

**AUTORITETI RRUGOR SHQIPTAR - ARRSH**

Rruga "Sami Frashëri", Nr.33, Tiranë

Email: [info@arrsh.gov.al](mailto:info@arrsh.gov.al)

**"PËRMIRËSIMI I SINJALISTIKËS HORIZONTALE/ VERTIKALE DHE PAJISJEVE  
TË SIGURISË RRUGORE NË AKSET E RAJONIT JUG, Lot 3 "**

**SEGMENTI NDRIÇIMET NË RR. GJIROKASTËR - KAKAVIJË**

**2024**

# PLANIMETRIA GJIROKASTER - KAKAVIJE

Fillimi projekti  
X= 429517.58  
Y= 4434367.12

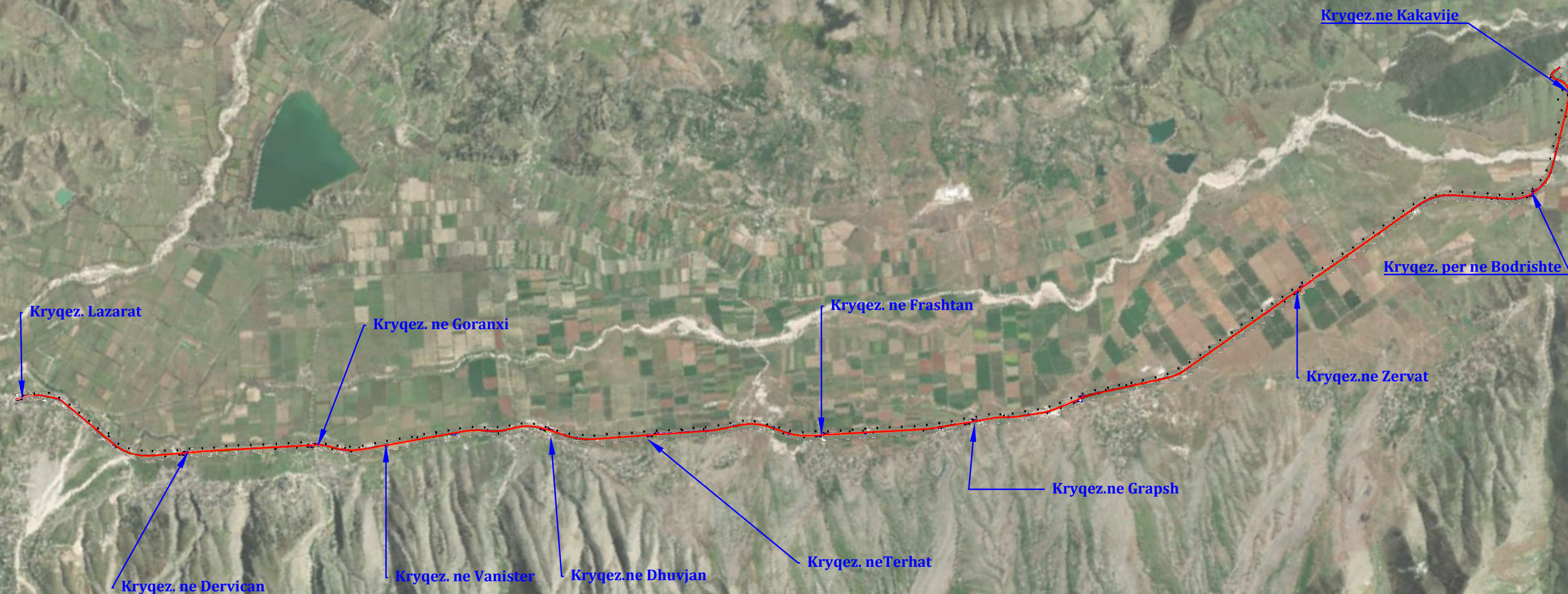

Mbarimi projekti  
X= 444865.16  
Y= 4418252.07



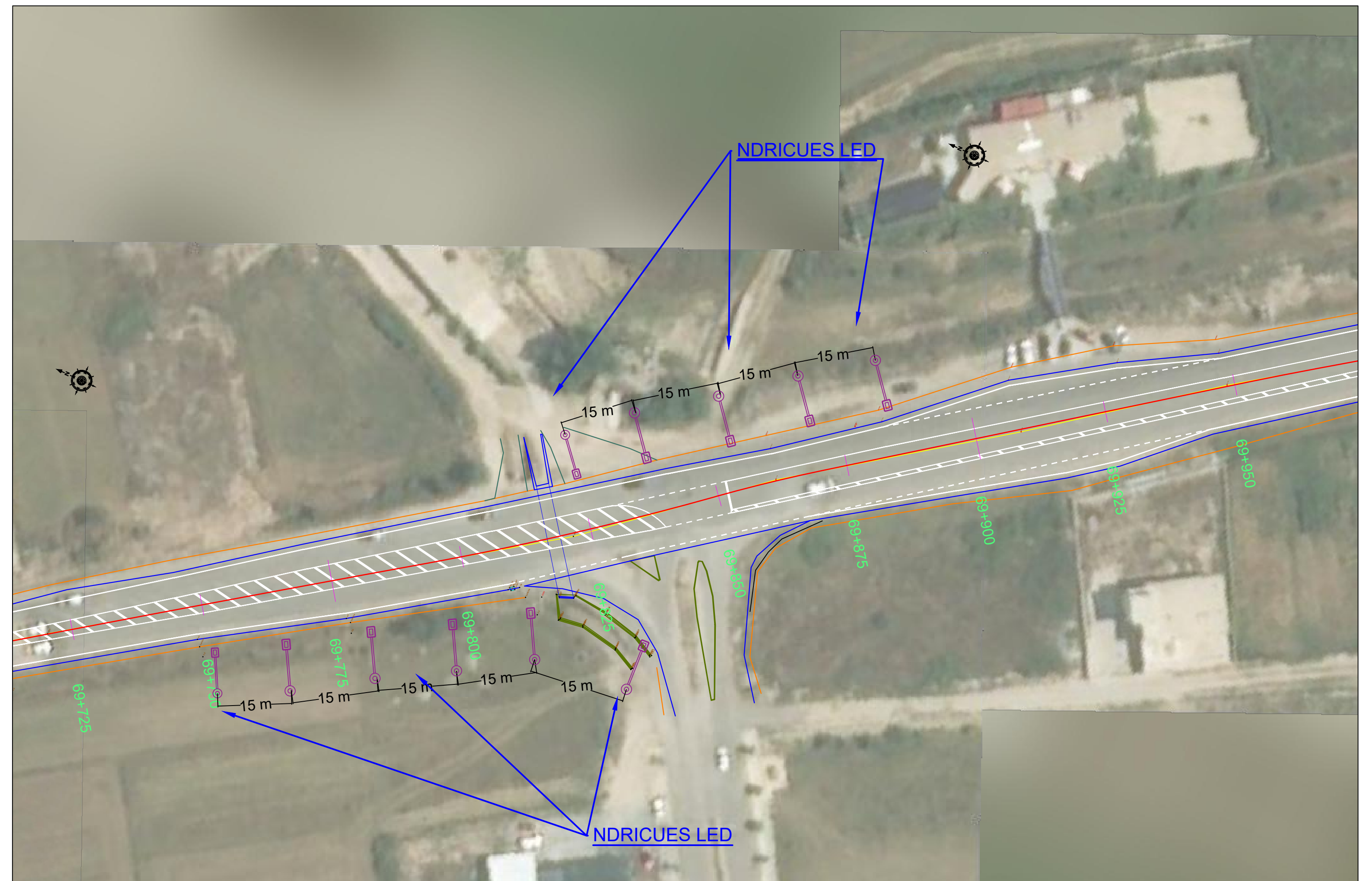

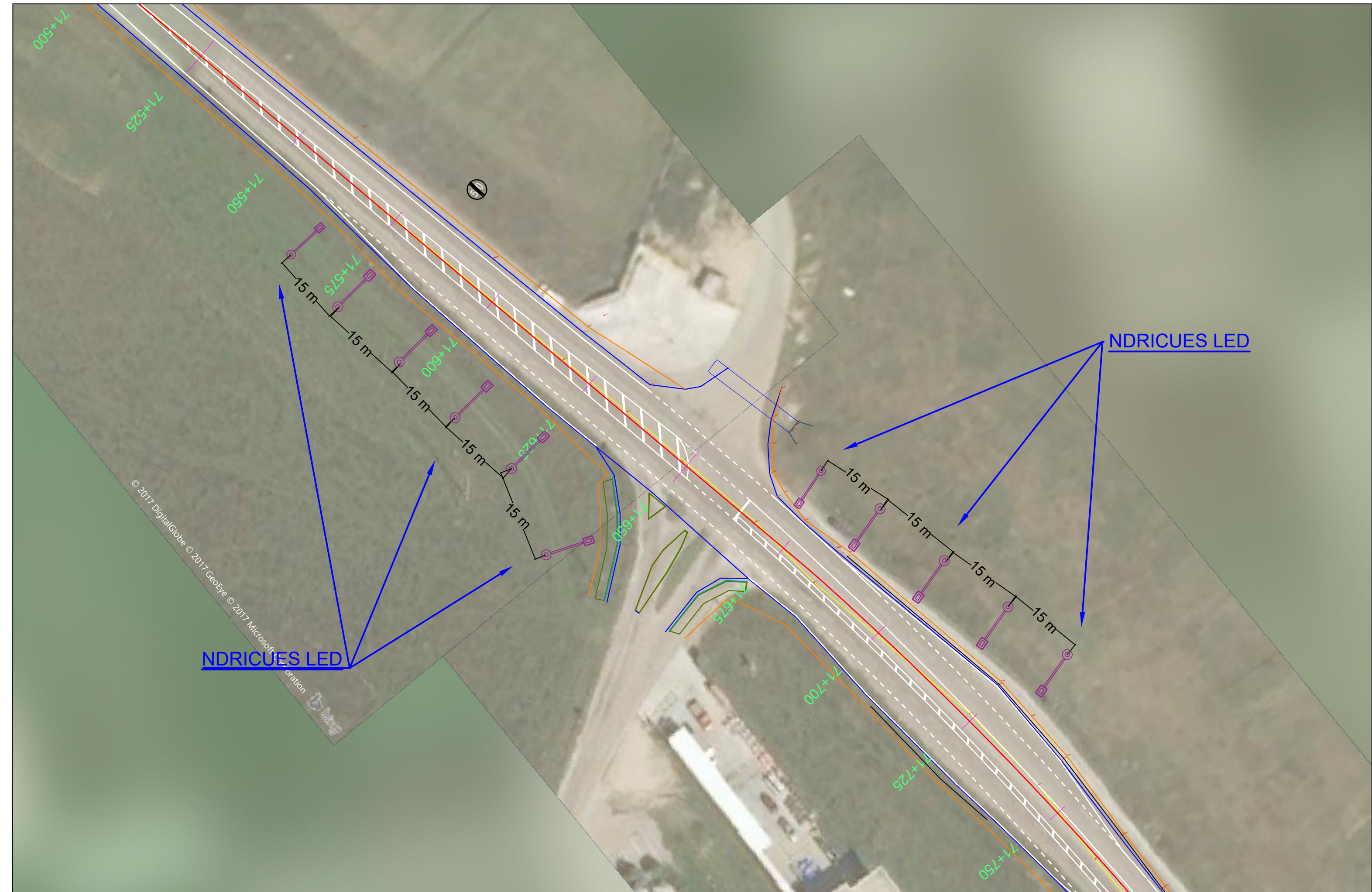



© 2017 DigitalGlobe © 2017 GeoEye © 2017 Microsoft Corporation

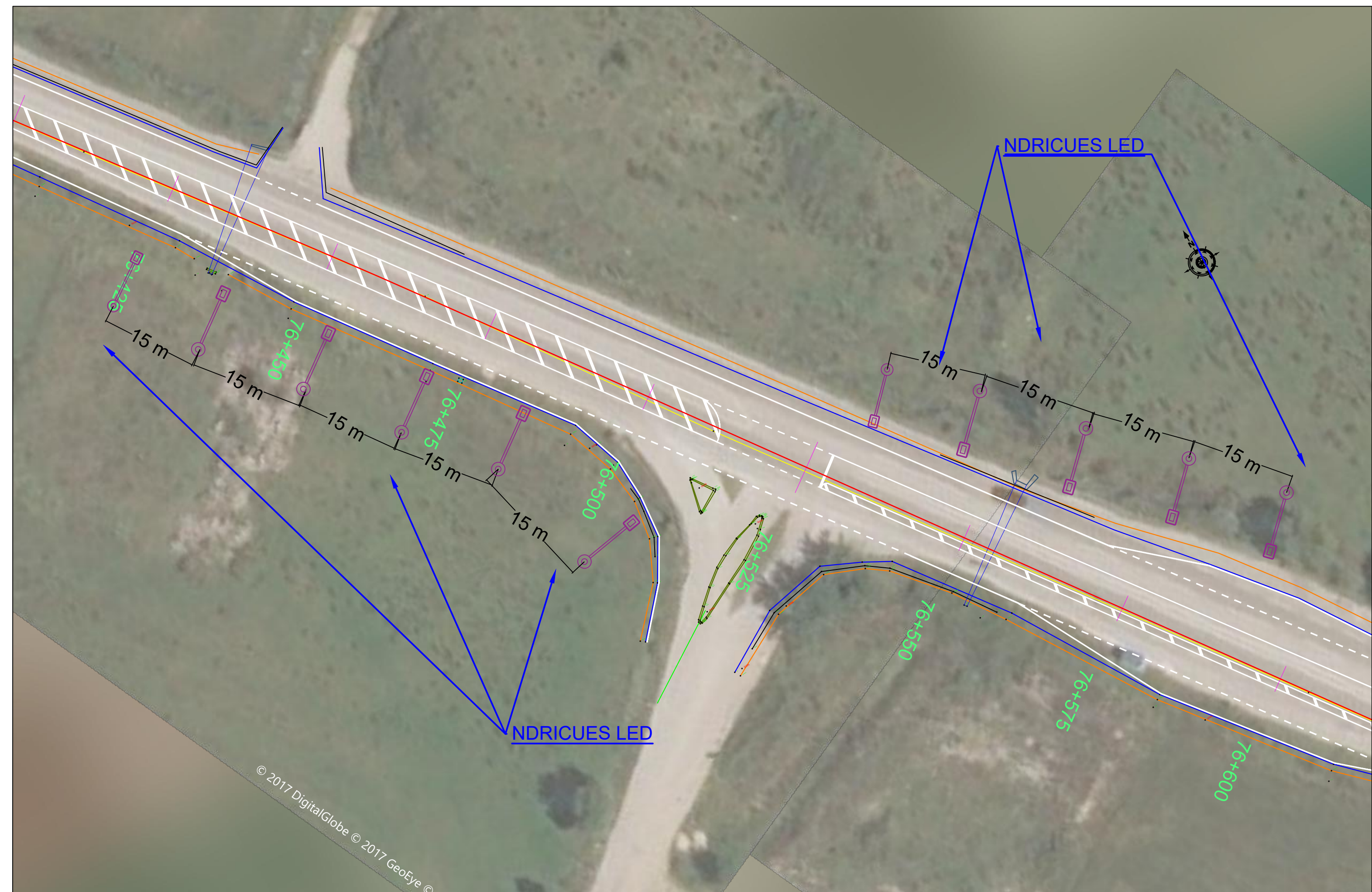

© 2017 DigitalGlobe © 2017 GeoEye © 2017

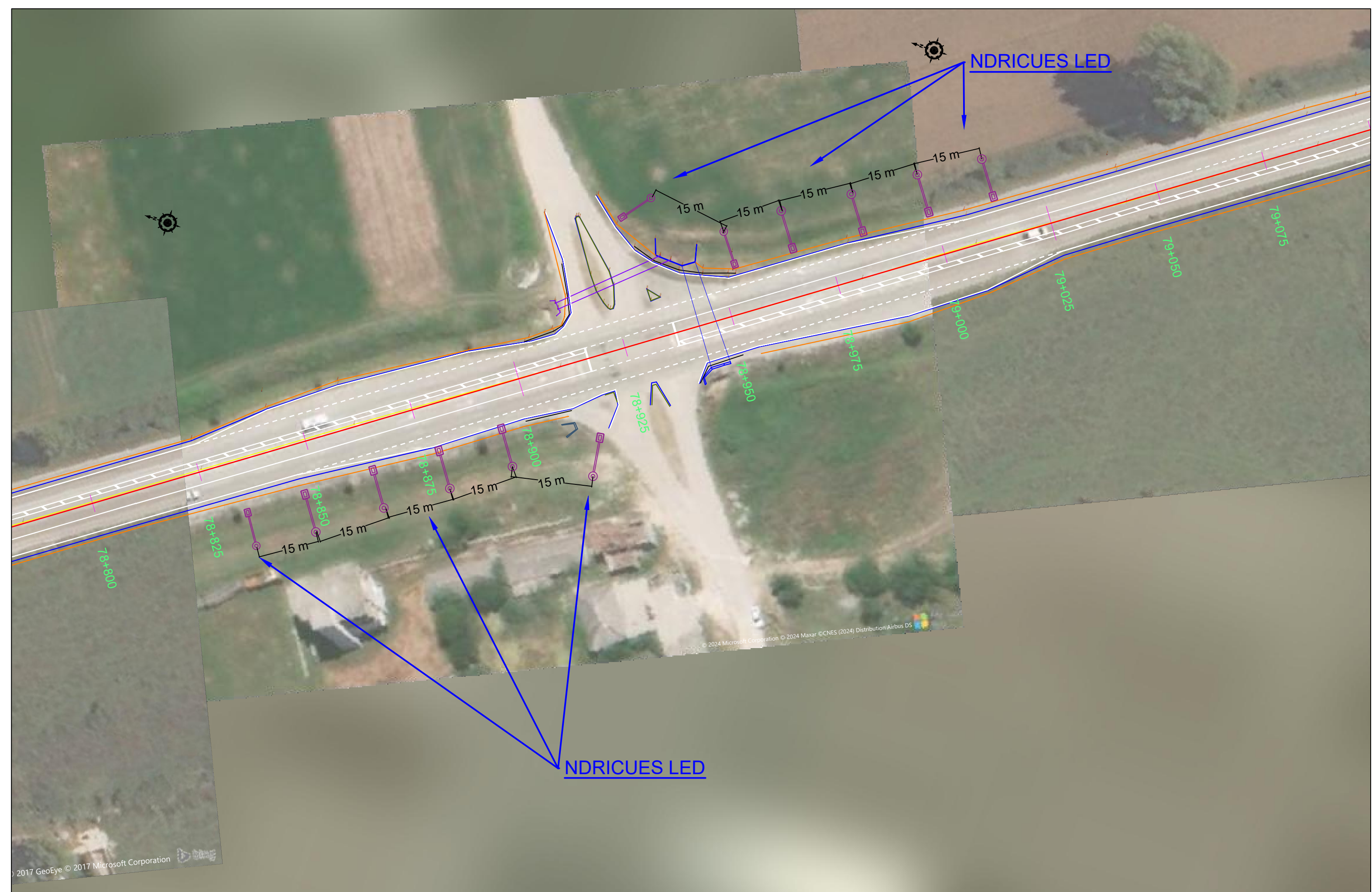





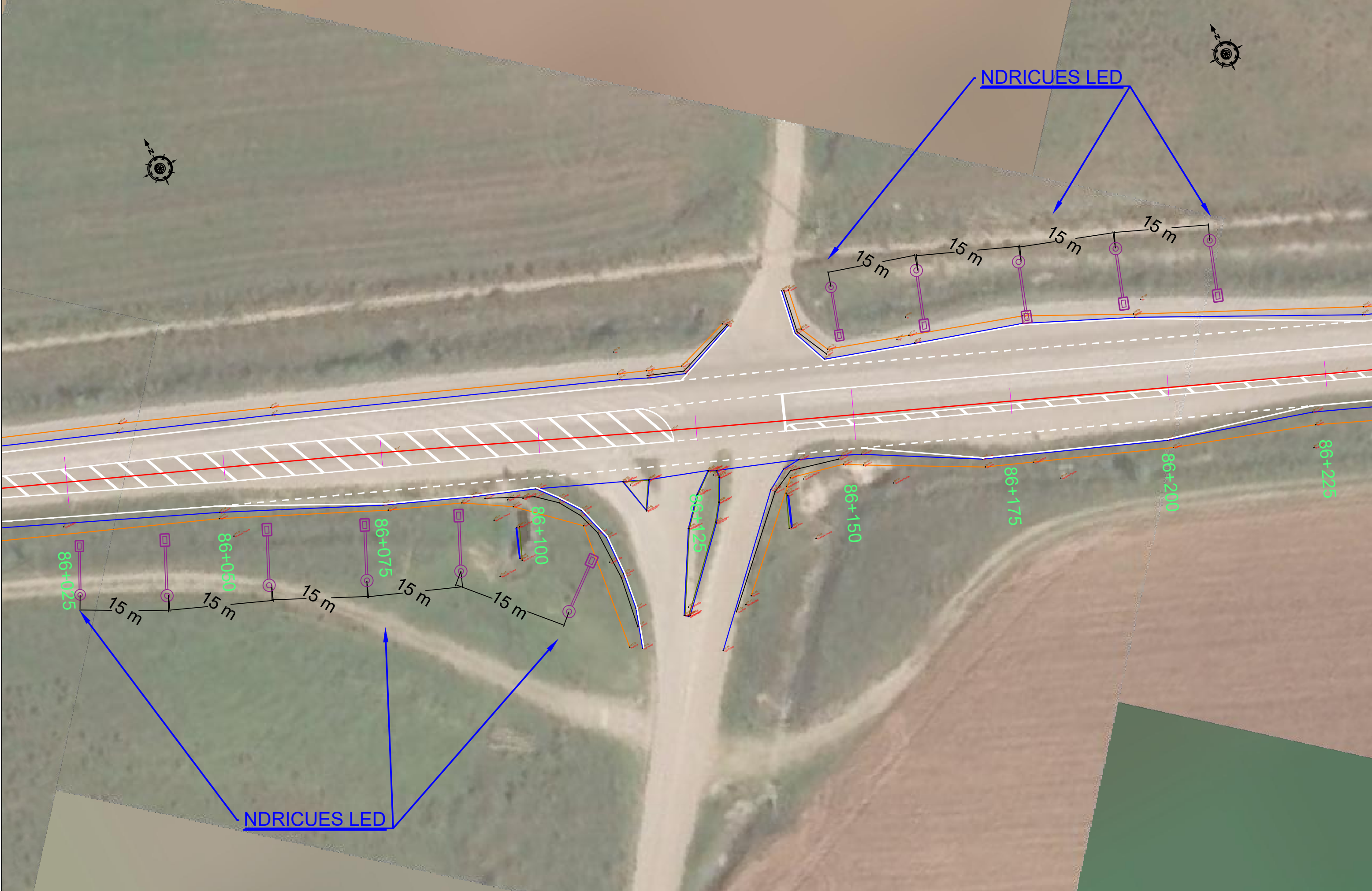

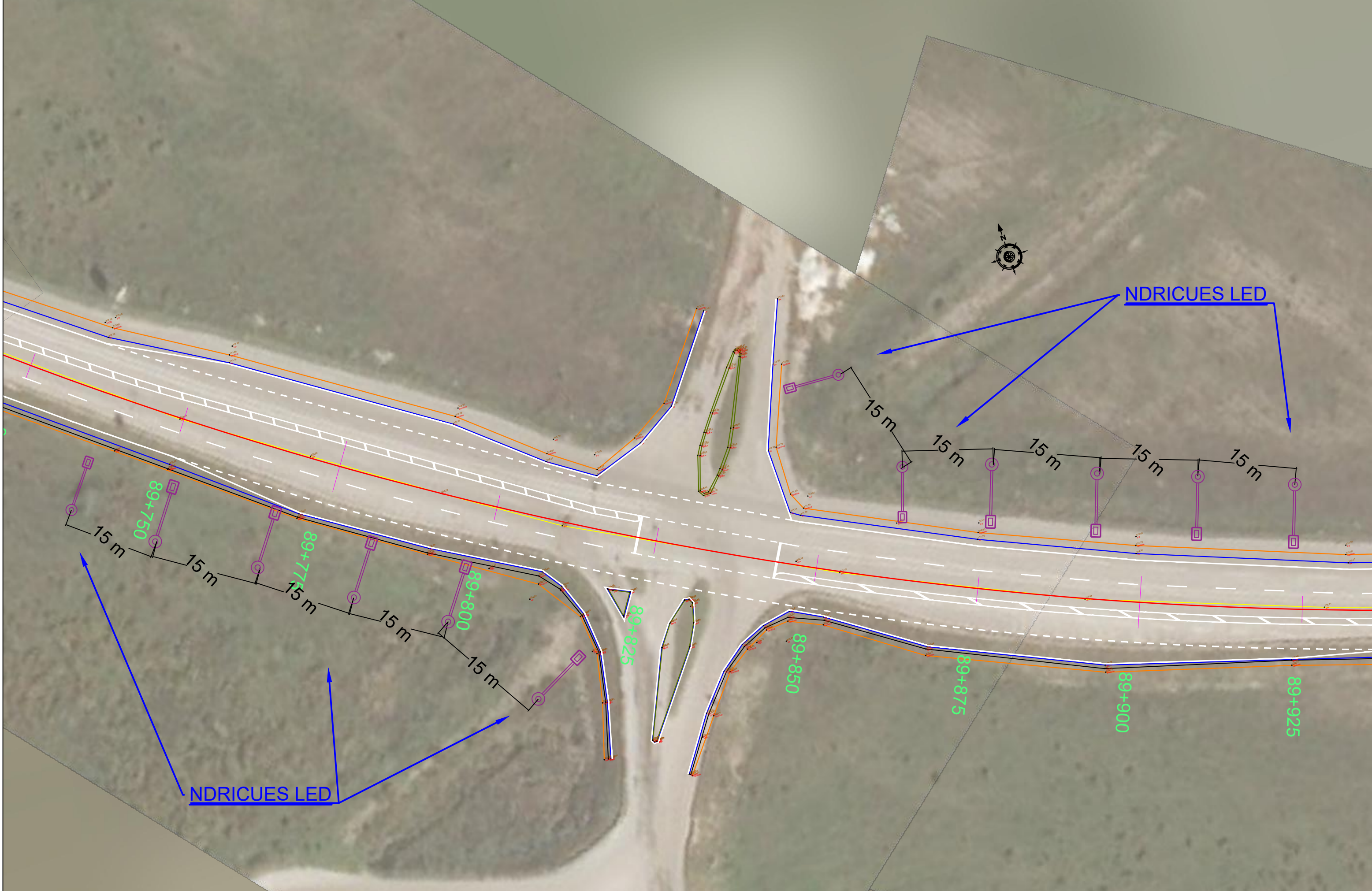



NDRICUES LED

NDRICUES LED

© 2017 DigitalGlo



NDRICUES TIP-1

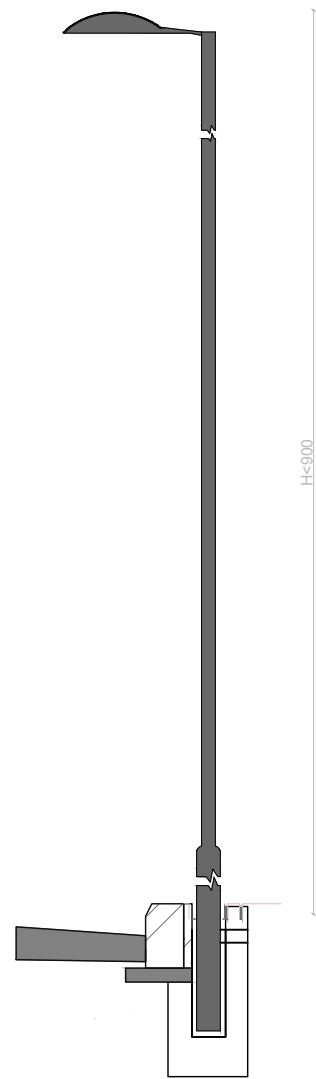

NDRICUES TIP-2

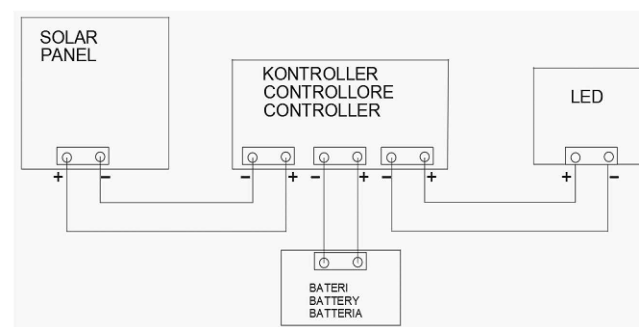
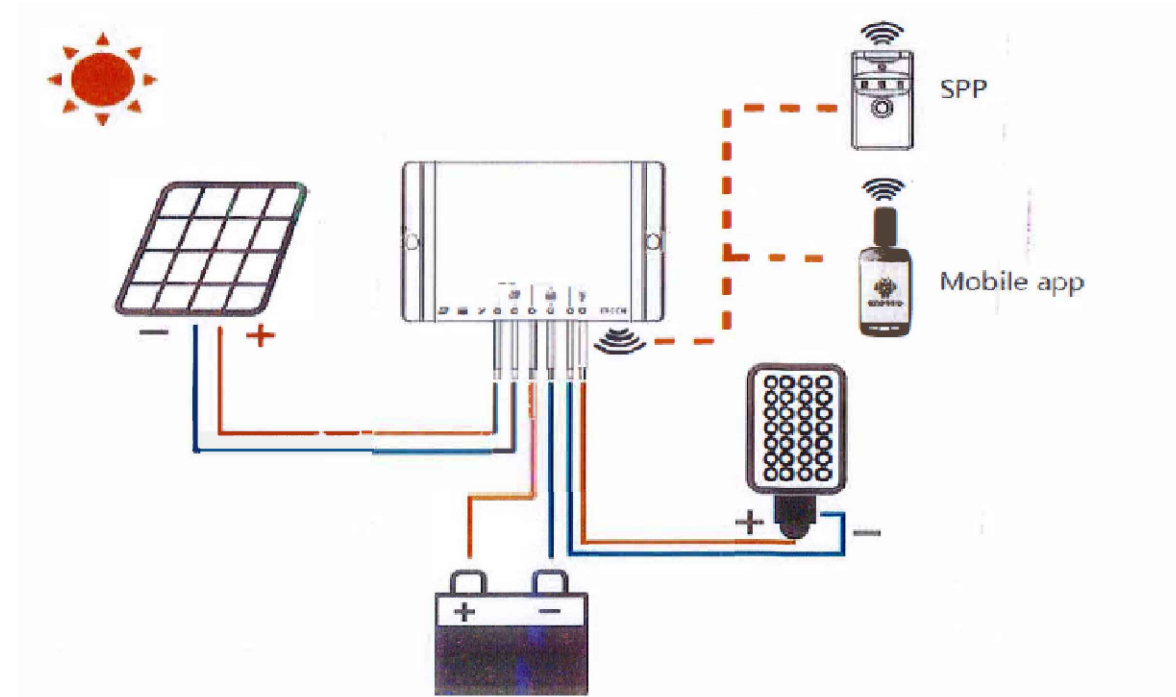
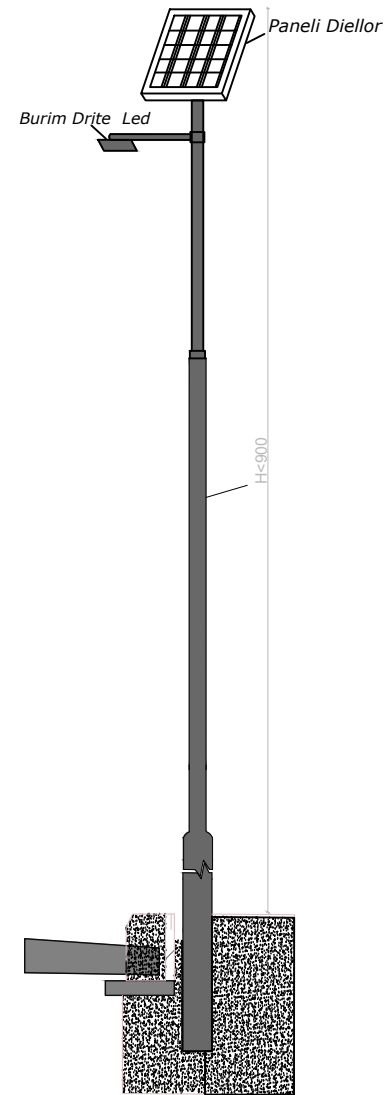

Grupi i Projektimit:

Ing. Gavrosh Jazexhiu

Preventivues:

Ing. Liri Sula

Përpunues:

Ing. Kristi Meçi

Objekti

Përmirësimi i Sinjalistikës Horizontale, vertikale dhe pajisjeve të sigurisë rrugore ne akset e Rajonit Jug, Lot 3

Emërtimi

Planimetria e sinjalistikës rrugore ,Ndricimet në Rr. Gjirokastër - Kakavijë,  
Detajet per ndricimet

Viti

2024

Shkalla

1:750

Nr. Revision

012

Nr. Fletës S12