

BAZAMENT TRANSFORMATORË FUQIE, N.STACIONI 110/35/10KV ÇOROVODË.

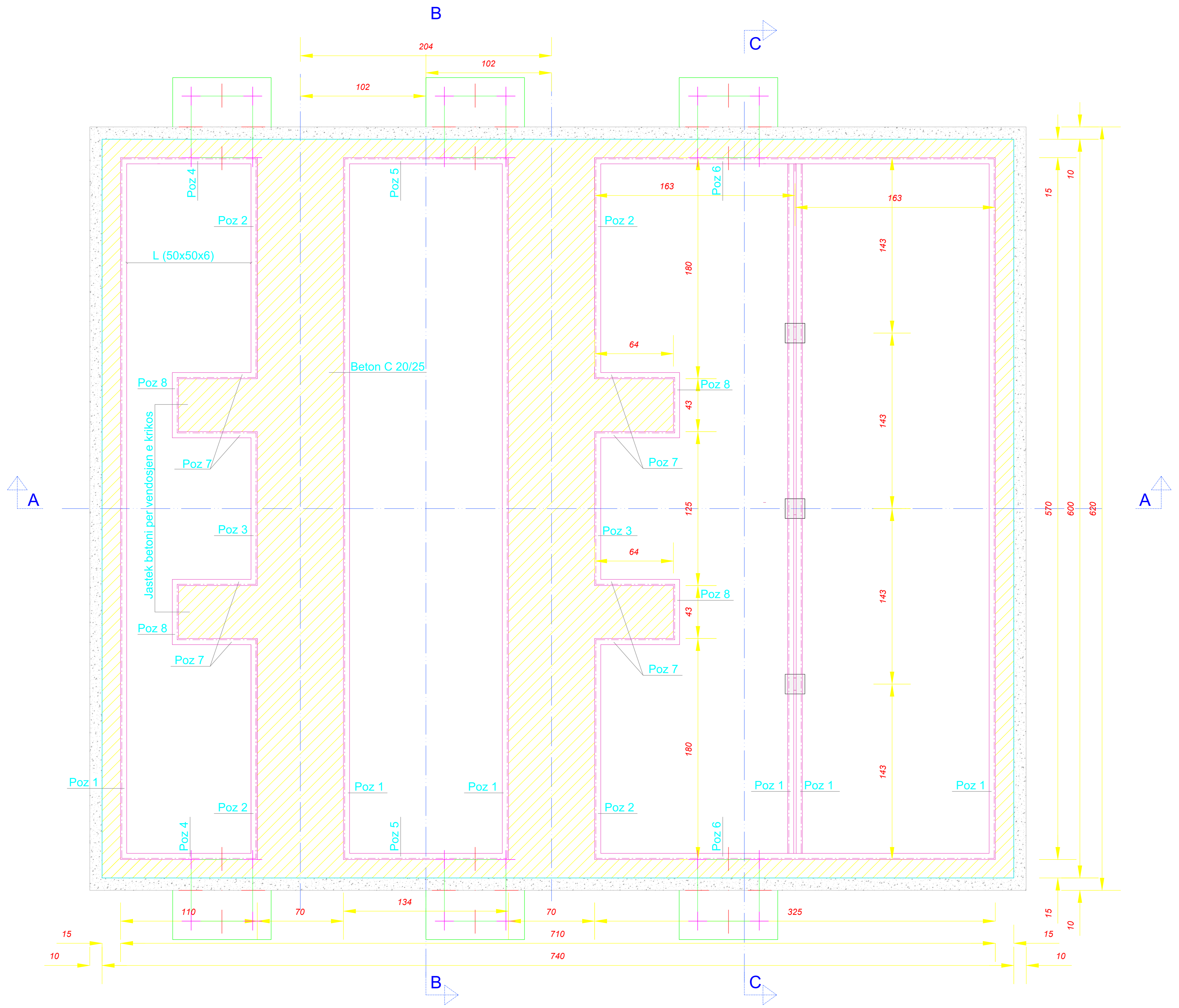

Përshkrimi i punimeve	Njësia	Sasia
Gërmim dheu	m ³	72
Shtresë zhavorri	m ³	5.7
Shtresë beton C 12/15	m ³	5.7
Beton bazamenti C/25/30	m ³	37

Specifikimi i materialeve	
Beton	
Bazamentet	C 20 / 25
Kanalet e kabllit	C 16 / 20
Beton i varfër	C 12 / 15
Shtresa mbrojtëse	5 cm
Armatura e hekurit	
Hekur periodik	B 500 C

<p>DREJTORIA E TENSIONIT TË LARTË</p>	DREJTORI		
	SHEF DEGA TEKNIKE		
Emërtimi objektit	SHEF ZYRA PROJEKTIT		
	PROJEKTOI		
Emërtimi fletës	PROJEKTOI		
	PROJEKTOI		
	PROJEKTOI		
	PERPUNOI		
Porositës:	FAZA: PROJEKT ZBATIMI		
	SHKALLA	Dt.	2023
	DIN A3		
Porositës:	NR. PROJEKTIT		
	FLETA VIZATIMIT		

Emërtimi objektit: FUQIZIMI I N.STACIONIT 110/35/10KV ÇOROVODË.

Emërtimi fletës: Bazamenti i transformatorit të fuqisë të N.Stacionit. Plani i kallëpit.

Porositës: DTL

BAZAMENT TRANSFORMATORË FUQIE, N.STACIONI 110/35/10KV ÇOROVODË.

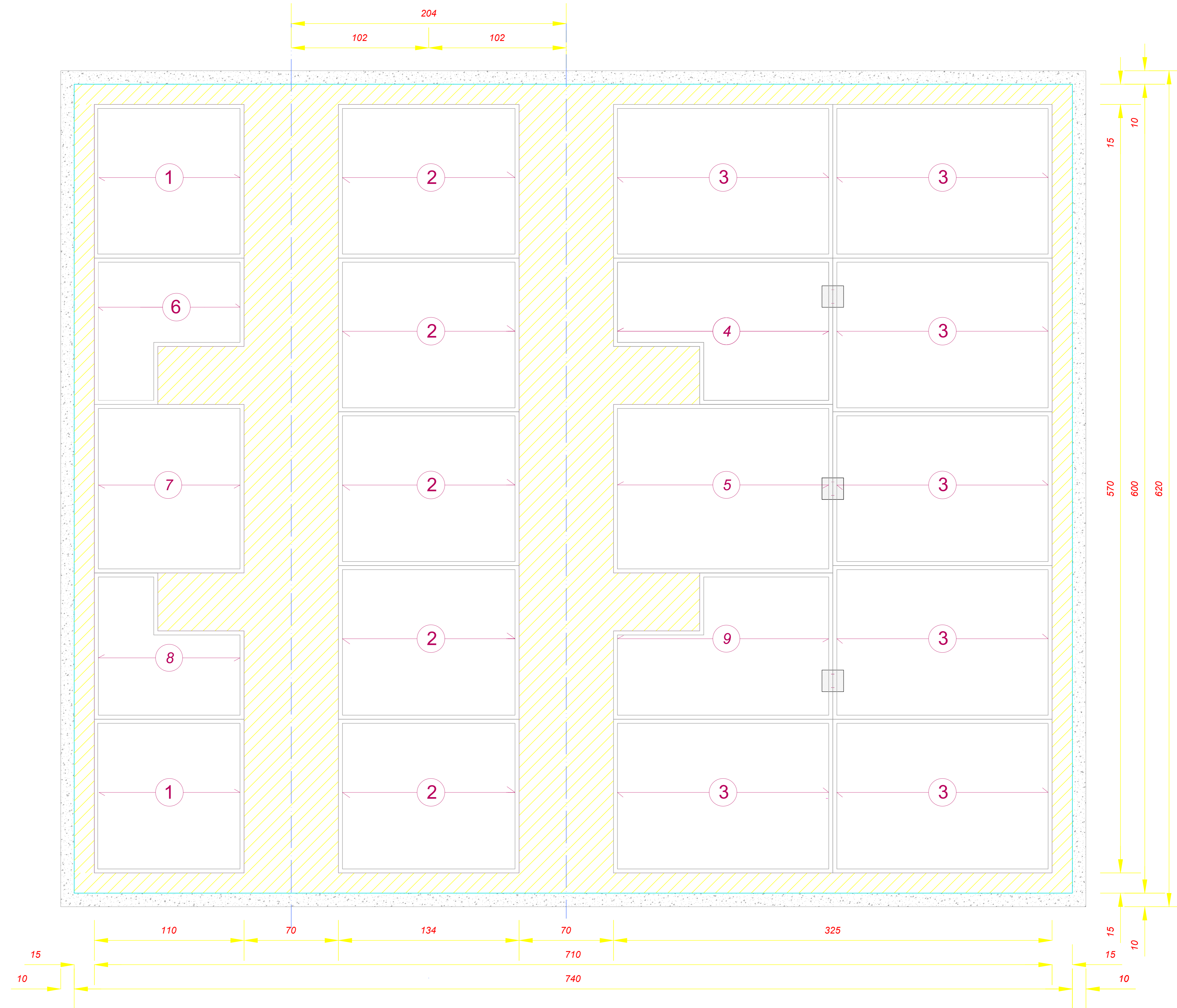

SHËNIM:

Pjerrësia e bazamentit do të jetë e tillë që me anë të tubave Ø 200mm, të lidhet me gropën e vajit ekzistues, dhe të mbledhë vajin në të.

	DREJTORI		
	SHEF DEGA TEKNIKE		
DREJTORIA E TENSIONIT TË LARTË	SHEF ZYRA PROJEKTIT		
	PROJEKTOI		
Emërtimi objektit FUQIZIMI I N.STACIONIT 110/35/10KV ÇOROVODË.	PROJEKTOI		
	PROJEKTOI		
	PROJEKTOI		
	PROJEKTOI		
	PERPUNOI		
Emërtimi fletës Bazamenti i transformatorit të fuqisë të N.Stacionit. Plani i vendosjes së zgarave.	PERPUNOI		
	FAZA: PROJEKT ZBATIMI		
Porositës: DTL	SHKALLA	Dt. 2023	DIN A3
	NR. PROJEKTIT		
	FLETA VIZATIMIT		

BAZAMENT TRANSFORMATORË FUQIE, N.STACIONI 110/35/10KV ÇOROVODË.

Prerja A - A

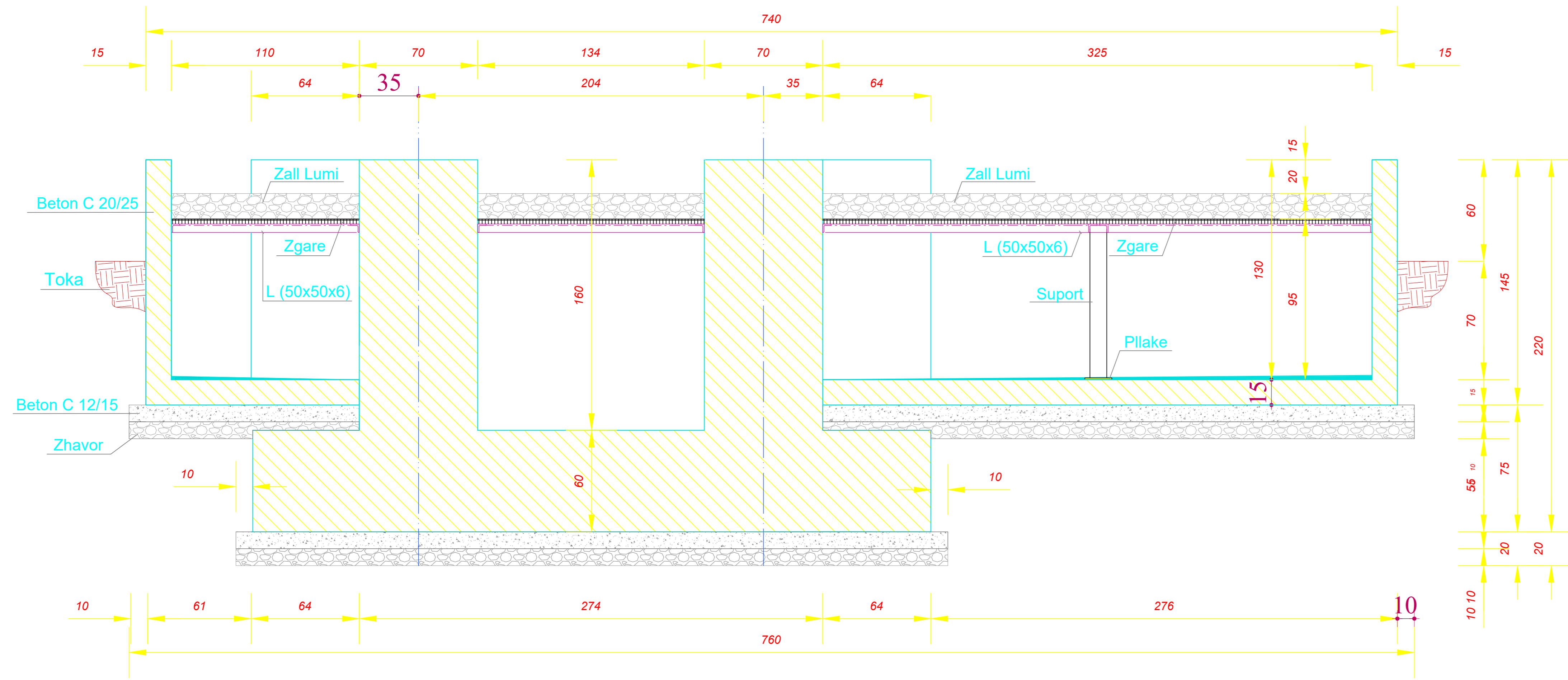

Prerja C - C

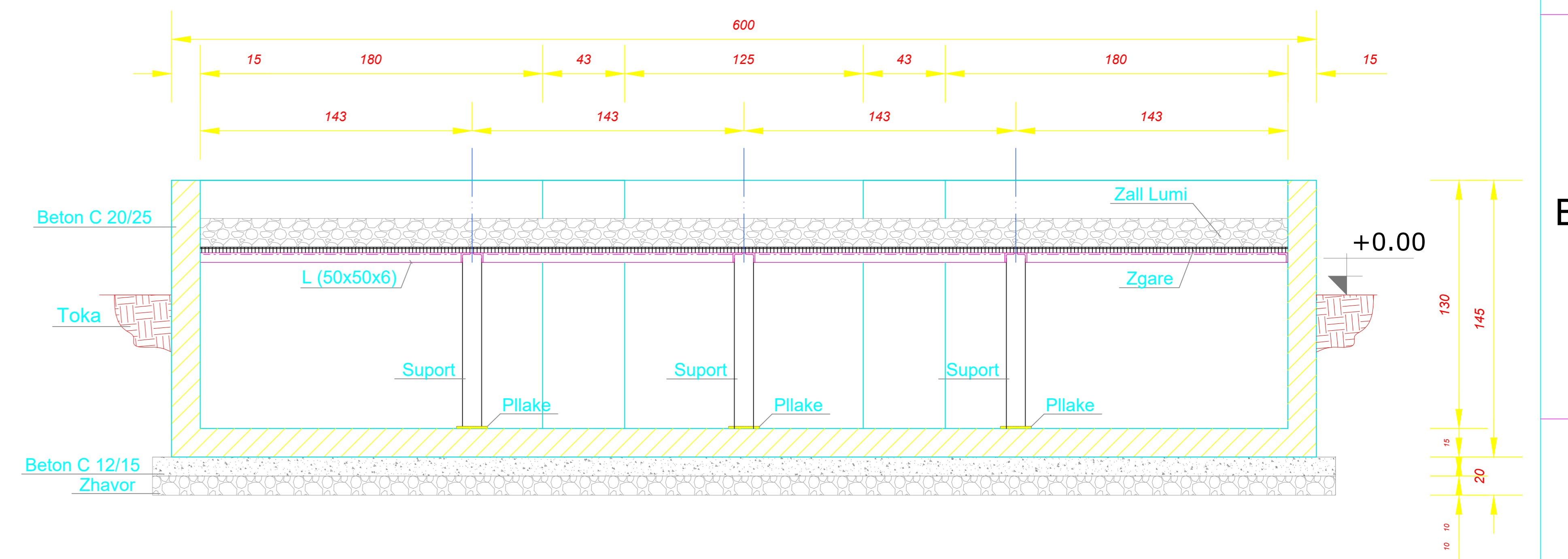

Prerja B - B

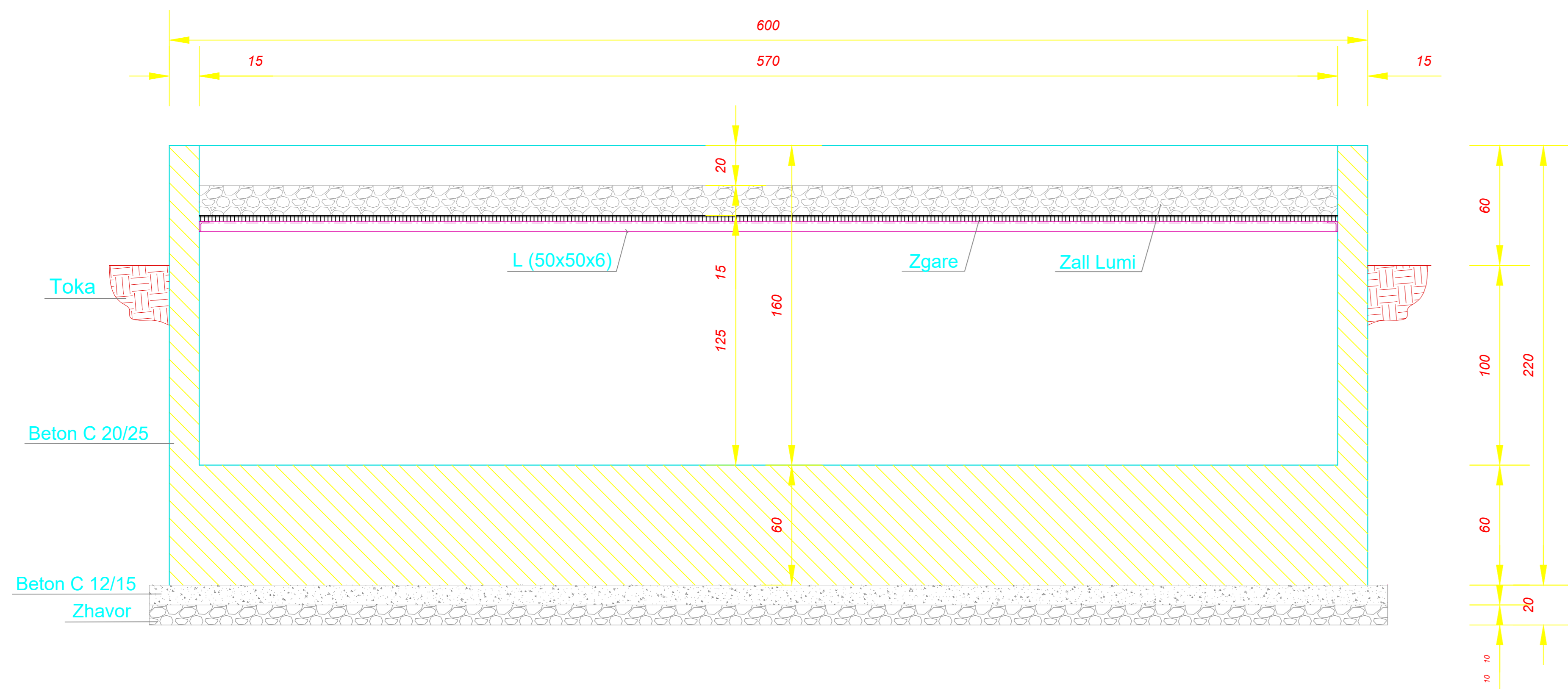

Përshkrimi për armaturën e bazamentit të transformatorit.

Nr.	D.	L (cm)	cope	L (m)	Pesha /njesi	Pesha /cope	Total/ kg
1	14	480	29	4.8	1.21	5.81	168.4
2	14	682	14	6.82	1.21	8.25	115.5
3	14	480	29	4.8	1.21	5.81	168.4
4	14	678	14	6.78	1.21	8.20	114.9
5	14	320	116	3.2	1.21	3.87	449.2
6	14	590	28	5.9	0.62	3.66	102.4
7	14	590	10	5.9	1.21	7.14	71.4
8	10	222	52	2.22	0.62	1.38	71.6
9	10	300	8	3	0.62	1.86	14.9
10	10	300	110	3	0.62	1.86	204.6
11	10	2625	14	26.25	0.62	16.28	227.9
12	10	416	58	4.16	0.62	2.58	149.6
13	10	200	58	2	0.62	1.24	71.9
14	10	590	48	5.9	0.62	3.66	175.6
15	10	340	32	3.4	0.62	2.11	67.5
16	10	250	44	2.5	0.62	1.6	68.2
SHUMA							2241.9
Konstrukcioni i zgarave i zinkuar							690

<p>DREJTORIA E TENSIONIT TË LARTË</p>	DREJTORI			
	SHEF DEGA TEKNIKE			
Emërtimi objektit FUQIZIMI I N.STACIONIT 110/35/10KV ÇOROVODË.	SHEF ZYRA PROJEKTIT			
	PROJEKTOI			
	PROJEKTOI			
	PROJEKTOI			
Emërtimi fletës Bazamenti i transformatorit të fuqisë së N.Stacionit. Prerja A - A, B - B, C - C.	PROJEKTOI			
	PERPUNOI			
	PERPUNOI			
Porositës: DTL	FAZA: PROJEKT ZBATIMI			
	SHKALLA	Dt.	2023	DIN A3
	NR. PROJEKTIT			
	FLETA VIZATIMIT			

BAZAMENT TRANSFORMATORË FUQIE, N.STACIONI 110/35/10KV ÇOROVODË.

Zgarë Tipi 1

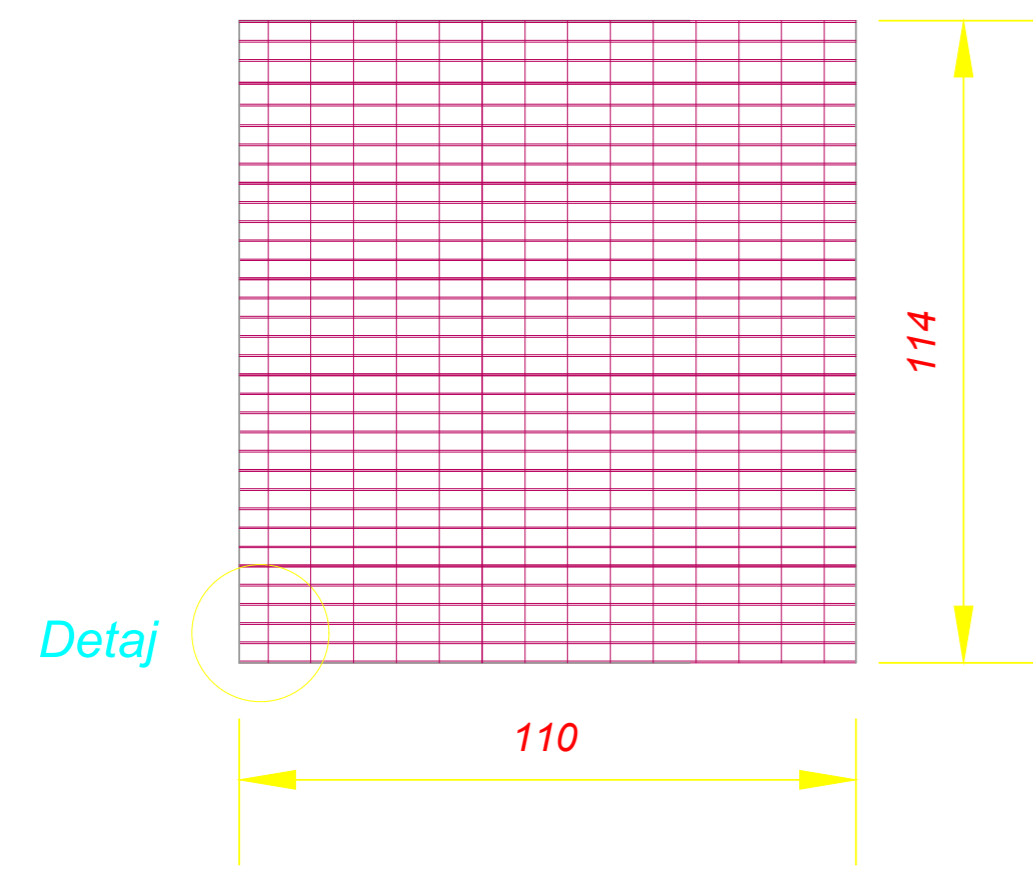

Zgarë Tipi 2

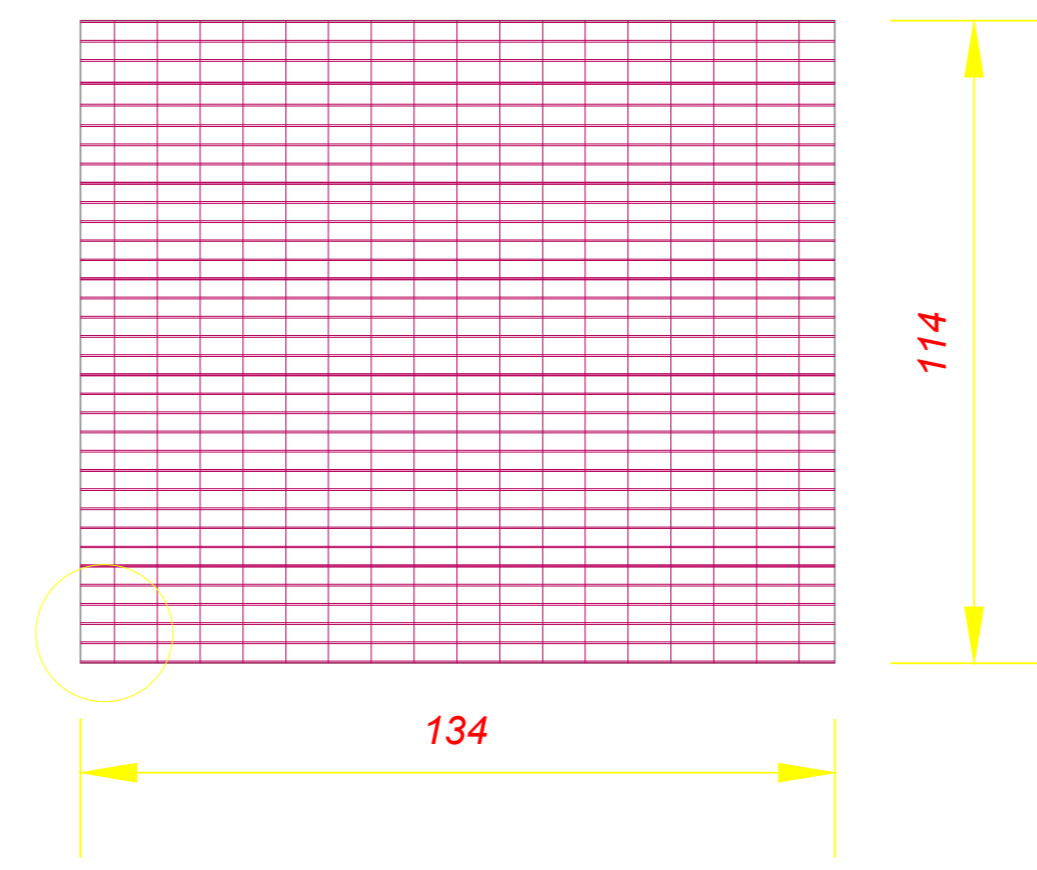

Zgarë Tipi 3

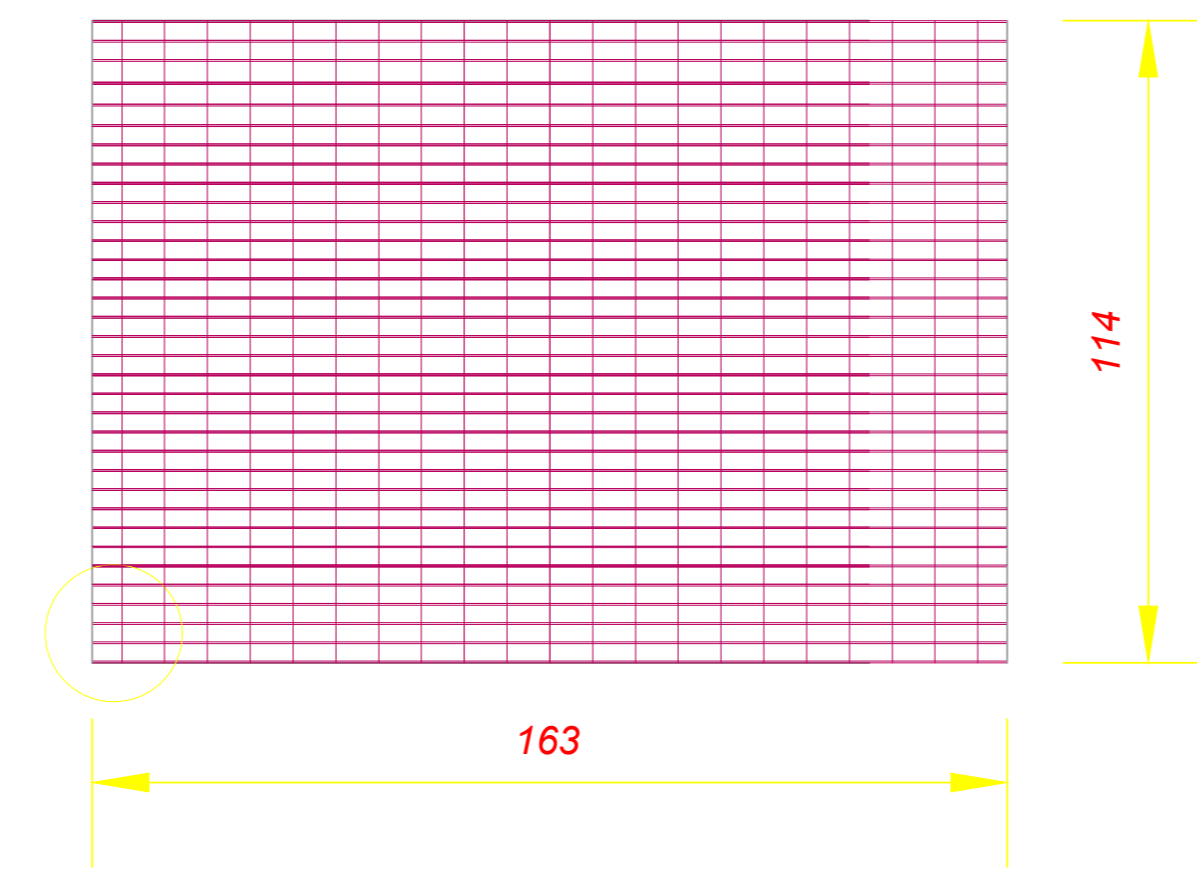

Zgarë Tipi 4

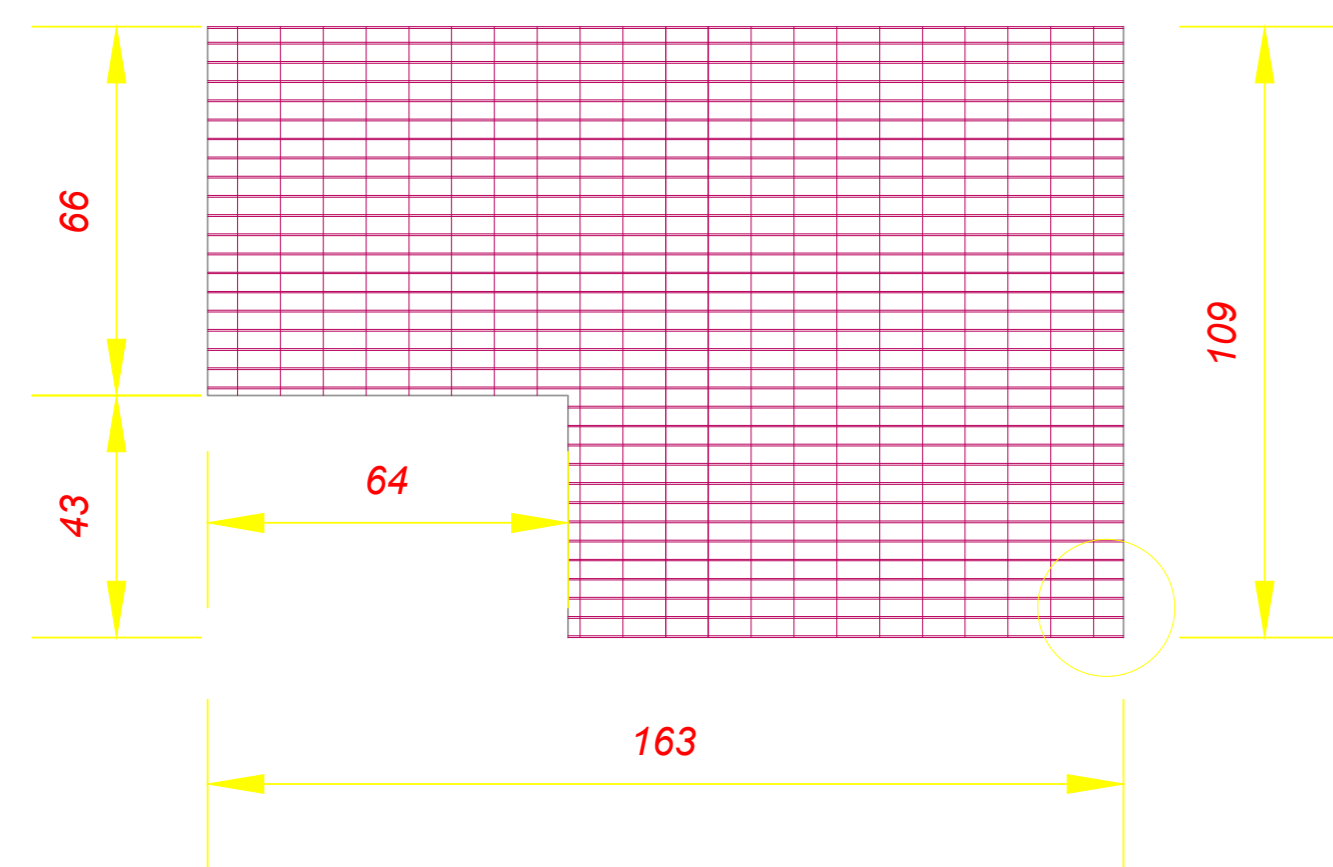

Zgarë Tipi 5

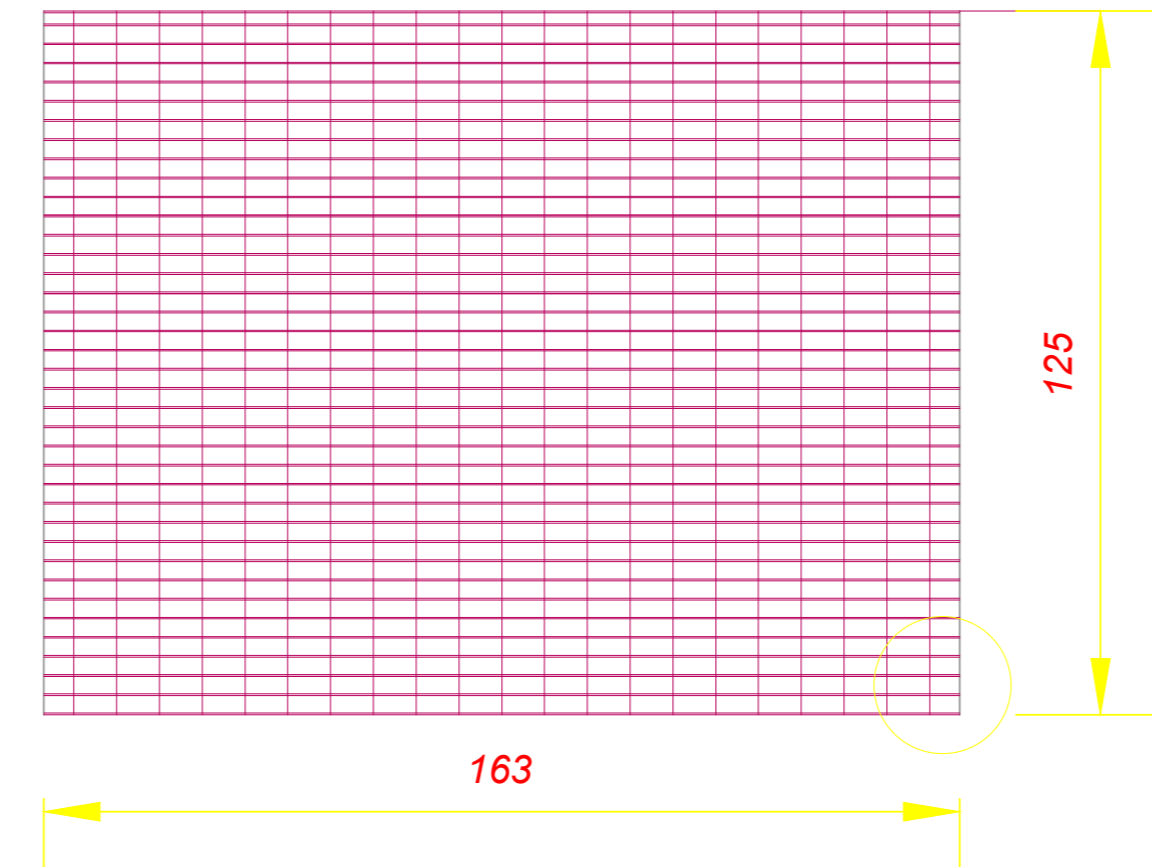

Zgarë Tipi 6

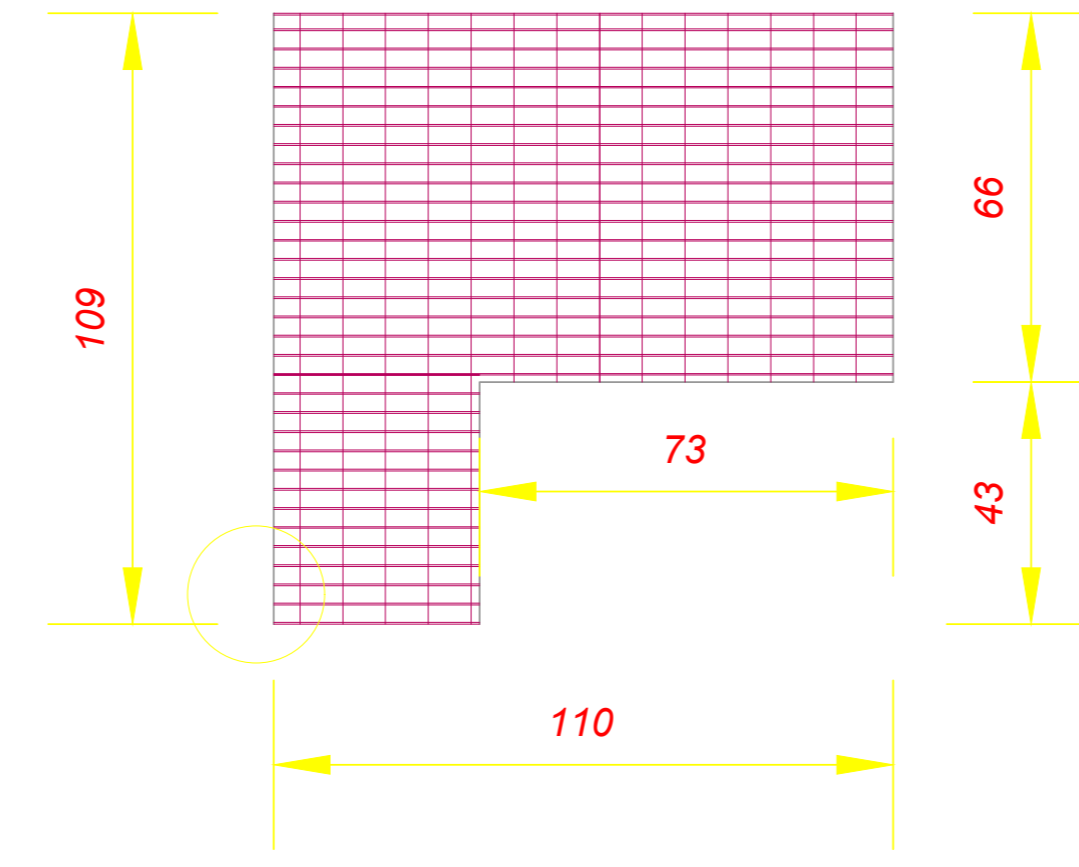

Zgarë Tipi 7

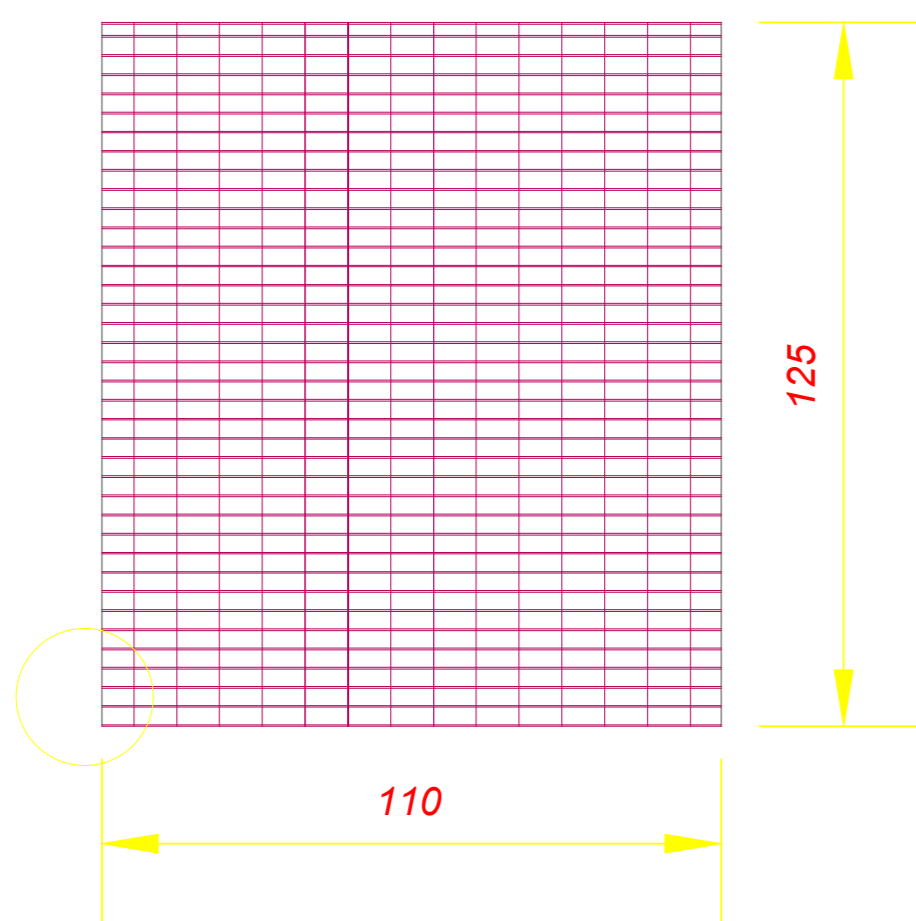

Zgarë Tipi 8

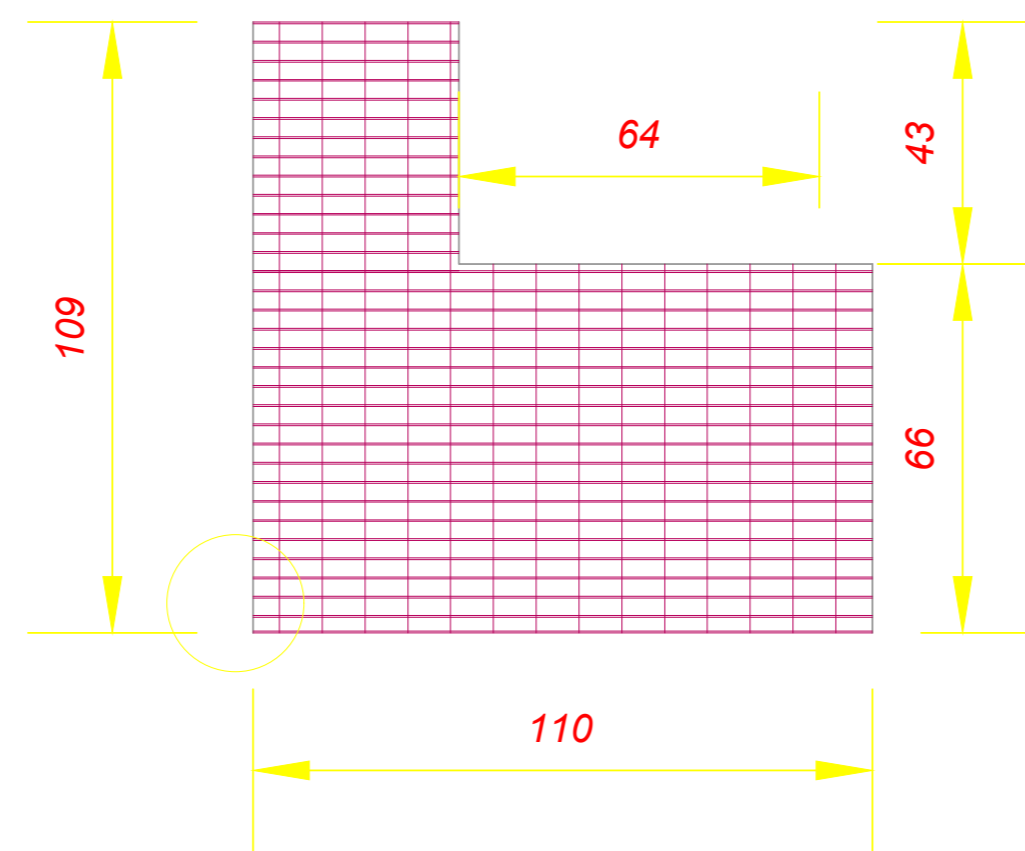

Zgarë Tipi 9

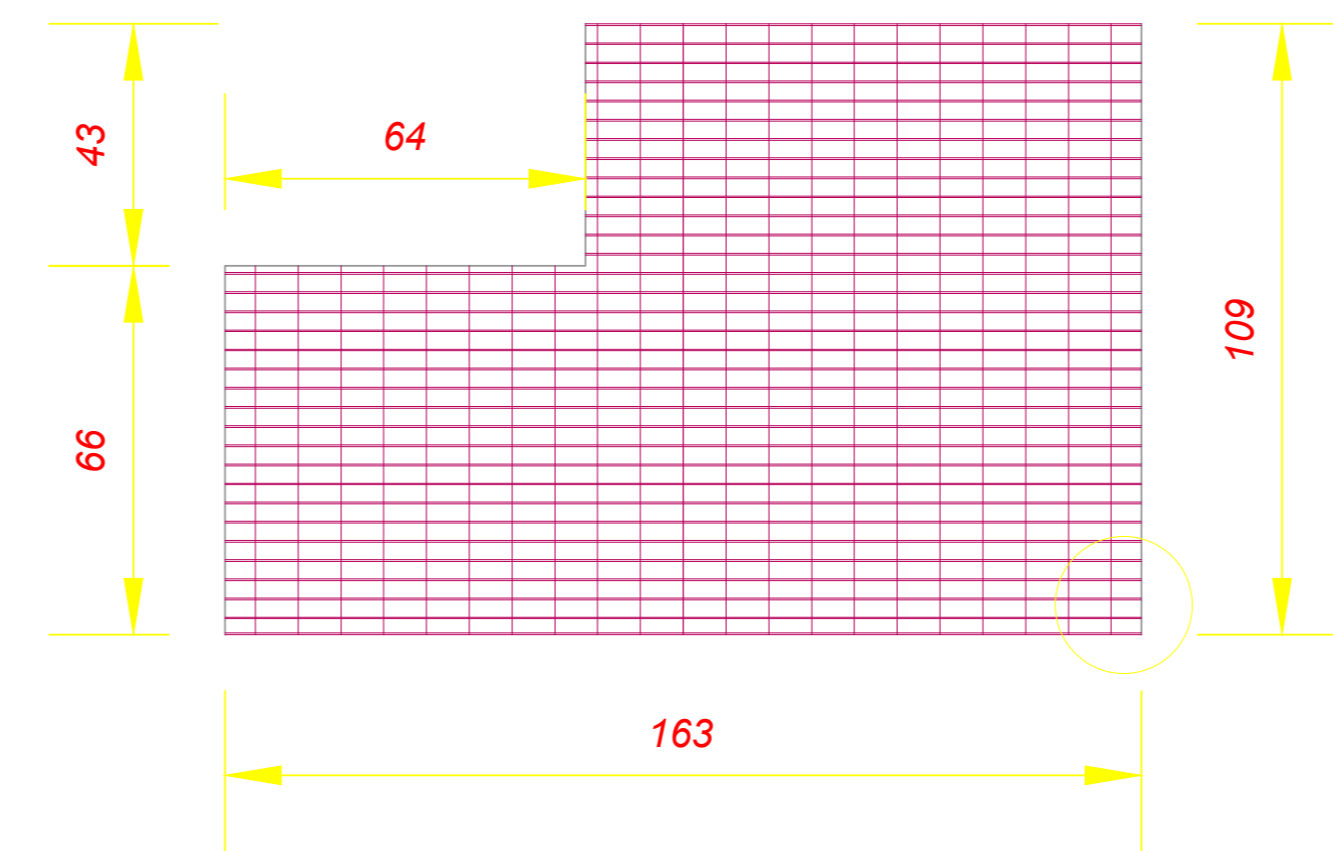

Detaj Shk 1:5

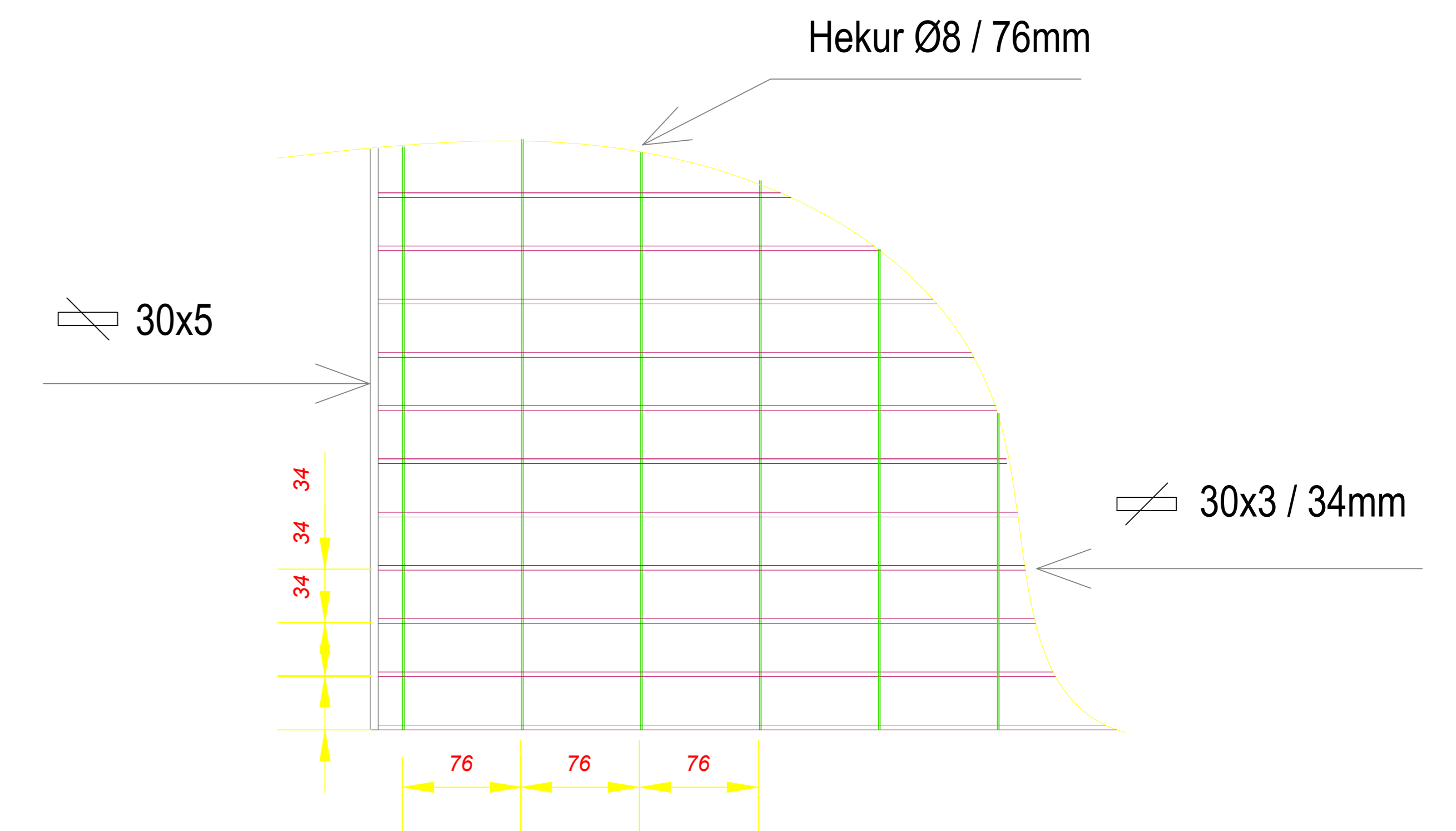

	DREJTORI			
	SHEF DEGA TEKNIKE			
DREJTORIA E TENSIONIT TË LARTË	SHEF ZYRA PROJEKTIT			
	PROJEKTOI			
Emërtimi objektit FUQIZIMI I N.STACIONIT 110/35/10KV ÇOROVODË.	PROJEKTOI			
	PROJEKTOI			
Emërtimi fletës Bazamenti i transformatorit të fuqisë së N.Stacionit. Detajet e zgarave.	PROJEKTOI			
	PERPUNOI			
Porositës: DTL	FAZA: PROJEKT ZBATIMI			
	SHKALLA	Dt.	2023	DIN A3
	NR. PROJEKTIT			
	FLETA VIZATIMIT			

BAZAMENT TRANSFORMATORË FUQIE, N.STACIONI 110/35/10KV ÇOROVODË.

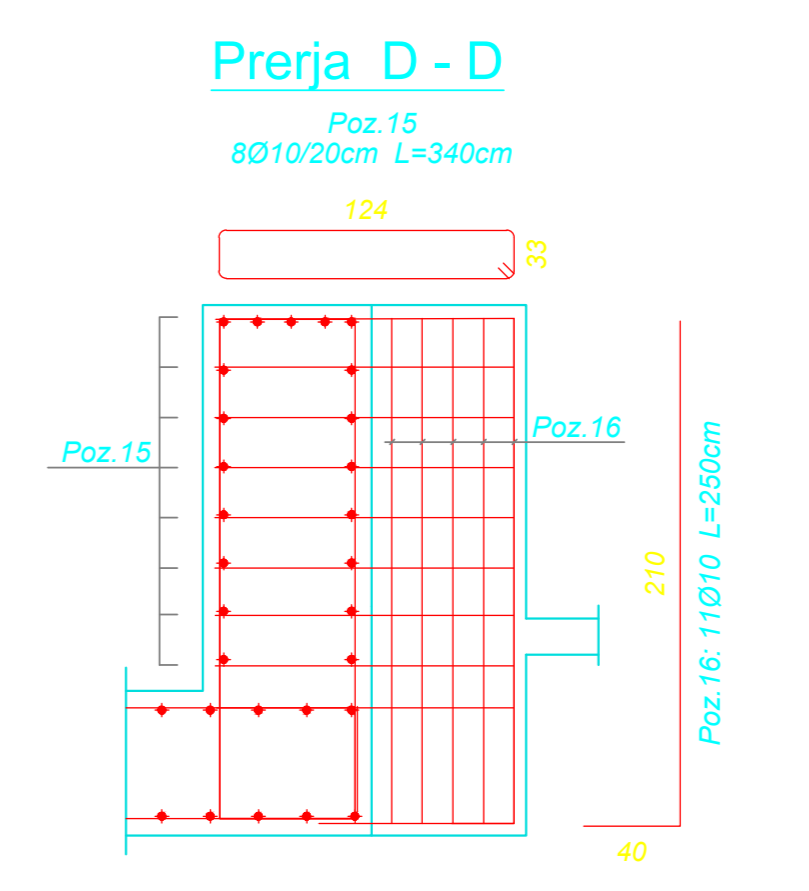
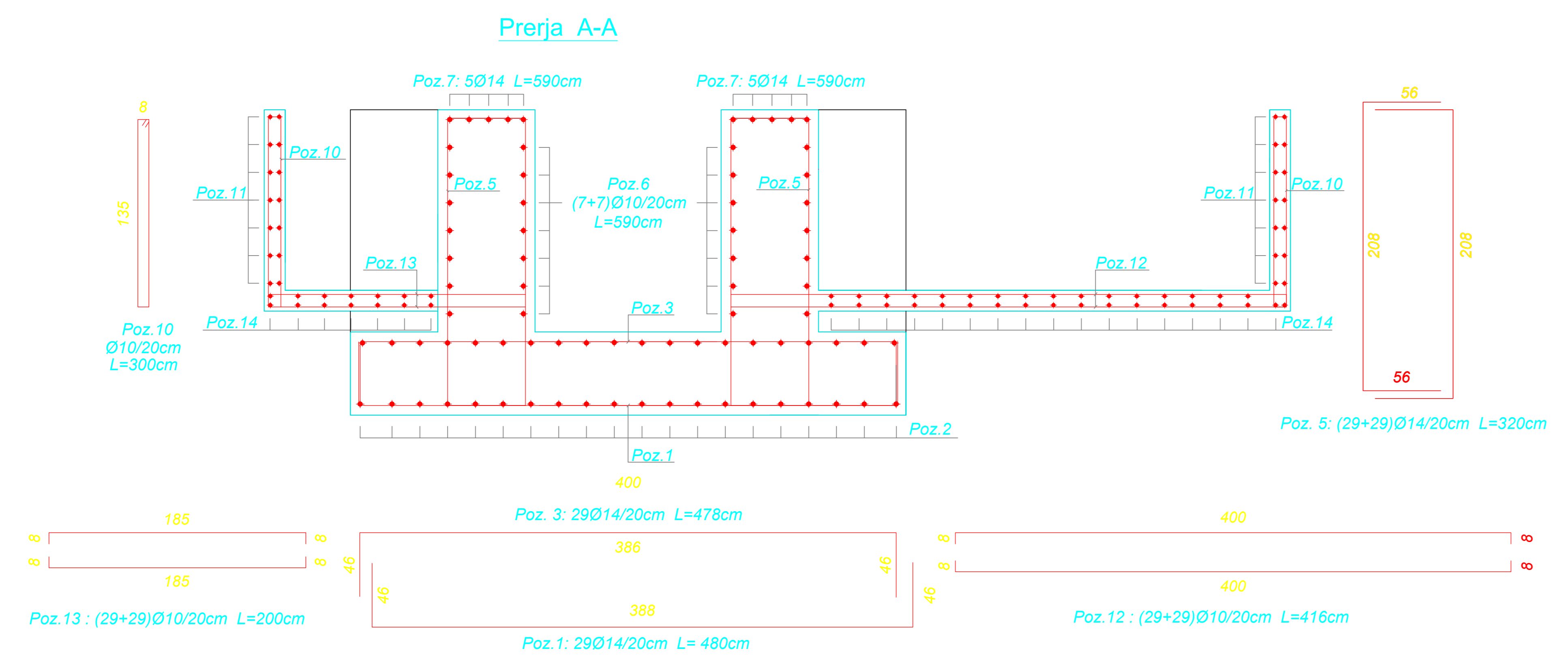
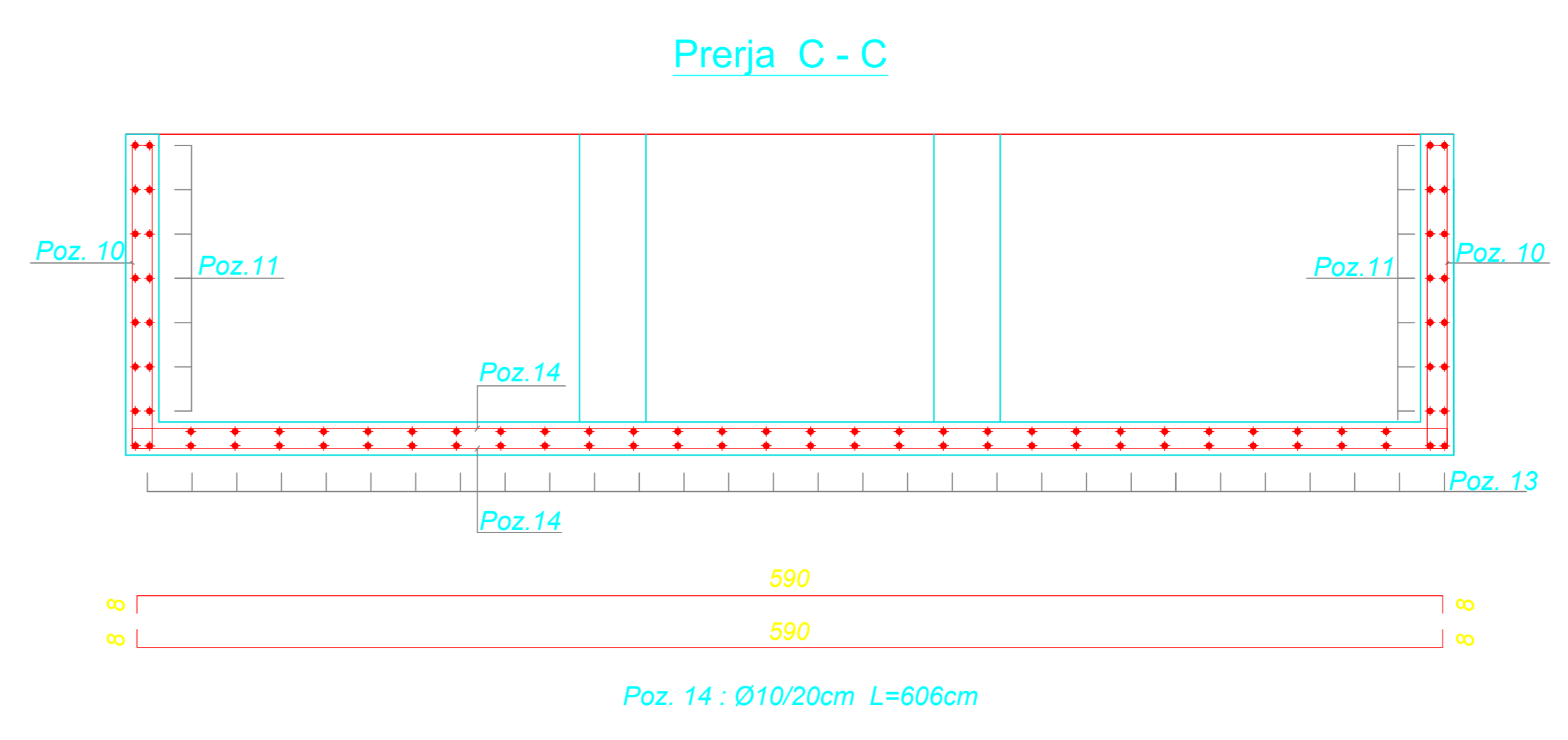
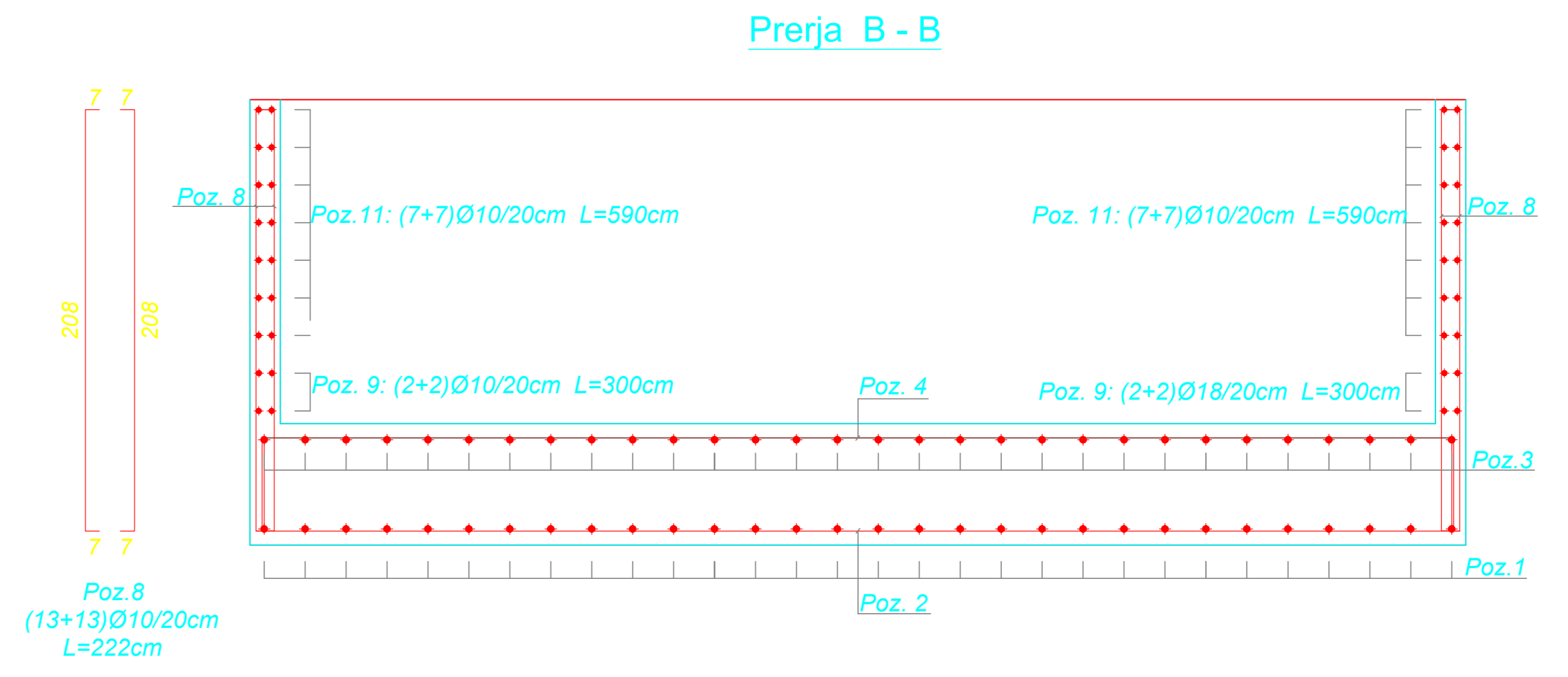
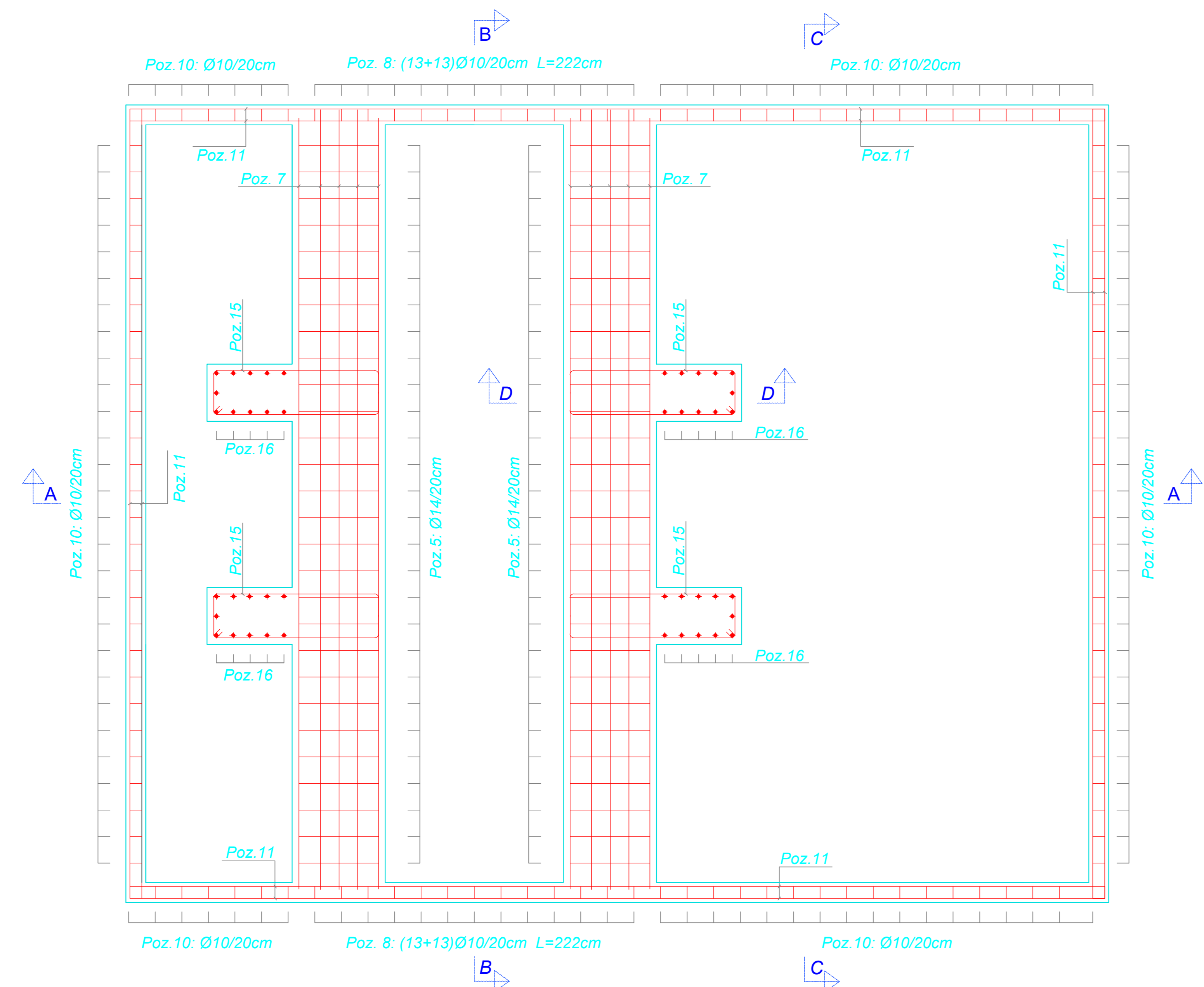

	DREJTORI		
	SHEF DEGA TEKNIKE		
DREJTORIA E TENSIONIT TË LARTË	SHEF ZYRA PROJEKTIT		
	PROJEKTOI		
Emërtimi objektit	PROJEKTOI		
	PROJEKTOI		
Emërtimi fletës	PROJEKTOI		
	PERPUNOI		
Porositës:	PERPUNOI		
	FAZA: PROJEKT ZBATIMI		
DTL	SHKALLA	Dt.	2023
	NR. PROJEKTIT	DIN A3	
	FLETA VIZATIMIT		

BAZAMENTET E TRANSFORMATORËVE TË FUQISË N.STACIONI 110/35/10KV ÇOROVODË.

A

A

Poz. 1 L 50x50x6 (8 copë)

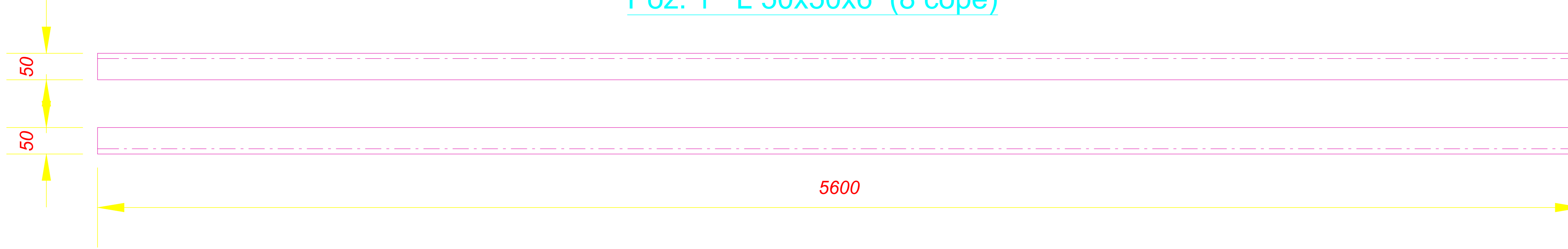

B

B

Poz. 2 L 50x50x6 (4 copë)

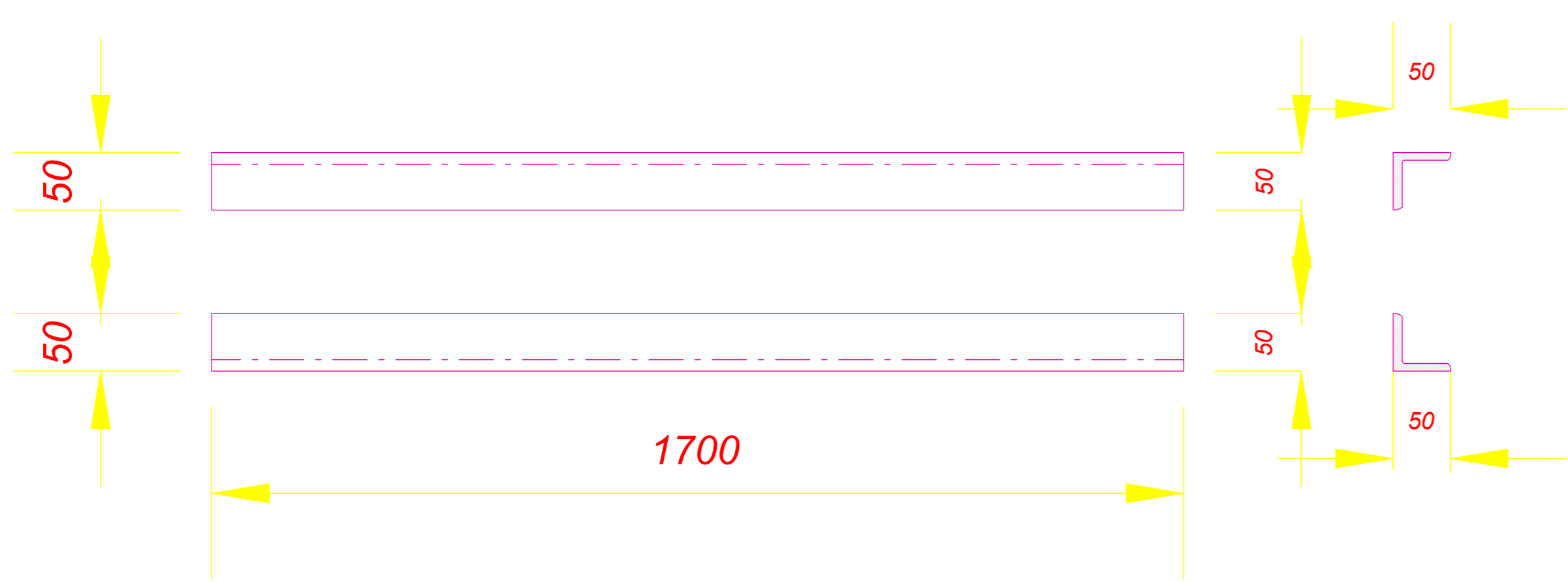

Poz. 3 L 50x50x6 (2 copë)

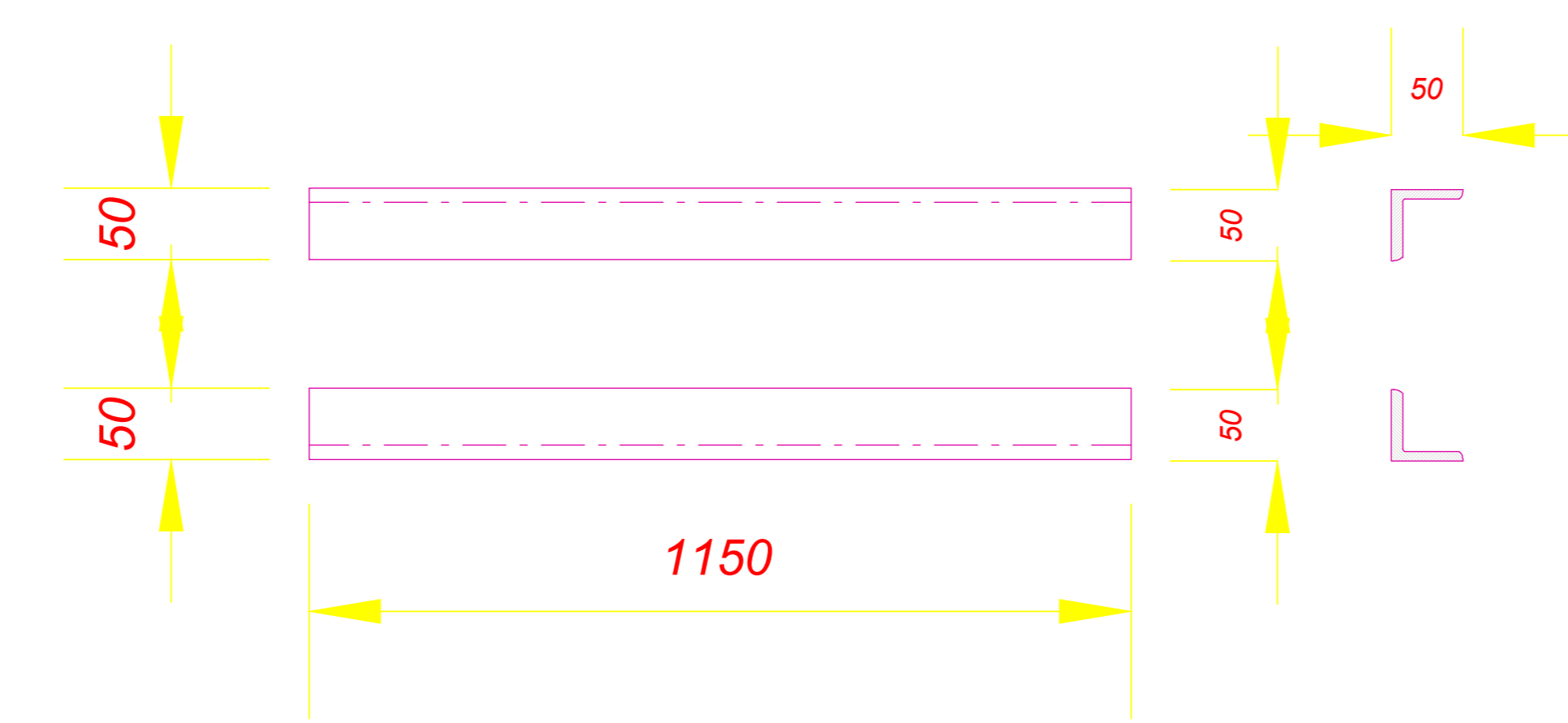

Poz. 8 L 50x50x6 (4 copë)

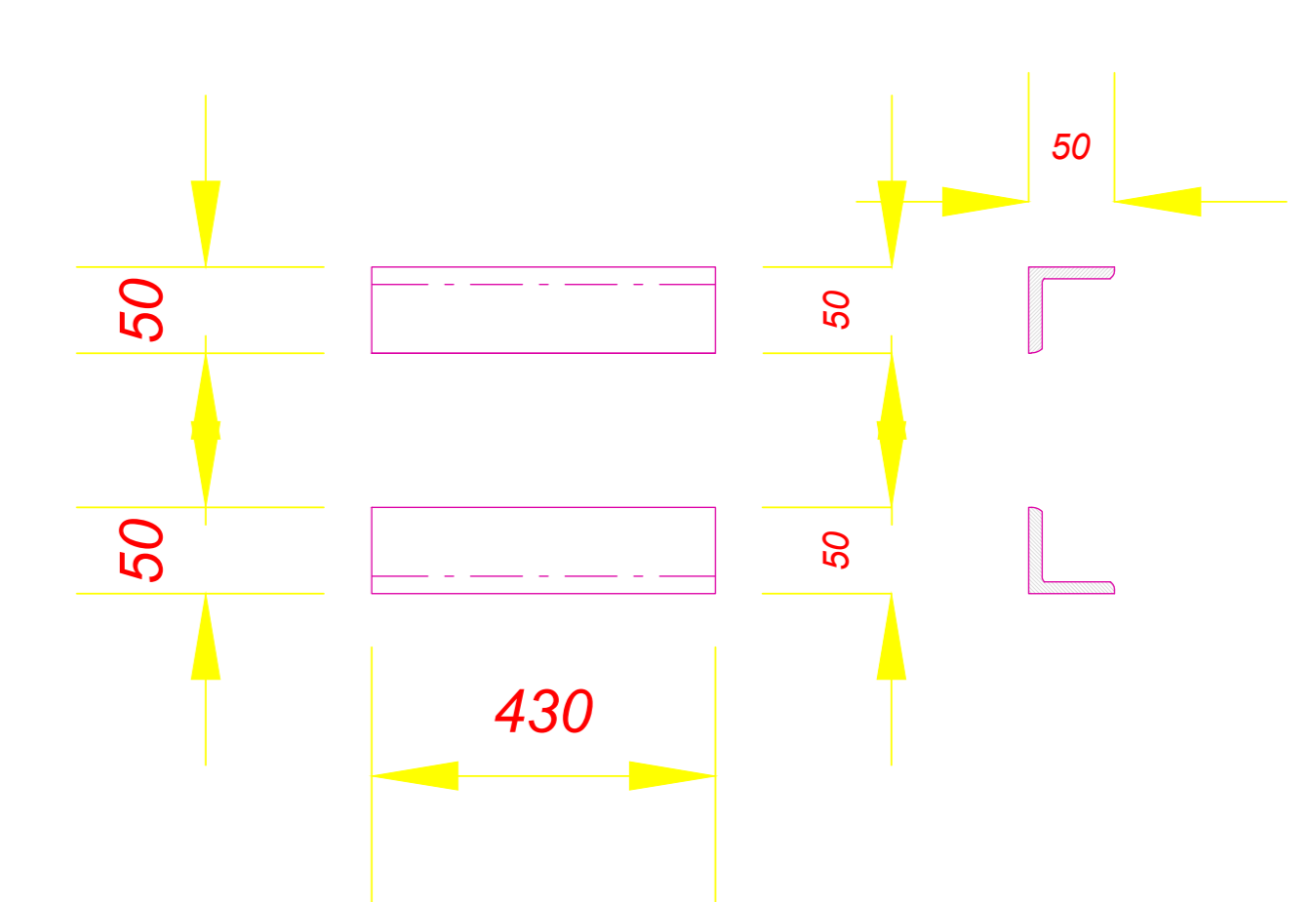

C

C

Poz. 4 L 50x50x6 (2 copë)

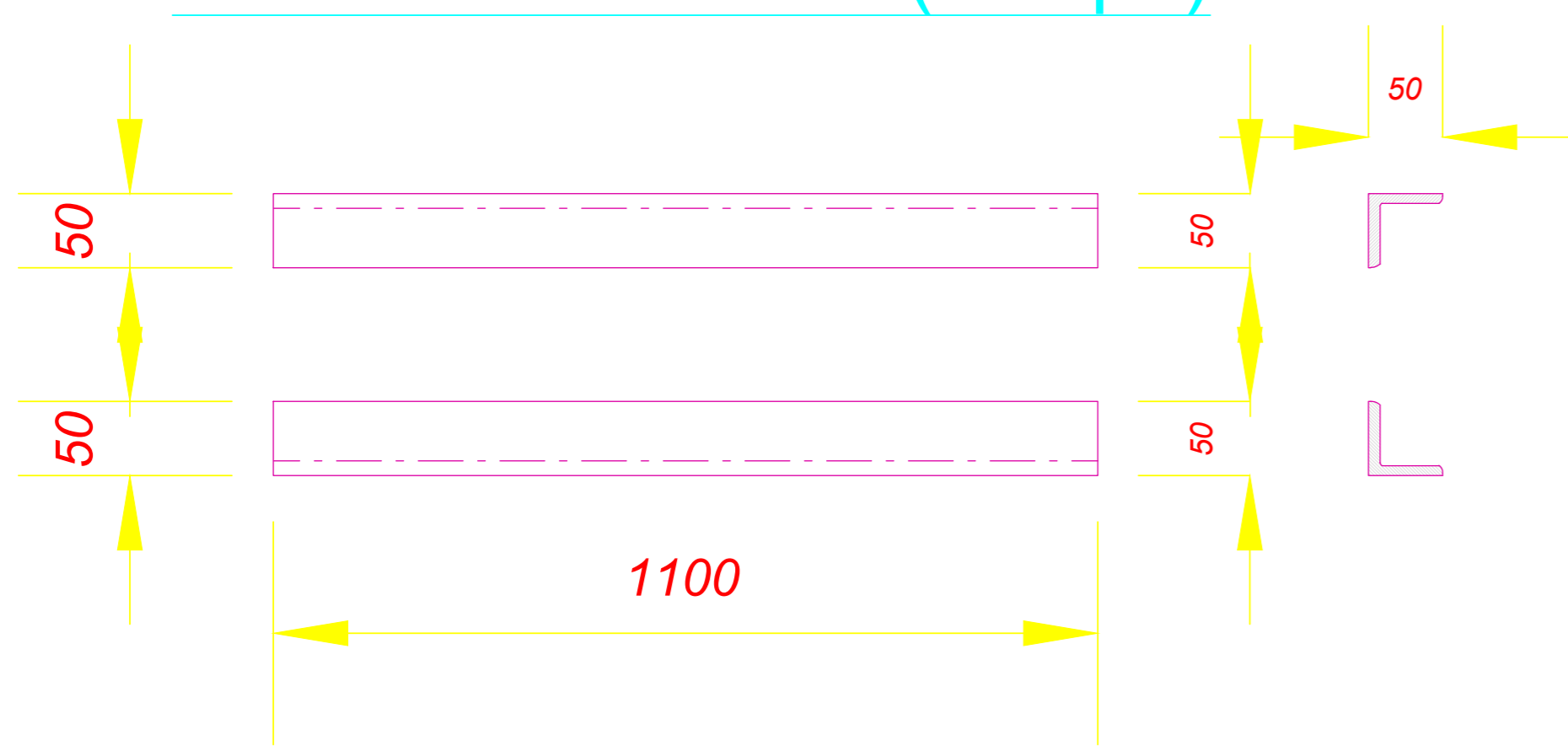

Poz. 5 L 50x50x6 (2 copë)

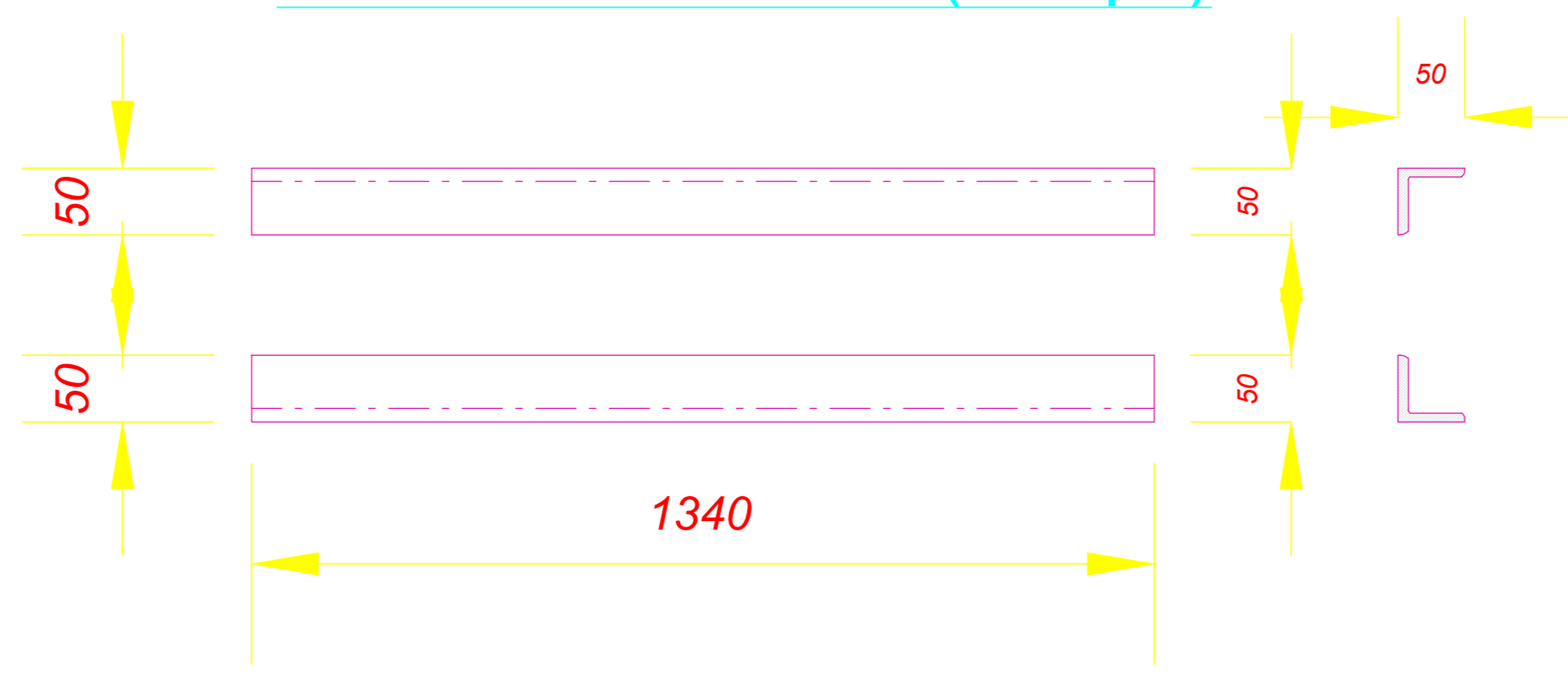

Poz. 7 L 50x50x6 (8 copë)

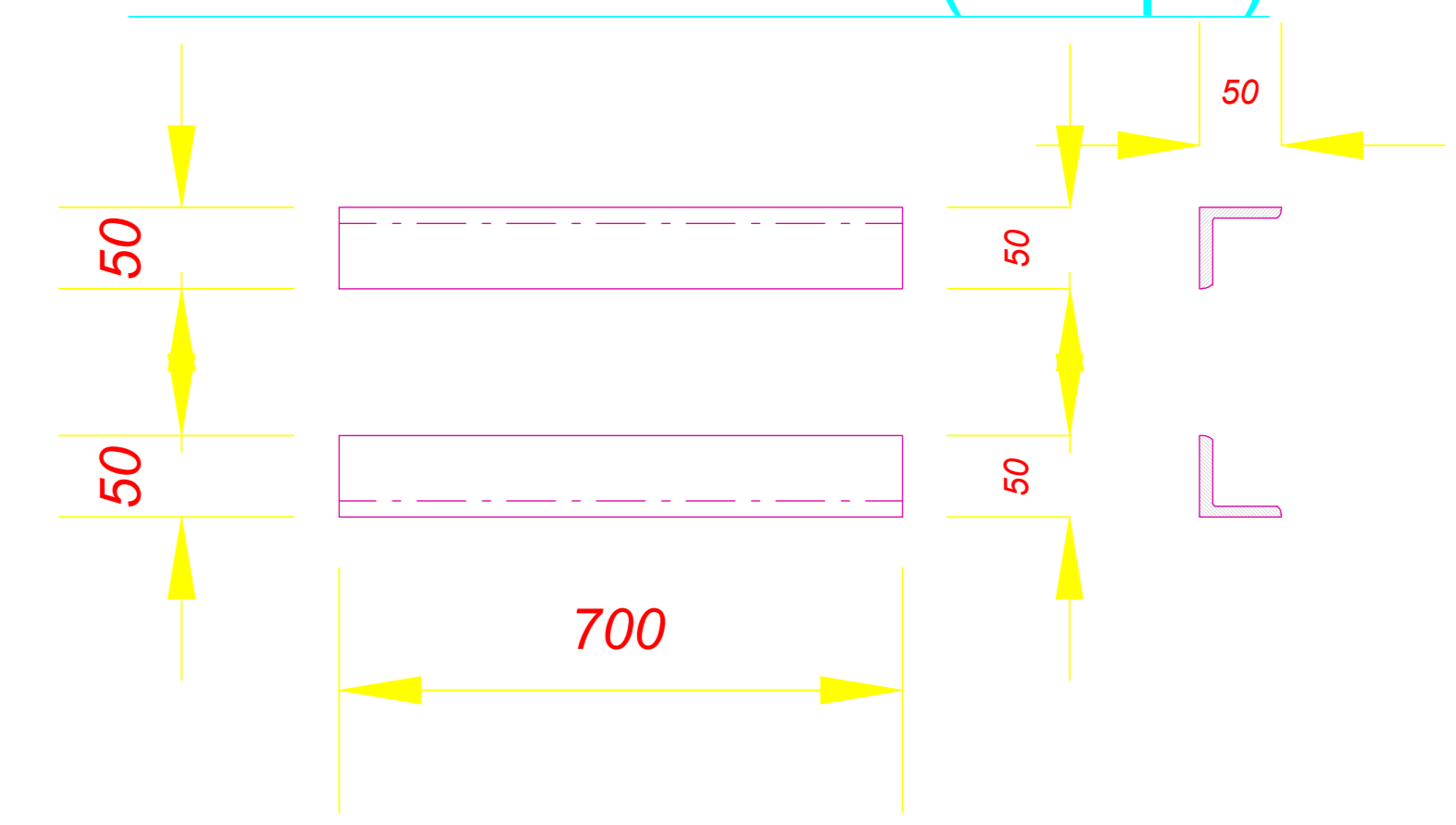

D

D

Poz. 6 L 50x50x6 (2 copë)

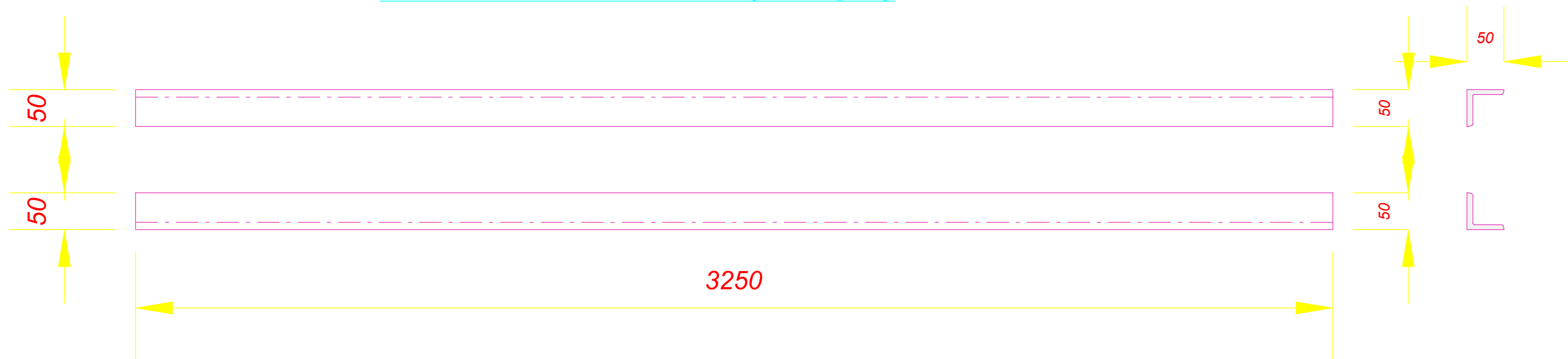

F

F

	DREJTORI			
	SHEF DEGA TEKNIKE			
DREJTORIA E TENSIONIT TË LARTË	SHEF ZYRA PROJEKTIT			
	PROJEKTOI			
Emërtimi objektit FUQIZIMI I NËNSTACIONIT 110/35/10KV ÇOROVODË.	PROJEKTOI			
	PROJEKTOI			
	PROJEKTOI			
	PERPUNOI			
Emërtimi fletës Bazamenti i transformatorit të fuqisë së N.Stacionit. Detaje të profileve.	PERPUNOI			
	FAZA: PROJEKT ZBATIMI			
Porositës: DTL	SHKALLA	Dt.	2023	DIN A3
	NR. PROJEKTIT			
	FLETA VIZATIMIT			

1

2

3

4

5

6

7

8