

"Hartimi i projekteve te zyrave postare "

-FILIALI NR. 5 TIRANË

Porositës

"Posta Shqiptare sh.a."

Faza

Projekt - Zbatimi

Titulli i Projektit

"Hartimi i projekteve te zyrave postare "



4K PPF CONSULTING
MO1715004E

PROJEKTUES:

"4K PPF "

Licensë N.6984/1

Arkitekt FATRI PETKU	liç. A-1166/2	
Arkitekt NDUE GJACI	liç. A.0031/4	
Ing. elektrik MIRA GOLEMI	liç. E. 0751/2	
Ing. hidro. ENKELEDA DOKLE	liç. K.1075/3	
Ing. ndertimi BEXHET ÇOBANI	liç. K.0383/5	
Ing. mekanik FERDINANT GERMENJI		



NET - GROUP

Arkitekthe DIANA MITRUSHI	liç. A.0212/4	
Ing. elektrik BURHAN DEMNERI	liç. E.1049/2	
Ing. mekanik GJERGJI KOTORI	liç. M.0579/1	
Ing. hidro. LULJETA KUÇI	liç. K.2022/1	
Ing. ndertimi ILIRIAN KOKALARI	liç. K1008/1	

Kapitulli

ARKITEKTURA

Titulli i Vizatimit

Shkalla

Nr. i Fletës

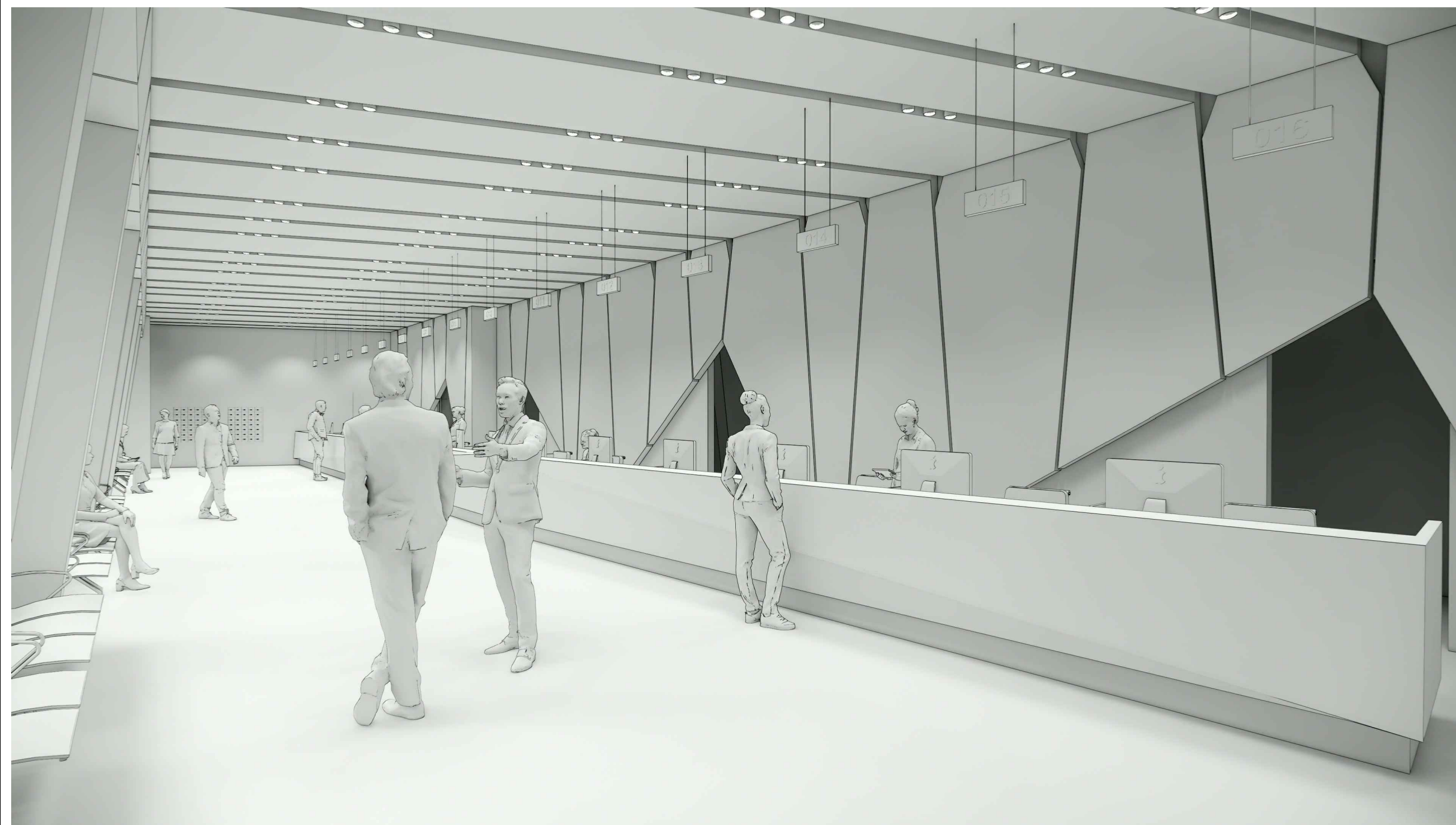

Porositës

"Posta Shqiptare sh.a."

Faza

Projekt - Zbatimi

Titulli i Projektit

"Hartimi i projekteve te zyrave postare "



PROJEKTUES:
"4K PPF "
Licensë N.6984/1

Arkitekt FATRI PETKU	liç. A-1166/2
Arkitekt NDUE GJACI	liç. A.0031/4
Ing. elektrik MIRA GOLEMI	liç. E. 0751/2
Ing. hidro. ENKELEDA DOKLE	liç. K.1075/3
Ing. ndertimi BEXHET ÇOBANI	liç. K.0383/5
Ing. mekanik FERDINANT GERMENJI	



Arkitekta DIANA MITRUSHI	liç. A.0212/4
Ing. elektrik BURHAN DEMNERI	liç. E.1049/2
Ing. mekanik GJERGJI KOTORI	liç. M.0579/1
Ing. hidro. LULJETA KUÇI	liç. K.2022/1
Ing. ndertimi ILIRIAN KOKALARI	liç. K1008/1

Kapitulli

ARKITEKTURA

Titulli i Vizatimit

Pamje

Shkalla

Nr. i Fletës

A.01

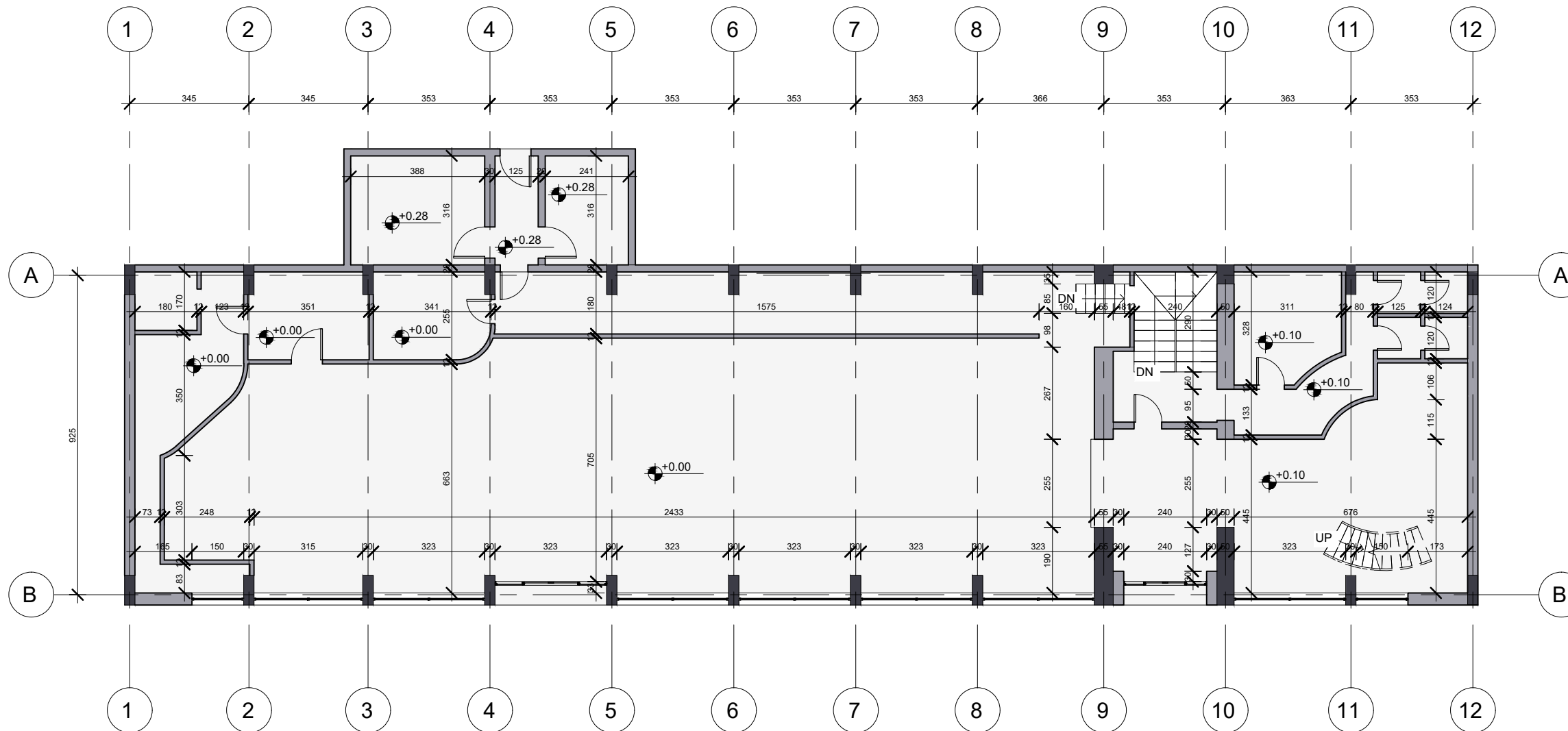

Porositës

"Posta Shqiptare sh.a."

Faza

Projekt - Zbatimi

Titulli i Projektit

"Hartimi i projekteve te zyrave postare "



PROJEKTUES:
"4K PPF "
Licensë N.6984/1

Arkitekt FATRI PETKU	liç. A-1166/2
Arkitekt NDUE GJACI	liç. A.0031/4
Ing. elektrik MIRA GOLEMI	liç. E. 0751/2
Ing. hidro. ENKELEDA DOKLE	liç. K.1075/3
Ing. ndertimi BEXHET ÇOBANI	liç. K.0383/5
Ing. mekanik FERDINANT GERMENJI	



Arkitekta DIANA MITRUSHI	liç. A.0212/4
Ing. elektrik BURHAN DEMNERI	liç. E.1049/2
Ing. mekanik GJERGJI KOTORI	liç. M.0579/1
Ing. hidro. LULJETA KUÇI	liç. K.2022/1
Ing. ndertimi ILIRIAN KOKALARI	liç. K1008/1

Kapitulli

ARKITEKTURA

Titulli i Vizatimit

Planimetria ekzistuese,kati perdhe

Shkalla

1:150

Nr. i Fletës

A.02

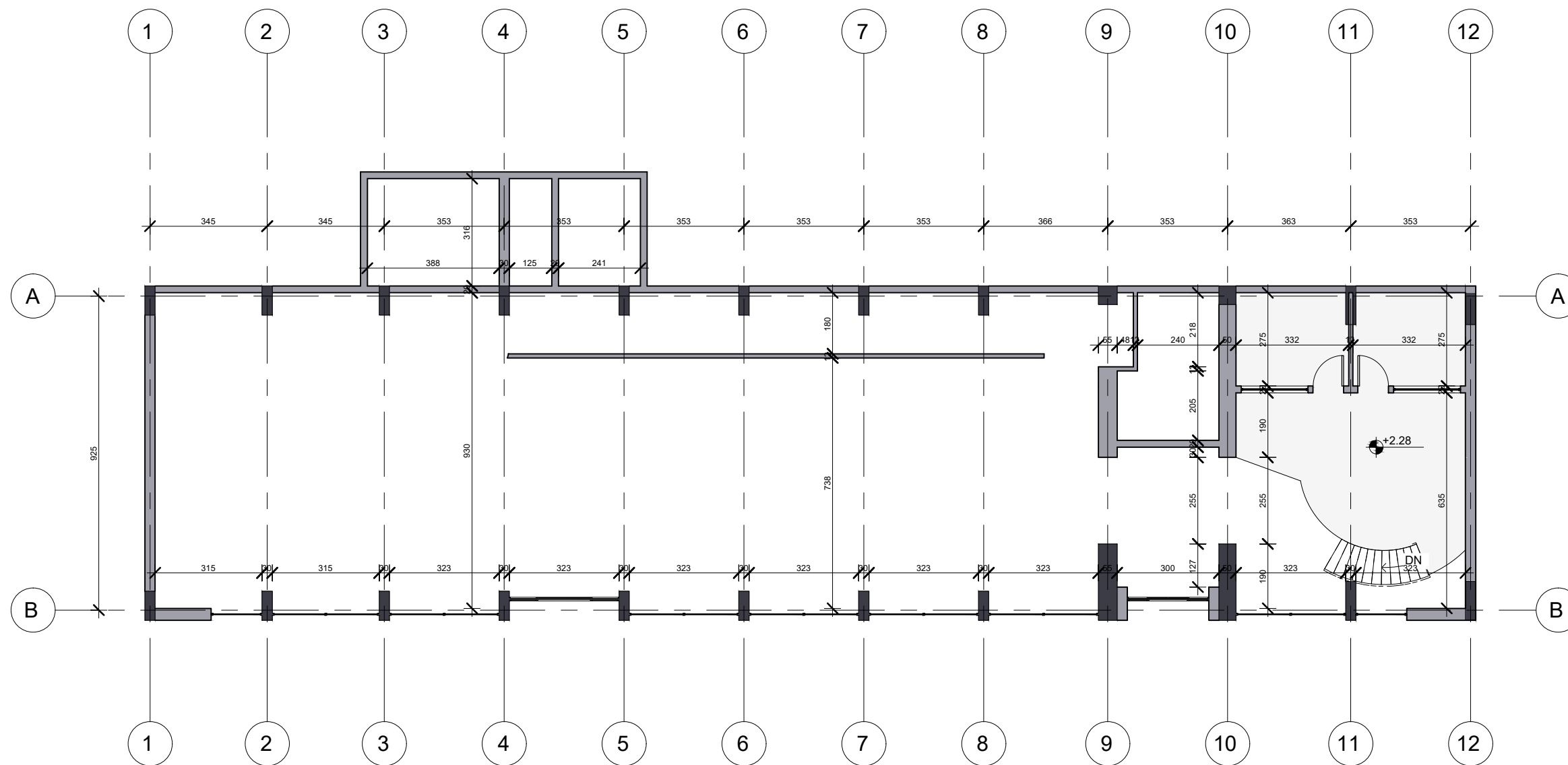

Porositës

"Posta Shqiptare sh.a."

Faza

Projekt - Zbatimi

Titulli i Projektit

"Hartimi i projekteve te zyrave postare "



PROJEKTUES:
"4K PPF "
Licensë N.6984/1

Arkitekt FATRI PETKU	liç. A-1166/2
Arkitekt NDUE GJACI	liç. A.0031/4
Ing. elektrik MIRA GOLEMI	liç. E. 0751/2
Ing. hidro. ENKELEDA DOKLE	liç. K.1075/3
Ing. ndertimi BEXHET ÇOBANI	liç. K.0383/5
Ing. mekanik FERDINANT GERMENJI	



Arkitekthe DIANA MITRUSHI	liç. A.0212/4
Ing. elektrik BURHAN DEMNERI	liç. E.1049/2
Ing. mekanik GJERGJI KOTORI	liç. M.0579/1
Ing. hidro. LULJETA KUÇI	liç. K.2022/1
Ing. ndertimi ILIRIAN KOKALARI	liç. K1008/1

Kapitulli

ARKITEKTURA

Titulli i Vizatimit

Planimetria ekzistuese,kati 1

Shkalla

1:150

Nr. i Fletës

A.03

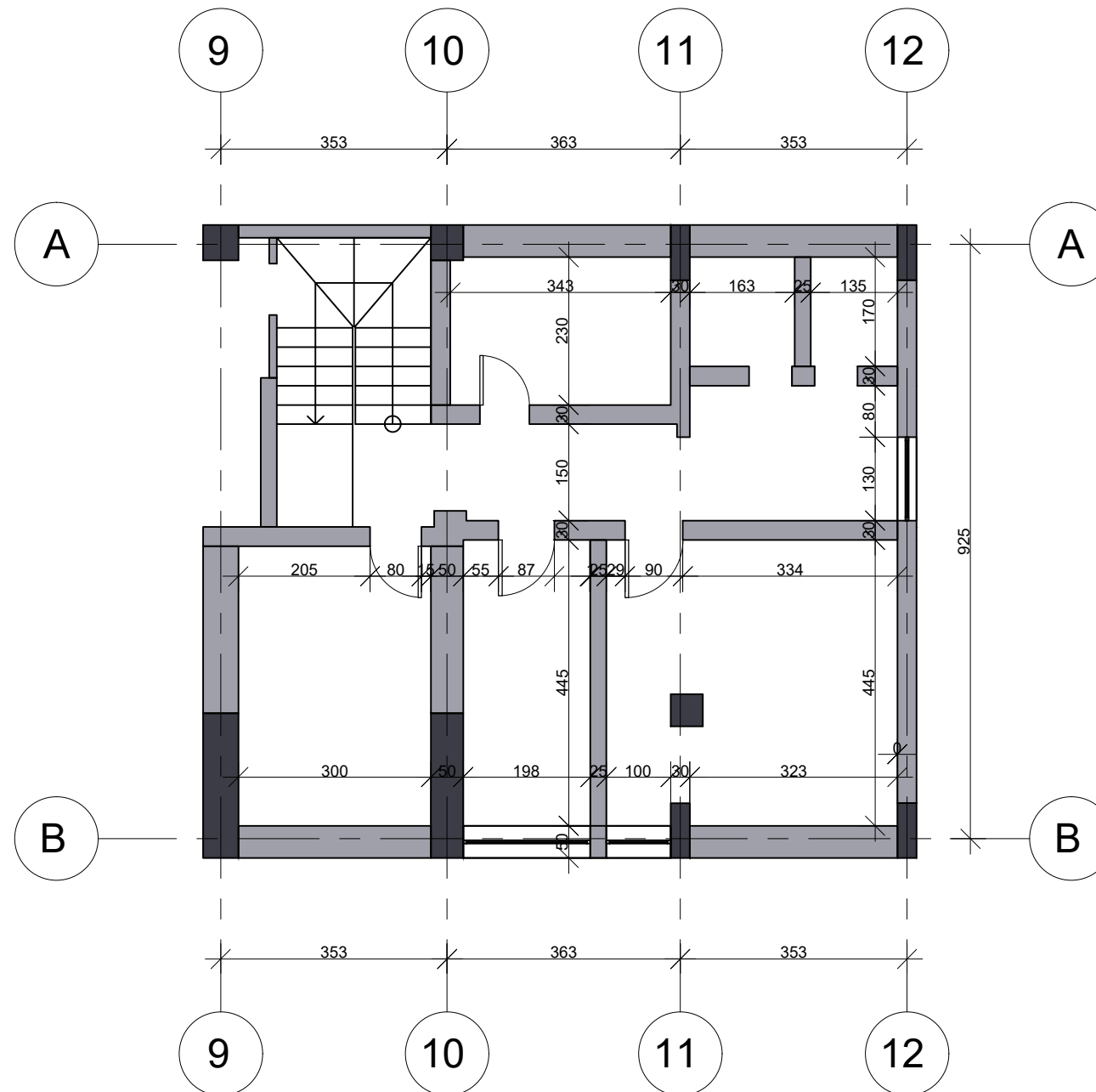

Porositës

"Posta Shqiptare sh.a."

Faza

Projekt - Zbatimi

Titulli i Projektit

"Hartimi i projekteve te zyrave postare "



PROJEKTUES:
"4K PPF "
Licensë N.6984/1

Arkitekt FATRI PETKU	liç. A-1166/2
Arkitekt NDUE GJACI	liç. A.0031/4
Ing. elektrik MIRA GOLEMI	liç. E. 0751/2
Ing. hidro. ENKELEDA DOKLE	liç. K.1075/3
Ing. ndertimi BEXHET ÇOBANI	liç. K.0383/5
Ing. mekanik FERDINANT GERMENJI	



Arkitekta DIANA MITRUSHI	liç. A.0212/4
Ing. elektrik BURHAN DEMNERI	liç. E.1049/2
Ing. mekanik GJERGJI KOTORI	liç. M.0579/1
Ing. hidro. LULJETA KUÇI	liç. K.2022/1
Ing. ndertimi ILIRIAN KOKALARI	liç. K1008/1

Kapitulli

ARKITEKTURA

Titulli i Vizatimit

Planimetria ekzistuese,kati nentoke

Shkalla

1:100

Nr. i Fletës

A.04

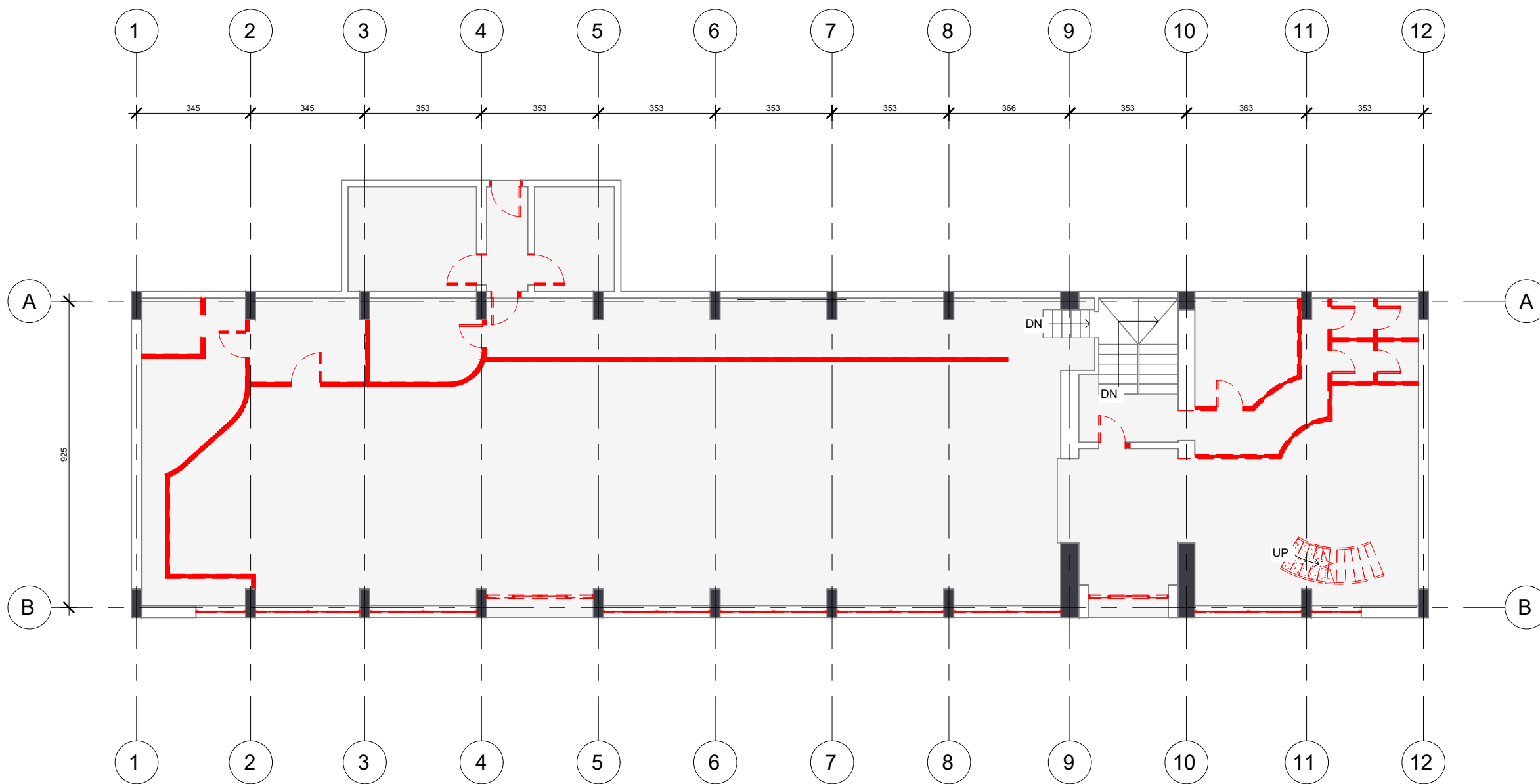

Porositës

"Posta Shqiptare sh.a."

Faza

Projekt - Zbatimi

Titulli i Projektit

"Hartimi i projekteve te zyrave postare "



PROJEKTUES:
"4K PPF "
Licensë N.6984/1

Arkitekt FATRI PETKU	liç. A-1166/2
Arkitekt NDUE GJACI	liç. A.0031/4
Ing. elektrik MIRA GOLEMI	liç. E. 0751/2
Ing. hidro. ENKELEDA DOKLE	liç. K.1075/3
Ing. ndertimi BEXHET ÇOBANI	liç. K.0383/5
Ing. mekanik FERDINANT GERMENJI	



Arkitekta DIANA MITRUSHI	liç. A.0212/4
Ing. elektrik BURHAN DEMNERI	liç. E.1049/2
Ing. mekanik GJERGJI KOTORI	liç. M.0579/1
Ing. hidro. LULJETA KUÇI	liç. K.2022/1
Ing. ndertimi ILIRIAN KOKALARI	liç. K1008/1

Kapitulli

ARKITEKTURA

Titulli i Vizatimit

Plani i prishjeve,kati perdhe

Shkalla

1:150

Nr. i Fletës

A.05

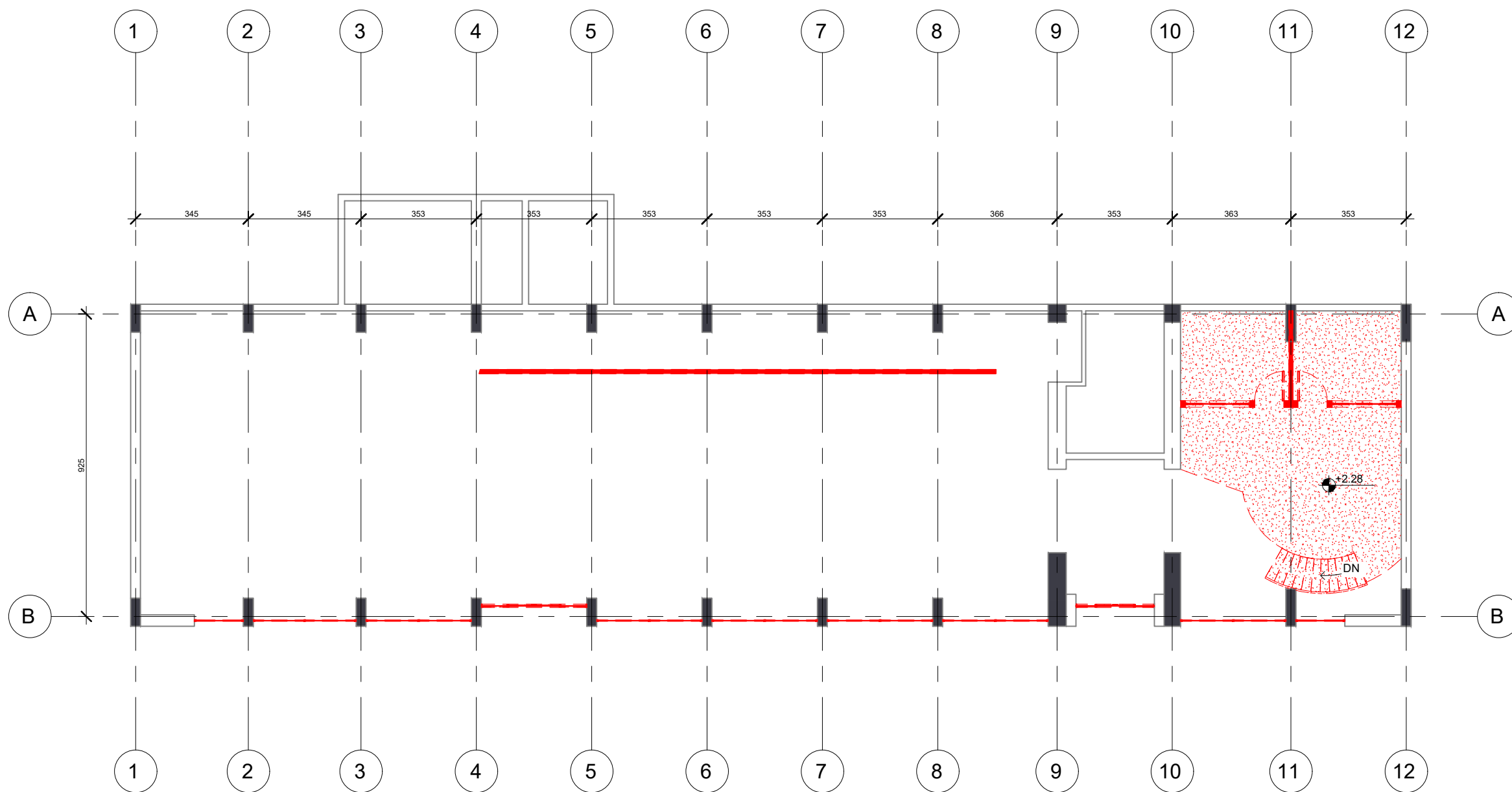

Porositës

"Posta Shqiptare sh.a."

Faza

Projekt - Zbatimi

Titulli i Projektit

"Hartimi i projekteve te zyrave postare "



PROJEKTUES:
"4K PPF "
Licensë N.6984/1

Arkitekt FATRI PETKU	liç. A-1166/2
Arkitekt NDUE GJACI	liç. A.0031/4
Ing. elektrik MIRA GOLEMI	liç. E. 0751/2
Ing. hidro. ENKELEDA DOKLE	liç. K.1075/3
Ing. ndertimi BEXHET ÇOBANI	liç. K.0383/5
Ing. mekanik FERDINANT GERMENJI	



Arkitekta DIANA MITRUSHI	liç. A.0212/4
Ing. elektrik BURHAN DEMNERI	liç. E.1049/2
Ing. mekanik GJERGJI KOTORI	liç. M.0579/1
Ing. hidro. LULJETA KUÇI	liç. K.2022/1
Ing. ndertimi ILIRIAN KOKALARI	liç. K1008/1

Kapitulli

ARKITEKTURA

Titulli i Vizatimit

Plani i prishjeve,kati 1

Shkalla

1:150

Nr. i Fletës

A.06

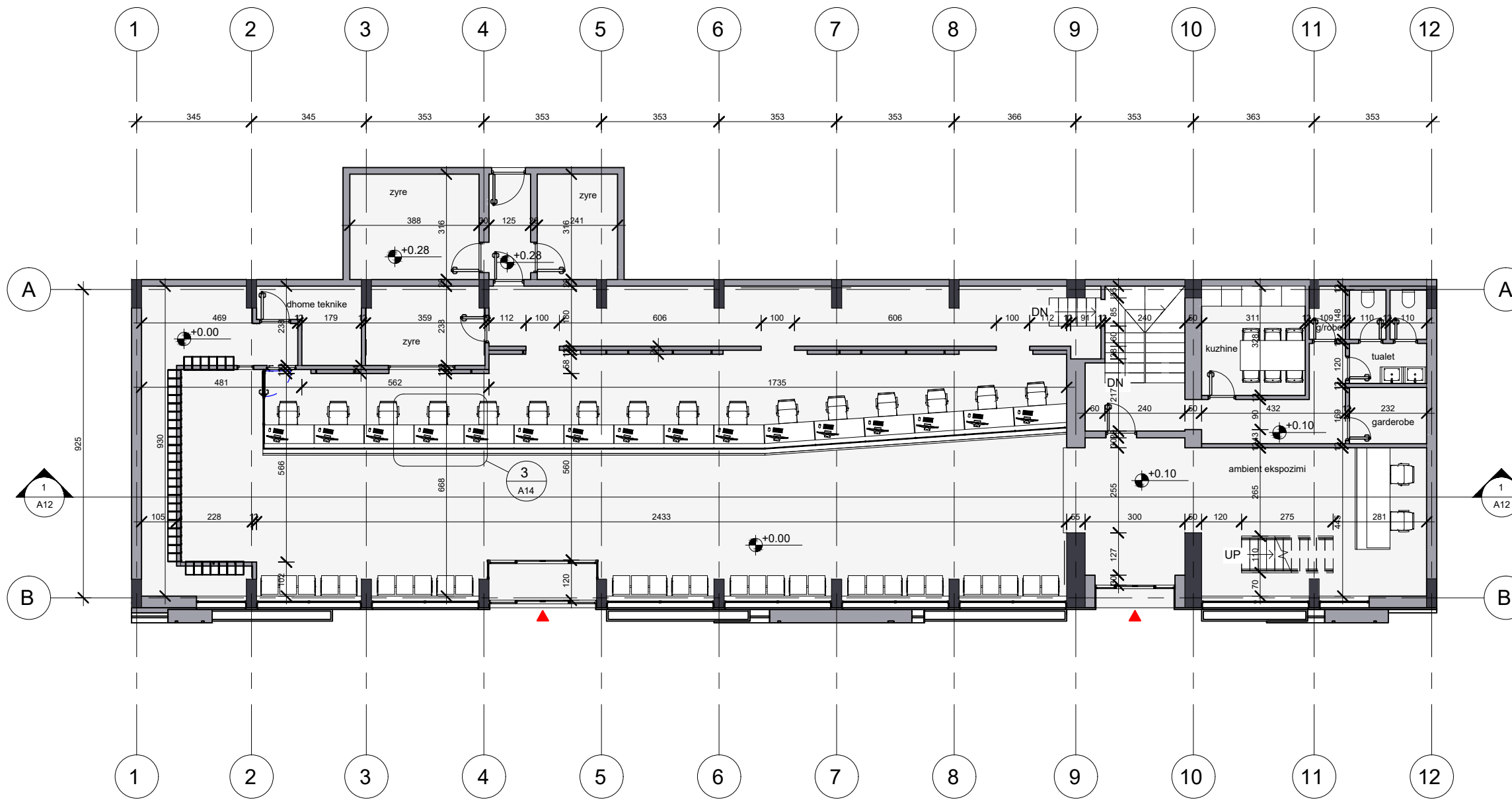

Porositës
"Posta Shqiptare sh.a."
 Faza
Projekt - Zbatimi
 Titulli i Projektit
"Hartimi i projekteve te zyrave postare "

PROJEKTUES:
"4K PPF "
 Licensë N.6984/1

Arkitekt FATRI PETKU	liç. A-1166/2
Arkitekt NDUE GJACI	liç. A.0031/4
Ing. elektrik MIRA GOLEMI	liç. E. 0751/2
Ing. hidro. ENKELEDA DOKLE	liç. K.1075/3
Ing. ndertimi BEXHET ÇOBANI	liç. K.0383/5
Ing. mekanik FERDINANT GERMENJI	

NET - GROUP

Arkitekta DIANA MITRUSHI	liç. A.0212/4
Ing. elektrik BURHAN DEMNERI	liç. E.1049/2
Ing. mekanik GJERGJI KOTORI	liç. M.0579/1
Ing. hidro. LULJETA KUÇI	liç. K.2022/1
Ing. ndertimi ILIRIAN KOKALARI	liç. K1008/1

Kapitulli
ARKITEKTURA
 Titulli i Vizatimit
Planimetria e re,kati perdhe

Shkalla 1:150	Nr. i Fletës A.07
-------------------------	-----------------------------

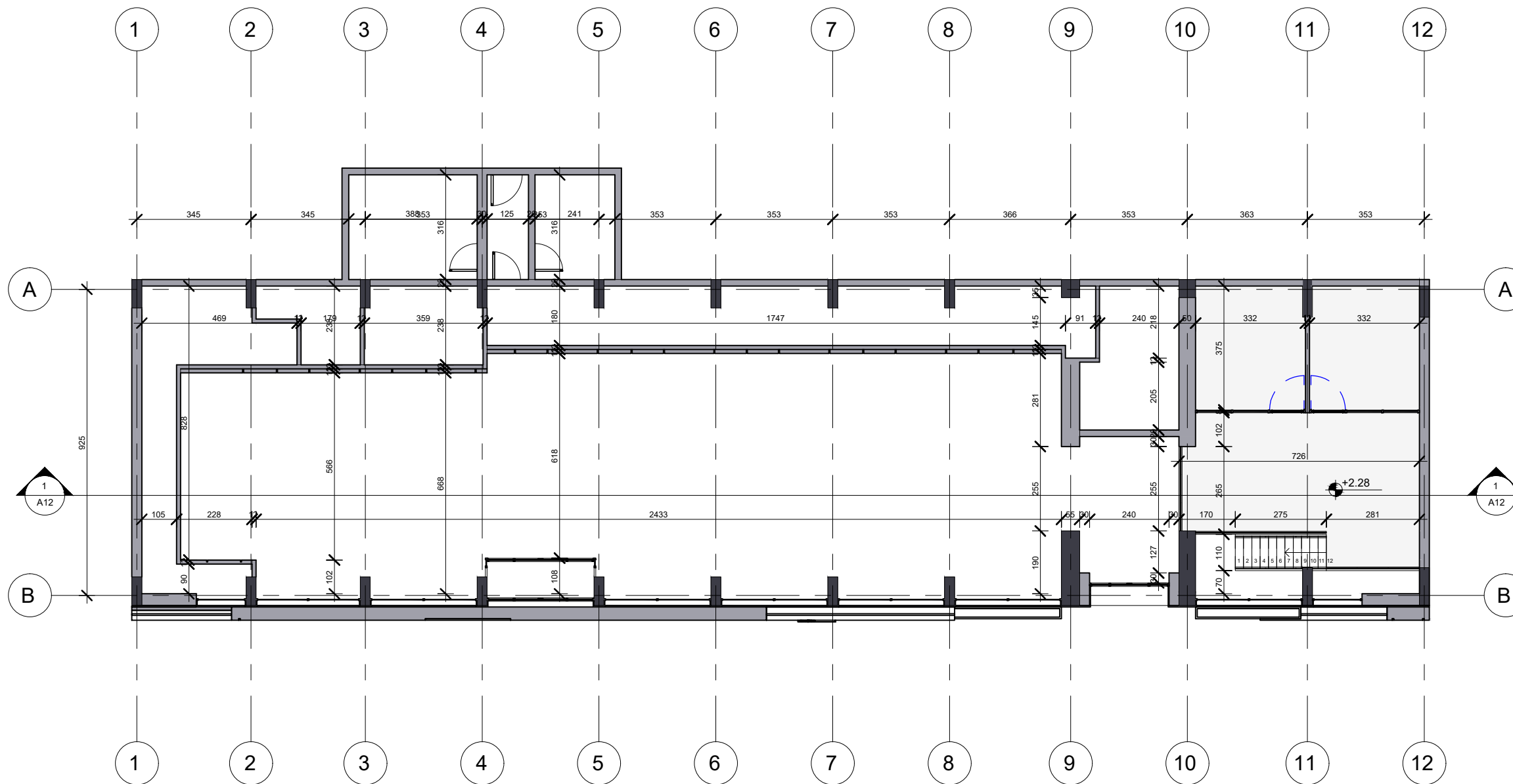

Porositës

"Posta Shqiptare sh.a."

Faza

Projekt - Zbatimi

Titulli i Projektit

"Hartimi i projekteve te zyrave postare "



PROJEKTUES:
"4K PPF "
Licensë N.6984/1

Arkitekt PATRI PETKU	liç. A-1166/2
Arkitekt NDUE GJACI	liç. A.0031/4
Ing. elektrik MIRA GOLEMI	liç. E. 0751/2
Ing. hidro. ENKELEDA DOKLE	liç. K.1075/3
Ing. ndertimi BEXHET ÇOBANI	liç. K.0383/5
Ing. mekanik FERDINANT GERMENJI	



Arkitekthe DIANA MITRUSHI	liç. A.0212/4
Ing. elektrik BURHAN DEMNERI	liç. E.1049/2
Ing. mekanik GJERGJI KOTORI	liç. M.0579/1
Ing. hidro. LULJETA KUÇI	liç. K.2022/1
Ing. ndertimi ILIRIAN KOKALARI	liç. K1008/1

Kapitulli

ARKITEKTURA

Titulli i Vizatimit

Planimetria e re, kati 1

Shkalla

1:150

Nr. i Fletës

A.08

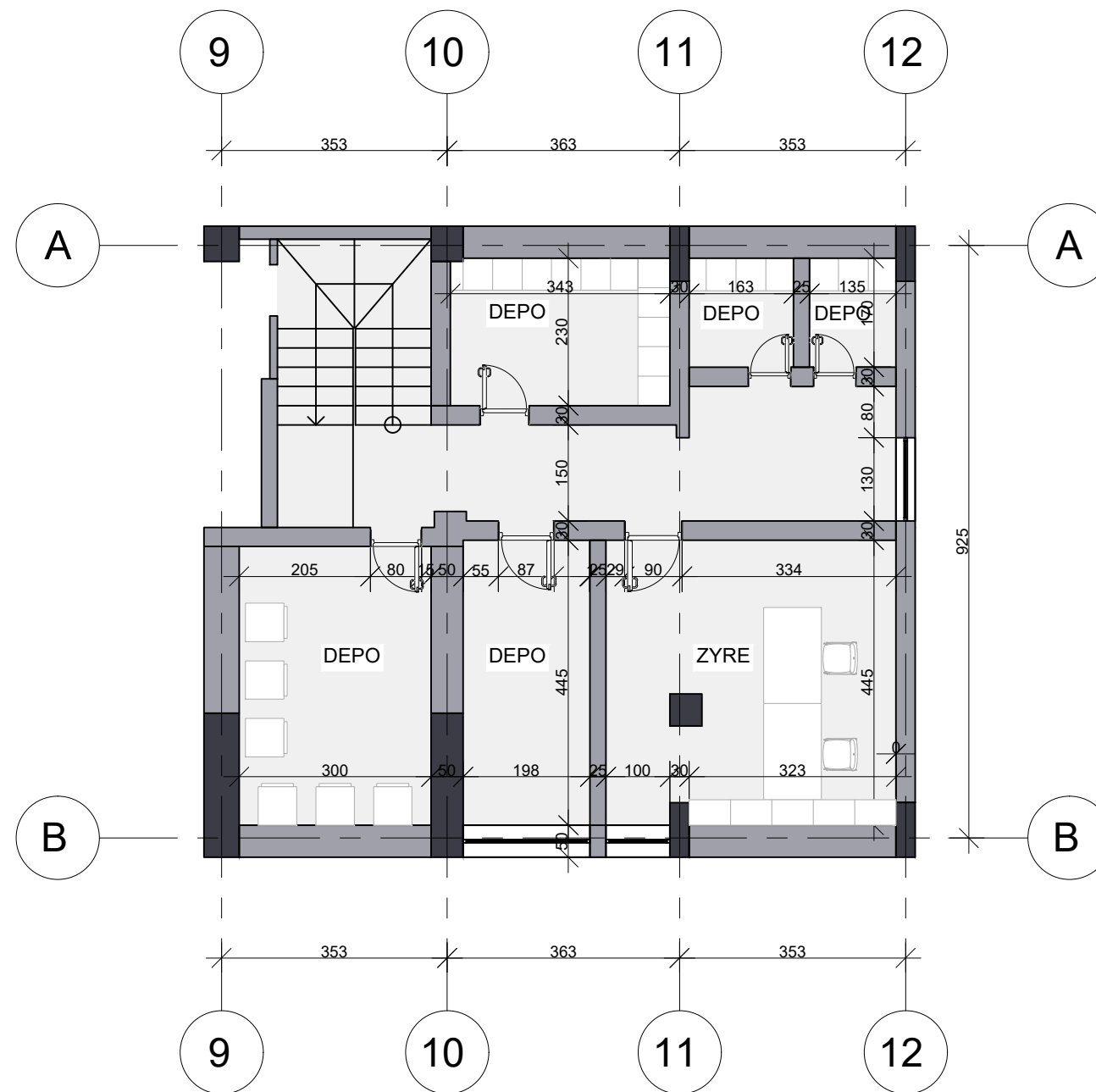

Porositës

"Posta Shqiptare sh.a."

Faza

Projekt - Zbatimi

Titulli i Projektit

"Hartimi i projekteve te zyrave postare "



PROJEKTUES:
"4K PPF "
Licensë N.6984/1

Arkitekt FATRI PETKU	liç. A-1166/2
Arkitekt NDUE GJACI	liç. A.0031/4
Ing. elektrik MIRA GOLEMI	liç. E. 0751/2
Ing. hidro. ENKELEDA DOKLE	liç. K.1075/3
Ing. ndertimi BEXHET ÇOBANI	liç. K.0383/5
Ing. mekanik FERDINANT GERMENJI	



Arkitekt DIANA MITRUSHI	liç. A.0212/4
Ing. elektrik BURHAN DEMNERI	liç. E.1049/2
Ing. mekanik GJERGJI KOTORI	liç. M.0579/1
Ing. hidro. LULJETA KUÇI	liç. K.2022/1
Ing. ndertimi ILIRIAN KOKALARI	liç. K1008/1

Kapitulli

ARKITEKTURA

Titulli i Vizatimit

Planimetria e re,kati nentoke

Shkalla

1:100

Nr. i Fletës

A.09



Porositës

"Posta Shqiptare sh.a."

Faza

Projekt - Zbatimi

Titulli i Projektit

"Hartimi i projekteve te zyrave postare "



PROJEKTUES:
"4K PPF "
 Licensë N.6984/1

Arkitekt PATRI PETKU	liç. A-1166/2
Arkitekt NDUE GJACI	liç. A.0031/4
Ing. elektrik MIRA GOLEMI	liç. E. 0751/2
Ing. hidro. ENKELEDA DOKLE	liç. K.1075/3
Ing. ndertimi BEXHET ÇOBANI	liç. K.0383/5
Ing. mekanik FERDINANT GERMENJI	



Arkitekthe DIANA MITRUSHI	liç. A.0212/4
Ing. elektrik BURHAN DEMNERI	liç. E.1049/2
Ing. mekanik GJERGJI KOTORI	liç. M.0579/1
Ing. hidro. LULJETA KUÇI	liç. K.2022/1
Ing. ndertimi ILIRIAN KOKALARI	liç. K1008/1

Kapitulli

ARKITEKTURA

Titulli i Vizatimit

Plani i shtrimit dhe i veshjeve, kati perdhe

Shkalla

1:150

Nr. i Fletës

A.10

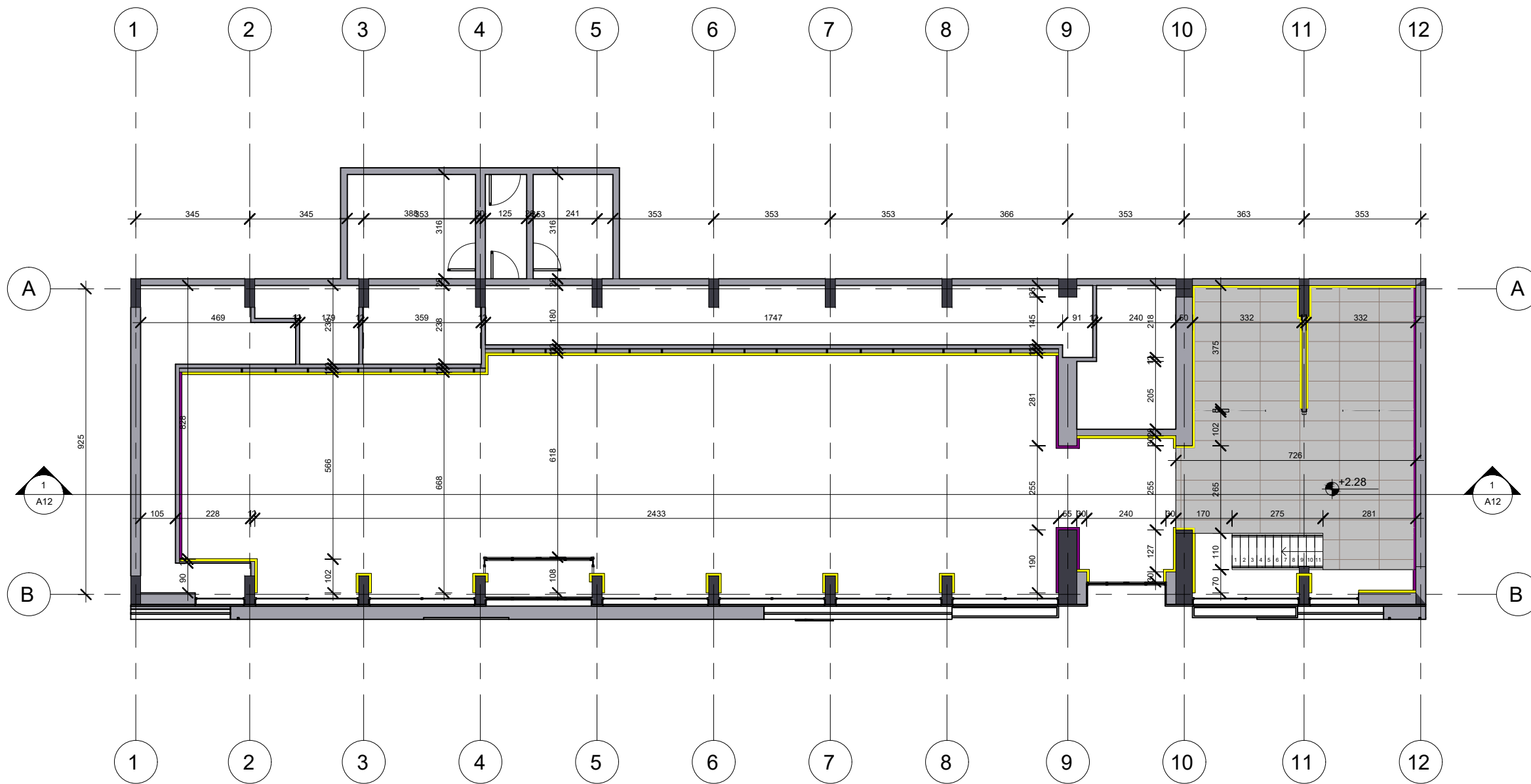

- veshje pulpis
- boje e bardhe
- boje e zeze
- pllaka 120x60

Porositës

"Posta Shqiptare sh.a."

Faza

Projekt - Zbatimi

Titulli i Projektit

"Hartimi i projekteve te zyrave postare "



PROJEKTUES:
"4K PPF "
Licensë N.6984/1

Arkitekt FATRI PETKU	liç. A-1166/2
Arkitekt NDUE GJACI	liç. A.0031/4
Ing. elektrik MIRA GOLEMI	liç. E. 0751/2
Ing. hidro. ENKELEDA DOKLE	liç. K.1075/3
Ing. ndertimi BEXHET ÇOBANI	liç. K.0383/5
Ing. mekanik FERDINANT GERMENJI	



Arkitekta DIANA MITRUSHI	liç. A.0212/4
Ing. elektrik BURHAN DEMNERI	liç. E.1049/2
Ing. mekanik GJERGJI KOTORI	liç. M.0579/1
Ing. hidro. LULJETA KUÇI	liç. K.2022/1
Ing. ndertimi ILIRIAN KOKALARI	liç. K1008/1

Kapitulli

ARKITEKTURA

Titulli i Vizatimit

Plani i shtrimit dhe i veshjeve, kati 1

Shkalla

1:150

Nr. i Fletës

A.11

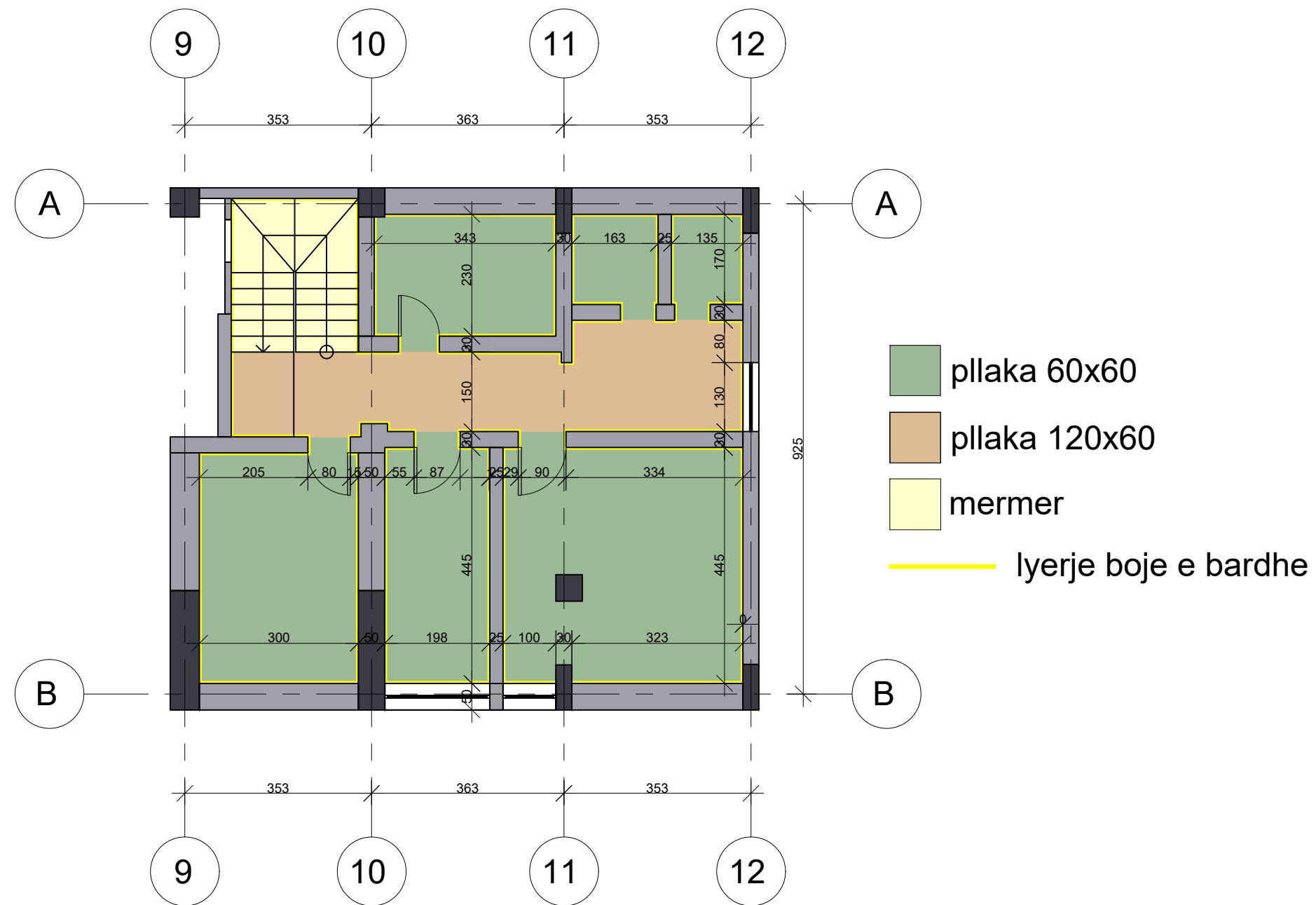

Porositës

"Posta Shqiptare sh.a."

Faza

Projekt - Zbatimi

Titulli i Projektit

"Hartimi i projekteve te zyrave postare "



PROJEKTUES:
"4K PPF "
Licensë N.6984/1

Arkitekt FATRI PETKU	liç. A-1166/2
Arkitekt NDUE GJACI	liç. A.0031/4
Ing. elektrik MIRA GOLEMI	liç. E. 0751/2
Ing. hidro. ENKELEDA DOKLE	liç. K.1075/3
Ing. ndertimi BEXHET ÇOBANI	liç. K.0383/5
Ing. mekanik FERDINANT GERMENJI	



Arkitekta DIANA MITRUSHI	liç. A.0212/4
Ing. elektrik BURHAN DEMNERI	liç. E.1049/2
Ing. mekanik GJERGJI KOTORI	liç. M.0579/1
Ing. hidro. LULJETA KUÇI	liç. K.2022/1
Ing. ndertimi ILIRIAN KOKALARI	liç. K1008/1

Kapitulli

ARKITEKTURA

Titulli i Vizatimit

Plani i shtrimit,kati nentoke

Shkalla

1:100

Nr. i Fletës

A.12

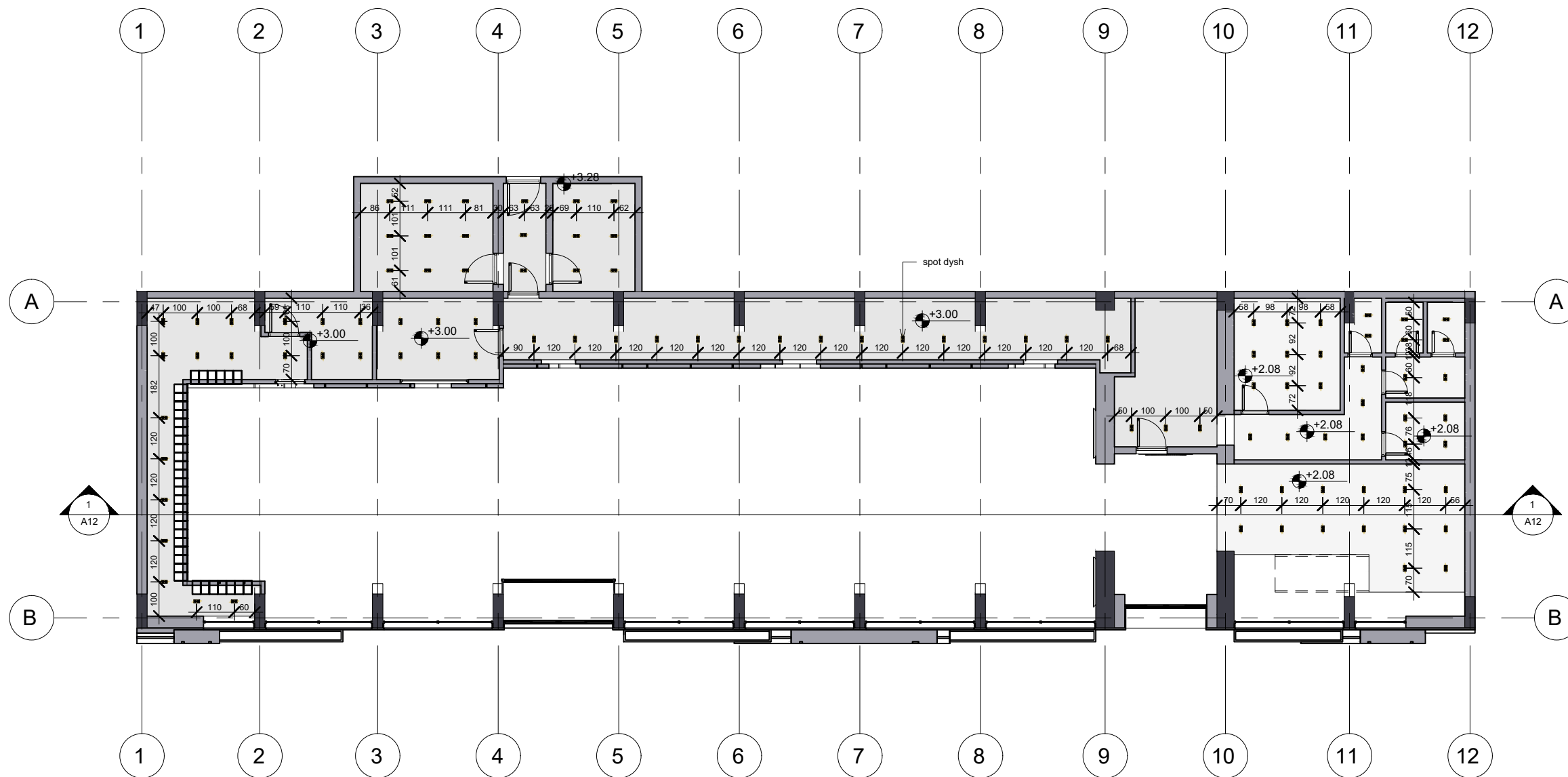

Porositës

"Posta Shqiptare sh.a."

Faza

Projekt - Zbatimi

Titulli i Projektit

"Hartimi i projekteve te zyrave postare "



PROJEKTUES:
"4K PPF "
Licensë N.6984/1

Arkitekt FATRI PETKU	liç. A-1166/2
Arkitekt NDUE GJACI	liç. A.0031/4
Ing. elektrik MIRA GOLEMI	liç. E. 0751/2
Ing. hidro. ENKELEDA DOKLE	liç. K.1075/3
Ing. ndertimi BEXHET ÇOBANI	liç. K.0383/5
Ing. mekanik FERDINANT GERMENJI	



Arkitekta DIANA MITRUSHI	liç. A.0212/4
Ing. elektrik BURHAN DEMNERI	liç. E.1049/2
Ing. mekanik GJERGJI KOTORI	liç. M.0579/1
Ing. hidro. LULJETA KUÇI	liç. K.2022/1
Ing. ndertimi ILIRIAN KOKALARI	liç. K1008/1

Kapitulli

ARKITEKTURA

Titulli i Vizatimit

**Plani i tavanit te varur,
kati perdhe**

Shkalla

1:150

Nr. i Fletës

A.13

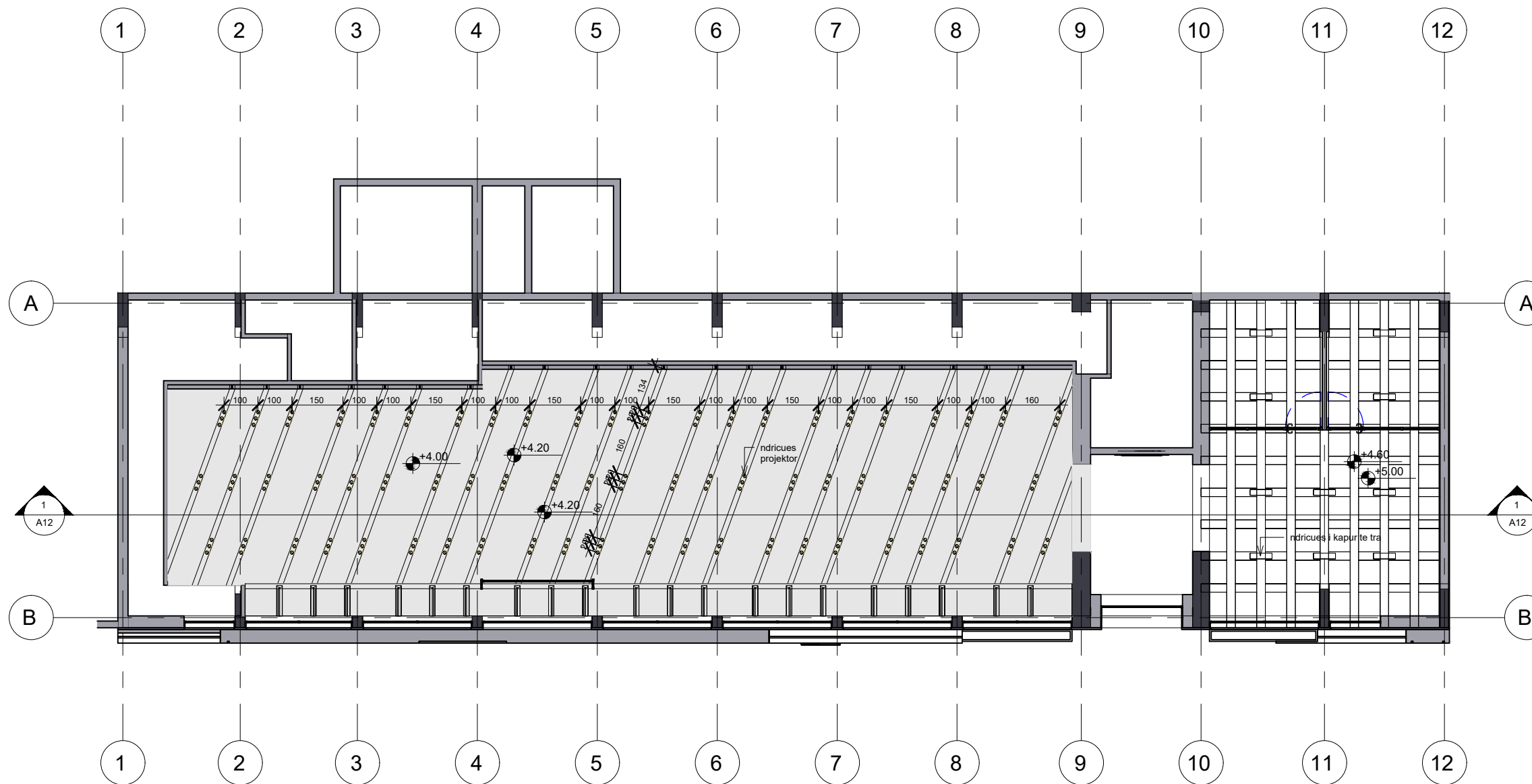

Porositës

"Posta Shqiptare sh.a."

Faza

Projekt - Zbatimi

Titulli i Projektit

"Hartimi i projekteve te zyrave postare "



PROJEKTUES:
"4K PPF "
Licensë N.6984/1

Arkitekt FATRI PETKU	liç. A-1166/2
Arkitekt NDUE GJACI	liç. A.0031/4
Ing. elektrik MIRA GOLEMI	liç. E. 0751/2
Ing. hidro. ENKELEDA DOKLE	liç. K.1075/3
Ing. ndertimi BEXHET ÇOBANI	liç. K.0383/5
Ing. mekanik FERDINANT GERMENJI	



Arkitekthe DIANA MITRUSHI	liç. A.0212/4
Ing. elektrik BURHAN DEMNERI	liç. E.1049/2
Ing. mekanik GJERGJI KOTORI	liç. M.0579/1
Ing. hidro. LULJETA KUÇI	liç. K.2022/1
Ing. ndertimi ILIRIAN KOKALARI	liç. K1008/1

Kapitulli

ARKITEKTURA

Titulli i Vizatimit

Plani i tavanit te varur,kati 1

Shkalla

1:150

Nr. i Fletës

A.14

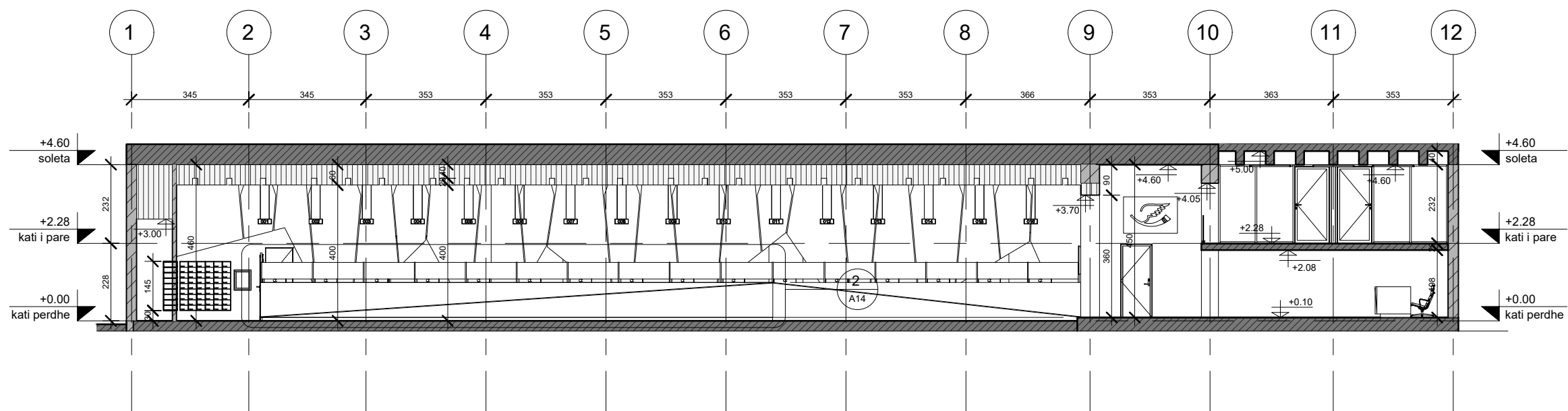

Porositës

"Posta Shqiptare sh.a."

Faza

Projekt - Zbatimi

Titulli i Projektit

"Hartimi i projekteve te zyrave postare "



4K PPF CONSULTING
M01715004E

PROJEKTUES:
"4K PPF "
Licensë N.6984/1

Arkitekt FATRI PETKU	liç. A-1166/2
Arkitekt NDUE GJACI	liç. A.0031/4
Ing. elektrik MIRA GOLEMI	liç. E. 0751/2
Ing. hidro. ENKELEDA DOKLE	liç. K.1075/3
Ing. ndertimi BEXHET ÇOBANI	liç. K.0383/5
Ing. mekanik FERDINANT GERMENJI	



Arkitekta DIANA MITRUSHI	liç. A.0212/4
Ing. elektrik BURHAN DEMNERI	liç. E.1049/2
Ing. mekanik GJERGJI KOTORI	liç. M.0579/1
Ing. hidro. LULJETA KUÇI	liç. K.2022/1
Ing. ndertimi ILIRIAN KOKALARI	liç. K1008/1

Kapitulli

ARKITEKTURA

Titulli i Vizatimit

Prerje 1

Shkalla

1:150

Nr. i Fletës

A.15

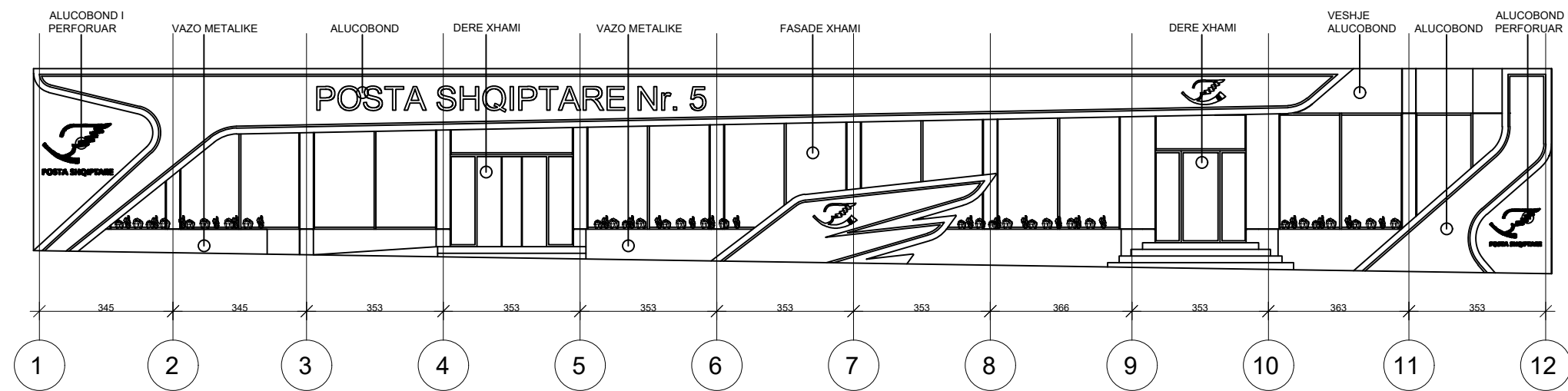

Porositës
"Posta Shqiptare sh.a."

Faza
Projekt - Zbatimi

Titulli i Projektit
"Hartimi i projekteve te zyrave postare "



PROJEKTUES:
"4K PPF "
 Licensë N.6984/1

Arkitekt FATRI PETKU	liç. A-1166/2
Arkitekt NDUE GJACI	liç. A.0031/4
Ing. elektrik MIRA GOLEMI	liç. E. 0751/2
Ing. hidro. ENKELEDA DOKLE	liç. K.1075/3
Ing. ndertimi BEXHET ÇOBANI	liç. K.0383/5
Ing. mekanik FERDINANT GERMENJI	



Arkitekta DIANA MITRUSHI	liç. A.0212/4
Ing. elektrik BURHAN DEMNERI	liç. E.1049/2
Ing. mekanik GJERGJI KOTORI	liç. M.0579/1
Ing. hidro. LULJETA KUÇI	liç. K.2022/1
Ing. ndertimi ILIRIAN KOKALARI	liç. K1008/1

Kapitulli
ARKITEKTURA

Titulli i Vizatimit
Fasada

Shkalla
1:150

Nr. i Fletës
A.16

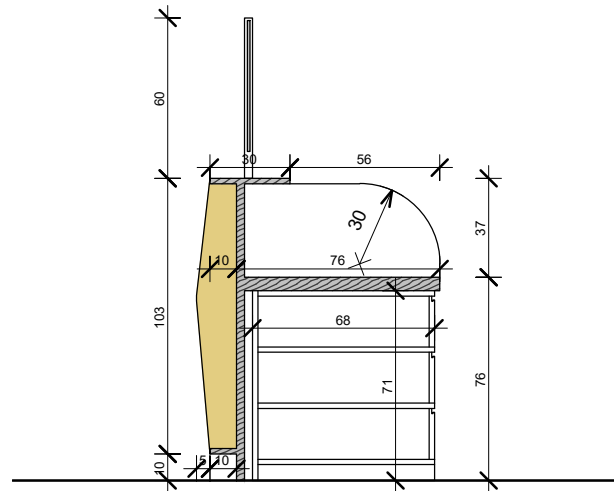

1 tavoline pune prerje
1 : 20

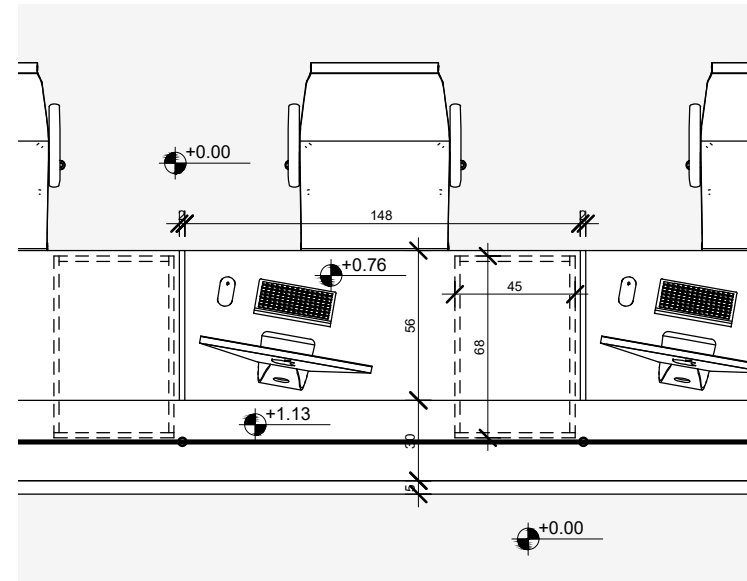

3 tavoline pune plan
1 : 20

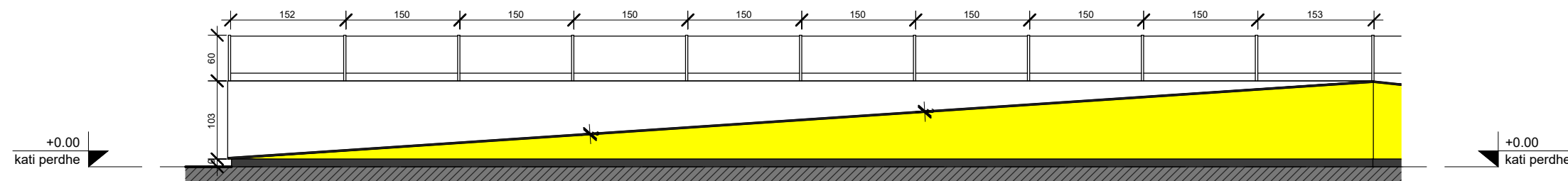

2 tavoline pune pamje ballore
1 : 50

Porositës

"Posta Shqiptare sh.a."

Faza

Projekt - Zbatimi

Titulli i Projektit

"Hartimi i projekteve te zyrave postare "



PROJEKTUES:
"4K PPF "

Licensë N.6984/1

Arkitekt FATRI PETKU	liç. A-1166/2
Arkitekt NDUE GJACI	liç. A.0031/4
Ing. elektrik MIRA GOLEMI	liç. E. 0751/2
Ing. hidro. ENKELEDA DOKLE	liç. K.1075/3
Ing. ndertimi BEXHET ÇOBANI	liç. K.0383/5
Ing. mekanik FERDINANT GERMENJI	



Arkitekthe DIANA MITRUSHI	liç. A.0212/4
Ing. elektrik BURHAN DEMNERI	liç. E.1049/2
Ing. mekanik GJERGJI KOTORI	liç. M.0579/1
Ing. hidro. LULJETA KUÇI	liç. K.2022/1
Ing. ndertimi ILIRIAN KOKALARI	liç. K1008/1

Kapitulli

ARKITEKTURA

Titulli i Vizatimit



Tavolinat e punes

Shkalla

Nr. i Fletës

A.17



Porositës	
"Posta Shqiptare sh.a."	
Faza	
Projekt - Zbatimi	
Titulli i Projektit	
"Hartimi i projekteve te zyrave postare "	
	
PROJEKTUES: "4K PPF " Licensë N.6984/1	
Arkitekt FATRI PETKU	liç. A-1166/2
Arkitekt NDUE GJACI	liç. A.0031/4
Ing. elektrik MIRA GOLEMI	liç. E. 0751/2
Ing. hidro. ENKELEDA DOKLE	liç. K.1075/3
Ing. ndertimi BEXHET ÇOBANI	liç. K.0383/5
Ing. mekanik FERDINANT GERMENJI	
 NET - GROUP	
Arkitekthe DIANA MITRUSHI	liç. A.0212/4
Ing. elektrik BURHAN DEMNERI	liç. E.1049/2
Ing. mekanik GJERGJI KOTORI	liç. M.0579/1
Ing. hidro. LULJETA KUÇI	liç. K.2022/1
Ing. ndertimi ILIRIAN KOKALARI	liç. K1008/1
Kapitulli	
ARKITEKTURA	
Titulli i Vizatimit	
Pamje 3D	
Shkalla	Nr. i Fletës
	A.18

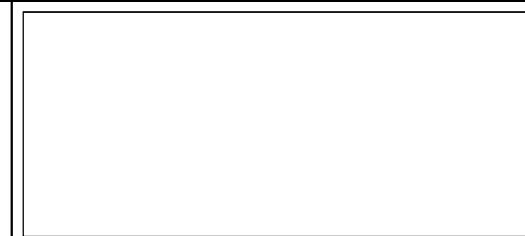
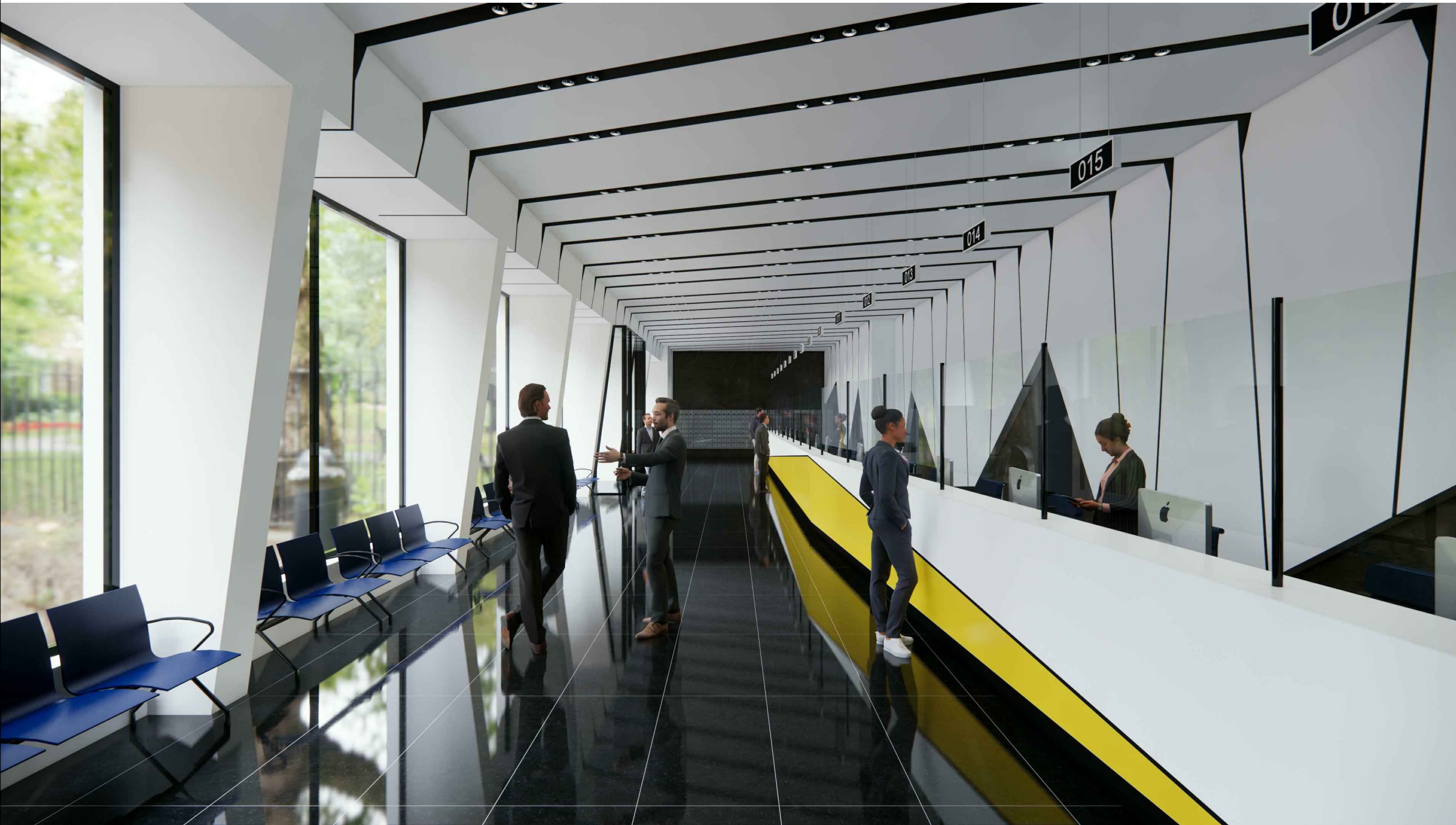

Porositës
"Posta Shqiptare sh.a."

Faza
Projekt - Zbatimi

Titulli i Projektit
"Hartimi i projekteve te zyrave postare "



4K PPF CONSULTING
 M01715004E

PROJEKTUES:
"4K PPF "
 Licensë N.6984/1

Arkitekt FATRI PETKU	liç. A-1166/2
Arkitekt NDUE GJACI	liç. A.0031/4
Ing. elektrik MIRA GOLEMI	liç. E. 0751/2
Ing. hidro. ENKELEDA DOKLE	liç. K.1075/3
Ing. ndertimi BEXHET ÇOBANI	liç. K.0383/5
Ing. mekanik FERDINANT GERMENJI	



NET - GROUP

Arkitekta DIANA MITRUSHI	liç. A.0212/4
Ing. elektrik BURHAN DEMNERI	liç. E.1049/2
Ing. mekanik GJERGJI KOTORI	liç. M.0579/1
Ing. hidro. LULJETA KUÇI	liç. K.2022/1
Ing. ndertimi ILIRIAN KOKALARI	liç. K1008/1



Kapitulli
ARKITEKTURA

Titulli i Vizatimit
Pamje 3D

Shkalla
 Nr. i Fletës
A.19





Porositës	
"Posta Shqiptare sh.a."	
Faza	
Projekt - Zbatimi	
Titulli i Projektit	
"Hartimi i projekteve te zyrave postare "	
	
PROJEKTUES: "4K PPF " Licensë N.6984/1	
Arkitekt FATRI PETKU	liç. A-1166/2
Arkitekt NDUE GJACI	liç. A.0031/4
Ing. elektrik MIRA GOLEMI	liç. E. 0751/2
Ing. hidro. ENKELEDA DOKLE	liç. K.1075/3
Ing. ndertimi BEXHET ÇOBANI	liç. K.0383/5
Ing. mekanik FERDINANT GERMENJI	
	
Arkitekta DIANA MITRUSHI	liç. A.0212/4
Ing. elektrik BURHAN DEMNERI	liç. E.1049/2
Ing. mekanik GJERGJI KOTORI	liç. M.0579/1
Ing. hidro. LULJETA KUÇI	liç. K.2022/1
Ing. ndertimi ILIRIAN KOKALARI	liç. K1008/1
Kapitulli	
ARKITEKTURA	
Titulli i Vizatimit	
Pamje 3D	
Shkalla	Nr. i Fletës
	A.20

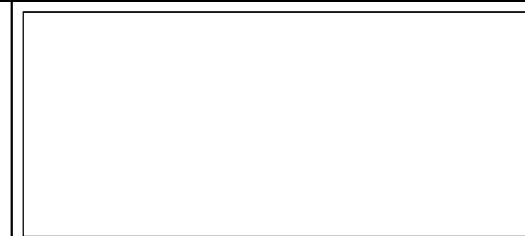

Porositës
"Posta Shqiptare sh.a."

Faza
Projekt - Zbatimi

Titulli i Projektit
"Hartimi i projekteve te zyrave postare "



PROJEKTUES:
"4K PPF "
 Licensë N.6984/1

Arkitekt FATRI PETKU	liç. A-1166/2
Arkitekt NDUE GJACI	liç. A.0031/4
Ing. elektrik MIRA GOLEMI	liç. E. 0751/2
Ing. hidro. ENKELEDA DOKLE	liç. K.1075/3
Ing. ndertimi BEXHET ÇOBANI	liç. K.0383/5
Ing. mekanik FERDINANT GERMENJI	



Arkitekta DIANA MITRUSHI	liç. A.0212/4
Ing. elektrik BURHAN DEMNERI	liç. E.1049/2
Ing. mekanik GJERGJI KOTORI	liç. M.0579/1
Ing. hidro. LULJETA KUÇI	liç. K.2022/1
Ing. ndertimi ILIRIAN KOKALARI	liç. K1008/1

Kapitulli
ARKITEKTURA

Titulli i Vizatimit
Pamje 3D

Shkalla
 Nr. i Fletës
A.21

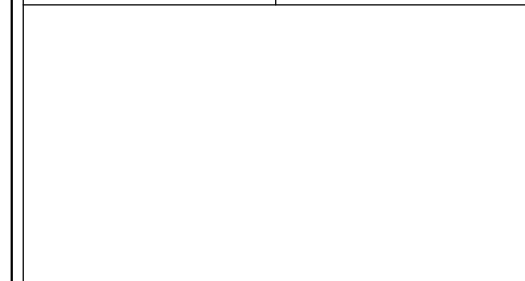



Porositës

"Posta Shqiptare sh.a."

Faza

Projekt - Zbatimi

Titulli i Projektit

"Hartimi i projekteve te zyrave postare "



PROJEKTUES:
"4K PPF "
Licensë N.6984/1

Arkitekt FATRI PETKU	liç. A-1166/2
Arkitekt NDUE GJACI	liç. A.0031/4
Ing. elektrik MIRA GOLEMI	liç. E. 0751/2
Ing. hidro. ENKELEDA DOKLE	liç. K.1075/3
Ing. ndertimi BEXHET ÇOBANI	liç. K.0383/5
Ing. mekanik FERDINANT GERMENJI	



Arkitekthe DIANA MITRUSHI	liç. A.0212/4
Ing. elektrik BURHAN DEMNERI	liç. E.1049/2
Ing. mekanik GJERGJI KOTORI	liç. M.0579/1
Ing. hidro. LULJETA KUÇI	liç. K.2022/1
Ing. ndertimi ILIRIAN KOKALARI	liç. K1008/1

Kapitulli

ARKITEKTURA

Titulli i Vizatimit

Pamje 3D

Shkalla

Nr. i Fletës

A.22



Porositës

"Posta Shqiptare sh.a."

Faza

Projekt - Zbatimi

Titulli i Projektit

"Hartimi i projekteve te zyrave postare "



PROJEKTUES:
"4K PPF "
Licensë N.6984/1

Arkitekt FATRI PETKU	liç. A-1166/2
Arkitekt NDUE GJACI	liç. A.0031/4
Ing. elektrik MIRA GOLEMI	liç. E. 0751/2
Ing. hidro. ENKELEDA DOKLE	liç. K.1075/3
Ing. ndertimi BEXHET ÇOBANI	liç. K.0383/5
Ing. mekanik FERDINANT GERMENJI	



Arkitekta DIANA MITRUSHI	liç. A.0212/4
Ing. elektrik BURHAN DEMNERI	liç. E.1049/2
Ing. mekanik GJERGJI KOTORI	liç. M.0579/1
Ing. hidro. LULJETA KUÇI	liç. K.2022/1
Ing. ndertimi ILIRIAN KOKALARI	liç. K1008/1

Kapitulli

ARKITEKTURA

Titulli i Vizatimit

Pamje 3D

Shkalla

Nr. i Fletës

A.23



Porositës
"Posta Shqiptare sh.a."

Faza
Projekt - Zbatimi

Titulli i Projektit
"Hartimi i projekteve te zyrave postare "



PROJEKTUES:
"4K PPF "
Licensë N.6984/1

Arkitekt FATRI PETKU	liç. A-1166/2
Arkitekt NDUE GJACI	liç. A.0031/4
Ing. elektrik MIRA GOLEMI	liç. E. 0751/2
Ing. hidro. ENKELEDA DOKLE	liç. K.1075/3
Ing. ndertimi BEXHET ÇOBANI	liç. K.0383/5
Ing. mekanik FERDINANT GERMENJI	





Arkitekthe DIANA MITRUSHI	liç. A.0212/4
Ing. elektrik BURHAN DEMNERI	liç. E.1049/2
Ing. mekanik GJERGJI KOTORI	liç. M.0579/1
Ing. hidro. LULJETA KUÇI	liç. K.2022/1
Ing. ndertimi ILIRIAN KOKALARI	liç. K1008/1

Kapitulli
ARKITEKTURA

Titulli i Vizatimit
Pamje 3D

Shkalla	Nr. i Fletës A.24
---------	-----------------------------



Porositës	
"Posta Shqiptare sh.a."	
Faza	
Projekt - Zbatimi	
Titulli i Projektit	
"Hartimi i projekteve te zyrave postare "	
	
PROJEKTUES: "4K PPF " Licensë N.6984/1	
Arkitekt FATRI PETKU	liç. A-1166/2
Arkitekt NDUE GJACI	liç. A.0031/4
Ing. elektrik MIRA GOLEMI	liç. E. 0751/2
Ing. hidro. ENKELEDA DOKLE	liç. K.1075/3
Ing. ndertimi BEXHET ÇOBANI	liç. K.0383/5
Ing. mekanik FERDINANT GERMENJI	
	
Arkitekthe DIANA MITRUSHI	liç. A.0212/4
Ing. elektrik BURHAN DEMNERI	liç. E.1049/2
Ing. mekanik GJERGJI KOTORI	liç. M.0579/1
Ing. hidro. LULJETA KUÇI	liç. K.2022/1
Ing. ndertimi ILIRIAN KOKALARI	liç. K1008/1
Kapitulli	
ARKITEKTURA	
Titulli i Vizatimit	
Pamje 3D	
Shkalla	Nr. i Fletës
	A.25

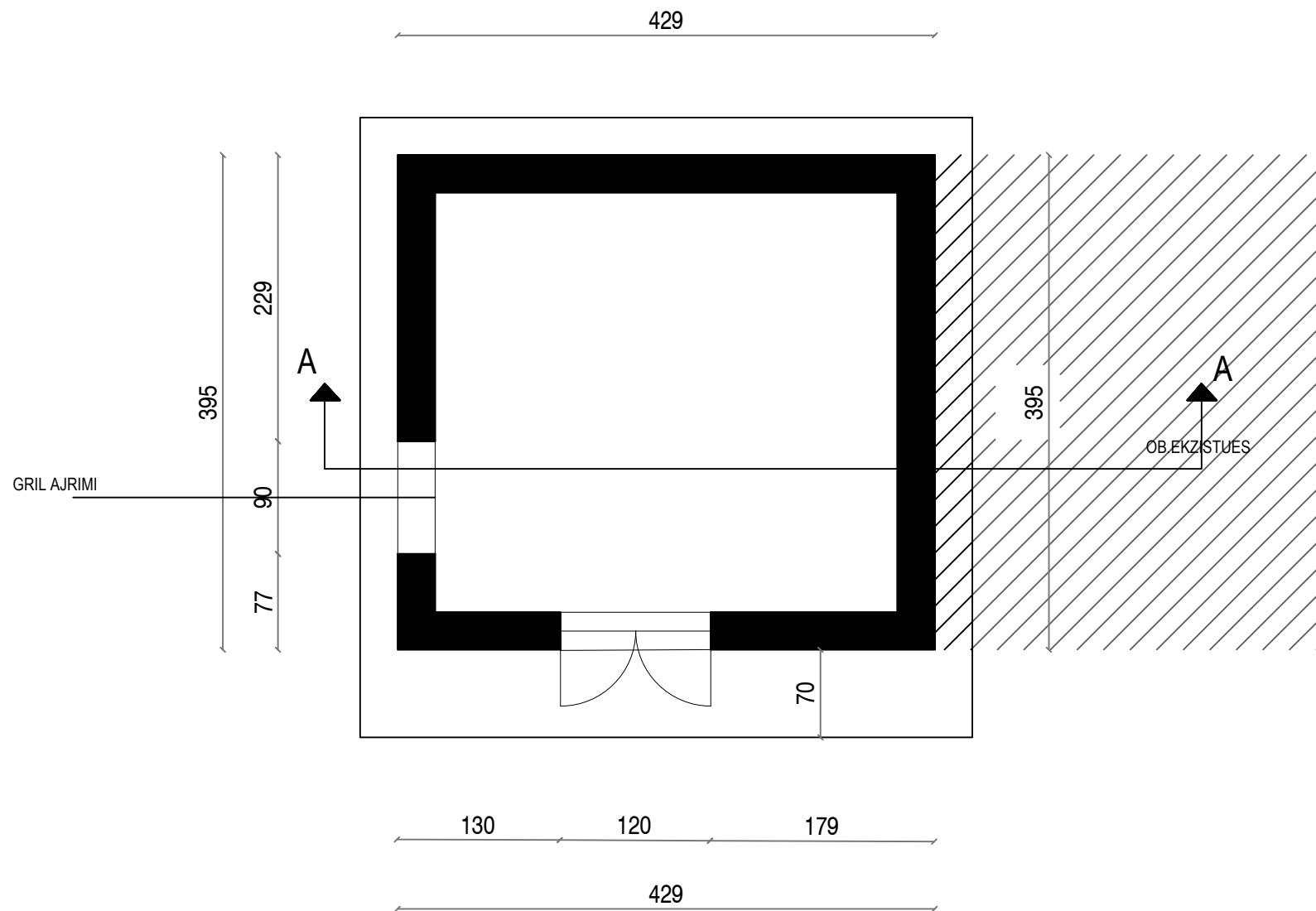

Porositës

"Posta Shqiptare sh.a."

Faza

Projekt - Zbatimi

Titulli i Projektit

"Hartimi i projekteve te zyrave postare "



PROJEKTUES:
"4K PPF "
Licensë N.6984/1

Arkitekt FATRI PETKU	liç. A-1166/2
Arkitekt NDUE GJACI	liç. A.0031/4
Ing. elektrik MIRA GOLEMI	liç. E. 0751/2
Ing. hidro. ENKELEDA DOKLE	liç. K.1075/3
Ing. ndertimi BEXHET ÇOBANI	liç. K.0383/5
Ing. mekanik FERDINANT GERMENJI	



Arkitekta DIANA MITRUSHI	liç. A.0212/4
Ing. elektrik BURHAN DEMNERI	liç. E.1049/2
Ing. mekanik GJERGJI KOTORI	liç. M.0579/1
Ing. hidro. LULJETA KUÇI	liç. K.2022/1
Ing. ndertimi ILIRIAN KOKALARI	liç. K1008/1

Kapitulli

ARKITEKTURA

Titulli i Vizatimit

Planimetria e gabines elektrike

Shkalla

1:50

Nr. i Fletës

A.26

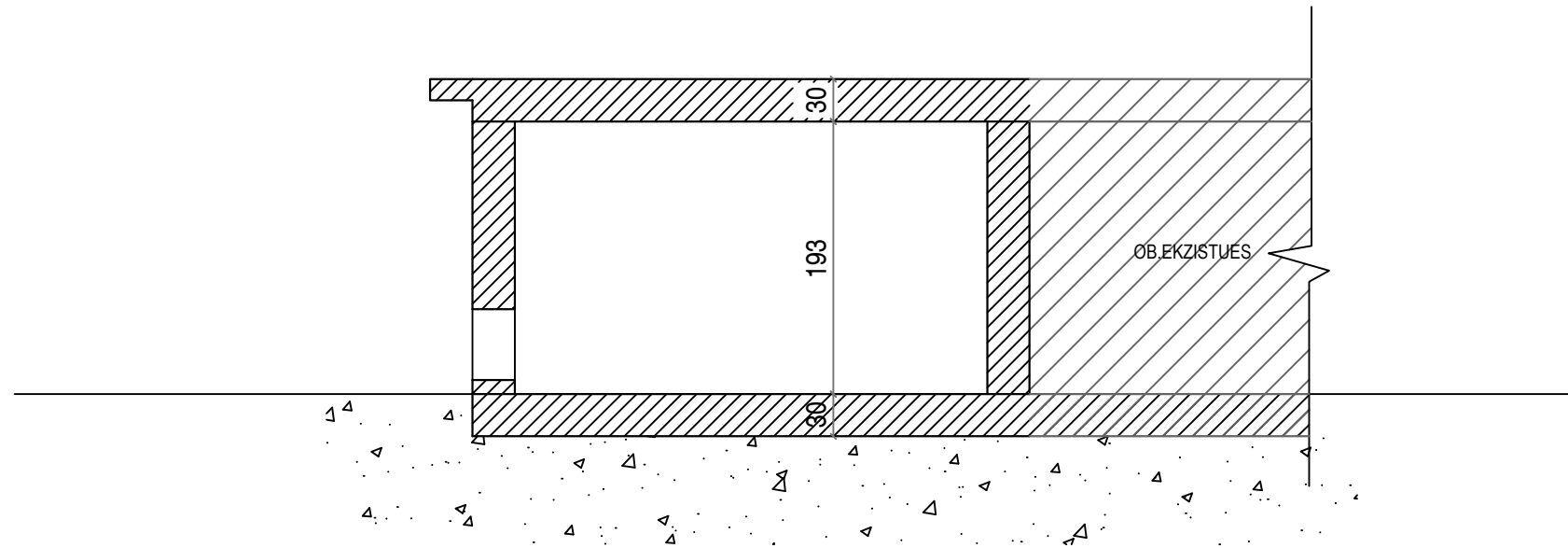

Porositës

"Posta Shqiptare sh.a."

Faza

Projekt - Zbatimi

Titulli i Projektit

"Hartimi i projekteve te zyrave postare "



PROJEKTUES:
"4K PPF "
Licensë N.6984/1

Arkitekt FATRI PETKU	liç. A-1166/2
Arkitekt NDUE GJACI	liç. A.0031/4
Ing. elektrik MIRA GOLEMI	liç. E. 0751/2
Ing. hidro. ENKELEDA DOKLE	liç. K.1075/3
Ing. ndertimi BEXHET ÇOBANI	liç. K.0383/5
Ing. mekanik FERDINANT GERMENJI	



Arkitekthe DIANA MITRUSHI	liç. A.0212/4
Ing. elektrik BURHAN DEMNERI	liç. E.1049/2
Ing. mekanik GJERGJI KOTORI	liç. M.0579/1
Ing. hidro. LULJETA KUÇI	liç. K.2022/1
Ing. ndertimi ILIRIAN KOKALARI	liç. K1008/1

Kapitulli

ARKITEKTURA

Titulli i Vizatimit

Prerja A-A

Shkalla

1:50

Nr. i Fletës

A.27

FASADA

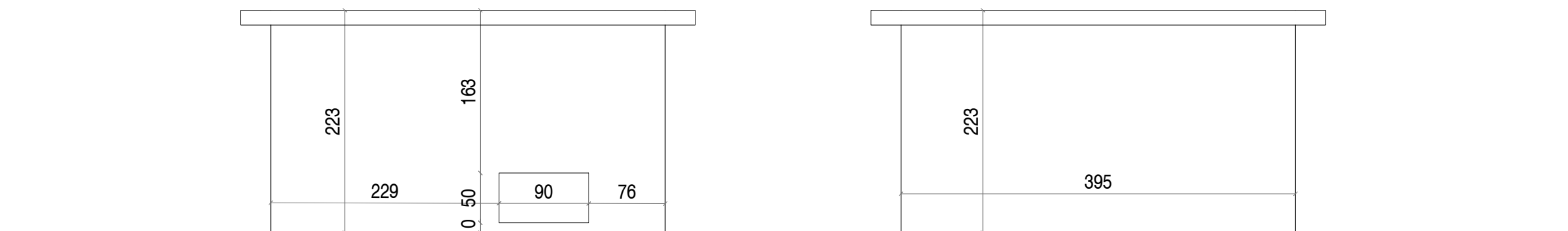
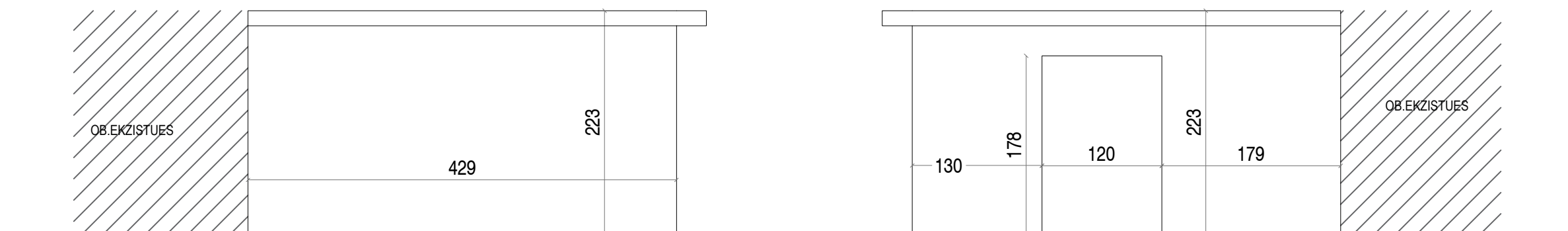

Porositës
"Posta Shqiptare sh.a."

Faza
Projekt - Zbatimi

Titulli i Projektit
"Hartimi i projekteve te zyrave postare "



PROJEKTUES:
"4K PPF "
Licensë N.6984/1

Arkitekt FATRI PETKU	liç. A-1166/2
Arkitekt NDUE GJACI	liç. A.0031/4
Ing. elektrik MIRA GOLEMI	liç. E. 0751/2
Ing. hidro. ENKELEDA DOKLE	liç. K.1075/3
Ing. ndertimi BEXHET ÇOBANI	liç. K.0383/5
Ing. mekanik FERDINANT GERMENJI	



Arkitekthe DIANA MITRUSHI	liç. A.0212/4
Ing. elektrik BURHAN DEMNERI	liç. E.1049/2
Ing. mekanik GJERGJI KOTORI	liç. M.0579/1
Ing. hidro. LULJETA KUÇI	liç. K.2022/1
Ing. ndertimi ILIRIAN KOKALARI	liç. K1008/1

Kapitulli
ARKITEKTURA

Titulli i Vizatimit
Fasada

Shkalla
1:50

Nr. i Fletës
A.28

RELACION ARKITEKTONIK

HARTIMI I PROJEKTEVE TE ZYRAVE POSTARE FILIALI NR.5 TIRANË



Projektues:



Porosites: Posta Shqiptare sh.a

OBJEKTI: ZYRAT E POSTES SHQIPTARE Nr.5

Posta Shqiptare Nr.5 kryen aktivitetin e saj ne katin perdhe te nje objekti banimi ne rrugen "Cameria". Ne kuader te vjetersise se ambienteve te brendshme dhe njekohesisht te realizimit te nje sherbimi bashkekohor, kjo dege e Postes Shqiptare do te realizoje disa punime te brendshme dhe te jashtme.

Bashkengjitur gjejme disa foto dhe planimetri te gjendjes ekzistuese, projektin e propozuar, duke bere nje pershkrim te punimeve qe do te kryhen dhe elementeve qe nuk do te preken sipas rastit.



Pamje ekzistuese e fasades se postes

Duke marre parasysh amortizimin e fasades ekzistuese te postes propozohet ndryshimi i saj. Fasada e re do te perbehet nga ngjyra me neutrale, si grija e erret, ne menyre qe te pershtatet me mire me ambjetin rrethues. Gjithashtu do te theksohen dy hyrjet per ne poste, te cilat nuk jane shume evidente ne fasaden ekzistuese.

Hapjet e jashtme nuk do te ndryshojne por ato do te zevendesohen me vetrata te nje cilesie me te mire persa i perket eficences termike dhe sigurise ne objekt.

Foto eksterier – Gjendja ekzistuese



Foto interior – Gjendja ekzistuese







Planet ekzistuese

Kati perdhe:

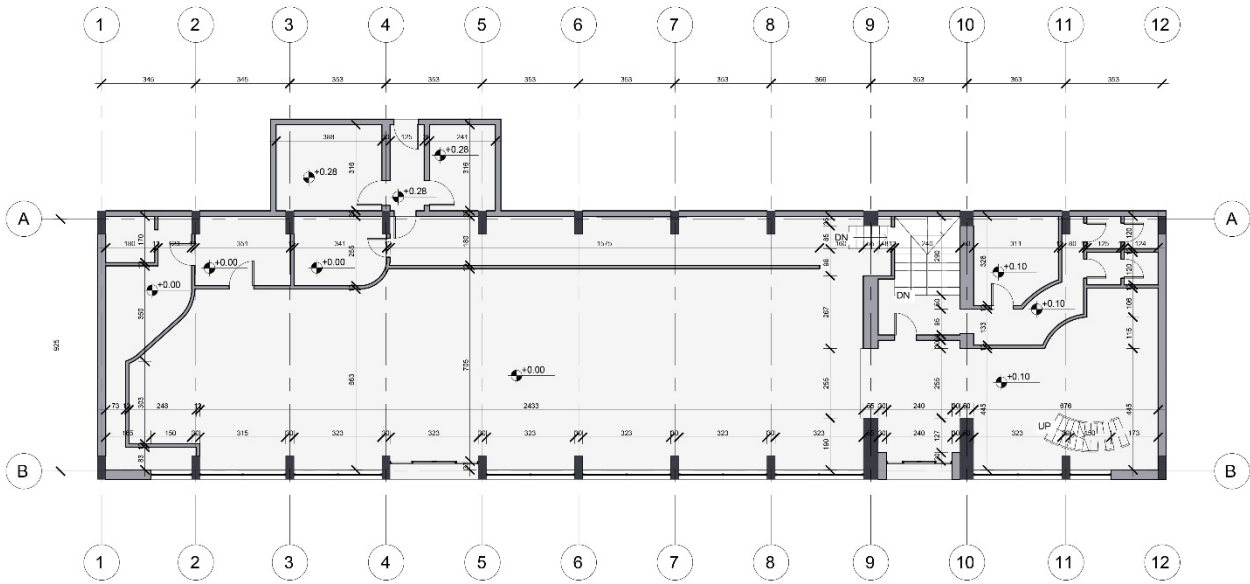

Kati 1:

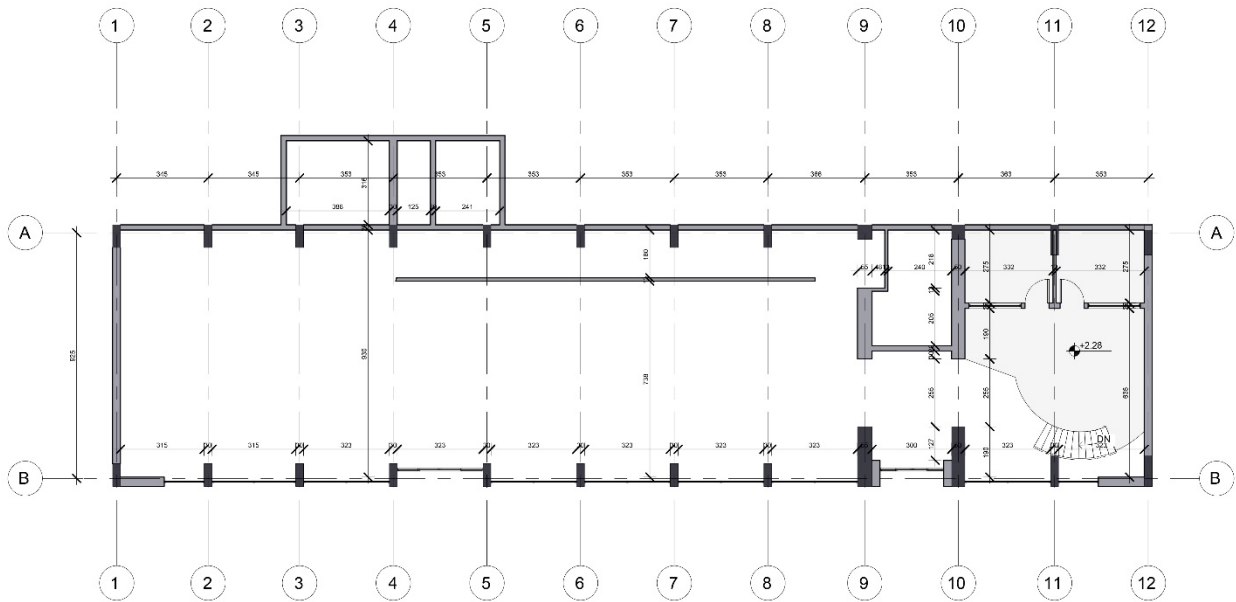

Kati nentoke:

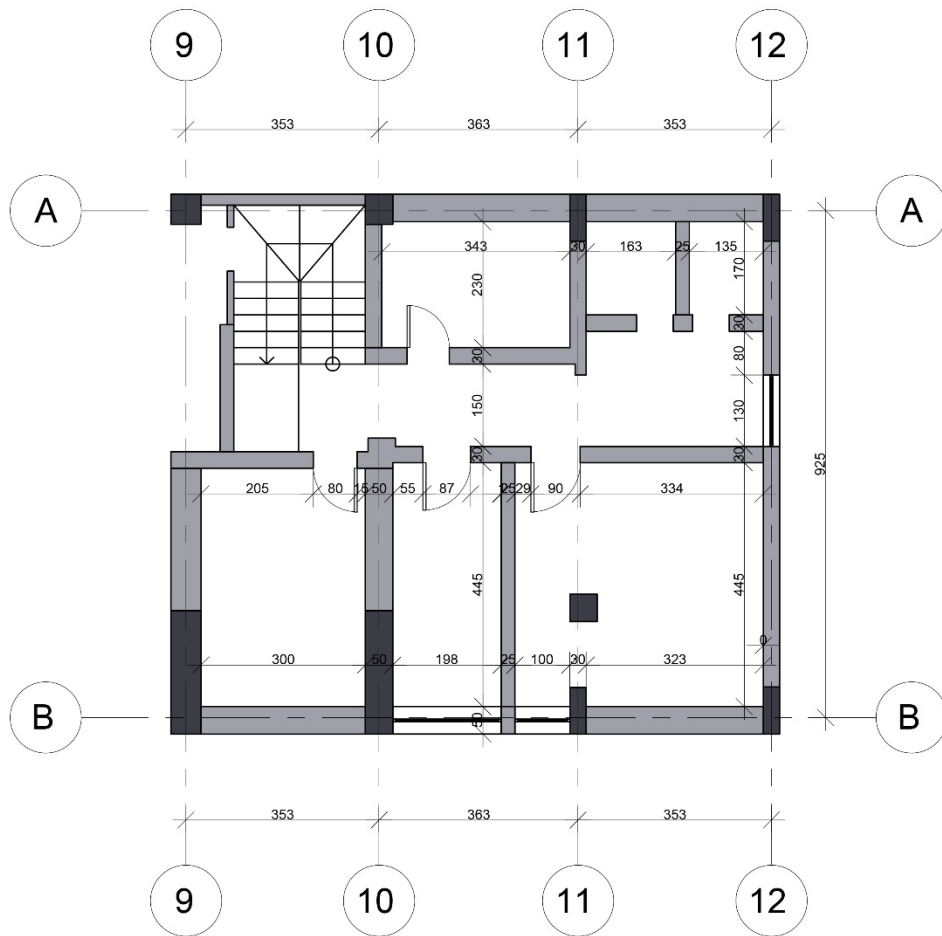

Nga verifikimet ne terren jane kryer matjet e gjendjes ekzistuese dhe evidentimi i ambienteve. Sikunder shihet ne planimetrite e mesiper, kemi te bejme me nje objekt te trajtuar me systemin tra-kollone. Elementet konstruktiv te objektit nuk do te preken. Ato do te lihen ashtu si jane ne gjendjen ekzistuese.

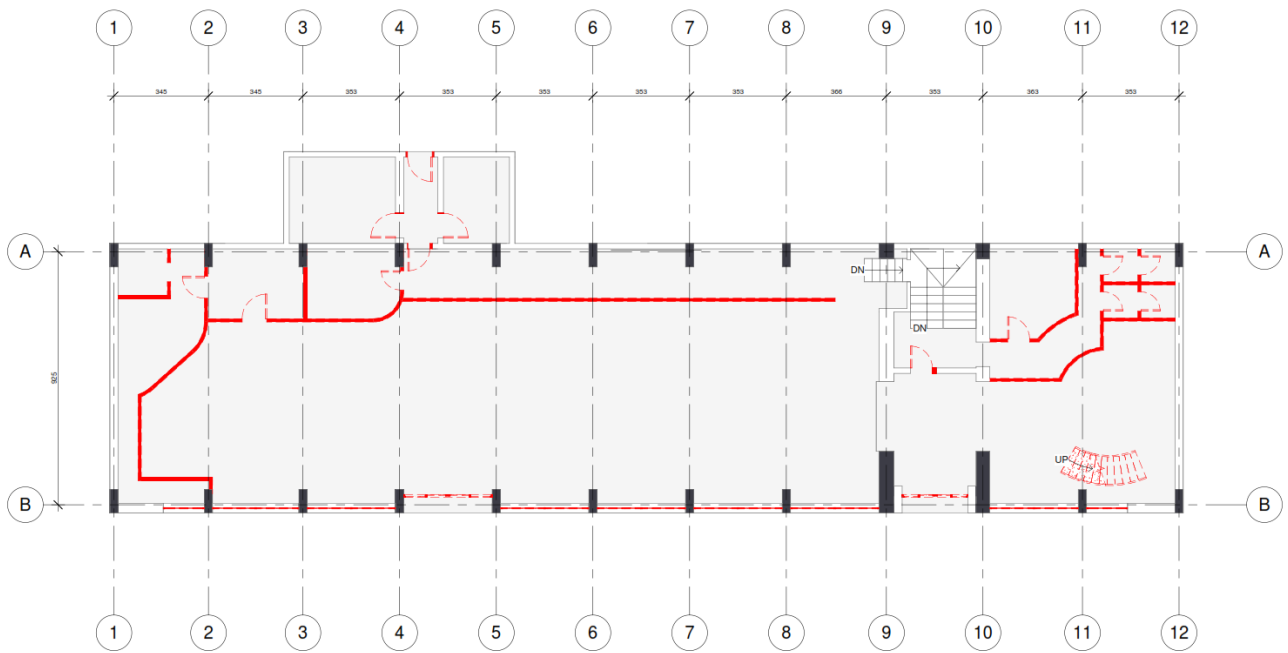

Plani i prishjeve ne katin perdhe

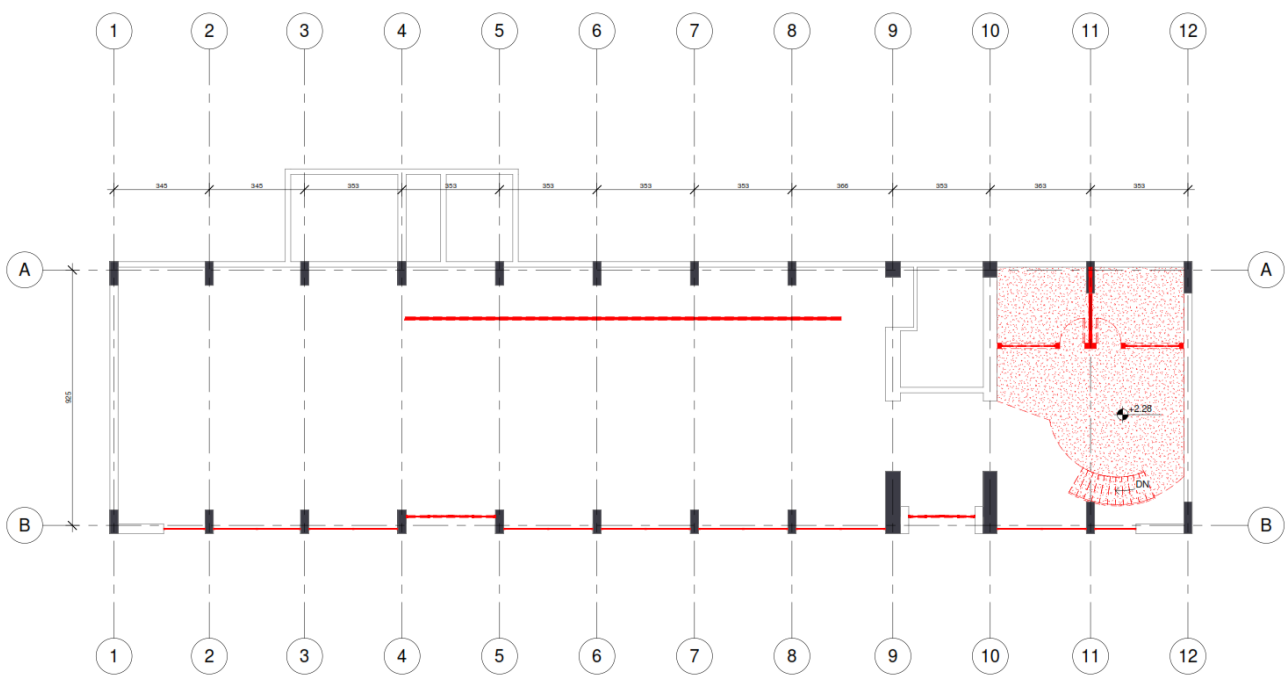

Plani i prishjeve ne nderkat

Ne planimetrit e mesiperme evidentohen prishjet e mureve ndares, jo mbajtes, te ambienteve te cilet do te prishen. Keto mure jane kryesisht ndarje me gips ose me tulle te lehtesuar. Fasadat e prishura do te zevendesohen nga vetrata te reja te nje eficence termike dhe sigurie me te larte. Gjithashtu do te prishet edhe struktura e nderkatit dhe shkallet qe te cojne atje, per tu zevendesuar nga nje struktura e re e cila ploteson kerkesat e ambienteve. Prishja e kesaj struktura te pavarur nuk cenon integritetin e struktures origjinale te objektit.

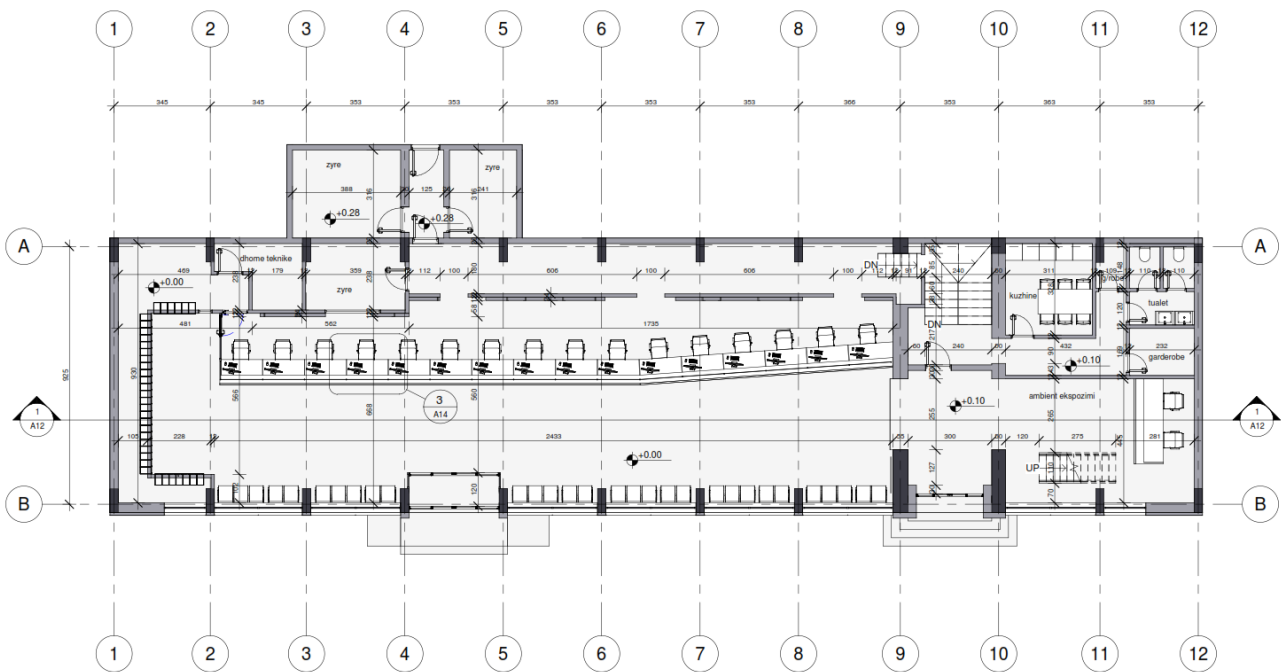

Planimetria e katit perdhe

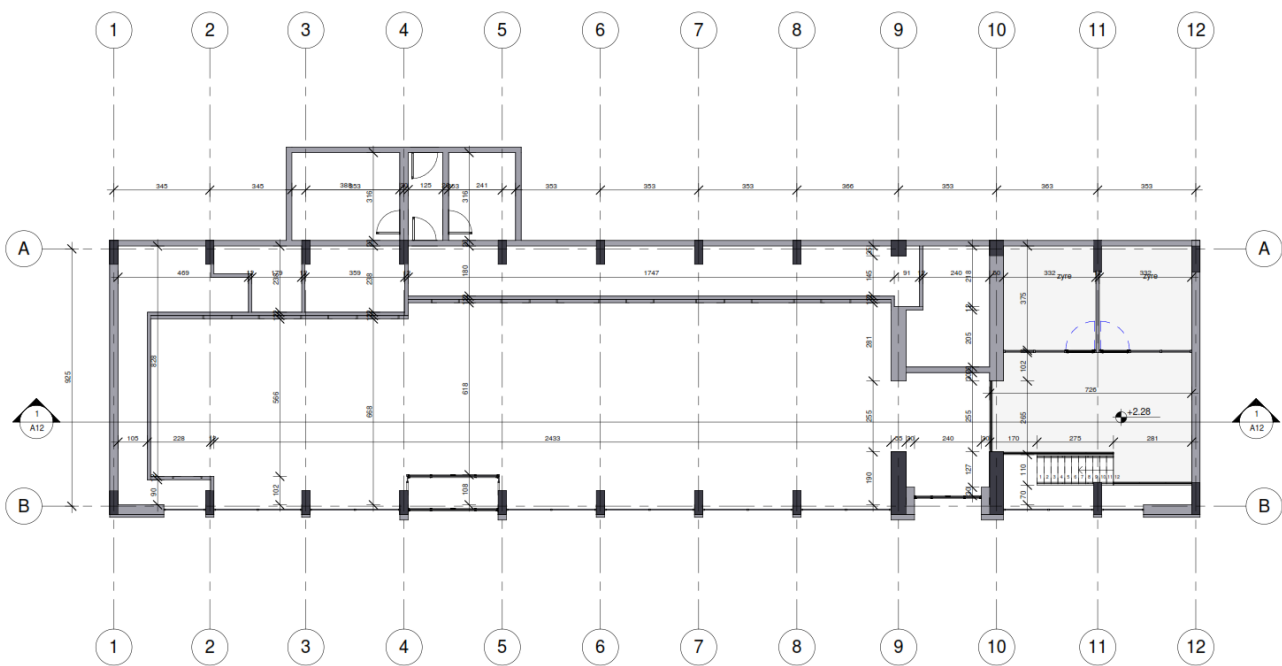

Planimetria e nderkatit

Ne planimetrit e mesiperme evidentohen ndarjet e propozuara te hapësirave. Nga ana funksionale eshte konceptuar unifikimi i nje hapësire per sherbimet ndaj klientit. Gjithashtu eshte treguar kujdes per krijimin e hapësirave me funksionale per stafin e postes ne te dy katet.

Ne realizimin e interierit do perdoren rifiniturat si me poshte: Pllaka per shtrim dyshemeje 60cm x 120cm, 60cm x 60cm; pllaka per veshje 100cm x 300cm, boje plastike mbi patinim. Fasada e jashtme do te jete sistem me panele alumini kompozite (albond).

MOMENTE INTERIERI





Projekti i paraqitur realizon me se miri kerkesat e reja te kesaj dege lidhur me krijimin e ambienteve per stafin dhe klientet, elementet e sigurise etj.

Pamje 3D



