

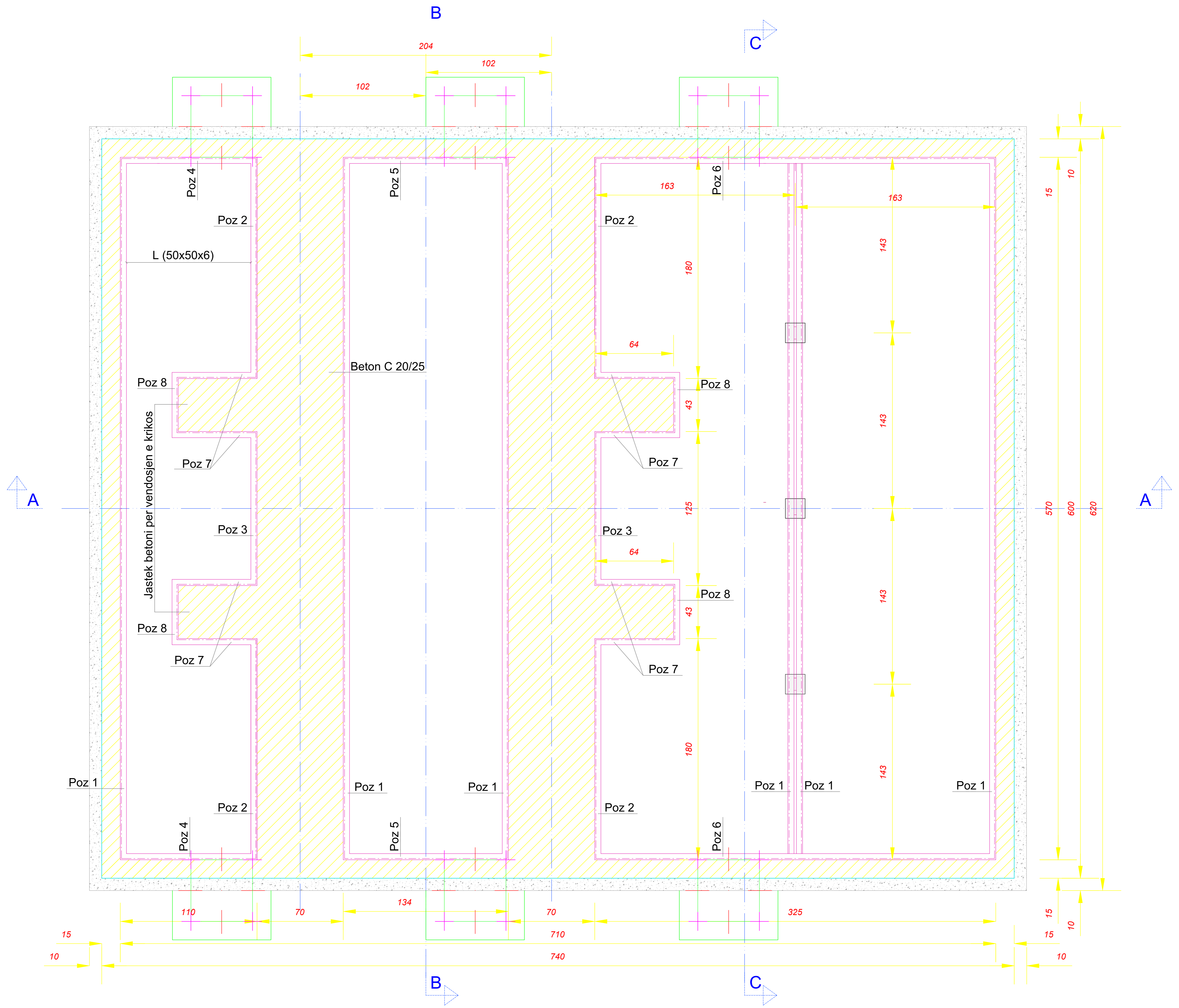

# BAZAMENTET E TRANSFORMORËVE TË FUQISË, N.STACIONI 110/35/20/10/6kV KUÇOVË.



Përshkrimi i punimeve	Njësia	Sasia
Gërmim dheu	m <sup>3</sup>	72
Shtresë zhavorri	m <sup>3</sup>	5.7
Shtresë beton C 12/15	m <sup>3</sup>	5.7
Beton bazamenti C/25/30	m <sup>3</sup>	37

Specifikimi i materialeve	
Beton	
Bazamentet	C 20 / 25
Kanalet e kabllit	C 16 / 20
Beton i varfër	C 12 / 15
Shtresa mbrojtëse	5 cm
Armatura e hekurit	
Hekur periodik	B 500 C

 <b>DREJTORIA E TENSIONIT TË LARTË</b>	DREJTORI		
	SHEF DEGA TEKNIKE		
Emërtimi objektit	SHEF ZYRA PROJEKTIT		
	PROJEKTOI		
	PROJEKTOI		
	PROJEKTOI		
Emërtimi fletës	PERPUNOI		
	FAZA: PROJEKT ZBATIMI		
	SHKALLA	Dt.	2023
	DIN A3		
Porositës:	NR. PROJEKTIT		
	FLETA VIZATIMIT		

**DTL**

**BAZAMENTET E TRANSFORMATORËVE TË FUQISË, N.STACIONI 110/35/20/10/6kV KUÇOVË.**

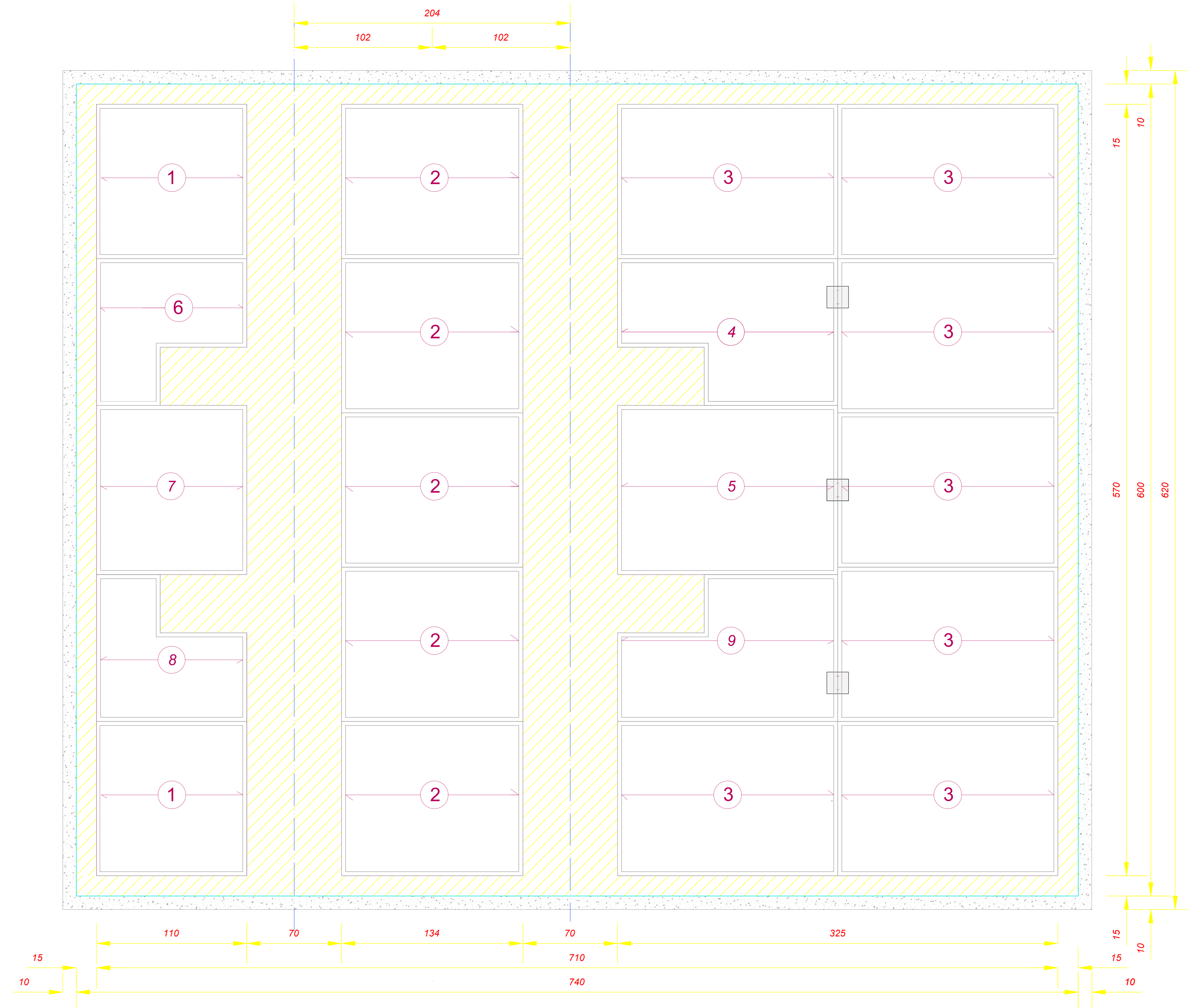

 <p><b>DREJTORIA E TENSIONIT TË LARTË</b></p>	DREJTORI		
	SHEF DEGA TEKNIKE		
Emërtimi objektit <b>RIKONSTRUKSIONI &amp; FUQIZIMI I N.STACIONIT 110/35/20/10/6kV, KUÇOVË.</b>	SHEF ZYRA PROJEKTIT		
	PROJEKTOI		
	PROJEKTOI		
	PROJEKTOI		
	PROJEKTOI		
Emërtimi fletës Bazamenti i transformatorit të fuqisë, plani i vendosjes zgavrave.	PERPUNOI		
	FAZA: PROJEKT ZBATIMI		
Porositës: <b>DTL</b>	SHKALLA	Dt.	2023
	NR. PROJEKTIT		DIN A3
	FLETA VIZATIMIT		

**BAZAMENTET E TRANSFORMORËVE TË FUQISË, N.STACIONI 110/35/20/10/6kV KUÇOVË.**

**Prerja A - A**

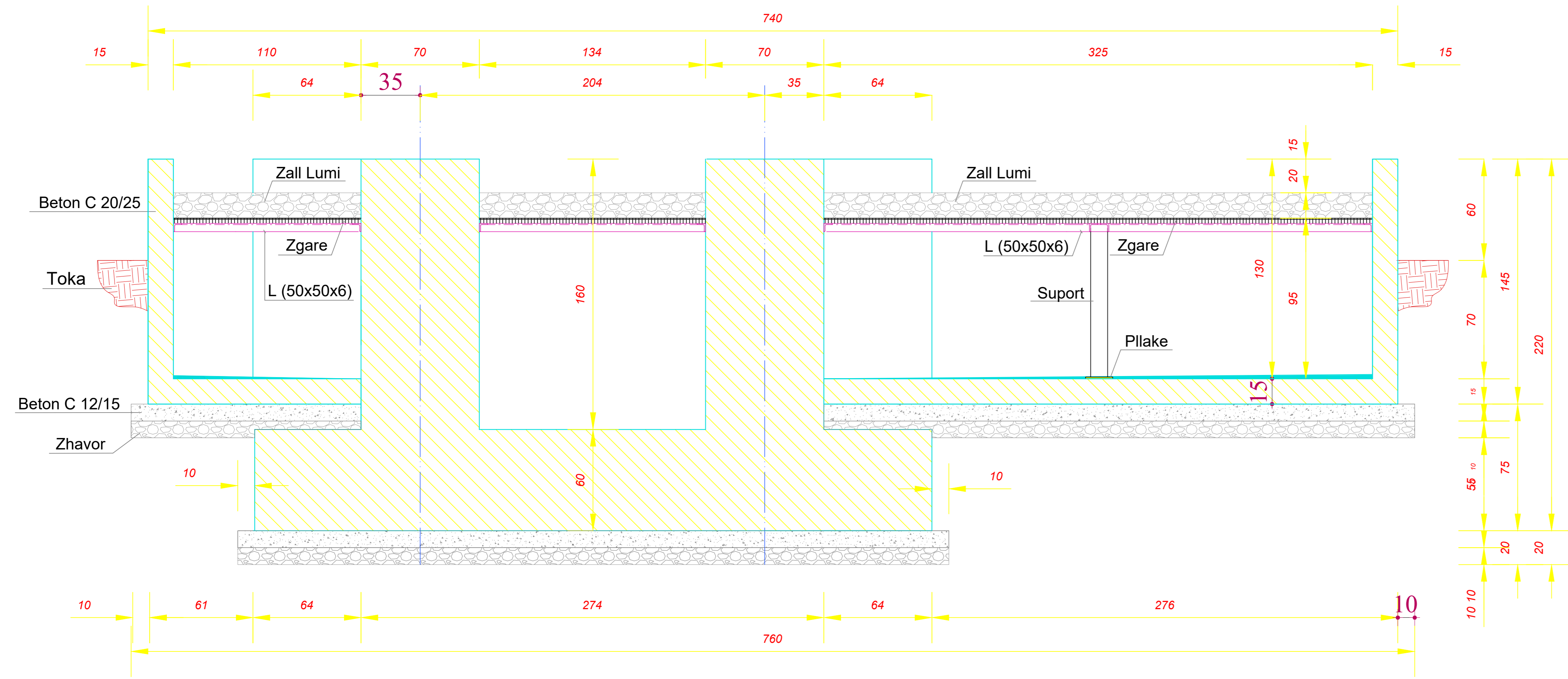

**Prerja C - C**

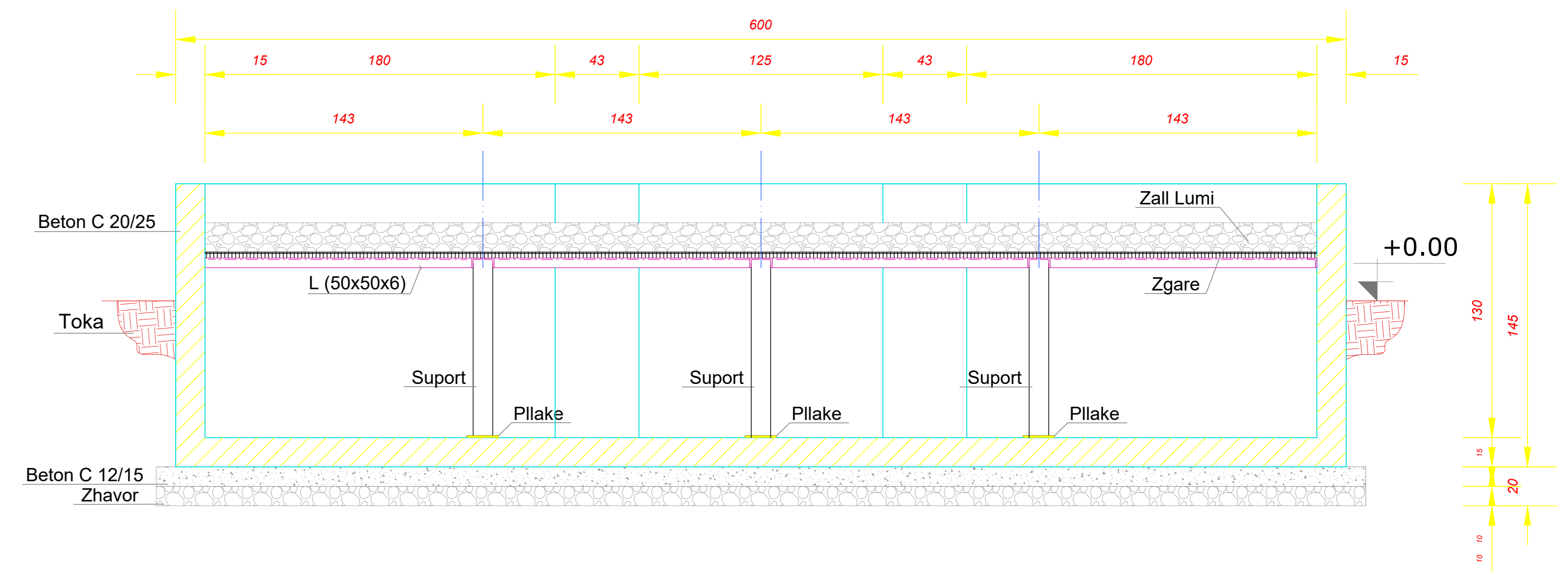

**Prerja B - B**

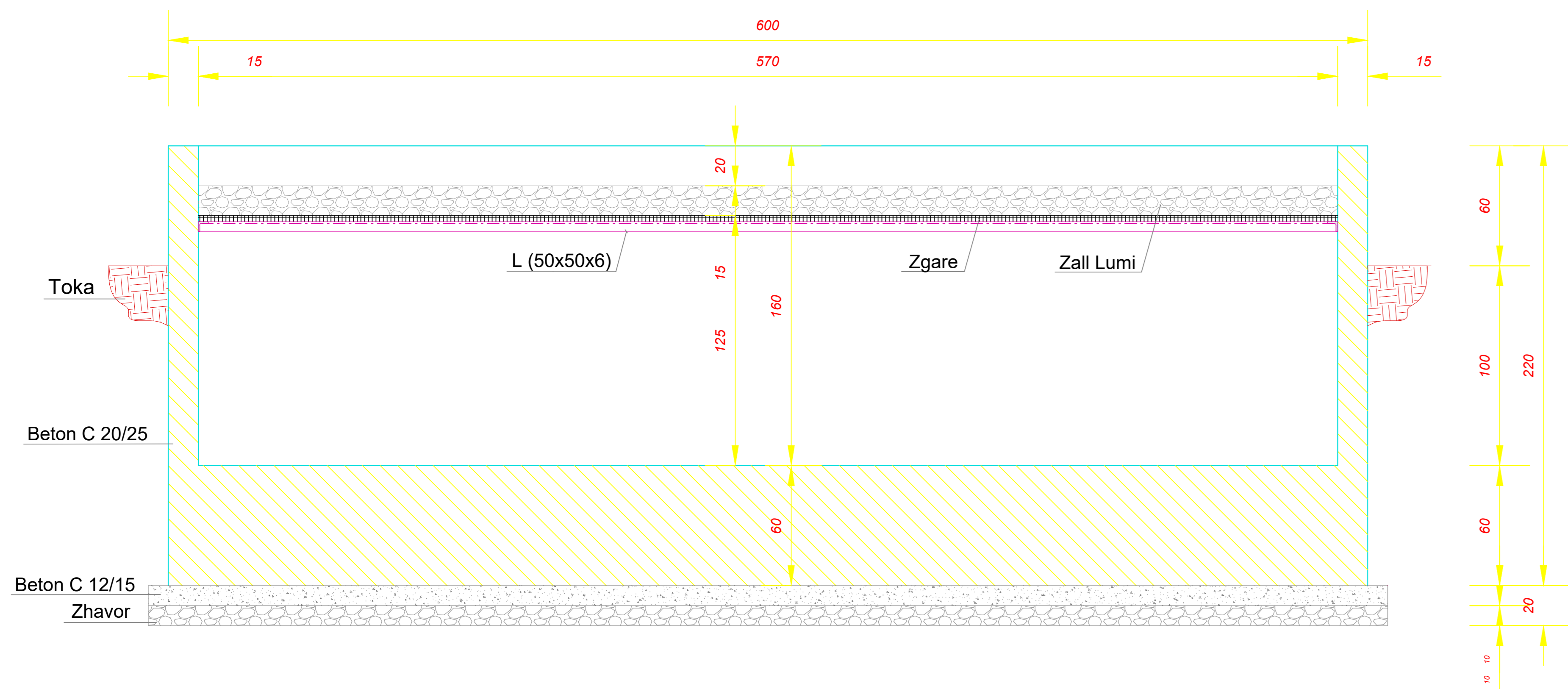

**Përshkrimi për armaturën e bazamentit të transformatorit.**

Nr.	D.	L (cm)	cope	L (m)	Pesha /njesi	Pesha /cope	Total/ kg
1	14	480	29	4.8	1.21	5.81	168.4
2	14	682	14	6.82	1.21	8.25	115.5
3	14	480	29	4.8	1.21	5.81	168.4
4	14	678	14	6.78	1.21	8.20	114.9
5	14	320	116	3.2	1.21	3.87	449.2
6	14	590	28	5.9	0.62	3.66	102.4
7	14	590	10	5.9	1.21	7.14	71.4
8	10	222	52	2.22	0.62	1.38	71.6
9	10	300	8	3	0.62	1.86	14.9
10	10	300	110	3	0.62	1.86	204.6
11	10	2625	14	26.25	0.62	16.28	227.9
12	10	416	58	4.16	0.62	2.58	149.6
13	10	200	58	2	0.62	1.24	71.9
14	10	590	48	5.9	0.62	3.66	175.6
15	10	340	32	3.4	0.62	2.11	67.5
16	10	250	44	2.5	0.62	1.6	68.2
SHUMA							2241.9
Konstrukcioni i zgarave i zinkuar							690

<p align="center"><b>DREJTORIA E TENSIONIT TË LARTË</b></p>	DREJTORI			
	SHEF DEGA TEKNIKE			
Emërtimi objektit <p align="center"><b>RIKONSTRUKSIONI &amp; FUQIZIMI I N.STACIONIT 110/35/20/10/6kV, KUÇOVË.</b></p>	SHEF ZYRA PROJEKTIT			
	PROJEKTOI			
	PROJEKTOI			
	PROJEKTOI			
Emërtimi fletës Bazamenti i transformatorit të fuqisë, plani i vendosjes zgavrave.	PROJEKTOI			
	PERPUNOI			
	FAZA: PROJEKT ZBATIMI			
Porositës: <p align="center"><b>DTL</b></p>	SHKALLA	Dt.	2023	DIN A3
	NR. PROJEKTIT			
	FLETA VIZATIMIT			

**BAZAMENTET E TRANSFORMATORËVE TË FUQISË, N.STACIONI 110/35/20/10/6kV KUÇOVË.**

**Zgarë Tipi 1**

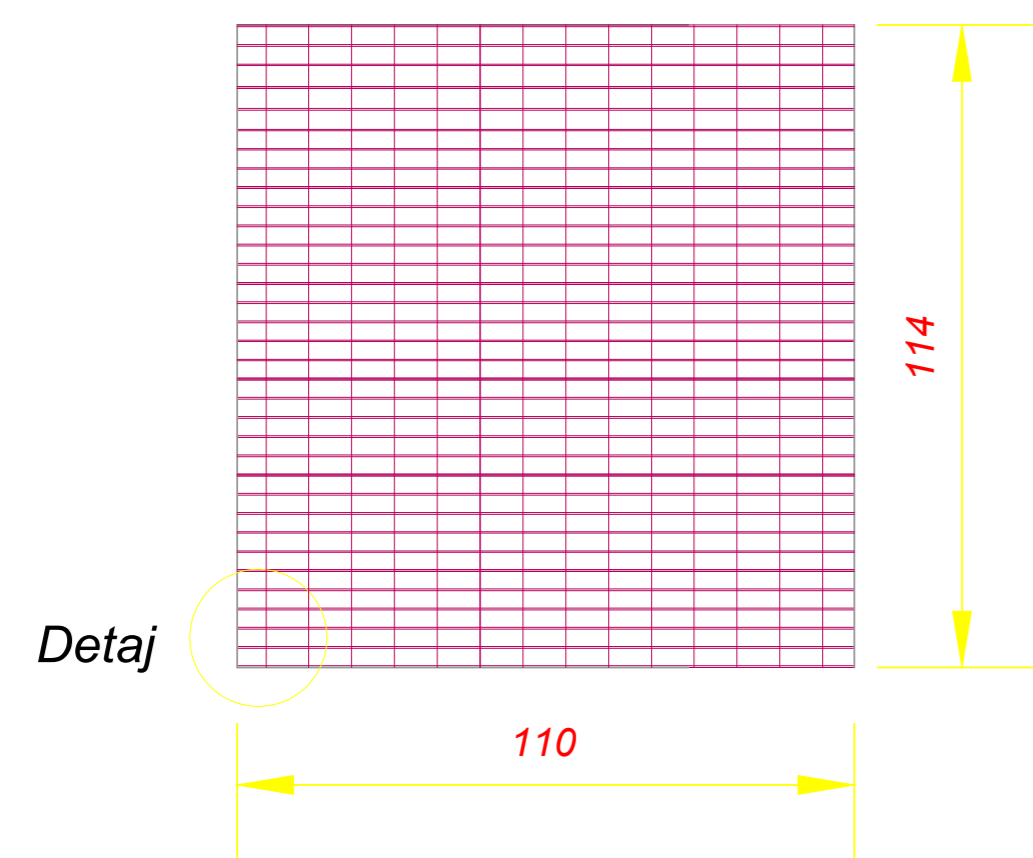

**Zgarë Tipi 2**

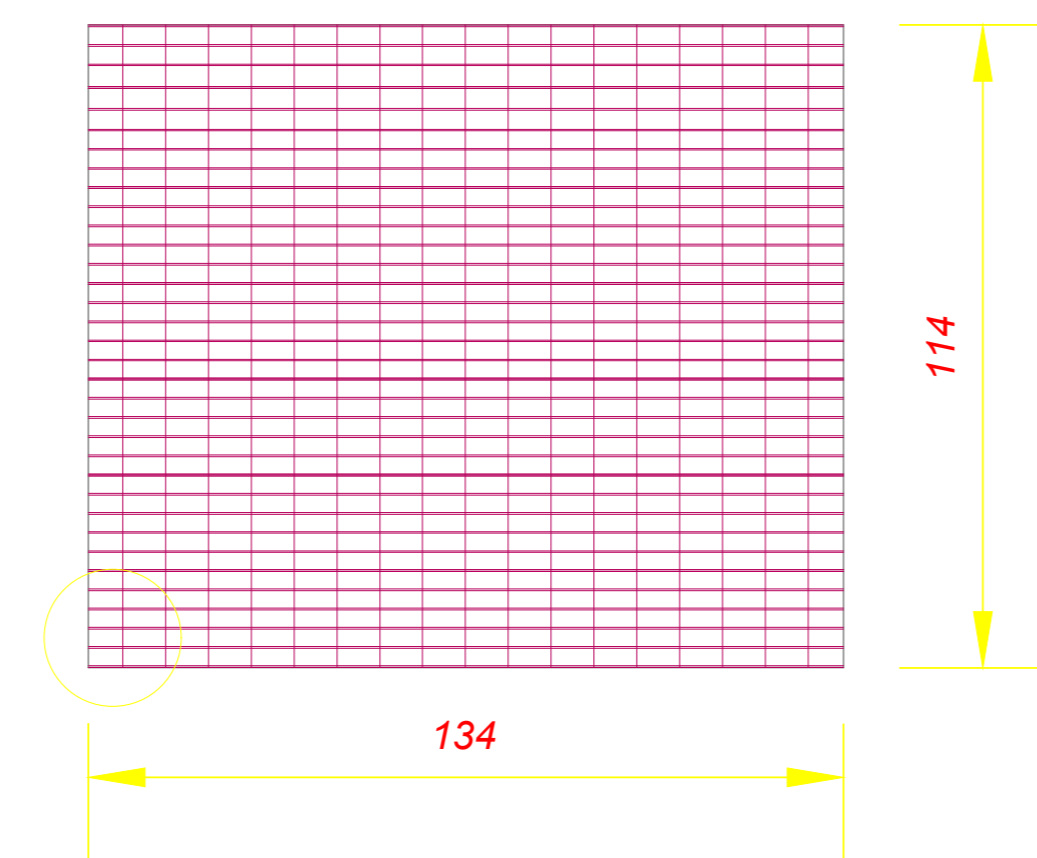

**Zgarë Tipi 3**

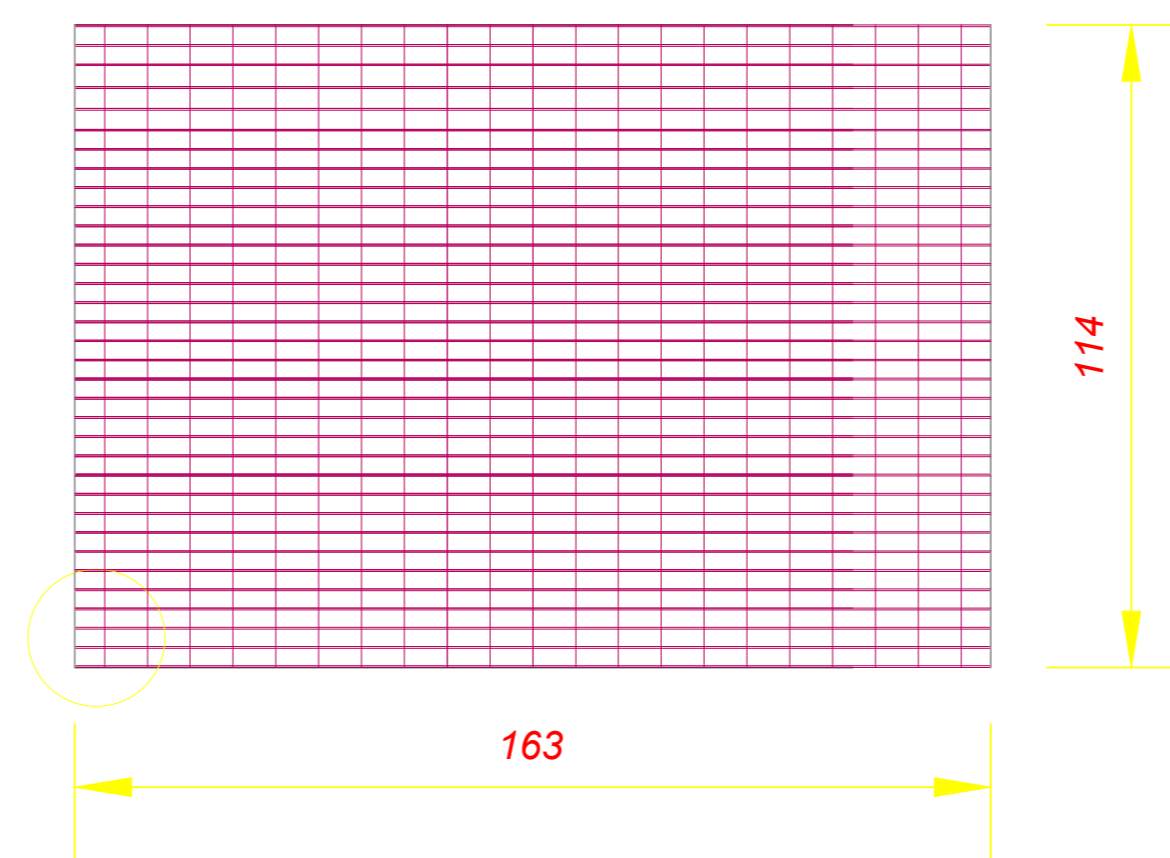

**Zgarë Tipi 4**

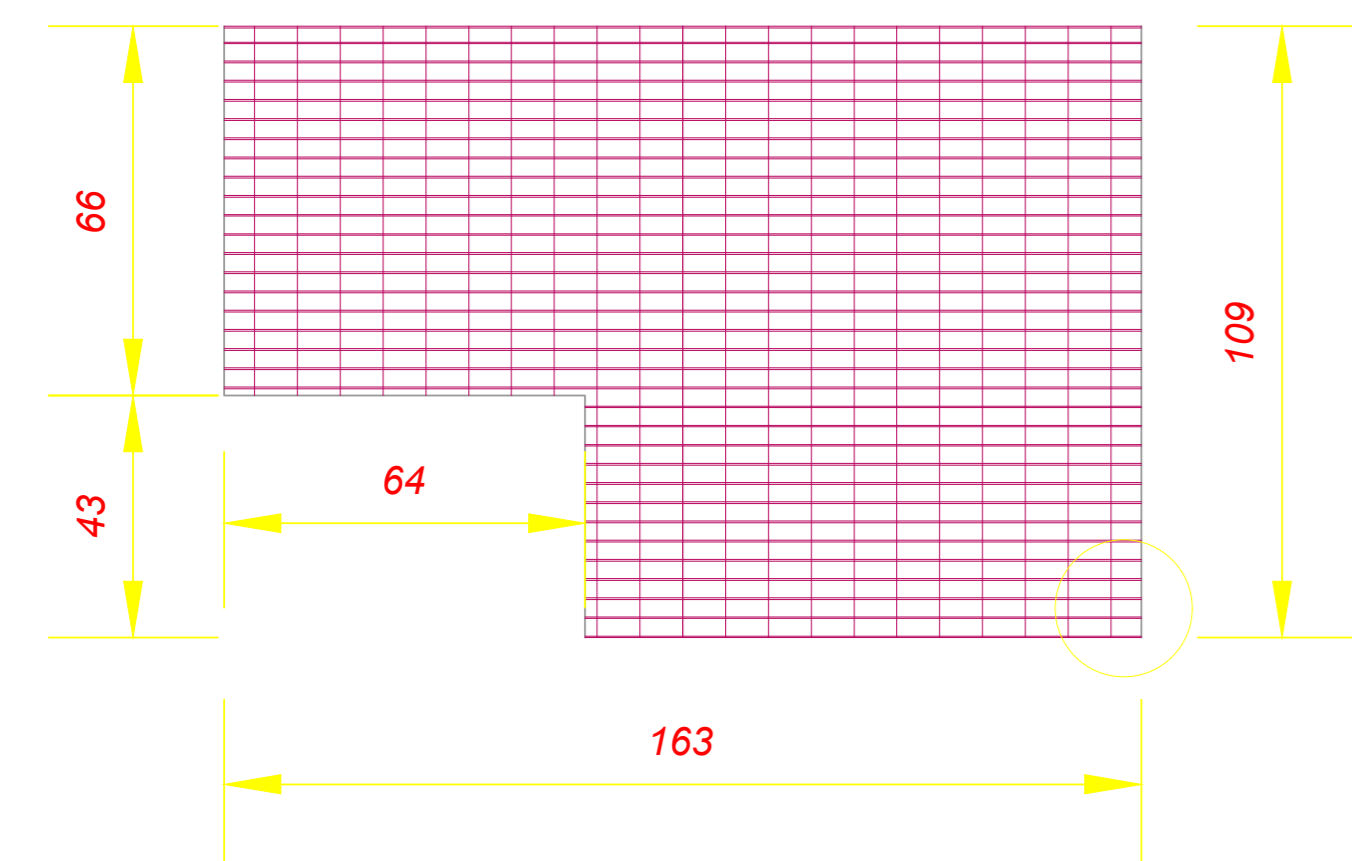

**Zgarë Tipi 5**

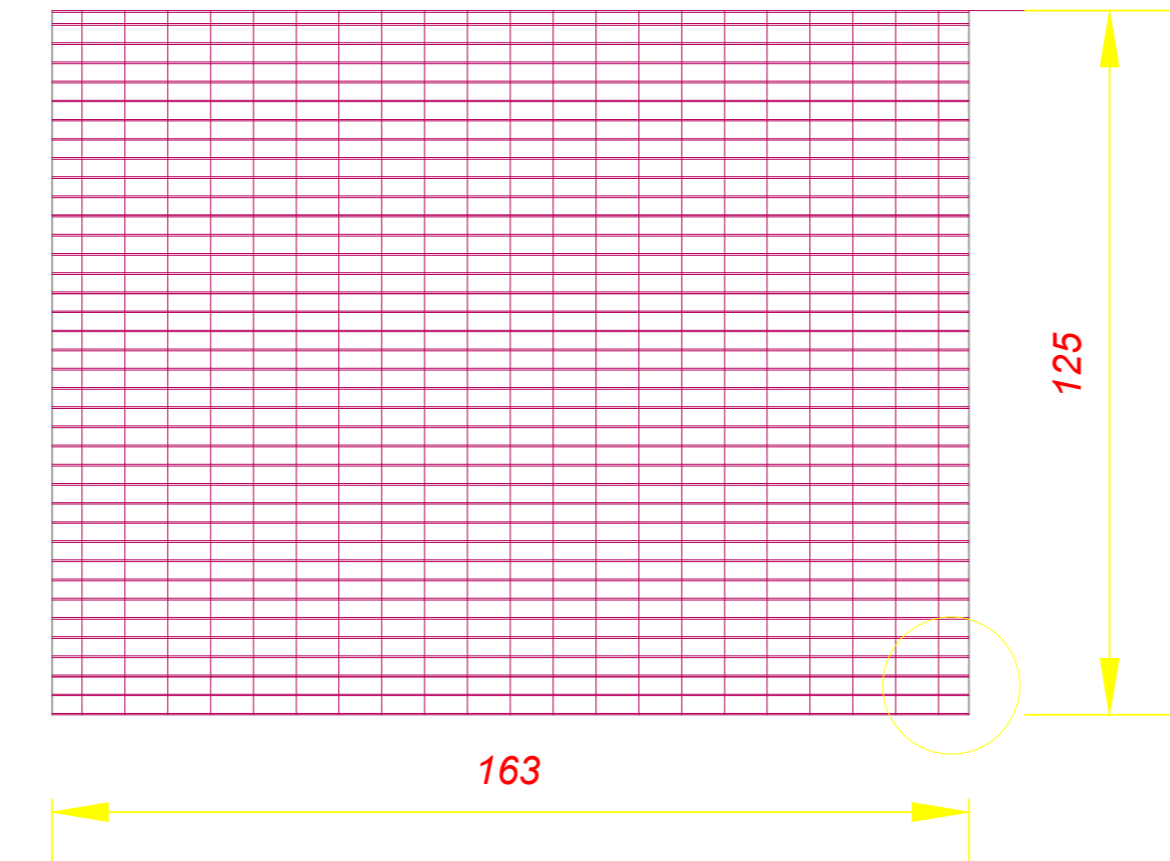

**Zgarë Tipi 6**

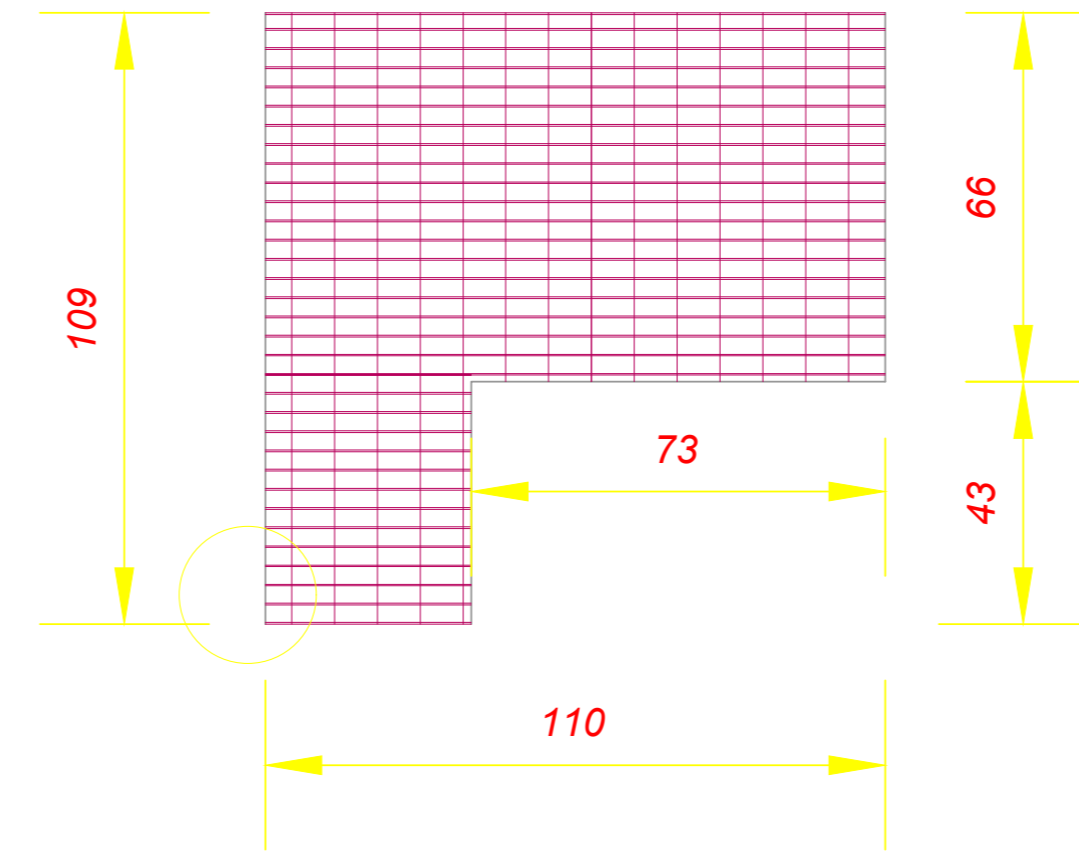

**Zgarë Tipi 7**

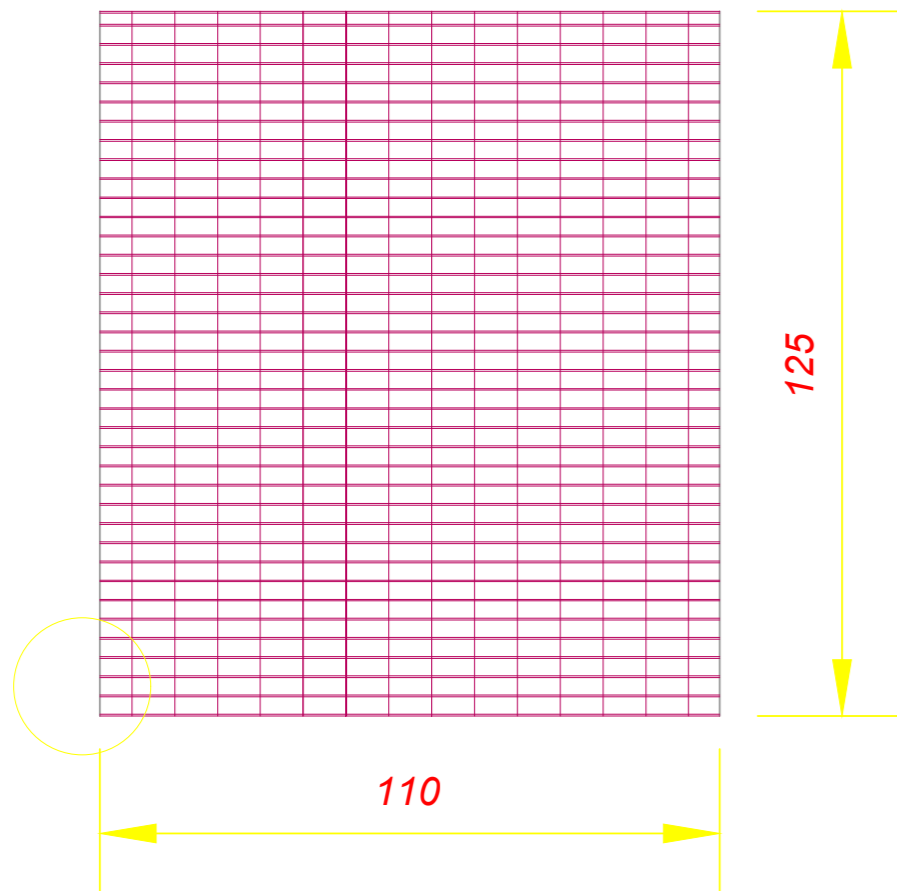

**Zgarë Tipi 8**

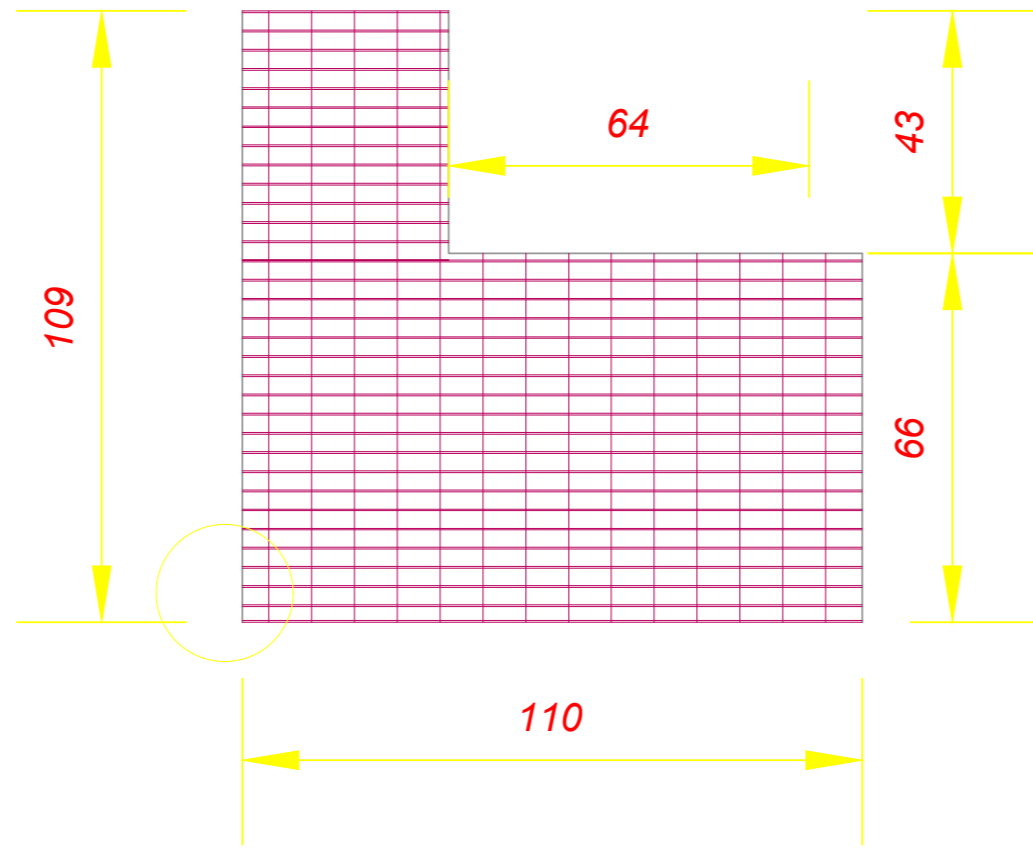

**Zgarë Tipi 9**

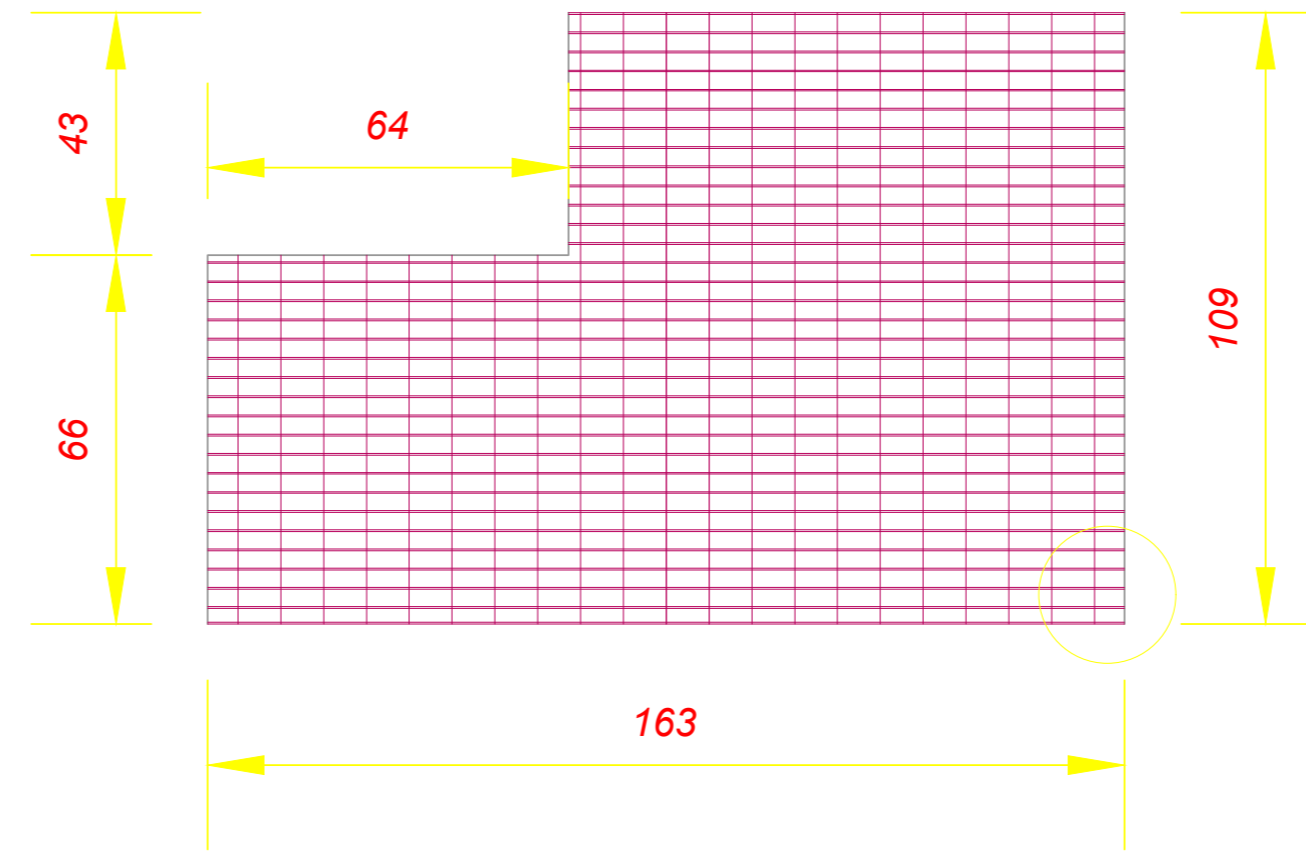

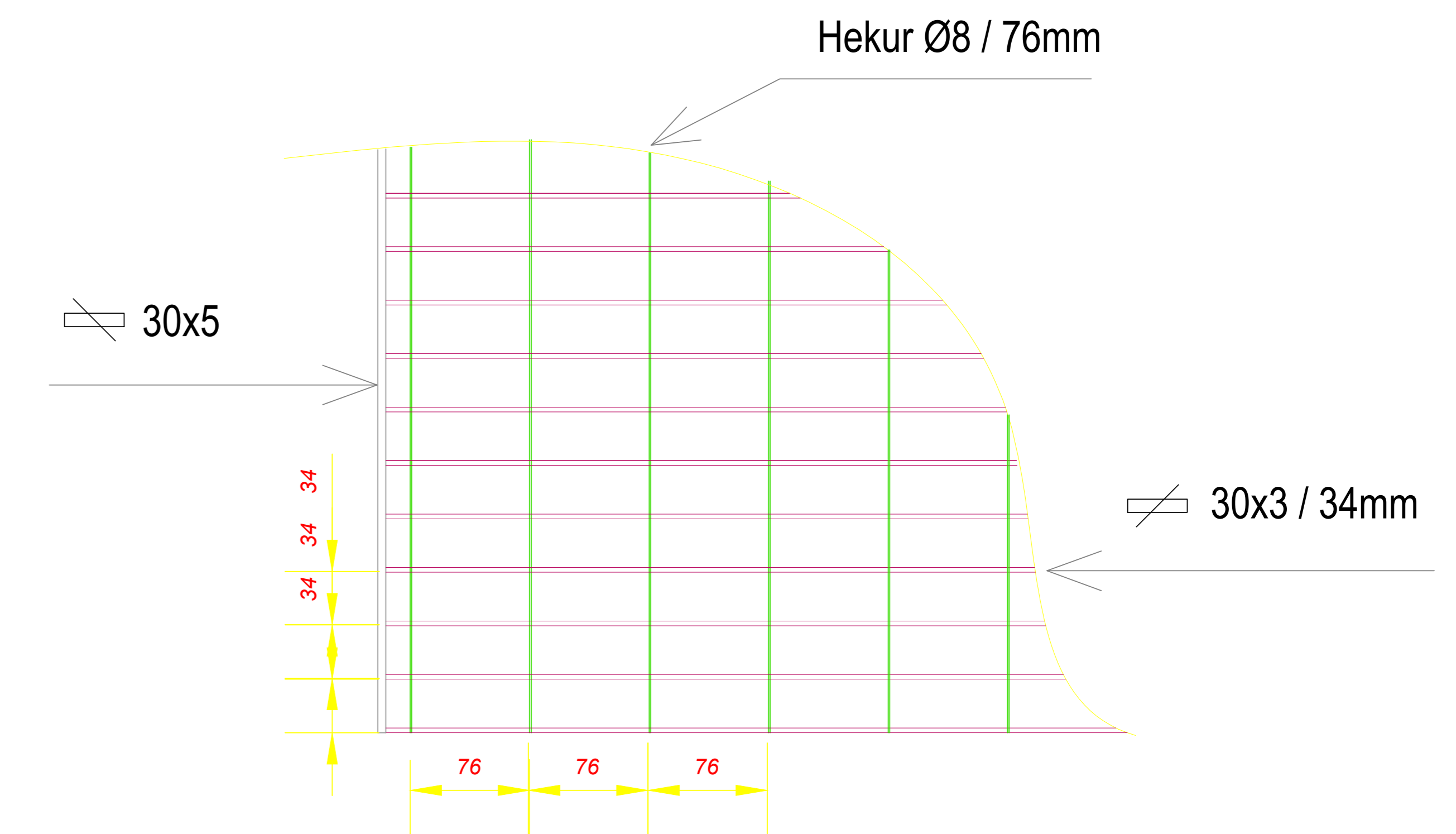

**Detaj Shk 1:5**

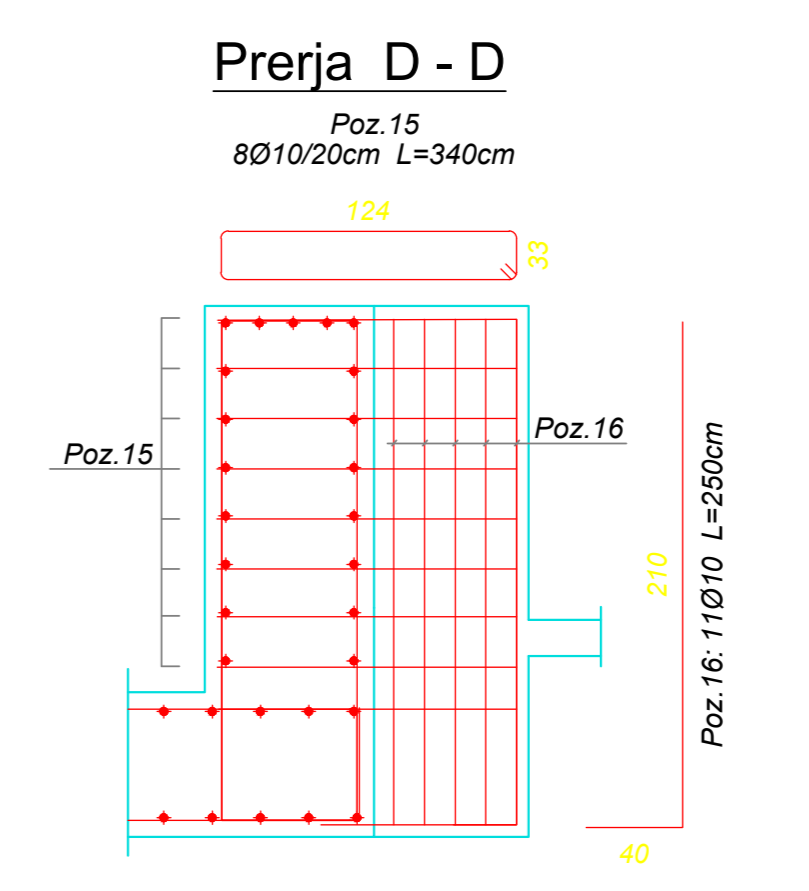
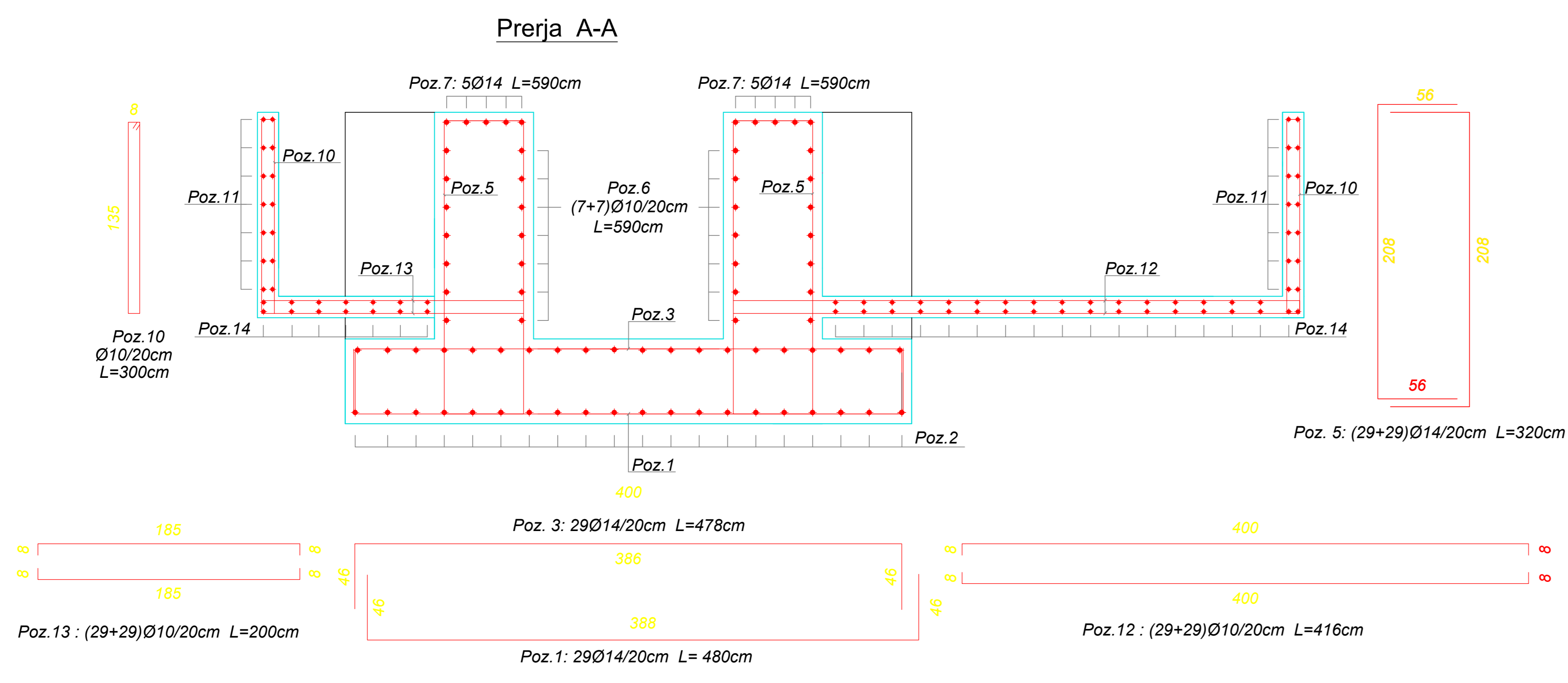
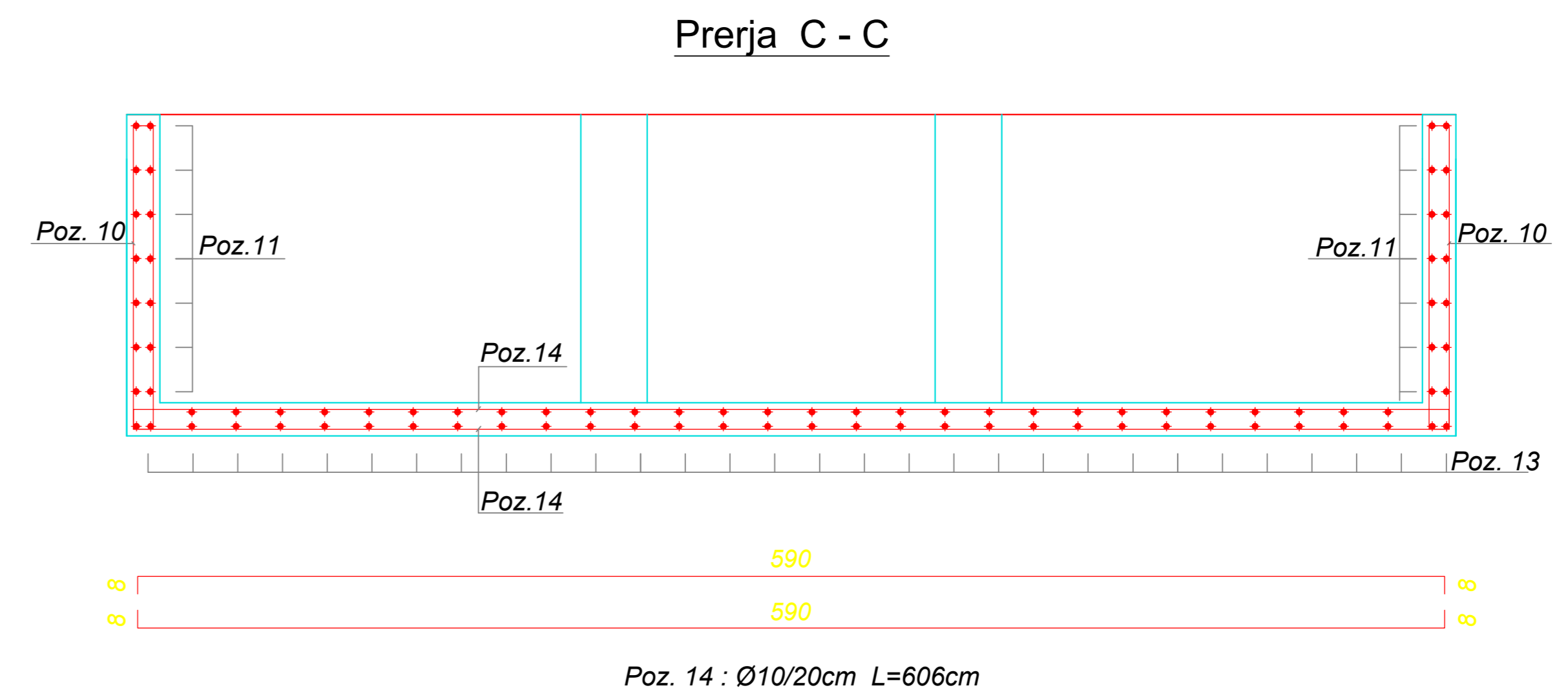
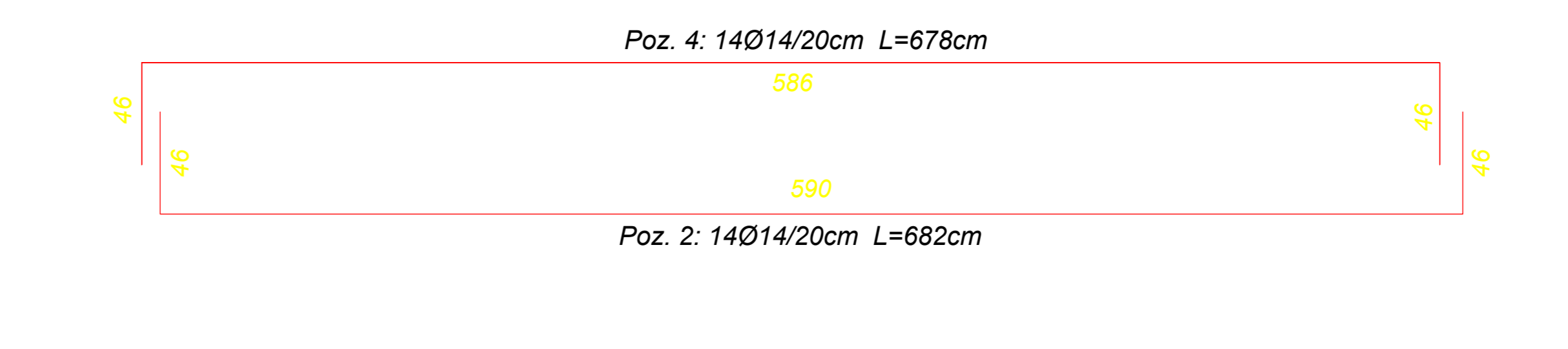
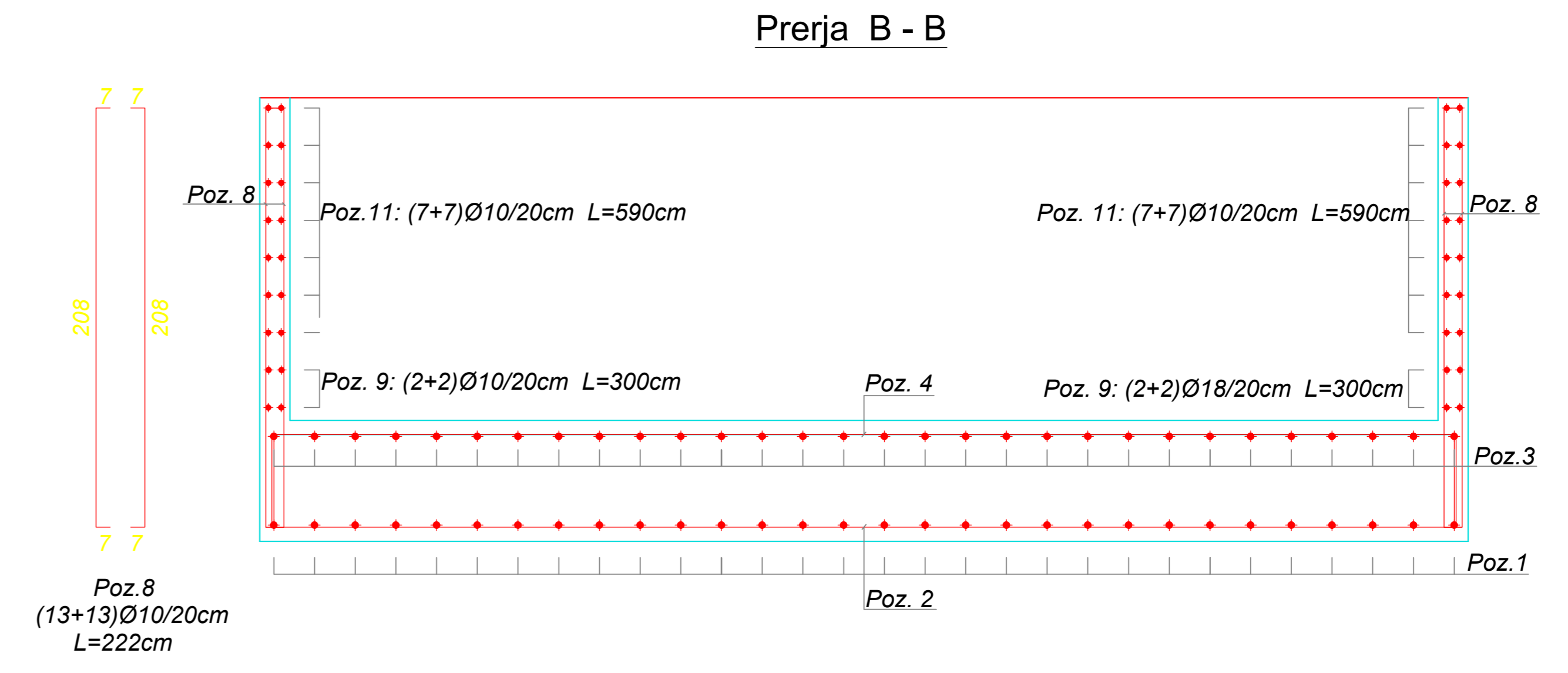
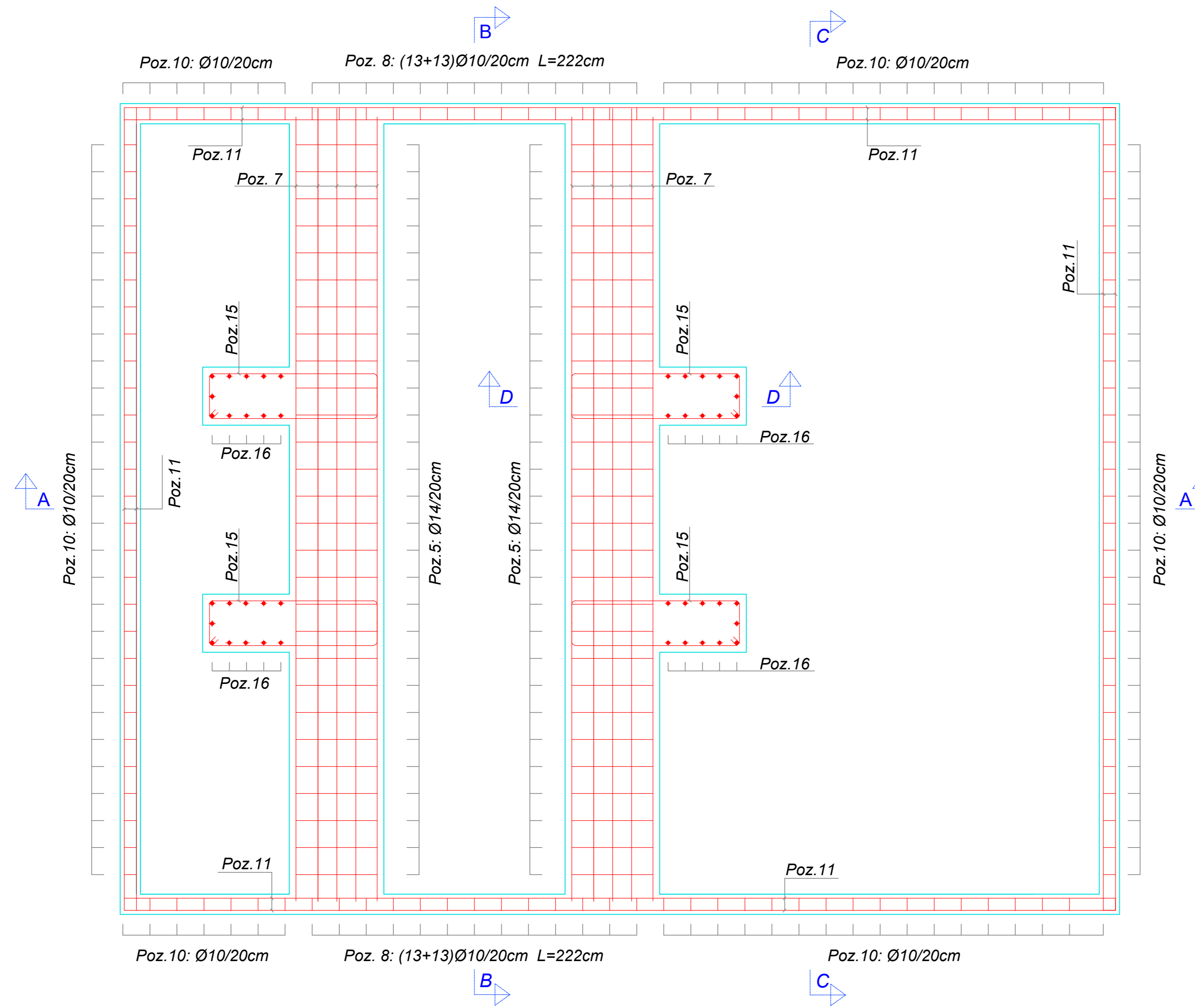

 <p><b>DREJTORIA E TENSIONIT TË LARTË</b></p>	DREJTORI		
	SHEF DEGA TEKNIKE		
Emërtimi objektit <p align="center"><b>RIKONSTRUKSIONI &amp; FUQIZIMI I N.STACIONIT 110/35/20/10/6kV, KUÇOVË.</b></p>	SHEF ZYRA PROJEKTIT		
	PROJEKTOI		
	PROJEKTOI		
	PROJEKTOI		
	PROJEKTOI		
Emërtimi fletës Bazamenti i transformatorit të fuqisë, detajet e zgavrave.	PERPUNOI		
	FAZA: PROJEKT ZBATIMI		
Porositës: <p align="center"><b>DTL</b></p>	SHKALLA	Dt.	2023
	NR. PROJEKTIT		DIN A3
	FLETA VIZATIMIT		

# BAZAMENTET E TRANSFORMATORËVE TË FUQISË, N.STACIONI 110/35/20/10/6kV KUÇOVË.



 <b>DREJTORIA E TENSIONIT TË LARTË</b>	DREJTORI			
	SHEF DEGA TEKNIKE			
Emërtimi objektit	SHEF ZYRA PROJEKTIT			
	PROJEKTOI			
	PROJEKTOI			
	PROJEKTOI			
Emërtimi fletës	PROJEKTOI			
	PERPUNOI			
Porositës:	Bazamenti i transformatorit të fuqisë, detajet e zgavrave.	FAZA: PROJEKT ZBATIMI		
	<b>DTL</b>	SHKALLA	Dt. 2023	DIN A3
		NR. PROJEKTIT		
	FLETA VIZATIMIT			

**BAZAMENTET E TRANSFORMATORËVE TË FUQISË, N.STACIONI 110/35/20/10/6kV KUÇOVË.**

**Poz. 1 L 50x50x6 (8 copë)**

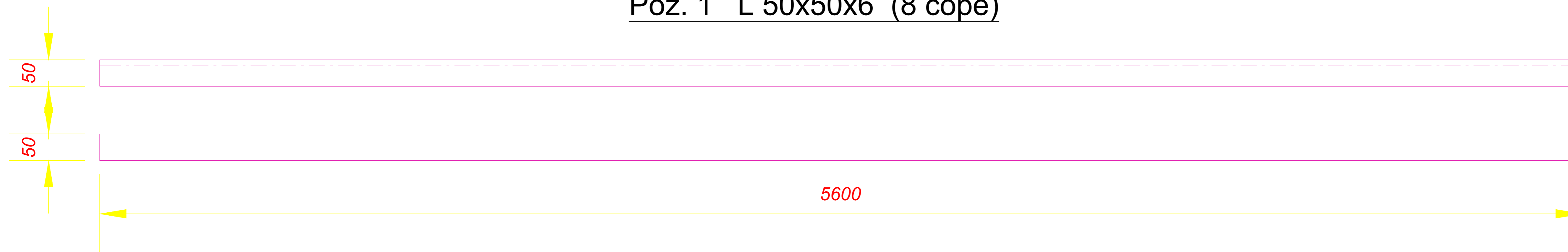

**Poz. 2 L 50x50x6 (4 copë)**

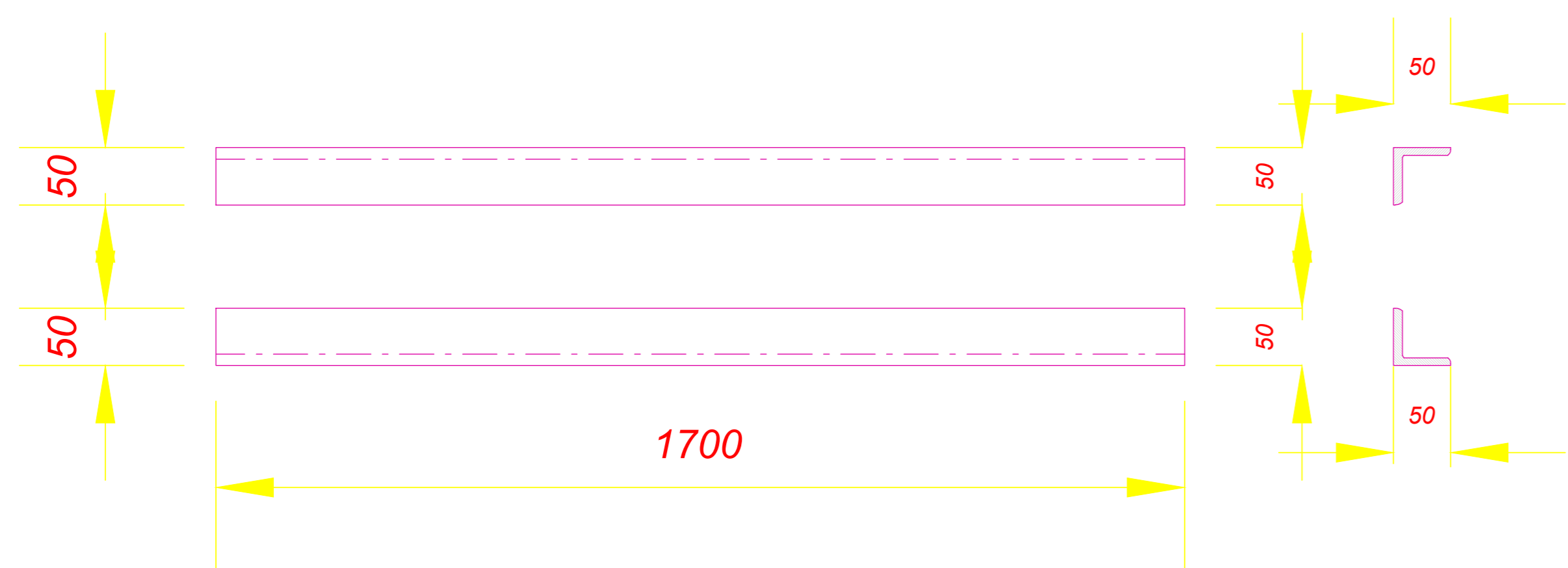

**Poz. 3 L 50x50x6 (2 copë)**

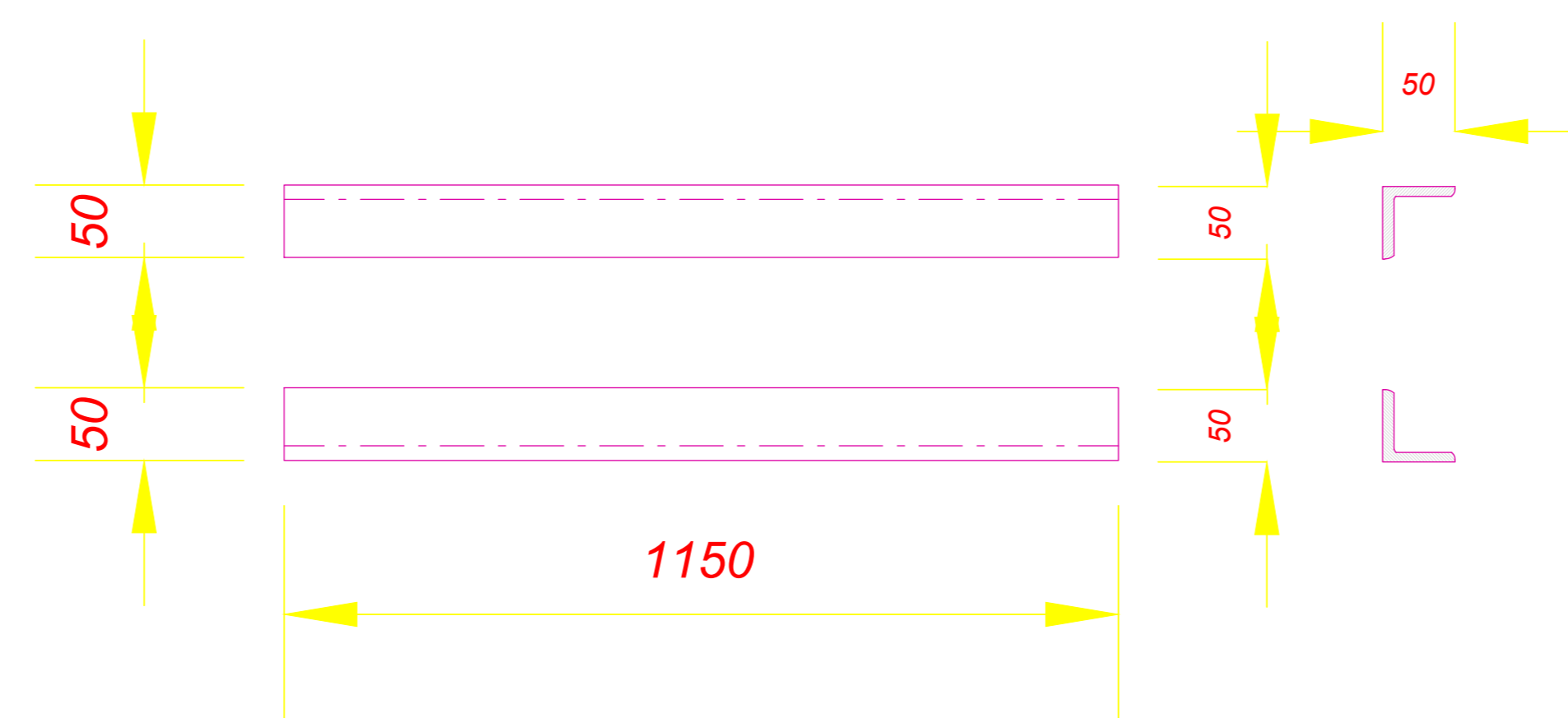

**Poz. 8 L 50x50x6 (4 copë)**

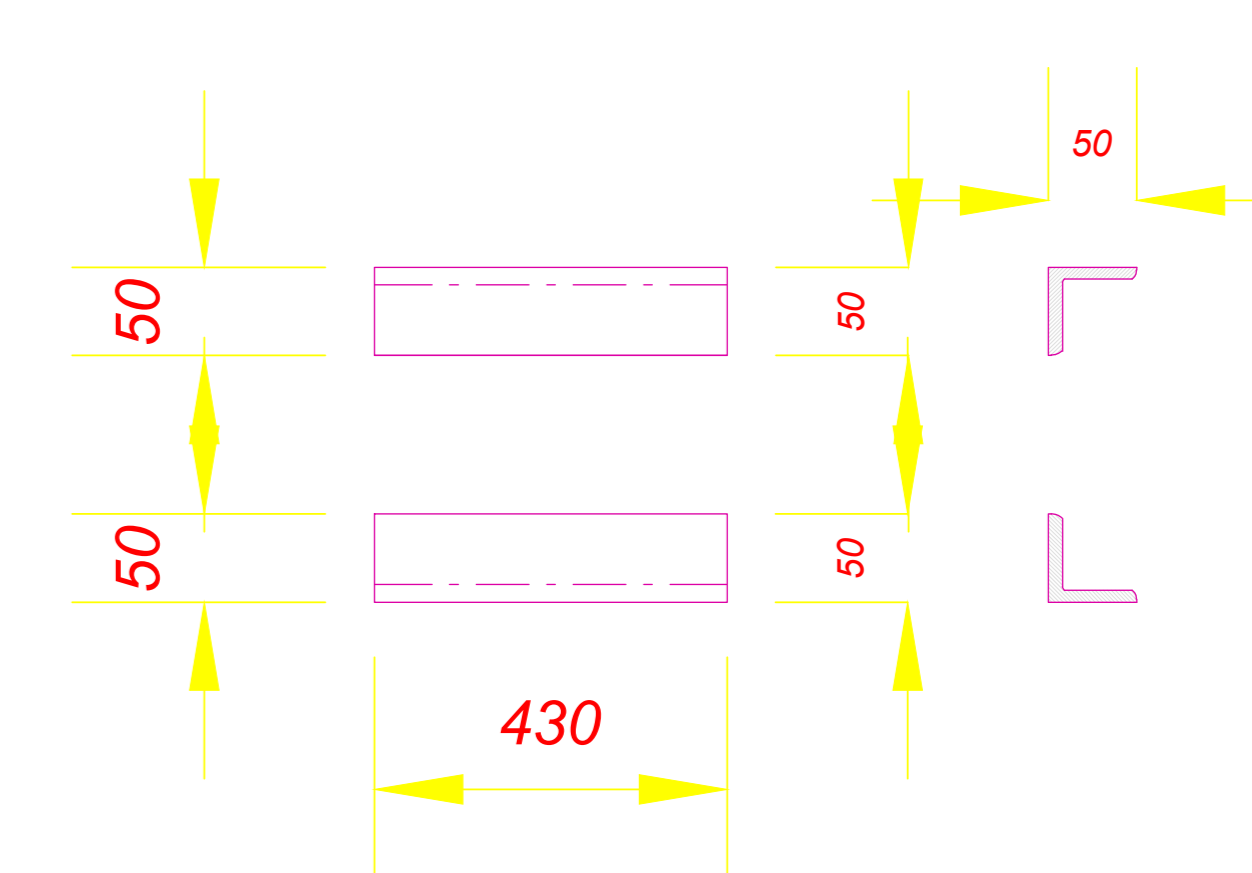

**Poz. 4 L 50x50x6 (2 copë)**

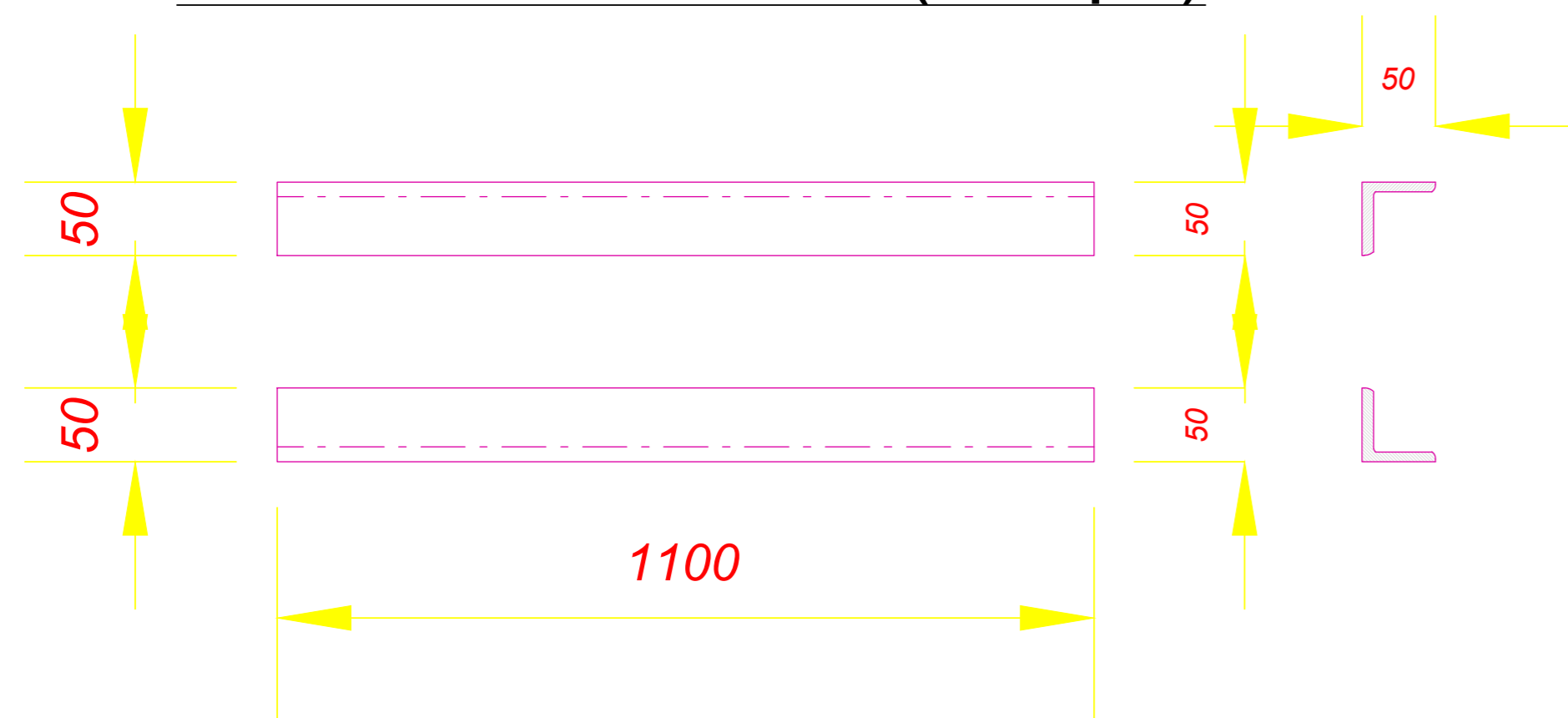

**Poz. 5 L 50x50x6 (2 copë)**

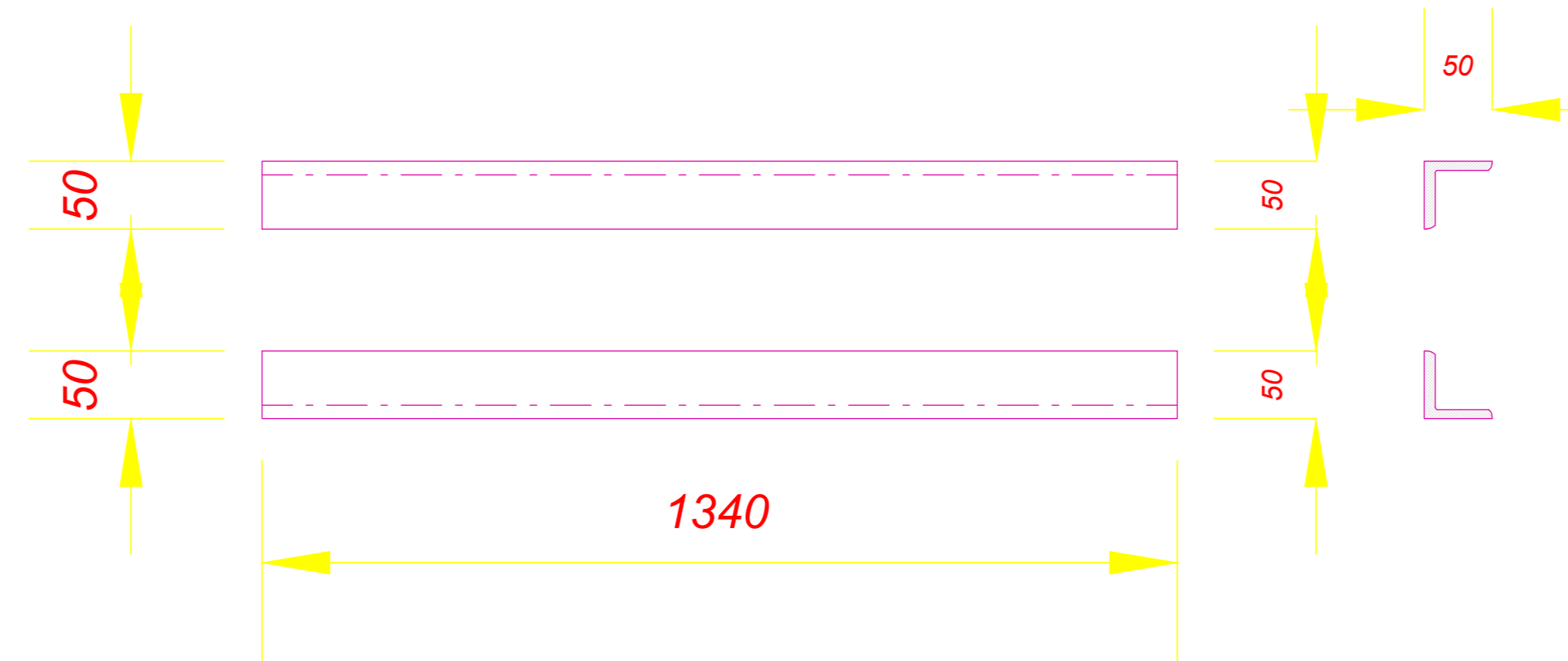

**Poz. 7 L 50x50x6 (8 copë)**

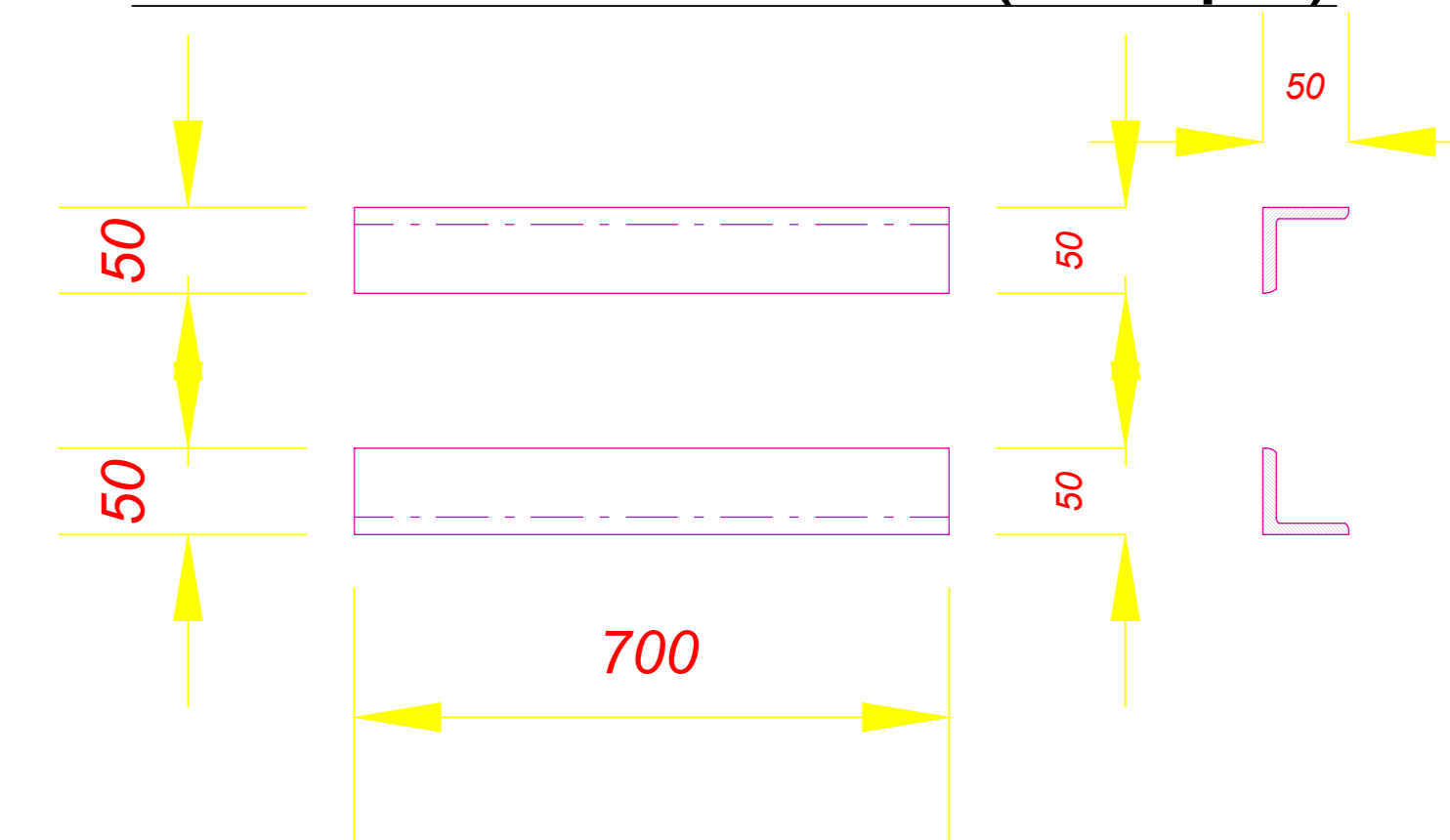

**Poz. 6 L 50x50x6 (2 copë)**

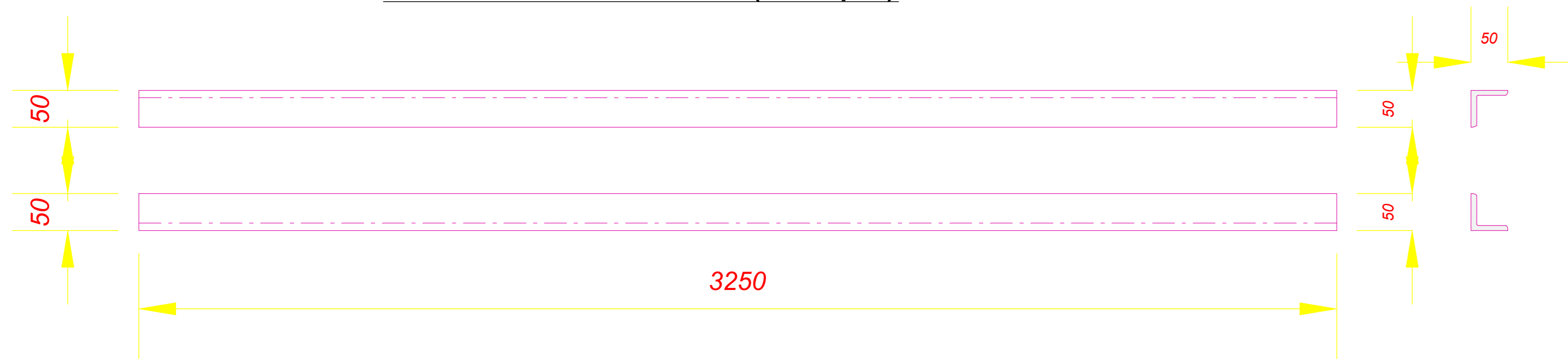

	DREJTORI			
	SHEF DEGA TEKNIKE			
<b>DREJTORIA E TENSIONIT TË LARTË</b> Emërtimi objektit <b>RIKONSTRUKSIONI &amp; FUQIZIMI I N.STACIONIT 110/35/20/10/6kV, KUÇOVË.</b>	PROJEKTOI			
	PROJEKTOI			
	PROJEKTOI			
	PROJEKTOI			
Emërtimi fletës Bazamenti i transformatorit të fuqisë, detajet e zgavrave.	PERPUNOI			
	FAZA: PROJEKT ZBATIMI			
Porositës: <b>DTL</b>	SHKALLA	Dt.	2023	DIN A3
	NR. PROJEKTIT			
	FLETA VIZATIMIT			