

TE DANA MBI WERAT

WORE RETHI HAS

# REZERUVARI TOBEL

Kapaciteti 188000 m<sup>3</sup>

Aferia nytese 53 Ha.

Kanale vaditës (gjithsaj) 6.4 km

Kanali krahut djathtë 2.79 km

Q = 50 l/sec

seksioni<sup>1</sup>

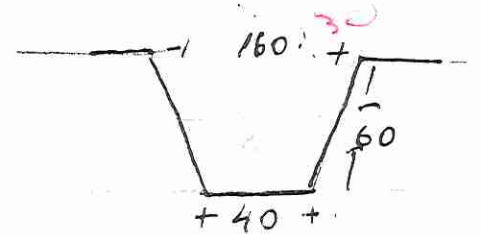

Kanali krahut majtë 3.61 km

Q = 50 l/sec

seksioni<sup>2</sup>

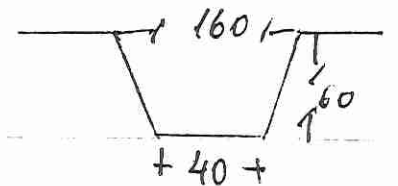

# REZERVUARI TREGTAN N° 1

Kapaciteti  $85000 \text{ m}^3$

Aftesia yitesed  $25 \text{ Ha}$

Kanali kryesor  $1 \text{ km}$

$$Q = 30 \text{ l/sek}$$

seksioni

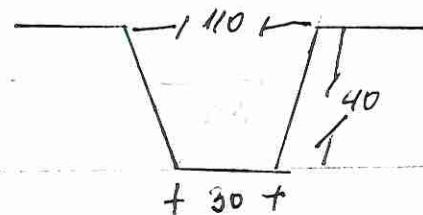

# РЕЗЕРВУАР ТРЕТЊИ № 2

Капацитет  $56000 \text{ m}^3$

Адреса изградње 16 Ха.

Капацитет резервоара 2 км.

$$Q = 30 \text{ l/sec}$$

Секција

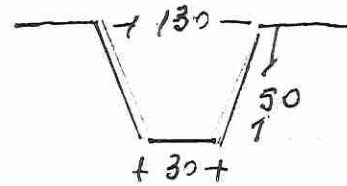

# REZERUVARI TREGTAN N° 3

Kapaciteti 915000 m<sup>3</sup>

Aftesia rytesci 260 Ha.

Kanale vadites gjithsaj 6.8 km.

A)  $V_1 = 0.7 \text{ km}$

B)  $V_2 = 3.8 \text{ km}$

C)  $V_3 + V_5 = 2.3 \text{ km}$

SER.  $V_1, V_2$

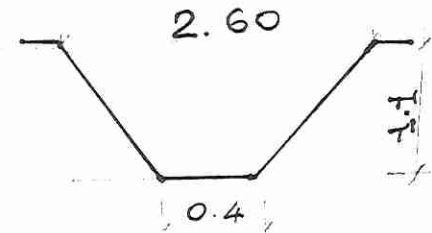

$Q = 260 \text{ L/s}$

$Q = 150 \text{ L/s}$

SER.  $V_4 + V_5$

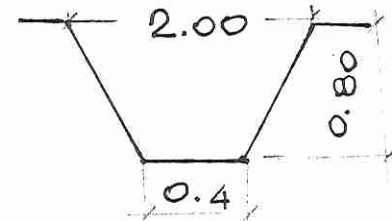

## STACIONI POMPIMIT TREGTAN.

A) TUBI I DERGIMIT GJATSJ 0.26 km

$Q = 100 \text{ L/s}$

B) KANALI VADITES  $V_3 + V_6 + V_7 + V_8 = 5.3 \text{ km}$

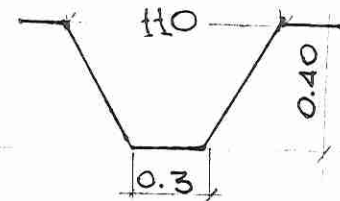

$Q = 30 \text{ L/s}$

# REZURVARI LESHNICE

KAPACITETI 993.000 m<sup>3</sup> UJE<sup>o</sup>  
 AFTESIA UJITESH 280 HA  
 KANALI VADITESH GJITHSEJ 9 KM.

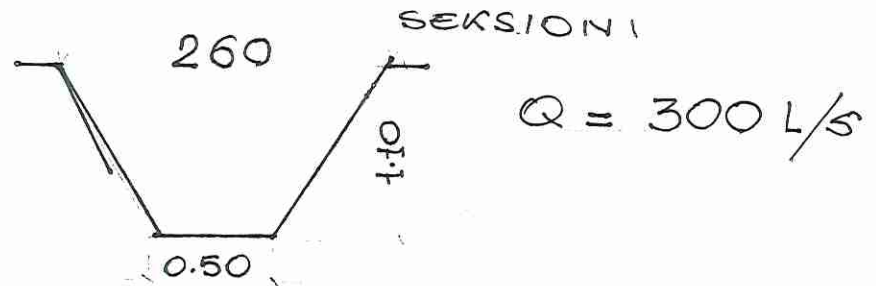

## STACIONI POMPIMIT LESHNICE NR 1.

KANALE VADITESH GJITHSEJ 1.5 KM  
 TUBI I DERGIMIT GJATESI 260 ML  
 KANALE VADITESH GJITHSEJ 1.5 KM  
 A)  $U_{4/1} + U_4 + U_{4-3} = 1.5 \text{ KM}$

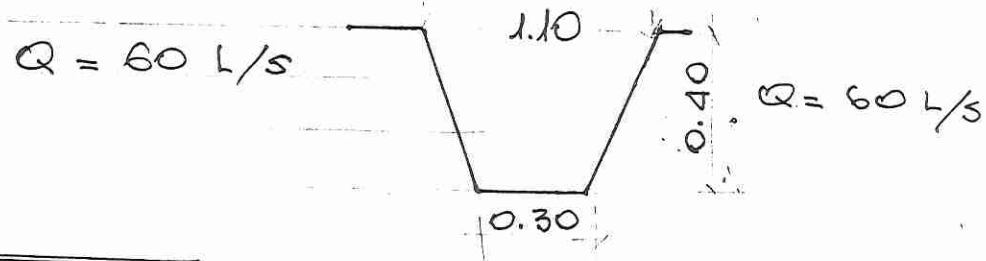

## STACIONI POMPIMIT LESHNICE NR 2.

TUBI I DERGIMIT GJATESI 332 ML PRURJA  $Q = 160 \text{ L/s}$   
 KANALE VADITESH GJITHSEJ 2.8 KM.  
 TUBI CELIKU  $U_{3-1}, U_3, U_{3/4}, U_2, U_{2/3}$  GJATESIA 1600 ML  
 KANALET VADITESH  $U_{2/1} - U_{2/4}, U_{2/3}, U_{2/6}$  GJATESIA 1.6 KM  
 PRURJA  $Q = 30 \text{ L/sek.}$

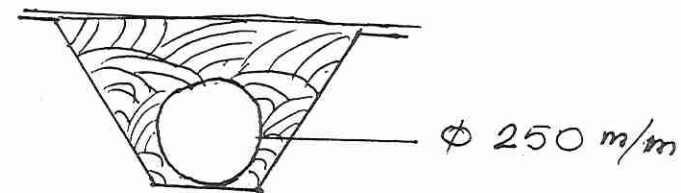

SEKSIONI

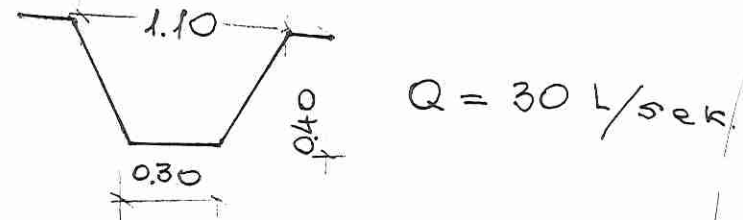



# REZURVARI FAJZA.

DAPACITETI 700.000 M<sup>3</sup> UJE<sup>2</sup>

AFTESIA UJITSE 200 HA

KANALE VADITES GJITHSEJ 11 KM

PRURJA Q = 200 l/sek

A. KANALI KRYESORE<sup>s</sup> 7 KM

PRURJA Q = 200 l/s

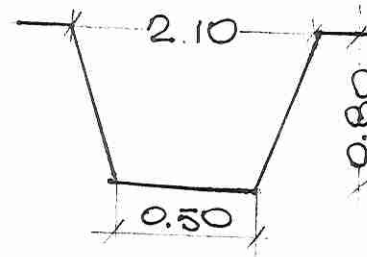

Q = 200 L/SEK.

B. KANALET E QABRATIT

GJATSHIA 4 KM

PRURJA 60 l/sek.

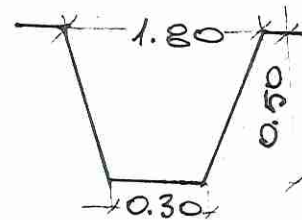

## STACIONI POMPIMIT FAJZA.

RUBI 1 DERGIMIT 350 ML

KANALI VADITES 4.7 KM.

A. KANALI MAJTE<sup>s</sup> 2.7 KM

PRURJA Q = 40 l/sek.

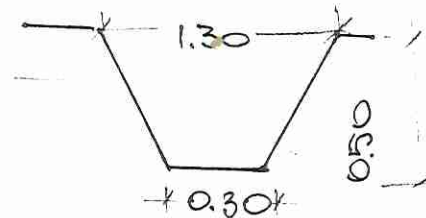

B. KANALI DJATHE<sup>s</sup> KM 2

PRURJA Q = 30 l/sek.

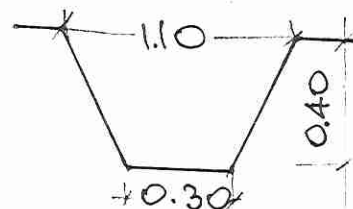

# REZERVUARI VRANJSKI N° 1

kapaciteti 124000 m<sup>3</sup>

Aftesia sistese 35 Ha

kanale voditej 3.1 km

a) konoli voditej krohu i majki 1.9 km

seksioni<sup>o</sup>

$$Q = 30 \text{ l/sec}$$

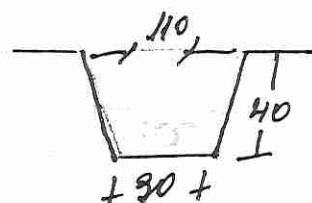

b) konoli voditej krahu i Djatlet 2.2 km

seksioni<sup>o</sup>

$$Q = 40 \text{ l/sec}$$

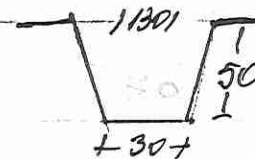



## REZURVARI VRANISHT 2

KAPACITETI 504.000 M<sup>3</sup> UJE<sup>2</sup>

APTESIA UJITSE 144 HA.

A) KANALI KRËSOR 3.5 KM  $Q = 200$  L/S

(SARAQINESKË - TUB, KRYQZIM) 3.5 KM

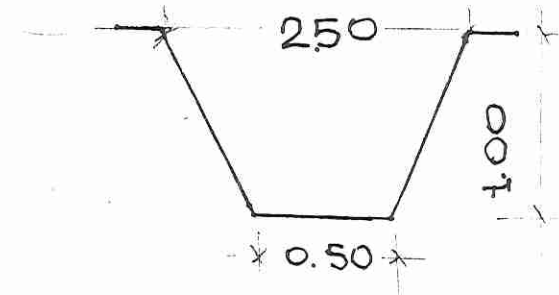

B) KANALI MAJTË 4.3 KM

PRURJA  $Q = 80$  L/sek.

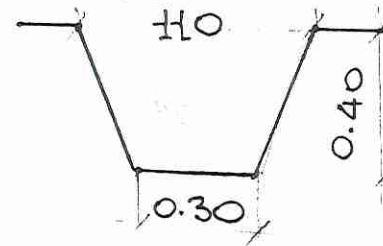

C) KANALI DJATHË<sup>s</sup> GOATESIA 4 KM

PRURJA  $Q = 60$  L/sek

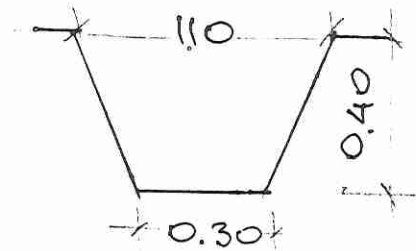

# REZURVARI LLAKAJ.

(4)

KAPACITETI 1.700.000 M<sup>3</sup> UJE<sup>2</sup>

AFTESIA UJITESE 485 HA

KANALE VADITESE GJATESIA 24.01 KM.

— KANALI KU-1 GJATESIA 1.27 KM  
PRURJA Q = 300 L/sek.

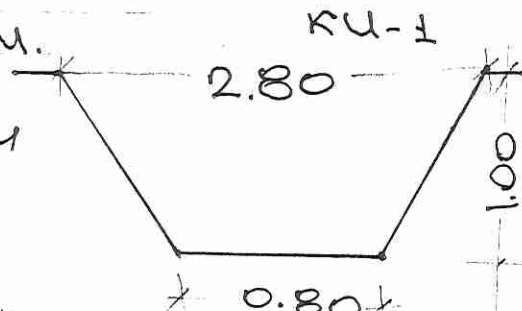

— KANALI KU-2 GJATESIA 2.2 KM  
PRURJA Q = 250 L/sek.

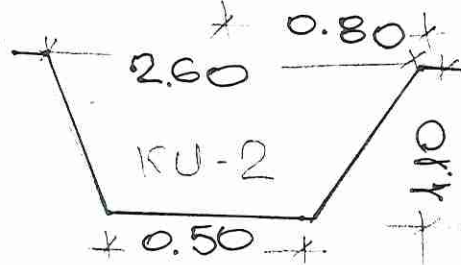

— KANALI KU-11  
PRURJA Q = 60 l/sek.  
GJATESIA 2.03 KM

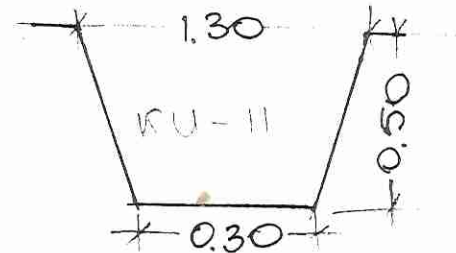

— KANALI KU-12  
GJATESIA 5.01 KM.  
PRURJA Q = 100 L/sek.

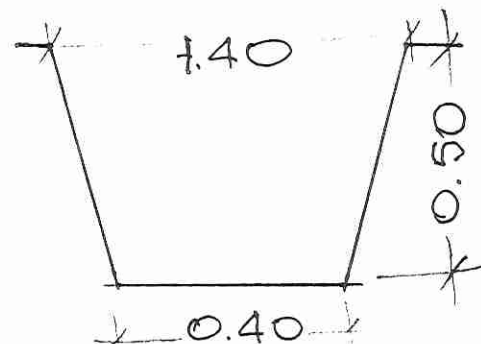

VIZON

NIJON REZ. LLAKAJ.

(2)

SEK. 71P

- KANALI: KU-20 = 1.8 KM, KU-21 = 0.5 KM, KU-22 = 1.45 KM  
KU-23 = 1.1 KM, KU-24 = 0.55 KM, KU-25 = 0.7 KM.

PRURJA  $Q = 30 \text{ l/sek.}$

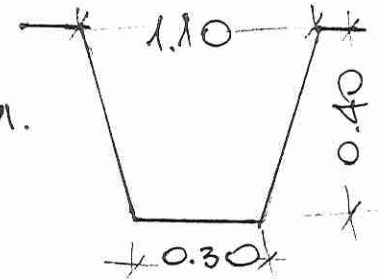

- KANALI KU-128

GAJATESIA 3.9 KM

PRURJA  $Q = 100 \text{ l/s}$

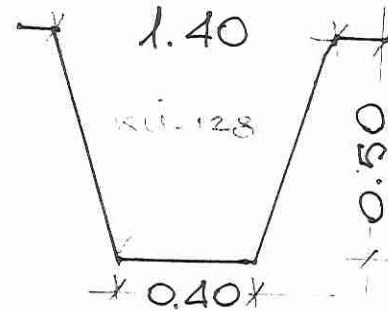

- KANALI KU-23

GAJATESIA 3.5 KM

PRURJA  $Q = 120 \text{ l/sek.}$

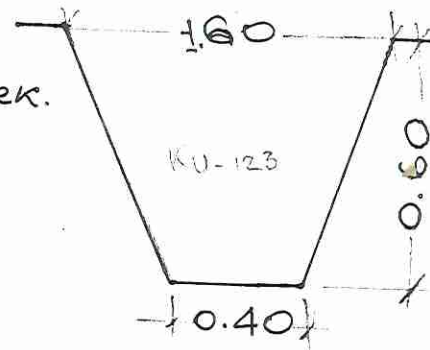

NIJON

S.T.P. LAKAJ NR. 1

PRURJA  $Q = 150 \text{ l/sek.}$

TUBI I DERGIMIT 186 ML

KANALE VADITSE GJITHSEJ 22.1 KM.

U.F. SH. TYB PLASMASI

KANALI KU-P1

GJATESIA = 0.8 KM

PRURJA  $Q = 40 \text{ l/s}$

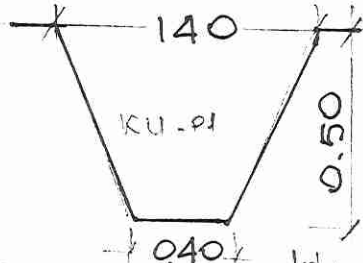

KANALI KU-P2

GJATESIA = 1.3 KM

PRURJA =  $Q = 110 \text{ l/sek}$

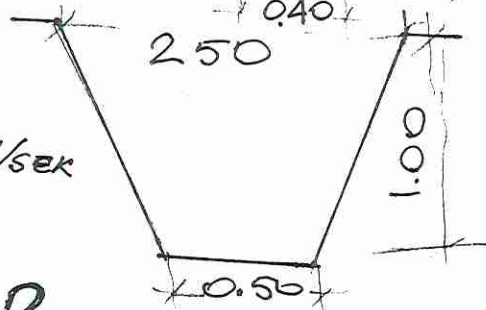

S.T.P. LAKAJ NR. 2

TUBI I DERGIMIT 120 ML

PRURJA 50 l/sek.

KANALI VADITES GJITHREJ 0.9 KM.

KANALI 2PKU-1

GJATESIA = 0.4 KM

PRURJA  $Q = 30 \text{ l/sek.}$

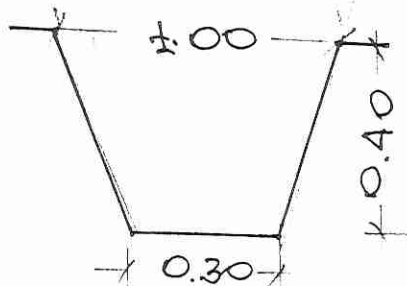

KANALI 2PKU-2

GJATESIA = 0.5 KM.

PRURJA  $Q = 30 \text{ l/sek.}$

# REZERVUARI BERES

Kapasiteti: 50000 m<sup>3</sup>

Aftwio. vytesa 15 Ha

Kanale voditei BJTHESEJ 3.1 km

a) konoli i trokut najt 2.1 km

$$Q = 20 \text{ l/sek}$$

seksioni

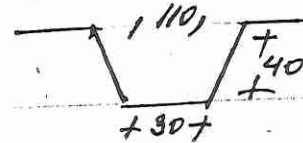

b) konoli i trokut Djatket 1 km

$$Q = 30 \text{ l/sek.}$$

seksioni

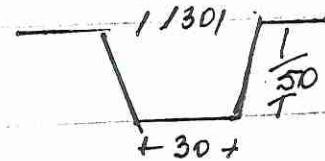



# REZERVUARI GOLJAZ N° 1

Kapacitet: 160.000 m<sup>3</sup>

Afeksió nystése 45 Ha

Kausole veditéi Bstitheséj 3.1 km

a) Kausóli Lórhut májt. 2 km

$$Q = 30 \text{ l/sek}$$

seksións<sup>o</sup>

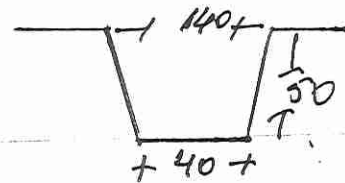

b) Kausóli Lórhut májt. 1.1 km

$$Q = 30 \text{ l/sek}$$

seksións<sup>o</sup>

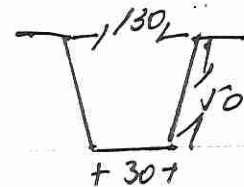



# REZERVUARI GOLAJ N° 2

Kapaciteti 72000 m<sup>3</sup>

Aftesia rykese 20 Ha

Konoli° kryesar voditeš 2.4 km.

Q = 30 l/sec.

Densitoni°

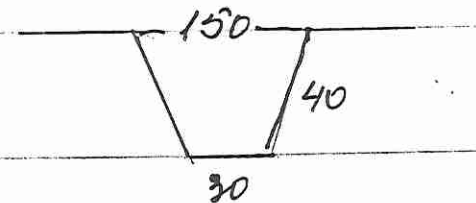

# REZERVUARI GOLJAJ № 3

Kapacitet: 195000 m<sup>3</sup>

Aftisid ryzko 55 Hol

Kanale voditej GJIThesaj 4 km

a) Kowali voditej KU-1 km. 102

Q = 30 l/sek

Seksion<sup>o</sup>

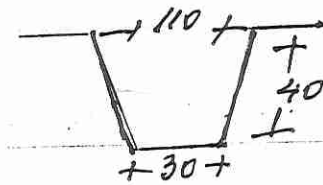

b) Kowali voditej KU-2

Q = 40 l/sek

Seksion<sup>o</sup>

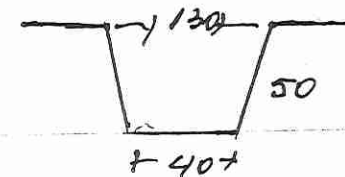

## REZURVARI NIKOLIQ NR 1

- KAPACITETI 12.000 M<sup>3</sup> UJE<sup>6</sup>
- AFTESIA UJITE<sup>6</sup>SE 3 HA
- KANALE VADITE<sup>6</sup>S 1 KM
- PRURJA Q = 20 L/SEK.

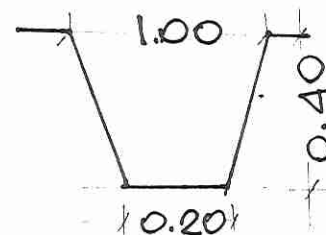

## REZURVARI QARR NR 1

- KAPACITETI 93.000 M<sup>3</sup> UJE<sup>6</sup>
- AFTESIA UJITE<sup>6</sup>SE 26 HA
- KANALI VADITE<sup>6</sup>S 1.6 KM
- PRURJA Q = 20 L/SEK.

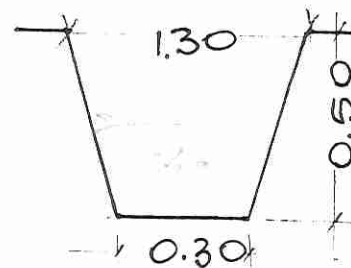

# STACIONI POMPIMIT

## ROSMAN

AFTESIA UJITËSE 50 HA

PRURJA  $Q = 50$  L/sek

KANALI VADITËS 1 KM

GJATËSIA E TUBIT DERG. 455 ML.

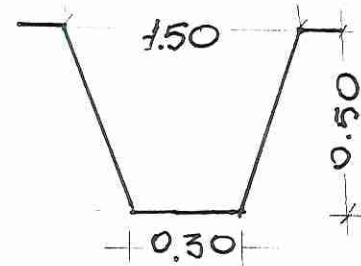

## REZURVARI NIKOLIQ NR 2.

KAPACITETI 20.000 M<sup>3</sup> UJË

AFTESIA UJITËSE 6 HA

KANALI VADITËS 1 KM

PRURJA  $Q = 20$  L/sek.

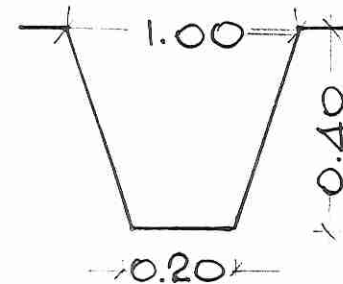

# REZURVARI QARR NR. 2

KAPACITETI 542.000 M<sup>3</sup> UJE<sup>s</sup>

AFTESIA UJITESE 155 HA

KANALE VADITES GJITHSEJ 15.8 KM.

- A. KANALI KRYESORE 1.8 KM KRQZIM-PLEPA  
PRURJA  $Q = 200 \text{ L/SEK.}$

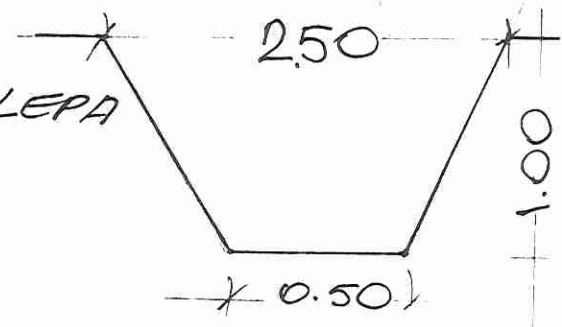

- B. KANALI KRQZIM-PEROLLAJ

GJATESIA 5.2 KM

PRURJA 60 L/SEK.

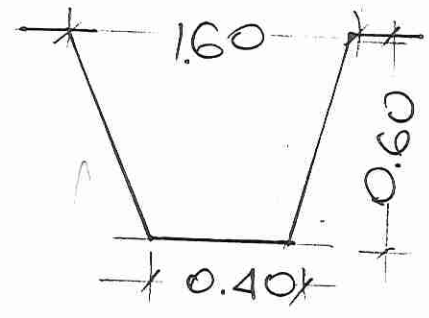

- C. KANALI KRQZIM-ZAFRISHT

GJATESIA 8.8 KM

PRURJA 130 L/SEK.

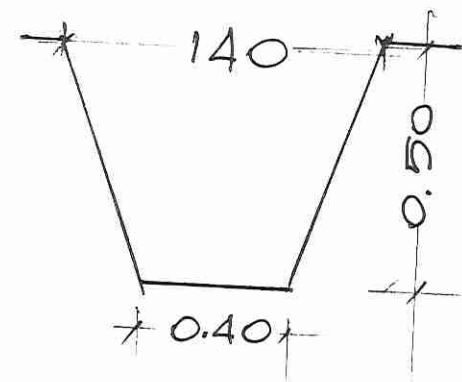



S.T.P PLA 1 PATE'S

PRURJA  $Q = 60$  l/sek.

KANALI U.F.SH 7.7 KM ME TUB PLASMASI

REZ. DOBRUNE

KAPACITETI 850.000 M<sup>3</sup> UDE<sup>s</sup>

AFTESIA UJITSE 250 HA

GDATESIA ERJETIT GJITHSEJ 14.8 KM.

A. KANALI U1

GDATESIA 11 KM

PRURJA  $Q = 250$  l/sek.

B. KANALI U1-1 ÷ U1-5

GDATESIA ERJETIT 2.75 KM

PRURJA 30 l/sek.

STACIONI POMPIMIT

PRURJA  $Q = 60$  l/sek.

TUBI I DERGIMIT 591 ML

KANALI VADITES 0.8 KM

KANALE U2-1 - U2-2 U.F.SH TUB SELIKU  $\Phi 200$  AFTESIA 50 HA.

ML GJITHSEJ 850 ML.

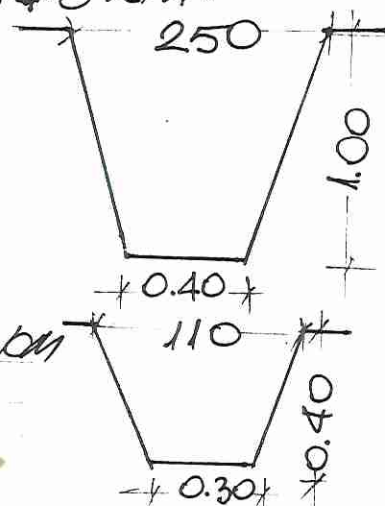

SEK. KANALIT

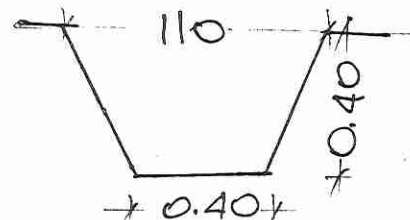



# REZURVARI LETAJ

KAPACITETI 1.390.000 M<sup>3</sup> UJE<sup>s</sup>

AFTESIA UJITESË 400 HA

KANALE GJITHSEJ 9.9 KM

## -A KRAHU MAJTE<sup>s</sup>

.GJATESIA 5.4 KM

.PRURJA 250 L/SEK

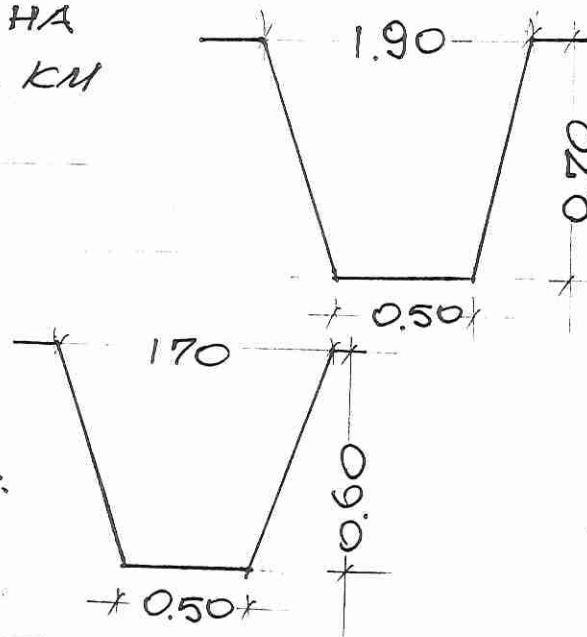

## -B KRAHU DJATHTE<sup>s</sup>

.GJATESIA 4.5 KM

.PRURJA Q = 150 L/SEK.

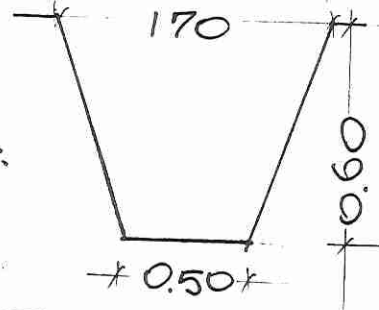

## ST. P. LETAJ.

TUBI DERGIMIT 685 ML

PRURJA Q = 70 L/SEK.

KANALI VAOITE<sup>s</sup> 5.3 KM.

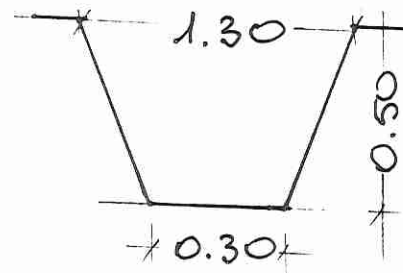

# REZERVUARI HELSIKIN IV: 1

Kapaciteti:  $32000 \text{ m}^3$

Ajkestis yitese 10 Hq.

Jameti roolitei 1 km

$Q = 10 \text{ l/sec}$

Seznam

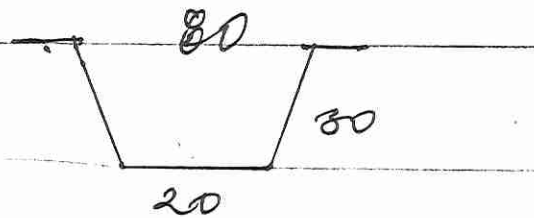

# РЕЗЕРВУАР МЕЛСНАН №2

Капацити 15000 м<sup>3</sup>

Аффект систем 5 тг.

Канал радиус 1 км.

Q = 10 л/сек

Сек зема

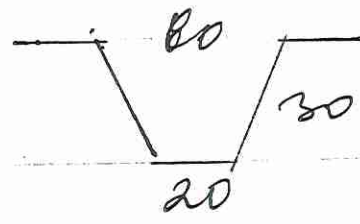

# REZERVUARI HELSINKI N:o 4

Kapacity: 208000 m<sup>3</sup>

Affluent rate: 60 l/s

Depth: water level 5.798 km

a) water level  $K_1$  km 4.336

$$Q = 70 \text{ l/s}$$

Depth:

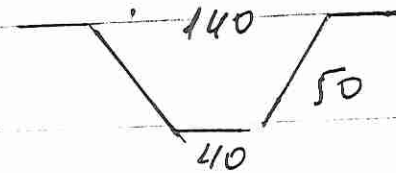

b) water level  $K_1$  km 1.462 (Sifon)

$$Q = 60 \text{ l/s}$$

Depth:  $\phi$  250

# REZURVARI KOSTURR

KAPASITETI 226.000 M<sup>3</sup> UDE<sup>s</sup>

KANALI VADITES 0.82 KM

PRURJA Q = 70 l/sek

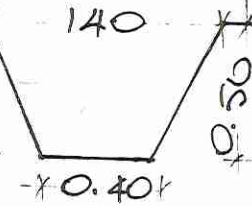

S-T.P KOSTURR.

TYBI BERGIMIT 253 ML

PRURJA 50 l/sek.

KANALI VADITES QITISED. 4.326 KM

