

"Godina e Teatrit Tiranë", Faza I-rë

## PROJEKTI ARKITEKTONIK

---

A&E ENGINEERING



Studio Konsulente  
F&M INGEGNERIA S.p.a.



A-00 Kopertina  
A-01 Pozicionimi i Sheshit  
A-02 Planvendosje  
A-03 Planorganizim  
A-04 Planpiketim  
A-05 Plansistemim  
A-06 Planimetri Kati nentoke -2 Zonim  
A-07 Planimetri Kati nentoke -2 Dyer  
A-08 Planimetri Kati nentoke -2 Teknik  
A-09 Planimetri Kati nentoke -2 Mobilim  
A-10 Planimetri Kati nentoke -2 DysHEME  
A-11 Planimetri Kati nentoke -2 Tavan  
A-12 Planimetri Kati nentoke -1 Zonim  
A-13 Planimetri Kati nentoke -1 Dyer  
A-14 Planimetri Kati nentoke -1 Teknik  
A-15 Planimetri Kati nentoke -1 Mobilim  
A-16 Planimetri Kati nentoke -1 DysHEME  
A-17 Planimetri Kati nentoke -1 Tavan  
A-18 Planimetri Kati perdhe Zonim  
A-19 Planimetri Kati perdhe Levizje  
A-20 Planimetri Kati perdhe Dyer  
A-21 Planimetri Kati perdhe Mobilim  
A-22 Planimetri Kati perdhe Teknik  
A-23 Planimetri Kati perdhe DysHEME  
A-24 Planimetri Kati perdhe Tavan  
A-25 Planimetri Kati perdhe Muratura  
A-26 Planimetri Kati Nenskena Zonim  
A-27 Planimetri Kati Nenskena Levizje  
A-28 Planimetri Kati Nenskena Dyer  
A-29 Planimetri Kati Nenskena Mobilim  
A-30 Planimetri Kati Nenskena Teknik  
A-31 Planimetri Kati Nenskena DysHEME  
A-32 Planimetri Kati Nenskena Tavan  
A-33 Planimetri Kati Nenskena Muratura  
A-34 Planimetri Kati Foyer Zonim  
A-35 Planimetri Kati Foyer Levizje  
A-36 Planimetri Kati Foyer Dyer  
A-37 Planimetri Kati Foyer Mobilim  
A-38 Planimetri Kati Foyer Teknik  
A-39 Planimetri Kati Foyer DysHEME  
A-40 Planimetri Kati Foyer Tavan  
A-41 Planimetri Kati Foyer Muratura  
A-42 Planimetri Kati Mezanina Zonim

A-43 Planimetri Kati Mezanina Levizje  
A-44 Planimetri Kati Mezanina Dyer  
A-45 Planimetri Kati Mezanina Mobilim  
A-46 Planimetri Kati Mezanina Teknik  
A-47 Planimetri Kati Mezanina DysHEME  
A-48 Planimetri Kati Mezanina Tavan  
A-49 Planimetri Kati Mezanina Muratura  
A-50 Planimetri Kati Ambjentet Artistet Zonim  
A-51 Planimetri Kati Ambjentet Artistet Levizje  
A-52 Planimetri Kati Ambjentet Artistet Dyer  
A-53 Planimetri Kati Ambjentet Artistet Mobilim  
A-54 Planimetri Kati Ambjentet Artistet Teknik  
A-55 Planimetri Kati Ambjentet Artistet DysHEME  
A-56 Planimetri Kati Ambjentet Artistet Tavan  
A-57 Planimetri Kati Ambjentet Artistet Muratura  
A-58 Planimetri Kati Kafeteria Zonim  
A-59 Planimetri Kati Kafeteria Levizje  
A-60 Planimetri Kati Kafeteria Dyer  
A-61 Planimetri Kati Kafeteria Mobilim  
A-62 Planimetri Kati Kafeteria Teknik  
A-63 Planimetri Kati Kafeteria DysHEME  
A-64 Planimetri Kati Kafeteria Tavan  
A-65 Planimetri Kati Kafeteria Muratura  
A-66 Planimetri Kati Taraca Zonim  
A-67 Planimetri Kati Taraca Levizje  
A-68 Planimetri Kati Taraca Dyer  
A-69 Planimetri Kati Taraca Mobilim  
A-70 Planimetri Kati Taraca Teknik  
A-71 Planimetri Kati Taraca DysHEME  
A-72 Planimetri Kati Taraca Tavan  
A-73 Planimetri Kati Taraca Muratura  
A-74 Planimetri Mbulimi  
A-75 Prerja A-A  
A-76 Prerja A-A Evakuim  
A-77 Prerja B-B  
A-78 Prerja B-B Evakuim  
A-79 Prerja C-C  
A-80 Prerja C-C Evakuim  
A-81 Prerja D-D  
A-82 Prerja D-D Evakuim  
A-83 Prerja E-E  
A-84 Prerja E-E Evakuim  
A-85 Prerja F-F  
A-86 Prerja F-F Evakuim

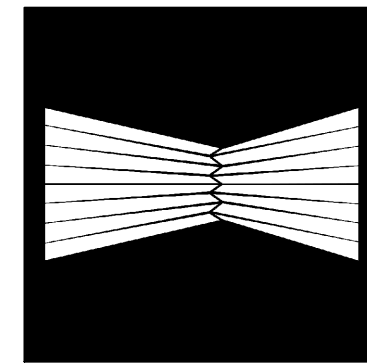

**"Godina e Teatrit Tiranë", Faza I-rë**

**Lista e Vizatimeve**

A-87 Pamje Veriore  
A-88 Pamje Jugore  
A-89 Pamje Lindore  
A-90 Pamje Perendimore  
A-91 Pamje|Prerje 1-1  
A-92 Pamje|Prerje 2-2  
A-93 Planimetri Shkalla kryesore  
A-94 Plan Tavani Shkalla Kryesore  
A-95 Plan Paradhoma  
A-96 Prerje Para dhoma  
A-97 Plan pjesshem I shkalles  
A-98 Pamje|Prerje Shkalla kryesore  
A-99 Aksonometri e Shkalles  
A-100 Prerje Shkalla 3-4  
A-101 Plan kati tip shkalla 3-4  
A-102 Plan Shkallare Taraca  
A-103 Pamje 1-1 Shkallare Taraca  
A-104 Pamje 2-2 Shkallare Taraca  
A-105 Pamje 3-3 Shkallare Taraca  
A-106 Pamje 4-4 Shkallare Taraca  
A-107 Detaj Xhameria Taraca  
A-108 Planimetri Holli  
A-109 Plan Tavani Holli  
A-110 Pamja 1-1 Holli  
A-111 Pamja 2-2 Holli  
A-112 Pamja 3-3 Holli  
A-113 Pamja 4-4 Holli  
A-114 Detaj Biletaria  
A-115 Planimetri Foyer  
A-116 Plan Tavani Foyer  
A-117 Pamja 1-1 Foyer  
A-118 Pamja 2-2 Foyer  
A-119 Pamja 3-3 Foyer  
A-120 Pamja 4-4 Foyer  
A-121 Planimetri Big Black Box  
A-122 Plan Urat e levizjes Big Black Box  
A-123 Plan Tavani Big Black Box  
A-124 Prerja 1-1 Big Black Box  
A-125 Prerja 2-2 Big Black Box  
A-126 Prerja 3-3 Big Black Box  
A-127 Planimetri Small Black Box  
A-128 Plan Urat e levizjes Small Black Box  
A-129 Plan Tavani Small Black Box  
A-130 Prerja 1-1 Small Black Box

A-131 Prerja 2-2 Small Black Box  
A-132 Prerja 3-3 Small Black Box  
A-133 Prerja 4-4 Small Black Box  
A-134 Planimetri Subfoyer 1  
A-135 Plan Tavani Subfoyer 1  
A-136 Pamja 1-1 Subfoyer 1  
A-137 Pamja 2-2 Subfoyer 1  
A-138 Pamja 3-3 Subfoyer 1  
A-139 Pamja 4-4 Subfoyer 1  
A-140 Planimetri Subfoyer 2  
A-141 Plan Tavani Subfoyer 2  
A-142 Pamja 1-1 Subfoyer 2  
A-143 Pamja 2-2 Subfoyer 2  
A-144 Pamja 3-3 Subfoyer 2  
A-145 Pamja 4-4 Subfoyer 2  
A-146 Planimetri Salla Polivalente  
A-147 Plan Urat e levizjes Salla Polivalente  
A-148 Plan Tavani Salla Polivalente  
A-149 Pamja 1-1 Salla Polivalente  
A-150 Pamja 2-2 Salla Polivalente  
A-151 Pamja 3-3 Salla Polivalente  
A-152 Pamja 4-4 Salla Polivalente  
A-153 Planimetri Skena  
A-154 Prerja 1-1 Skena  
A-155 Pamja 2-2 Skena  
A-156 Aksonometri Skena  
A-157 Planimetri Lozhat  
A-158 Plan Tavani Lozhat  
A-159 Planimetri Ballkoni  
A-160 Plan Tavani Ballkoni  
A-161 Tualet Niveli 3 01  
A-162 Tualet Niveli 3 02  
A-163 Tualet Niveli 3 03  
A-164 Tualet Niveli 3 04  
A-165 Tualet Niveli 3 05  
A-166 Tualet Niveli 3 06  
A-167 Tualet Niveli 3 07  
A-168 Tualet Niveli 3 08  
A-169 Tualet Niveli 3 09  
A-170 Tualet Niveli 3 10  
A-171 Tualet Niveli 3 11  
A-172 Tualet Niveli 3 12  
A-173 Tualet Niveli 3 13  
A-174 Tualet Niveli 3 14

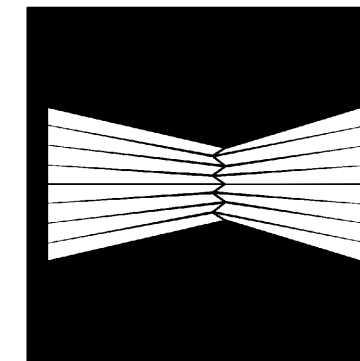

**"Godina e Teatrit Tiranë", Faza I-rë**

**Lista e Vizatimeve**

A-175 Tualet Nivel 4 01  
A-176 Tualet Nivel 4 02  
A-177 Tualet Nivel 4 03  
A-178 Tualet Nivel 4 04  
A-179 Tualet Nivel 4 05  
A-180 Tualet Nivel 4 06  
A-181 Tualet Nivel 4 07  
A-182 Tualet Nivel 4 08  
A-183 Tualet Nivel 4 09  
A-184 Tualet Nivel 4 10  
A-185 Tualet Nivel 4 11  
A-186 Tualet Nivel 4 12  
A-187 Tualet Nivel 4 13  
A-188 Tualet Nivel 4 14  
A-189 Plan Holli Nentoke  
A-190 Plan Tavani Holli Nentoke  
A-191 Pamje 1-1 Holli Nentoke  
A-192 Pamje 2-2 Holli Nentoke  
A-193 Pamje 3-3 Holli Nentoke  
A-194 Pamje 4-4 Holli Nentoke  
A-195 Tabela Dyer Dritare 1  
A-196 Tabela Dyer Dritare 2  
A-197 Tabela Dyer Dritare 3  
A-198 Tabela Dyer Dritare 4  
A-199 Tabela Dyer Dritare 5  
A-200 Tabela Dyer Dritare 6  
A-201 Tabela Dyer Dritare 7  
A-202 Tabela Dyer Dritare 8  
A-203 Tabela Dyer Dritare 9  
A-204 Tabela Dyer Dritare 10  
A-205 Tabela Dyer Dritare 11  
A-206 Tabela Dyer Dritare 12  
A-207 Tabela Dyer Dritare 13  
A-208 Tabela Dyer Dritare 14  
A-209 Tabela Dyer Dritare 15  
A-210 Tabela Dyer Dritare 16  
A-211 Tabela Dyer Dritare 17  
A-212 Tabela Dyer Dritare 18  
A-213 Tabela Dyer Dritare 19  
A-214 Tabela Dyer Dritare 20  
A-215 Tabela Dyer Dritare 21  
A-216 Tabela Dyer Dritare 22  
A-217 Tabela Dyer Dritare 23  
A-218 Tabela Dyer Dritare 24

A-219 Tabela Dyer Dritare 25  
A-220 Tabela Dyer Dritare 26  
A-221 Tabela Dyer Dritare 27  
A-222 Tabela Dyer Dritare 28  
A-223 Tabela Dyer Dritare 29  
A-224 Tabela Dyer Dritare 30  
A-225 Detaj 1  
A-226 Detaj 2  
A-227 Detaj 3  
A-228 Detaj 4  
A-229 Detaj 5  
A-230 Detaj 6  
A-231 Detaj 7  
A-232 Detaj 8  
A-233 Detaj 9  
A-234 Detaj 10  
A-235 Detaj 11  
A-236 Detaj 12  
A-237 Detaj 13  
A-238 Detaj 14  
A-239 Detaj 15  
A-240 Detaj 16  
A-241 Detaj 17  
A-242 Detaj 18  
A-243 Detaj 19  
A-244 Detaj 20  
A-245 Detaj 21  
A-246 Detaj 22  
A-247 Detaj 23  
A-248 Detaj 24  
A-249 Detaj 25  
A-250 Detaj 26  
A-251 Detaj 27  
A-252 Detaj 28  
A-253 Detaj 29  
A-254 Detaj 30  
A-255 Detaj 31  
A-256 Detaj 32  
A-257 Detaj 33  
A-258 Detaj 34  
A-259 Detaj 35  
A-260 Detaj 36  
A-261 Detaj 37  
A-262 Detaj 38

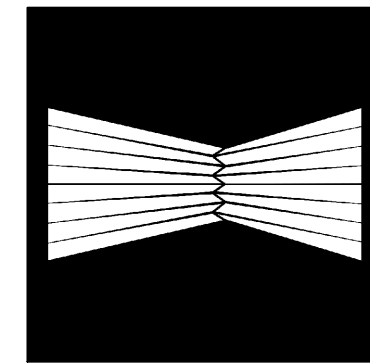

**"Godina e Teatrit Tiranë", Faza I-rë**

**Lista e Vizatimeve**



A-263 Detaj 39  
A-264 Detaj 40  
A-265 Detaj 41  
A-266 Detaj 42  
A-267 Detaj 43  
A-268 Detaj 44  
A-269 Detaj 45  
A-270 Detaj 46  
A-271 Detaj 47  
A-272 Detaj 48  
A-273 Detaj 49  
A-274 Detaj 50  
A-275 Detaj 51  
A-276 Detaj 52  
A-277 Detaj 53  
A-278 Detaj 54  
A-279 Detaj 55  
A-280 Detaj 56  
A-281 Detaj 57  
A-282 Detaj 58  
A-283 Detaj 59  
A-284 Detaj 60  
A-285 Detaj 61  
A-286 Detaj 62  
A-287 Vizualizim 1  
A-288 Vizualizim 2  
A-289 Vizualizim 3  
A-290 Vizualizim 4  
A-291 Vizualizim 5  
A-292 Vizualizim 6  
A-293 Vizualizim 7  
A-294 Vizualizim 8  
A-295 Vizualizim 9  
A-296 Vizualizim 10  
A-297 Vizualizim 11  
A-298 Vizualizim 12  
A-299 Vizualizim 13  
A-300 Vizualizim 14  
A-301 Vizualizim 15  
A-302 Vizualizim 16  
A-303 Vizualizim 17  
A-304 Vizualizim 18  
A-305 Vizualizim 19  
A-306 Vizualizim 20

A-307 Vizualizim 21  
A-308 Vizualizim 22  
A-309 Vizualizim 23  
A-310 Vizualizim 24  
A-311 Vizualizim 25  
A-312 Vizualizim 26  
A-313 Vizualizim 27  
A-314 Vizualizim 28  
A-315 Vizualizim 29  
A-316 Vizualizim 30  
A-317 Vizualizim 31  
A-318 Vizualizim 32  
A-319 Vizualizim 33  
A-320 Vizualizim 34  
A-321 Vizualizim 35  
A-322 Vizualizim 36  
A-323 Vizualizim 37  
A-324 Vizualizim 38  
A-325 Vizualizim 39  
A-326 Vizualizim 40  
A-327 Vizualizim 41  
A-328 Vizualizim 42  
A-329 Vizualizim 43  
A-330 Vizualizim 44  
A-331 Vizualizim 45  
A-332 Vizualizim 46  
A-333 Vizualizim 47  
A-334 Vizualizim 48  
A-335 Vizualizim 49  
A-336 Vizualizim 50  
A-337 Vizualizim 51  
A-338 Vizualizim 52

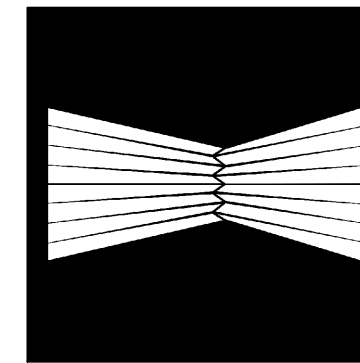

**"Godina e Teatrit Tiranë", Faza I-rë**

**Lista e Vizatimeve**



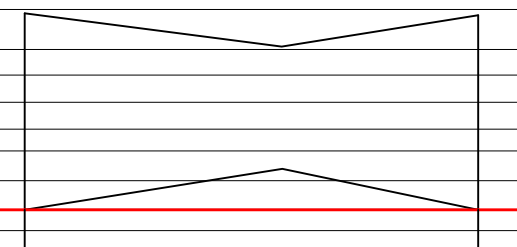
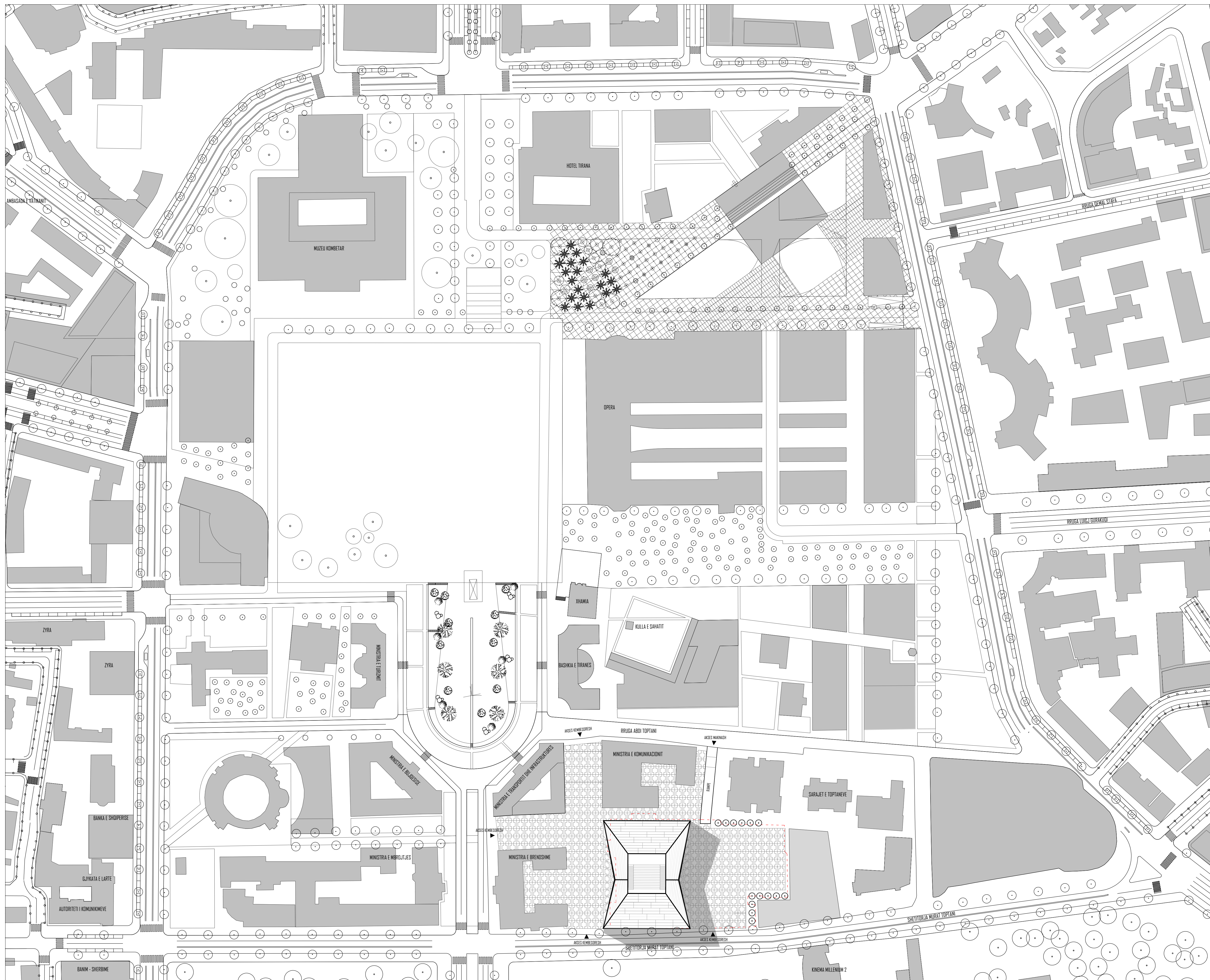
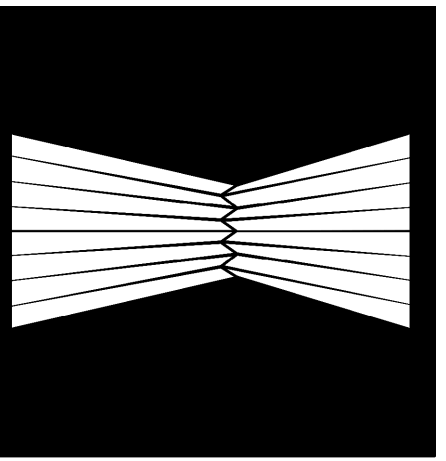

 A&E ENGINEERING sh.p.k.

 Studio Konsulente  
F&M INGEGNERIA S.p.a.  
Via Belvedere 8/10  
30035 Mirano (VE)  
tel 041-5785711  
fax 041-4355933

ark.	F. KAJMANKU
ark.	G. ZOTO
ing.	M. HALILAJ
ing.	E. CANO
ing.	V. HOXHA
ing.	D. BUZI
ing.	E. CANO
ark.	N. DASHI
geohid.	V. AVDA
ark.	V. HOXHA
ing.	A. BONAVENTURA
ing.	A.C. NUZZO
ing.	G. CHARALAMPOPOULOS
ing.	A. MAGRINI

PROJEKT  
"Godina e Teatrit Tiranë", Faza I-rë

PROJEKTI ARKITEKTONIK

EMERTIM  
POZICIONIMI I SHESHIT

A01

DATA: 01/11/2011  
SHKALLA: 1:1000



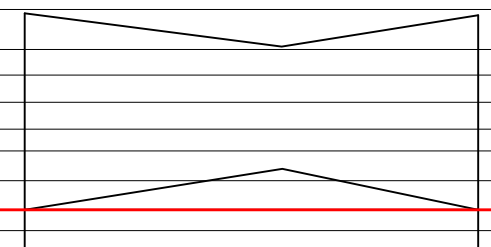
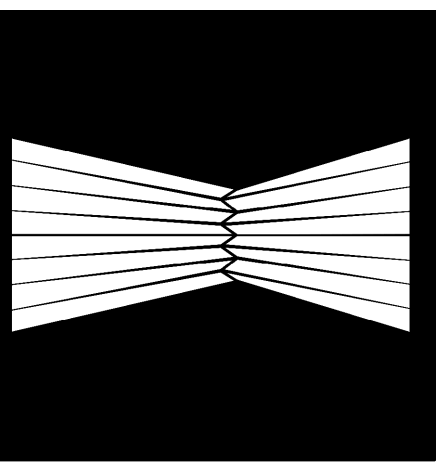

A&E ENGINEERING sh.p.k.

Studio Konsulente  
**F&M INGEENIERIA S.p.a.**  
Via Belvedere 8/10  
30035 Mirano (VE)  
tel 041-5785711  
fax 041-4355933

ark.	P. KAJMANKU
ark.	O. ZOTO
ing.	M. HALILAJ
ing.	E. CANO
ing.	V. HOXHA
ing.	D. BUZI
ing.	E. CANO
ark.	N. DASHI
geohid.	V. AVDA
ark.	V. HOXHA
ing.	A. BONAVENTURA
ing.	A.C. NUZZO
ing.	G. CHARALAMPOPOULOS
ing.	A. MAGRINI

PROJEKT "Godina e Teatrit Tiranë", Faza I-rë

PROJEKTI ARKITEKTONIK

EMERTIMI PLANVENDOSJA

BRIGJADA A02

DATA: 1:250





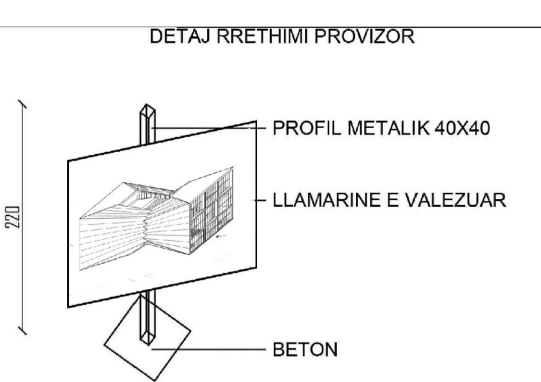
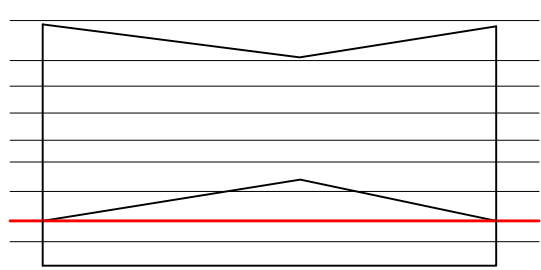
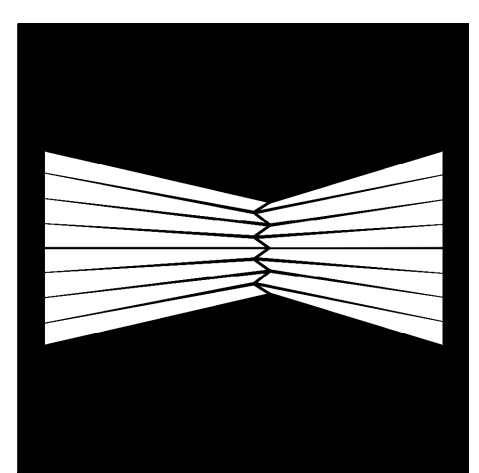

- LEGJENDA**
- 1- Kufiri i pronës
  - 2- Rrethimi provizor, kolona metalike + rrjete metalike h=2m
  - 3- Hyrja per ne kantier
  - 3'- Hyrje dytesore per ne kantier
  - 4- Vinc 10 ton
  - 5- Dhome per roje
  - 6- Zyre
  - 7- WC
  - 8- Tavoline per pergatjen e hekurit
  - 9- Grupe gajgere
  - 10- Grumbullim rere
  - 11- Grumbullim hullash
  - 12- Vend grumbullimi inertesh
  - 13- Ambulance

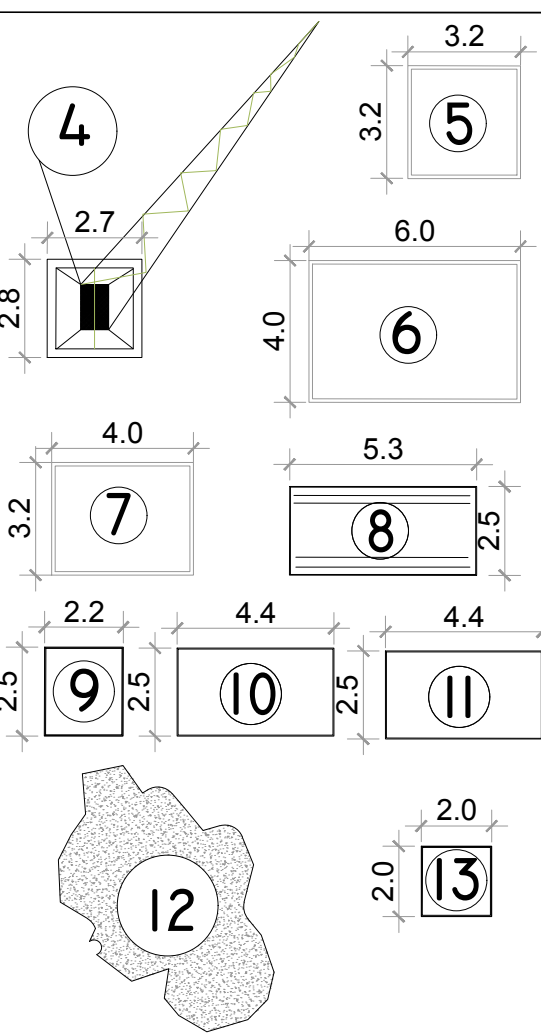

**A&E ENGINEERING** sh.p.k

**F&M ingegneria** Studio Konsulente  
**F&M INGENGERIA S.p.a.**  
 Via Belvedere 8/10  
 30035 Mirano (VE)  
 tel 041-5785711  
 fax 041-4355933

ark.	P. KAJMANKU
ark.	O. ZOTO
ing.	M. HALILAJ
ing.	E. CANO
ing.	V. HOXHA
ing.	D. BUZI
ing.	E. CANO
ark.	N. DASHI
geohid.	V. AVDA
elek.	V. HOXHA
ing.	A. BONAVENTURA
ing.	A.C. NUZZO
ing.	G. CHARALAMPOPOULOS
ing.	A. MAGRINI

PROJEKTI "Godina e Teatrit Tiranë", Faza I-rë

PROJEKTI ARKITEKTONIK

PLANORGANIZIMI

BRIGJADA A03

DATA: 1:250



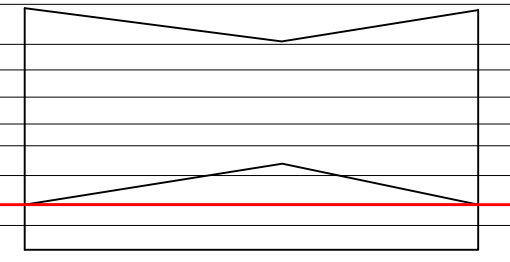
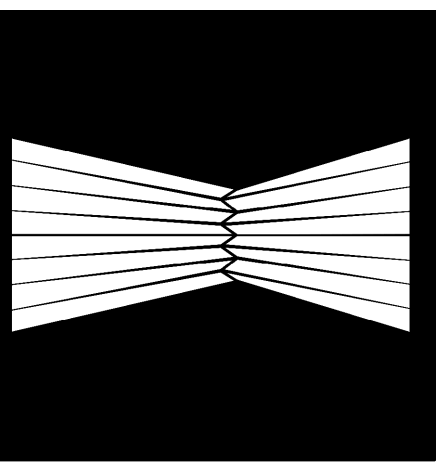

Piketimi i objektit është realizuar duke marrë si pikë referimi pikën T1 me koordinata  $x=0,00$  dhe  $y=0,00$  në objektin ekzistues, në të majtë të sheshit tonë. Boshti (Y) të vendoset përgjatë faqes të drejtë të objektit ekzistues 3k, ndërsa boshti (X) të vendoset pingul me boshtin (Y). Kuota  $\pm 0,00$  e objektit përkon me kuotën  $+97,67$  të terrenit.

Pikat "A" i referohen këndeve të Objektit.

Emertimi	X	Y
A1	-2236.481	640.6918
A2	-2095.861	-0.6428
A3	-7095.296	31.6021
A4	-6946.296	671.0998
A5	-5673.335	1882.1865
A6	-3493.381	1868.1121
A7	-3481.215	3752.4947
A8	-5661.169	3766.5691
A9	-6915.120	5499.9892
A10	-7055.199	6231.5053
A11	-2055.805	6199.2201
A12	-2205.512	5468.5719

A&E ENGINEERING sh.p.k

Studio Konsulente  
F&M INGEGNERIA S.p.a.  
Via Belvedere 8/10  
30035 Mirano (VE)  
tel 041-5785711  
fax 041-4355933

ark.	P. KAJMANKU
ark.	O. ZOTO
ing.	M. HALILAJ
ing.	E. CANO
ing.	V. HOXHA
ing.	D. BUZI
ing.	E. CANO
ark.	N. DASHI
geohid.	V. AVDA
elek.	V. HOXHA
ing.	A. BONAVENTURA
ing.	A.C. NUZZO
ing.	G. CHARALAMPOPOULOS
ing.	A. MAGRINI

PROJEKTI "Godina e Teatrit Tiranë", Faza I-rë

PROJEKTI ARKITEKTONIK

PLANPIKETIMI

A04

DATA: 01/12/2010

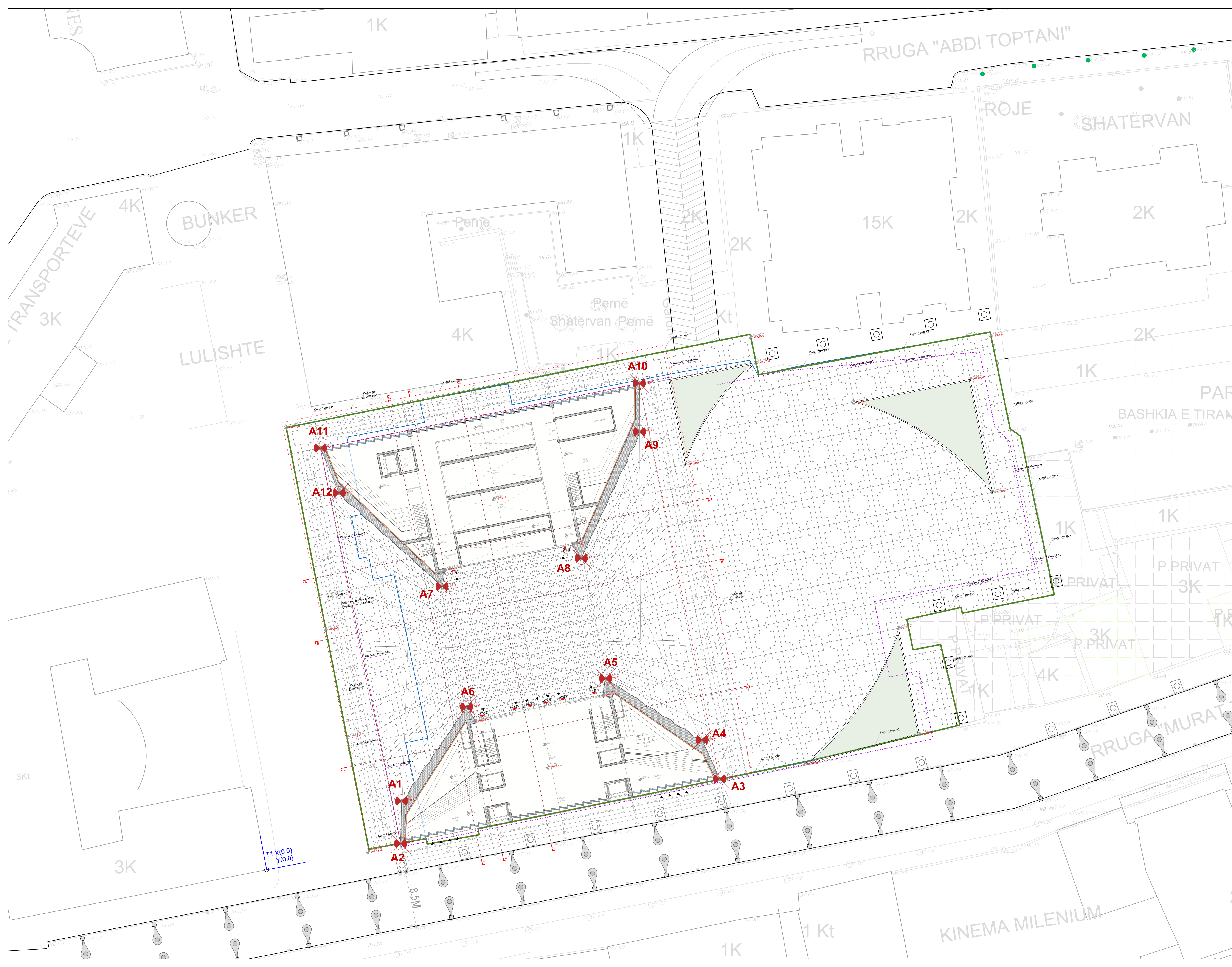



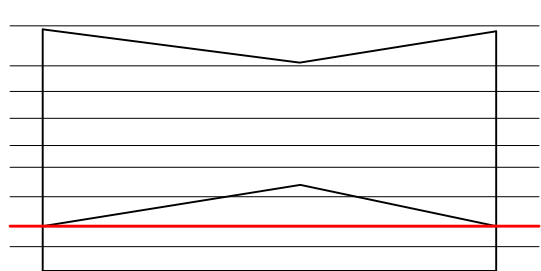
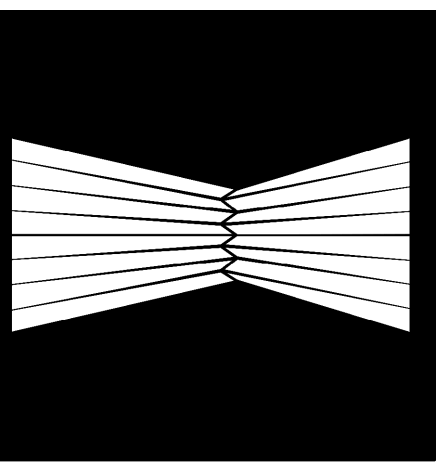

**LEGJENDA**

- Gjelbërim i ulët / Bar
- Trotuar me pllaka qartë të ngjashme me ekzistueset
- Rrugë automobilistike
- Gjelbërim i mesëm / Shikurre
- Gjelbërim i lartë / Pemë
- Pusete e ujërave të bardha
- Ndriçues
- Kosh mbeturinash
- Ndriçues linear në sistemin
- Kallim për zjarrfikëset
- Kufiri i Nentokës
- Kufiri i Pronës

**A&E ENGINEERING sh.p.k**

**F&M** ingegneria

Studio Konsulente  
**F&M INGENGERIA S.p.a.**  
 Via Belvedere 8/10  
 30035 Mirano (VE)  
 tel 041-5785711  
 fax 041-4355933

ark.	P. KAJMARI
ark.	O. ZOTO
ing.	M. HALILAJ
ing.	E. CANO
ing.	V. HOXHA
ing.	D. BUZI
ing.	E. CANO
ing.	N. DASHI
geohid.	V. AVDA
elek.	V. HOXHA
ing.	A. BONAVENTURA
ing.	A.C. NUZZO
ing.	G. CHARALAMPOPOULOS
ing.	A. MAGRINI

PROJEKTI

**"Godina e Teatrit Tiranë", Faza I-rë**

PROJEKTI ARKITEKTONIK

EMERTIMI

**PLANSISTEMIMI**

DATA

1:250

**A05**



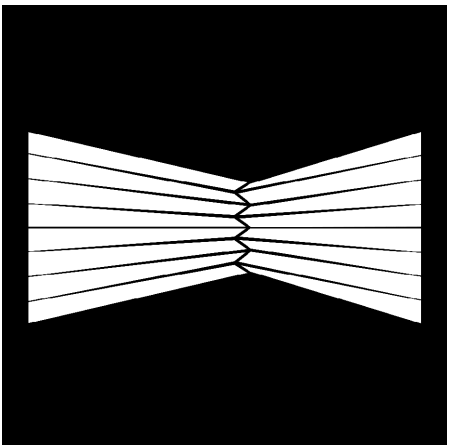

- Parkim
- Depo
- Lëvizje
- Hapësira Teknike
- Performim/Workshop
- Dhoma për stafin

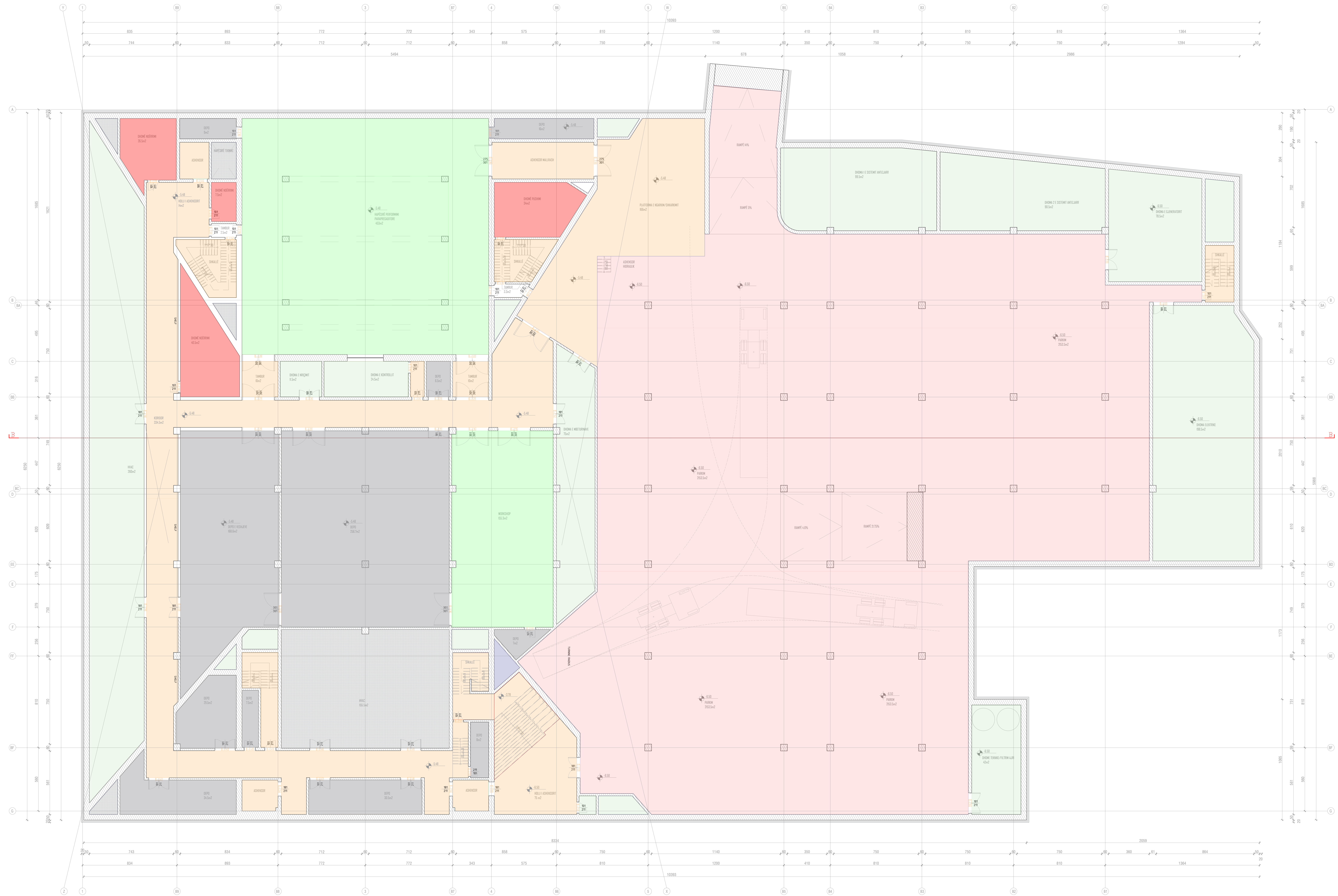

**A&E ENGINEERING** sh.p.k.

**F&M Ingegneria**  
 Studio Konsulente  
 F&M INGEGNERIA S.p.A.  
 Via Solvatore B10  
 30035 Mirano (VE)  
 tel 041-43592711  
 fax 041-4359333

AR.	P. KAJMARI
AR.	D. ZOTI
PR.	M. HALLAJ
PR.	E. GANDI
PR.	V. HODHA
PR.	D. BULLI
PR.	E. GANDI
PR.	N. DASHI
PR.	V. HODHA
PR.	V. HODHA
PR.	A. BISHI
PR.	A. BISHI
PR.	G. HALLAJ
PR.	A. HALLAJ

Projekti: "Godina e Teatrit Tirane", Faza I-rë

PROJEKTI ARKITEKTONIK

Kati -2 Zonim

A-06































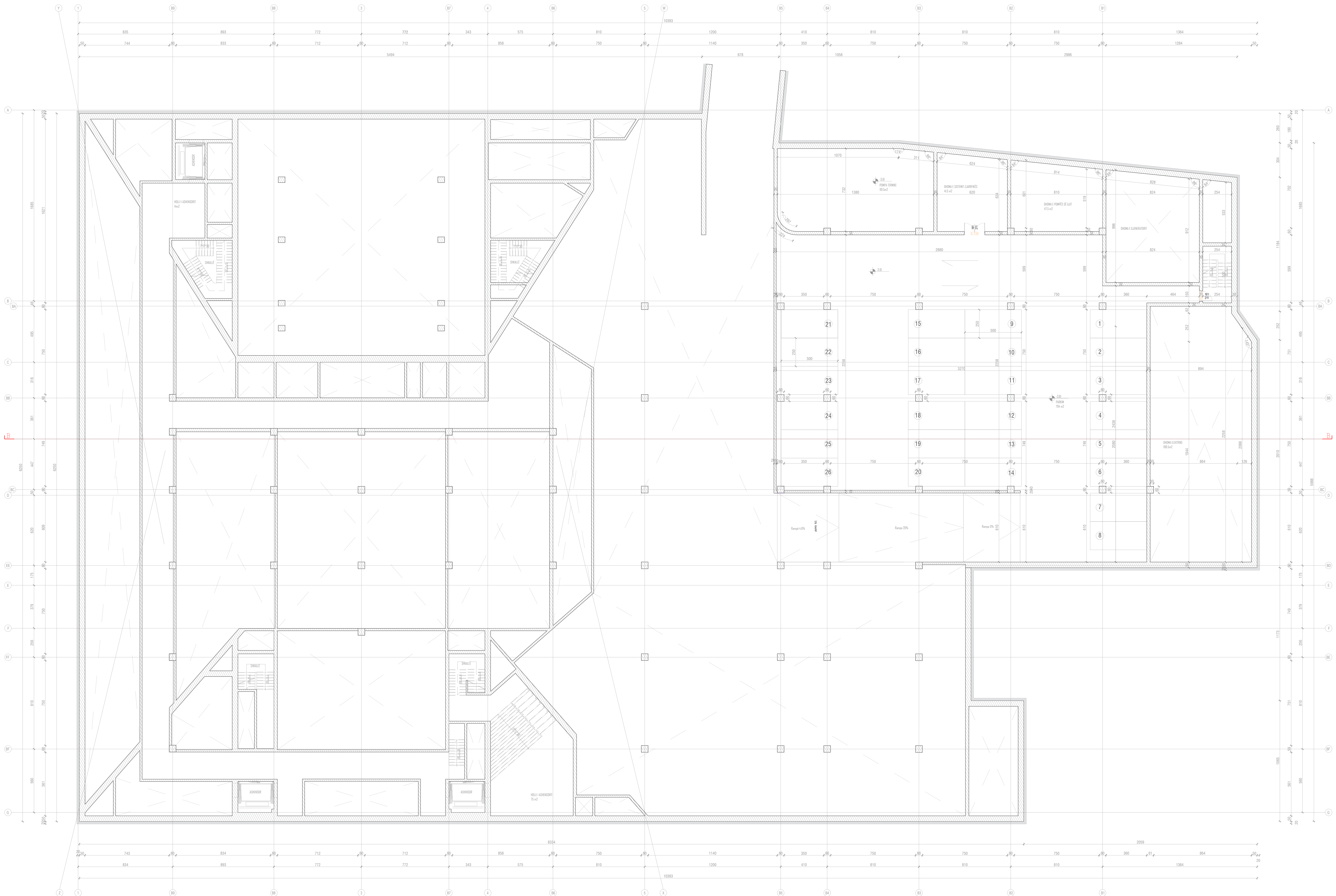
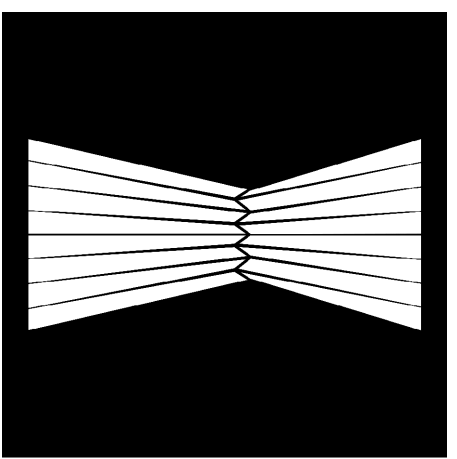

A&E ENGINEERING s.p.a.

**F&M**  
ingegneria

Studio Consulente  
F&M INGEGNERIA S.p.A.  
Via Solvatore 1/10  
30035 Mirano (VE)  
tel. 041-5782711  
fax 041-4355933

PROGETTO  
"Godina e Teatrit Tirana", Faza I-ré

PROJEKTI ARHITEKTONIK

Kati-1 Teknik

A-14



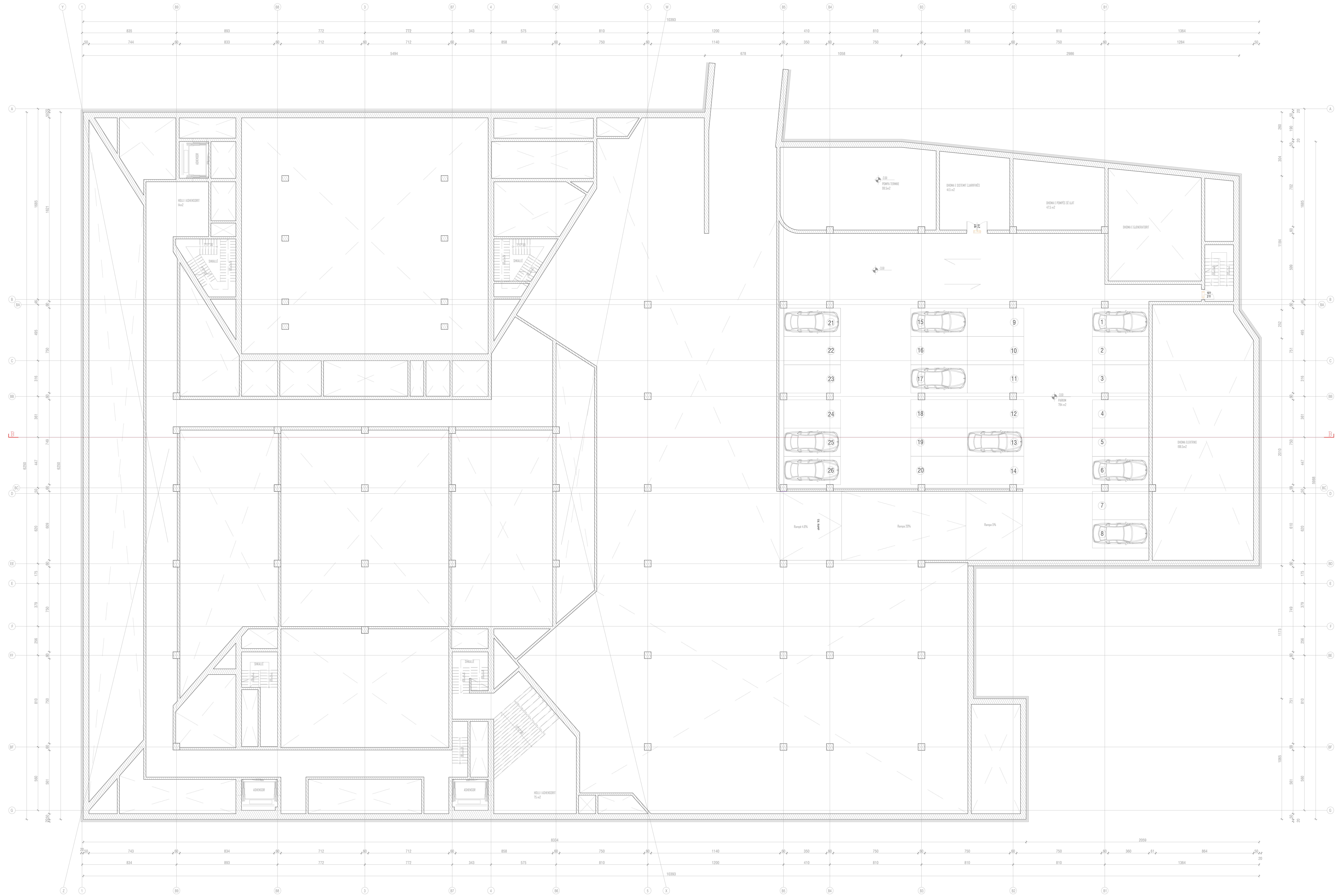
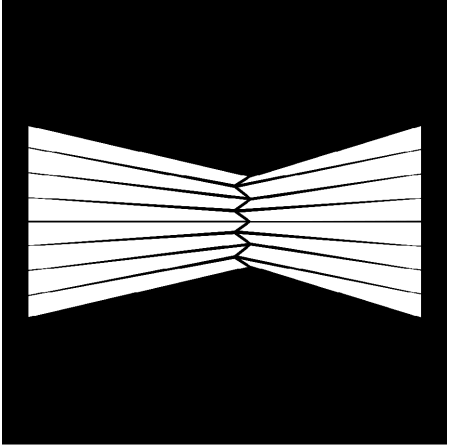

A&E ENGINEERING sh.p.k.

**F&M**  
Ingegneria  
Studio Konsultivo  
F&M INGEGNERIA S.p.A.  
Via Solvatore B10  
30035 Mirano (VE)  
tel 041-5782711  
fax 041-4355933

AR.	P. KAJMUKU
AR.	D. ZOTU
PR.	M. SHALAJI
PR.	E. GANO
PR.	V. HODHA
PR.	D. BUZO
PR.	E. GANO
PR.	N. DASHI
PR.	V. SHAN
PR.	V. HODHA
PR.	A. BISHMIREVURA
PR.	A. E. NUGOZI
PR.	G. CHALAMPOPOULOS
PR.	A. MANDINI

PROJEKT  
"Godina e Teatrit Tirane", Faza I-rë

PROJEKTI ARKITEKTONIK

OBJEKTI  
Kati -1 Mobilim

DATA  
SHEKILLI  
TITULLI



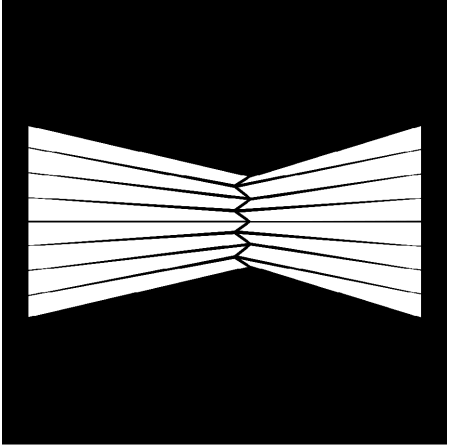

431.100 - Beton i fshirë

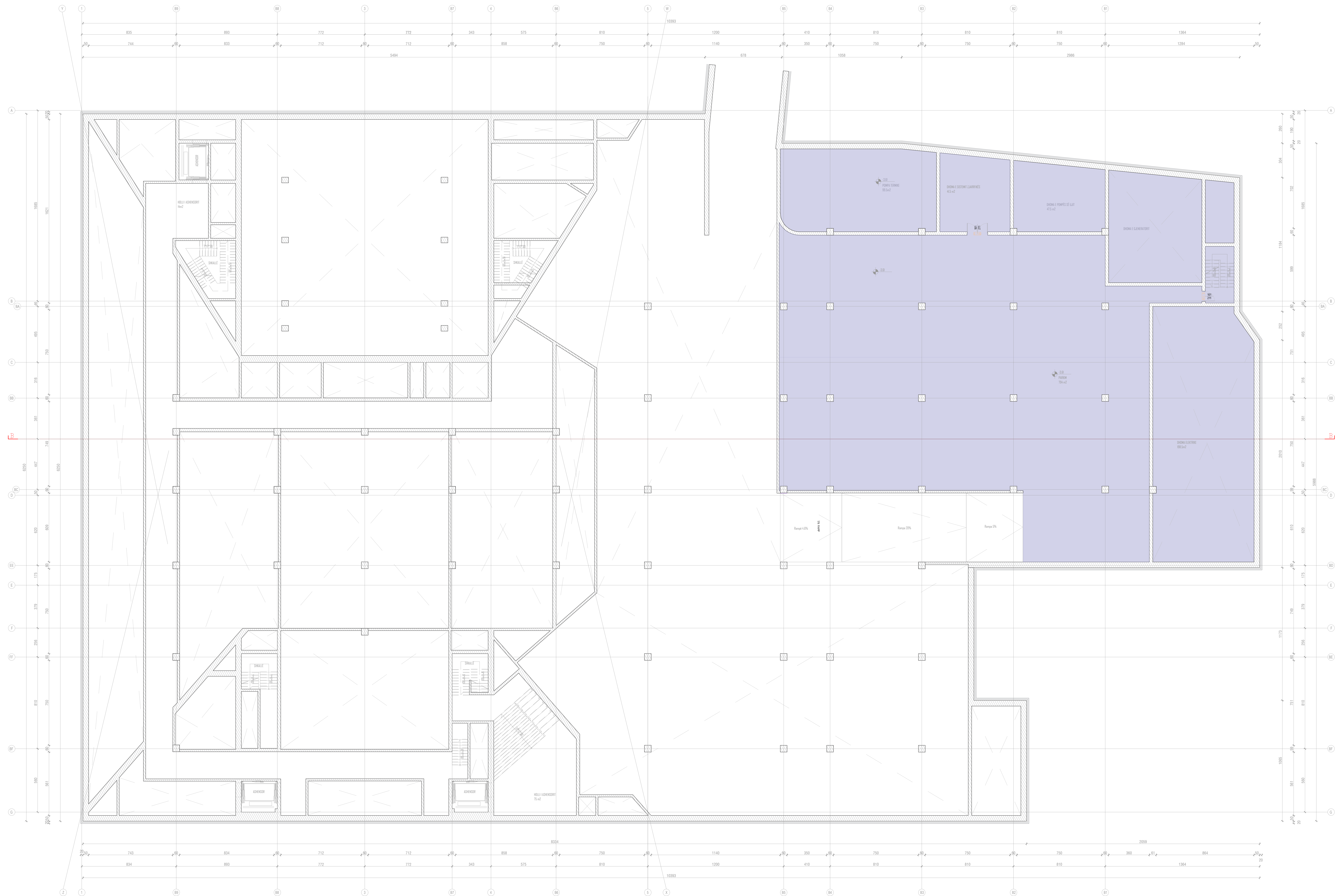

A&E ENGINEERING sh.p.k

**F&M**  
Ingegneria  
Studio Konsulente  
F&M INGEGNERIA S.p.A.  
Via Selvetore 8/10  
30035 Mirano (VE)  
tel 041-5782711  
fax 041-4355933

AR.	P. KAJMARI
AR.	D. ZOTU
PR.	M. HALLAJI
PR.	E. GANO
PR.	V. HODHA
PR.	D. BUZO
PR.	E. GANO
PR.	N. DASHI
PR.	V. HODHA
PR.	A. BASHKIRI
PR.	A. E. NIGRO
PR.	G. CHALAMPOPOULOS
PR.	A. NAGINI

"Godina e Teatrit Tirane", Faza I-rë

PROJEKTI ARKITEKTONIK

Kati -1 Dysheve

A-16



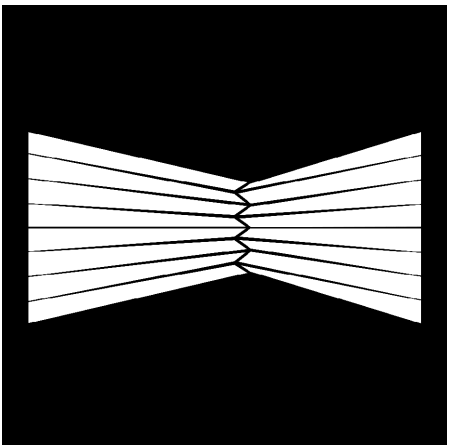

431.100 - Beton i fshirë

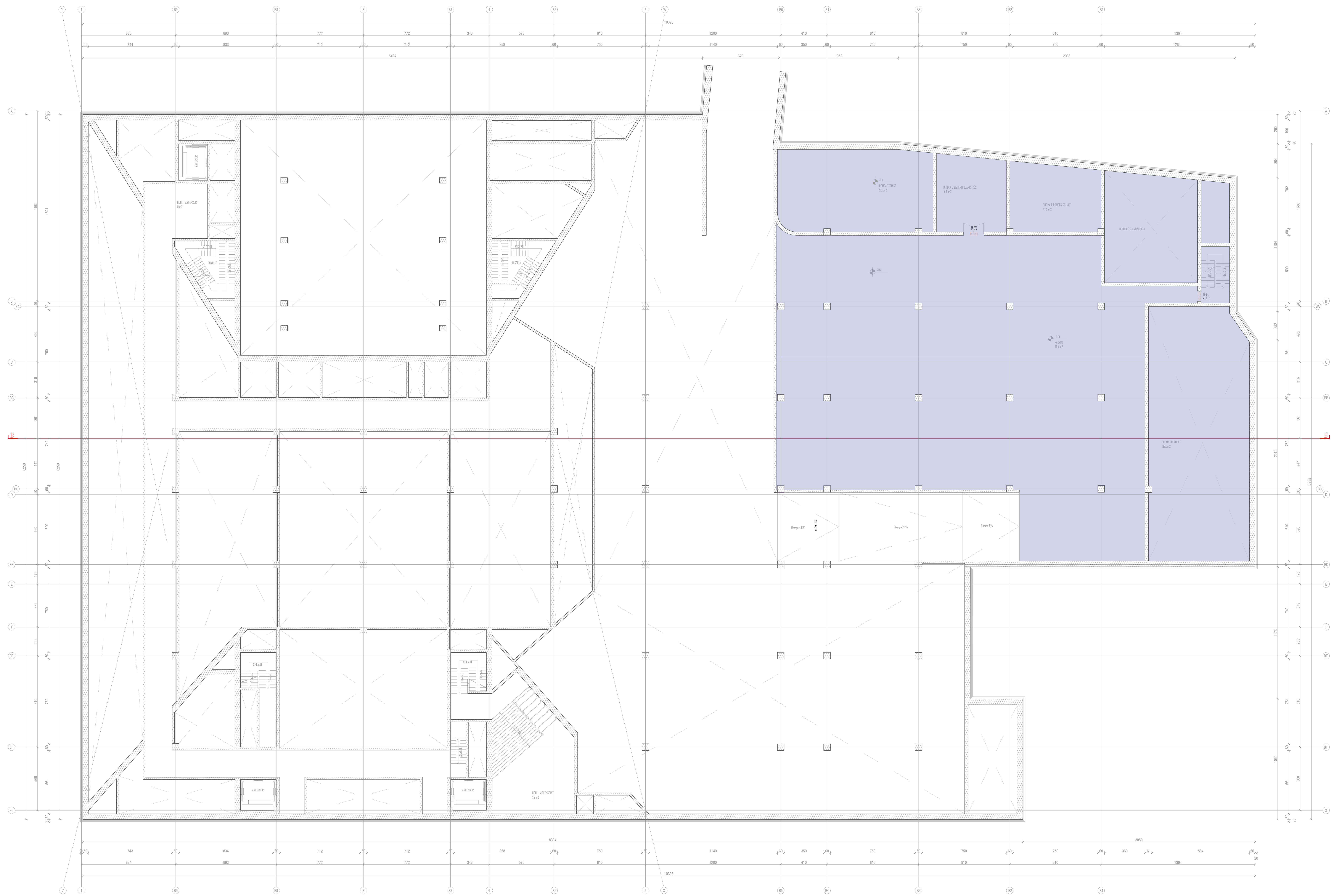

A&E ENGINEERING sh.p.k.

Studio Konsulent F&M INGEGNERIA S.p.A. Via Selvetore 8/10 30035 Mirano (VE) tel 041-5782711 fax 041-4355933

AR.	P. KAJMUKU
AR.	D. ZOTU
PR.	M. HALLAJI
PR.	E. GANDI
PR.	V. HODNA
PR.	D. BUZZI
PR.	E. GANDI
PR.	N. DASHI
PR.	V. HODNA
PR.	V. HODNA
PR.	A. BONDAREVSKA
PR.	A. E. NIKOLAI
PR.	G. CHALAMPOPOULOS
PR.	A. MANGINI

"Godina e Teatrit Tirane", Faza I-rë

PROJEKTI ARKITEKTONIK

Kati -1 Tavani

A-17



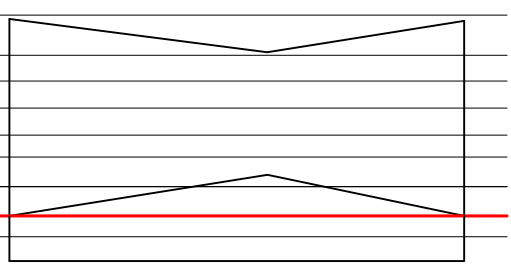
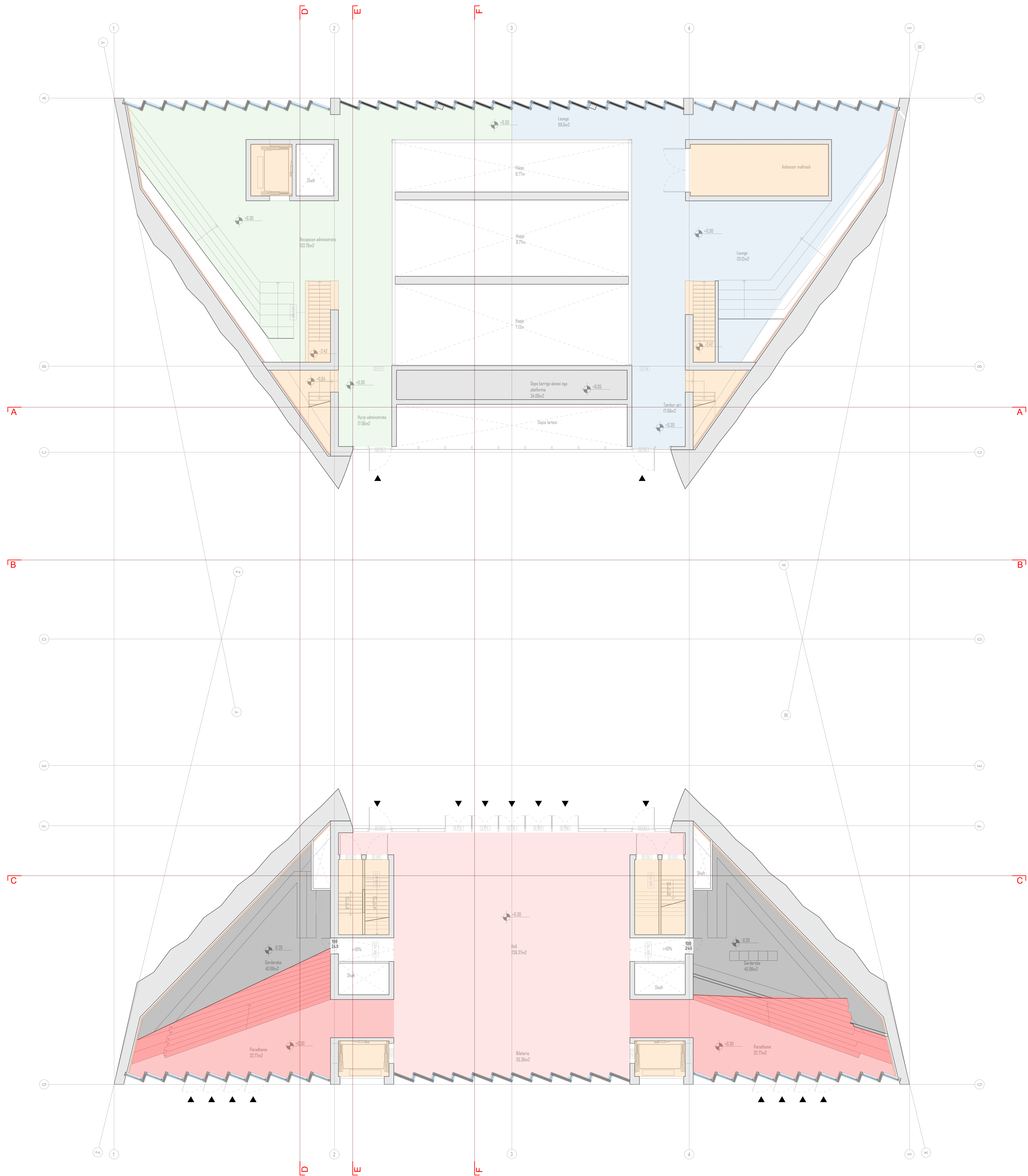
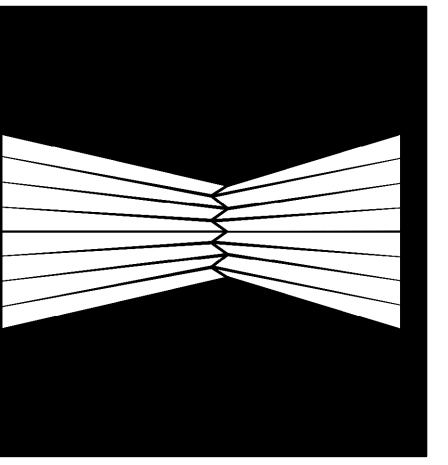

Nr	Emertimi	Siperfaqe
1.07	Hyrje Administrative	17,06 m <sup>2</sup>
1.08	Reception Admin	133,76 m <sup>2</sup>
1.11	Tambur Ajri	17,08 m <sup>2</sup>
1.02	Parathome 1	32,77 m <sup>2</sup>
1.05	Parathome 2	32,79 m <sup>2</sup>
1.12	Depo karrigesh	34,08 m <sup>2</sup>
1.01	Garderobe 1	40,98 m <sup>2</sup>
1.06	Garderobe 2	40,98 m <sup>2</sup>
1.03	Holl	236,37 m <sup>2</sup>
1.10	Lounge	121,12 m <sup>2</sup>
1.04	Biletaria	35,36 m <sup>2</sup>
1.09	Lounge	98,60 m <sup>2</sup>

**A&E ENGINEERING** sh.p.k

**F&M ingegneria** Studio Konsulente  
F&M INGEGNERIA S.p.a.  
Via Belvedere 8/10  
30035 Mirano (VE)  
tel 041-5785711  
fax 041-4355933

ark.	P. KAJMAKU	
ark.	D. ZOTO	
ing.	M. HAKLALAJ	
ing.	E. CANDO	
ing.	V. HOXHA	
ing.	D. BULEZ	
ing.	E. CANDO	
ing.	N. DASHI	
ing.	V. AVDA	
ark.	V. HOXHA	
ing.	A. BONAVENTURA	
ing.	A. CALLEZZO	
ing.	G. CHARALAMPOPOULOS	
ing.	A. MAGRINI	

PROJEKTI  
"Godina e Teatrit Tirane", Faza I-R8

PROJEKTI ARKITEKTONIK

EMERTIMI  
Planimetri Zonim Kati Perdhe

A18

DATA 2021 1:100



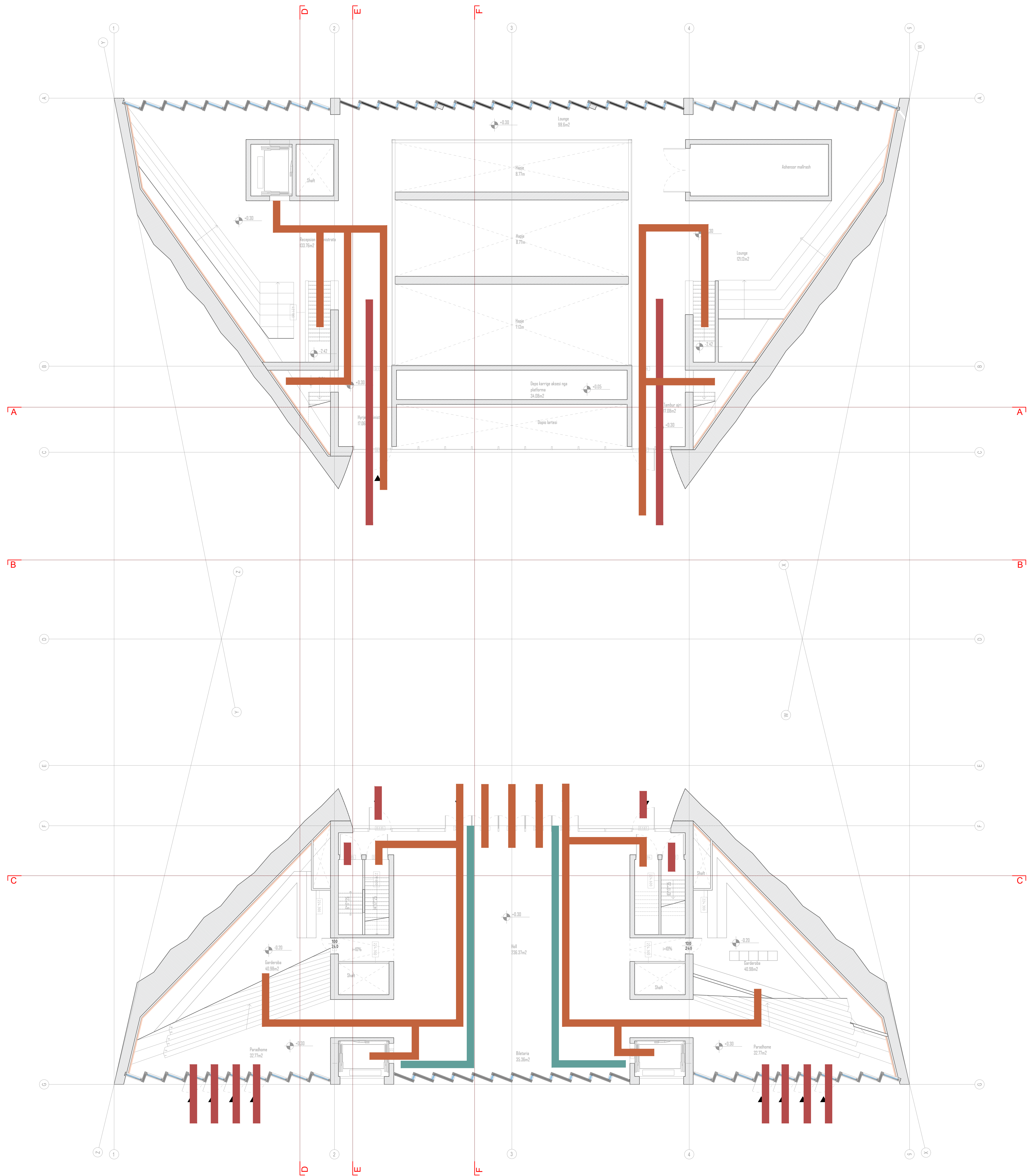
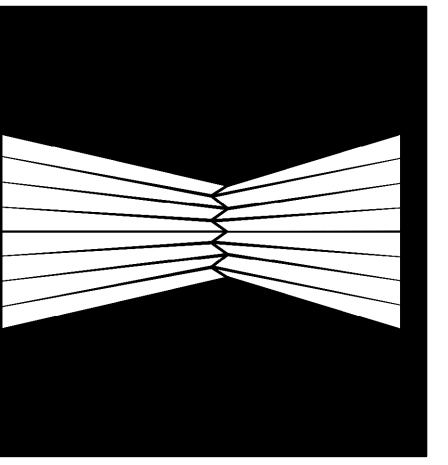

LEGJENDA

- Spektoret —
- PAK —
- Staf —
- Aktoret —
- Daljet e emergjences —

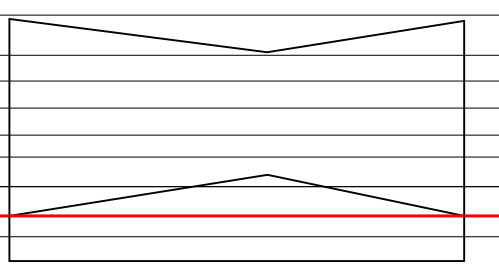

Nr	Emertimi	Siperfaqe
<b>Niveli 01</b>		
1.07	Hyrje Administrative	17,06 m <sup>2</sup>
1.08	Reception Admin	133,76 m <sup>2</sup>
1.11	Tambur Ajri	17,08 m <sup>2</sup>
1.02	Paradhome 1	32,77 m <sup>2</sup>
1.05	Paradhome 2	32,79 m <sup>2</sup>
1.12	Depo karrigesh	34,08 m <sup>2</sup>
1.01	Garderobe 1	40,98 m <sup>2</sup>
1.06	Garderobe 2	40,98 m <sup>2</sup>
1.03	Holl	236,37 m <sup>2</sup>
1.10	Lounge	121,12 m <sup>2</sup>
1.04	Biletaria	35,36 m <sup>2</sup>
1.09	Lounge	98,60 m <sup>2</sup>

**A&E ENGINEERING** sh.p.k

**F&M** ingegneria  
Studio Konsulente  
F&M INGEGNERIA S.p.a.  
Via Belvedere 8/10  
30035 Mirano (VE)  
tel 041-5785711  
fax 041-4355933

ark.	P. KAJMAKU
ark.	D. ZOTO
ing.	M. HALLAJA
ing.	E. CANDO
ing.	V. HOXHA
ing.	D. BULZ
ing.	E. CANDO
ing.	N. DASHI
ing.	V. AVDA
ark.	V. HOXHA
ing.	A. BONAVENTURA
ing.	A. CALLEZZO
ing.	G. CHARALAMPOPOULOS
ing.	A. MAGRINI

PROJEKTI  
"Godina e Teatrit Tirane", Faza I-r6

PROJEKTI ARKITEKTONIK

DESIGNER  
Planimetri Levizje Kati Perdhe

A19

DATA 2021 SKALA 1:100



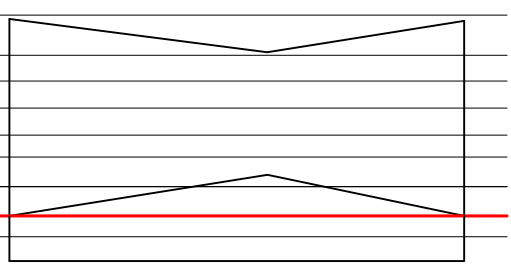
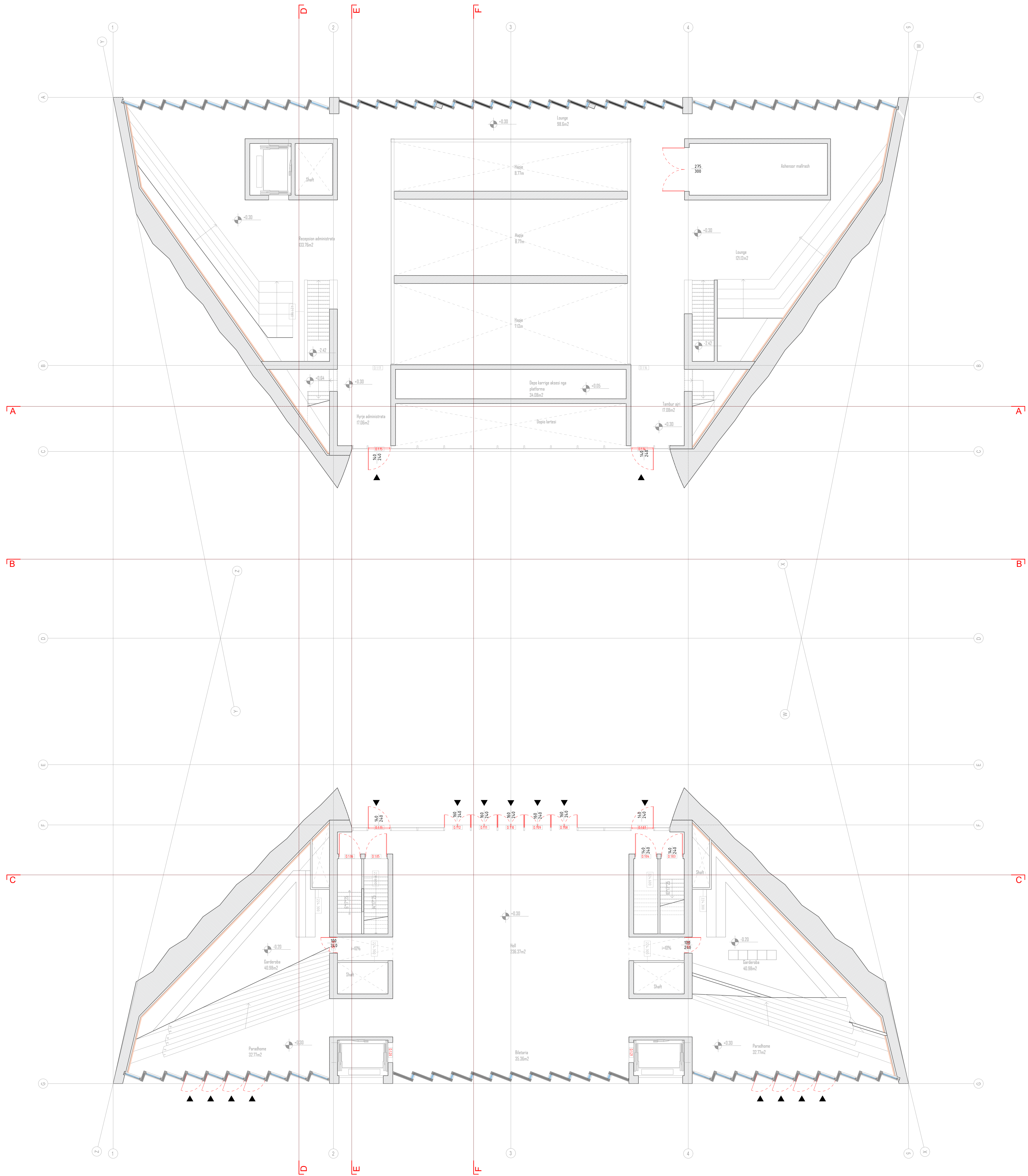
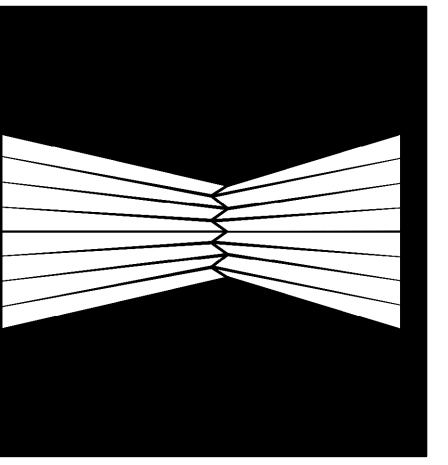

**A&E ENGINEERING** sh.p.k

**F&M ingegneria** Studio Konsulente  
 F&M INGEGNERIA S.p.a.  
 Via Belvedere 8/10  
 30035 Mirano (VE)  
 tel 041-5785711  
 fax 041-4355933

ark.	P. KAJMAKU
ark.	D. ZOTO
ing.	M. HAKLALAJ
ing.	E. CANDO
ing.	V. HOXHA
ing.	D. BULE
ing.	E. CANDO
ing.	N. DASHI
ing.	V. AVDA
ing.	V. HOXHA
ing.	A. BONAVENTURA
ing.	A. CALLEZZO
ing.	G. CHARALAMPOPOULOS
ing.	A. MAGRINI

PROJEKT  
 "Godina e Teatrit Tirane", Faza I-r6

PROJEKTI ARKITEKTONIK

EMERITIM  
 Planimetri Dyer Kati Perdhe

A20  
 DATA 2021 1:100



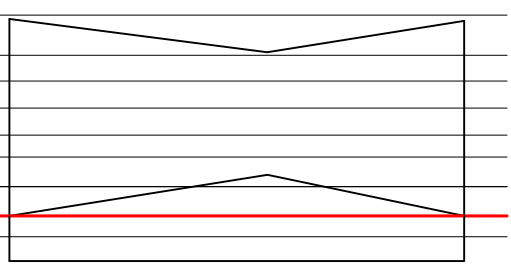
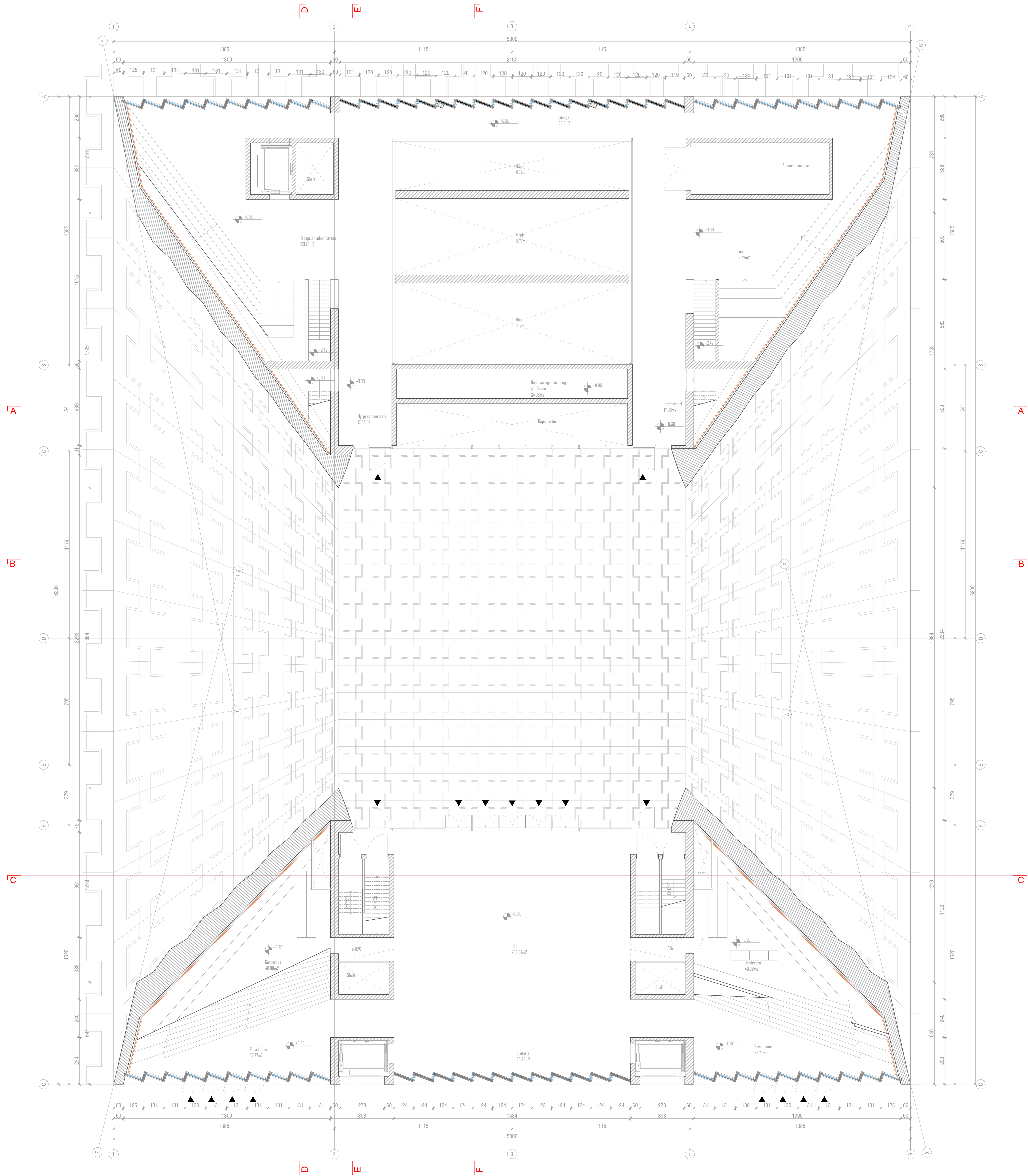
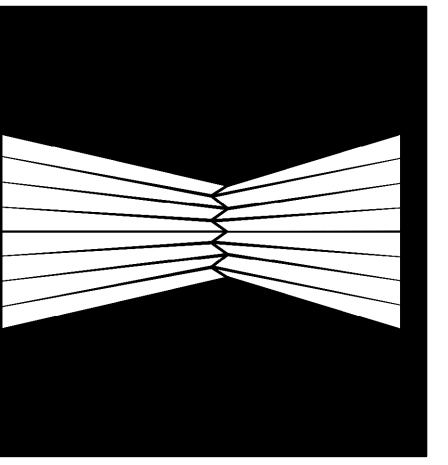

Nr	Emertimi	Siperfaqe
<b>Niveli 01</b>		
1.07	Hyrje Administrative	17,06 m <sup>2</sup>
1.08	Reception Admin	133,76 m <sup>2</sup>
1.11	Tambur Ajri	17,08 m <sup>2</sup>
1.02	Paradhome 1	32,77 m <sup>2</sup>
1.05	Paradhome 2	32,79 m <sup>2</sup>
1.12	Depo karrigesh	40,98 m <sup>2</sup>
1.01	Garderober 1	40,98 m <sup>2</sup>
1.06	Garderober 2	40,98 m <sup>2</sup>
1.03	Holl	236,37 m <sup>2</sup>
1.10	Lounge	121,12 m <sup>2</sup>
1.04	Biletaria	35,36 m <sup>2</sup>
1.09	Lounge	98,60 m <sup>2</sup>

**A&E ENGINEERING** sh.p.k

**F&M** ingegneria  
Studio Konsulente  
F&M INGEGNERIA S.p.a.  
Via Belvedere 8/10  
30035 Mirano (VE)  
tel 041-5765711  
fax 041-4355933

nr.	Emri	Funzioni
01.	P. KAJMAKU	Proj. Arkitekt
02.	D. ZOTO	Proj. Arkitekt
03.	M. HAKAJ	Proj. Arkitekt
04.	E. CANDO	Proj. Arkitekt
05.	V. HOXHA	Proj. Arkitekt
06.	D. BULI	Proj. Arkitekt
07.	E. CANDO	Proj. Arkitekt
08.	N. DASHI	Proj. Arkitekt
09.	V. AVDA	Proj. Arkitekt
10.	V. HOXHA	Proj. Arkitekt
11.	A. BONAVENTURA	Proj. Arkitekt
12.	A. CALZOTTO	Proj. Arkitekt
13.	G. CHARALAMPOPOULOS	Proj. Arkitekt
14.	A. MAGRINI	Proj. Arkitekt

PROJEKT  
"Godina e Teatrit Tirane", Faza I-r6

PROJEKTI ARKITEKTONIK

Emertimi  
Planimetri Mobilim Kati perdhe

A21

DATA  
2021  
1:100



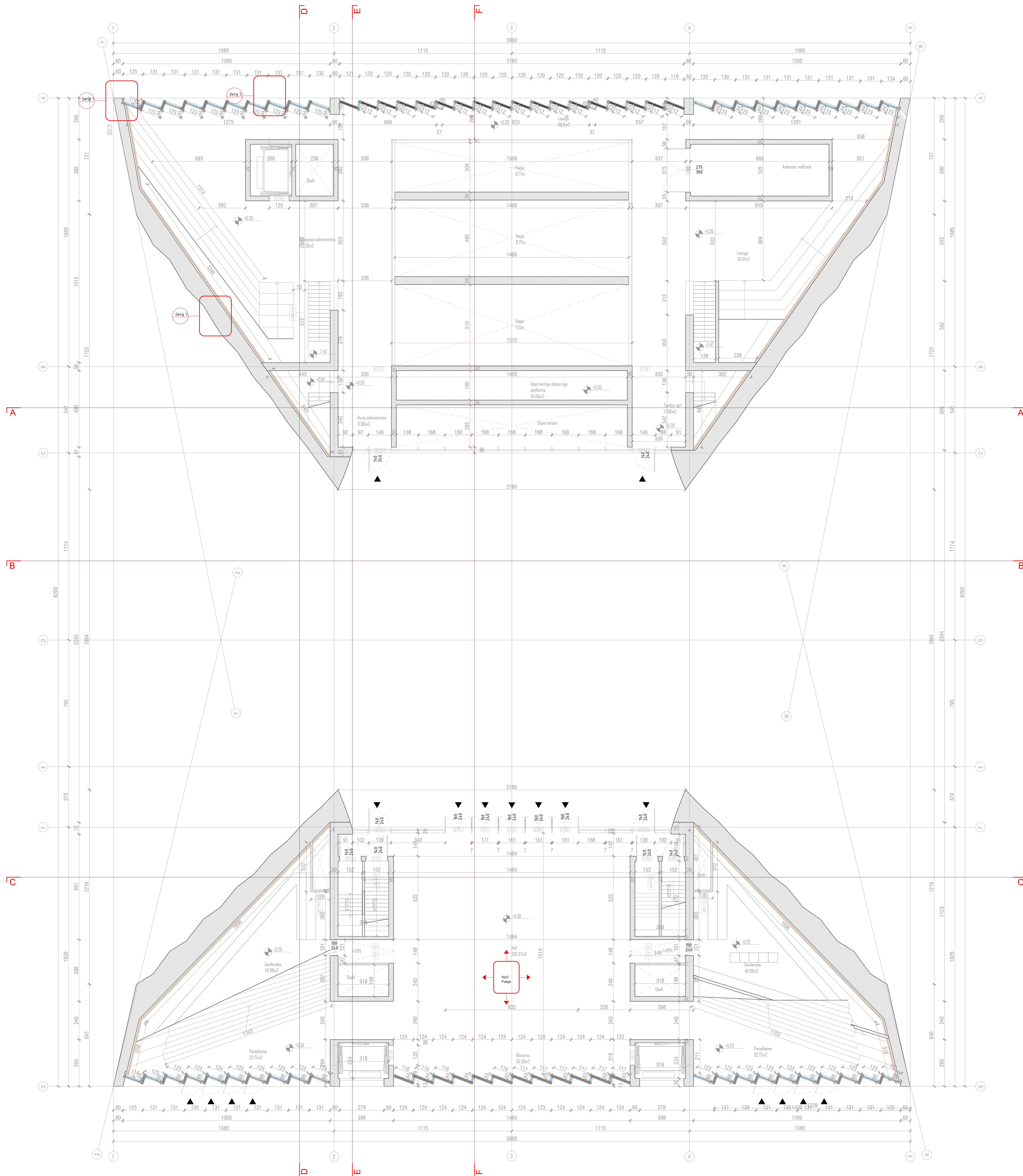
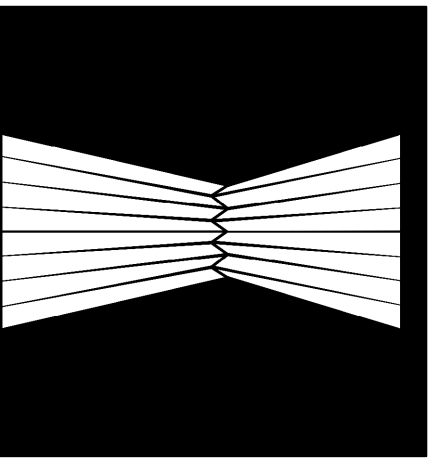

- Mur struktural B/A
- Panel Akustik
- Mur Gips
- Mur B/A
- Mur Shaft

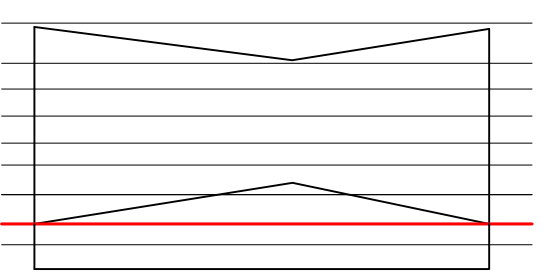

Nr	Emertimi	Siperfaqe
<b>Niveli 01</b>		
1.07	Hyrje Administrate	17,06 m <sup>2</sup>
1.08	Reception Admin	133,76 m <sup>2</sup>
1.11	Tambur Ajri	17,08 m <sup>2</sup>
1.02	Paradhome 1	32,77 m <sup>2</sup>
1.05	Paradhome 2	32,79 m <sup>2</sup>
1.12	Depo karrigesh	34,08 m <sup>2</sup>
1.01	Garderobe 1	40,98 m <sup>2</sup>
1.06	Garderobe 2	40,98 m <sup>2</sup>
1.03	Holl	236,37 m <sup>2</sup>
1.10	Lounge	121,12 m <sup>2</sup>
1.04	Biletaria	35,36 m <sup>2</sup>
1.09	Lounge	98,60 m <sup>2</sup>

**A&E ENGINEERING** sh.p.k

**F&M** ingegneria  
 Studio Konsultive  
 F&M INGEGNERIA S.p.A.  
 Via Belvedere 8/10  
 30035 Mirano (VE)  
 tel 041-5765111  
 fax 041-4355933

IPK	IPK
P. KAJMAKU	
D. ZOTO	
M. HAKALAJ	
E. CANDO	
V. HOXHA	
D. BURE	
E. CANDO	
N. DASHI	
V. AVDA	
V. HOXHA	
A. BONAVENTURA	
A. CALLEZZO	
G. CHARALAMPOPOULOS	
A. MAGRINI	

PROJEKT: "Godina e Teatrit Tiranë", Faza I-rë

PROJEKTI ARKITEKTONIK

EMERTIMI: Planimetri Teknike Kati perdhe

A22

DATA: 2021  
 SKALA: 1:100



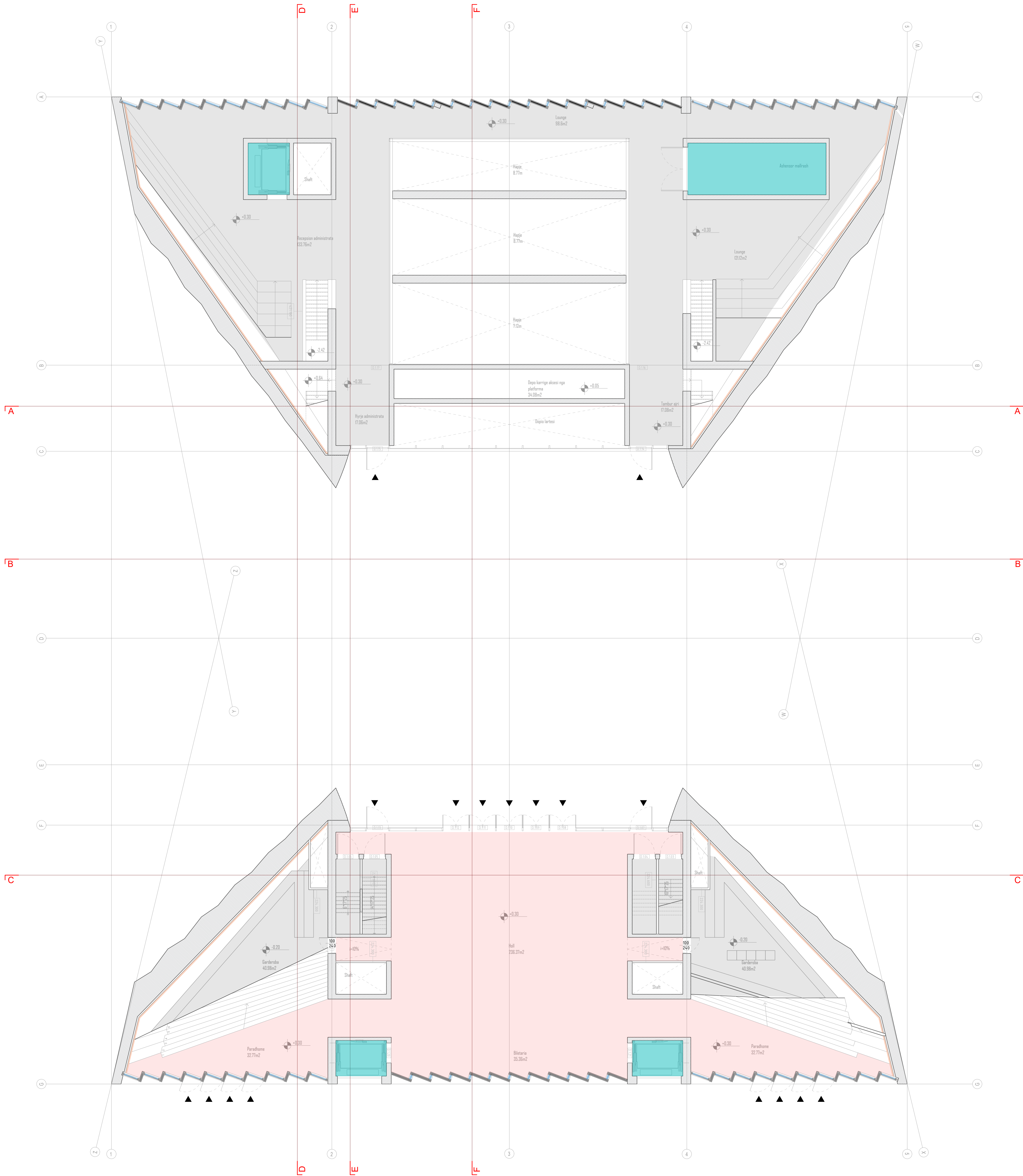
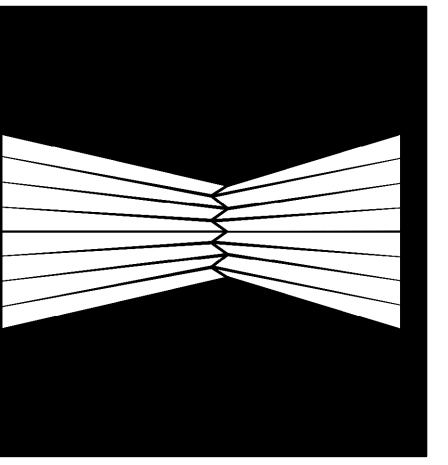

**Shtirim Dysheme**

- 431.100 - Beton i fshire
- 432.100 - Plaka guri
- 432.200 - Plaka qeramike
- 433.100 - Dru
- 433.200 - Mokset
- BOH - Rezine

**Material Tavani**

- Struktura ne pamje
- Tavani i varur:
  - 351.100 tavani i varur akustik,
  - Pet zeri 50 Ngjyra: Gri
  - 351.200 Perde e varur akustike
  - Ngjyra: Kuqe
  - 351.600 Panele akustike
  - Plaka metalike

**Siperfaqe Tavani:**

- 353.100 Panele akustike, Pet zeri 50 Ngjyra: Jeshile
- 353.200 Panele akustike shtrese e dyfishte fiber Ngjyra: e Zeze
- 353.400 Panele akustike (Pet zeri 50) Ngjyra: Gri
- 353.700 Panele akustike shtrese e dyfishte fiber Ngjyra: e Zeze

- Ashensori: Metal i galvanizuar

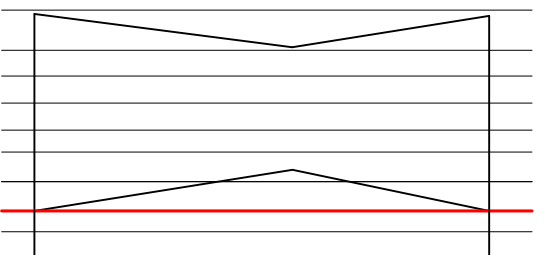

Nr	Emertimi	Siperfaqe
<b>Niveli 01</b>		
1.07	Hyrje Administrative	17,06 m <sup>2</sup>
1.08	Reception Admin	133,76 m <sup>2</sup>
1.11	Tambur Ajri	17,08 m <sup>2</sup>
1.02	Paradhome 1	32,77 m <sup>2</sup>
1.05	Paradhome 2	32,79 m <sup>2</sup>
1.12	Depo karrigesh	34,08 m <sup>2</sup>
1.01	Garderobe 1	40,98 m <sup>2</sup>
1.06	Garderobe 2	40,98 m <sup>2</sup>
1.03	Holl	236,37 m <sup>2</sup>
1.10	Lounge	121,12 m <sup>2</sup>
1.04	Biletaria	35,36 m <sup>2</sup>
1.09	Lounge	98,60 m <sup>2</sup>

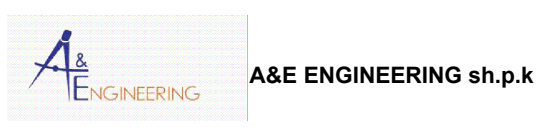

**F&M** ingegneria  
 Studio Konsulente  
 F&M INGEGNERIA S.p.A.  
 Via Belvedere 8/10  
 30035 Mirano (VE)  
 tel 041-5765711  
 fax 041-4355933

ark.	P. KAJMAKU	
ark.	D. ZOTO	
ing.	M. HAKAJ	
ing.	E. CANO	
ing.	V. HOKHA	
ing.	D. BURE	
ing.	E. CANO	
ing.	N. DASHI	
ing.	V. AVDA	
ark.	V. HOKHA	
ing.	A. BONAVENTURA	
ing.	A. CALZOTTO	
ing.	G. CHARALAMPOPOULOS	
ing.	A. MAGRINI	

PROJEKT  
 "Godina e Teatrit Tiranë", Faza I-rë

PROJEKTI ARKITEKTONIK

EMERTIMI  
 Planimetri Dysheme Kati perdhe



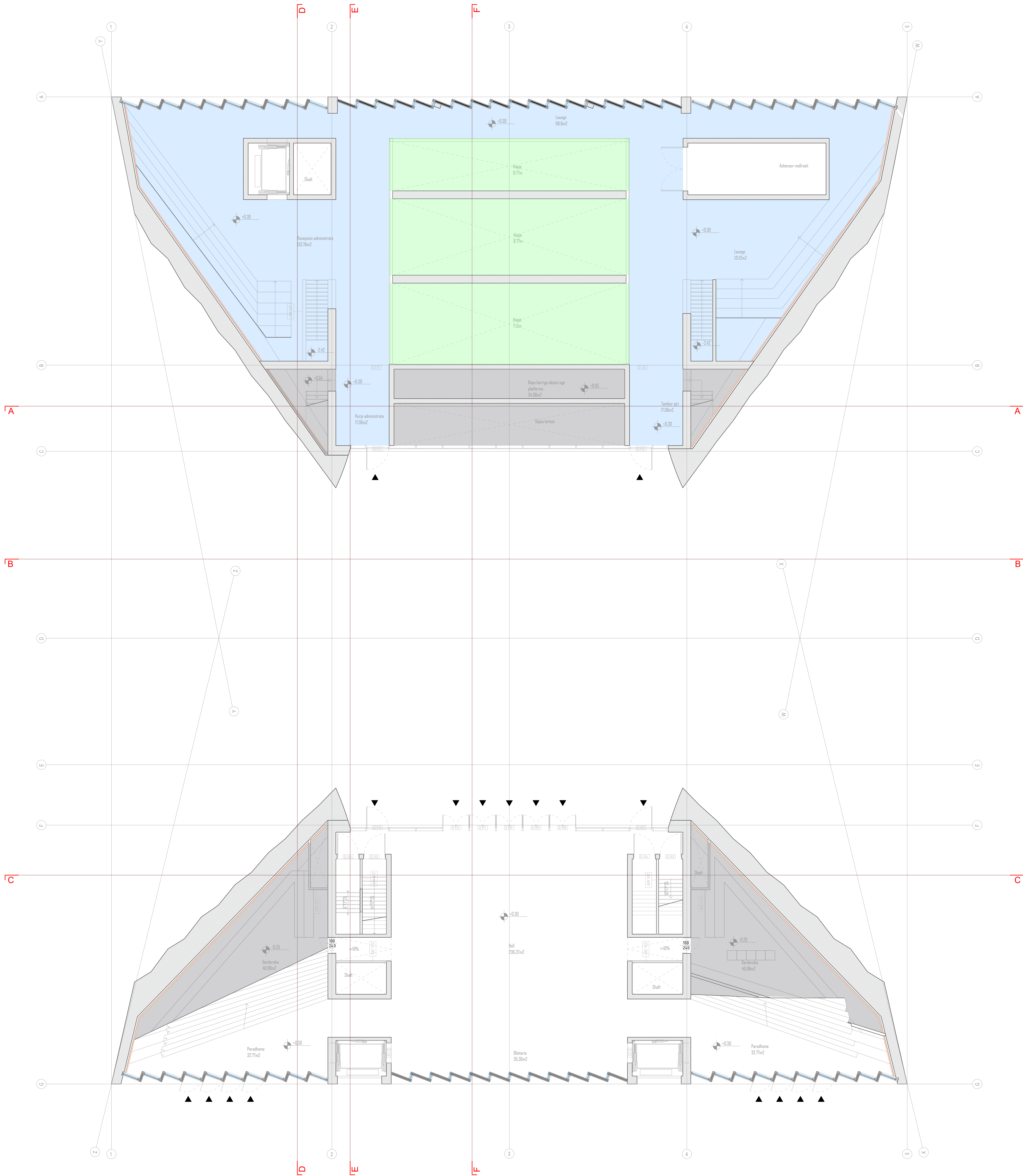
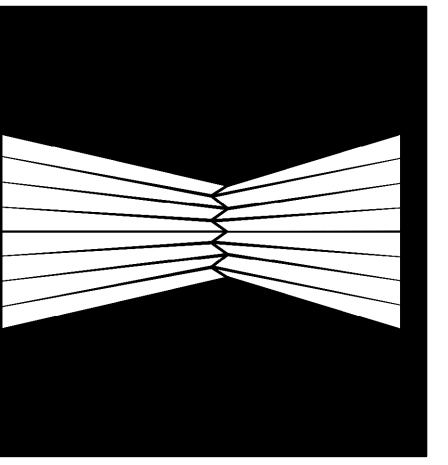

**Shtirim Dysheme**

- 431.100 - Beton i fshire
- 432.100 - Plaka guri
- 432.200 - Plaka qeramike
- 433.100 - Dru
- 433.200 - Mokset
- BOH - Rezine

**Material Tavani**

- Struktura ne pamje
- Tavani i varur:
  - 351.100 tavani i varur akustik, Pet zeri 50 Ngjyra: Gri
  - 351.200 Perde e varur akustike Ngjyra: Kuqe
  - 351.600 Panele akustike - Plaka metalike

**Siperfaqe Tavani:**

- 353.100 Panele akustike, Pet zeri 50 Ngjyra: Jeshile
- 353.200 Panele akustike shtrese e dyfishte fiber Ngjyra: e Zeze
- 353.400 Panele akustike (Pet zeri 50) Ngjyra: Gri
- 353.700 Panele akustike shtrese e dyfishte fiber Ngjyra: e Zeze

- Ashensori: Metal i galvanizuar

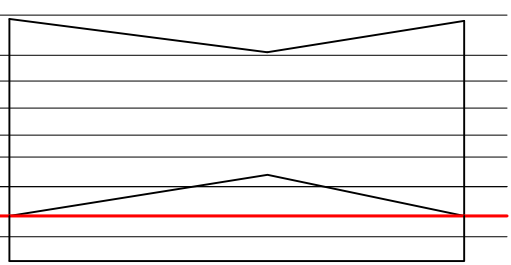

Nr	Emertimi	Siperfaqe
<b>Niveli 01</b>		
1.07	Hyrje Administrate	17,06 m <sup>2</sup>
1.08	Reception Admin	133,76 m <sup>2</sup>
1.11	Tambur Ajri	17,08 m <sup>2</sup>
1.02	Paradhome 1	32,77 m <sup>2</sup>
1.05	Paradhome 2	32,79 m <sup>2</sup>
1.12	Depo karrigesh	34,08 m <sup>2</sup>
1.01	Garderobe 1	40,98 m <sup>2</sup>
1.06	Garderobe 2	40,98 m <sup>2</sup>
1.03	Holl	236,37 m <sup>2</sup>
1.10	Lounge	121,12 m <sup>2</sup>
1.04	Biletaria	35,36 m <sup>2</sup>
1.09	Lounge	98,60 m <sup>2</sup>



**F&M** ingegneria Studio Konsulente  
 F&M INGEGNERIA S.p.a.  
 Via Belvedere 8/10  
 30035 Mirano (VE)  
 tel 041-5765711  
 fax 041-4355933

ark.	P. KAJMAKU
ark.	D. ZOTO
ing.	M. HAKAJ
ing.	E. CANO
ing.	V. HOXHA
ing.	D. BURE
ing.	E. CANO
ing.	N. DASHI
ing.	V. AVDA
ark.	V. HOXHA
ing.	A. BONAVENTURA
ing.	A. CALZOTTO
ing.	G. CHARALAMPOPOULOS
ing.	A. MAGRINI

PROJEKT  
 "Godina e Teatrit Tirane", Faza I-r6

**PROJEKTI ARKITEKTONIK**

EMERTIMI  
 Planimetri Tavani Kati perdhje

A24



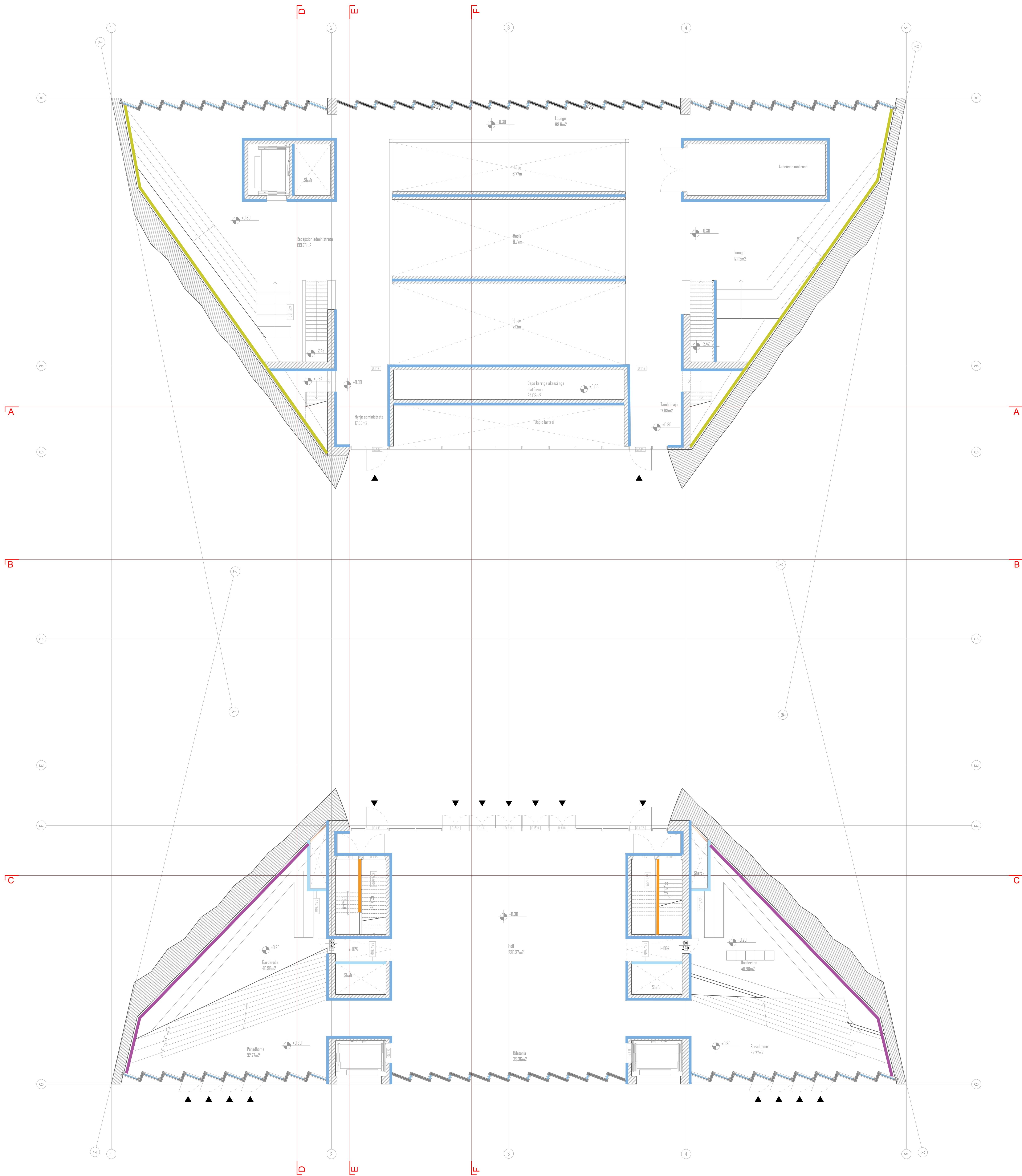
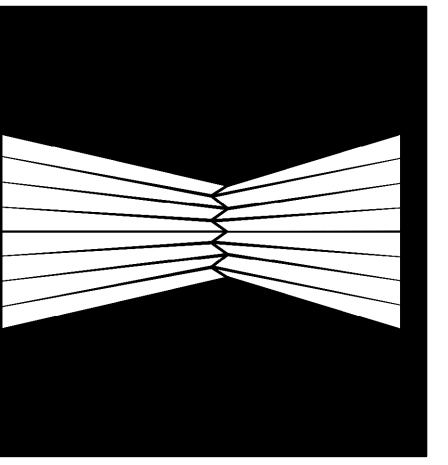

- Strukure 224.100
- 224.200
- 224.300
- 224.400
- 224.600
- 224.700
- 224.800
- 224.500

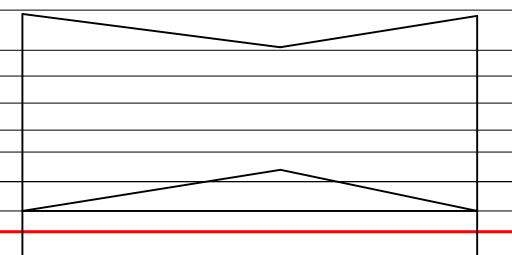

Nr	Emertimi	Siperfaqe
1.07	Hyrje Administrate	17,06 m <sup>2</sup>
1.08	Reception Admin	133,76 m <sup>2</sup>
1.11	Tambur Ajri	17,08 m <sup>2</sup>
1.02	Paradhome 1	32,77 m <sup>2</sup>
1.05	Paradhome 2	32,79 m <sup>2</sup>
1.12	Depo karrigesh	34,08 m <sup>2</sup>
1.01	Garderobe 1	40,98 m <sup>2</sup>
1.06	Garderobe 2	40,98 m <sup>2</sup>
1.03	Holl	236,37 m <sup>2</sup>
1.10	Lounge	121,12 m <sup>2</sup>
1.04	Biletaria	35,36 m <sup>2</sup>
1.09	Lounge	98,60 m <sup>2</sup>

A&E ENGINEERING sh.p.k

Studio Konsulente  
**F&M**  
**ingegneria**  
 F&M INGEGNERIA S.p.A.  
 Via Belvedere 8/10  
 30035 Mirano (VE)  
 tel 041-5785711  
 fax 041-4355933

ark.	P. KAJMAKU
ark.	D. ZOTO
ing.	M. HAKAJ
ing.	E. CANDO
ing.	V. HOKHA
ing.	D. BULZ
ing.	E. CANDO
ing.	N. DASHI
ing.	V. AVDA
ing.	V. HOKHA
ing.	A. BONAVENTURA
ing.	A. CALZOTTO
ing.	G. CHARALAMPOPOULOS
ing.	A. MAGRINI

PROJEKT  
 "Godina e Teatrit Tirane", Faza I-r8

PROJEKTI ARKITEKTONIK

PLANIMETRI Muret Kati perdo

A25

DATA 2021 1:100