

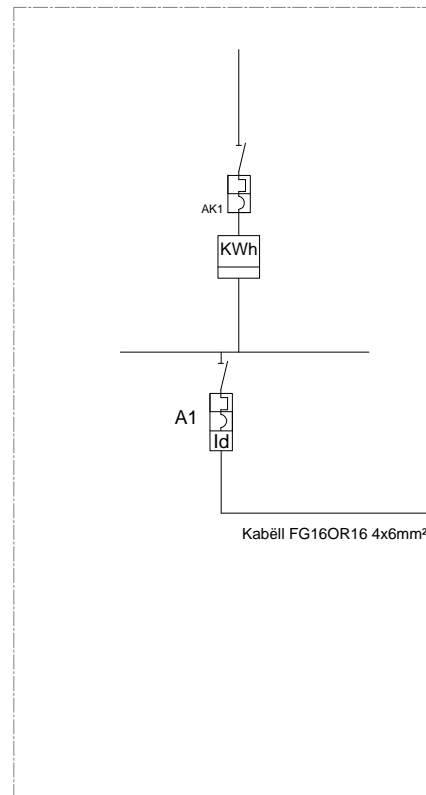

SKEMA ELEKTRIKE E NDRIÇIMIT TË PANELIT

Kabëll FG16OR16 4x6mm²
nga kabina elektrike

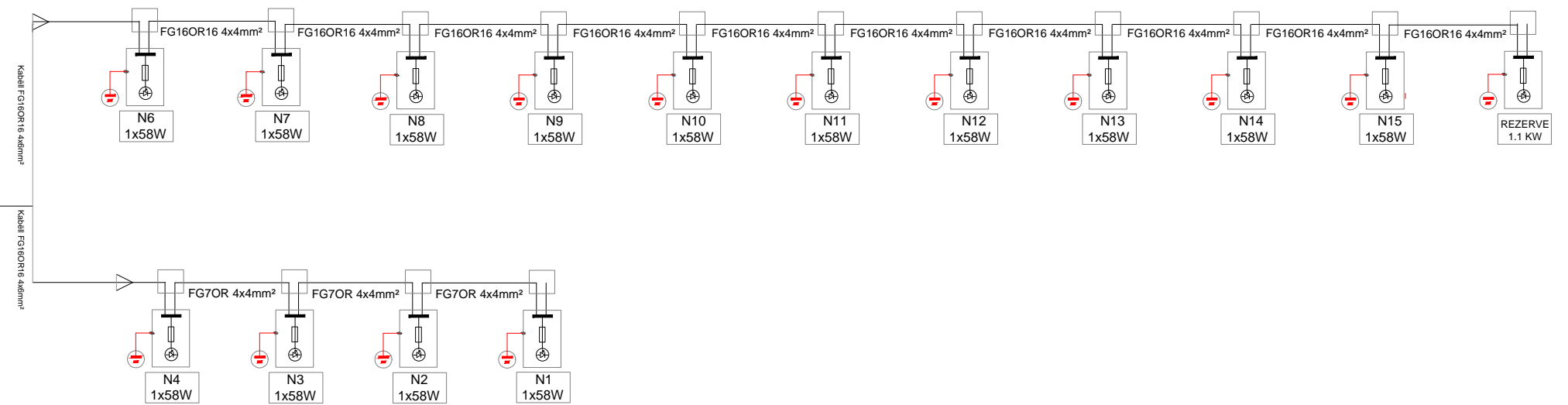

Kuari elektrik
i komandimit të ndriçimit



	REPUBLIKA E SHQIPERISE BASHKIA KORCE DREJTORIA E PLANIFIKIMIT URBAN TE TERRITORIT	DREJTORI I D.P.P.K.ZH.U.	ZHANETA LUBONJA	FLETA 1
	Objekti: RIKONSTRUKSIONI I NDRICIMIT "RRUGA SOTIR POLENA" Emertimi: SKEMA ELEKTRIKE E NDRICIMIT TË PANELIT Shkalla: _____ Data:2022	AUORET E PROJEKTIT	Ing.el.VILMA PEPO Ark. ARSEN QOSJA	





LEGJENDA

- NDRIÇUES LED
- KABËLL NËNTOKËSOR
- PUSETË ELEKTRIKE
- KUADËR ELEKTRIK
- ⚡ KABINË ELEKTRIKE

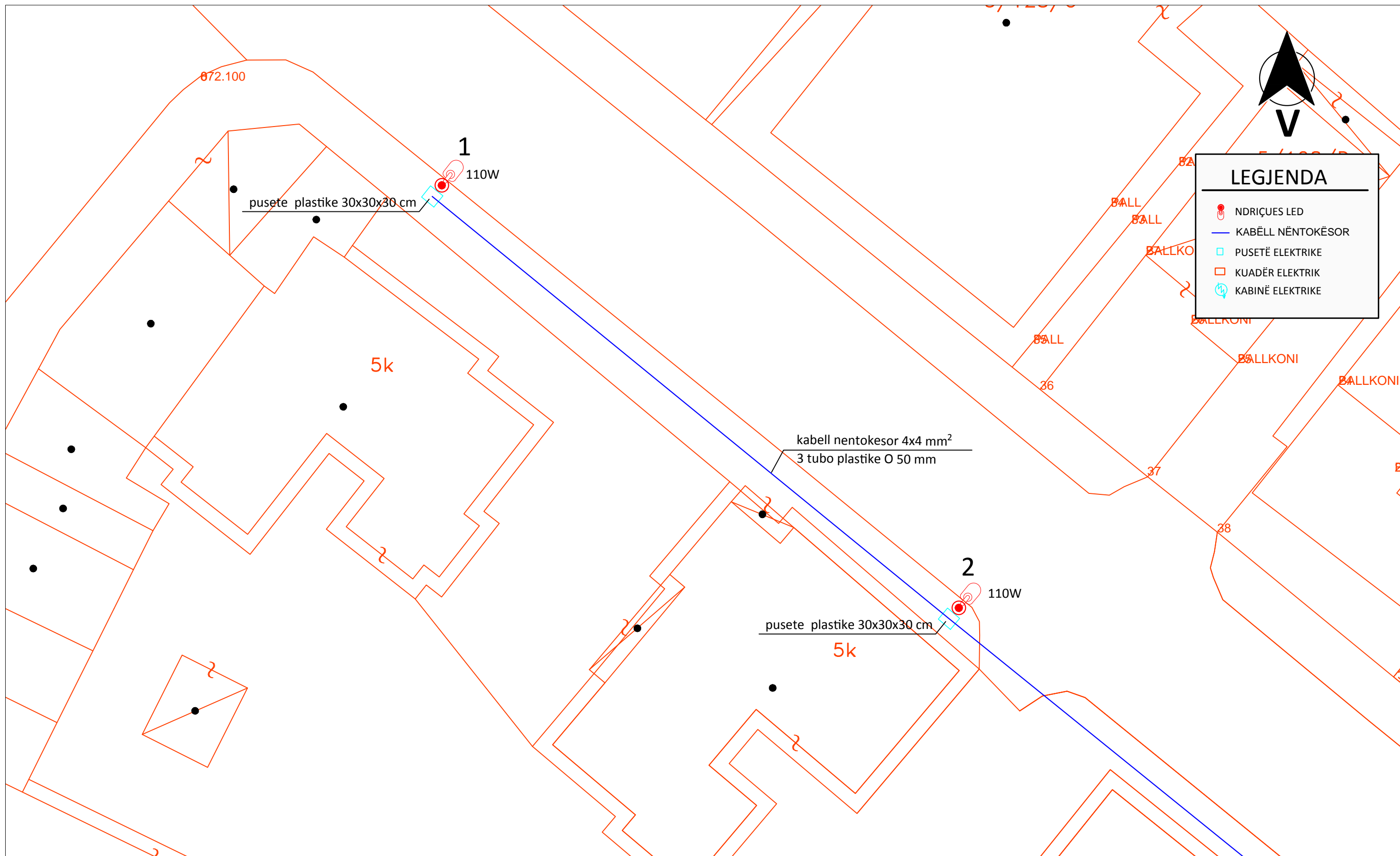

 REPUBLIKA E SHQIPERISE BASHKIA KORÇE DREJTORIA E PLANIFIKIMIT URBAN TE TERRITORIT	DREJTORI I D.P.P.K.ZH.U.	ZHANETA LUBONJA	FLETA E-01-01
	AUTORET E PROJEKTIT		Ing.ei.VILMA PEPO Ark. ARSEN QOSJA
Objekti: RIKONSTRUKSION I NDRIÇIMIT RRUGA " REXHEP TELHAJ"			
Emertimi: PLANIMETRIA E RRUGËS			
Shkalla: 1:1700	Data: 2022		



 REPUBLIKA E SHQIPERISE BASHKIA KORCE DREJTORIA E PLANIFIKIMIT URBAN TE TERRITORIT	DREJTORI I D.P.P.K.ZH.U.	ZHANETA LUBONJA	FLETA E-01-02
	AUTORET E PROJEKTIT	Ing.eI.VILMA PEPO Ark. ARSEN QOSJA	
Objekti: RIKONSTRUKSION I NDRIÇIMIT RRUGA " REXHEP TELHAJ"			
Emertimi: PLANIMETRIA E RRGËS			
Shkalla: 1:200	Data: 2022		

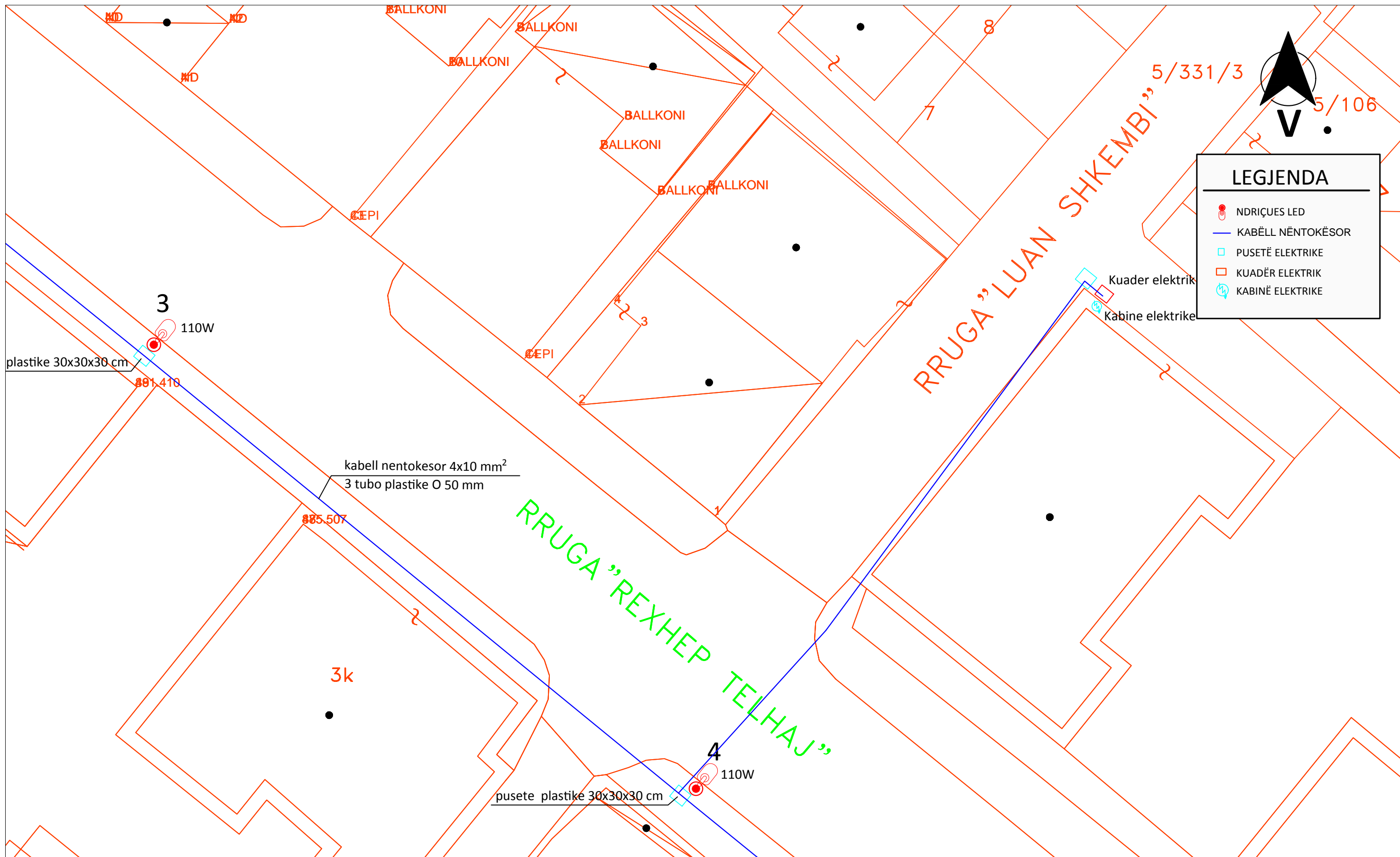

 REPUBLIKA E SHQIPERISE BASHKIA KORCE DREJTORIA E PLANIFIKIMIT URBAN TE TERRITORIT	DREJTORI I D.P.P.K.ZH.U.	ZHANETA LUBONJA	FLETA E-01-03
	AUTORET E PROJEKTIT		Ing.ei.VILMA PEPO Ark. ARSEN QOSJA
Shkalla: 1:200	Data: 2022		

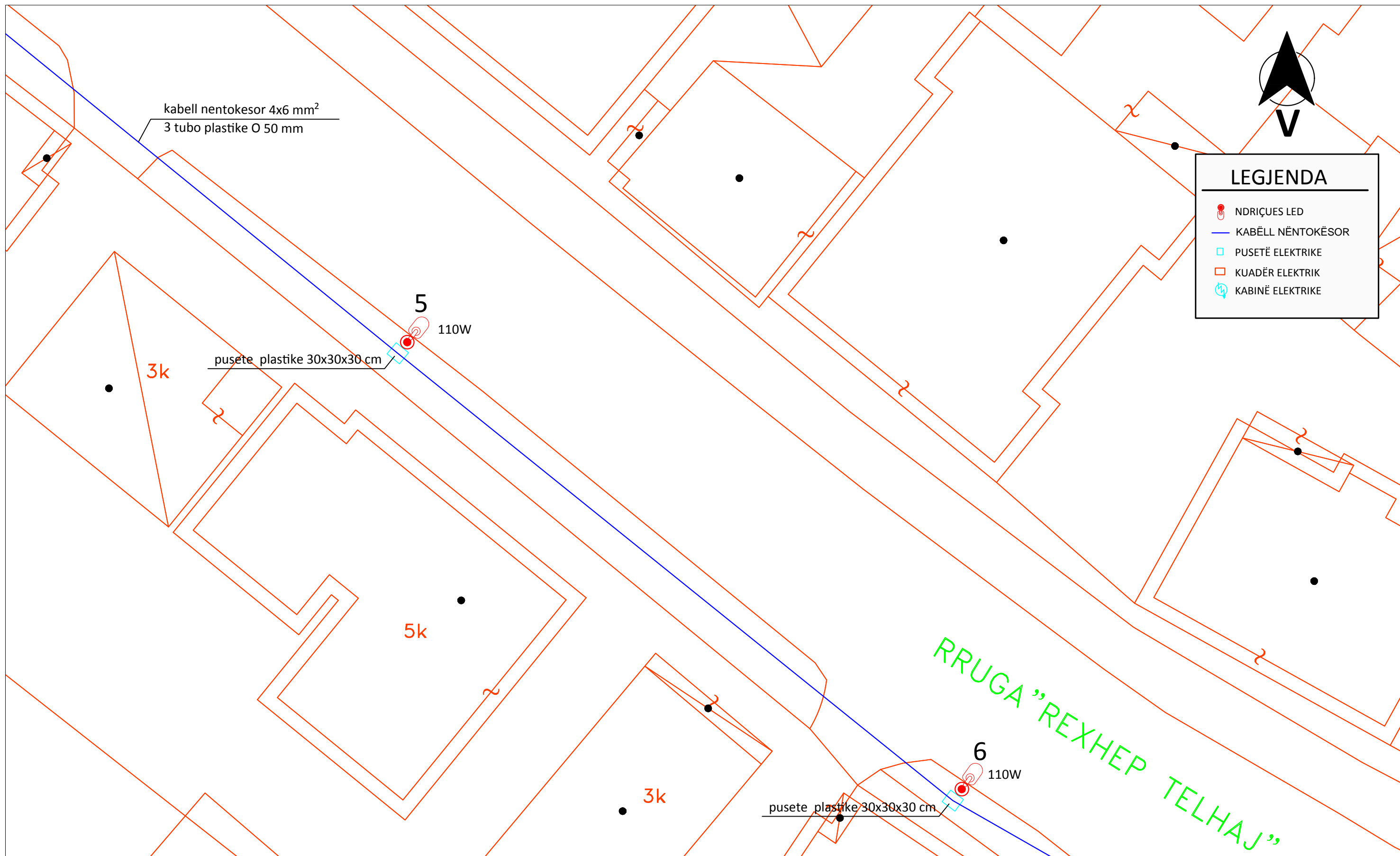

 REPUBLIKA E SHQIPERISE BASHKIA KORCE DREJTORIA E PLANIFIKIMIT URBAN TE TERRITORIT	DREJTORI I D.P.P.K.ZH.U.	ZHANETA LUBONJA	FLETA E-01-04
	AUTORET E PROJEKTIT		Ing.eI.VILMA PEPO Ark. ARSEN QOSJA
	Objekti: RIKONSTRUKSION I NDRICIMIT RRUGA " REXHEP TELHAJ"	Emertimi: PLANIMETRIA E RRRUGES	
Shkalla: 1:200	Data: 2022		

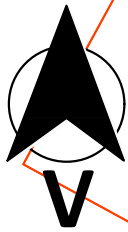
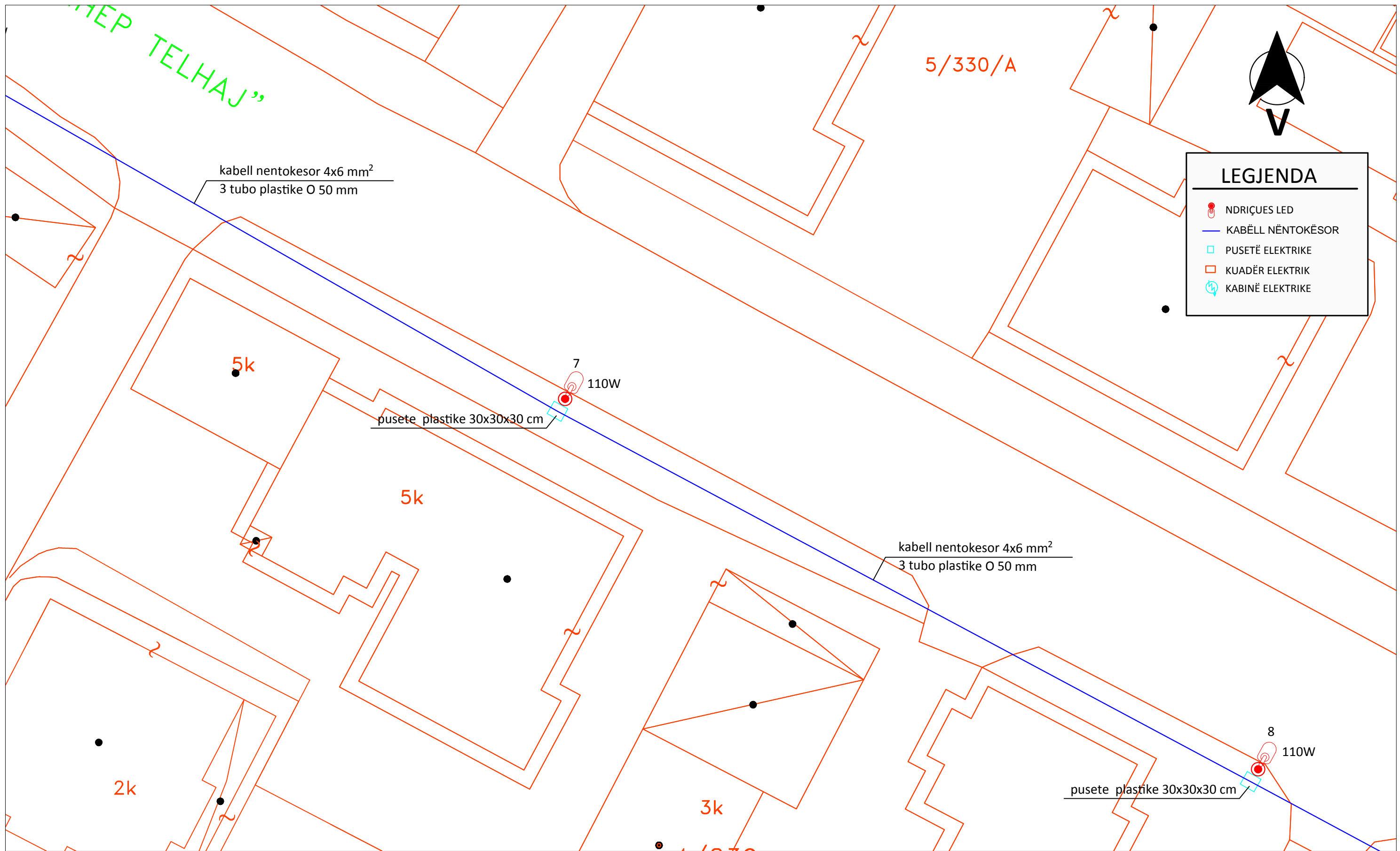

LEGJENDA

- NDRIÇUES LED
- KABËLL NËNTOKËSOR
- PUSETË ELEKTRIKE
- KUADËR ELEKTRIK
- KABINË ELEKTRIKE



 REPUBLIKA E SHQIPERISE BASHKIA KORCE DREJTORIA E PLANIFIKIMIT URBAN TE TERRITORIT	DREJTORI I D.P.P.K.ZH.U.	ZHANETA LUBONJA	FLETA E-01-05
	AUORET E PROJEKTIT		Ing.eI.VILMA PEPO Ark. ARSEN QOSJA
Objekti: RIKONSTRUKSION I NDRIÇIMIT RRUGA " REXHEP TELHAJ"			
Emertimi: PLANIMETRIA E RRU GËS			
Shkalla: 1:200	Data: 2022		

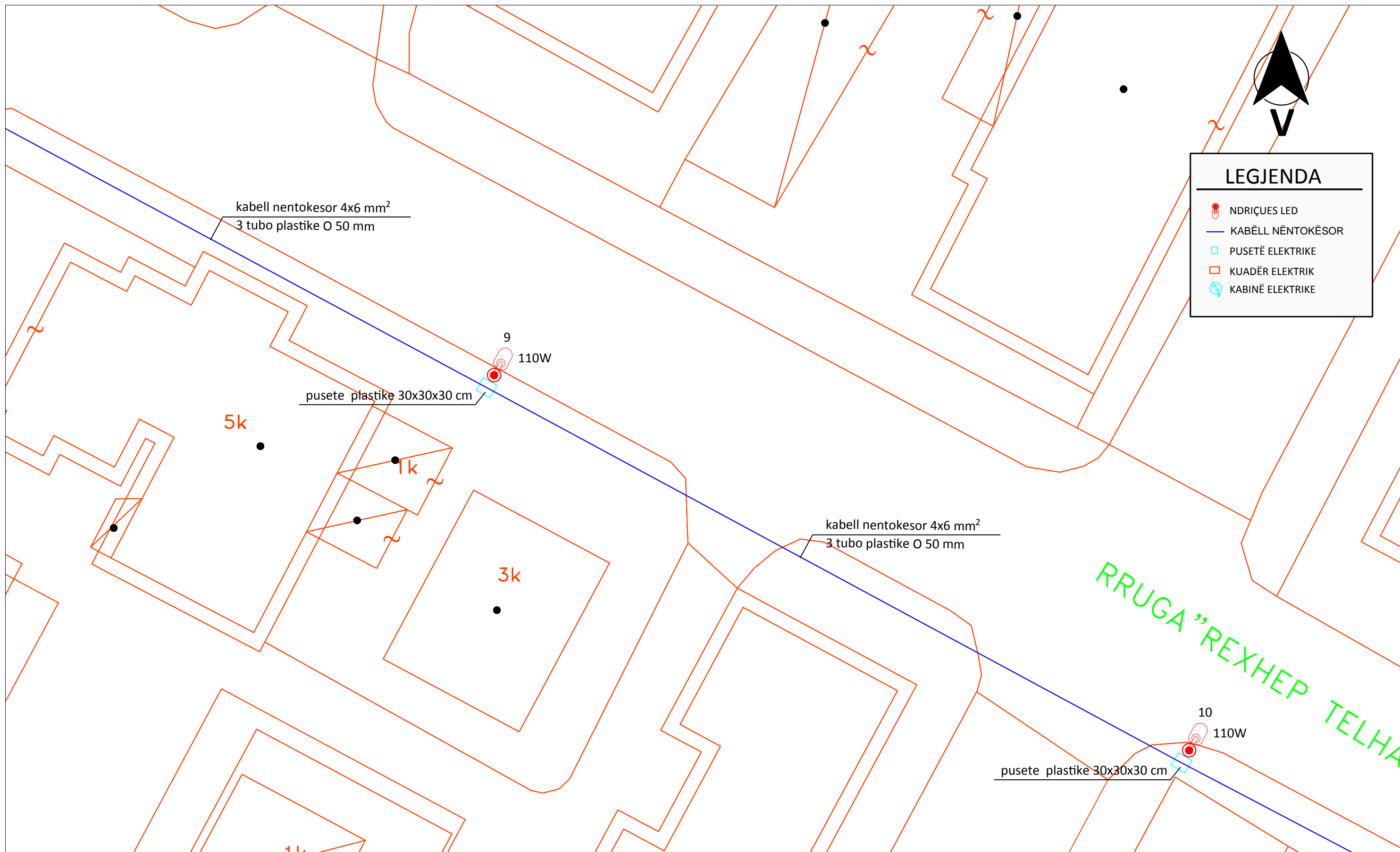

LEGJENDA

- NDRIÇUES LED
- KABËLL NËNTOKËSOR
- PUSETË ELEKTRIKE
- KUADËR ELEKTRIK
- KABINË ELEKTRIKE

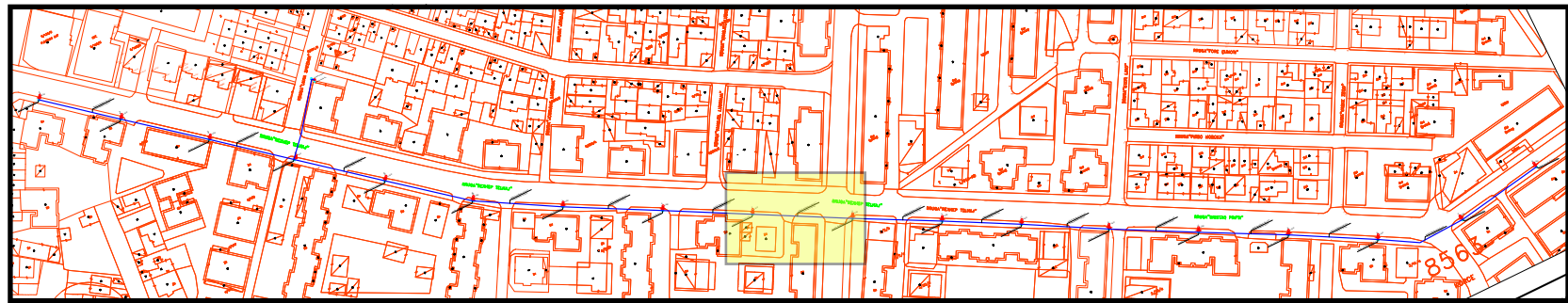

 REPUBLIKA E SHQIPERISE BASHKIA KORCE DREJTORIA E PLANIFIKIMIT URBAN TE TERRITORIT	DREJTORI I D.P.P.K.ZH.U.	ZHANETA LUBONJA	FLETA E-01-06
	AUTORET E PROJEKTIT		Ing.eI.VILMA PEPO Ark. ARSEN QOSJA
Objekti: RIKONSTRUKSION I NDRIÇIMIT RRUGA " REXHEP TELHAJ"			
Emertimi: PLANIMETRIA E RRUGËS			
Shkalla: 1:200	Data: 2022		

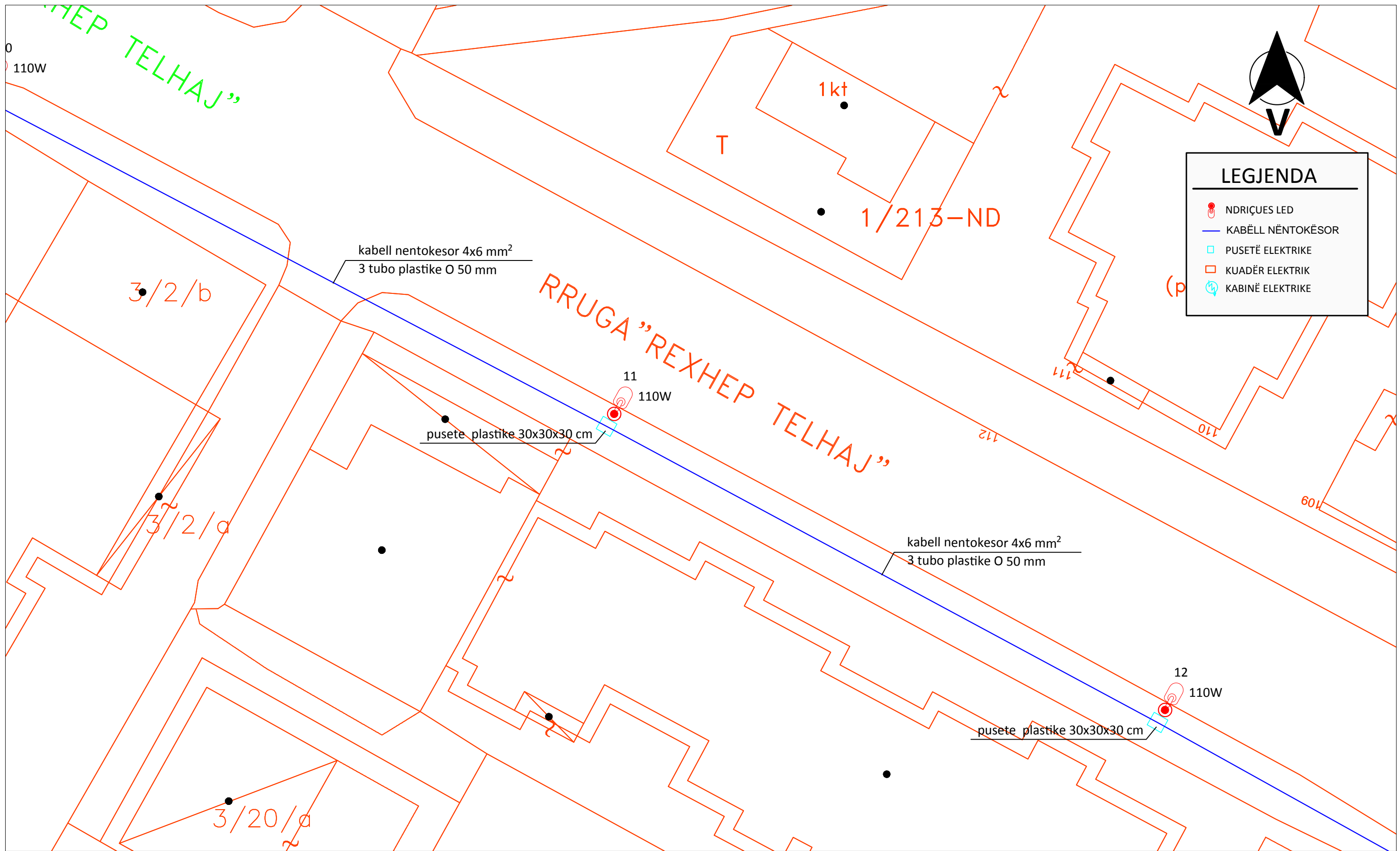

LEGJENDA	
	NDRIÇUES LED
	KABËLL NËNTOKËSOR
	PUSETË ELEKTRIKE
	KUADËR ELEKTRIK
	KABINË ELEKTRIKE



 REPUBLIKA E SHQIPERISE BASHKIA KORCE DREJTORIA E PLANIFIKIMIT URBAN TE TERRITORIT	DREJTORI I D.P.P.K.ZH.U.	ZHANETA LUBONJA	FLETA E-01-07
	AUORET E PROJEKTIT		Ing.eI.VILMA PEPO Ark. ARSEN QOSJA
	Objekti: RIKONSTRUKSION I NDRIÇIMIT RRUGA " REXHEP TELHAJ"	Emertimi: PLANIMETRIA E RRGËS	
Shkalla: 1:200	Data: 2022		

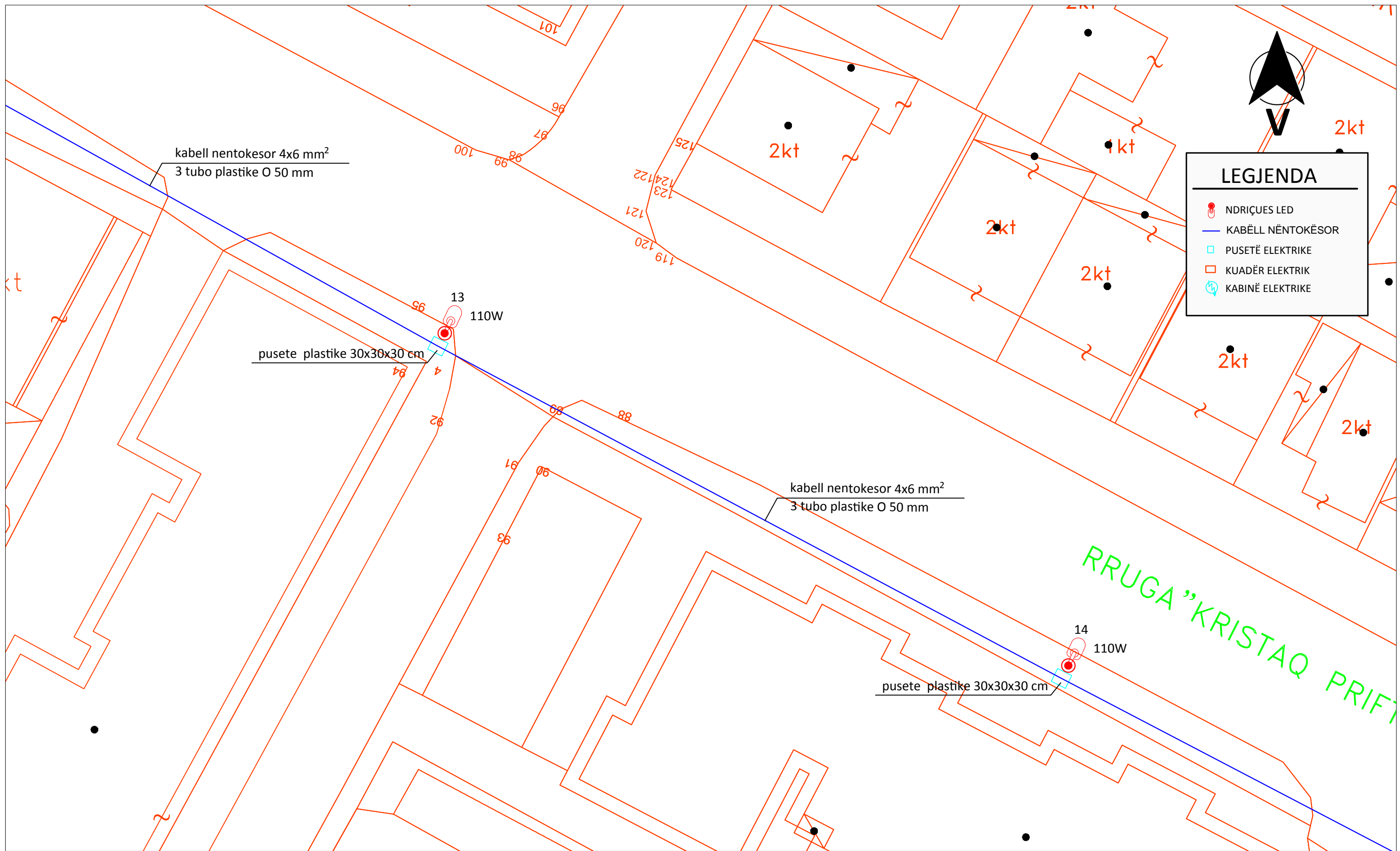



LEGJENDA

- NDRIÇUES LED
- KABËLL NËNTOKËSOR
- PUSETË ELEKTRIKE
- KUADËR ELEKTRIK
- KABINË ELEKTRIKE

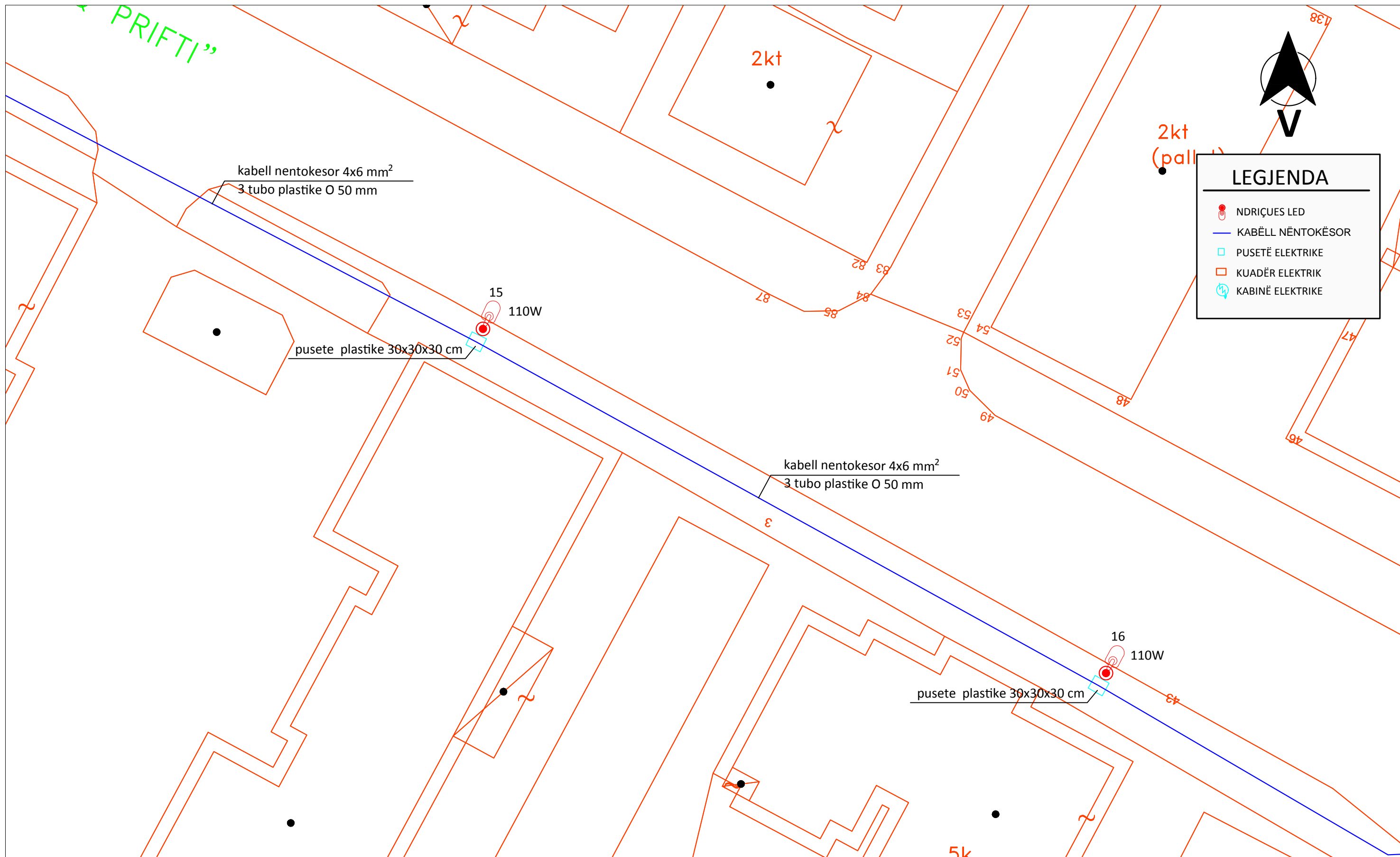

 REPUBLIKA E SHQIPERISE BASHKIA KORCE DREJTORIA E PLANIFIKIMIT URBAN TE TERRITORIT	DREJTORI I D.P.P.K.ZH.U.	ZHANETA LUBONJA	FLETA E-01-08
	AUTORET E PROJEKTIT		Ing.eI.VILMA PEPO Ark. ARSEN QOSJA
	Objekti: RIKONSTRUKSION I NDRIÇIMIT RRUGA " REXHEP TELHAJ"		
Emertimi: PLANIMETRIA E RRGËS			
Shkalla: 1:200	Data: 2022		



 REPUBLIKA E SHQIPERISE BASHKIA KORCE DREJTORIA E PLANIFIKIMIT URBAN TE TERRITORIT	DREJTORI I D.P.P.K.ZH.U.	ZHANETA LUBONJA	FLETA E-01-09
	AUORET E PROJEKTIT		Ing.ei.VILMA PEPO Ark. ARSEN QOSJA
	Objekti: RIKONSTRUKSION I NDRIÇIMIT RRUGA " REXHEP TELHAJ"	Emertimi: PLANIMETRIA E RRRUGËS	
Shkalla: 1:200	Data: 2022		

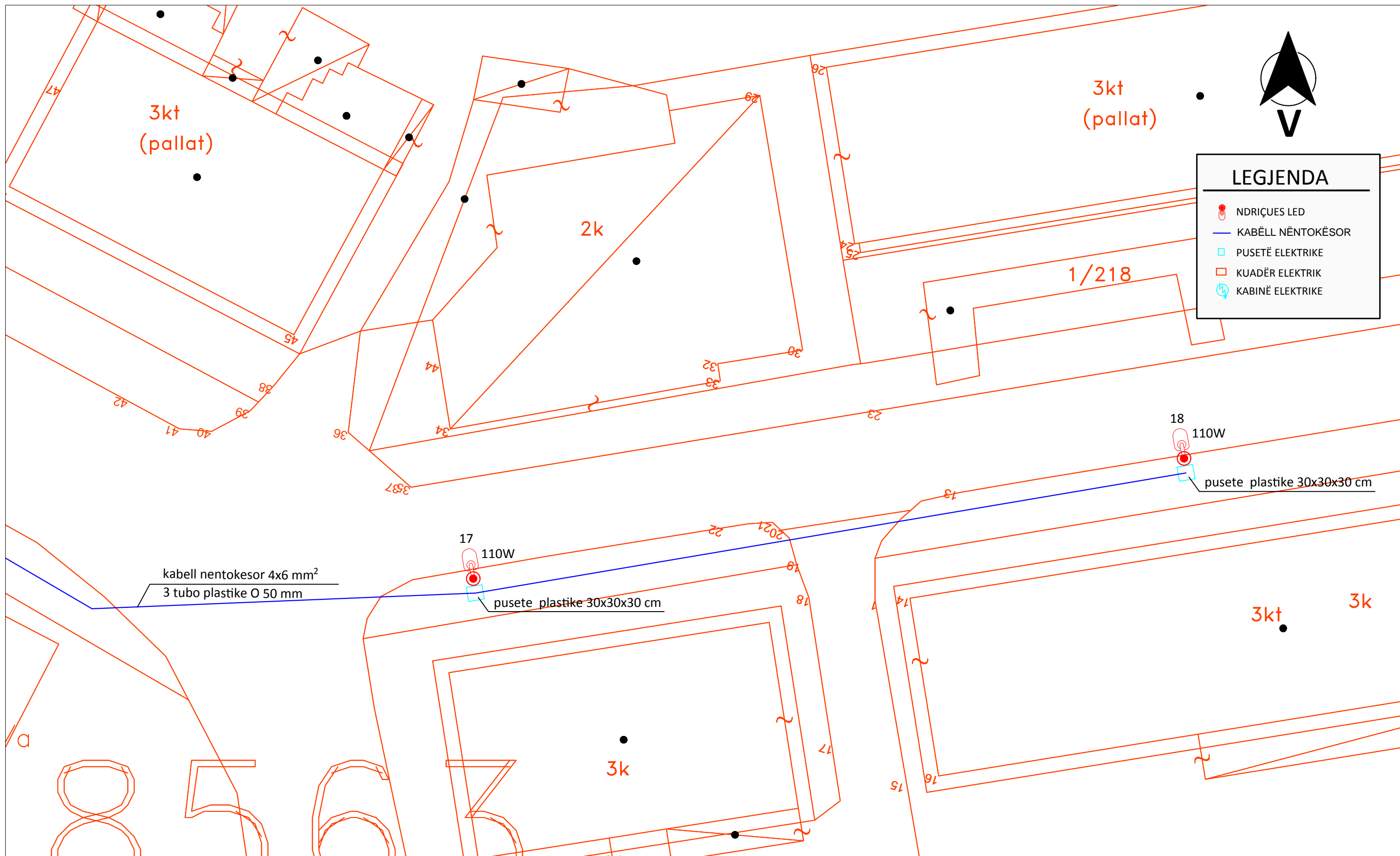

 REPUBLIKA E SHQIPERISE BASHKIA KORCE DREJTORIA E PLANIFIKIMIT URBAN TE TERRITORIT	DREJTORI I D.P.P.K.ZH.U.	ZHANETA LUBONJA	FLETA E-01-10
	AUTORET E PROJEKTIT		Ing.eI.VILMA PEPO Ark. ARSEN QOSJA
Objekti: RIKONSTRUKSION I NDRICIMIT RRUGA " REXHEP TELHAJ"			
Emertimi: PLANIMETRIA E RRRUGËS			
Shkalla: 1:200	Data: 2022		

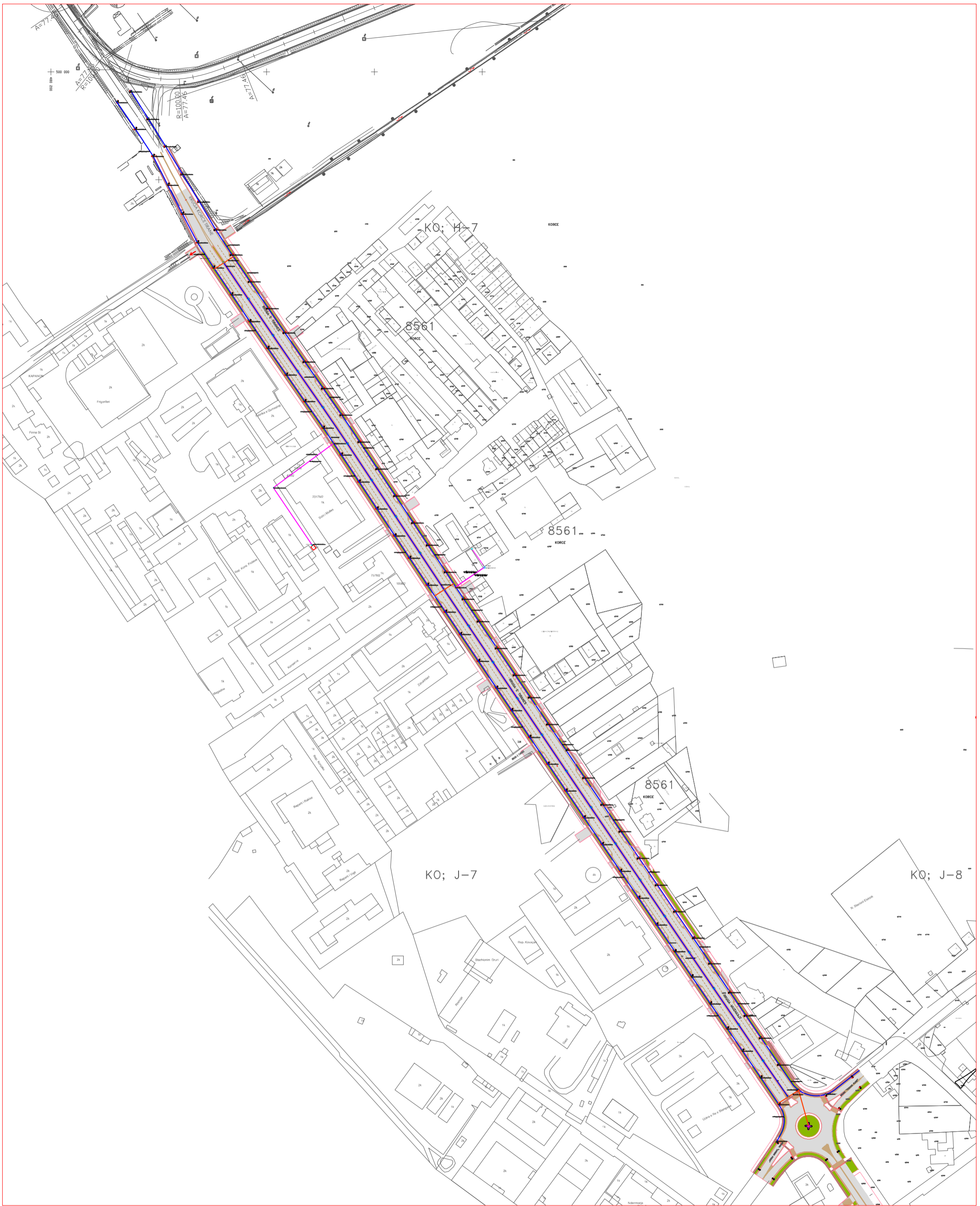

 REPUBLIKA E SHQIPERISE BASHKIA KORCE DREJTORIA E PLANIFIKIMIT URBAN TE TERRITORIT	DREJTORI I D.P.P.K.Z.H.U.	ZHANETA LUBONJA	Fleta 00-01
	Objekti: RIKONSTRUKSION I INDRICIMIT RRUGA " MUZAKAJT" Emertimi: PLANIMETRIA E RRUGES Shkalla: 1:1500 Data: 2022	AUORET E PROJEKTIT	Ing.el.Vilma Pepo Ark. Arsen Qosja

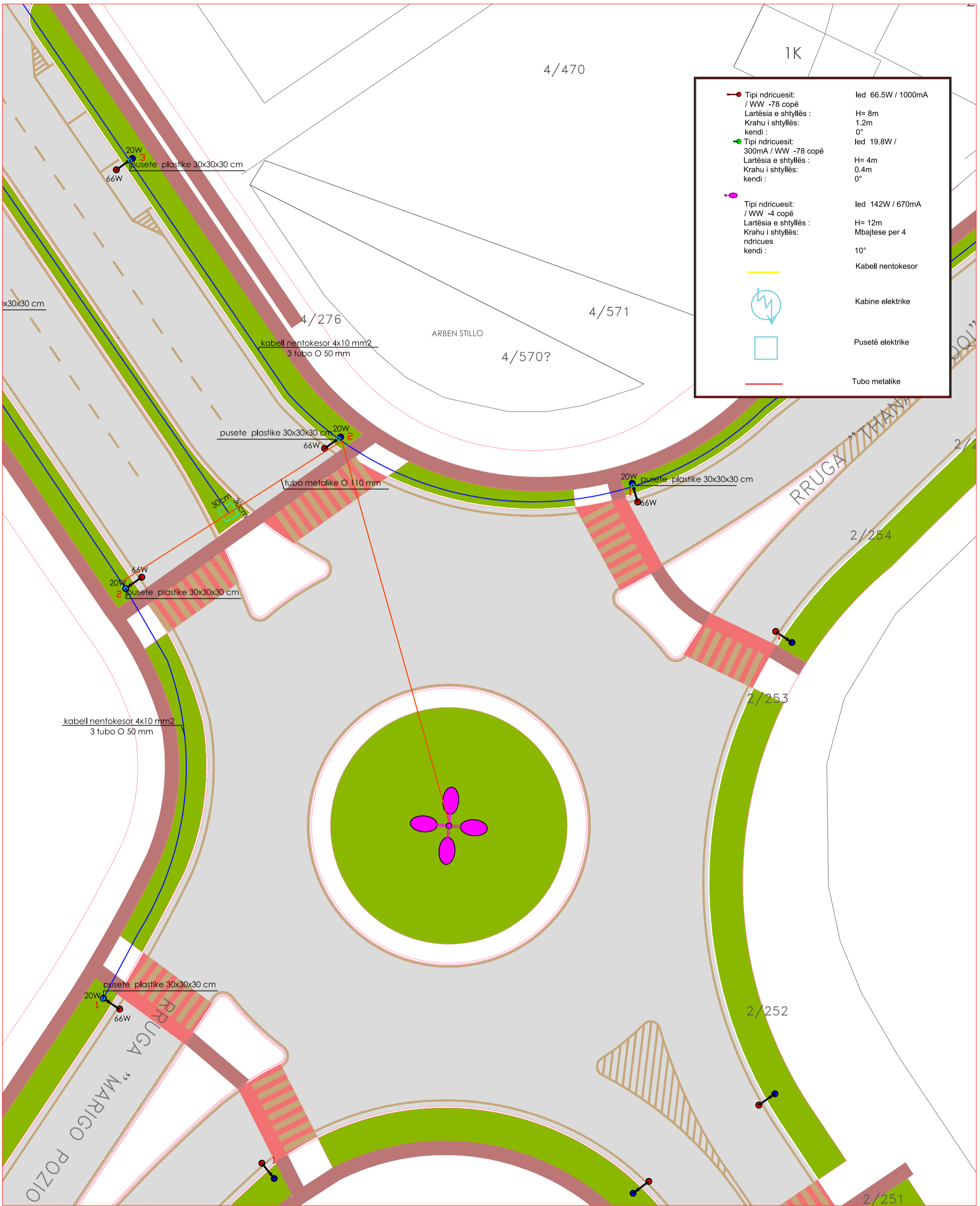

<ul style="list-style-type: none"> Tipi ndricuesit: / WW -78 copë Lartësia e shtyllës: Krahu i shtyllës: kendi : 	<ul style="list-style-type: none"> led 66.5W / 1000mA H= 8m 1.2m 0°
<ul style="list-style-type: none"> Tipi ndricuesit: 300mA / WW -78 copë Lartësia e shtyllës: Krahu i shtyllës: kendi : 	<ul style="list-style-type: none"> led 19.8W / H= 4m 0.4m 0°
<ul style="list-style-type: none"> Tipi ndricuesit: / WW -4 copë Lartësia e shtyllës: Krahu i shtyllës: ndricues kendi : 	<ul style="list-style-type: none"> led 142W / 670mA H= 12m Mbajtese per 4 10°
	Kabell nentokesor
	Kabine elektrike
	Pusetë elektrike
	Tubo metalike



REPUBLIKA E SHQIPERISE
BASHKIA KORCE
 DREJTORIA E PLANIFIKIMIT URBAN
 TE TERRITORIT

Objekti: RIKONSTRUKSION I NDRICIMIT RRUGA " MUZAKAJT"
 Emertimi: PLANIMETRIA E NDRICIMIT
 Shkalla: 1:300 Data: 2022

DREJTORI D.P.P.K.Z.H.U.	ZHANETA LUBONJA	Fleta E-01-01
AUTORET E PROJEKTIT	Ing.el.Vilma Pepo Ark. Arsen Qosja	



	Tipi ndricuesit: / WW -78 copë Lartësia e shtyllës : Krahu i shtyllës: kendi :	led 66.5W / 1000mA H= 8m 1.2m 0°
	Tipi ndricuesit: 300mA / WW -78 copë Lartësia e shtyllës : Krahu i shtyllës: kendi :	led 19.8W / H= 4m 0.4m 0°
	Tipi ndricuesit: / WW -4 copë Lartësia e shtyllës : Krahu i shtyllës: ndricues kendi :	led 142W / 670mA H= 12m Mbajtese per 4 10°
		Kabell nentokesor
		Kabine elektrike
		Pusetë elektrike
		Tubo metalike

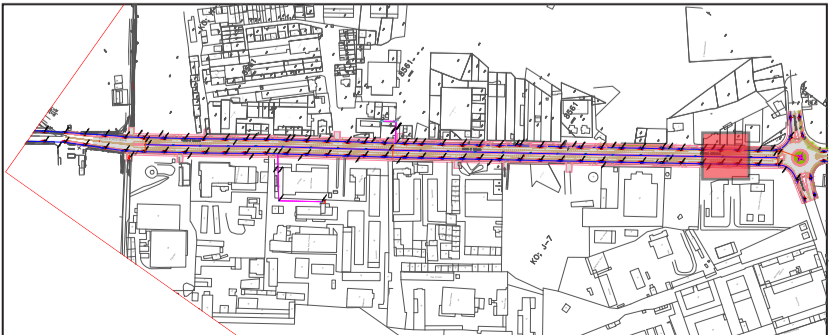

REPUBLIKA E SHQIPERISE
BASHKIA KORCE
 DREJTORIA E PLANIFIKIMIT URBAN
 TE TERRITORIT

Objekti: RIKONSTRUKSION I NDRICIMIT RRUGA " MUZAKAJT"
 Emertimi: PLANIMETRIA E NDRICIMIT
 Shkalla: 1:300 Data: 2022

DREJTORI I D.P.P.K.Z.H.U.	ZHANETA LUBONJA	Fleta E-01-02
AUTORET E PROJEKTIT		Ing.el.Vilma Pepo Ark. Arsen Qosja

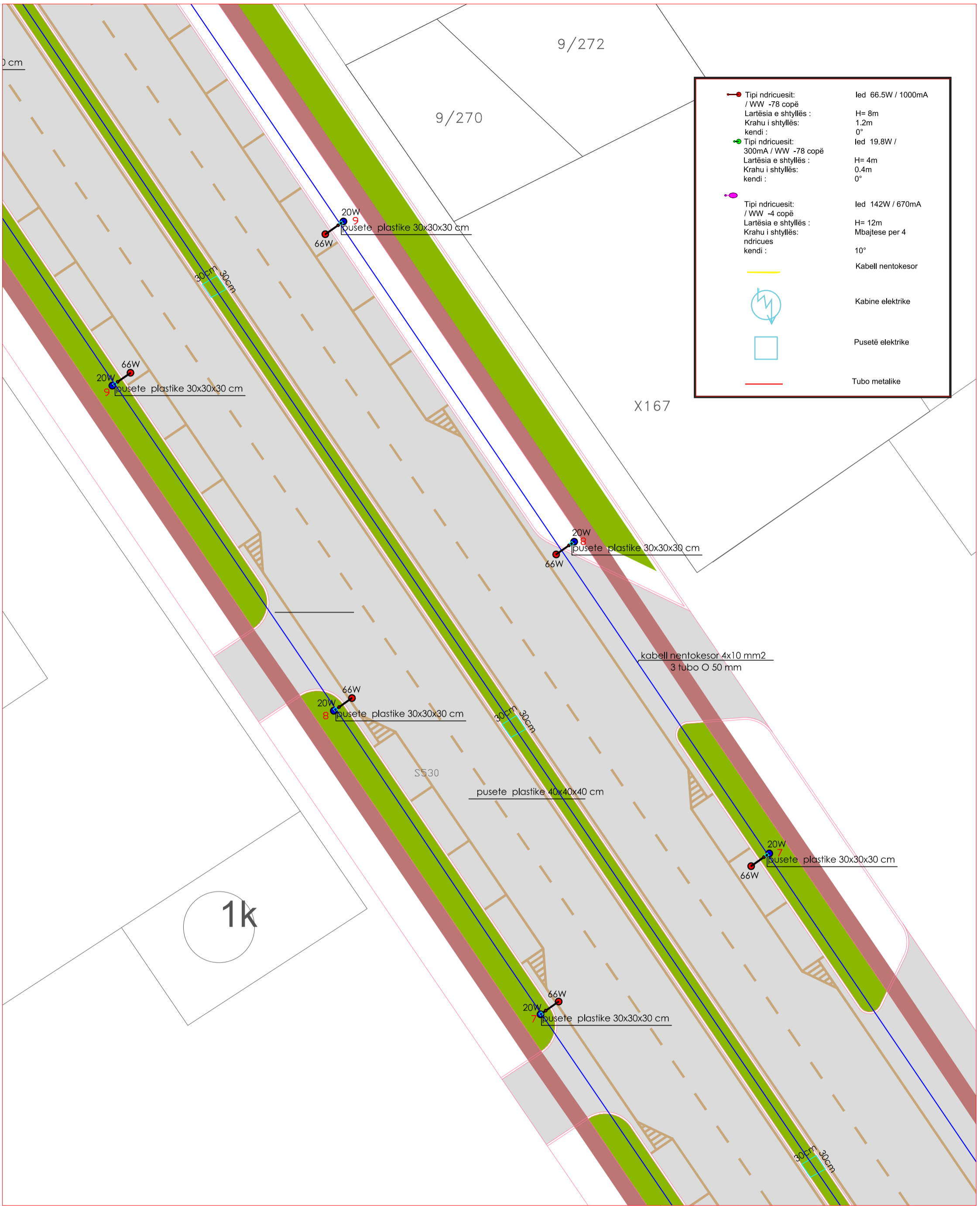

<ul style="list-style-type: none"> Tipi ndricuesit: / WW -78 copë Lartësia e shtyllës: Krahu i shtyllës: kendi : 	<ul style="list-style-type: none"> led 66.5W / 1000mA H= 8m 1.2m 0°
<ul style="list-style-type: none"> Tipi ndricuesit: 300mA / WW -78 copë Lartësia e shtyllës: Krahu i shtyllës: kendi : 	<ul style="list-style-type: none"> led 19.8W / H= 4m 0.4m 0°
<ul style="list-style-type: none"> Tipi ndricuesit: / WW -4 copë Lartësia e shtyllës: Krahu i shtyllës: ndricues kendi : 	<ul style="list-style-type: none"> led 142W / 670mA H= 12m Mbajtese per 4 10°
	Kabell nentokesor
	Kabine elektrike
	Pusete elektrike
	Tubo metalike



 <p>REPUBLIKA E SHQIPERISE BASHKIA KORCE</p> <p>DREJTORIA E PLANIFIKIMIT URBAN TE TERRITORIT</p>	
Objekti:	RIKONSTRUKSION I NDRICIMIT RRUGA " MUZAKAJT "
Emertimi:	PLANIMETRIA E NDRICIMIT
Shkalla:	1:300 Data: 2022

DREJTORI I D.P.P.K.Z.H.U.	ZHANETA LUBONJA	Fleta E-01-03
AUTORET E PROJEKTIT		Ing.el.Vilma Pepo Ark. Arsen Qosja

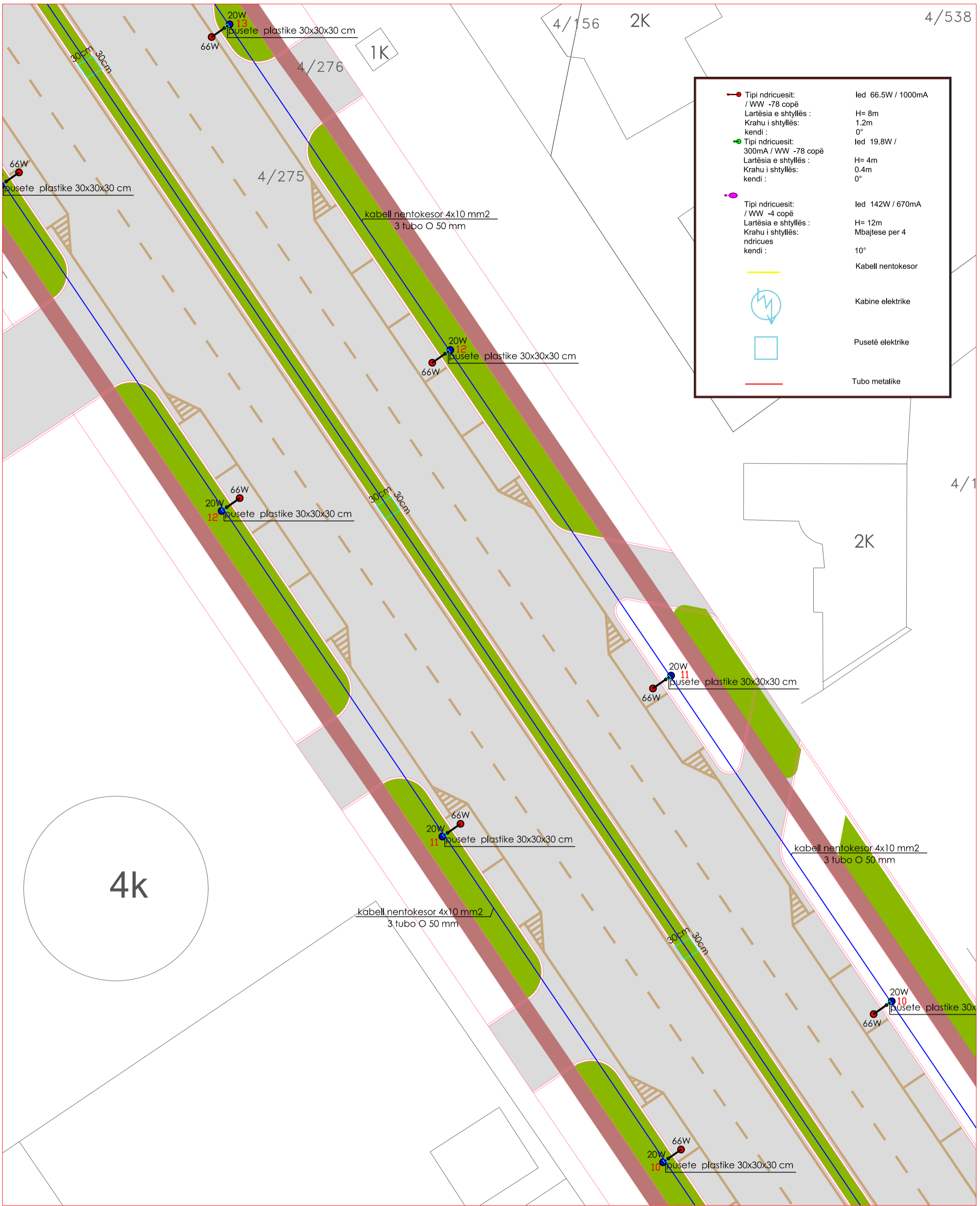

	Tipi ndricuesit: / WW -78 copë Lartësia e shtyllës : Krahu i shtyllës: kendi :	led 66.5W / 1000mA H= 8m 1.2m 0°
	Tipi ndricuesit: 300mA / WW -78 copë Lartësia e shtyllës : Krahu i shtyllës: kendi :	led 19.8W / H= 4m 0.4m 0°
	Tipi ndricuesit: / WW -4 copë Lartësia e shtyllës : Krahu i shtyllës: ndricues kendi :	led 142W / 670mA H= 12m Mbjatese per 4 10°
		Kabell nentokesor
		Kabine elektrike
		Pusetë elektrike
		Tubo metalike



REPUBLIKA E SHQIPERISE
BASHKIA KORCE

DREJTORIA E PLANIFIKIMIT URBAN
TE TERRITORIT

Objekti: RIKONSTRUKSION I NDRICIMIT RRUGA " MUZAKAJT"
Emertimi: PLANIMETRIA E NDRICIMIT
Shkalla: 1:300 Data: 2022

DREJTORI I D.P.P.K.Z.H.U.	ZHANETA LUBONJA	Fleta E-01-04
AUTORET E PROJEKTIT		Ing.el.Vilma Pepo Ark. Arsen Qosja

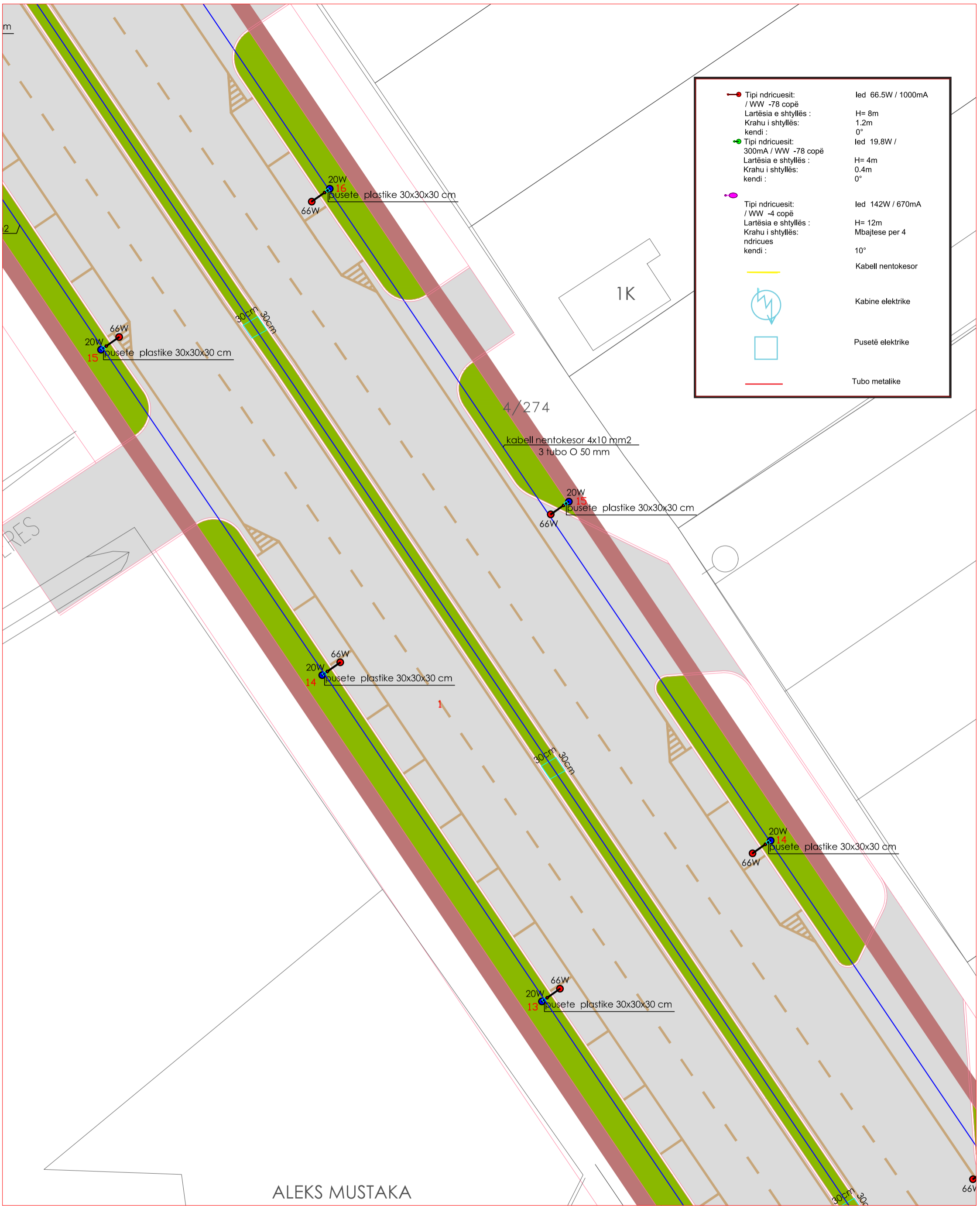

<ul style="list-style-type: none"> Tipi ndricuesit: / WW -78 copë Lartësia e shtyllës: Krahu i shtyllës: kendi : 	<ul style="list-style-type: none"> led 66.5W / 1000mA H= 8m 1.2m 0°
<ul style="list-style-type: none"> Tipi ndricuesit: 300mA / WW -78 copë Lartësia e shtyllës: Krahu i shtyllës: kendi : 	<ul style="list-style-type: none"> led 19.8W / H= 4m 0.4m 0°
<ul style="list-style-type: none"> Tipi ndricuesit: / WW -4 copë Lartësia e shtyllës: Krahu i shtyllës: ndricues kendi : 	<ul style="list-style-type: none"> led 142W / 670mA H= 12m Mbajtëse per 4 10°
	Kabell nentokesor
	Kabine elektrike
	Pusetë elektrike
	Tube metalike

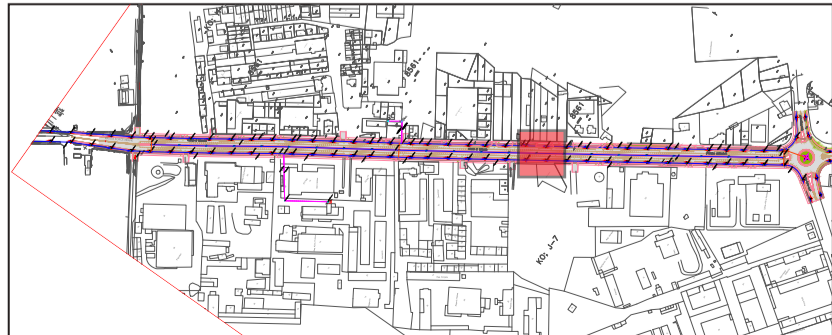

REPUBLIKA E SHQIPERISE
BASHKIA KORCE
 DREJTORIA E PLANIFIKIMIT URBAN
 TE TERRITORIT

Objekti: RIKONSTRUKSION I NDRICIMIT RRUGA " MUZAKAJT"
 Emertimi: PLANIMETRIA E NDRICIMIT
 Shkalla: 1:300 Data: 2022

DREJTORI I D.P.P.K.Z.H.U.	ZHANETA LUBONJA	Fleta E-01-05
AUTORET E PROJEKтит		Ing.el.Vilma Pepo Ark. Arsen Qosja



<ul style="list-style-type: none"> Tipi ndricuesit: / WW -78 copë Lartësia e shtyllës: Krahu i shtyllës: kendi : 	<ul style="list-style-type: none"> led 66.5W / 1000mA H= 8m 1.2m 0°
<ul style="list-style-type: none"> Tipi ndricuesit: 300mA / WW -78 copë Lartësia e shtyllës: Krahu i shtyllës: kendi : 	<ul style="list-style-type: none"> led 19.8W / H= 4m 0.4m 0°
<ul style="list-style-type: none"> Tipi ndricuesit: / WW -4 copë Lartësia e shtyllës: Krahu i shtyllës: ndricues kendi : 	<ul style="list-style-type: none"> led 142W / 670mA H= 12m Mbajtëse per 4 10°
	Kabell nentokesor
	Kabine elektrike
	Pusetë elektrike
	Tabo metalike

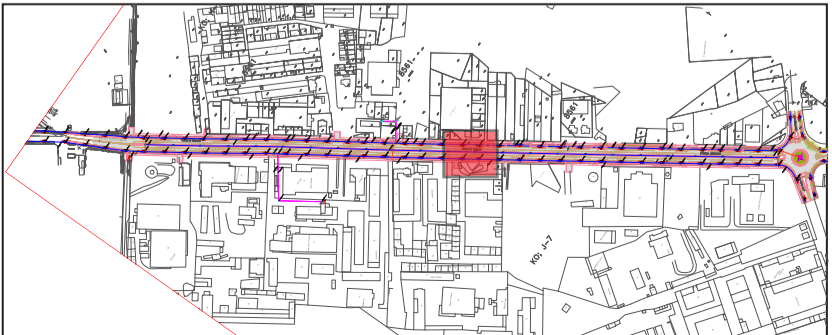

REPUBLIKA E SHQIPERISE
BASHKIA KORCE
 DREJTORIA E PLANIFIKIMIT URBAN
 TE TERRITORIT

Objekti: RIKONSTRUKSION I NDRICIMIT RRUGA " MUZAKAJT"
 Emertimi: PLANIMETRIA E NDRICIMIT
 Shkalla: 1:300 Data: 2022

DREJTORI
 I
 D.P.P.K.Z.H.U.

ZHANETA LUBONJA

Fleta
 E-01-06

**AUTORET
 E PROJEKTIT**

Ing.el.Vilma Pepo
 Ark. Arsen Qosja

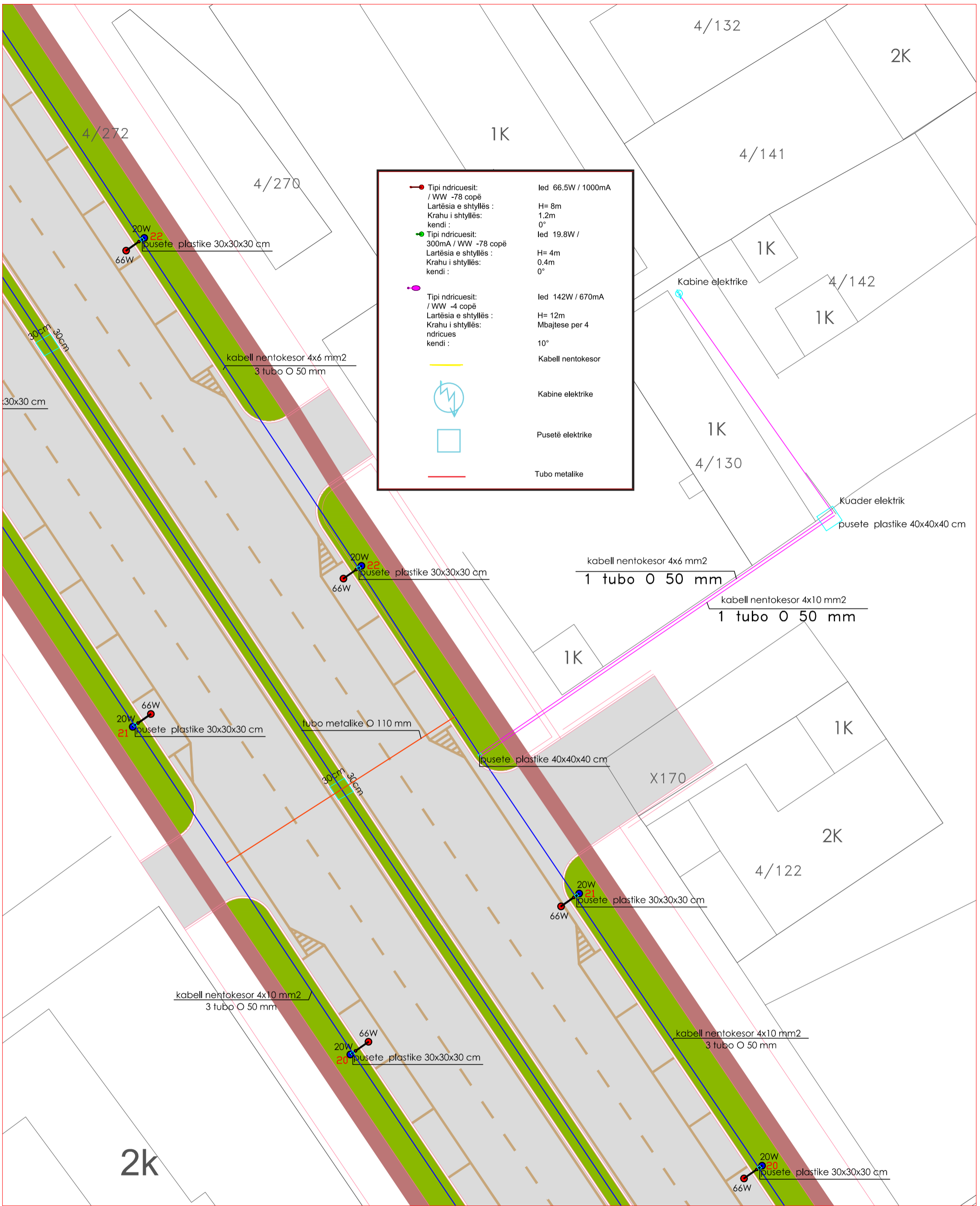

<ul style="list-style-type: none"> Tipi ndricuesit: / WW -78 copë Lartësia e shtyllës: Krahu i shtyllës: kendi : 	<ul style="list-style-type: none"> Ied 66.5W / 1000mA H= 8m 1.2m 0°
<ul style="list-style-type: none"> Tipi ndricuesit: 300mA / WW -78 copë Lartësia e shtyllës: Krahu i shtyllës: kendi : 	<ul style="list-style-type: none"> Ied 19.8W / H= 4m 0.4m 0°
<ul style="list-style-type: none"> Tipi ndricuesit: / WW -4 copë Lartësia e shtyllës: Krahu i shtyllës: ndricues kendi : 	<ul style="list-style-type: none"> Ied 142W / 670mA H= 12m Mbajtese per 4 10°
	Kablentokesor
	Kabine elektrike
	Pusetë elektrike
	Tubo metalike



REPUBLIKA E SHQIPERISE
BASHKIA KORCE
 DREJTORIA E PLANIFIKIMIT URBAN
 TE TERRITORIT

Objekti: RIKONSTRUKSION I NDRICIMIT RRUGA " MUZAKAJT"
 Emertimi: PLANIMETRIA E NDRICIMIT
 Shkalla: 1:300 Data: 2022

DREJTORI I D.P.P.K.Z.H.U.	ZHANETA LUBONJA	Fleta E-01-07
AUTORET E PROJEKTIT		Ing.el.Vilma Pepo Ark. Arsen Qosja

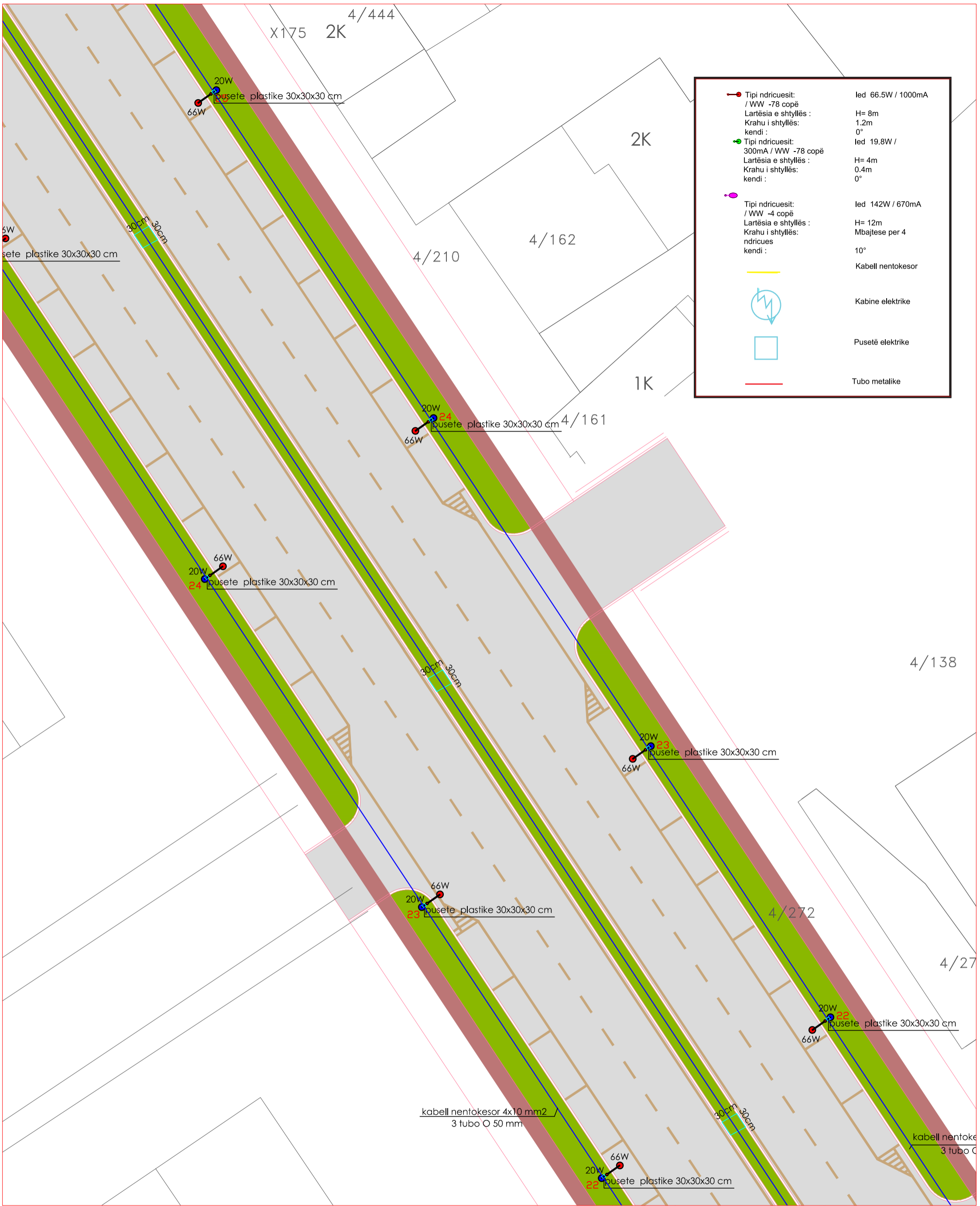

<ul style="list-style-type: none"> Tipi ndricuesit: / WW -78 copë Lartësia e shtyllës: Krahu i shtyllës: kendi : 	<ul style="list-style-type: none"> led 66.5W / 1000mA H= 8m 1.2m 0°
<ul style="list-style-type: none"> Tipi ndricuesit: 300mA / WW -78 copë Lartësia e shtyllës: Krahu i shtyllës: kendi : 	<ul style="list-style-type: none"> led 19.8W / H= 4m 0.4m 0°
<ul style="list-style-type: none"> Tipi ndricuesit: / WW -4 copë Lartësia e shtyllës: ndricues kendi : 	<ul style="list-style-type: none"> led 142W / 670mA H= 12m Mbajtëse per 4 10°
	Kabell nentokesor
	Kabine elektrike
	Pusetë elektrike
	Tubo metalike

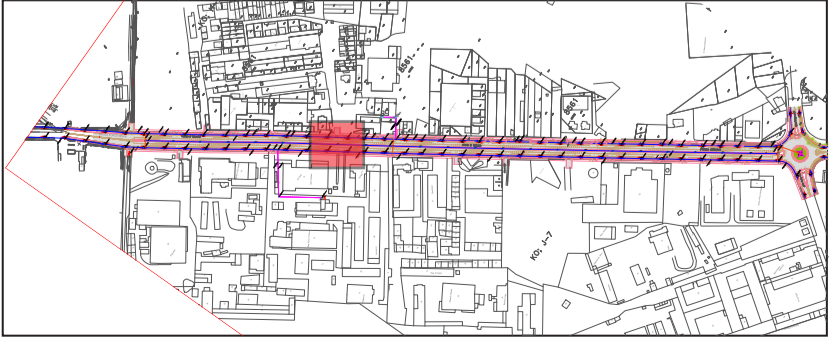

REPUBLIKA E SHQIPERISE
BASHKIA KORCE

DREJTORIA E PLANIFIKIMIT URBAN
TE TERRITORIT

Objekti: RIKONSTRUKSION I NDRICIMIT RRUGA " MUZAKAJT "

Emertimi: PLANIMETRIA E NDRICIMIT

Shkalla: 1:300 Data: 2022

DREJTORI D.P.P.K.Z.H.U.	ZHANETA LUBONJA	Fleta E-01-08
AUTORET E PROJEKTTIT		Ing.el.Vilma Pepo Ark. Arsen Qosja

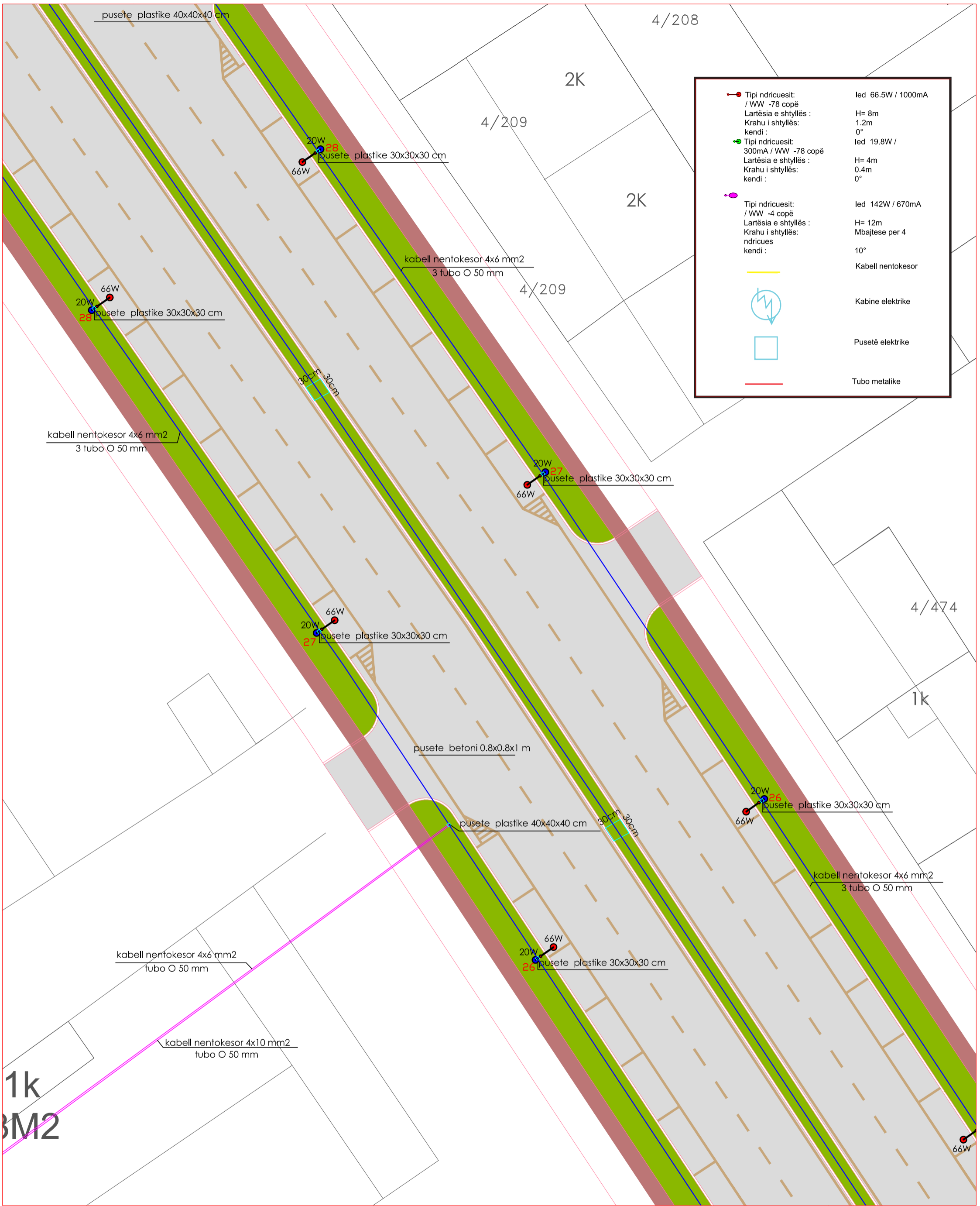

<ul style="list-style-type: none"> Tipi ndricuesit: / WW -78 copë Lartësia e shtyllës: Krahu i shtyllës: kendi : 	<ul style="list-style-type: none"> led 66.5W / 1000mA H= 8m 1.2m 0°
<ul style="list-style-type: none"> Tipi ndricuesit: 300mA / WW -78 copë Lartësia e shtyllës: Krahu i shtyllës: kendi : 	<ul style="list-style-type: none"> led 19.8W / H= 4m 0.4m 0°
<ul style="list-style-type: none"> Tipi ndricuesit: / WW -4 copë Lartësia e shtyllës: Krahu i shtyllës: ndricues kendi : 	<ul style="list-style-type: none"> led 142W / 670mA H= 12m Mbajtëse per 4 10°
	Kabell nentokesor
	Kabine elektrike
	Pusetë elektrike
	Tubo metalike



REPUBLIKA E SHQIPERISE
BASHKIA KORCE
 DREJTORIA E PLANIFIKIMIT URBAN
 TE TERRITORIT

Objekti: RIKONSTRUKSION I NDRICIMIT RRUGA " MUZAKAJT"
 Emertimi: PLANIMETRIA E NDRICIMIT
 Shkalla: 1:300 Data: 2022

DREJTORI I D.P.P.K.Z.H.U.	ZHANETA LUBONJA	Fleta E-01-09
AUTORET E PROJEKTIT		Ing.el.Vilma Pepo Ark. Arsen Qosja

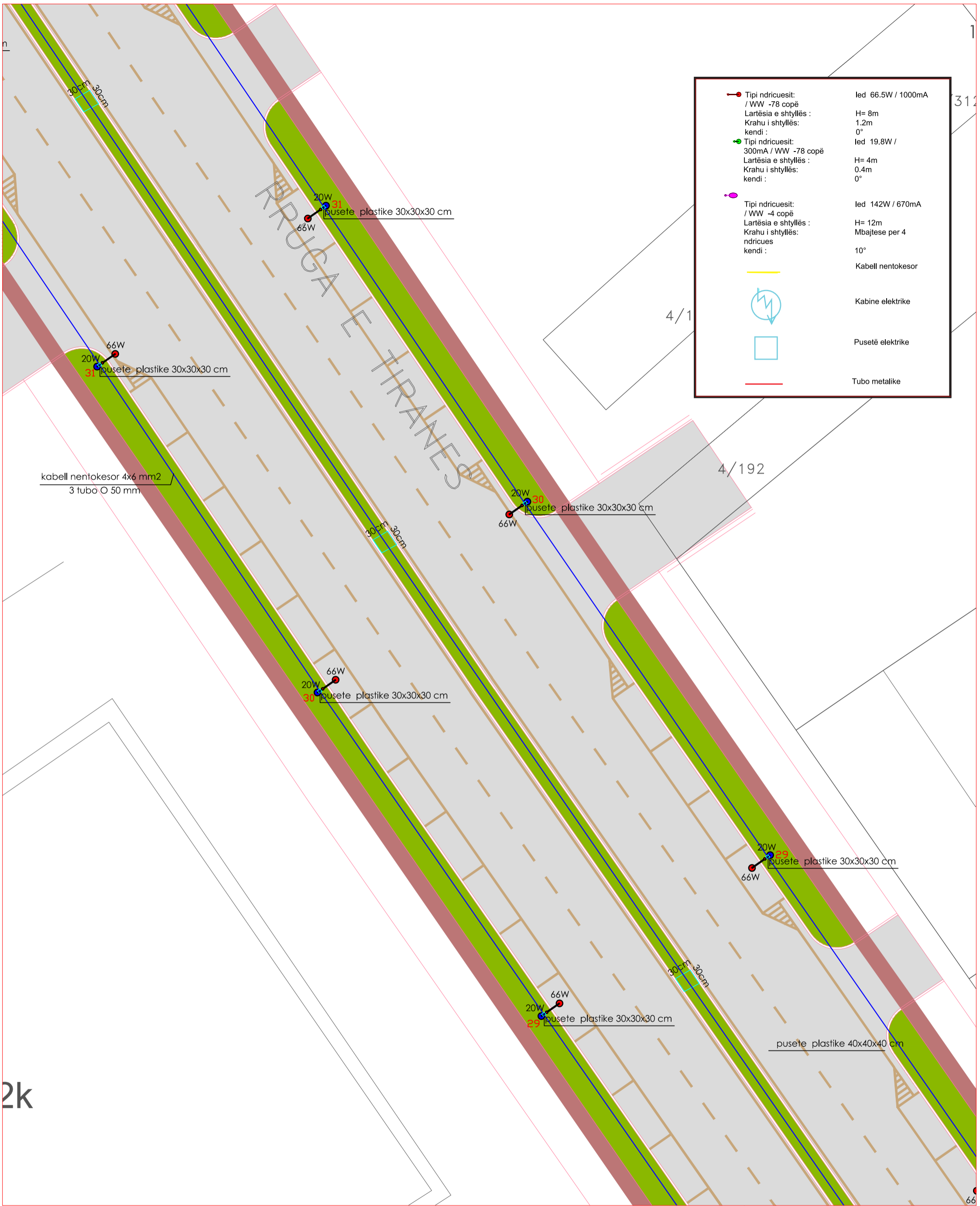

<ul style="list-style-type: none"> Tipi ndricuesit: / WW -78 copë Lartësia e shtyllës: H= 8m Krahu i shtyllës: 1.2m kendi: 0° 	led 66.5W / 1000mA
<ul style="list-style-type: none"> Tipi ndricuesit: 300mA / WW -78 copë Lartësia e shtyllës: H= 4m Krahu i shtyllës: 0.4m kendi: 0° 	led 19.8W /
<ul style="list-style-type: none"> Tipi ndricuesit: / WW -4 copë Lartësia e shtyllës: H= 12m Krahu i shtyllës: Mbajtese per 4 ndricues: 10° kendi: Kabell nentokesor 	led 142W / 670mA
	Kabell nentokesor
	Kabine elektrike
	Pusete elektrike
	Tubo metalike

kabell nentokesor 4x6 mm2
3 tubo O 50 mm

4/192

pusete plastike 40x40x40 cm

2k



REPUBLIKA E SHQIPERISE
BASHKIA KORCE

DREJTORIA E PLANIFIKIMIT URBAN
TE TERRITORIT

Objekti: RIKONSTRUKSION I NDRICIMIT RRUGA " MUZAKAJT "

Emertimi: PLANIMETRIA E NDRICIMIT

Shkalla: 1:300 Data: 2022

DREJTORI I D.P.P.K.Z.H.U.	ZHANETA LUBONJA	Fleta E-01-10
AUTORET E PROJEKTIT		Ing.el.Vilma Pepo Ark. Arsen Qosja

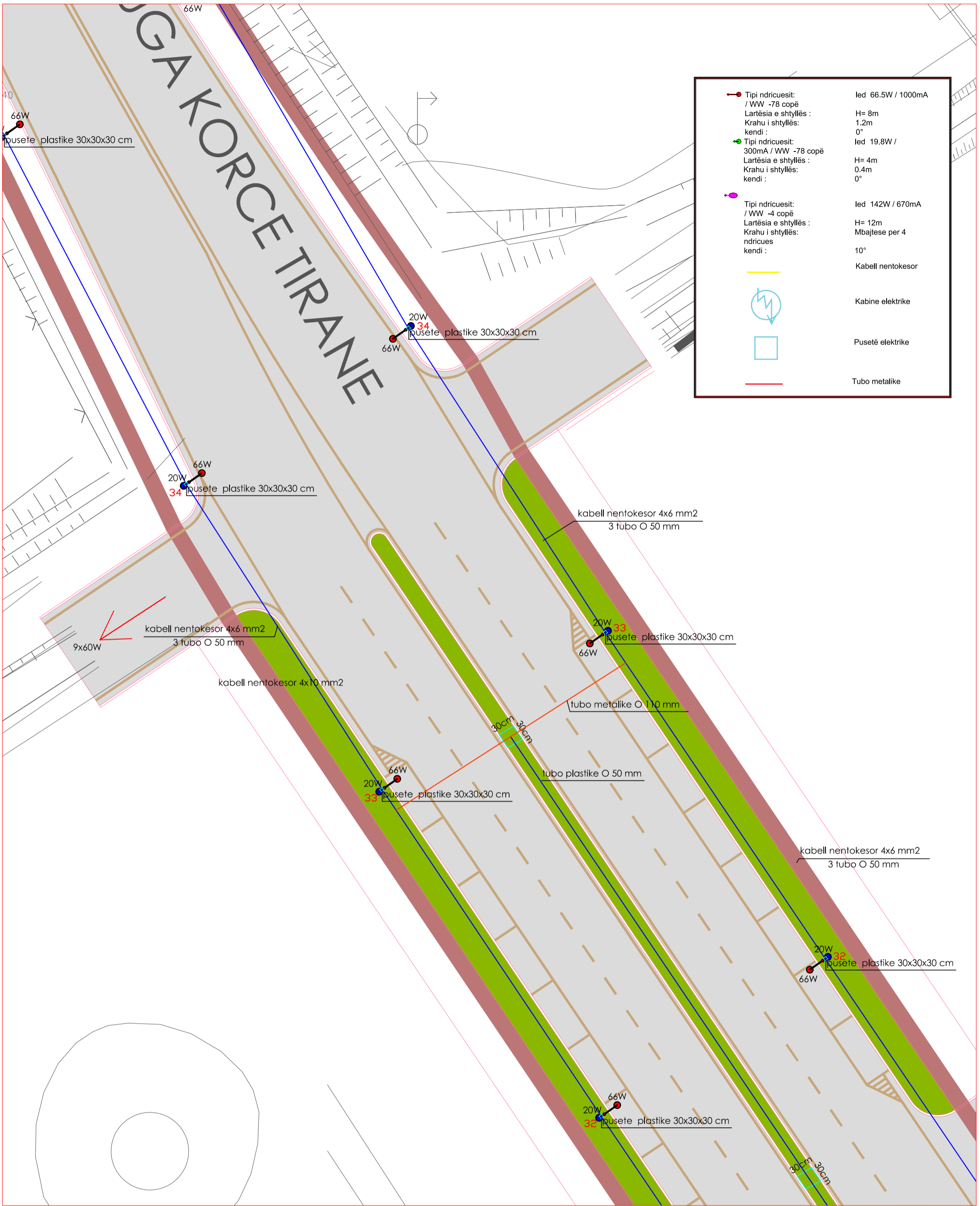

<ul style="list-style-type: none"> Tipi ndricuesit: / WW -78 copë Lartësia e shtyllës: H= 8m Krahu i shtyllës: 1.2m kendi: 0° 	led 66.5W / 1000mA
<ul style="list-style-type: none"> Tipi ndricuesit: 300mA / WW -78 copë Lartësia e shtyllës: H= 4m Krahu i shtyllës: 0.4m kendi: 0° 	led 19.8W /
<ul style="list-style-type: none"> Tipi ndricuesit: / WW -4 copë Lartësia e shtyllës: H= 12m Krahu i shtyllës: Mbajtese per 4 ndricues kendi: 10° 	led 142W / 670mA
	Kabell nentokesor
	Kabine elektrike
	Pusetë elektrike
	Tubo metalike

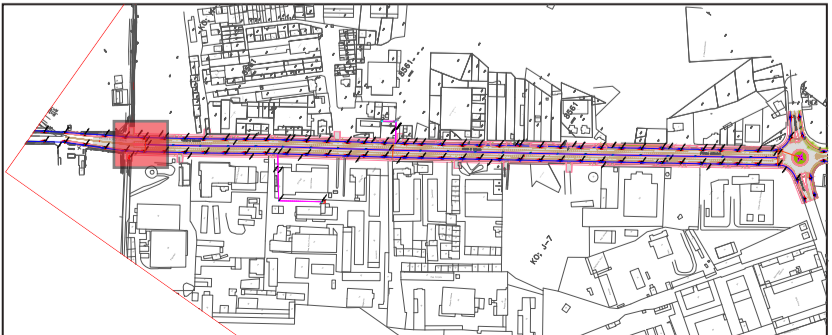

REPUBLIKA E SHQIPERISE
BASHKIA KORÇE

DREJTORIA E PLANIFIKIMIT URBAN
TE TERRITORIT

Objekti: RIKONSTRUKSION I NDRICIMIT RRUGA " MUZAKAJT "

Emertimi: PLANIMETRIA E NDRICIMIT

Shkalla: 1:300 Data: 2022

DREJTORI D.P.P.K.Z.H.U.	ZHANETA LUBONJA	Fleta E-01-11
AUТОRET E PROJEKTIT		Ing.el.Vilma Pepo Ark. Arsen Qosja

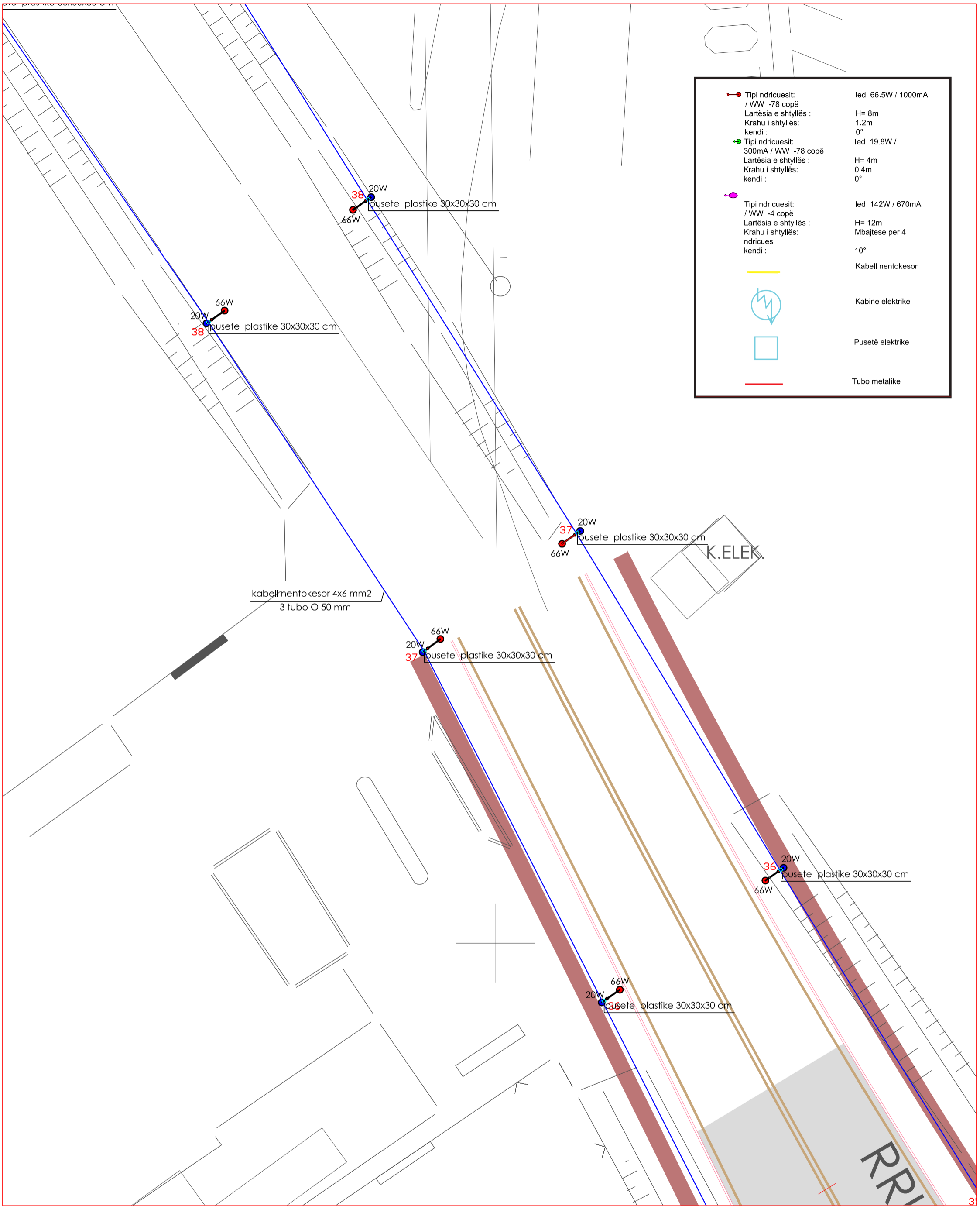

<ul style="list-style-type: none"> Tipi ndricuesit: / WW -78 copë Lartësia e shtyllës: Krahu i shtyllës: kendi : 	<ul style="list-style-type: none"> led 66.5W / 1000mA H= 8m 1.2m 0°
<ul style="list-style-type: none"> Tipi ndricuesit: / WW -78 copë Lartësia e shtyllës: Krahu i shtyllës: kendi : 	<ul style="list-style-type: none"> led 19.8W / H= 4m 0.4m 0°
<ul style="list-style-type: none"> Tipi ndricuesit: / WW -4 copë Lartësia e shtyllës: Krahu i shtyllës: ndricues kendi : 	<ul style="list-style-type: none"> led 142W / 670mA H= 12m Mbajtese per 4 10°
	Kabell nentokesor
	Kabine elektrike
	Pusetë elektrike
	Tubo metalike



REPUBLIKA E SHQIPERISE
BASHKIA KORCE







DREJTORIA E PLANIFIKIMIT URBAN
TE TERRITORIT

Objekti: RIKONSTRUKSION I NDRICIMIT RRUGA " MUZAKAJT "

Emertimi: PLANIMETRIA E NDRICIMIT

Shkalla: 1:300 Data: 2022

DREJTORI I D.P.P.K.Z.H.U.	ZHANETA LUBONJA	Fleta E-01-12
AUTORET E PROJEKTTIT		Ing.el.Vilma Pepo Ark. Arsen Qosja

	Tipi ndricuesit: / WW -78 copë Lartësia e shtyllës: Krahu i shtyllës: kendi :	led 66.5W / 1000mA H= 8m 1.2m 0°
	Tipi ndricuesit: 300mA / WW -78 copë Lartësia e shtyllës: Krahu i shtyllës: kendi :	led 19.8W / H= 4m 0.4m 0°
	Tipi ndricuesit: / WW -4 copë Lartësia e shtyllës: Krahu i shtyllës: ndricues kendi :	led 142W / 670mA H= 12m Mbajtese per 4 10°
		Kabell nentokesor
		Kabine elektrike
		Pusetë elektrike
		Tube metalike

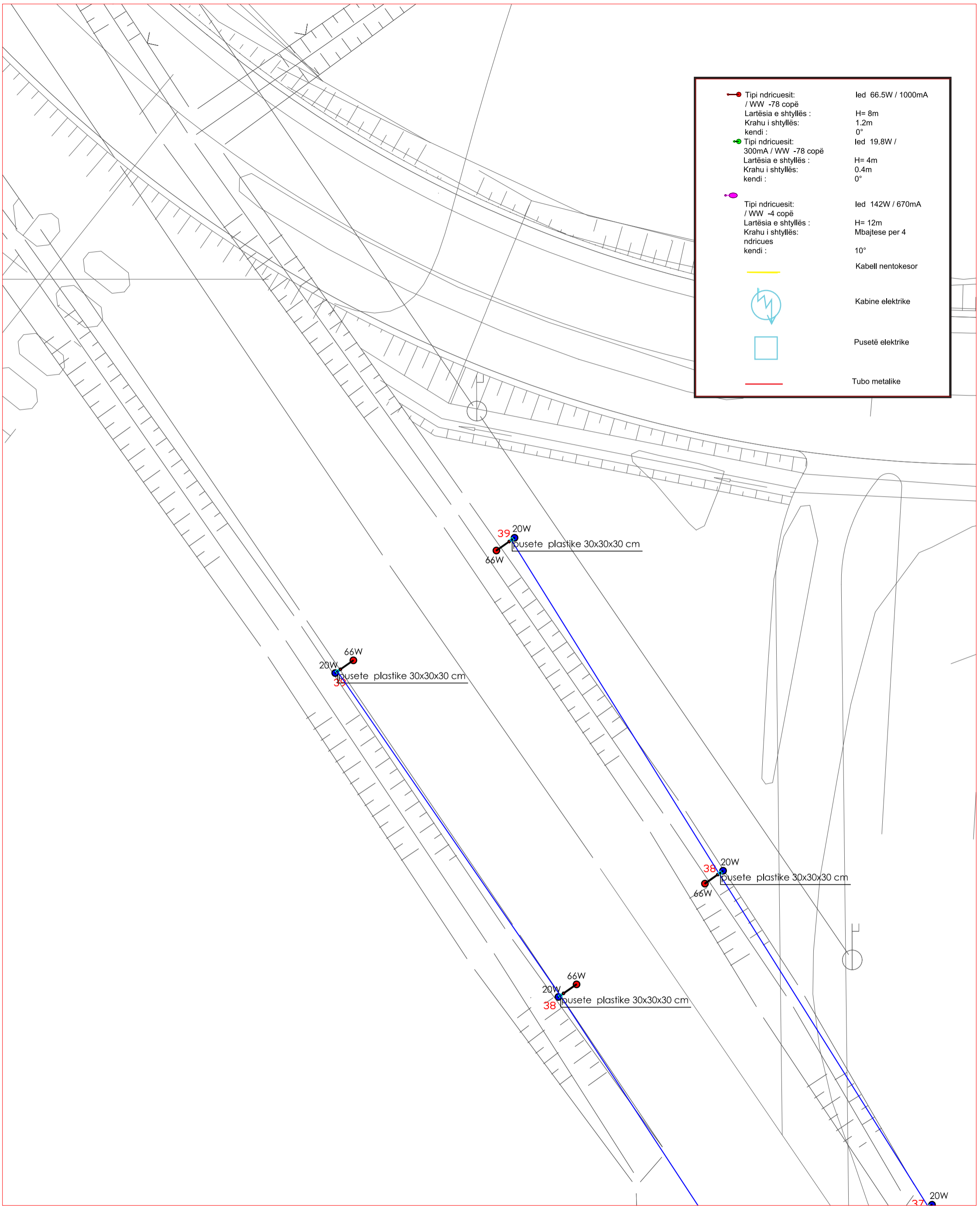

REPUBLIKA E SHQIPERISE
BASHKIA KORCE

DREJTORIA E PLANIFIKIMIT URBAN
TE TERRITORIT

Objekti: RIKONSTRUKSION I NDRICIMIT RRUGA " MUZAKAJT "

Emertimi: PLANIMETRIA E NDRICIMIT

Shkalla: 1:300 Data: 2022

DREJTORI I D.P.P.K.Z.H.U.	ZHANETA LUBONJA	Fleta E-01-13
AUTORET E PROJEKTTIT		Ing.el.Vilma Pepo Ark. Arsen Qosja