

SHTYLLE BETON ARME

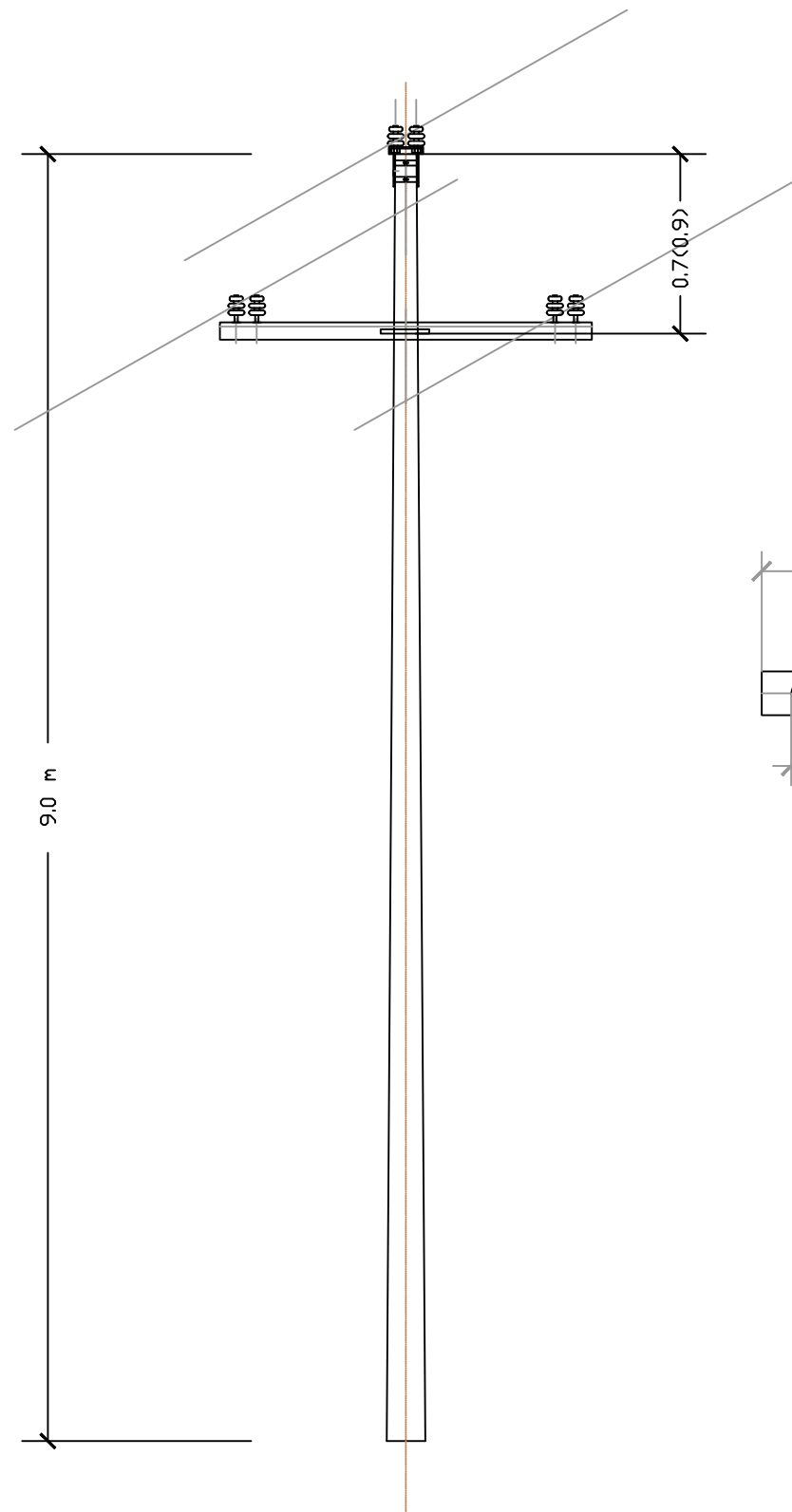

GROPA E SHTYLLES

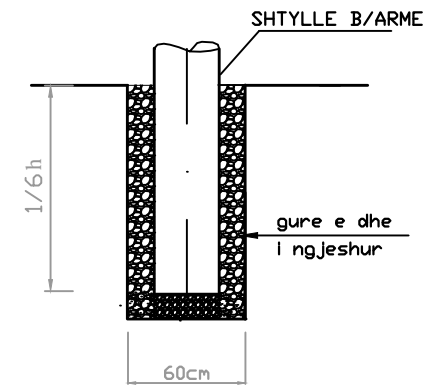

KONSTRUKSIONE METALIKE LINJE

TR A V E R S E

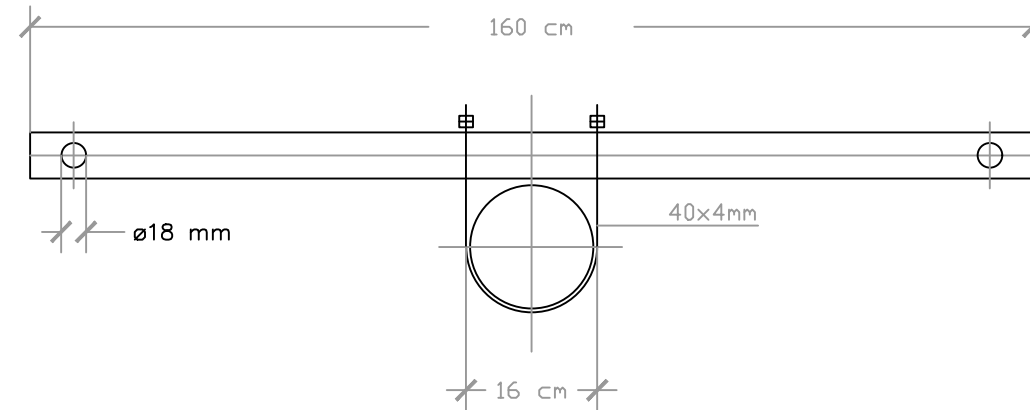

K O K O R E

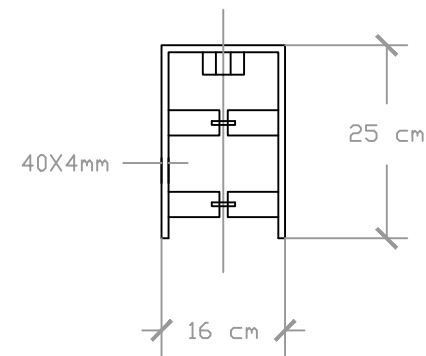

SHTYLLA E FUNDIT E LIDHJES 10KV

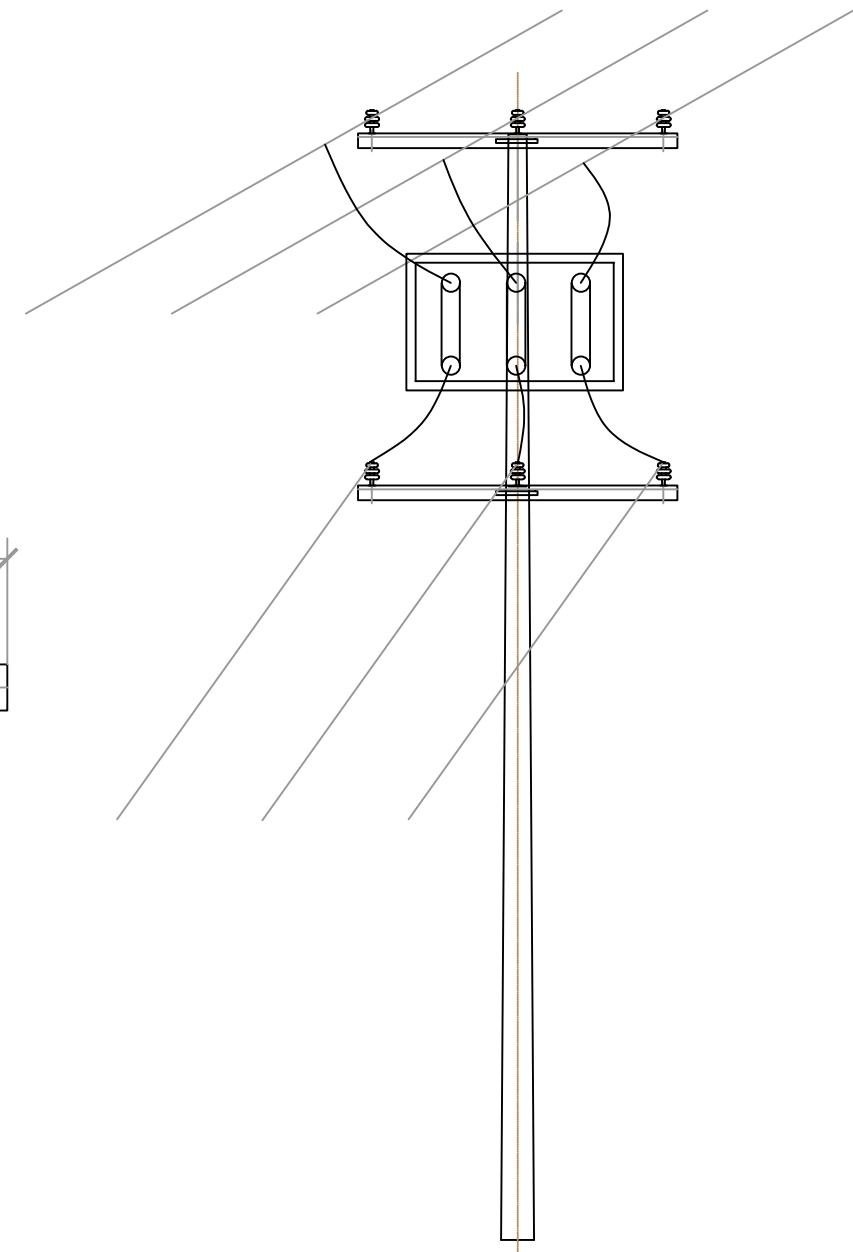

 <b>REPUBLIKA E SHQIPERISE</b> <b>BASHKIA KORCE</b> DREJTORIA E PLANIFIKIMIT URBAN TE TERRITORIT	DREJTORI I D.P.P.K.ZH.U.	ZHANETA LUBONJA	FLETA 01
	Objekti: NDRICIMI I RRUGEVE TE NJESIVE ADMINISTRATIVE Emertimi: DETAJET E SHTYLLES SE BETONIT Data: 2022	<b>AUTORET                  E PROJEKTIT</b>	Ing. el. VILMA PEPO Ark. ARSEN QOSJA

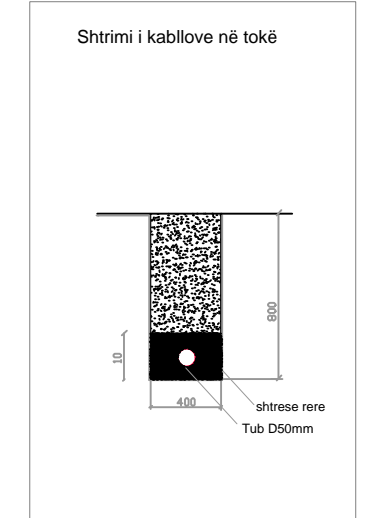
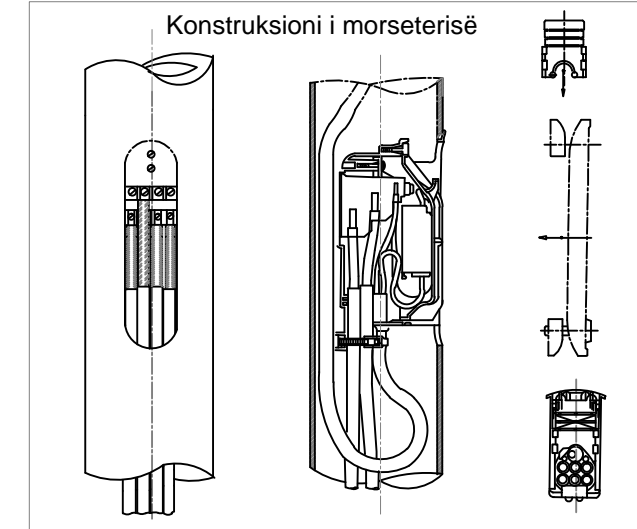
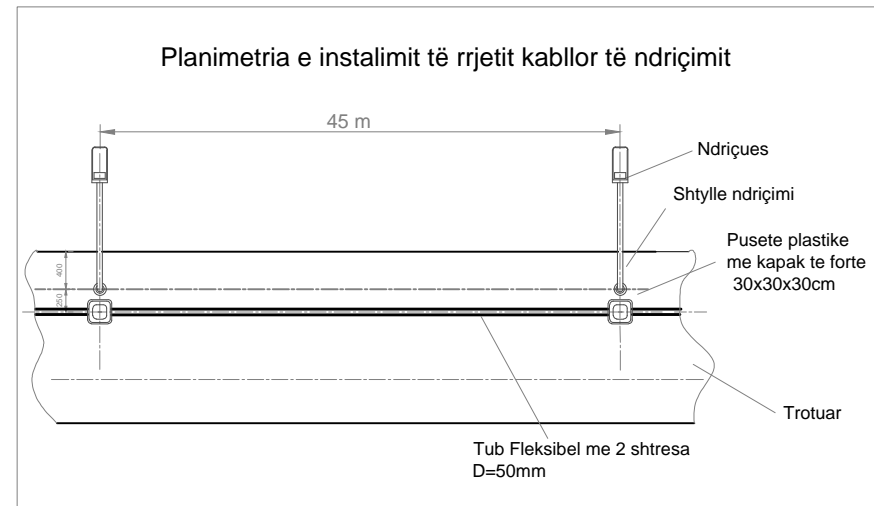
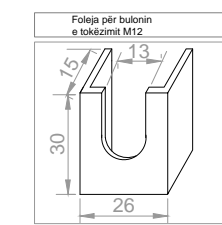
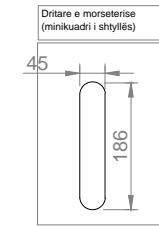
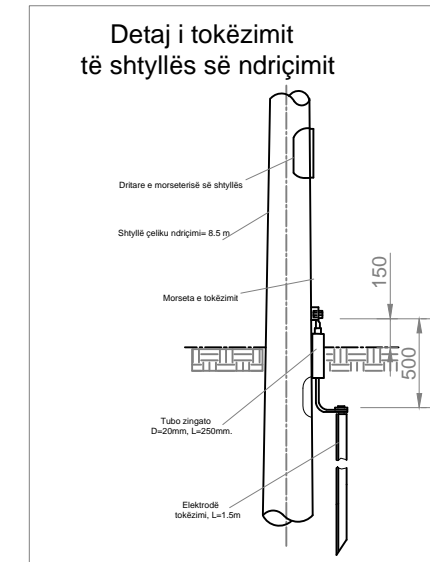
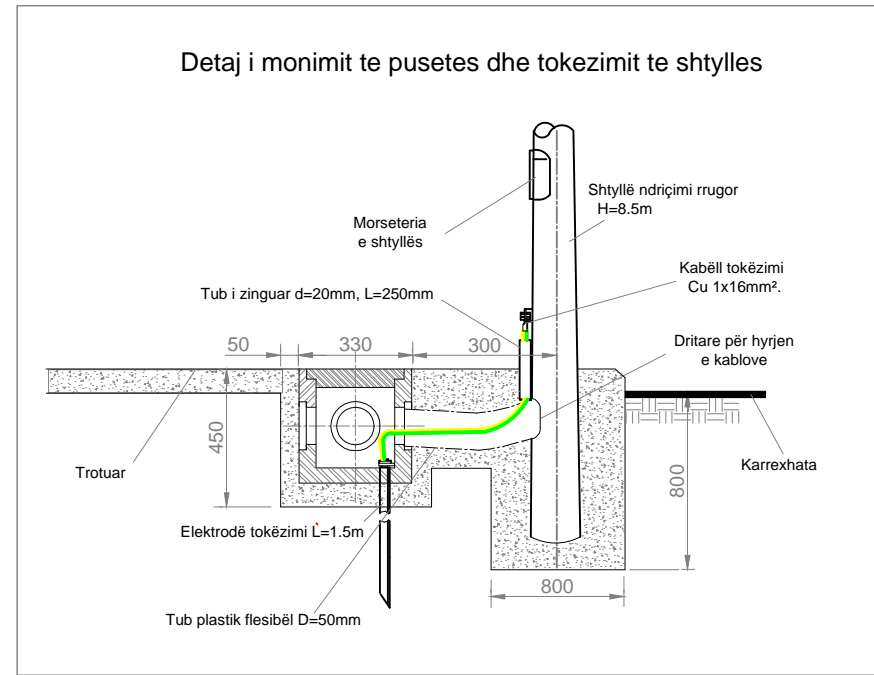
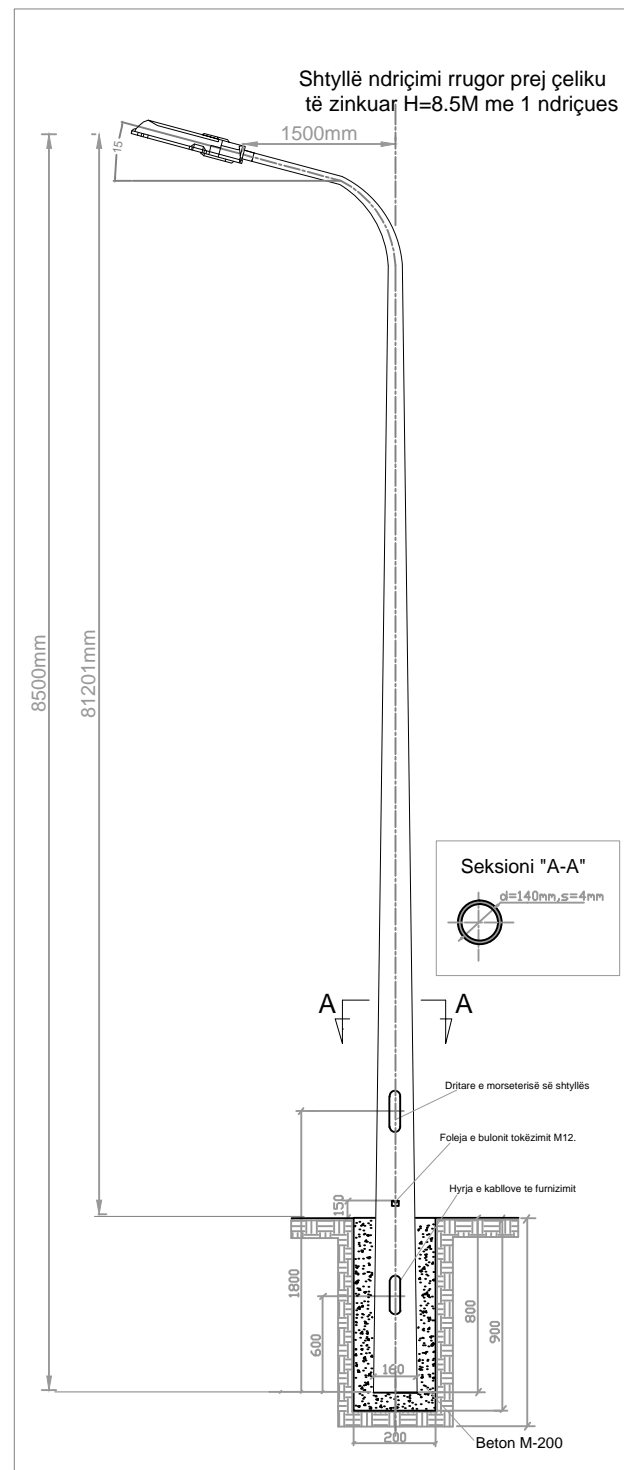

	<b>REPUBLIKA E SHQIPËRISË</b> <b>BASHKIA KORÇË</b> DREJTORIA E PLANIFIKIMIT URBAN TË TERRITORIT	<b>DREJTORI</b>   <b>D.P.P.K.ZH.U.</b>	<b>ZHANETA LUBONJA</b>	FLETA 1.1	
	<b>Objekti:</b> RIKONSTRUKSION I NDIRIÇIMIT "RRUGA SOTIR POLENA" <b>Emërtimi:</b> DETAJE ELEKTRIKE <b>Shkalla:</b>	<b>AUTORËT</b> <b>E PROJEKTIT</b>	<b>Ing.el.Vilma Pepo</b> <b>Ark. Arsen Qosja</b>		
	<b>Data:</b> 2022				

# SKEMA ELEKTRIKE E NDRIÇIMIT TË PANELIT 2 - DALLAMANGO

KABINA ELEKTRIKE 20,6/0.4 kV

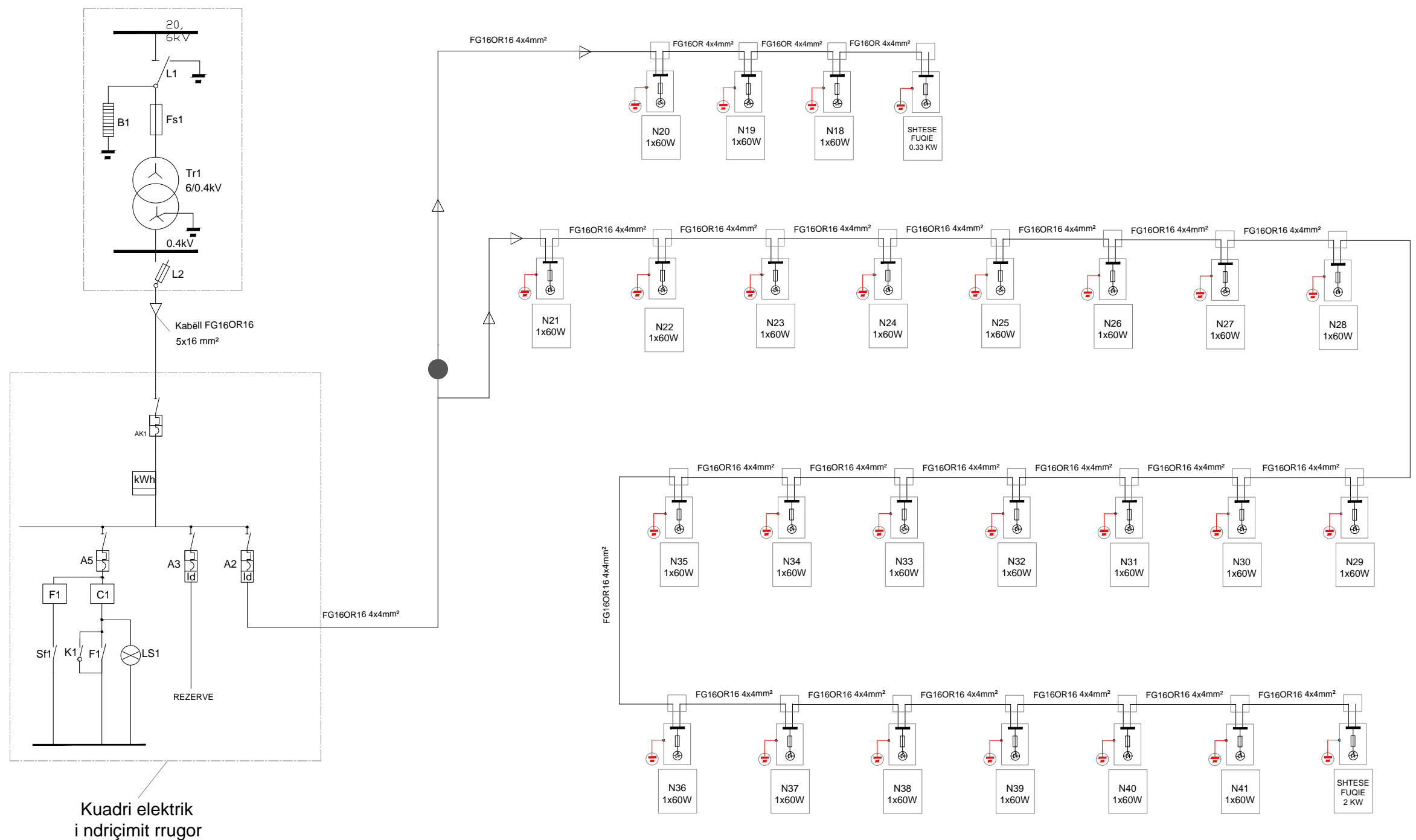

 <p><b>REPUBLIKA E SHQIPERISE</b> <b>BASHKIA KORCE</b> DREJTORIA E PLANIFIKIMIT URBAN TE TERRITORIT</p>	<p>DREJTORI I D.P.P.K.ZH.U.</p>	ZHANETA LUBONJA	Fleta 02
	<p><b>AUORET E PROJEKTIT</b></p>	<p>Ing.el.VILMA PEPO Ark. ARSEN QOSJA</p>	
<p>Objekti: RIKONSTRUKSIONI I NDRIÇIMIT RRUGA "VIKTOR EFTIMIU" Emertimi: SKEMA ELEKTRIKE E NDRIÇIMIT TË PANELIT 1 - DALLAMANGO Shkalla:</p>	<p>Data: 2022</p>		

# SKEMA ELEKTRIKE E NDRIÇIMIT TË PANELIT 1 - JORGANËT

KABINA ELEKTRIKE 20,6/0.4 kV

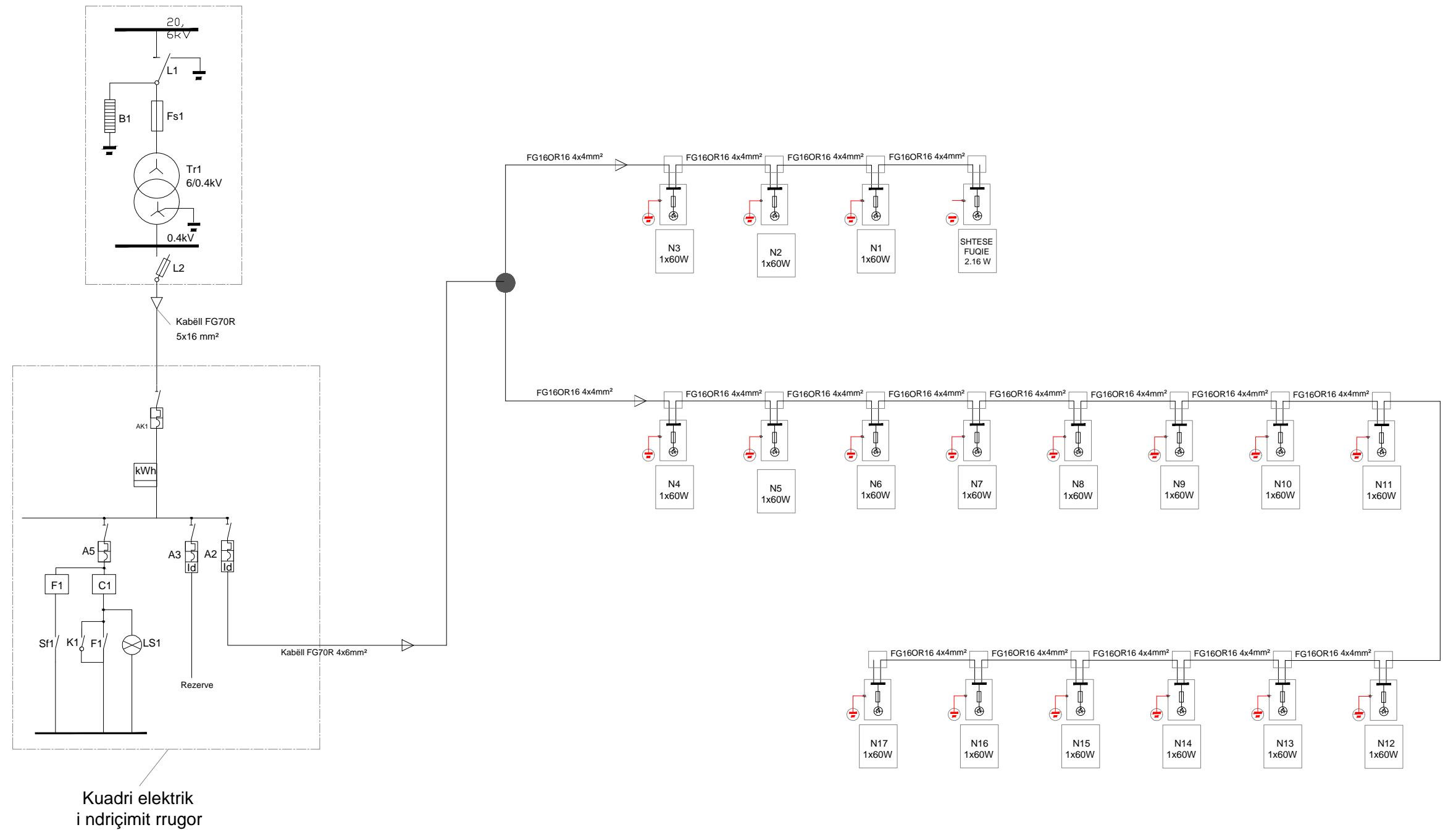

Kuadri elektrik i ndriçimit rrugor

 <b>REPUBLIKA E SHQIPERISE</b> <b>BASHKIA KORCE</b> DREJTORIA E PLANIFIKIMIT URBAN TE TERRITORIT	DREJTORI I D.P.P.K.ZH.U.	ZHANETA LUBONJA	Fleta 01
	Objekti: RIKONSTRUKSIONI I NDRIÇIMIT RRUGA "VIKTOR EFTIMIU" Emertimi: SKEMA ELEKTRIKE E NDRIÇIMIT TË PANELIT 1 - JORGANËT Shkalla: _____ Data: 2022	<b>AUORET                  E PROJEKTIT</b>	Ing.el.VILMA PEPO Ark. ARSEN QOSJA

## SKEMA ELEKTRIKE E NDRIÇIMIT TË PANELIT PERIMORE

KABINA ELEKTRIKE 20,6/0.4 kV

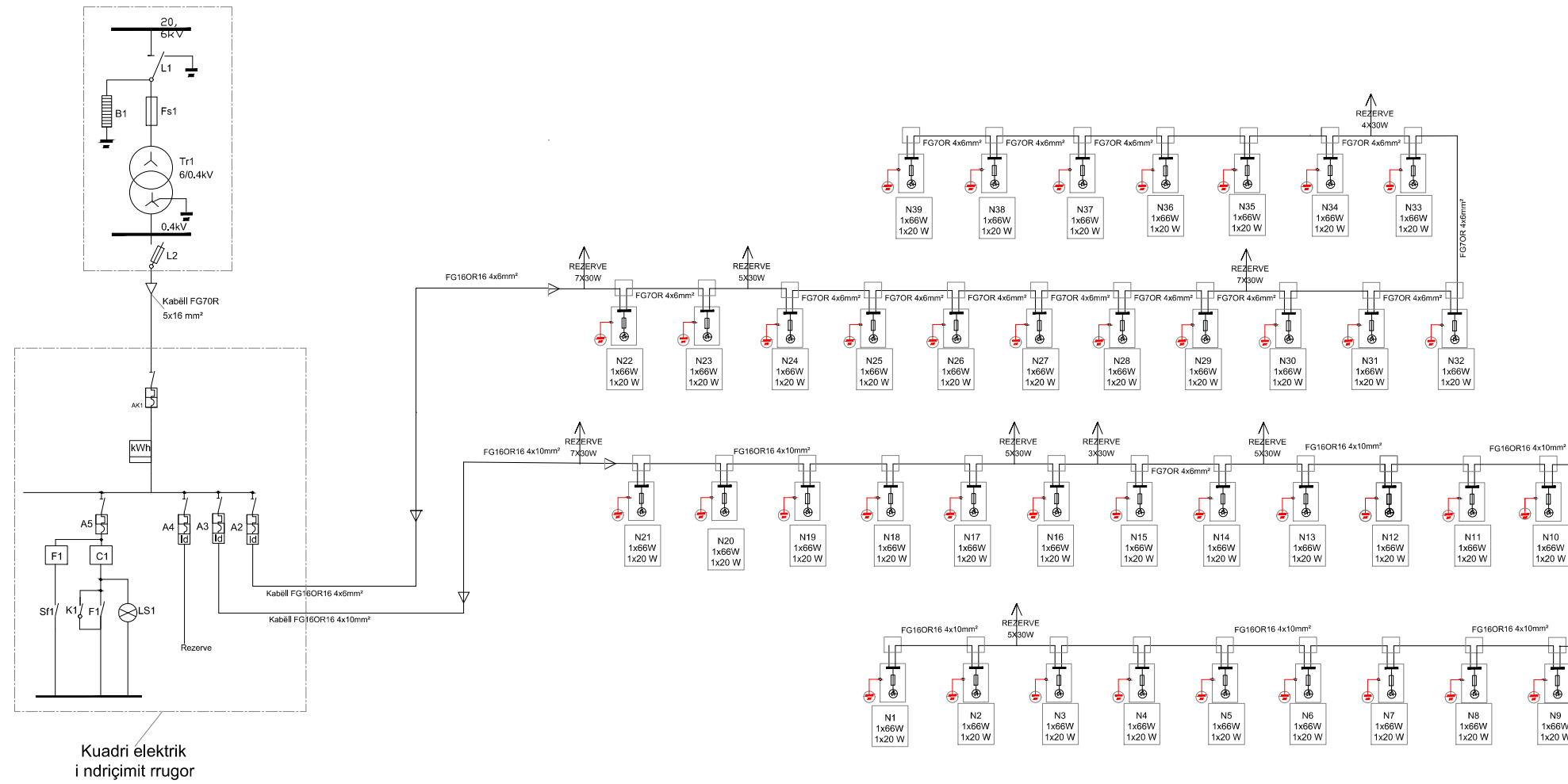

Kuadri elektrik  
i ndriçimit rrugor

	<b>REPUBLIKA E SHQIPËRISË BASHKIA KORÇË</b>	<b>DREJTORI I D.P.P.K.ZH.U.</b>	<b>ZHANETA LUBONJA</b>	<b>FLETA 1</b>
	<b>DREJTORIA E PLANIFIKIMIT URBAN TË TERRITORIT</b>		<b>AUTORËT E PROJEKTIT</b>	
<b>Objekti:</b> RIKONSTRUKSION I NDRIÇIMIT- RRUGA " MUZAKAJT"		<b>Ing.el.Vilma Pepo Ark. Arsen Qose</b>		
<b>Emërtimi:</b> SKEMA ELEKTRIKE E NDRIÇIMIT TË PANELIT PERIMORE				
<b>Shkalla:</b> 1:1		<b>Data:</b> 2022		

## SKEMA ELEKTRIKE E NDRIÇIMIT TË PANELIT SMT

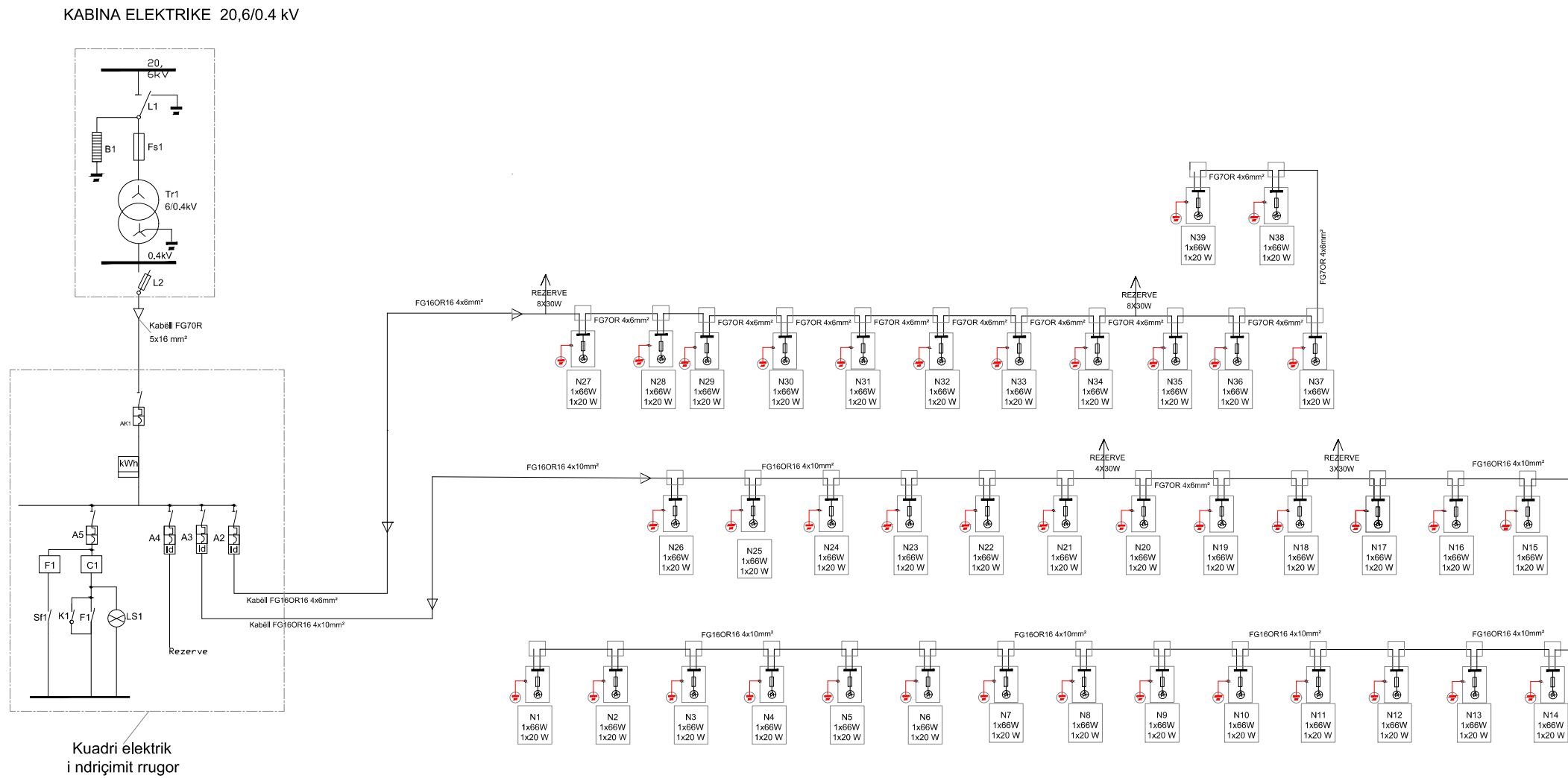

	<b>REPUBLIKA E SHQIPËRISË BASHKIA KORÇË</b>	<b>DREJTORI I D.P.P.K.ZH.U.</b>	<b>ZHANETA LUBONJA</b>	<b>FLETA 2</b>
	<b>DREJTORIA E PLANIFIKIMIT URBAN TË TERRITORIT</b>	<b>AUTORËT E PROJEKTIT</b>		<b>Ing.el.Vilma Pepo Ark. Arsen Qose</b>
<b>Objekti:</b> RIKONSTRUKSION I NDRIÇIMIT- RRUGA " MUZAKAJT"				
<b>Emërtimi:</b> SKEMA ELEKTRIKE E NDRIÇIMIT TË PANELIT SMT				
<b>Shkalla:</b> 1:1		<b>Data:</b> 2022		







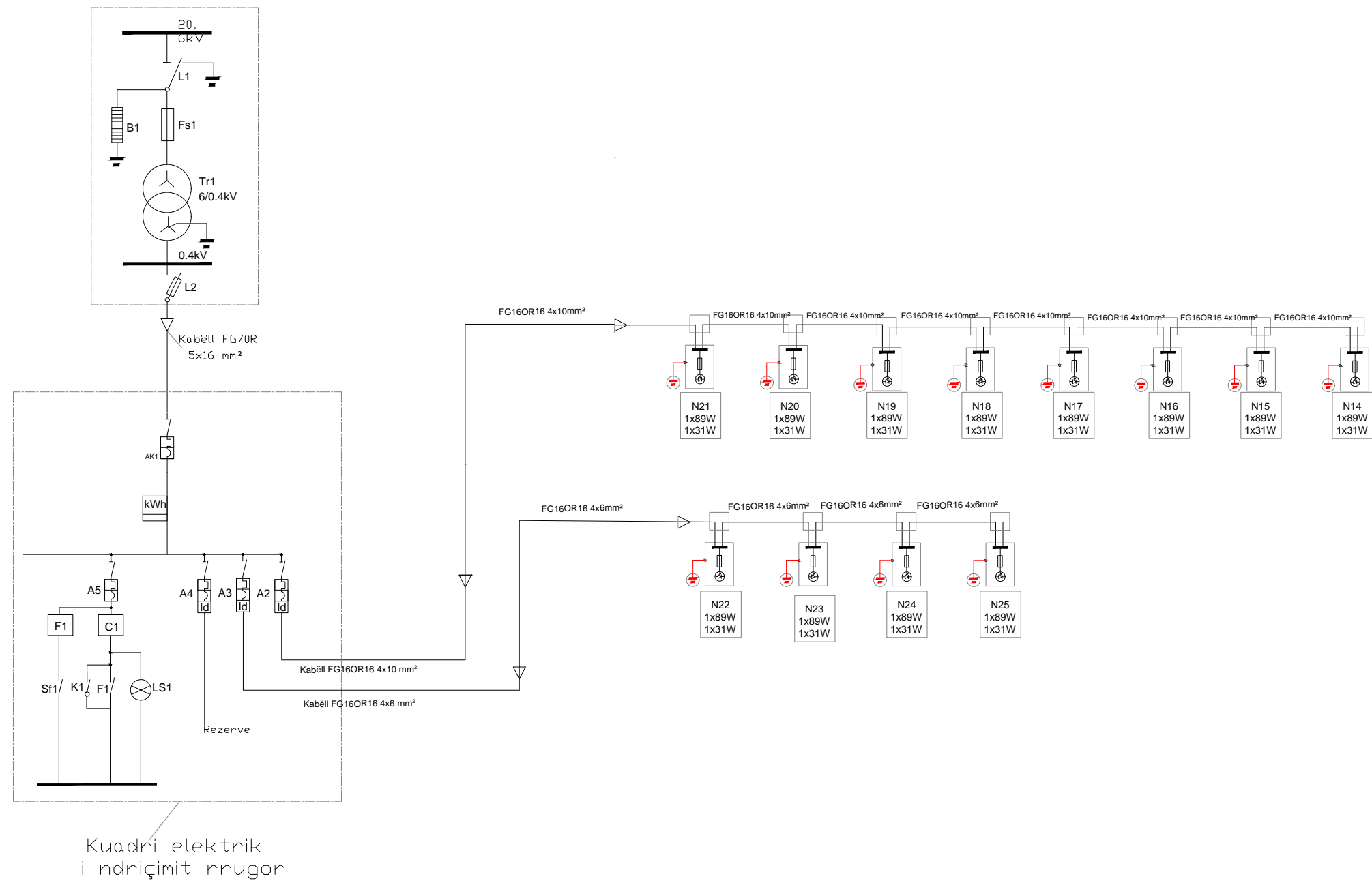

# SKEMA ELEKTRIKE E NDRIÇIMIT TË PANELIT 2

KABINA ELEKTRIKE 20,6/0.4 kV



	<p><b>REPUBLIKA E SHQIPERISE</b></p> <p><b>BASHKIA KORCE</b></p> <p>DREJTORIA E PLANIFIKIMIT URBAN TE TERRITORIT</p>	<p>DREJTORI   D.P.P.K.ZH.U.</p>	<p>ZHANETA LUBONJA</p>	<p>FLETA 2</p>
	<p>Objekti: RIKONSTRUKSIONI I NDRICIMIT RRUGA REPUBLIKA</p> <p>Emertimi: SKEMA ELEKTRIKE E NDRIÇIMIT TË PANELIT 2</p> <p>Shkalla:</p>	<p>Data:2022</p>	<p><b>AUORET E PROJEKTIT</b></p>	<p>Ing.el.VILMA PEPO Ark. ARSEN QOSJA</p>

# SKEMA ELEKTRIKE E NDRIÇIMIT "RRUGA 1 MAJI"

KABINA ELEKTRIKE 20,6/0.4 kV

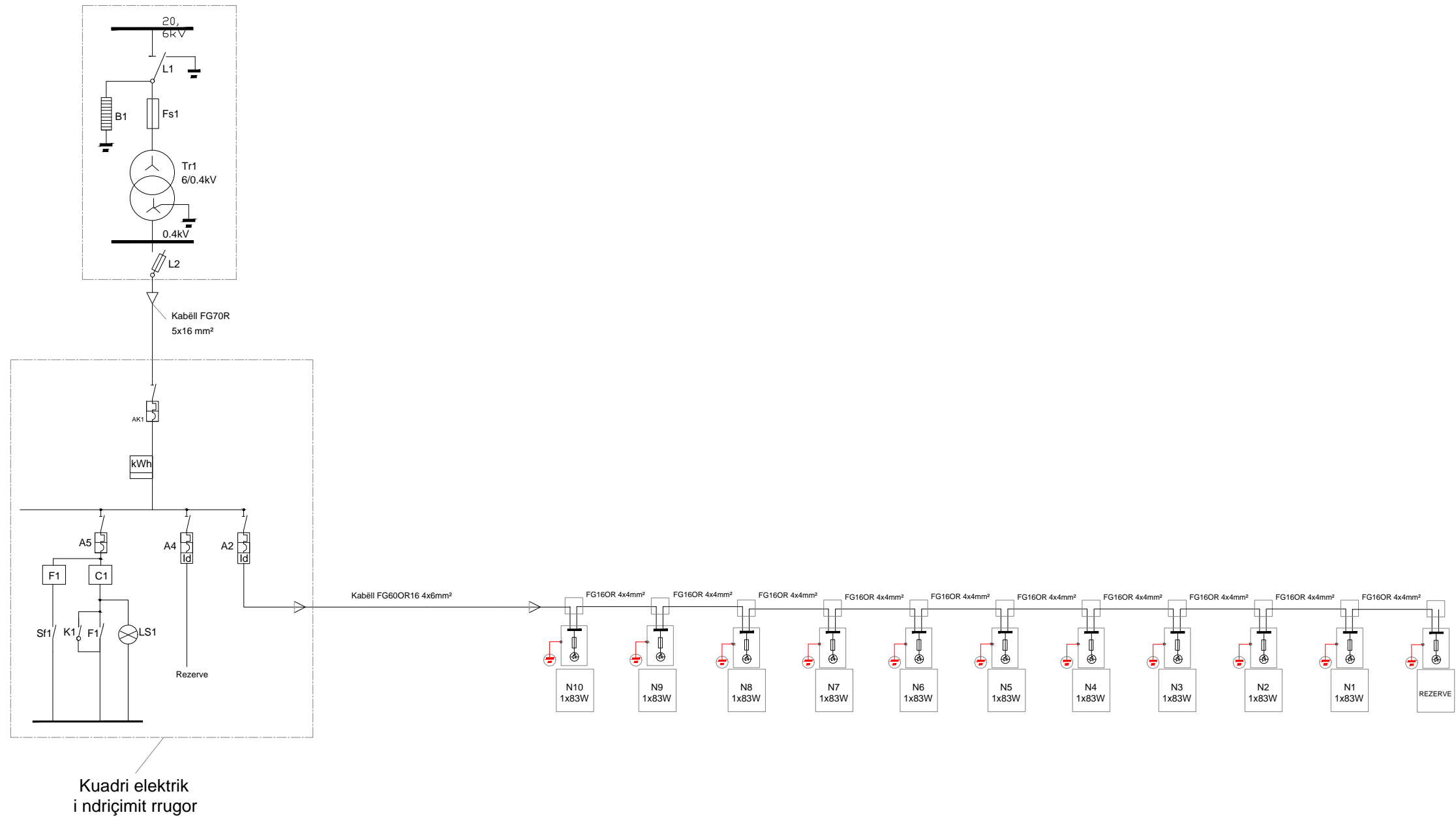

 <b>REPUBLIKA E SHQIPERISE</b> <b>BASHKIA KORCE</b> DREJTORIA E PLANIFIKIMIT URBAN TE TERRITORIT	DREJTORI I D.P.P.K.ZH.U.	ZHANETA LUBONJA	Fieta 01
	Objekti: RIKONSTRUKSIONI I NDRIÇIMIT RRUGA "1 MAJI" Emertimi: SKEMA ELEKTRIKE E NDRIÇIMIT Shkalla: _____ Data: 2022	<b>AUORET                  E PROJEKTIT</b>	Ing.el.VILMA PEPO Ark. ARSEN QOSJA

# SKEMA ELEKTRIKE E NDRIÇIMIT TË PANELIT

FG16OR16 4X6 mm<sup>2</sup>  
nga kabina elektrike

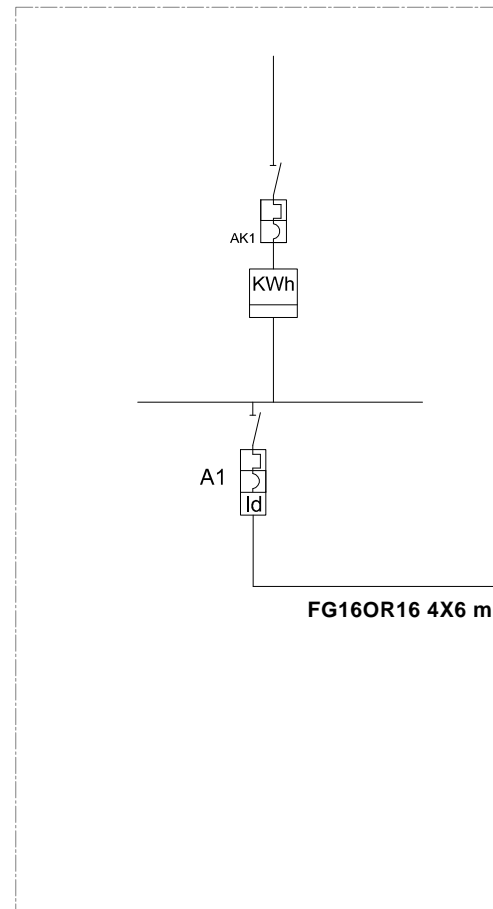

Kudri elektrik  
i komandimit të ndriçimit

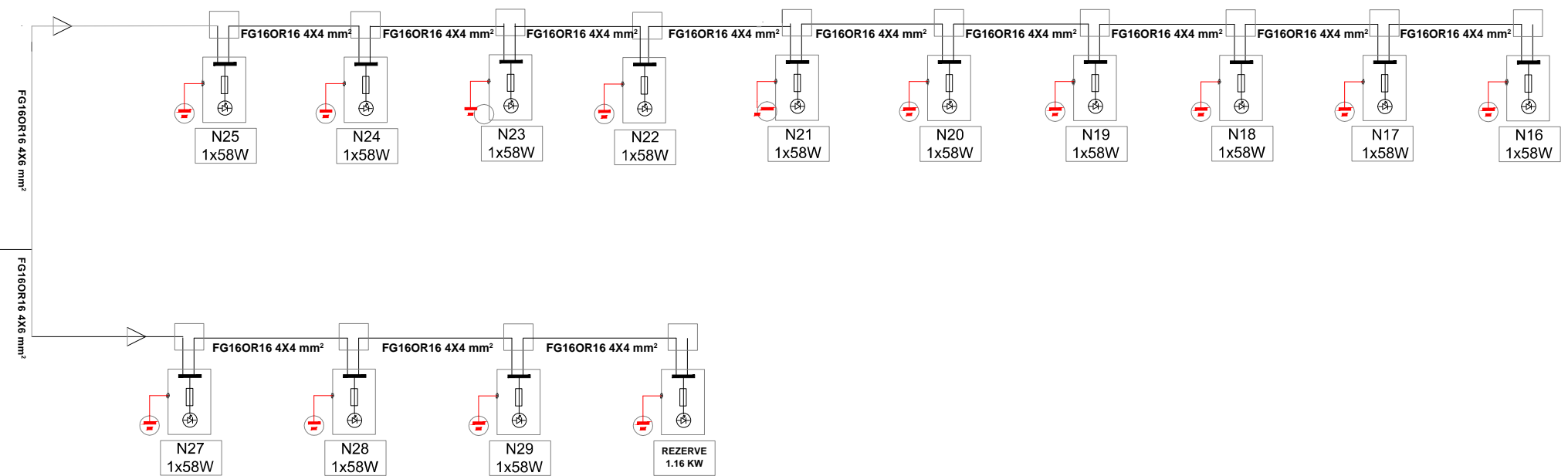

	<b>REPUBLIKA E SHQIPERISE</b>  <b>BASHKIA KORCE</b>  DREJTORIA E PLANIFIKIMIT URBAN TE TERRITORIT	DREJTORI I D.P.P.K.ZH.U.	ZHANETA LUBONJA	FLETA 2
	Objekti: RIKONSTRUKSIONI I NDRICIMIT "RRUGA SOTIR POLENA" Emertimi: SKEMA ELEKTRIKE E NDRICIMIT TË PANELIT Shkalla:	Data:2022	<b>AUTORET E PROJEKTIT</b>	Ing.ei.VILMA PEPO Ark. ARSEN QOSJA

# SKEMA ELEKTRIKE E NDRIÇIMIT TË PANELIT

Kabëll FG16OR16 4x6mm<sup>2</sup>  
nga kabina elektrike

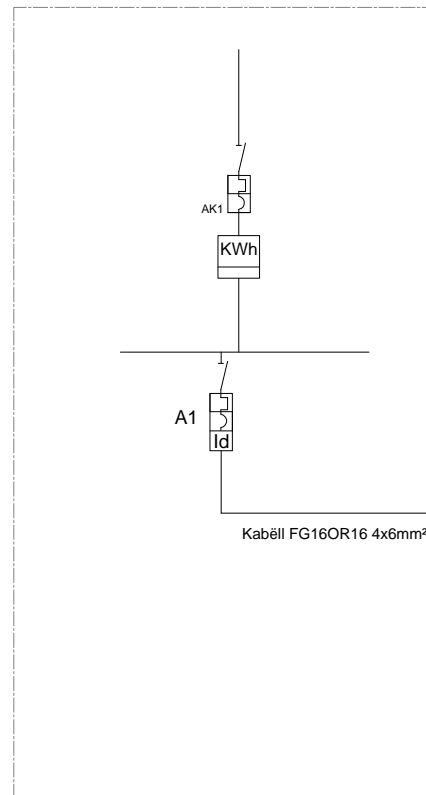

Kuari elektrik  
i komandimit të ndriçimit

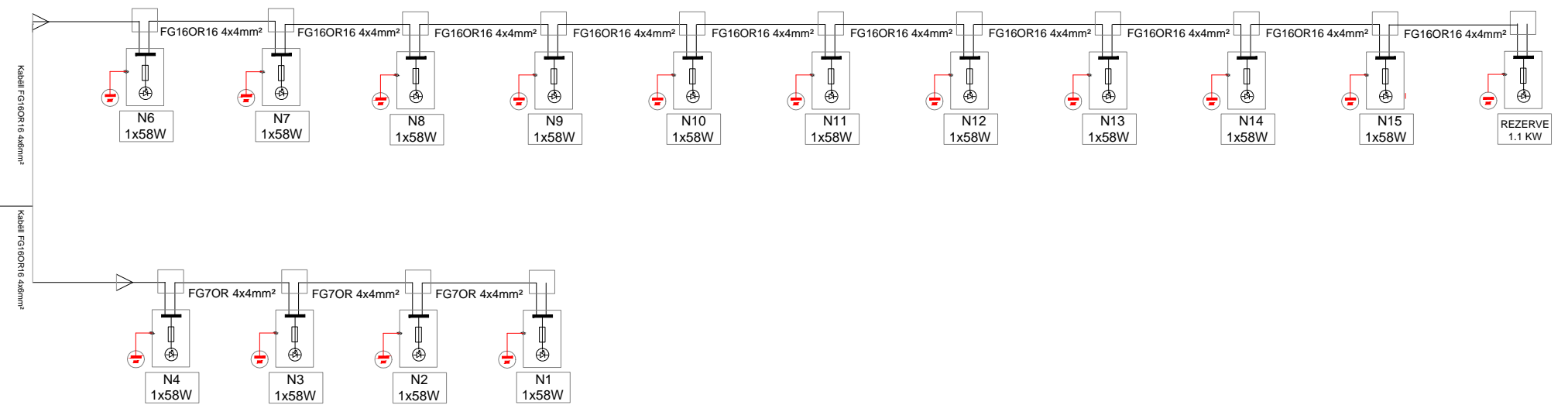

	<b>REPUBLIKA E SHQIPERISE</b>  <b>BASHKIA KORCE</b>  DREJTORIA E PLANIFIKIMIT URBAN TE TERRITORIT	DREJTORI I D.P.P.K.ZH.U.	ZHANETA LUBONJA	FLETA 1
	Objekti: RIKONSTRUKSIONI I NDRIÇIMIT "RRUGA SOTIR POLENA" Emertimi: SKEMA ELEKTRIKE E NDRIÇIMIT TË PANELIT Shkalla: _____ Data:2022	<b>AUORET E PROJEKTIT</b>	Ing.el.VILMA PEPO Ark. ARSEN QOSJA	

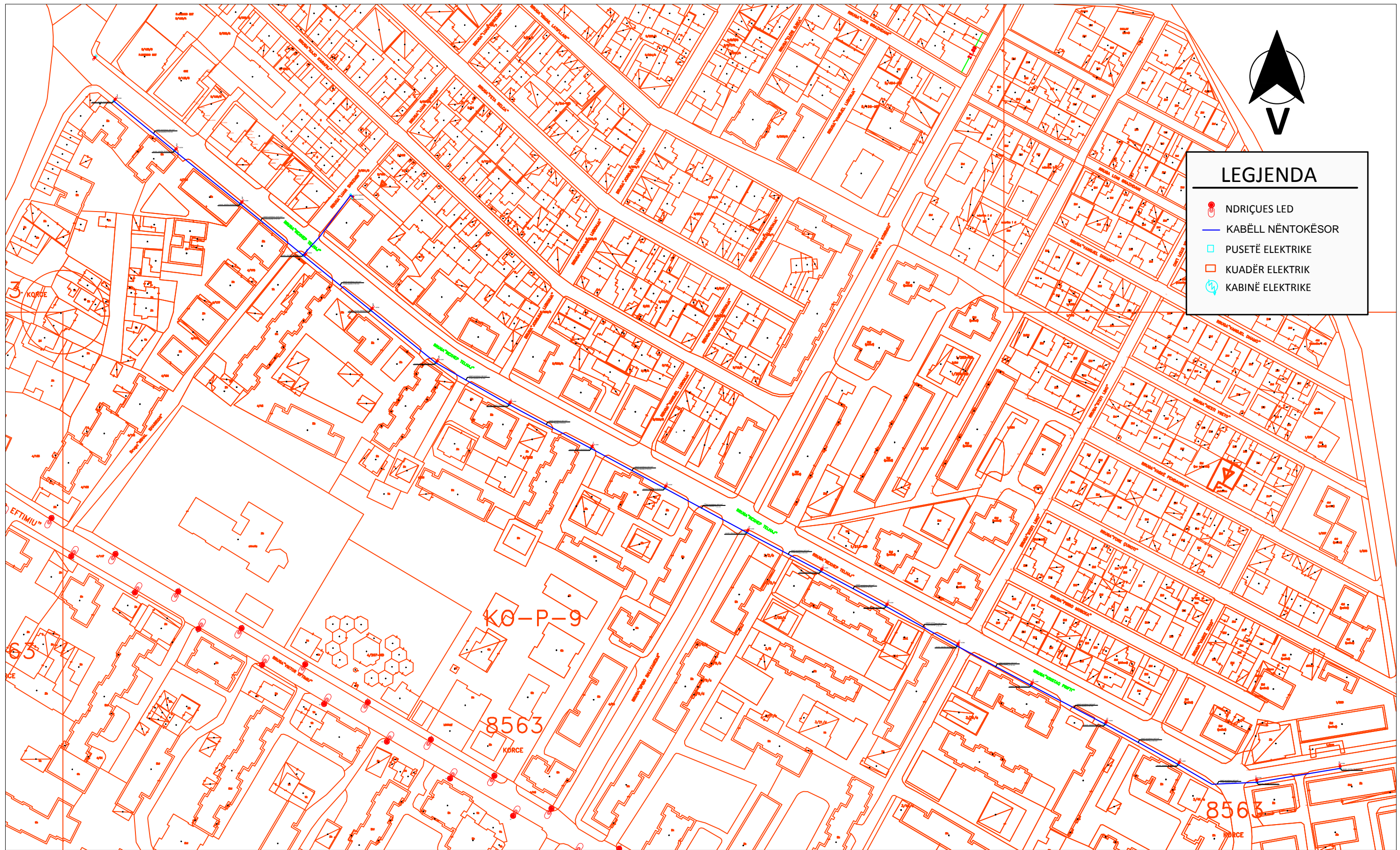

 <b>REPUBLIKA E SHQIPERISE</b> <b>BASHKIA KORÇE</b> DREJTORIA E PLANIFIKIMIT URBAN TE TERRITORIT	DREJTORI I D.P.P.K.ZH.U.	ZHANETA LUBONJA	FLETA E-01-01
	Objekti: RIKONSTRUKSION I NDRIÇIMIT RRUGA " REXHEP TELHAJ" Emertimi: PLANIMETRIA E RRUGËS Shkalla: 1:1700	<b>AUORET          E PROJEKTIT</b>	
Data: 2022			

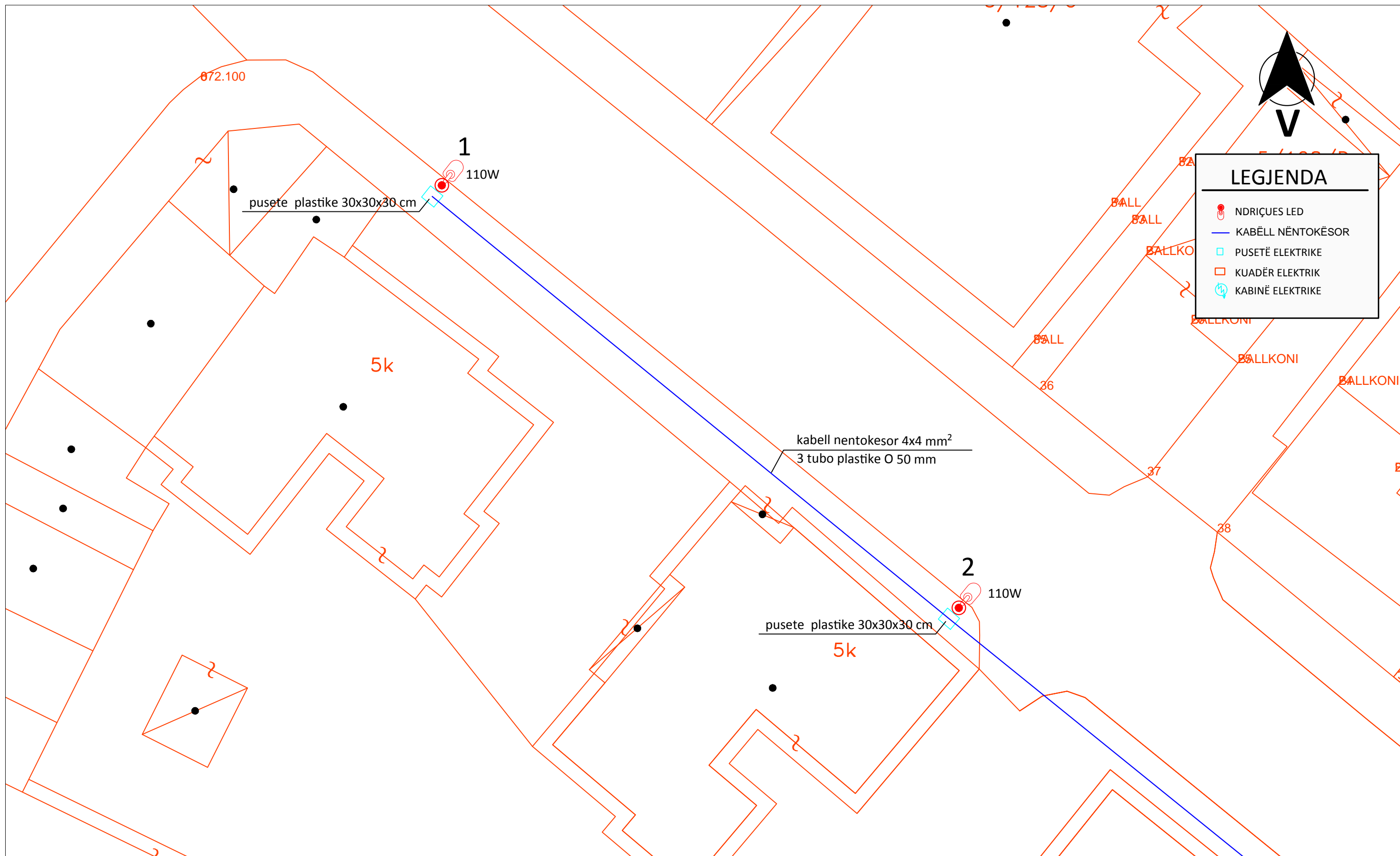

 <b>REPUBLIKA E SHQIPERISE</b> <b>BASHKIA KORCE</b> DREJTORIA E PLANIFIKIMIT URBAN TE TERRITORIT	DREJTORI I D.P.P.K.ZH.U.	ZHANETA LUBONJA	FLETA E-01-02
	<b>AUTORET E PROJEKTIT</b>		Ing.eI.VILMA PEPO Ark. ARSEN QOSJA
Objekti: RIKONSTRUKSION I NDRIÇIMIT RRUGA " REXHEP TELHAJ"			
Emertimi: PLANIMETRIA E RRGËS			
Shkalla: 1:200	Data: 2022		

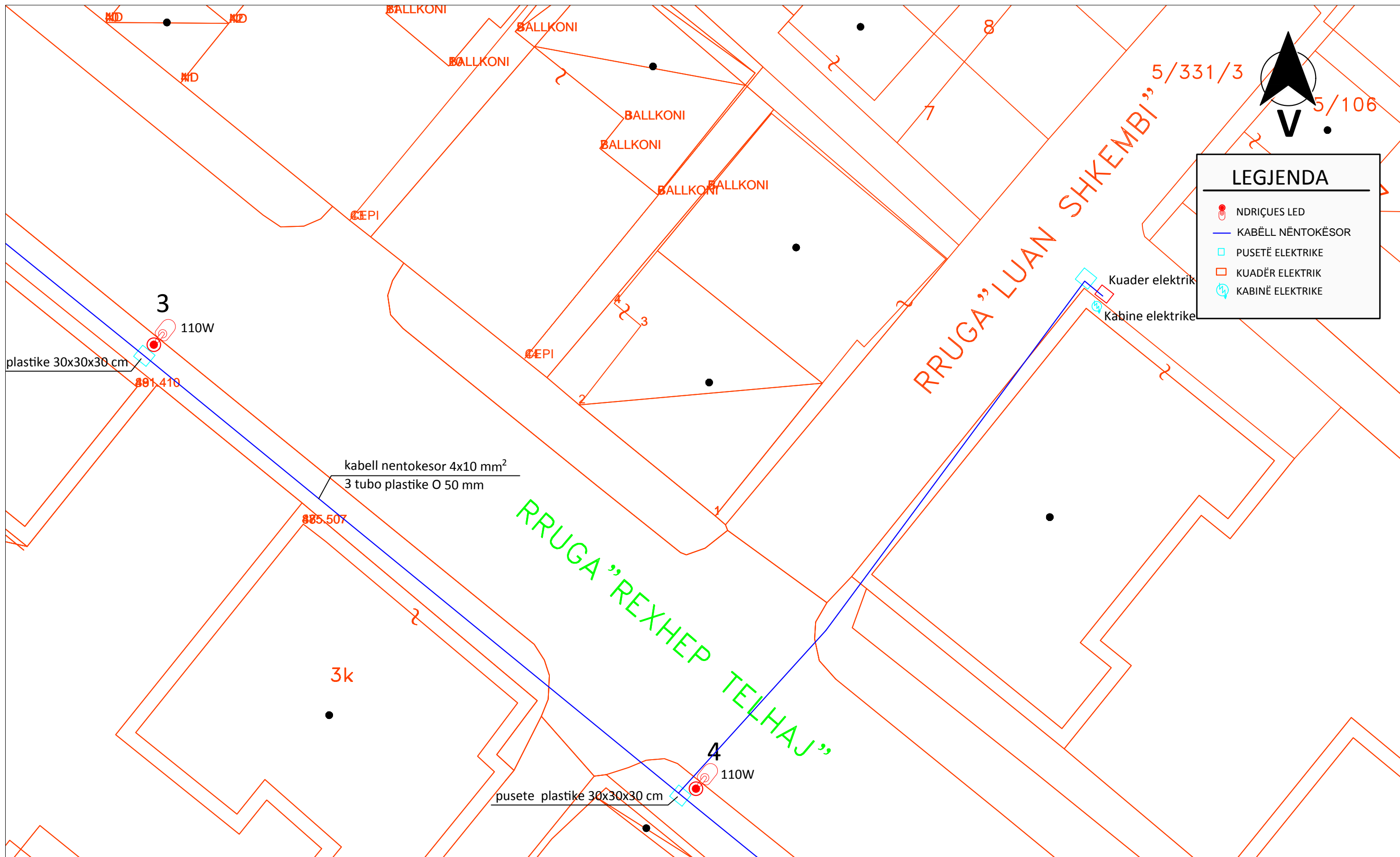

 <b>REPUBLIKA E SHQIPERISE</b> <b>BASHKIA KORCE</b> DREJTORIA E PLANIFIKIMIT URBAN TE TERRITORIT	DREJTORI I D.P.P.K.ZH.U.	ZHANETA LUBONJA	FLETA E-01-03
	<b>AUORET E PROJEKTIT</b>		Ing.ei.VILMA PEPO Ark. ARSEN QOSJA
	Objekti: RIKONSTRUKSION I NDRIÇIMIT RRUGA " REXHEP TELHAJ"	Emertimi: PLANIMETRIA E RRUGËS	
Shkalla: 1:200	Data: 2022		

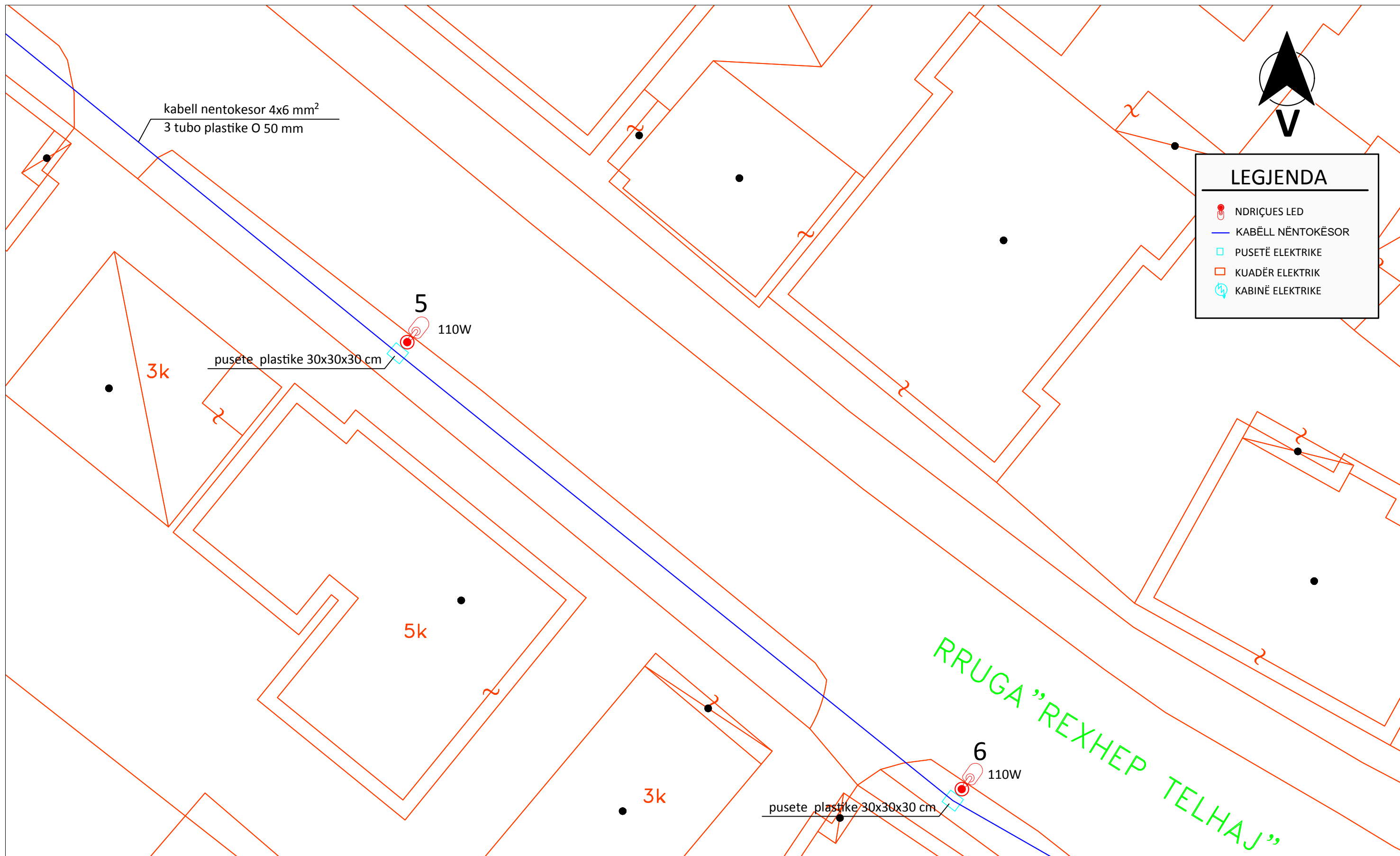

LEGJENDA	
	NDRIÇUES LED
	KABËLL NËNTOKËSOR
	PUSETË ELEKTRIKE
	KUADËR ELEKTRIK
	KABINË ELEKTRIKE



 <b>REPUBLIKA E SHQIPERISE</b> <b>BASHKIA KORCE</b> DREJTORIA E PLANIFIKIMIT URBAN TE TERRITORIT	DREJTORI I D.P.P.K.ZH.U.	ZHANETA LUBONJA	FLETA E-01-04
	<b>AUORET E PROJEKTIT</b>		Ing.eI.VILMA PEPO Ark. ARSEN QOSJA



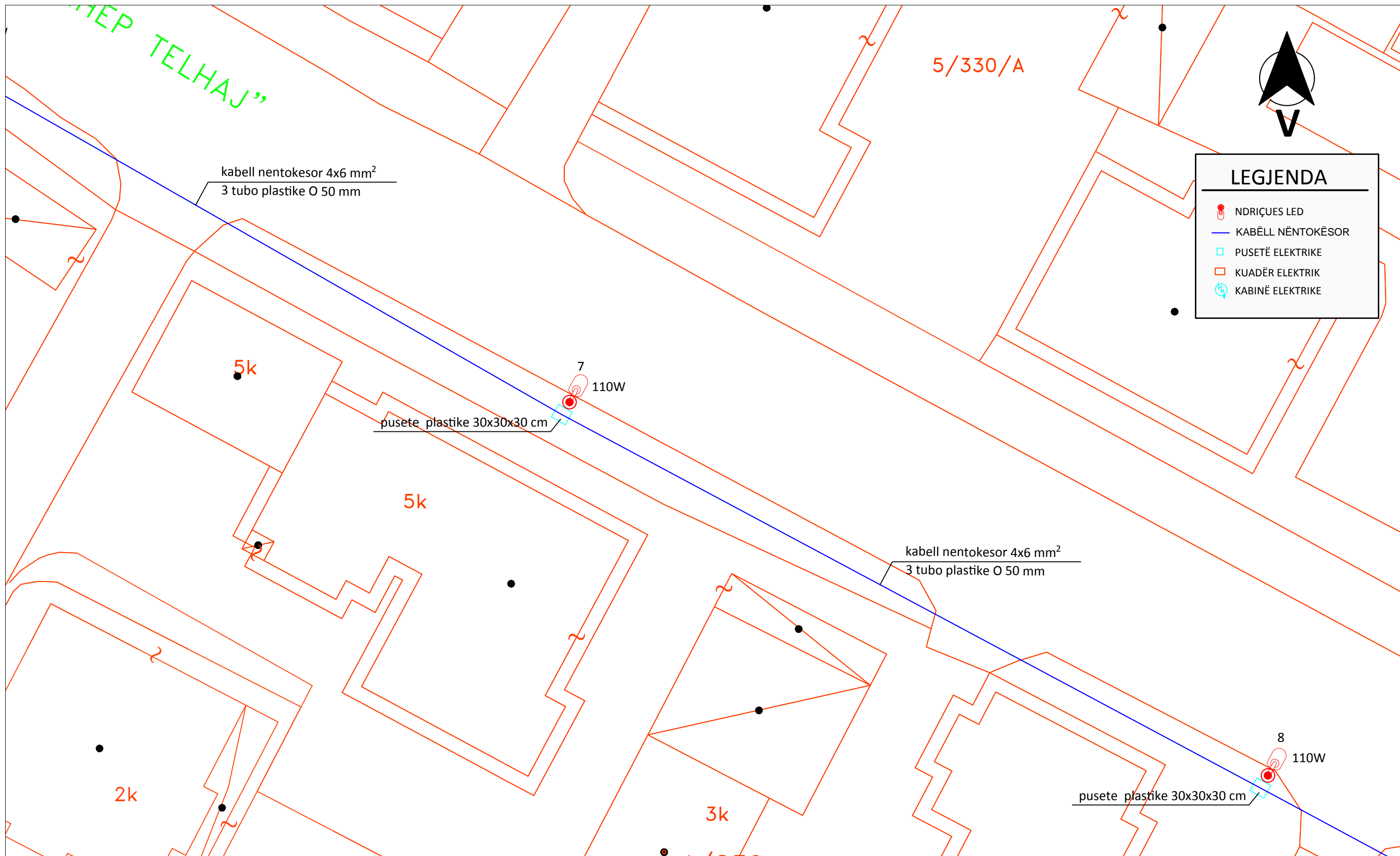





LEGJENDA	
	NDRIÇUES LED
	KABËLL NËNTOKËSOR
	PUSETË ELEKTRIKE
	KUADËR ELEKTRIK
	KABINË ELEKTRIKE

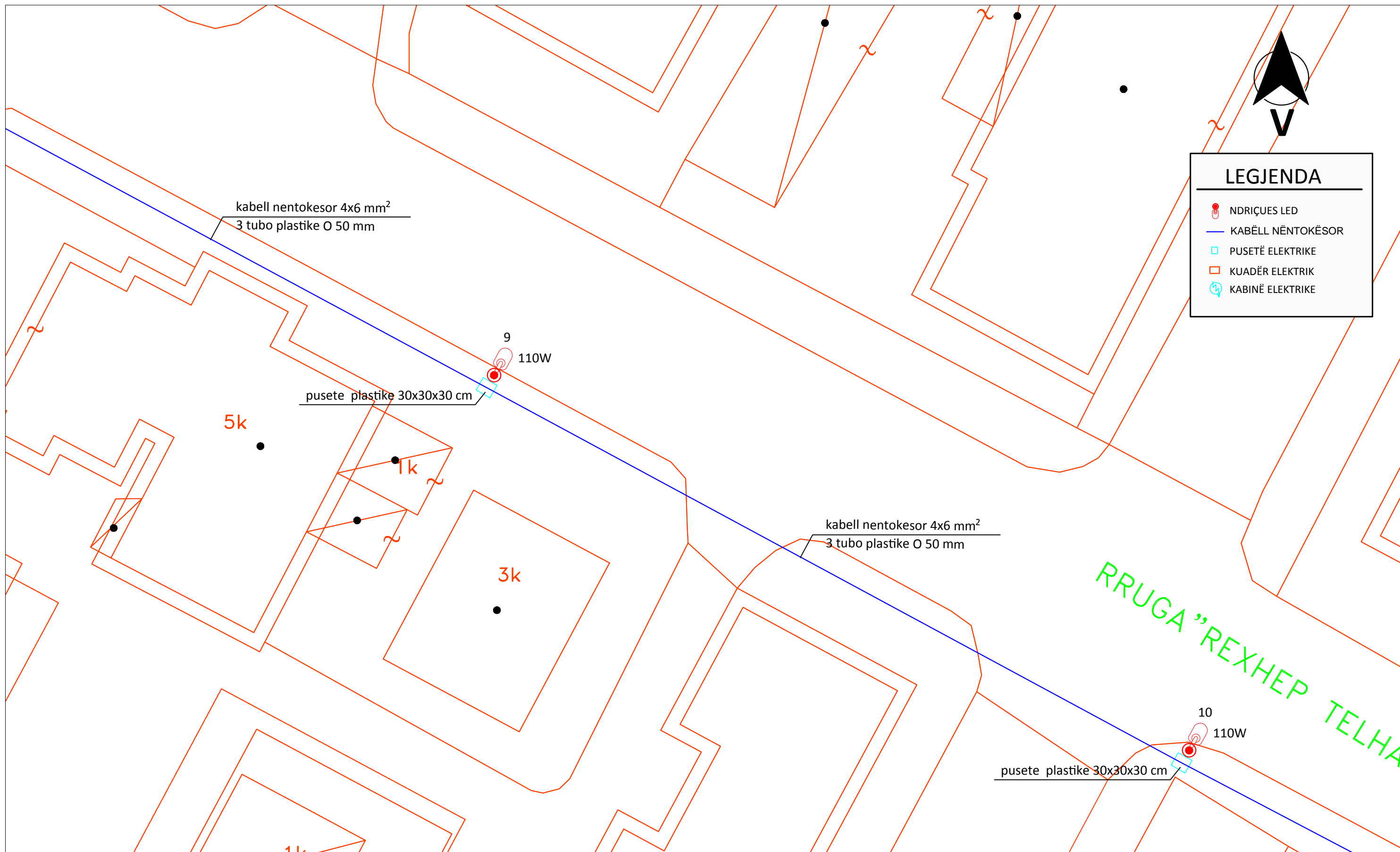

 <b>REPUBLIKA E SHQIPERISE</b> <b>BASHKIA KORCE</b> DREJTORIA E PLANIFIKIMIT URBAN TE TERRITORIT	DREJTORI I D.P.P.K.ZH.U.	ZHANETA LUBONJA	FLETA E-01-05
	<b>AUORET          E PROJEKTIT</b>		Ing.eI.VILMA PEPO Ark. ARSEN QOSJA
Objekti: RIKONSTRUKSION I NDRIÇIMIT RRUGA " REXHEP TELHAJ"			
Emertimi: PLANIMETRIA E RRU GËS			
Shkalla: 1:200	Data: 2022		



**LEGJENDA**

-  NDRIÇUES LED
-  KABËLL NËNTOKËSOR
-  PUSETË ELEKTRIKE
-  KUADËR ELEKTRIK
-  KABINË ELEKTRIKE



 <b>REPUBLIKA E SHQIPERISE</b> <b>BASHKIA KORCE</b> DREJTORIA E PLANIFIKIMIT URBAN TE TERRITORIT	DREJTORI I D.P.P.K.ZH.U.	ZHANETA LUBONJA	FLETA E-01-06
	<b>AUTORET E PROJEKTIT</b>		Ing.eI.VILMA PEPO Ark. ARSEN QOSJA
Objekti: RIKONSTRUKSION I NDRIÇIMIT RRUGA " REXHEP TELHAJ"			
Emertimi: PLANIMETRIA E RRUGËS			
Shkalla: 1:200	Data: 2022		

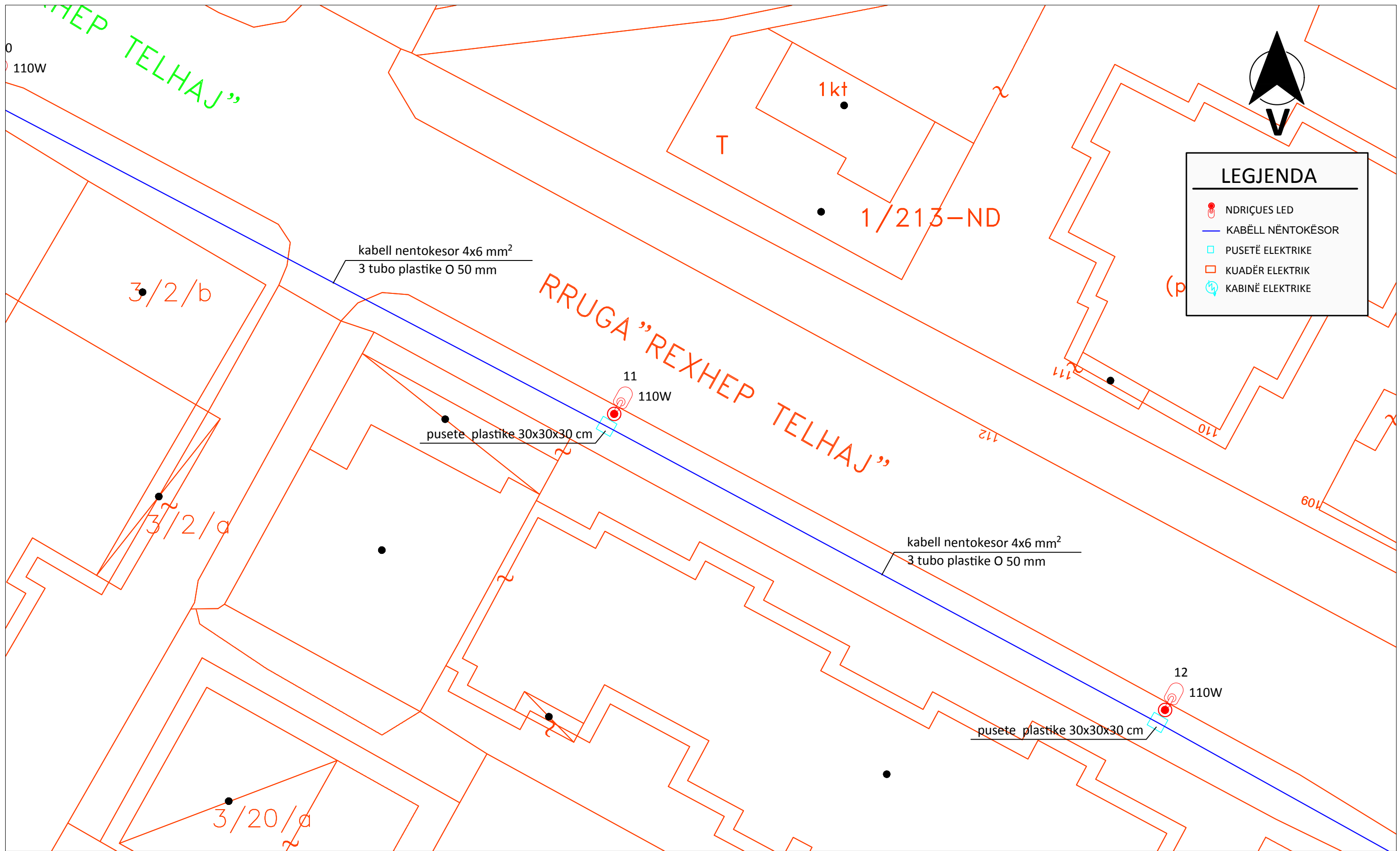

**LEGJENDA**

- NDRIÇUES LED
- KABËLL NËNTOKËSOR
- PUSETË ELEKTRIKE
- KUADËR ELEKTRIK
- KABINË ELEKTRIKE



 <b>REPUBLIKA E SHQIPERISE</b> <b>BASHKIA KORCE</b> DREJTORIA E PLANIFIKIMIT URBAN TE TERRITORIT	DREJTORI I D.P.P.K.ZH.U.	ZHANETA LUBONJA	FLETA E-01-07
	<b>AUORET          E PROJEKTIT</b>		Ing.eI.VILMA PEPO Ark. ARSEN QOSJA
	Objekti: RIKONSTRUKSION I NDRIÇIMIT RRUGA " REXHEP TELHAJ"	Emertimi: PLANIMETRIA E RRGËS	
Shkalla: 1:200	Data: 2022		

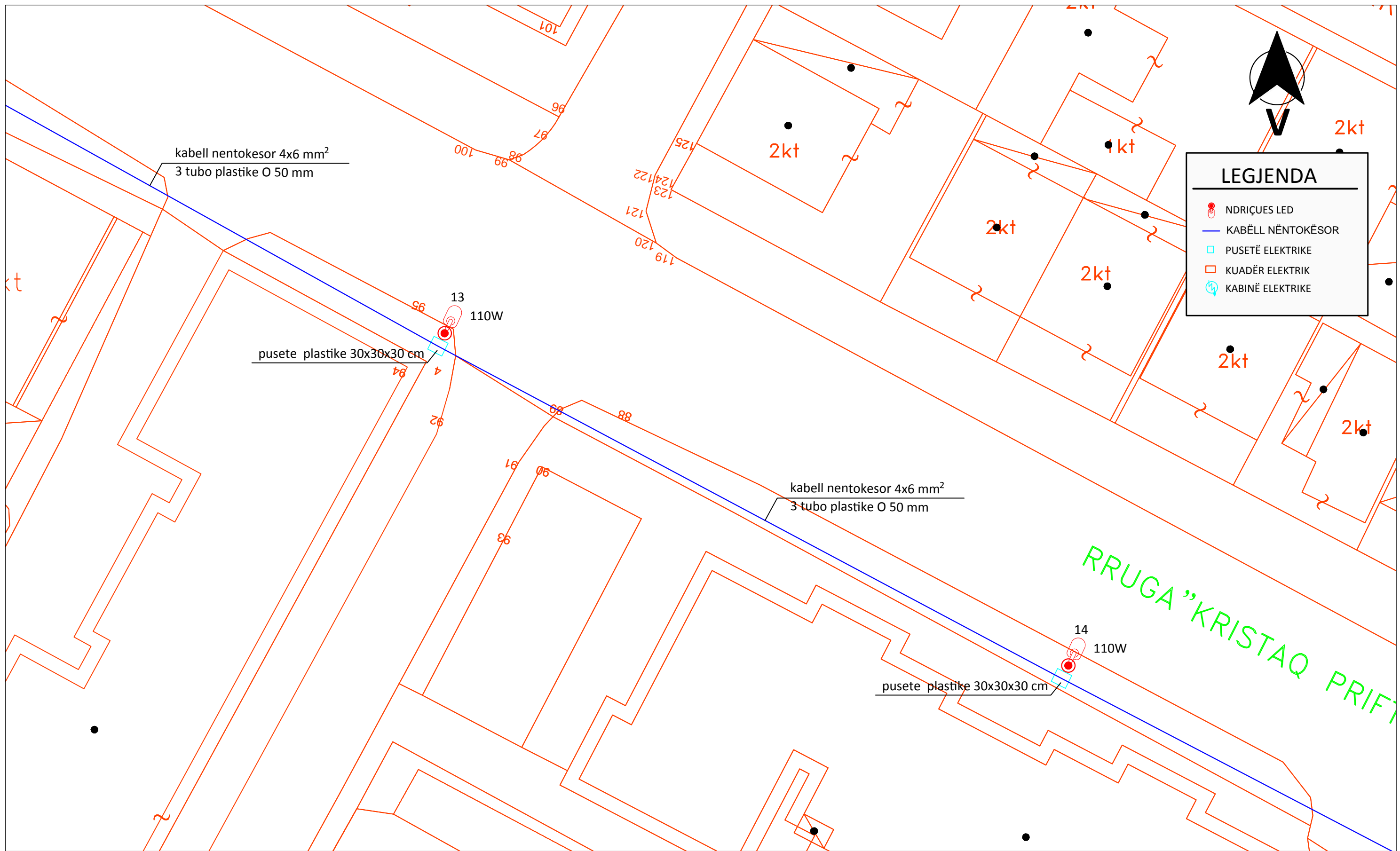



**LEGJENDA**

- NDRIÇUES LED
- KABËLL NËNTOKËSOR
- PUSETË ELEKTRIKE
- KUADËR ELEKTRIK
- KABINË ELEKTRIKE

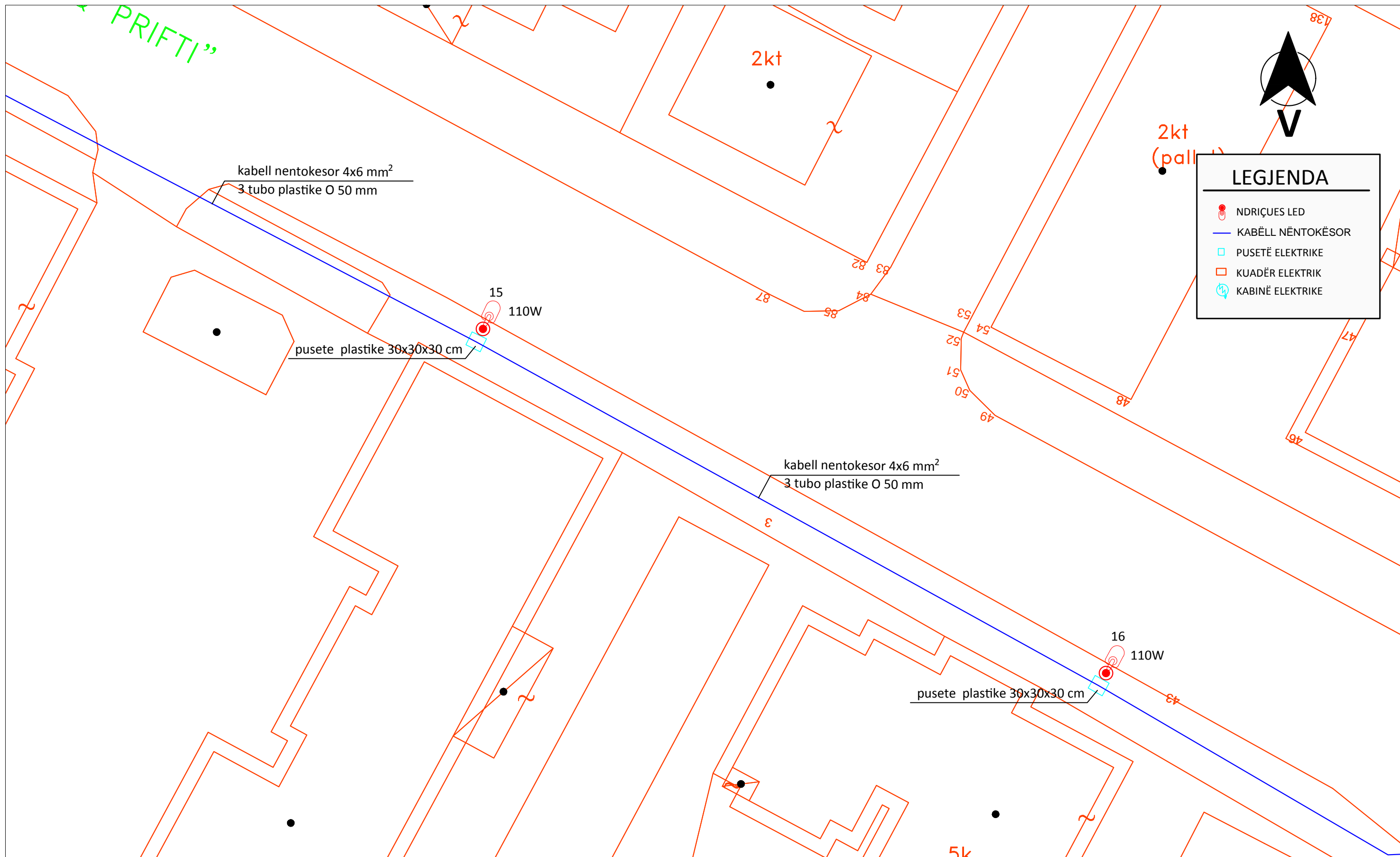

 <b>REPUBLIKA E SHQIPERISE</b> <b>BASHKIA KORCE</b> DREJTORIA E PLANIFIKIMIT URBAN TE TERRITORIT	DREJTORI I D.P.P.K.ZH.U.	ZHANETA LUBONJA	FLETA E-01-08
	<b>AUTORET E PROJEKTIT</b>		Ing.eI.VILMA PEPO Ark. ARSEN QOSJA
	Objekti: RIKONSTRUKSION I NDRIÇIMIT RRUGA " REXHEP TELHAJ"		
Emertimi: PLANIMETRIA E RRGËS			
Shkalla: 1:200	Data: 2022		





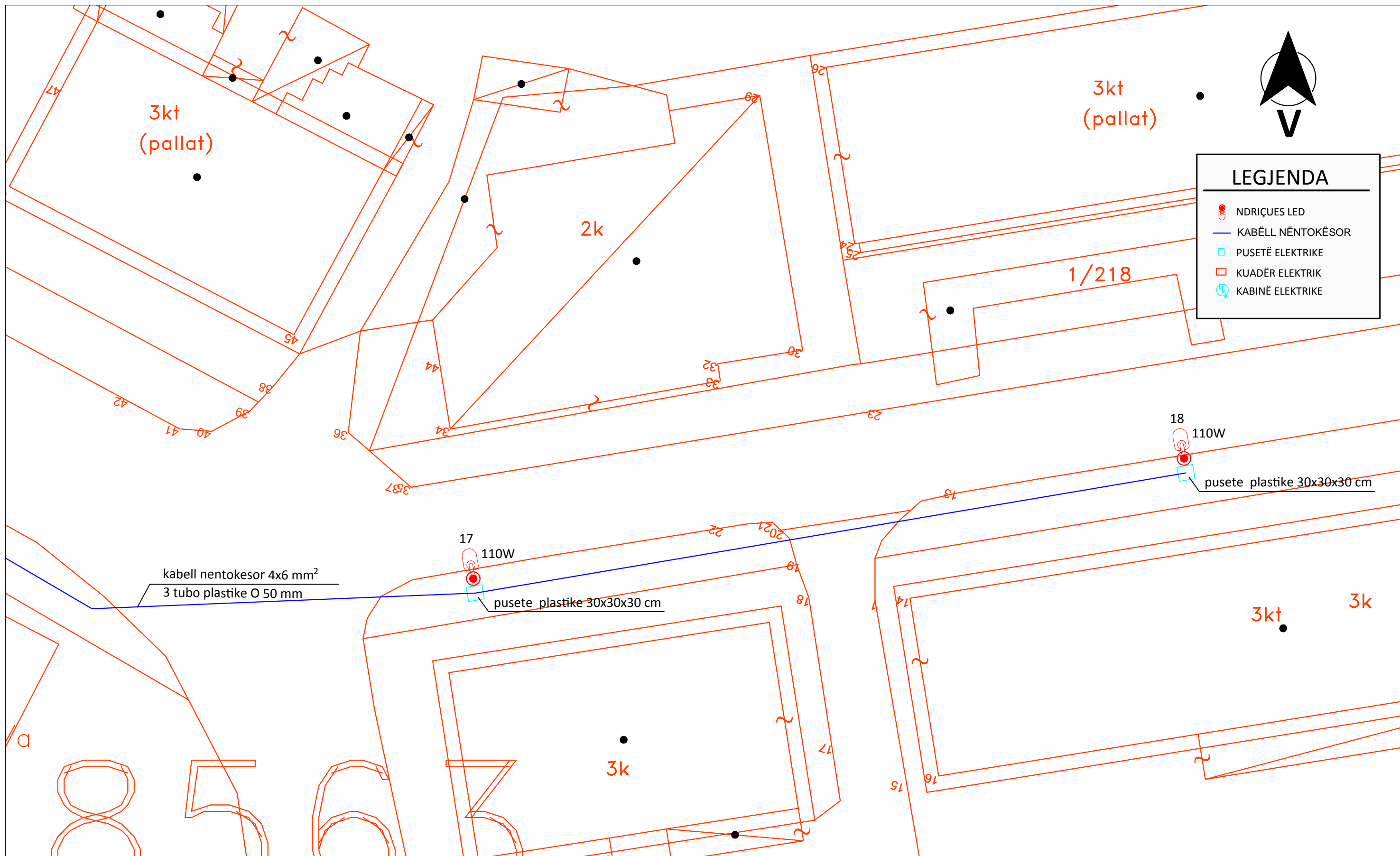



 <b>REPUBLIKA E SHQIPERISE</b> <b>BASHKIA KORCE</b> DREJTORIA E PLANIFIKIMIT URBAN TE TERRITORIT	DREJTORI I D.P.P.K.ZH.U.	ZHANETA LUBONJA	FLETA E-01-09
	<b>AUTORET E PROJEKTIT</b>		Ing.ei.VILMA PEPO Ark. ARSEN QOSJA
	Objekti: RIKONSTRUKSION I NDRIÇIMIT RRUGA " REXHEP TELHAJ"	Emertimi: PLANIMETRIA E RRGËS	
Shkalla: 1:200	Data: 2022		





 <b>REPUBLIKA E SHQIPERISE</b> <b>BASHKIA KORCE</b> DREJTORIA E PLANIFIKIMIT URBAN TE TERRITORIT	DREJTORI I D.P.P.K.ZH.U.	ZHANETA LUBONJA	FLETA E-01-10
	<b>AUTORET          E PROJEKTIT</b>		Ing.eI.VILMA PEPO Ark. ARSEN QOSJA
	Objekti: RIKONSTRUKSION I NDRICIMIT RRUGA " REXHEP TELHAJ"	Emertimi: PLANIMETRIA E RRRUGËS	
Shkalla: 1:200	Data: 2022		

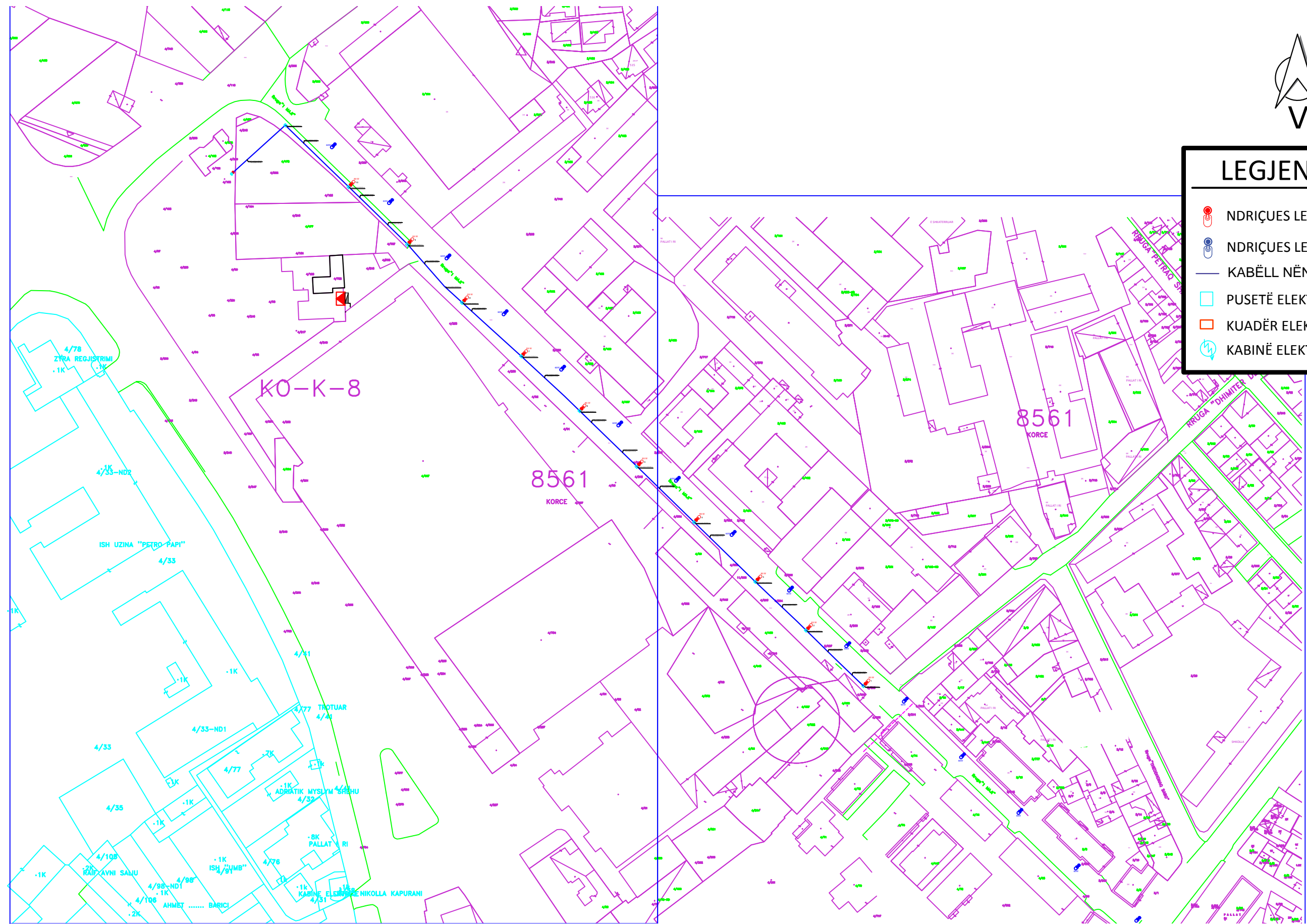

# LEJENDA

-  NDRIÇUES LED
-  NDRIÇUES LED EKZISTUES
-  KABËLL NËNTOKËSOR
-  PUSËTË ELEKTRIKE
-  KUADËR ELEKTRIK
-  KABINË ELEKTRIKE



 <b>REPUBLIKA E SHQIPERISE</b> <b>BASHKIA KORCE</b> DREJTORIA E PLANIFIKIMIT URBAN TE TERRITORIT	<b>DREJTORI</b> I D.P.P.K.ZH.U.	<b>ZHANETA LUBONJA</b>	FLETA E-01-01
	<b>AUTORET</b> <b>E PROJEKTIT</b>		Ing.el.VILMA PEPO Ark. ARSEN QOSJA
Objekti: RIKONSTRUKSION I NDRICIMIT "RRUGA 1 MAJI" Emertimi: PLANIMETRIA E RRUGES Shkalla: 1:1200      Data: 2022			

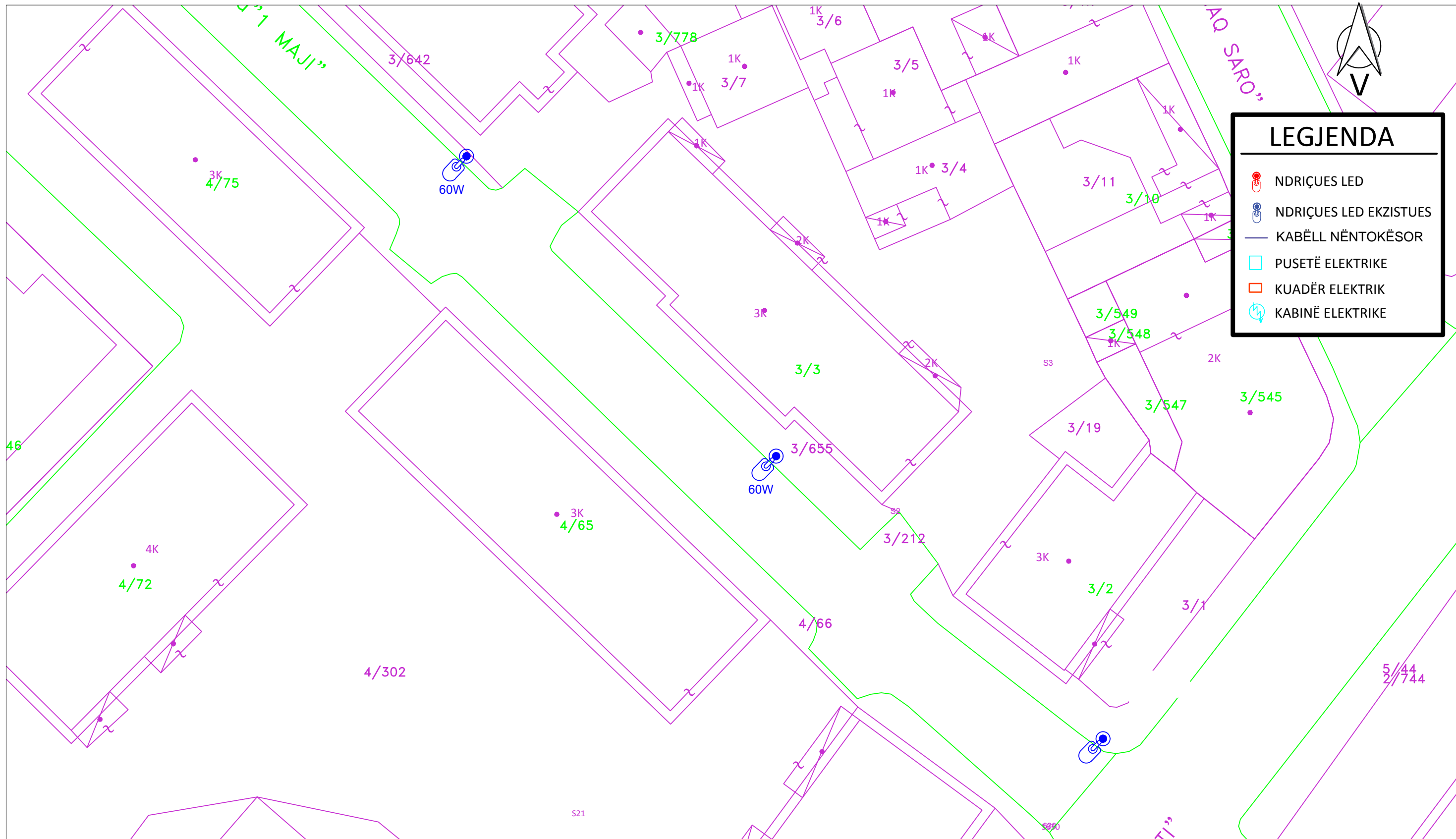

LEGGJENDA	
	NDRIÇUES LED
	NDRIÇUES LED EKZISTUES
	KABËLL NËNTOKËSOR
	PUSETË ELEKTRIKE
	KUADËR ELEKTRIK
	KABINË ELEKTRIKE



 <b>REPUBLIKA E SHQIPERISE</b> <b>BASHKIA KORCE</b> DREJTORIA E PLANIFIKIMIT URBAN TE TERRITORIT	DREJTORI I D.P.P.K.ZH.U.	ZHANETA LUBONJA	FLETA E-01-02
	Objekti: RIKONSTRUKSION I NDRICIMIT "RRUGA 1 MAJI" Emertimi: PLANIMETRIA E RRUGES Shkalla: 1:200      Data: 2022	<b>AUORET          E PROJEKTIT</b>	Ing.el.VILMA PEPO Ark. ARSEN QOSJA





### LEGJENDA

-  NDRIÇUES LED
-  NDRIÇUES LED EKZISTUES
-  KABËLL NËNTOKËSOR
-  PUSETË ELEKTRIKE
-  KUADËR ELEKTRIK
-  KABINË ELEKTRIKE

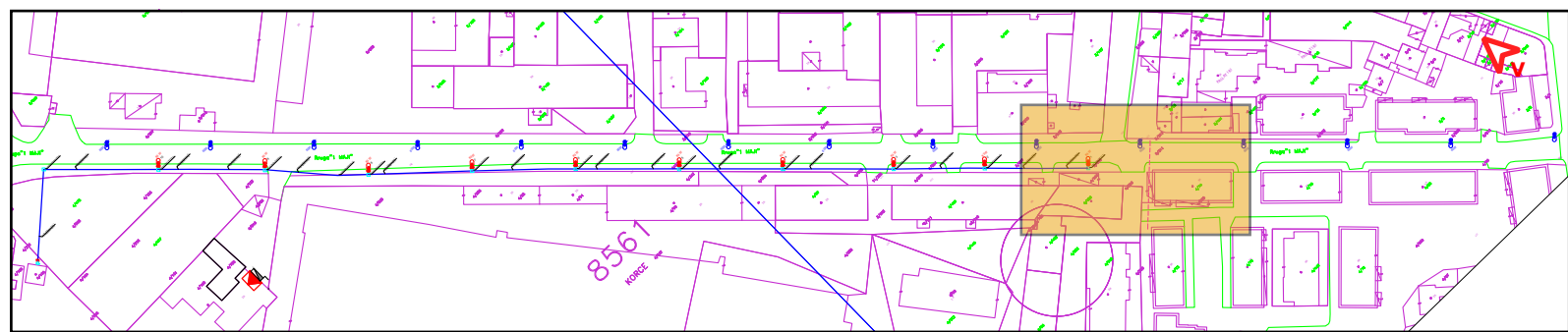
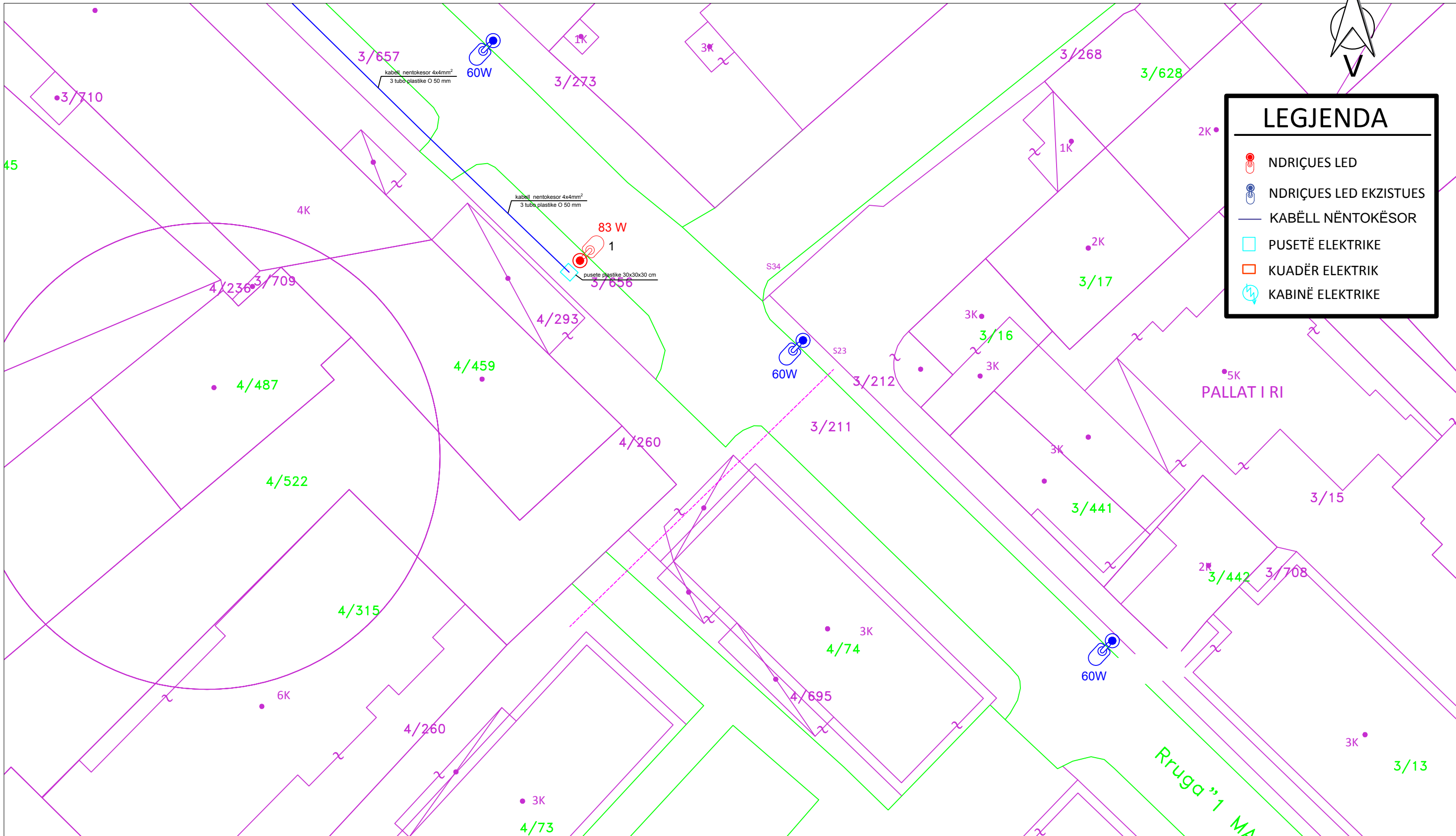

 <b>REPUBLIKA E SHQIPERISE</b> <b>BASHKIA KORCE</b> DREJTORIA E PLANIFIKIMIT URBAN TE TERRITORIT	DREJTORI I D.P.P.K.ZH.U.	ZHANETA LUBONJA	FLETA E-01-03
	<b>AUTORET E PROJEKTIT</b>	Ing.el.VILMA PEPO Ark. ARSEN QOSJA	
Objekti: RIKONSTRUKSION I NDRICIMIT "RRUGA 1 MAJI" Emertimi: PLANIMETRIA E RRUGES Shkalla: 1:200      Data: 2022			