

**Miratoi
Kryetari Bashkise
Eriselda Sefa**

**Objekti : MURIT MBAJTES SEGMENTI NDERMJET
RRUGES VASIL PRIFTI DHE SAZAN ZEKA**

**DREJTORIA PLANIFIKIMIT
MIMOZA HAXHIU**

PLANIMETRIA E MURIT MBAJTES SEGMENTI NDERMJET RRUGES VASIL PRIFTI DHE SAZAN ZEKA



OBJEKTI	PLANIMETRIA E MURIT MBAJTES SEGMENTI NDERMJET RRUGES VASIL PRIFTI DHE SAZAN ZEKA	NR.FLETES	A-01
VENDNDODHJA	LAGJJA KONGRESI ,LUSHNJE	FORMATI	297X420
EMERT.I FLETES	PROFIELET TERTHORE	SHKALLA	1:250
DREJTORIA	Ing. MIMOZA HAXHIU	 REPUBLIKA E SHQIPERIS BASHKIA LUSHNJE DREJTORIA E PLANIFIKIMIT SEKTORI I PROJEKTIMIT	
SPECIALIST	Ing .ARIOLA BEQD		
SPECIALIST	Top.Vasil Lena		

PLANIMETRIA E MURIT MBAJTES SEGMENTI NDERMJET RRUGES VASIL PRIFTI DHE SAZAN ZEKA

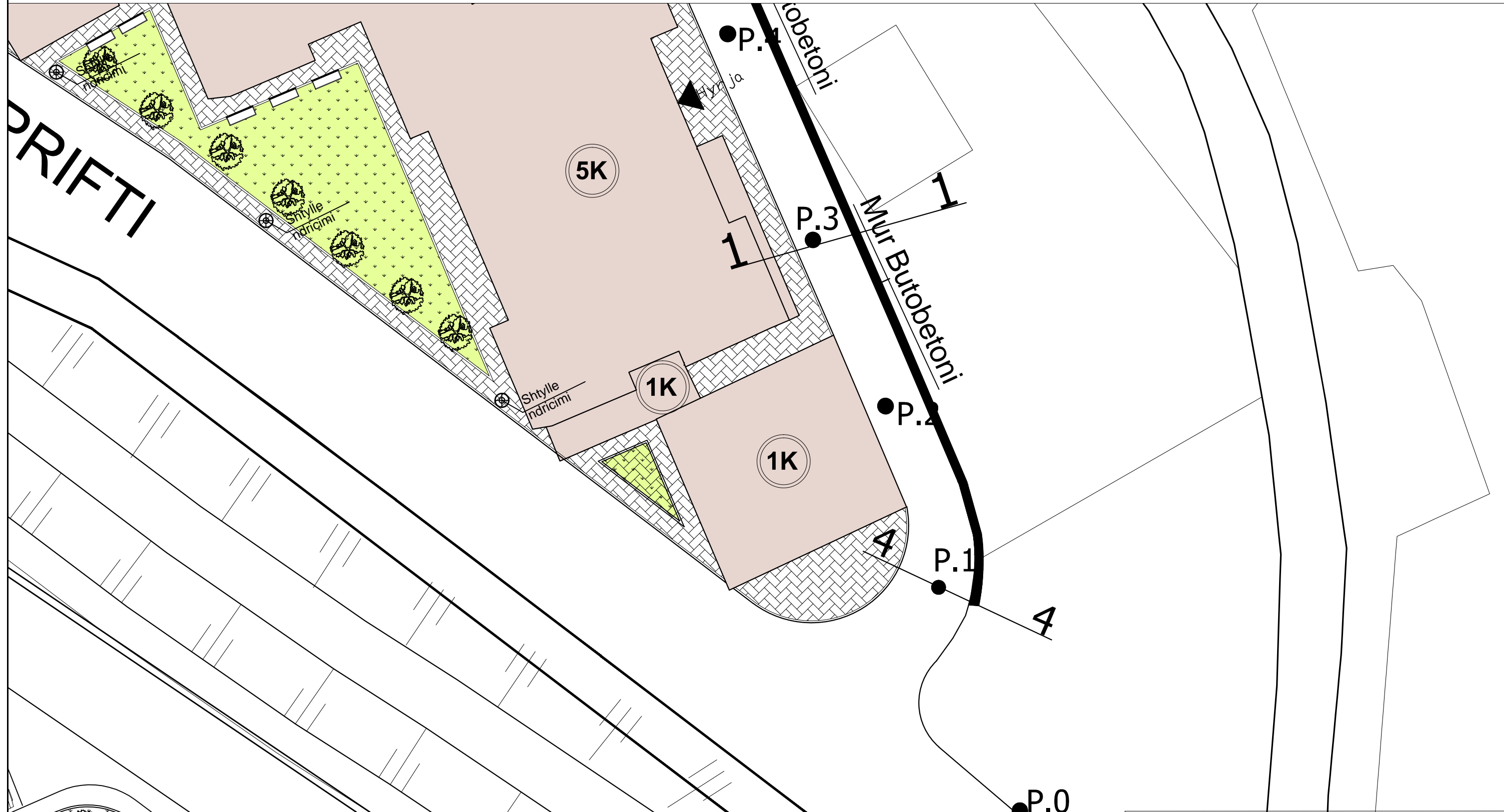

OBJEKTI	PLANIMETRIA E MURIT MBAJTES SEGMENTI NDERMJET RRUGES VASIL PRIFTI DHE SAZAN ZEKA	NR.FLETES	A-01
VENDNDODHJA	LAGJJA KONGRESI ,LUSHNJE	FORMATI	297X420
EMERT.I FLETES	PROFILET TERTHORE	SHKALLA	1:250
DREJTORIA	Ing. MIMOZA HAXHIU	 REPUBLIKA E SHQIPERISE BASHKIA LUSHNJE DREJTORIA E PLANIFIKIMIT SEKTORI I PROJEKTIMIT	
SPECIALIST	Ing .ARIOLA BEQO		
SPECIALIST	Top.Vasil Lena		

PLANIMETRIA E MURIT MBAJTES SEGMENTI NDERMJET RRUGES VASIL PRIFTI DHE SAZAN ZEKA

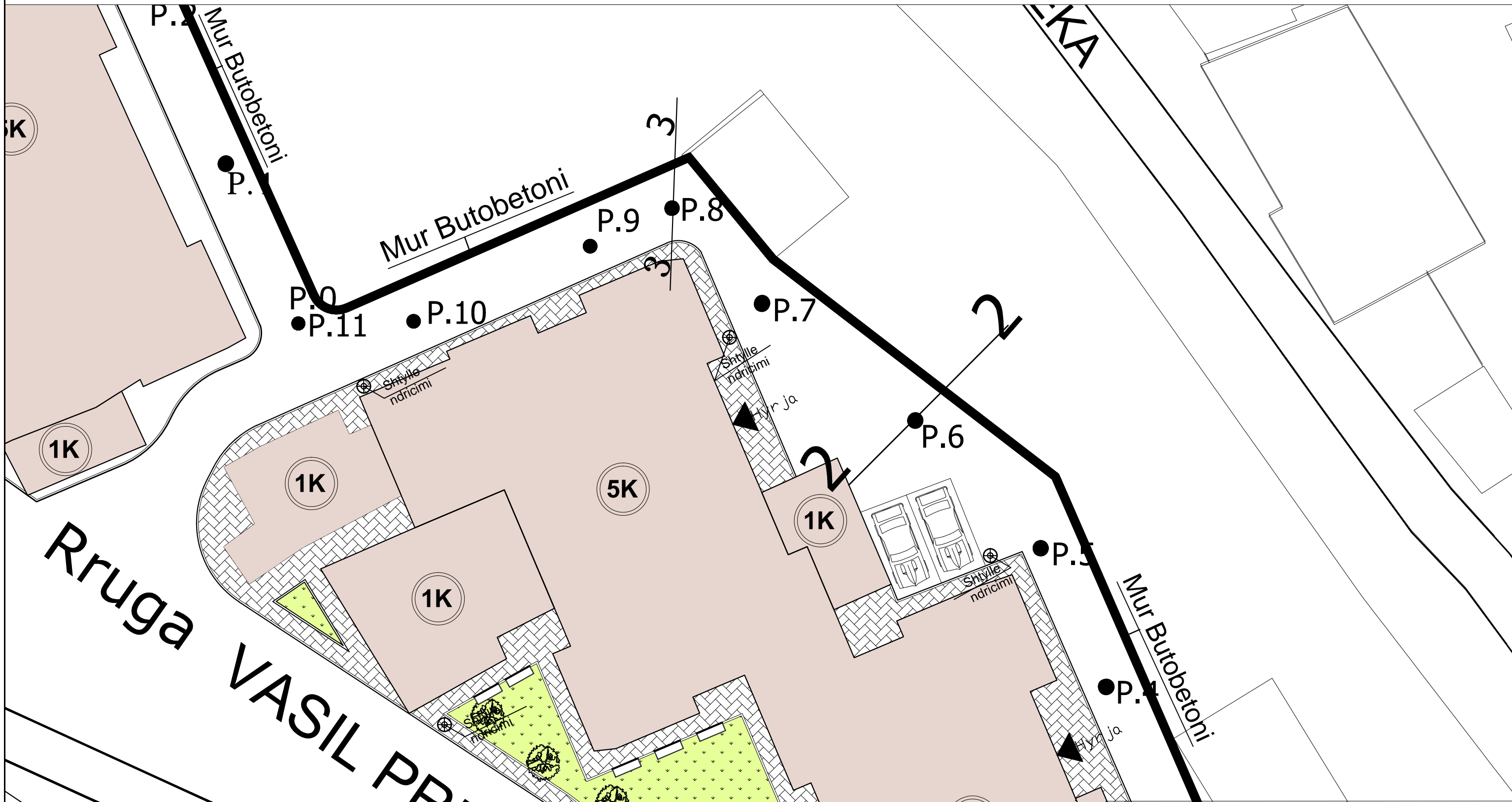

OBJEKTI	PLANIMETRIA E MURIT MBAJTES SEGMENTI NDERMJET RRUGES VASIL PRIFTI DHE SAZAN ZEKA	NR.FLETES	A-01
VENDNDODHJA	LAGJJA KONGRESI ,LUSHNJE	FORMATI	297X420
EMERT.I FLETES	PROFILET TERTHORE	SHKALLA	1:250
DREJTORIA	Ing. MIMOZA HAXHIU	 REPUBLIKA E SHQIPERISE BASHKIA LUSHNJE DREJTORIA E PLANIFIKIMIT SEKTORI I PROJEKTIMIT	
SPECIALIST	Ing .ARIOLA BEQO		
SPECIALIST	Top.Vasil Lena		

PLANVENDOSJA E MURIT MBAJTES SEGMENTI NDERMJET RRUGES VASIL PRIFTI DHE SAZAN ZEKA

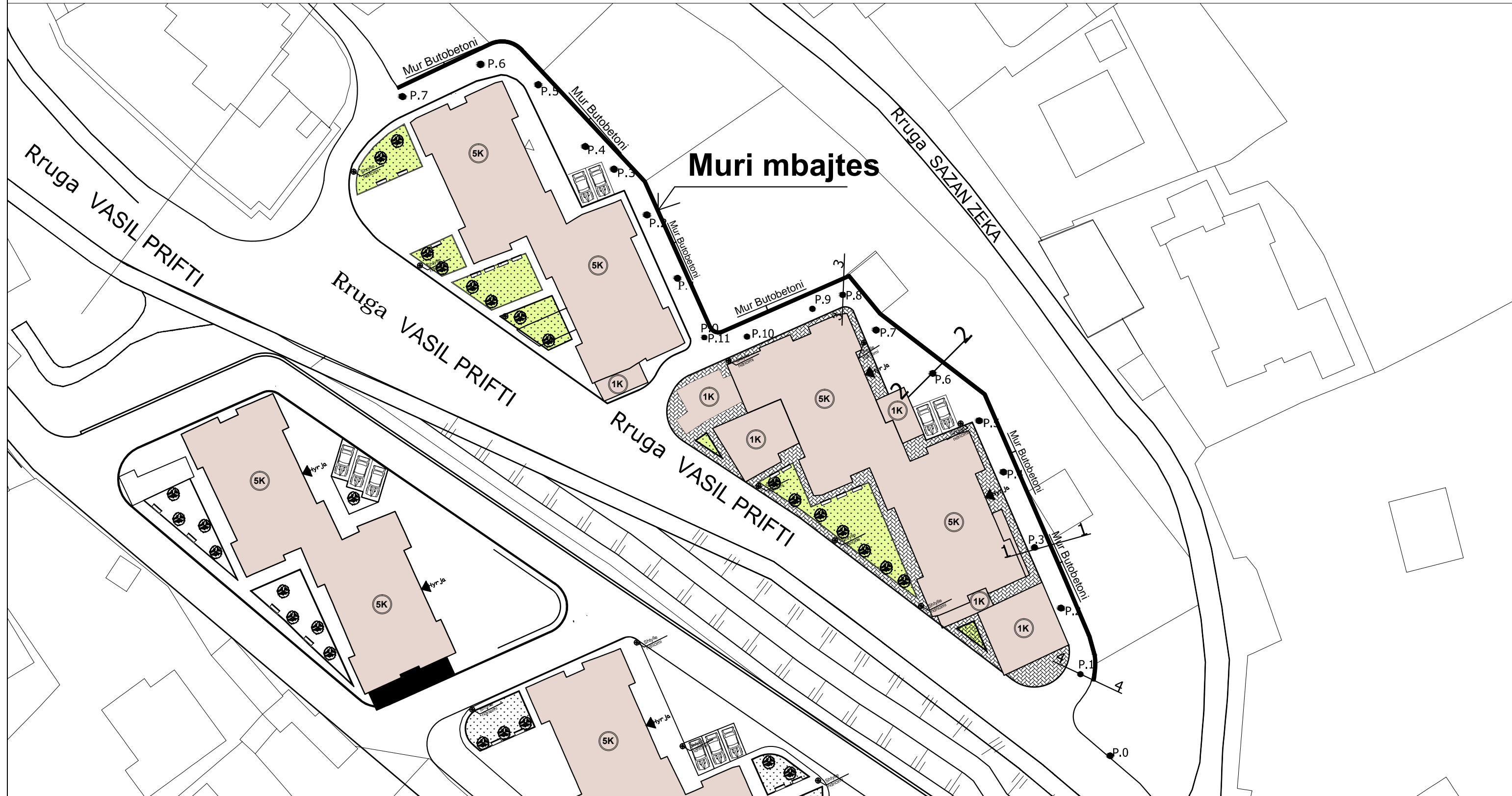

Shenim. Gjate zbatimit te projektit te kontaktohet me projektuesin per pozicionimin e sakte te gjurmes se murit mbajtes.

OBJEKTI	PLANIMETRIA E MURIT MBAJTES SEGMENTI NDERMJET RRUGES VASIL PRIFTI DHE SAZAN ZEKA	NR.FLETES	A-01
VENDNDODHJA	LAGJJA KONGRESI ,LUSHNJE	FORMATI	297X420
EMERTI FLETES	PROFILET TERTHORE	SHKALLA	1:250
DREJTORIA	Ing. MIMOZA HAXHIU	 REPUBLIKA E SHQIPERIS BASHKIA LUSHNJE DREJTORIA E PLANIFIKIMIT SEKTORI I PROJEKTIMIT	
SPECIALIST	Ing .ARIOLA BEQD		
SPECIALIST	Top.Vasil Lena		

Objekti . Muri mbajtes segmenti ndermet rruges Vasil Prifti dhe Sazan Zeka

Profili gjatesor segmenti 1

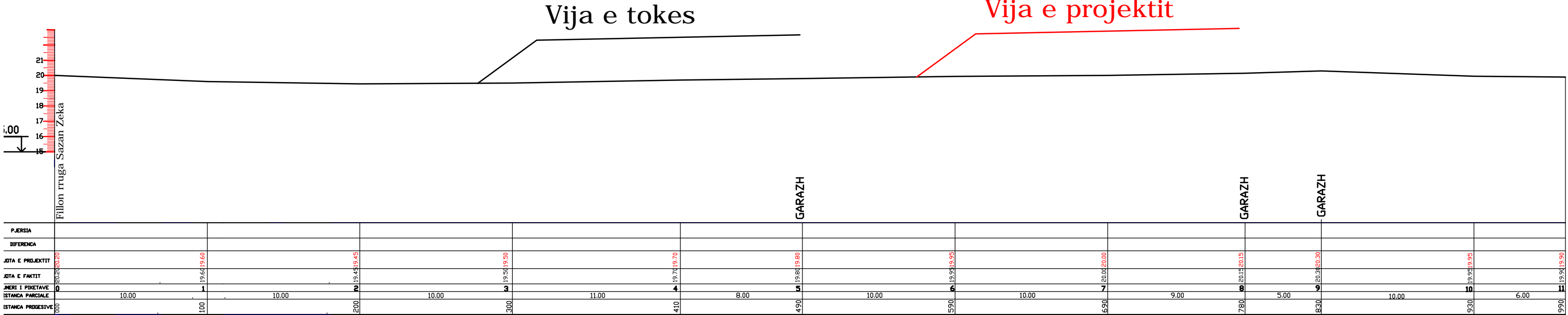

OBJEKTI	PLANIMETRIA E MURIT MBAJTES SEGMENTI NDERMJET RRUGES VASIL PRIFTI DHE SAZAN ZEKA	NR.FLETES	A-01
VENDNDODHJA	LAGJJA KONGRESI ,LUSHNJE	FORMATI	297X420
EMERT.I FLETES	PROFILET TERTHORE	SHKALLA	1:250
DREJTORIA	Ing. MIMOZA HAXHIU	 REPUBLIKA E SHQIPERISE BASHKIA LUSHNJE DREJTORIA E PLANIFIKIMIT SEKTORI I PROJEKTIMIT	
SPECIALIST	Ing .ARIOLA BEQO		
SPECIALIST	Top.Vasil Lena		

Objekti . Muri mbajtes segmenti ndermet rruges Vasil Prifti dhe Sazan Zeka

Profilet terthore Segmenti i dyte

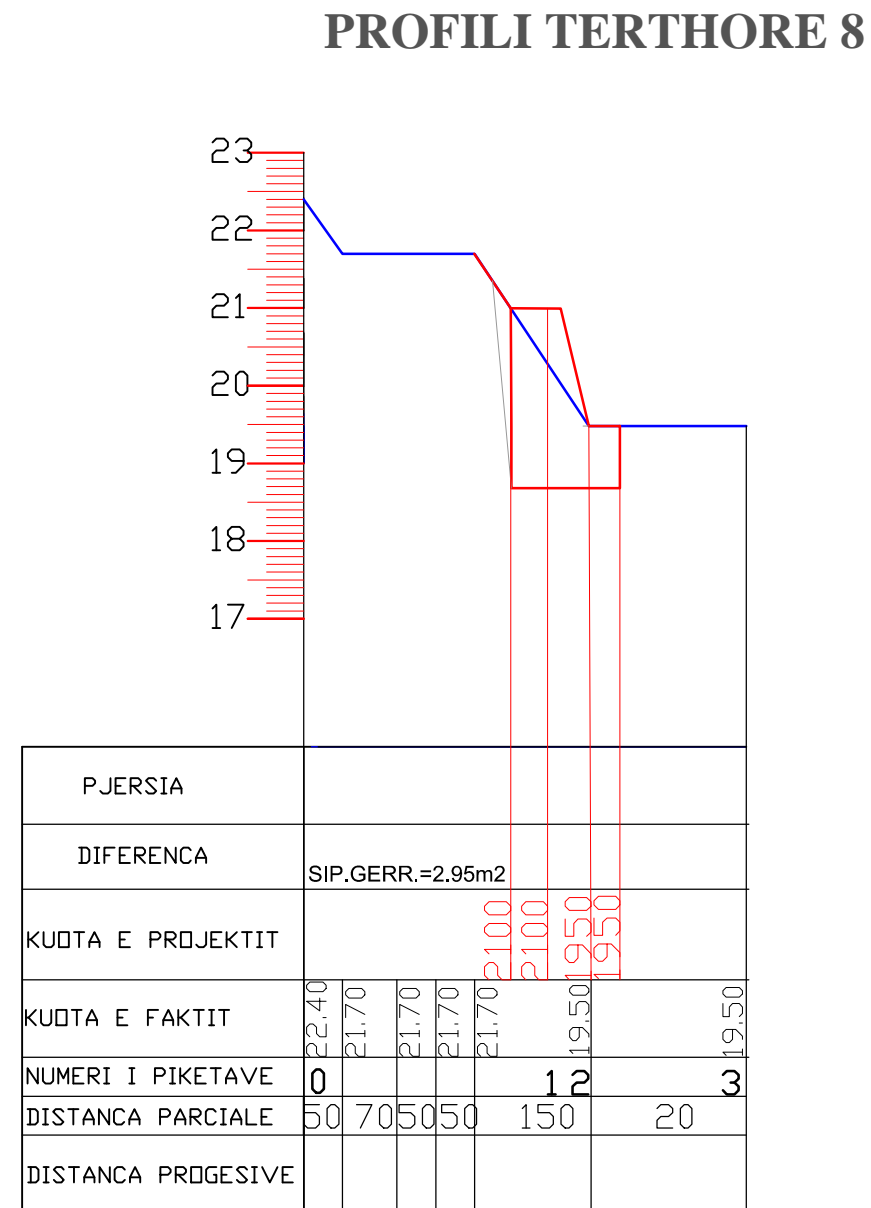
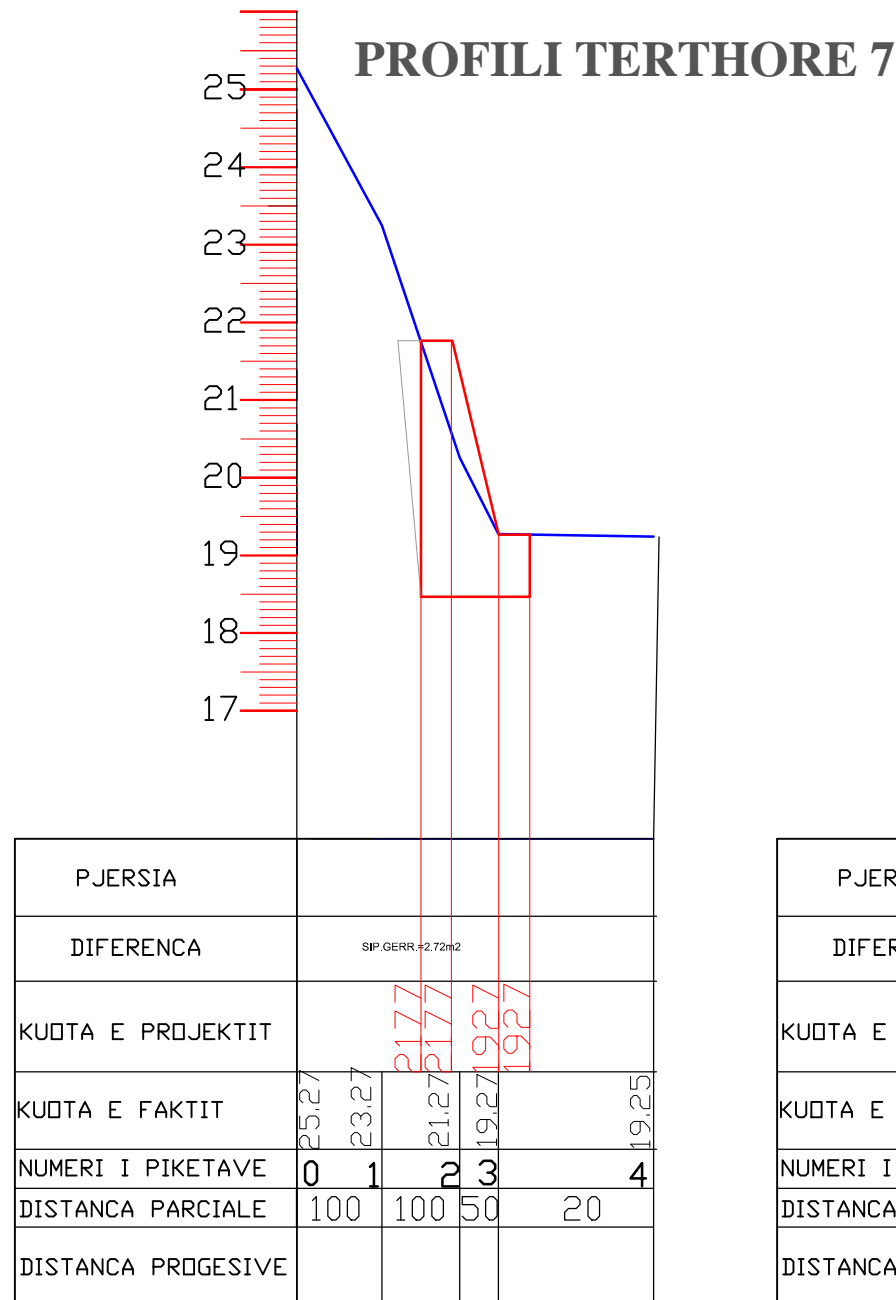

OBJEKTI	PLANIMETRIA E MURIT MBAJTES SEGMENTI NDERMJET RRUGES VASIL PRIFTI DHE SAZAN ZEKA	NR.FLETES	A-01
		FORMATI	297X420
VENDNDODHJA	LAGJJA KONGRESI ,LUSHNJE	SHKALLA	1:250
EMERT.I FLETES	PROFILET TERTHORE		
DREJTORIA	Ing. MIMOZA HAXHIU		
SPECIALIST	Ing .ARIOLA BEQO		
SPECIALIST	Top.Vasil Lena		



REPUBLIKA E SHQIPERISE
BASHKIA LUSHNJE
DREJTORIA E PLANIFIKIMIT
SEKTORI I PROJEKTIMIT

Objekti . Muri mbajtes segmenti ndermet rruges Vasil Prifti dhe Sazan Zeka

Profilet terthore

PROFILI TERTHORE 0

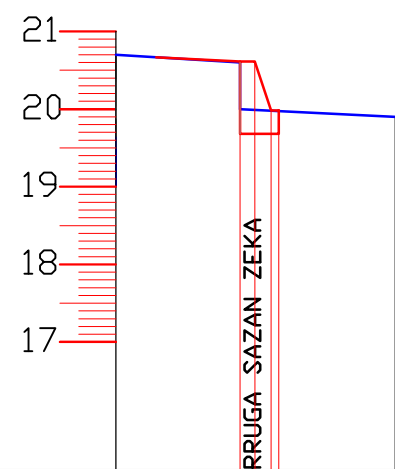

PJERSIA			
DIFERENCA			
KUOTA E PROJEKTIT		20.60 20.50 20.00	20.00
KUOTA E FAKTIT	20.70	20.60	19.90
NUMERI I PIKETAVE	0	1	3
DISTANCA PARCIALE	16	20	
DISTANCA PROGRESIVE			

PROFILI TERTHORE 1

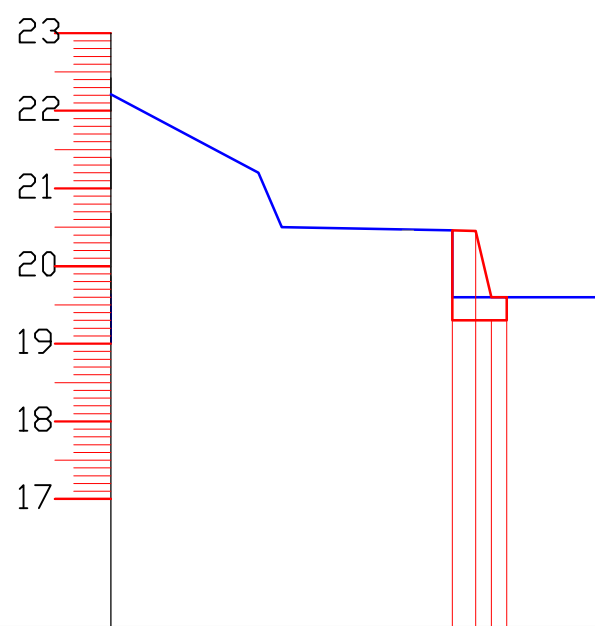

PJERSIA					
DIFERENCA					
KUOTA E PROJEKTIT				20.45 20.45 19.60 19.60	
KUOTA E FAKTIT	22.20	21.20	20.50	20.45	19.60
NUMERI I PIKETAVE	0	1	2	3	4
DISTANCA PARCIALE	20	3	22	20	
DISTANCA PROGRESIVE					

PROFILI TERTHORE 2

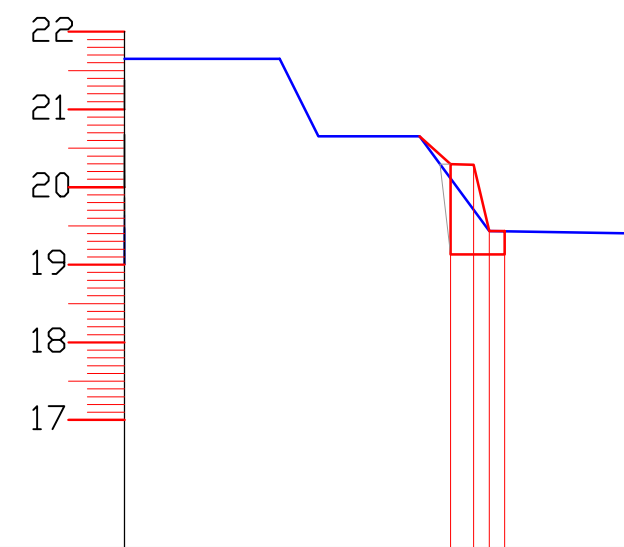

PJERSIA					
DIFERENCA					
KUOTA E PROJEKTIT				20.30 20.30 19.45 19.45	
KUOTA E FAKTIT	21.65	21.65	20.65	20.65	19.40
NUMERI I PIKETAVE	0	1	2	3	4
DISTANCA PARCIALE	20	5	13	9	20
DISTANCA PROGRESIVE					

OBJEKTI	PLANIMETRIA E MURIT MBAJTES SEGMENTI NDERMJET RRUGES VASIL PRIFTI DHE SAZAN ZEKA	NR.FLETES	A-01
		FORMATI	297X420
VENDNDODHJA	LAGJJA KONGRESI ,LUSHNJE	SHKALLA	1:250
EMERT.I FLETES	PROFILET TERTHORE		
DREJTORIA	Ing. MIMOZA HAXHIU		
SPECIALIST	Ing .ARIOLA BEQO		
SPECIALIST	Top.Vasil Lena		



Objekti . Muri mbajtes segmenti ndermet rruges Vasil Prifti dhe Sazan Zeka

Profilet terthore

PROFILI TERTHORE 4

PROFILI TERTHORE 5

PROFILI TERTHORE 3

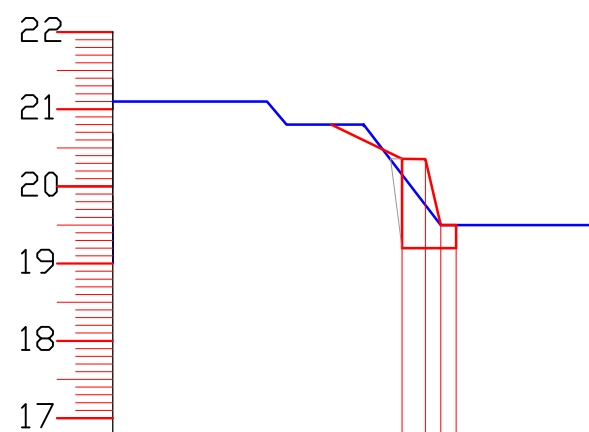

PJERSIA						
DIFERENCA						
KUOTA E PROJEKTIT				20.38 20.36 19.50		
KUOTA E FAKTIT	21.10	21.10	20.80	20.80	19.50	19.50
NUMERI I PIKETAVE	0	1	2	3	4	5
DISTANCA PARCIALE	20	2.5	10	10	20	
DISTANCA PROGESIVE						

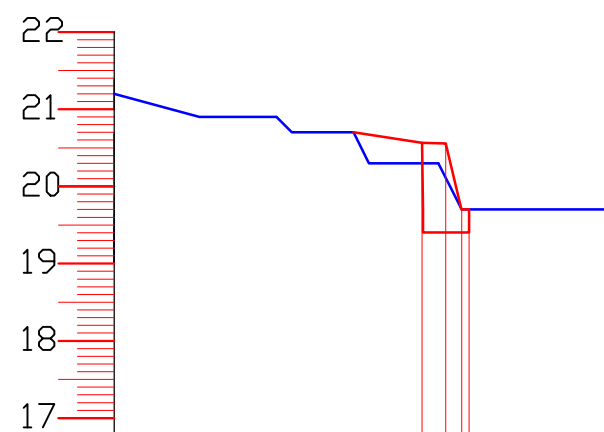

PJERSIA								
DIFERENCA								
KUOTA E PROJEKTIT					20.55 20.55 19.70			
KUOTA E FAKTIT	21.20	20.90	20.90	20.70	20.30	20.30	19.70	19.70
NUMERI I PIKETAVE	0	1	2	3	5	6	7	8
DISTANCA PARCIALE	11	10	2	8	2	9	3	20
DISTANCA PROGESIVE								

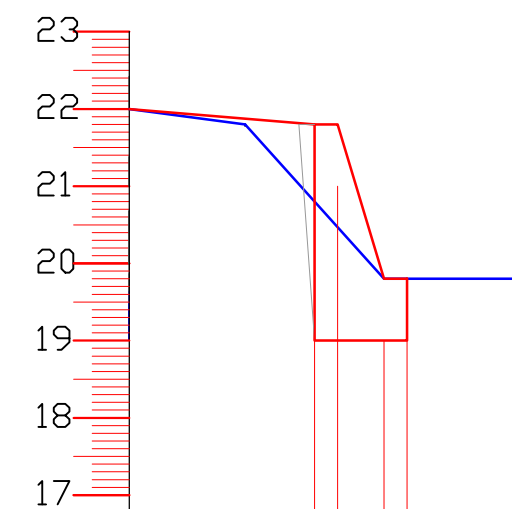

PJERSIA				
DIFERENCA		21.80 21.80	19.80 19.80	
KUOTA E PROJEKTIT				
KUOTA E FAKTIT	22.00	21.80	19.80	19.80
NUMERI I PIKETAVE	0	1	2	3
DISTANCA PARCIALE	15	18	20	
DISTANCA PROGESIVE				

OBJEKTI	PLANIMETRIA E MURIT MBAJTES SEGMENTI NDERMJET RRUGES VASIL PRIFTI DHE SAZAN ZEKA	NR.FLETES	A-01
		FORMATI	297X420
VENDNDODHJA	LAGJJA KONGRESI ,LUSHNJE	SHKALLA	1:250
EMERT.I FLETES	PROFILET TERTHORE		
DREJTORIA	Ing. MIMOZA HAXHIU		
SPECIALIST	Ing .ARIOLA BEQO		
SPECIALIST	Top.Vasil Lena		



REPUBLIKA E SHQIPERISE
BASHKIA LUSHNJE
DREJTORIA E PLANIFIKIMIT
SEKTORI I PROJEKTIMIT

Objekti . Muri mbajtes segmenti ndermet rruges Vasil Prifti dhe Sazan Zeka

Profilet terthore

PROFILI TERTHORE 7

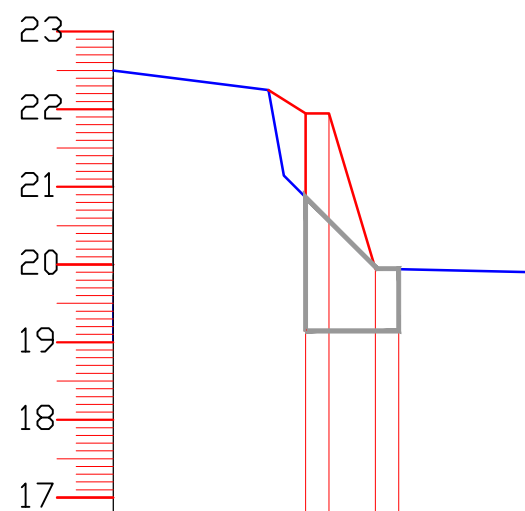

PJERSIA					
DIFERENCA					
KUOTA E PROJEKTIT			2195	1980	
KUOTA E FAKTIT	22.50	22.25	21.15	19.95	19.90
NUMERI I PIKETAVE	0	1	2	3	4
DISTANCA PARCIALE	20	2	12	20	
DISTANCA PROGESIVE					

PROFILI TERTHORE 8

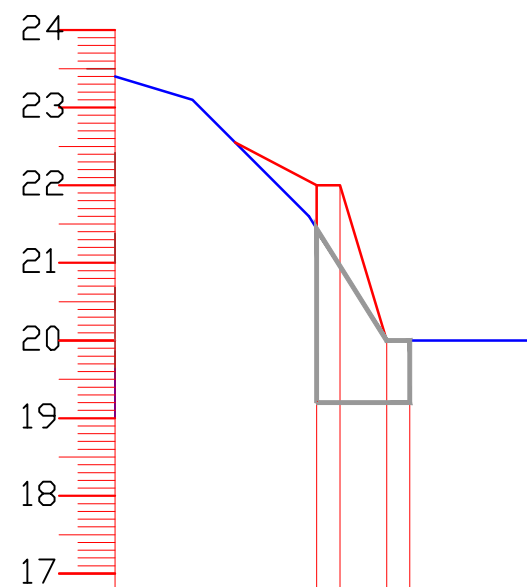

PJERSIA					
DIFERENCA					
KUOTA E PROJEKTIT			2200	2020	
KUOTA E FAKTIT	23.40	23.10	21.60	20.00	20.00
NUMERI I PIKETAVE	0	1	2	3	4
DISTANCA PARCIALE	10	15	10	20	
DISTANCA PROGESIVE					

PROFILI TERTHORE 9

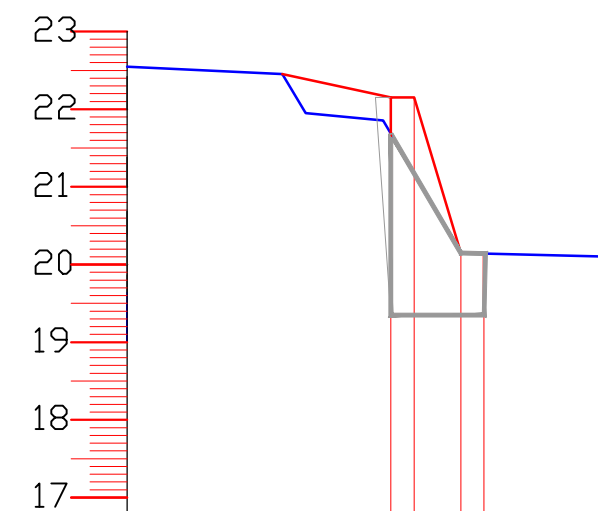

PJERSIA					
DIFERENCA			2215	2015	
KUOTA E PROJEKTIT					
KUOTA E FAKTIT	22.55	22.45	21.95	20.15	20.10
NUMERI I PIKETAVE	0	1	2	3	4
DISTANCA PARCIALE	20	10	10	20	
DISTANCA PROGESIVE					

OBJEKTI	PLANIMETRIA E MURIT MBAJTES SEGMENTI NDERMJET RRUGES VASIL PRIFTI DHE SAZAN ZEKA	NR.FLETES	A-01
VENDNDODHJA	LAGJJA KONGRESI ,LUSHNJE	FORMATI	297X420
EMERT.I FLETES	PROFILET TERTHORE	SHKALLA	1:250
DREJTORIA	Ing. MIMOZA HAXHIU	 REPUBLIKA E SHQIPERISE BASHKIA LUSHNJE DREJTORIA E PLANIFIKIMIT SEKTORI I PROJEKTIMIT	
SPECIALIST	Ing .ARIOLA BEQO		
SPECIALIST	Top.Vasil Lena		

Objekti . Muri mbajtes segmenti ndermet rruges Vasil Prifti dhe Sazan Zeka

Profilet terthore

PROFILI TERTHORE 10

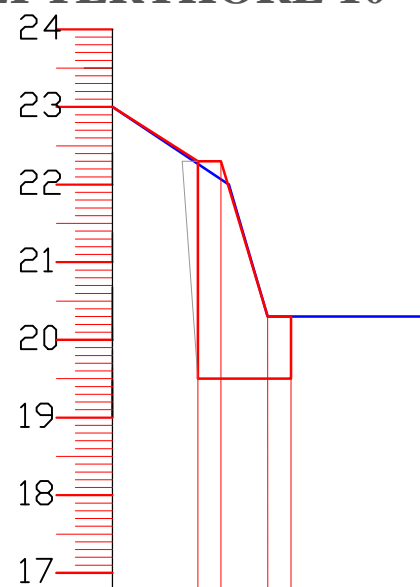

PJERSIA				
DIFERENCA				
KUOTA E PROJEKTIT		2230	2230	2030
KUOTA E FAKTIT	23.00	22.00	20.30	20.30
NUMERI I PIKETAVE	0	1	2	3
DISTANCA PARCIALE		15	5	20
DISTANCA PROGESIVE				

PROFILI TERTHORE 11

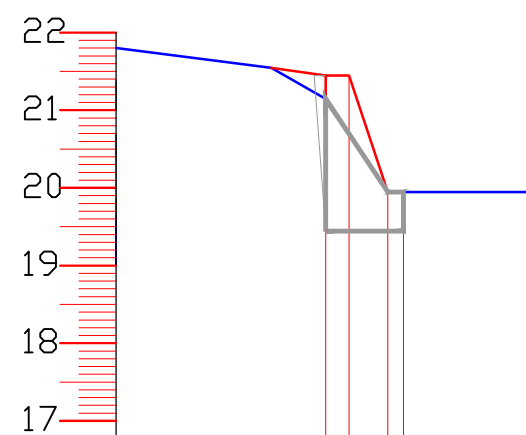

PJERSIA				
DIFERENCA				
KUOTA E PROJEKTIT			2145	2145
KUOTA E FAKTIT	21.80	21.55	21.15	19.95
NUMERI I PIKETAVE	0	1	2	3
DISTANCA PARCIALE		20	7	8
DISTANCA PROGESIVE				20

PROFILI TERTHORE 12

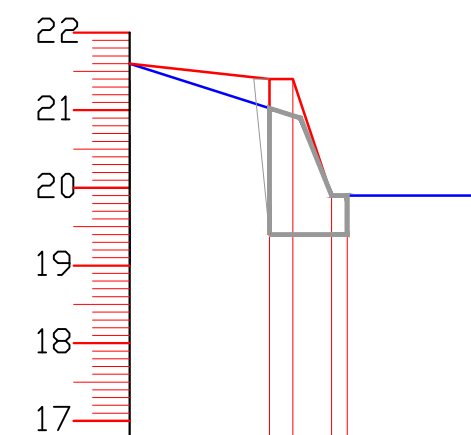

PJERSIA			
DIFERENCA		2140	2140
KUOTA E PROJEKTIT		1990	1990
KUOTA E FAKTIT	21.60	20.90	19.90
NUMERI I PIKETAVE	0	1	2
DISTANCA PARCIALE		22	4
DISTANCA PROGESIVE			20

OBJEKTI	PLANIMETRIA E MURIT MBAJTES SEGMENTI NDERMJET RRUGES VASIL PRIFTI DHE SAZAN ZEKA	NR.FLETES	A-01
VENDNDODHJA	LAGJJA KONGRESI ,LUSHNJE	FORMATI	297X420
EMERT.I FLETES	PROFILET TERTHORE	SHKALLA	1:250
DREJTORIA	Ing. MIMOZA HAXHIU	 REPUBLIKA E SHQIPERISE BASHKIA LUSHNJE DREJTORIA E PLANIFIKIMIT SEKTORI I PROJEKTIMIT	
SPECIALIST	Ing .ARIOLA BEQO		
SPECIALIST	Top.Vasil Lena		

Objekti . Muri mbajtes segmenti ndermet rruges Vasil Prifti dhe Sazan Zeka

Profilet terthore Segmenti i dyte

PROFILI TERTHORE 1

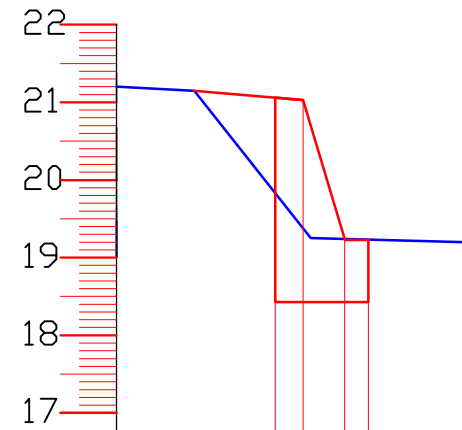

PJERSIA			
DIFERENCA			
KUOTA E PROJEKTIT	SIP.GERR.=1.85m ²		
KUOTA E FAKTIT	21.20	21.15	19.25
NUMERI I PIKETAVE	0	1	2
DISTANCA PARCIALE	10	15	20
DISTANCA PROGESIVE			

PROFILI TERTHORE 2

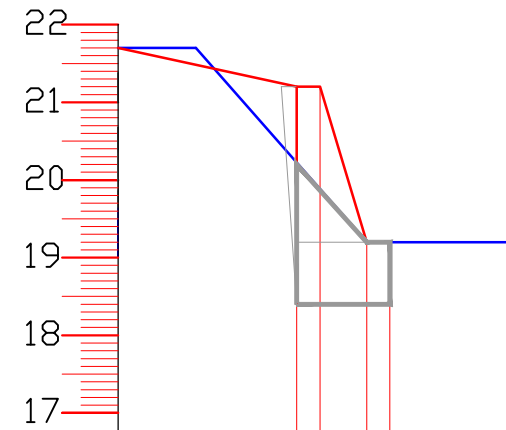

PJERSIA			
DIFERENCA			
KUOTA E PROJEKTIT	SIP.GERR.=2.22m ²		
KUOTA E FAKTIT	21.70	21.20	19.20
NUMERI I PIKETAVE	0	1	2
DISTANCA PARCIALE	10	22	20
DISTANCA PROGESIVE			

PROFILI TERTHORE 3

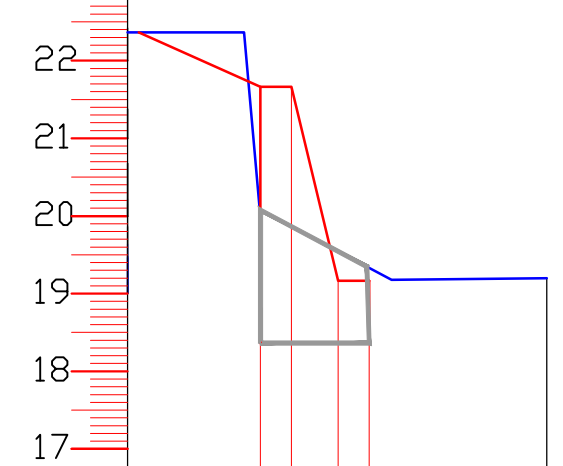

PJERSIA			
DIFERENCA			
KUOTA E PROJEKTIT	SIP.GERR.=2.00m ²		
KUOTA E FAKTIT	22.37	21.68	19.17
NUMERI I PIKETAVE	0	1	2
DISTANCA PARCIALE	15	2	17
DISTANCA PROGESIVE			

OBJEKTI	PLANIMETRIA E MURIT MBAJTES SEGMENTI NDERMJET RRUGES VASIL PRIFTI DHE SAZAN ZEKA	NR.FLETES	A-01
VENDNDODHJA	LAGJJA KONGRESI ,LUSHNJE	FORMATI	297X420
EMERT.I FLETES	PROFILET TERTHORE	SHKALLA	1:250
DREJTORIA	Ing. MIMOZA HAXHIU	 REPUBLIKA E SHQIPERISE BASHKIA LUSHNJE DREJTORIA E PLANIFIKIMIT SEKTORI I PROJEKTIMIT	
SPECIALIST	Ing .ARIOLA BEQO		
SPECIALIST	Top.Vasil Lena		

Objekti . Muri mbajtes segmenti ndermet rruges Vasil Prifti dhe Sazan Zeka

Profilet terthore Segmenti i dyte

PROFILI TERTHORE 4

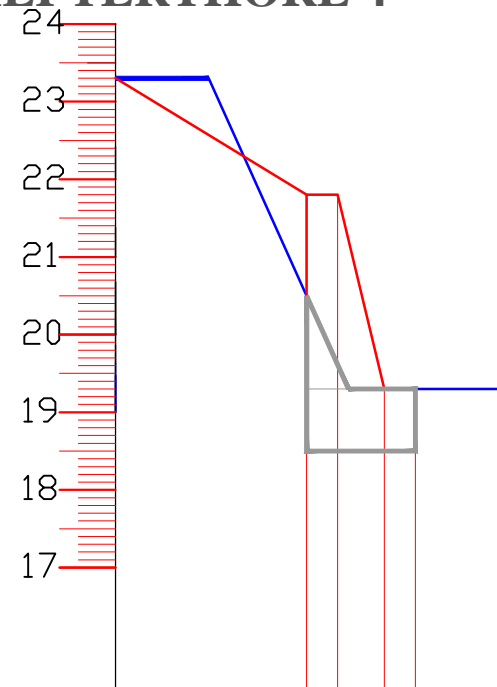

PJERSIA	
DIFERENCA	SIP.GERR.=2.7m ²
KUOTA E PROJEKTIT	21.80 21.80 19.30 19.30
KUOTA E FAKTIT	22.30 23.30 19.30 19.30
NUMERI I PIKETAVE	0 1 2 3
DISTANCA PARCIALE	12 18 20
DISTANCA PROGESIVE	

PROFILI TERTHORE 5

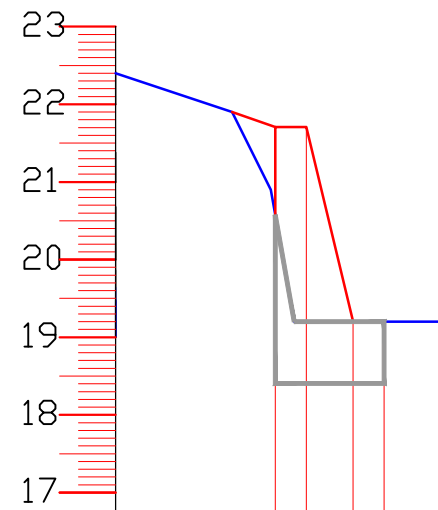

PJERSIA	
DIFERENCA	SIP.GERR.=3.45m ²
KUOTA E PROJEKTIT	21.70 21.70 19.20 19.20
KUOTA E FAKTIT	22.40 21.90 20.90 19.20 19.20
NUMERI I PIKETAVE	0 1 2 3
DISTANCA PARCIALE	15 5 3 20
DISTANCA PROGESIVE	

PROFILI TERTHORE 6

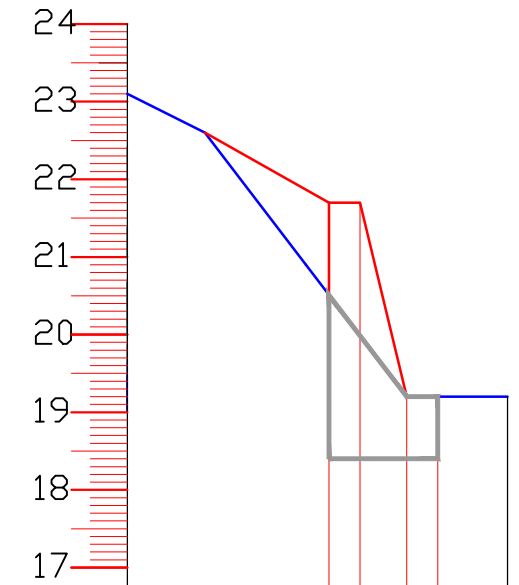

PJERSIA	
DIFERENCA	SIP.GERR.=2m ²
KUOTA E PROJEKTIT	21.70 21.70 19.20 19.20
KUOTA E FAKTIT	23.10 22.60 20.90 19.20 19.20
NUMERI I PIKETAVE	0 1 2 3 4
DISTANCA PARCIALE	10 13 13 20
DISTANCA PROGESIVE	

OBJEKTI	PLANIMETRIA E MURIT MBAJTES SEGMENTI NDERMJET RRUGES VASIL PRIFTI DHE SAZAN ZEKA	NR.FLETES	A-01
VENDNDODHJA	LAGJJA KONGRESI ,LUSHNJE	FORMATI	297X420
EMERT.I FLETES	PROFILET TERTHORE	SHKALLA	1:250
DREJTORIA	Ing. MIMOZA HAXHIU	 REPUBLIKA E SHQIPERISE BASHKIA LUSHNJE DREJTORIA E PLANIFIKIMIT SEKTORI I PROJEKTIMIT	
SPECIALIST	Ing .ARIOLA BEQO		
SPECIALIST	Top.Vasil Lena		

PRERJA TERTHORE TIPI 1

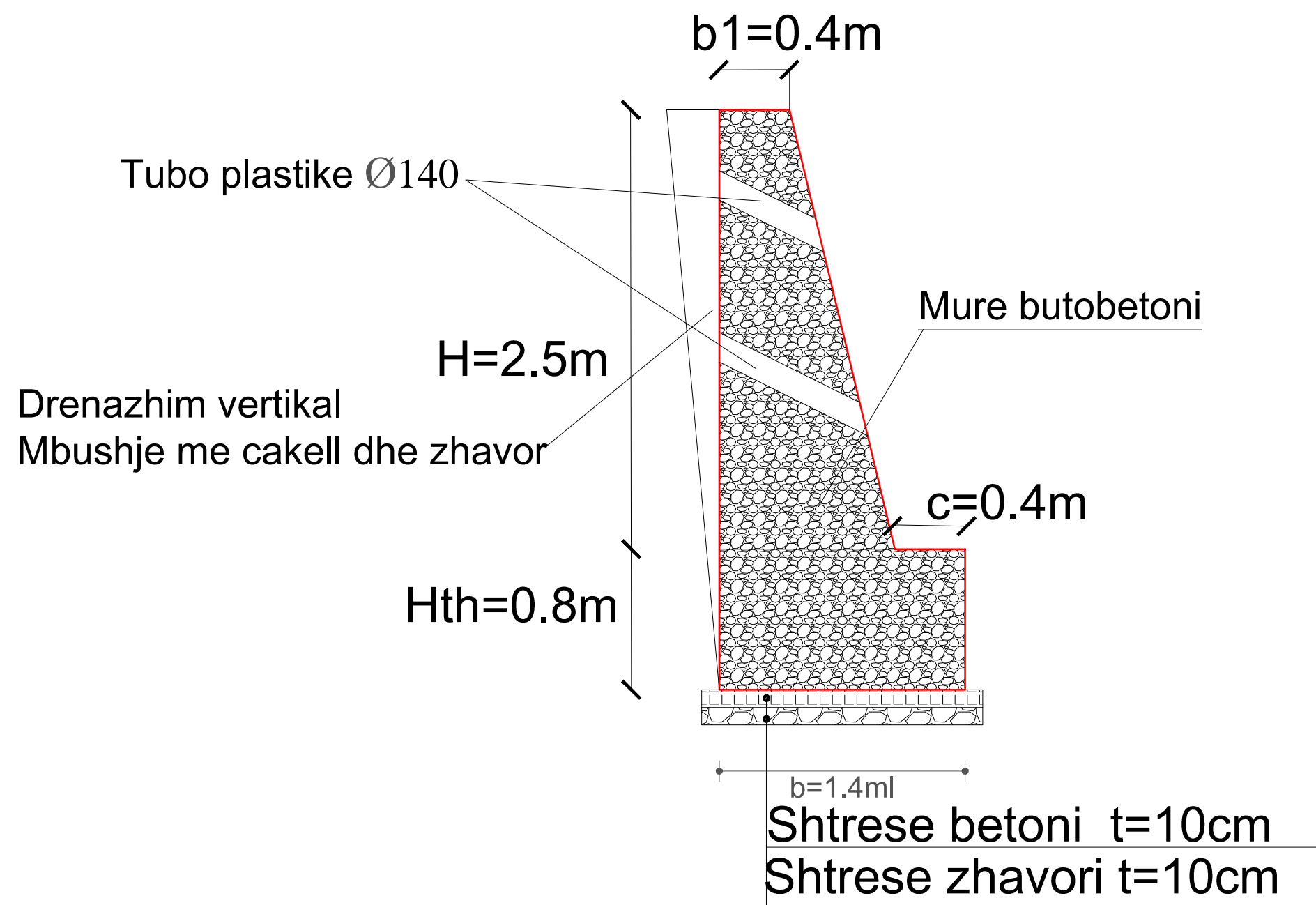

OBJEKTI	PLANIMETRIA E MURIT MBAJTES SEGMENTI NDERMJET RRUGES VASIL PRIFTI DHE SAZAN ZEKA	NR. FLETES	A-01
		FORMATI	297X420
VENDNDODHJA	LAGJJA KONGRESI „LUSHNJE	SHKALLA	1:30
EMERT.I FLETES	PRERJE TERTHORE		
DREJTORIA	Ing. MIMOZA HAXHIU		
SPECIALIST	Ark. ALBAN MANOKU		
SPECIALIST	Ing .ARIOLA BEÇO Top.Vasil Lena		
		 REPUBLIKA E SHQIPERISE BASHKIA LUSHNJE DREJTORIA E PLANIFIKIMIT SEKTORI I PROJEKTIMIT	

PRERJA TERTHORE TIPI 2

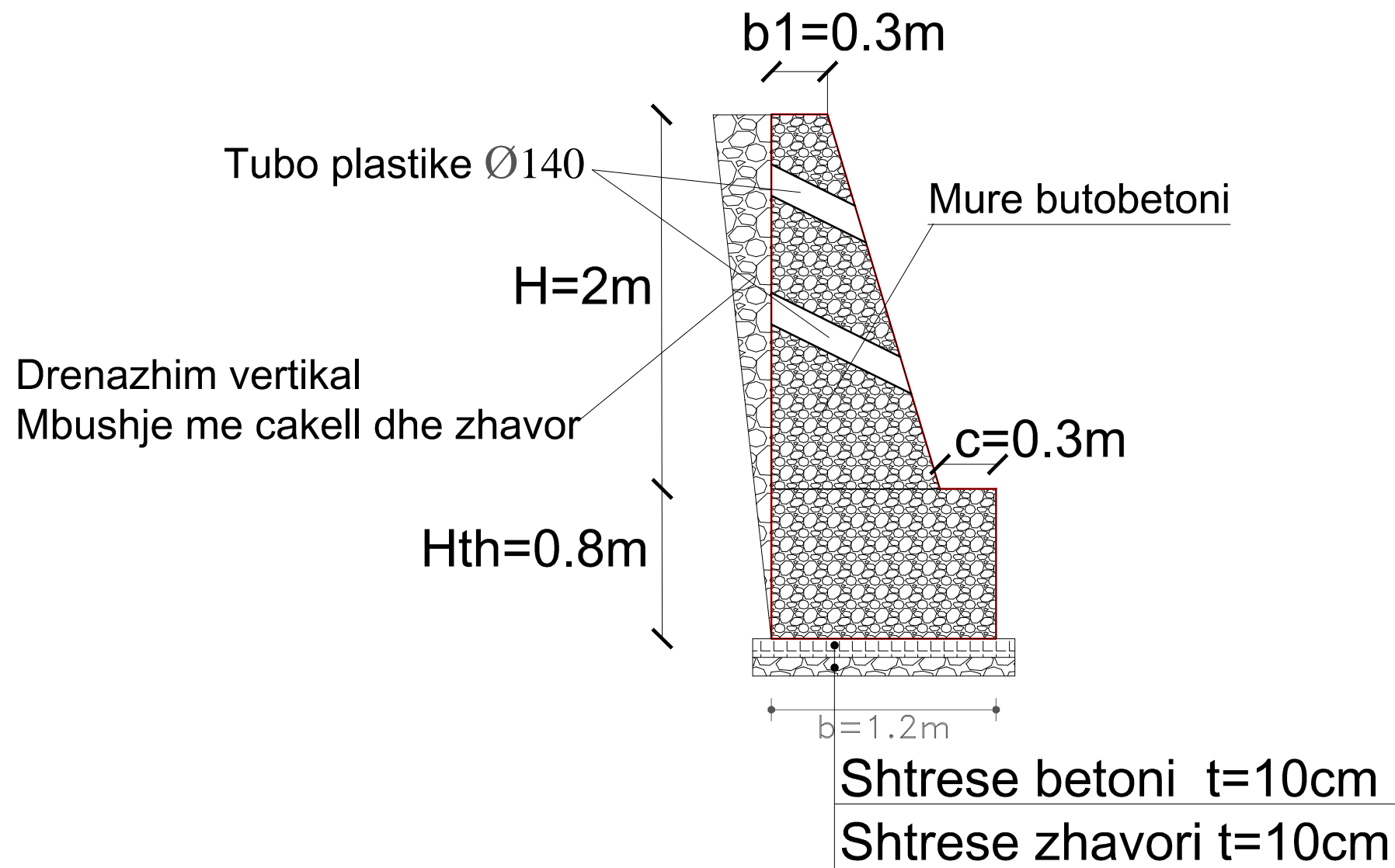

OBJEKTI	PLANIMETRIA E MURIT MBAJTES SEGMENTI NDERMJET RRUGES VASIL PRIFTI DHE SAZAN ZEKA	NR. FLETES	A-01
		FORMATI	297X420
VENDNDODHJA	LAGJJA KONGRESI „LUSHNJE	SHKALLA	1:30
EMERT.I FLETES	PRERJE TERTHORE	 REPUBLIKA E SHQIPERISE BASHKIA LUSHNJE DREJTORIA E PLANIFIKIMIT SEKTORI I PROJEKTIMIT	
DREJTORIA	Ing. MIMOZA HAXHIU		
SPECIALIST	Ark. ALBAN MANOKU		
SPECIALIST	Ing. ARIOLA BEQO Top. Vasil Lena		

PRERJA TERTHORE TIPI 3

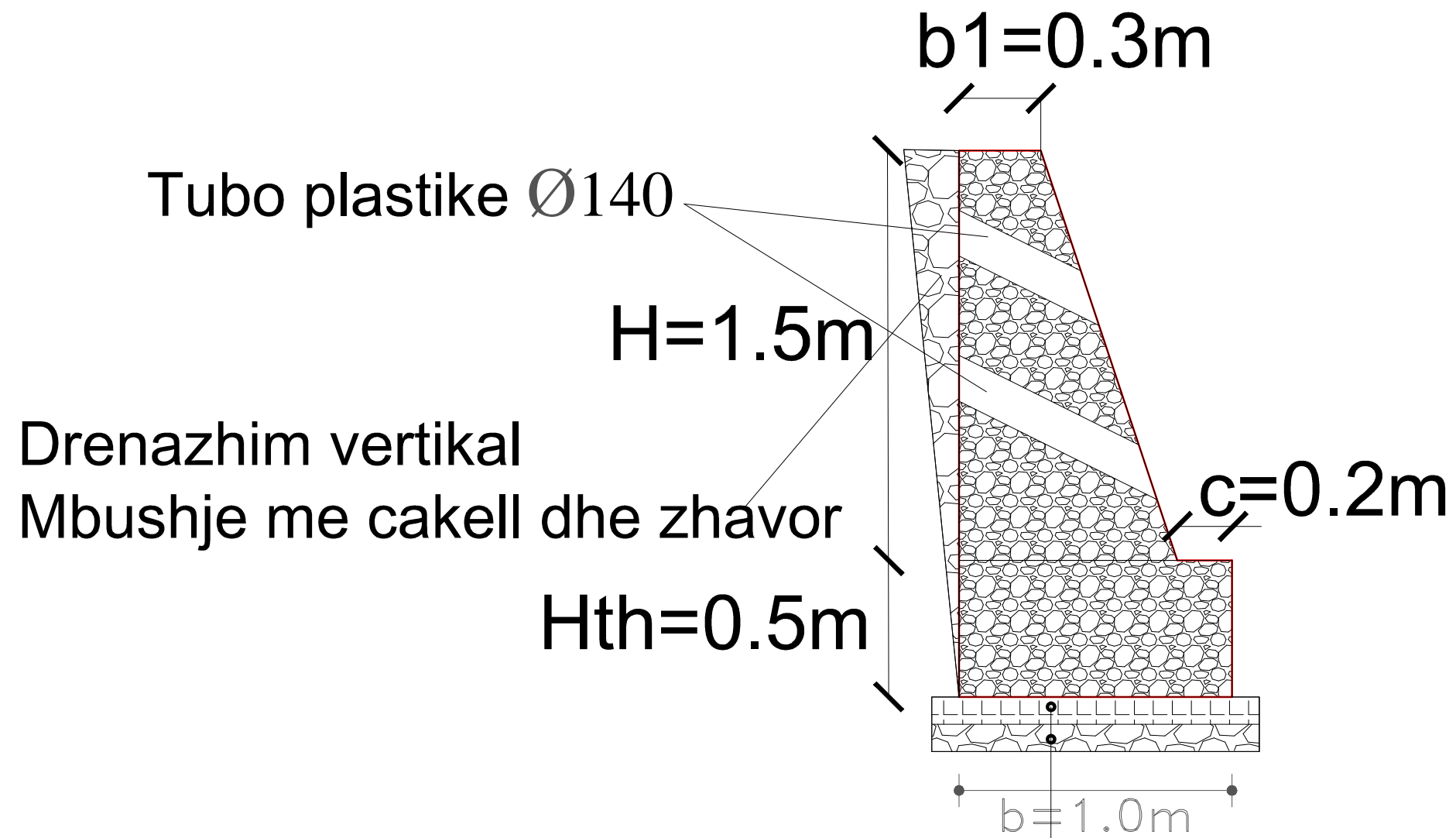

Shtrese betoni t=10cm
Shtrese zhavori t=10cm

OBJEKTI	PLANIMETRIA E MURIT MBAJTES SEGMENTI NDERMJET RRUGES VASIL PRIFTI DHE SAZAN ZEKA	NR. FLETES	A-01
		FORMATI	297X420
VENDNDODHJA	LAGJJA KONGRESI „LUSHNJE	SHKALLA	1:30
EMERT.I FLETES	PRERJE TERTHORE	 REPUBLIKA E SHQIPERISE BASHKIA LUSHNJE DREJTORIA E PLANIFIKIMIT SEKTORI I PROJEKTIMIT	
DREJTORIA	Ing. MIMOZA HAXHIU		
SPECIALIST	Ark. ALBAN MANOKU		
SPECIALIST	Ing. ARIOLA BEQO Top.Vasil Lena		

PRERJA TERTHORE TIPI 4

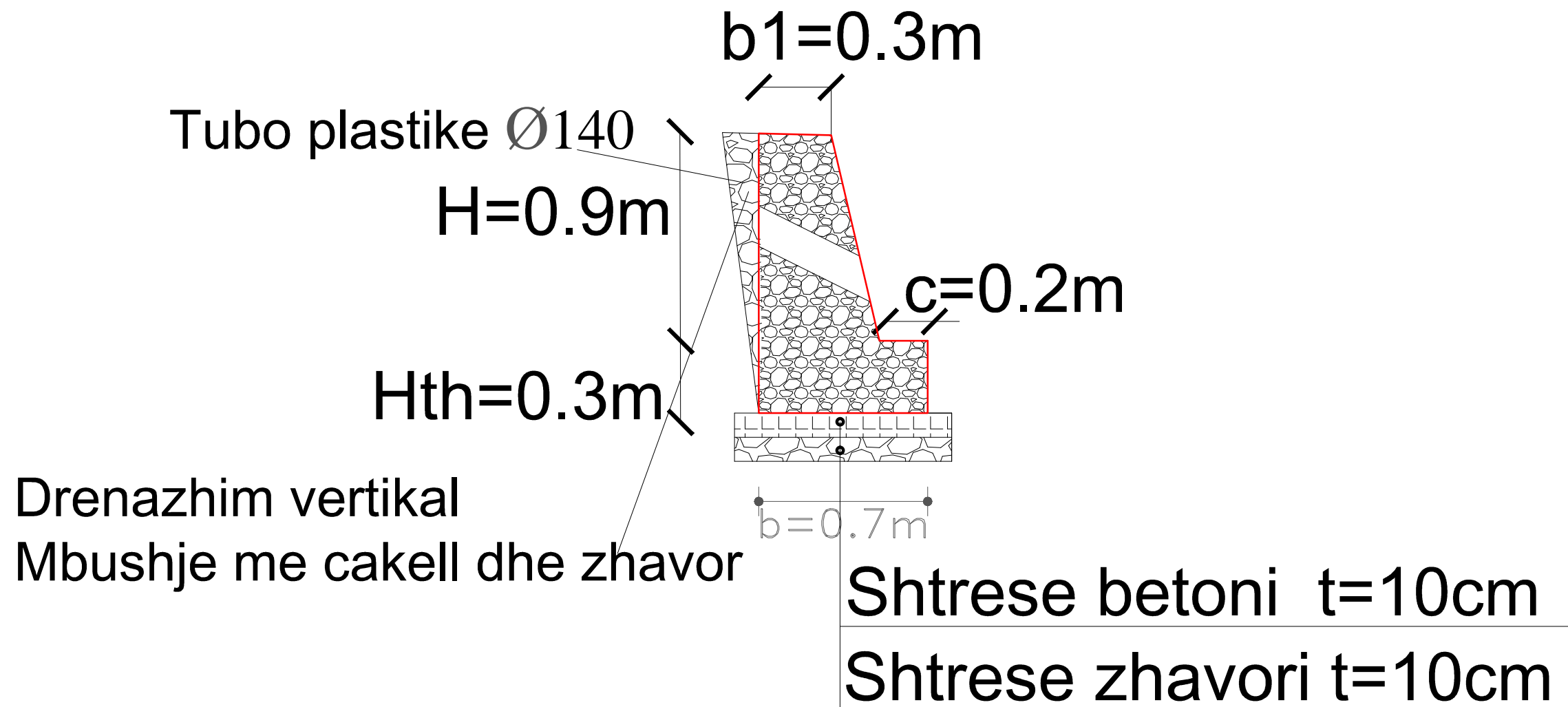

OBJEKTI	PLANIMETRIA E MURIT MBAJTES SEGMENTI NDERMJET RRUGES VASIL PRIFTI DHE SAZAN ZEKA	NR. FLETES	A-01
		FORMATI	297X420
VENDNDODHJA	LAGJJA KONGRESI „LUSHNJE	SHKALLA	1:30
EMERT.I FLETES	PRERJE TERTHORE	 REPUBLIKA E SHQIPERISE BASHKIA LUSHNJE DREJTORIA E PLANIFIKIMIT SEKTORI I PROJEKTIMIT	
DREJTORIA	Ing. MIMOZA HAXHIU		
SPECIALIST	Ark. ALBAN MANOKU		
SPECIALIST	Ing .ARIOLA BEQO Top.Vasil Lena		