

**POROSITESI : BASHKIA TROPOJË**  
 OBJEKTI:  
 "PROJEKT I RRUGES SE FSHATIT KASAJ, BASHKIA TROPOJË "

Emertimi: PROFILET TERTHORE  
 "ASI2STUDIO" Sh.p.k  
 Adresa:  
 Kompleksi Vizon Plus, Tirane.

ASI2-STUDIO  
 Ing. MENTOR ÇOKAJ  
 Nr. Lic. XI/1451  
 Tel: 069 27 20 79

Projektues  
 Ing. Mentor ÇOKAJ

SHKALLA	FLETA
1 : 200	7 - 15
Tropojë 2022	Format A2

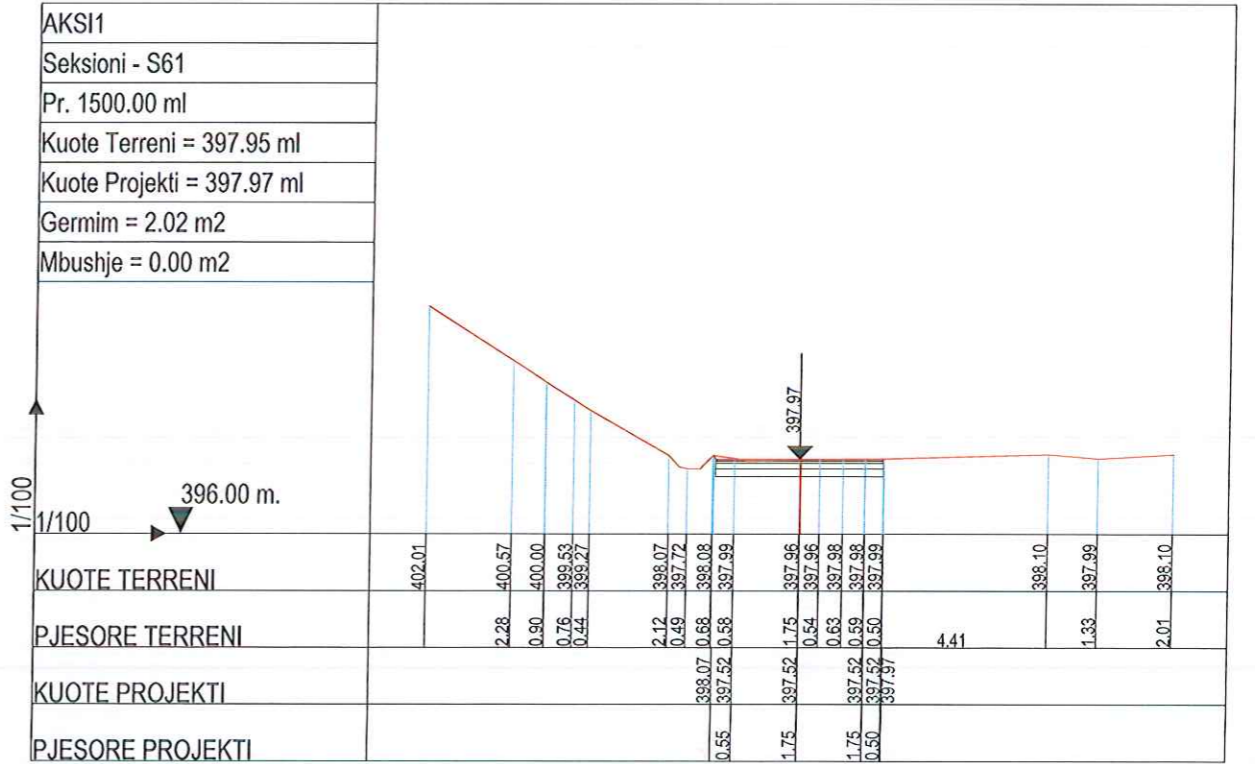
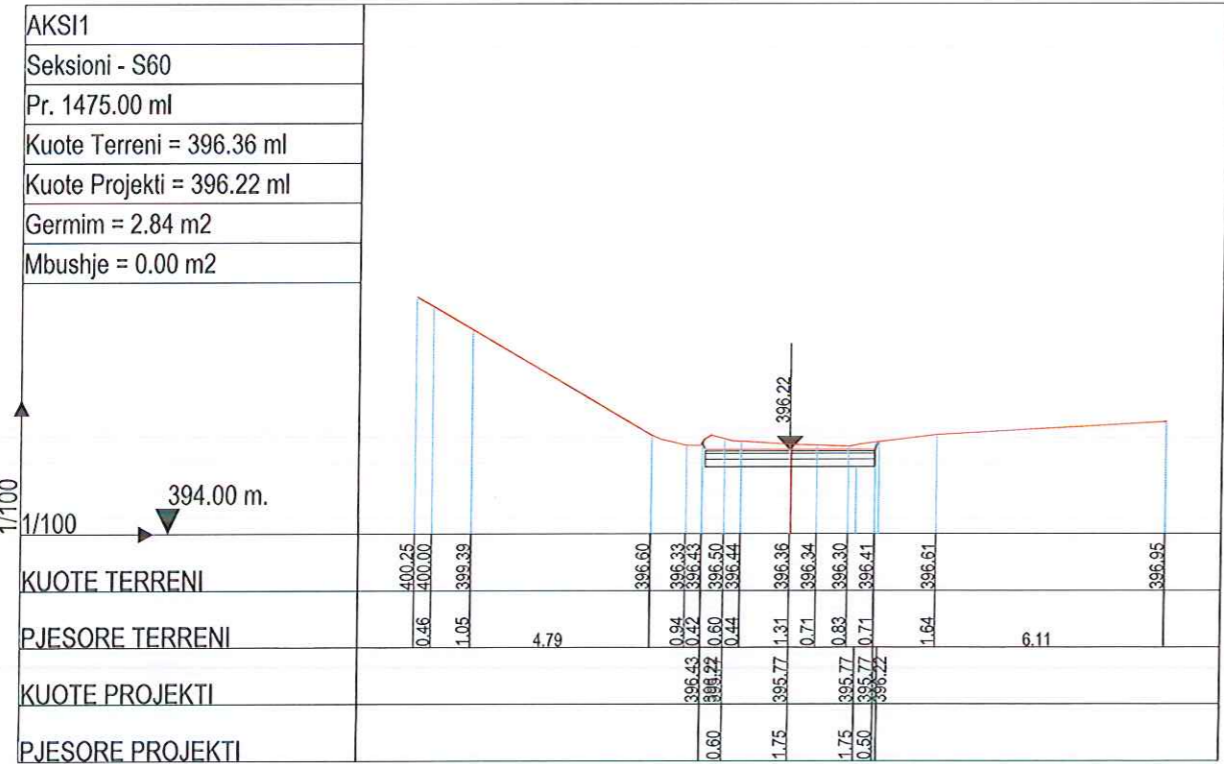
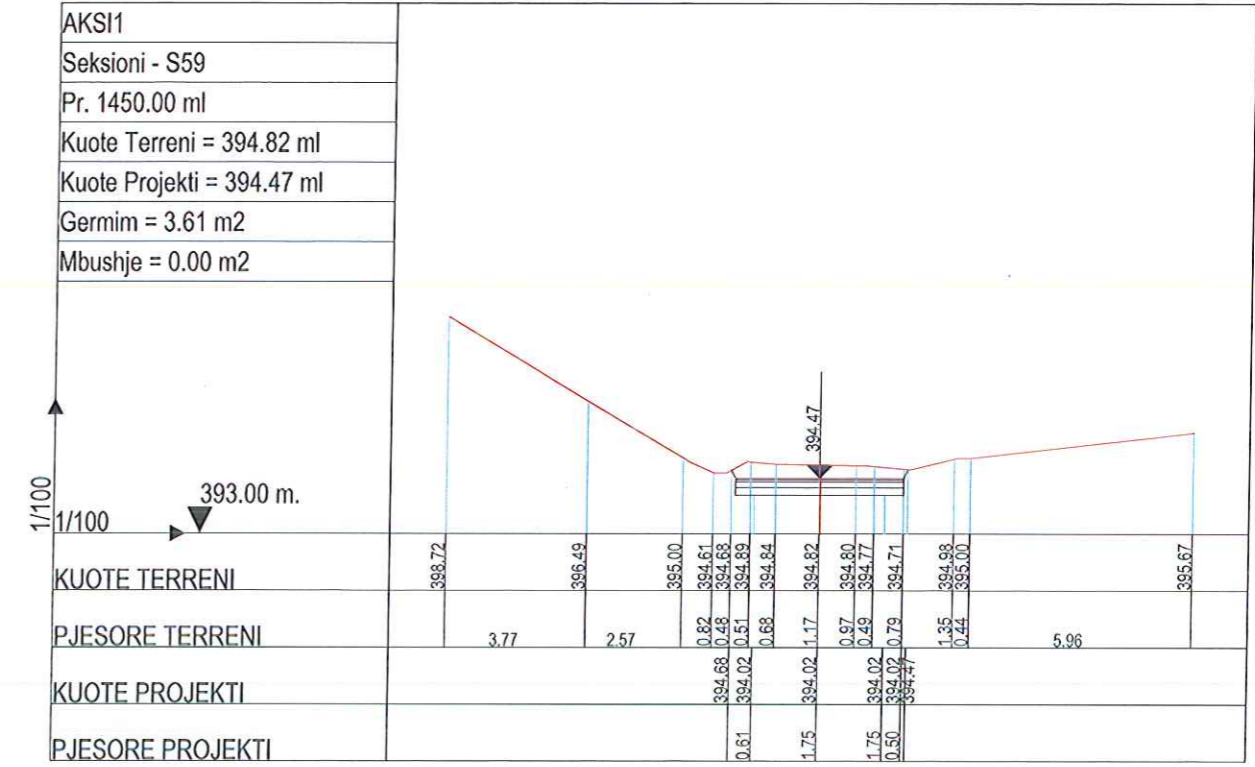
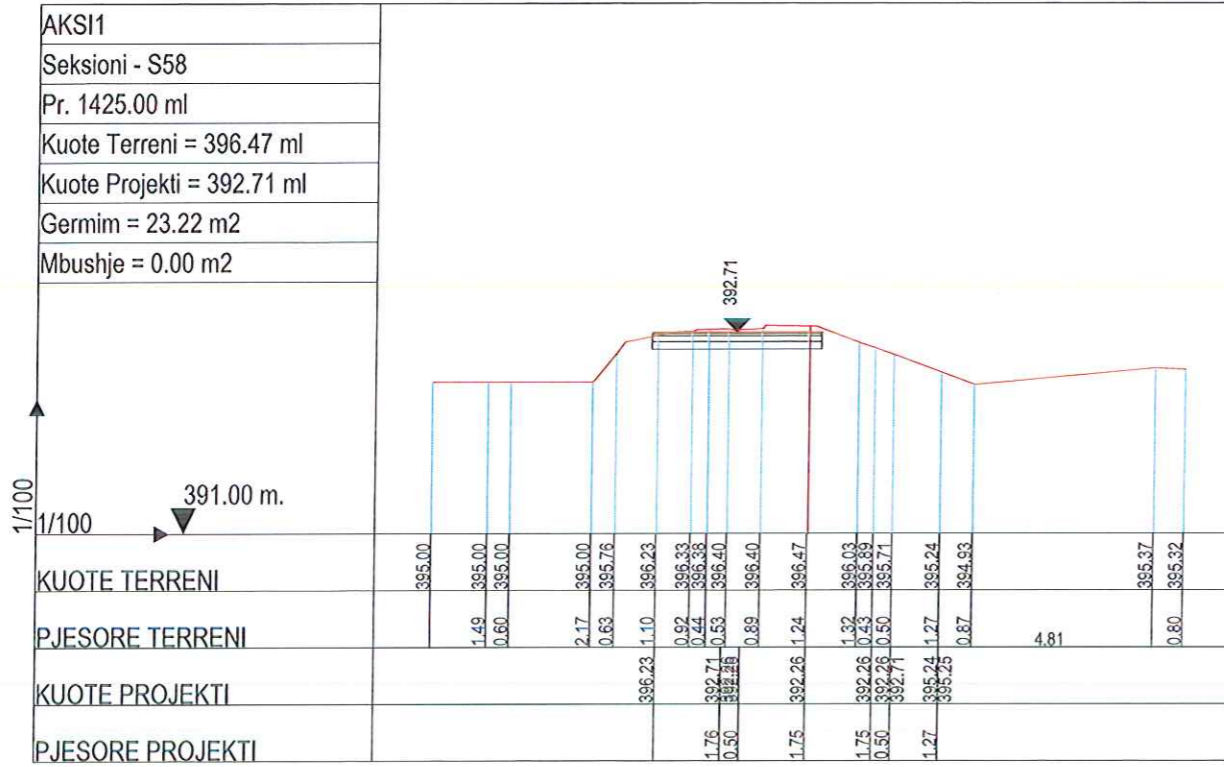

**POROSITESI : BASHKIA TROPOJË**  
 OBJEKTI:  
 "PROJEKT I RRUGES SE FSHATIT KASAJ, BASHKIA TROPOJË "

Emertimi: PROFILET TERTHORE  
 "ASI2STUDIO" Sh.p.k  
 Adresa:  
 Kompleksi Vizon Plus, Tirane.

ASIZ-STUDIO  
 Ing. Mentor ÇOKAJ  
 Nr. 16, M/51  
 Tiranë, Shqipëri  
 Tel: 069 21 22 22

Projektues  
 SHKALLA  
 1 : 200  
 FLETA  
 7 - 16  
 Tropojë 2022, Format A3

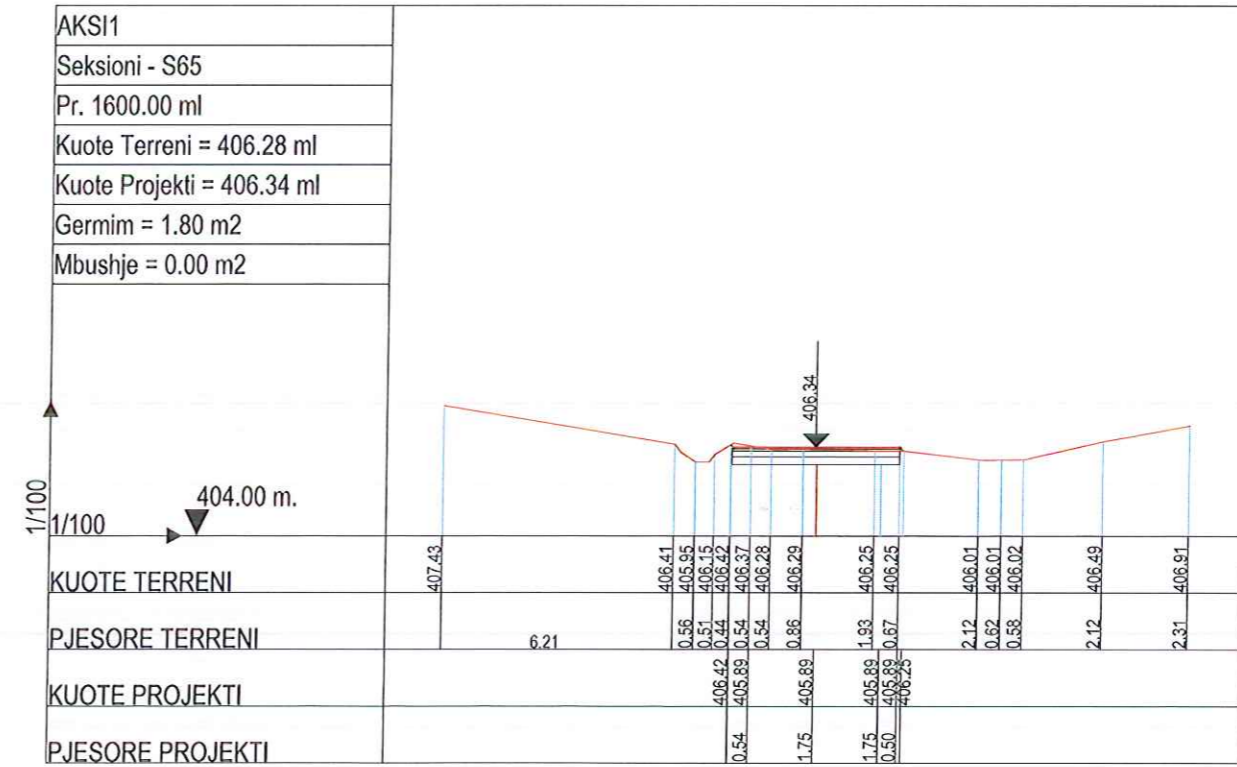
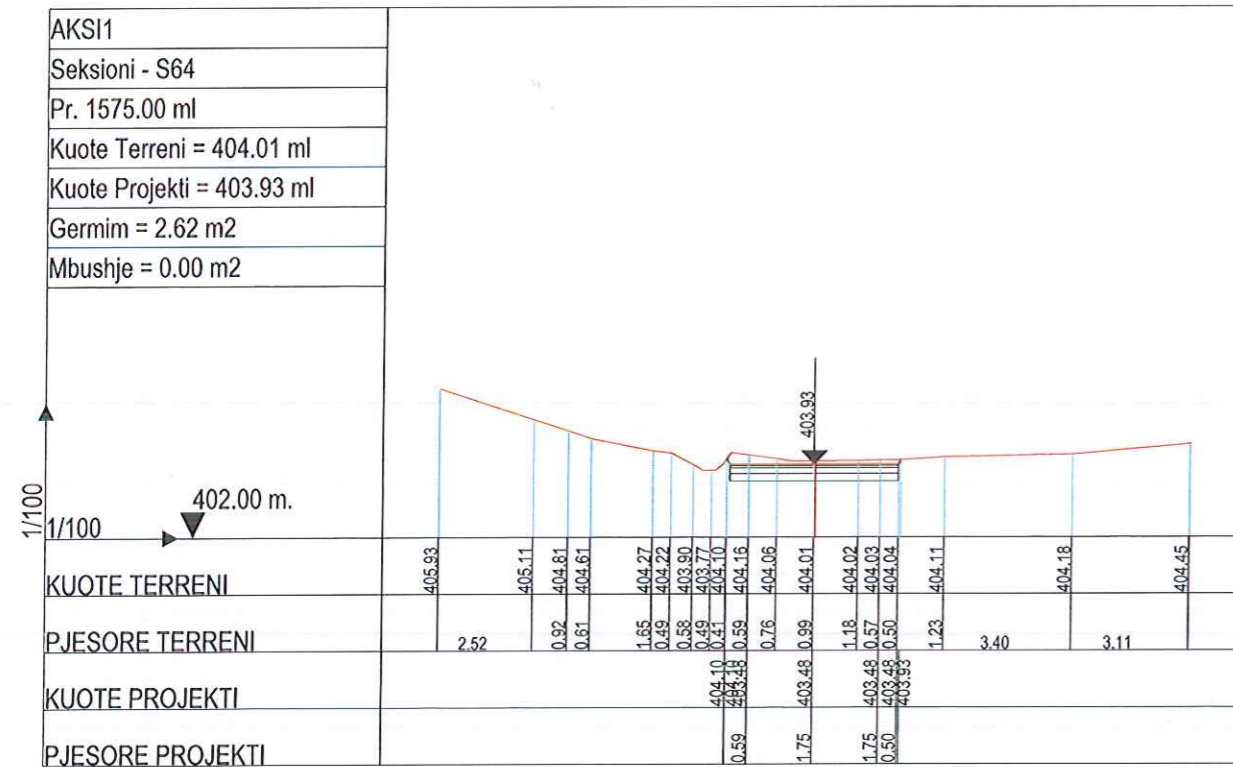
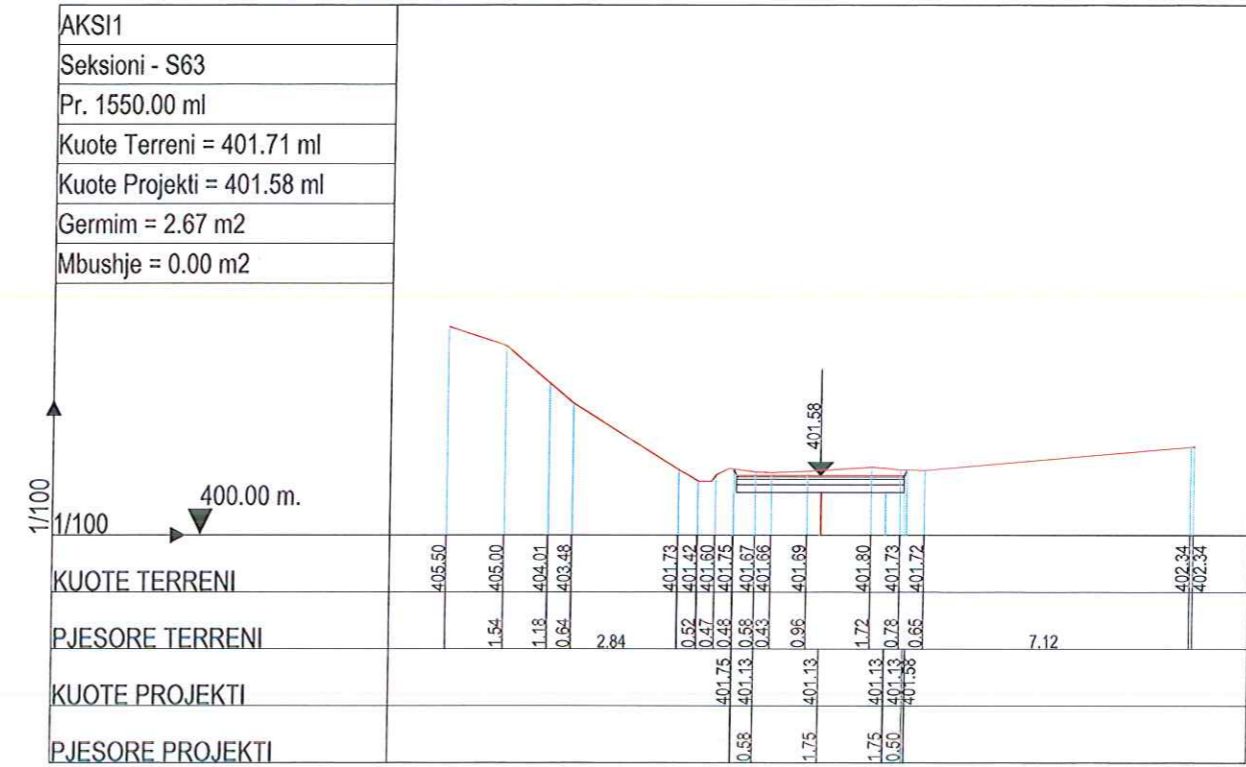
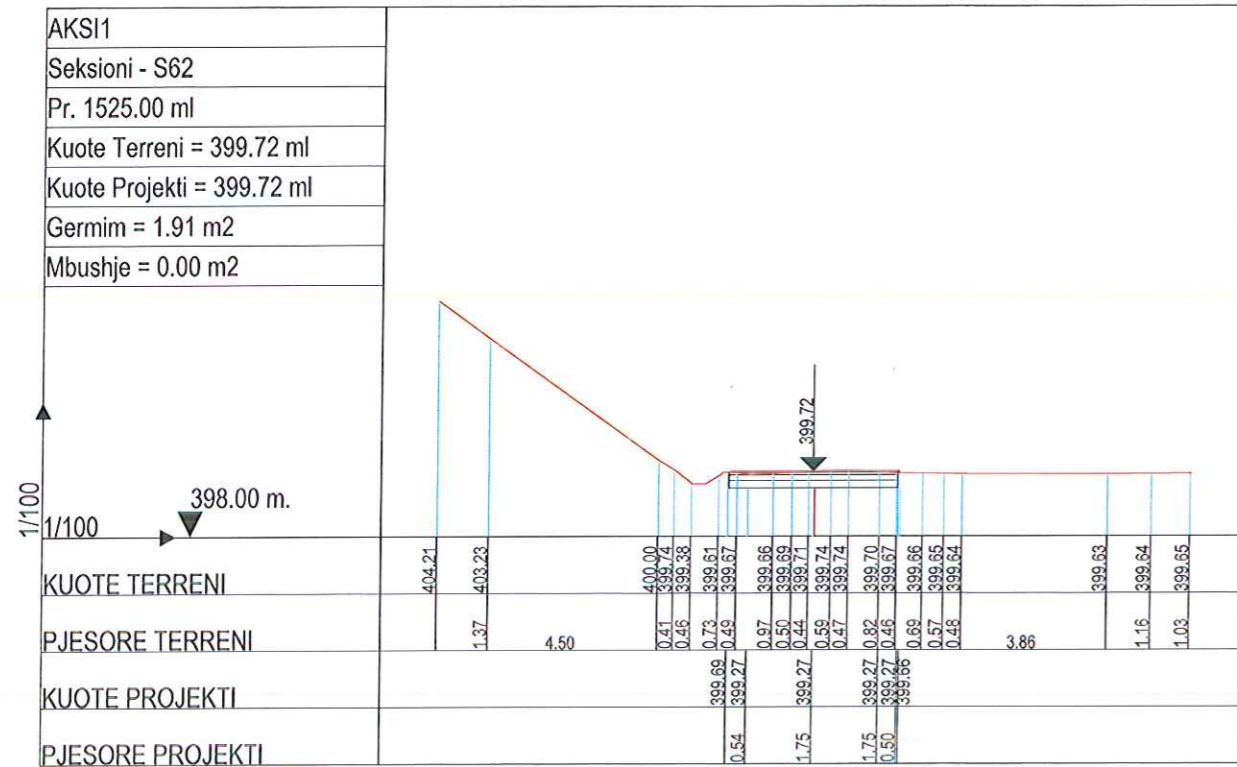

# POROSITESI : BASHKIA TROPOJË

OBJEKTI:  
"PROJEKT I RRUGES SE FSHATIT KASAJ, BASHKIA TROPOJË "

Emertimi: PROFILET TERTHORE



"ASI2STUDIO" Sh.p.k

Adresa:  
Kompleksi Vizon Plus, Tirane.



Ing. Mentor COKAJ

Projektues

SHKALLA FLETA

1 : 200 7 - 17

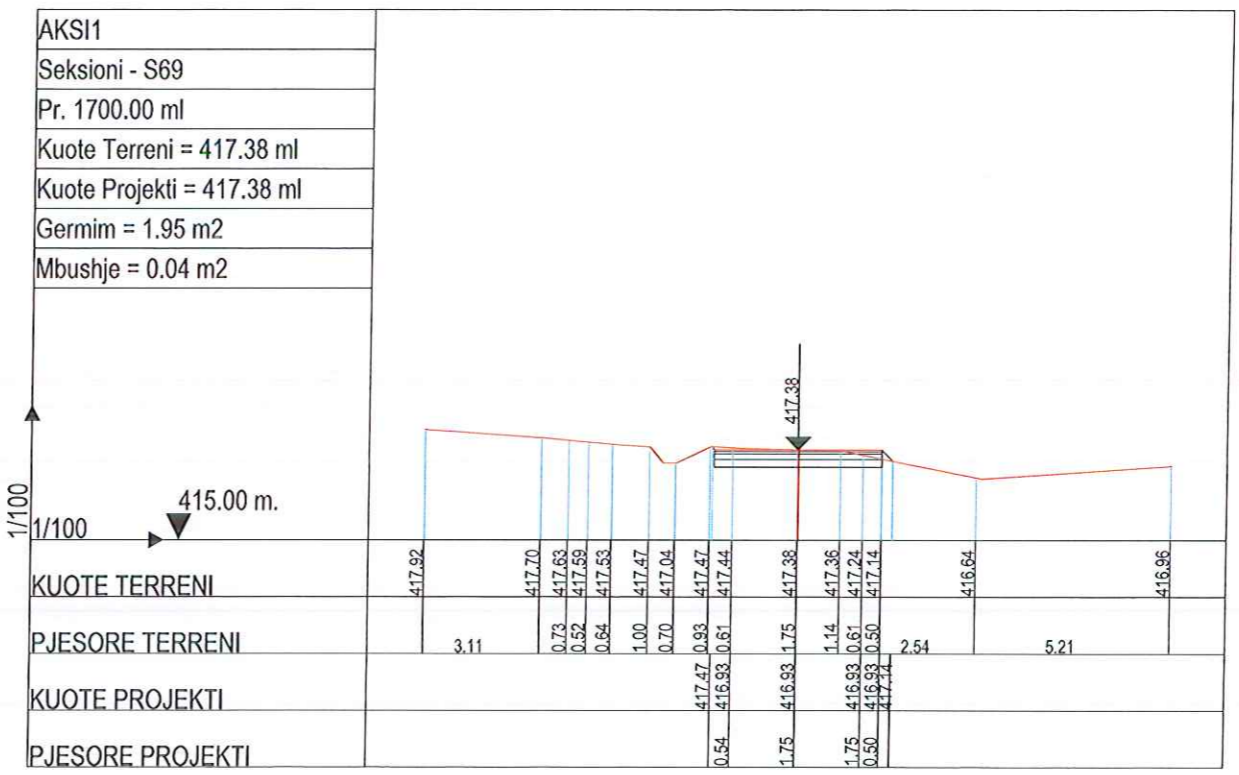
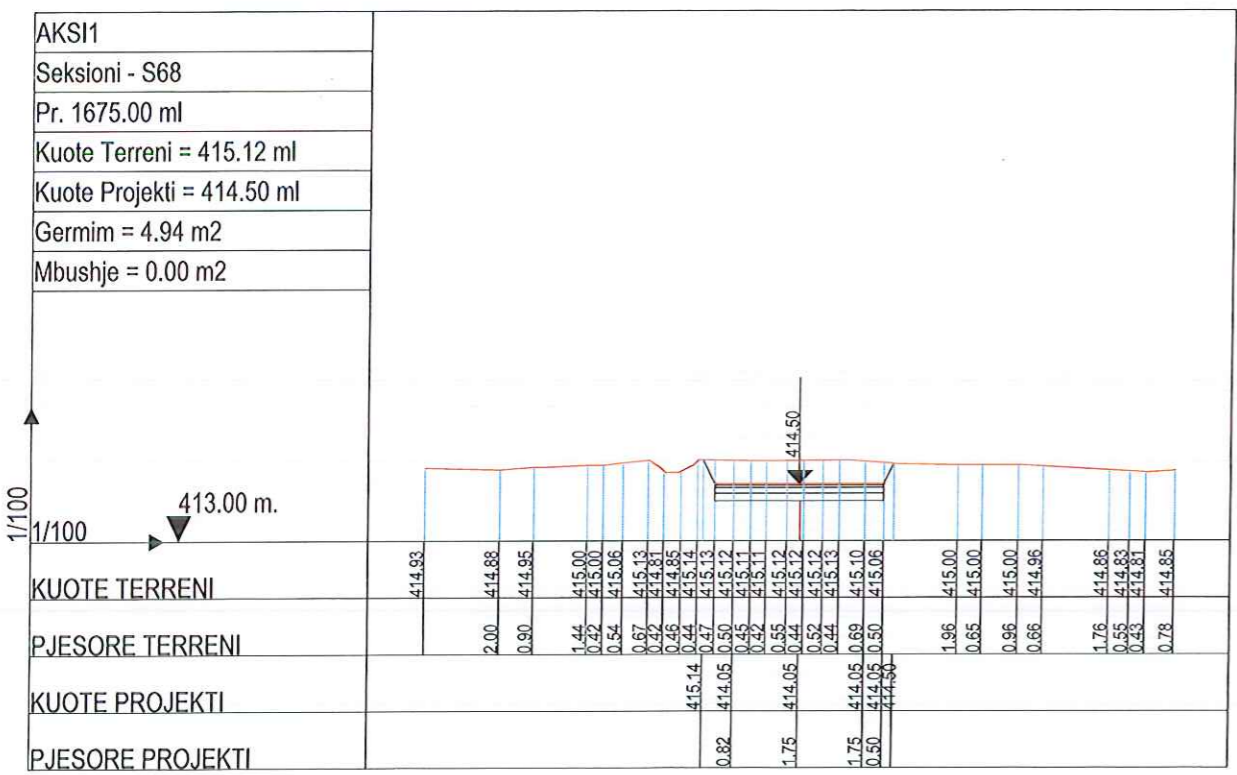
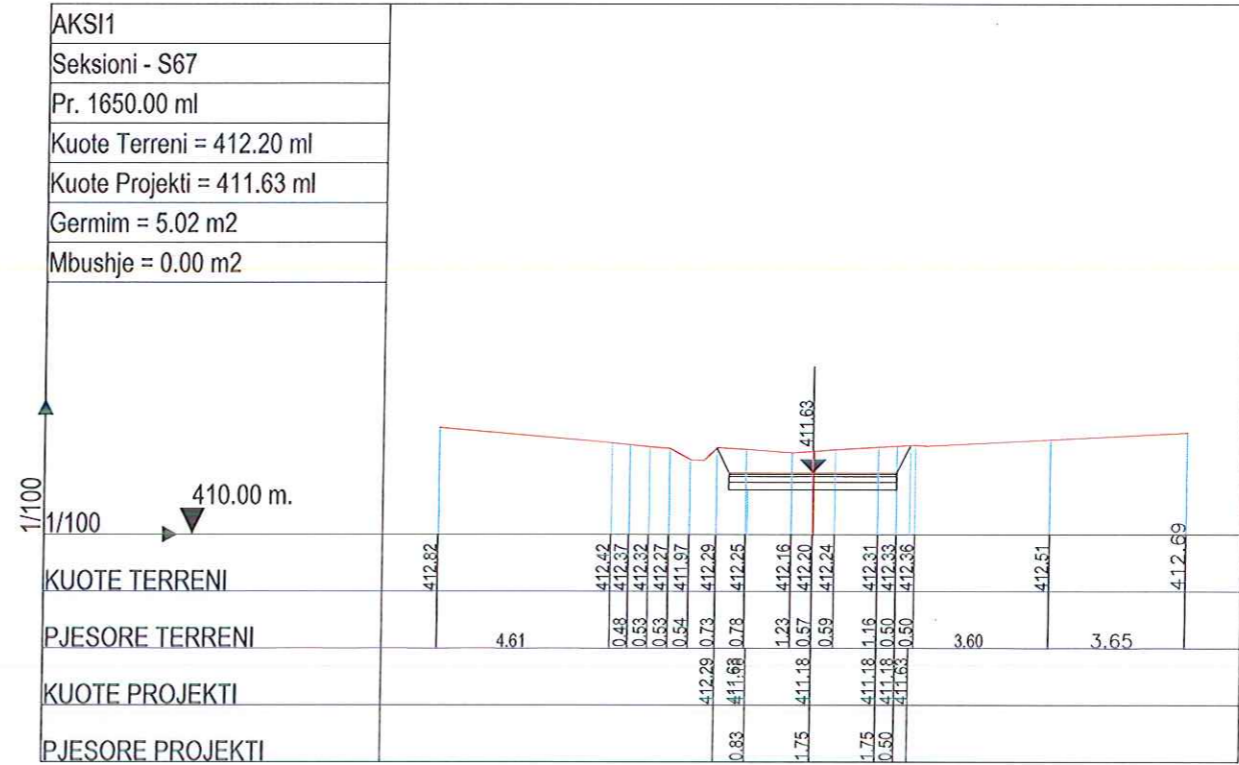
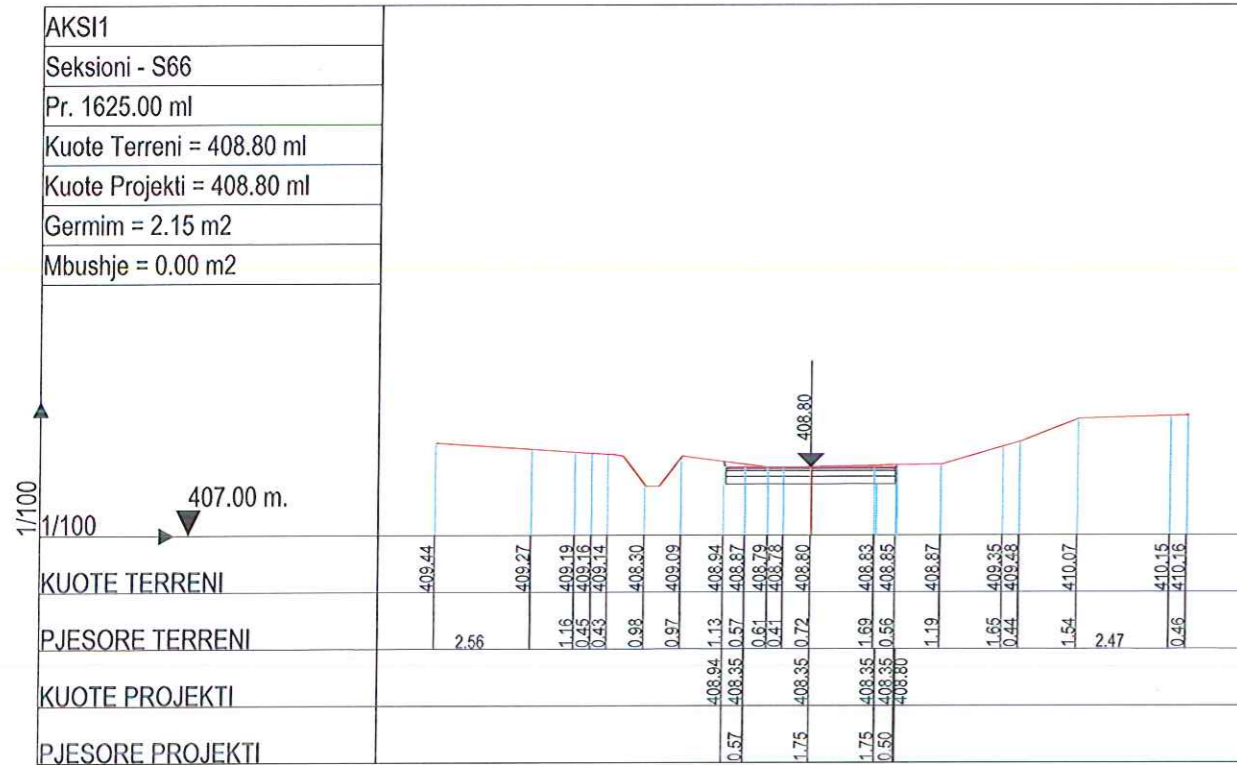

**POROSITESI : BASHKIA TROPOJË**  
 OBJEKTI:  
 "PROJEKT I RRUGES SE FSHATIT KASAJ, BASHKIA TROPOJË "

Emertimi: PROFILET TERTHORE  
 "ASI2STUDIO" Sh.p.k  
 Adresa:  
 Kompleksi Vizon Plus, Tirane.



Projektues

SHKALLA	FLETA
1 : 200	7 - 18
Tirane 2022	Format A2

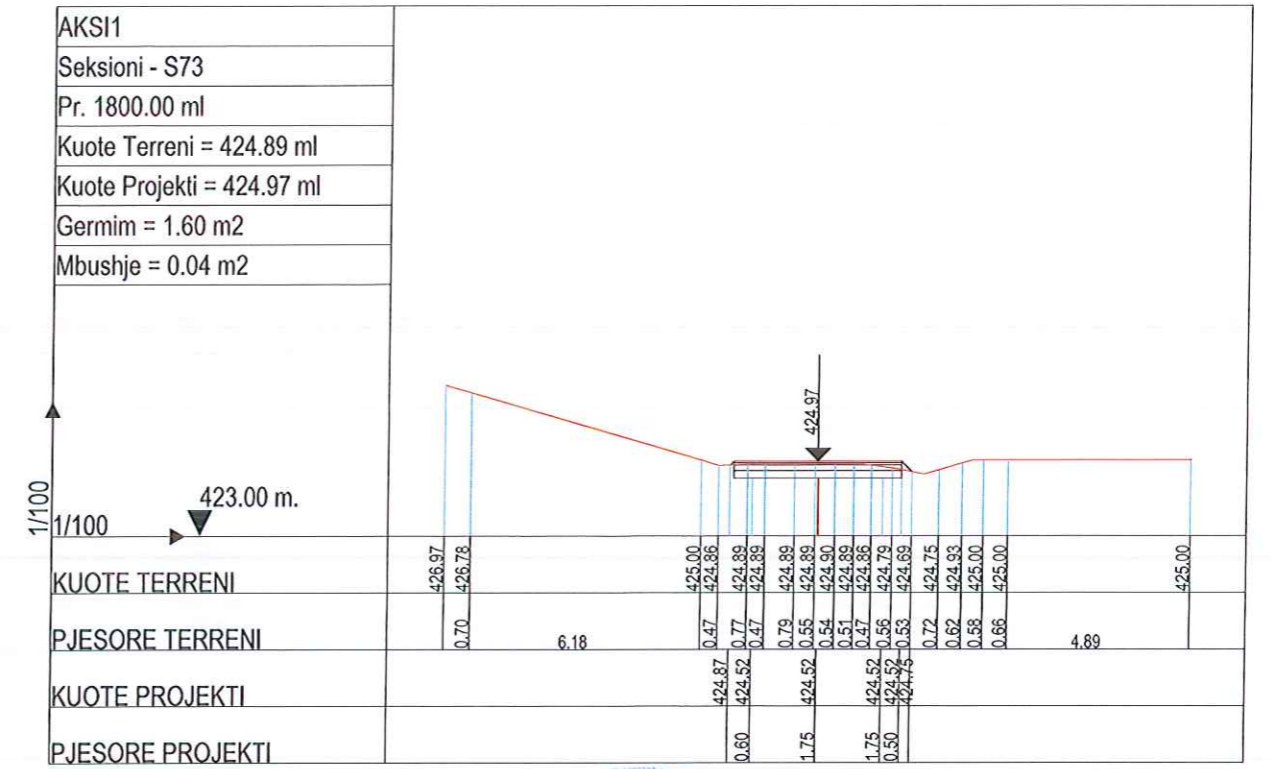
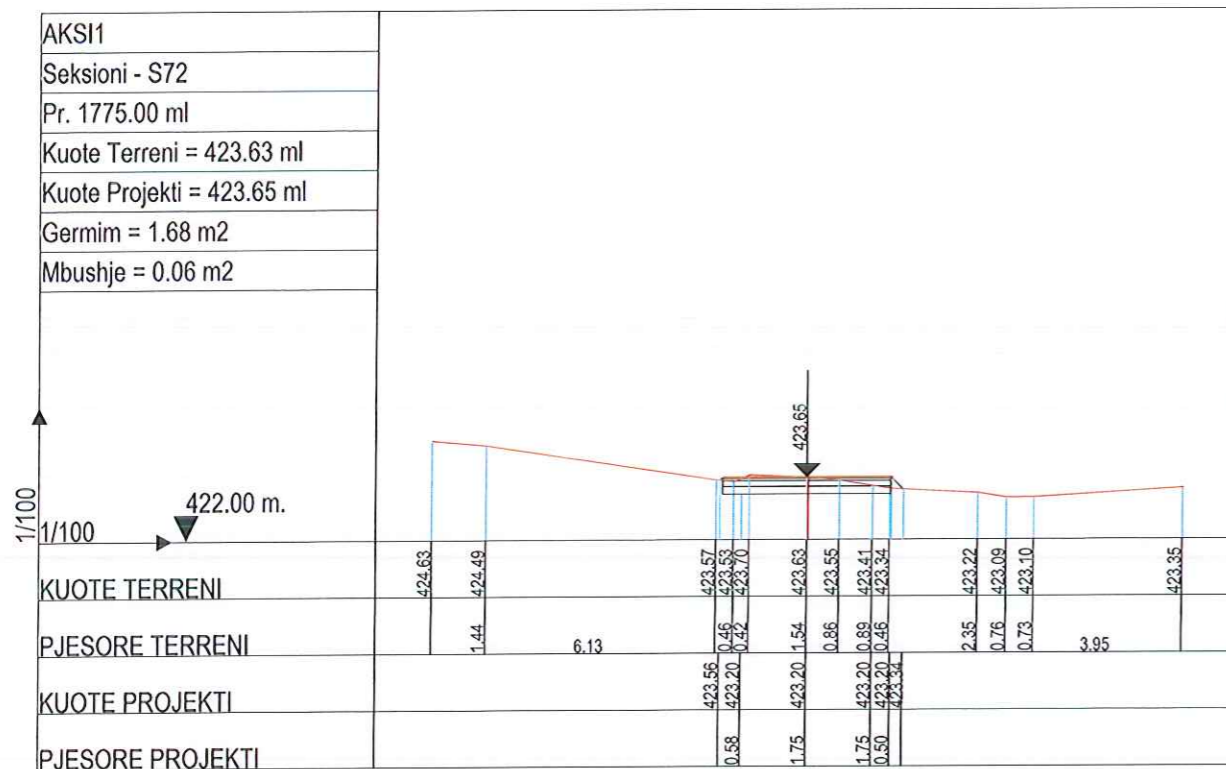
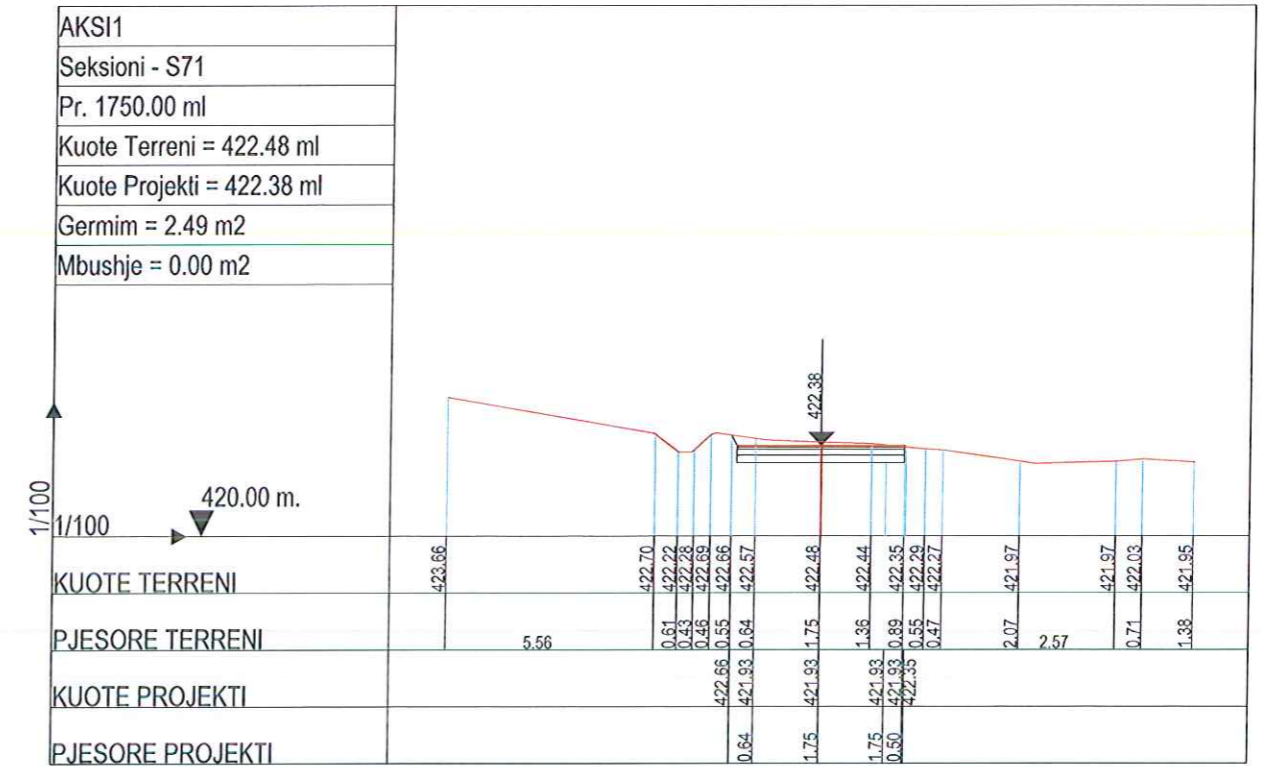
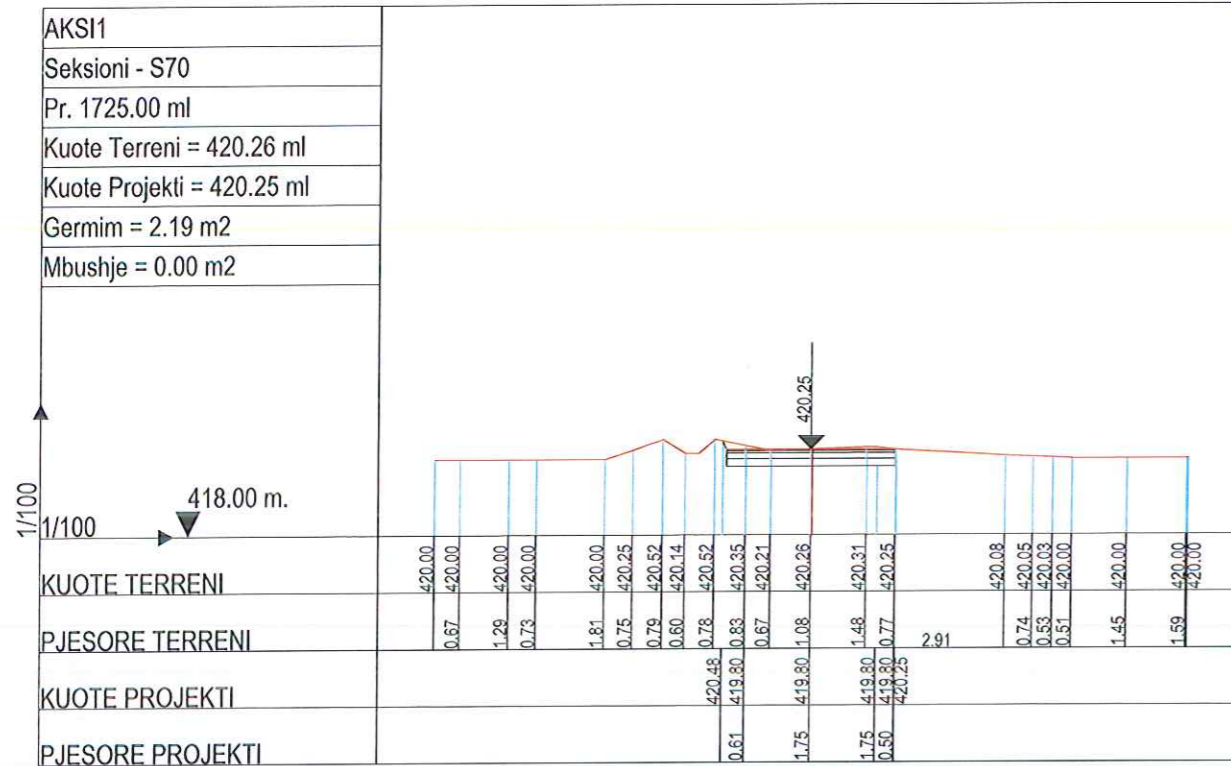

# POROSITESI : BASHKIA TROPOJË

OBJEKTI:  
"PROJEKT I RRUGES SE FSHATIT KASAJ, BASHKIA TROPOJË "

Emertimi: PROFILET TERTHORE



"ASI2STUDIO" Sh.p.k

Adresa:  
Kompleksi Vizion Plus, Tirane.



Ing. Mentor ÇOKAJ

Projektues

SHKALLA FLETA

1 : 200 7 - 19

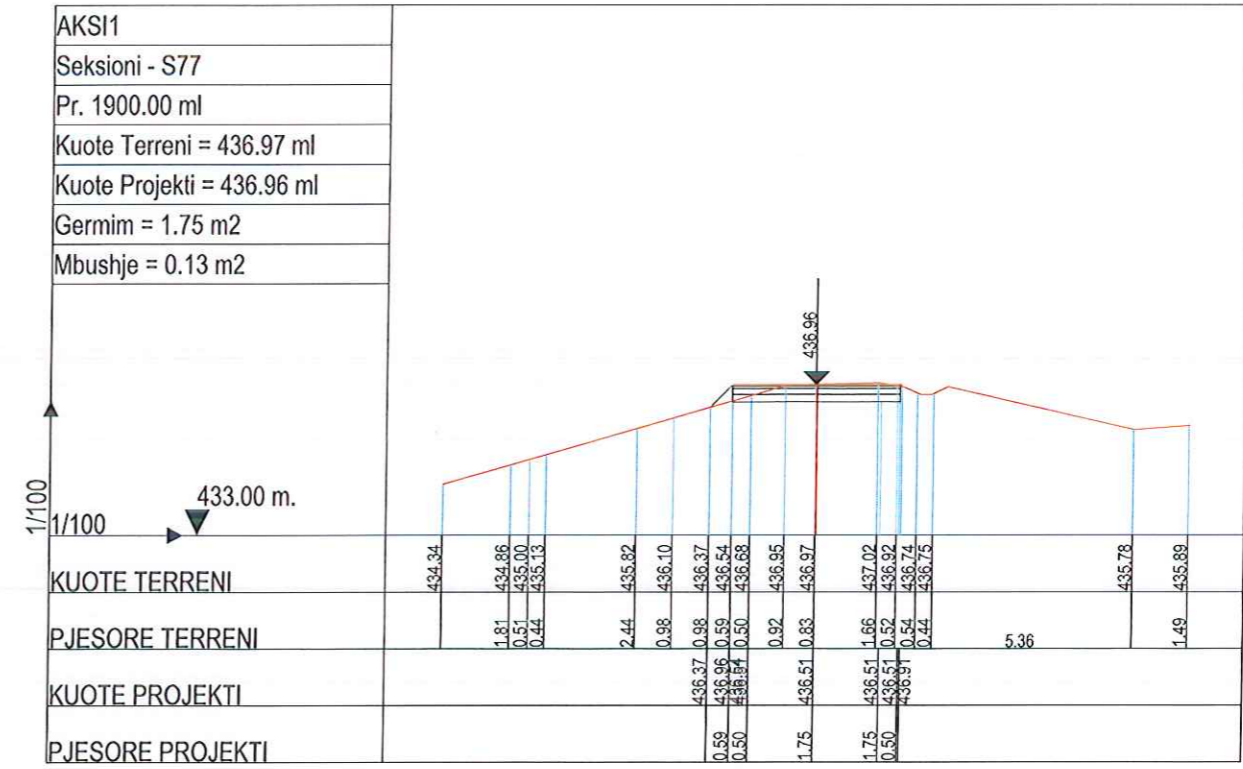
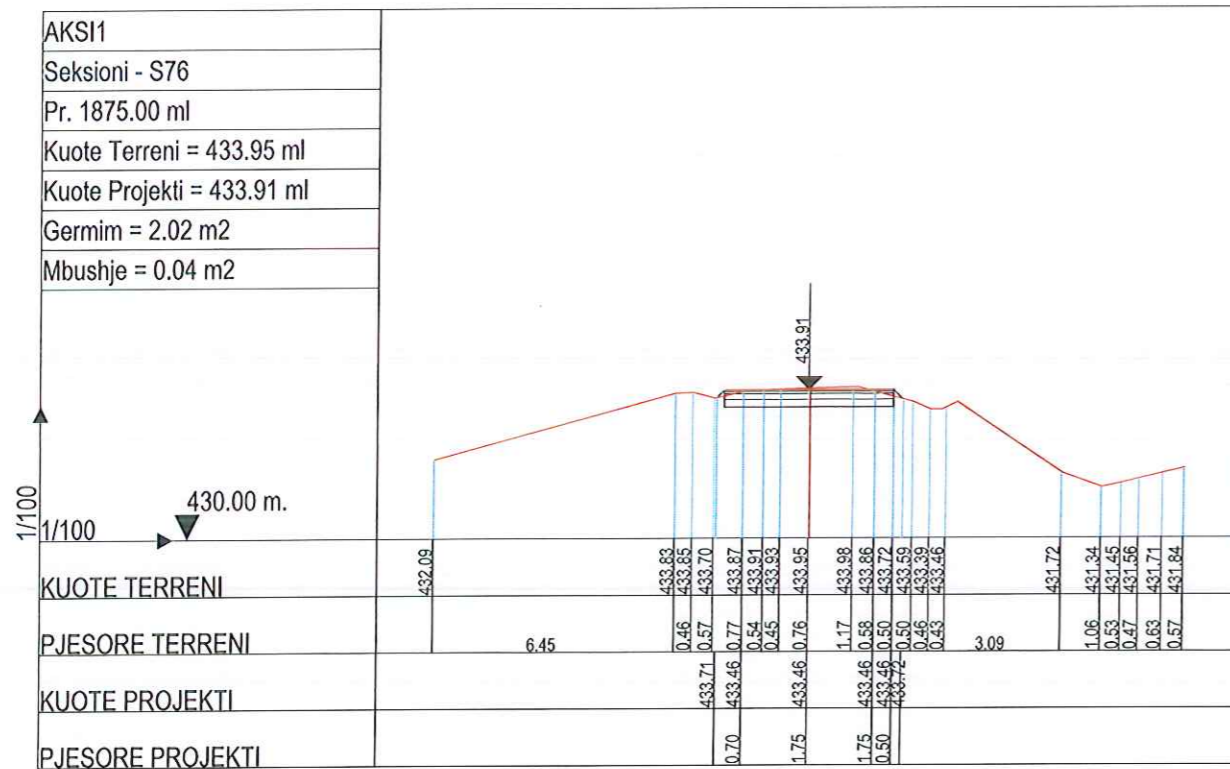
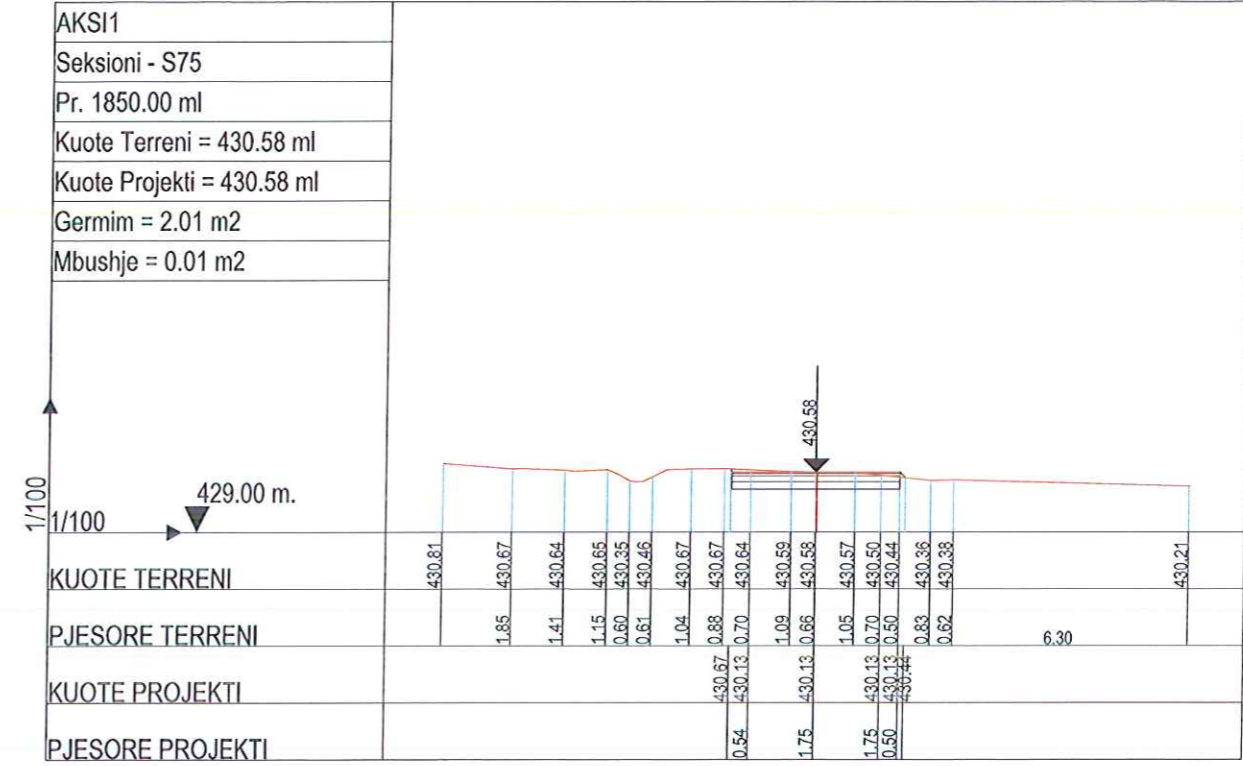
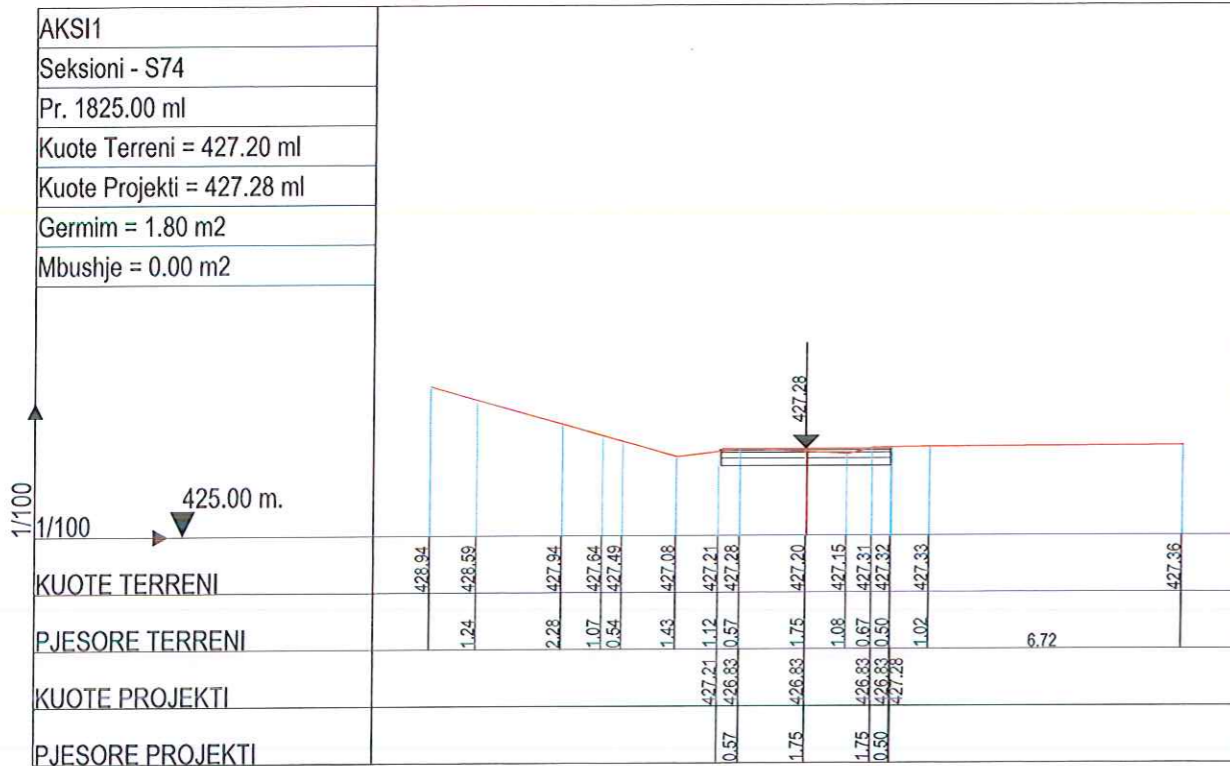

# POROSITESI : BASHKIA TROPOJË

OBJEKTI:  
"PROJEKT I RRUGES SE FSHATIT KASAJ, BASHKIA TROPOJË "

Emertimi: PROFILET TERTHORE



"ASI2STUDIO" Sh.p.k

Adresa:  
Kompleksi Vizion Plus, Tirane.



Projektues

SHKALLA FLETA

1 : 200 7 - 20

Tropojë 2022 Formet A2

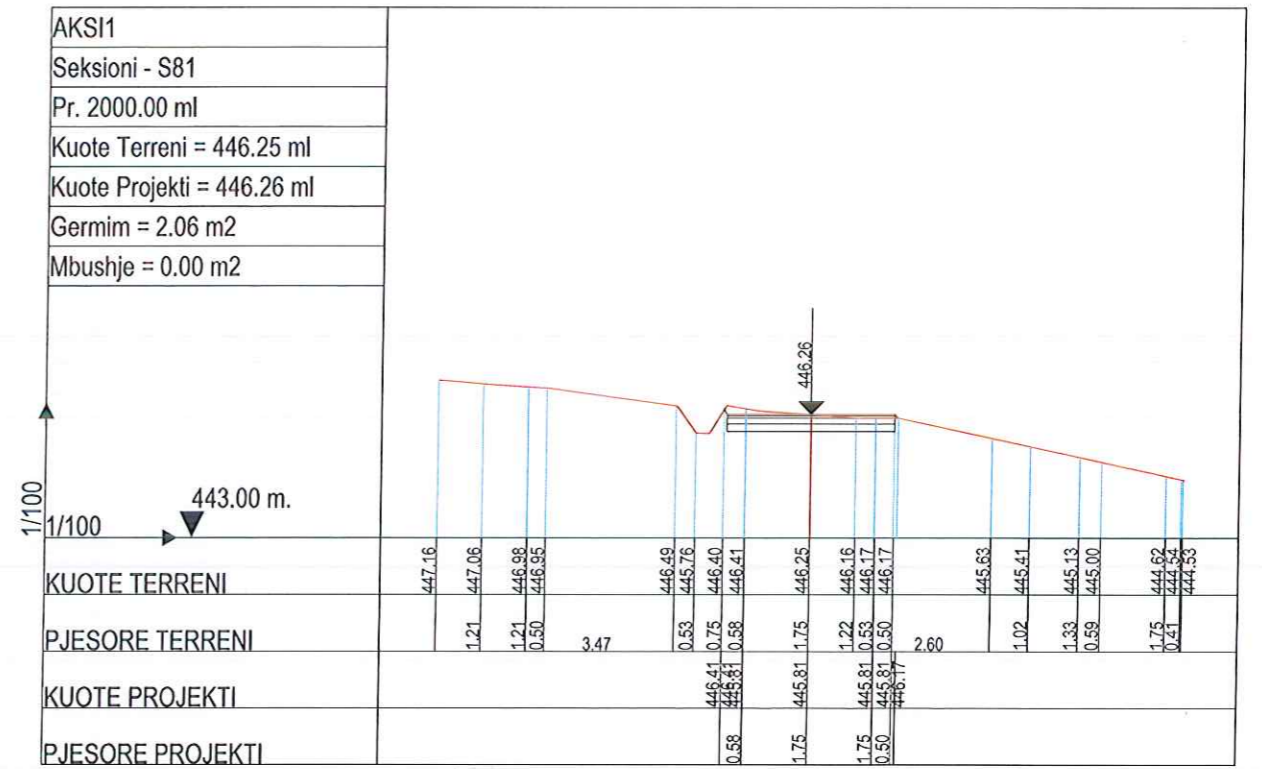
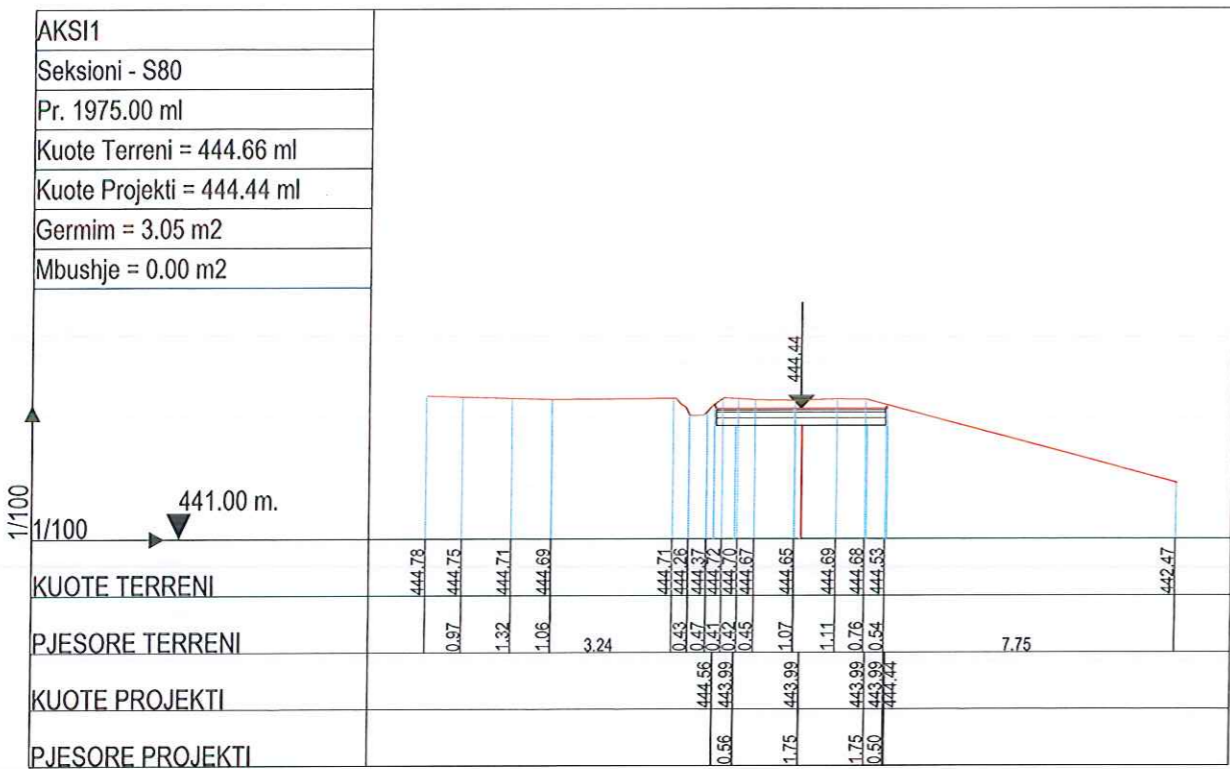
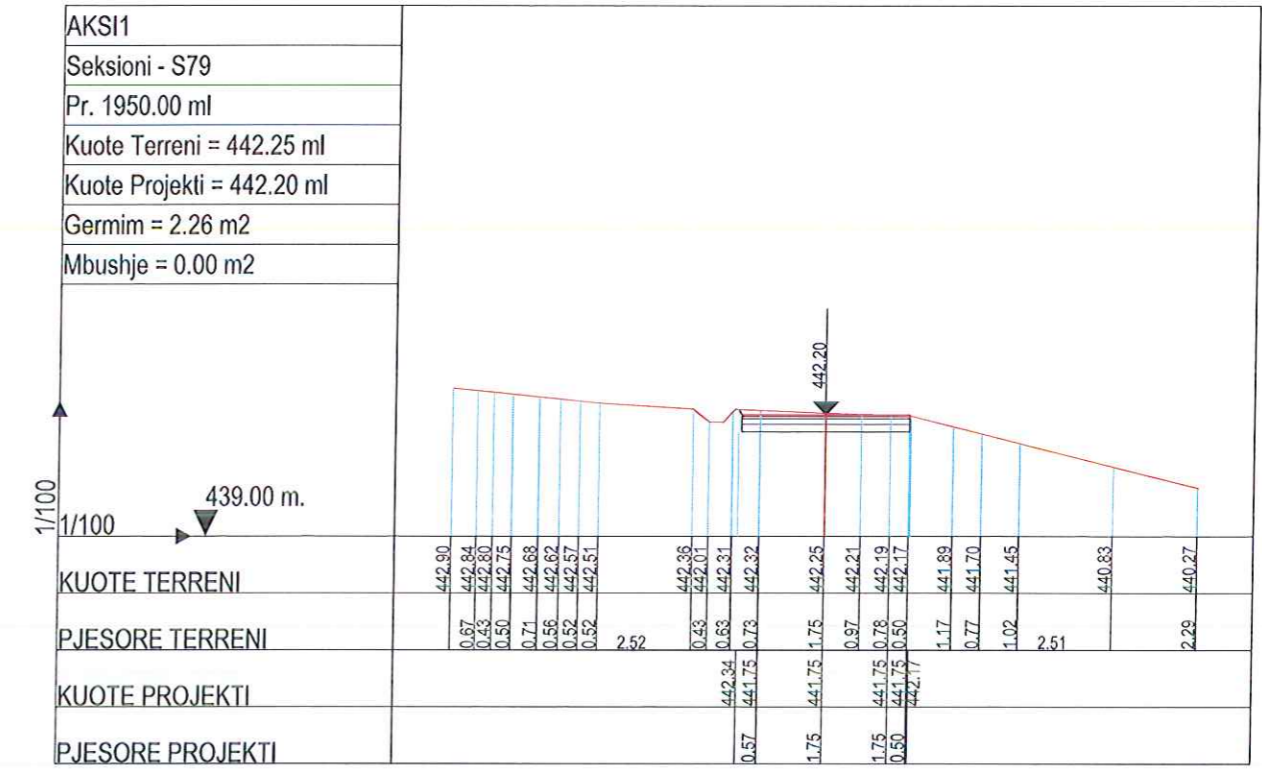
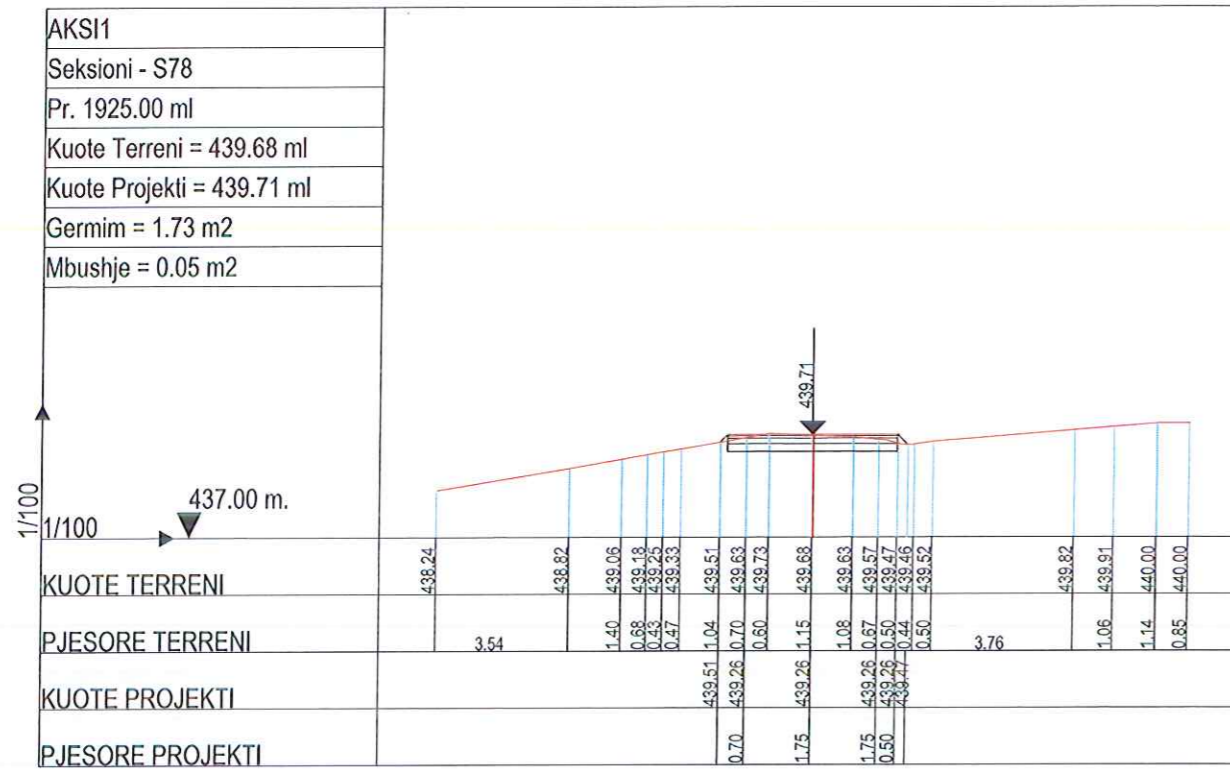

**POROSITESI : BASHKIA TROPOJË**

OBJEKTI:  
"PROJEKT I RRUGES SE FSHATIT KASAJ, BASHKIA TROPOJË"

Emertimi: PROFILET TERTHORE

"ASI2STUDIO" Sh.p.k  
Adresa:  
Kompleksi Vizon Plus, Tirane.



Projektues

SHKALLA FLETA

1 : 200 7 - 21  
Tropojë 2022 Format A3

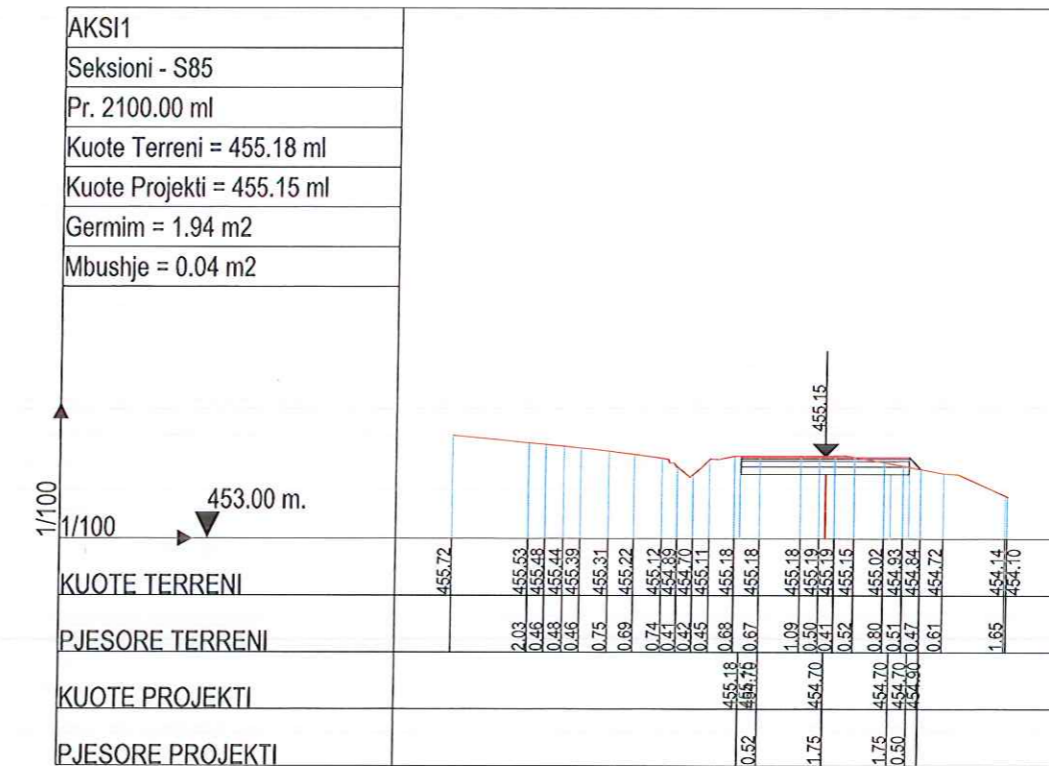
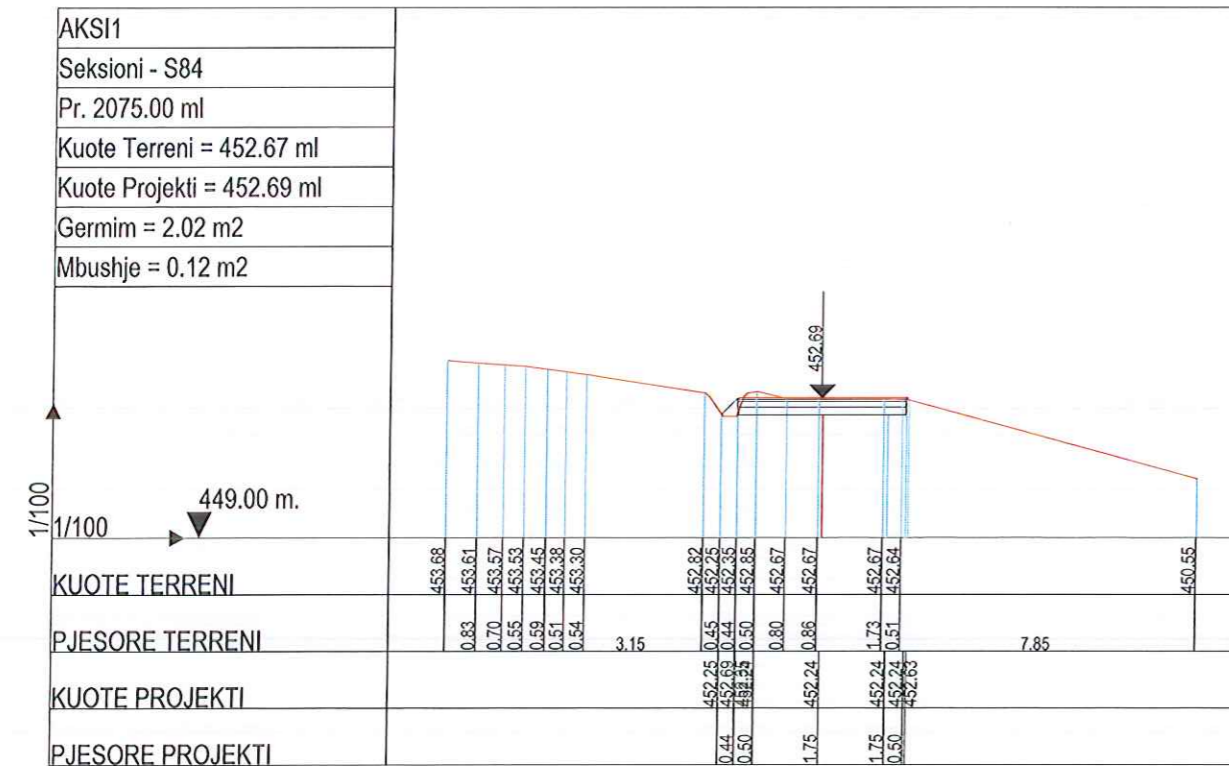
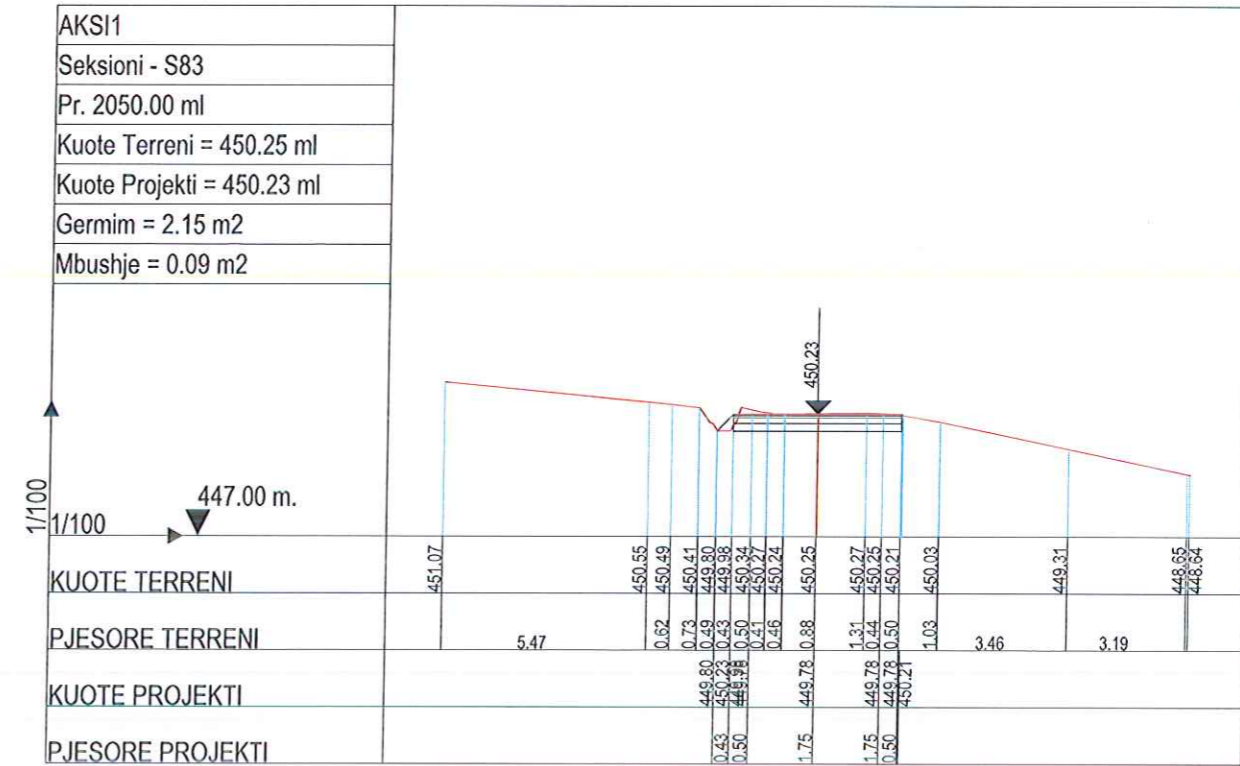
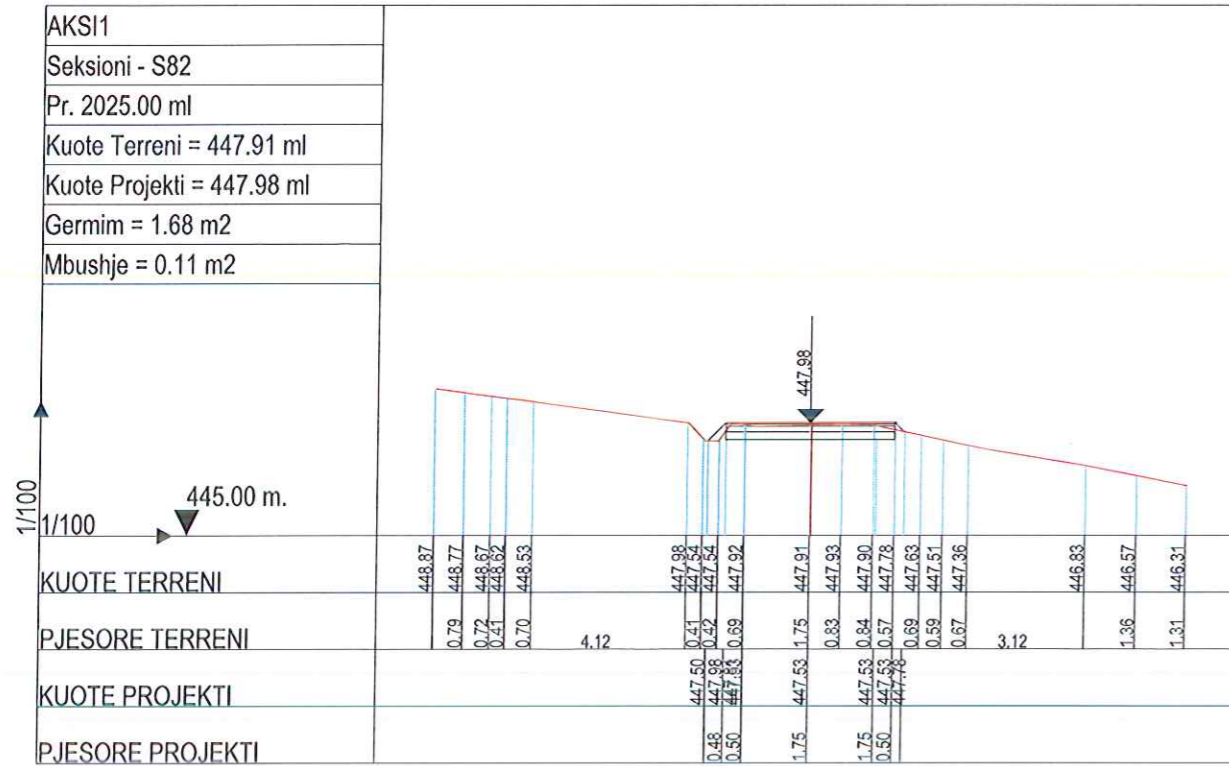

**POROSITESI : BASHKIA TROPOJË**  
 OBJEKTI:  
 "PROJEKT I RRUGES SE FSHATIT KASAJ, BASHKIA TROPOJË "

Emertimi: PROFILET TERTHORE  
 "ASI2STUDIO" Sh.p.k  
 Adresa:  
 Kompleksi Vizon Plus, Tirane.

ASIZ-STUDIO  
 Ing. MENTOR ÇOKAJ  
 Nr. i lic. 2014/1  
 Projektim - Zbatim  
 www.asizstudio.com  
 069 21 73 215

Projektues

SHKALLA	FLETA
1 : 200	7 - 22
Tropojë 2022	Format A3



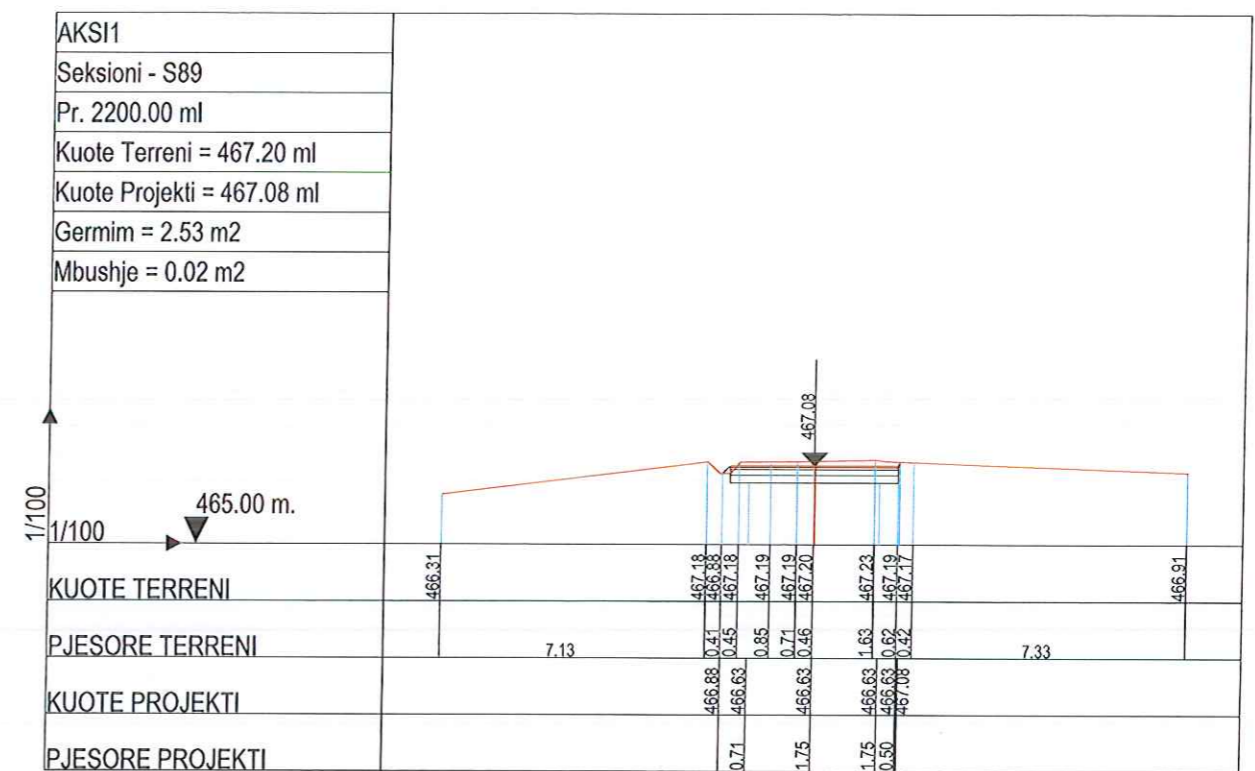
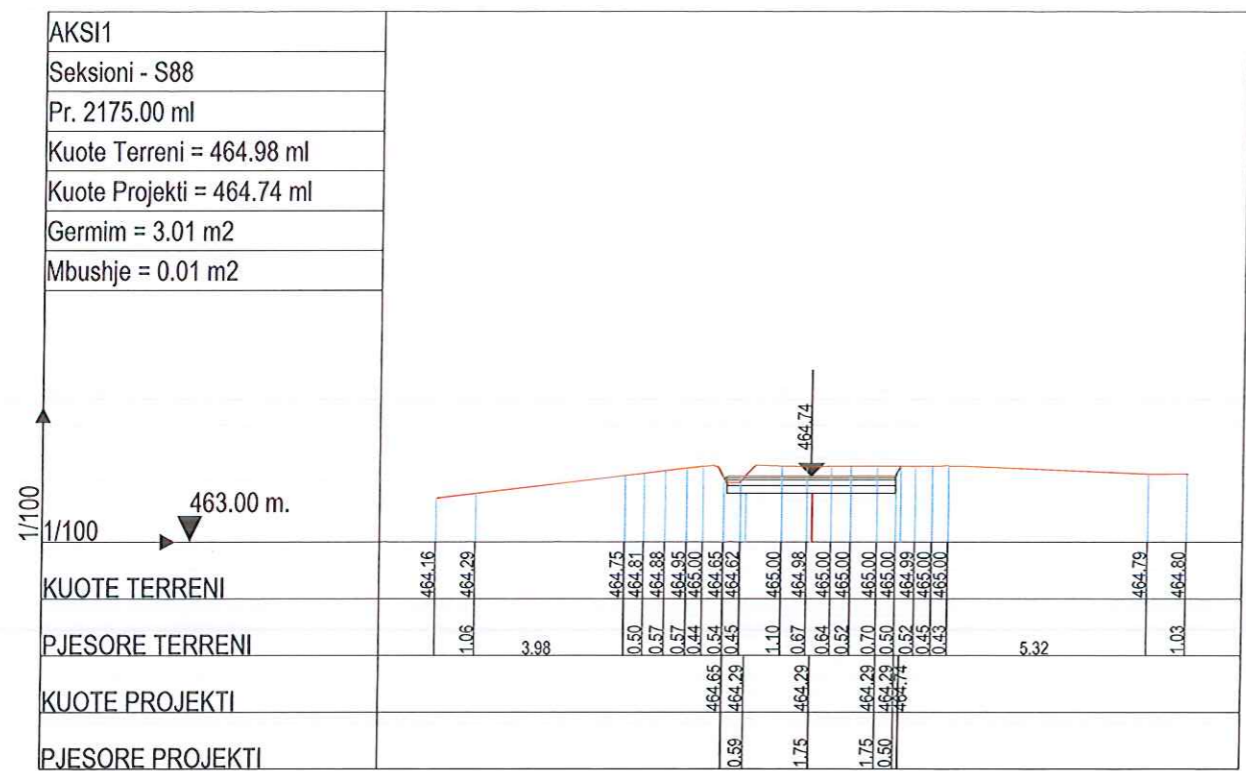
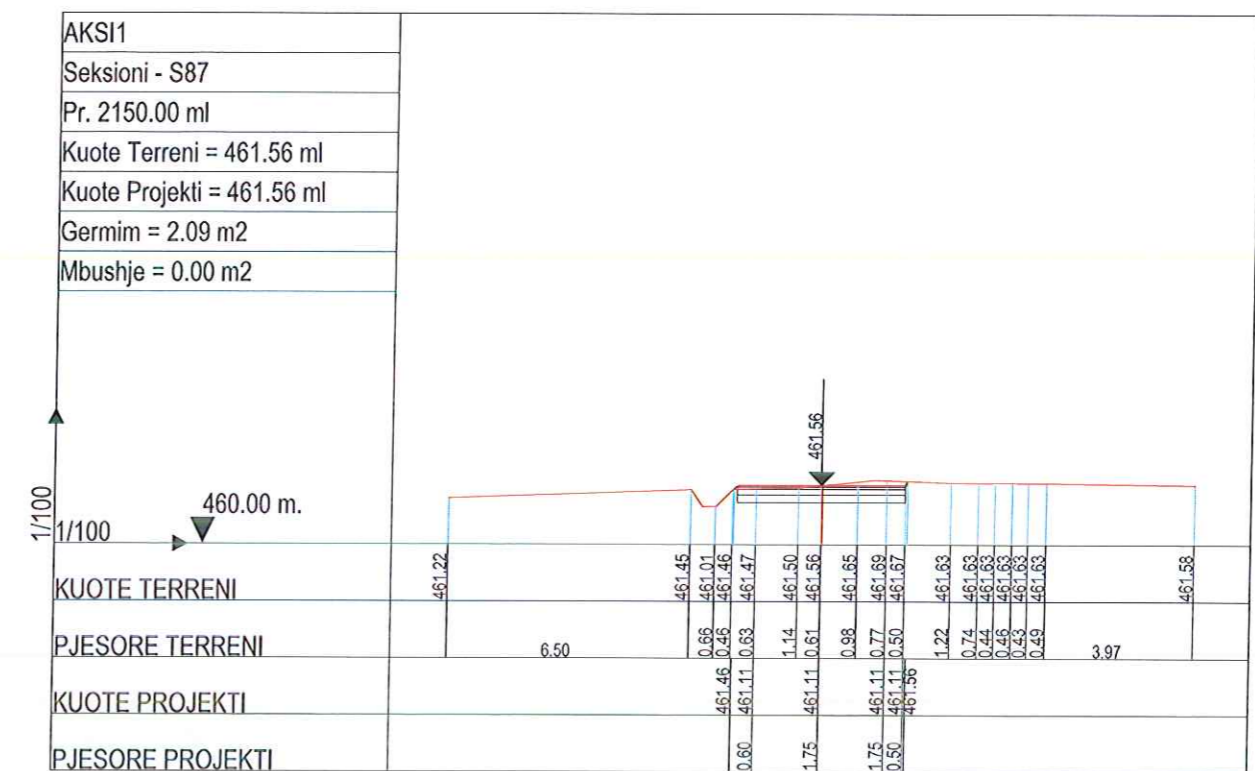
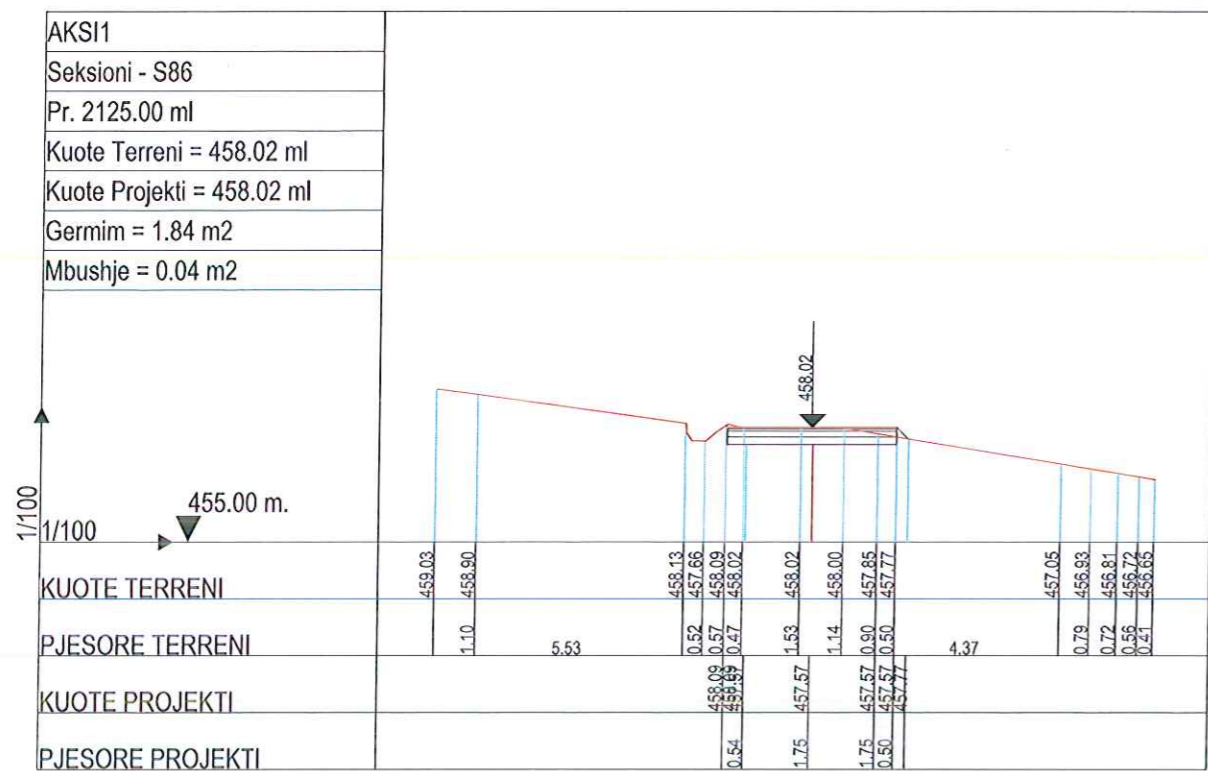

**POROSITESI : BASHKIA TROPOJË**  
 OBJEKTI:  
 "PROJEKT I RRUGES SE FSHATIT KASAJ, BASHKIA TROPOJË "

Emertimi: PROFILET TERTHORE  
 "ASI2STUDIO" Sh.p.k  
 Adresa:  
 Kompleksi Vizon Plus, Tirane.

ASI2-STUDIO  
 Ing. MENTOR ÇOKAJ  
 Nr. Lic. X/1451  
 Projektim - Zbatim  
 mentor.cokaj@yahoo.com  
 Ing. Mentor ÇOKAJ

Projektues  
 SHKALLA 1 : 200  
 FLETA 7 - 23  
 Tropojë 2022 Formet A2



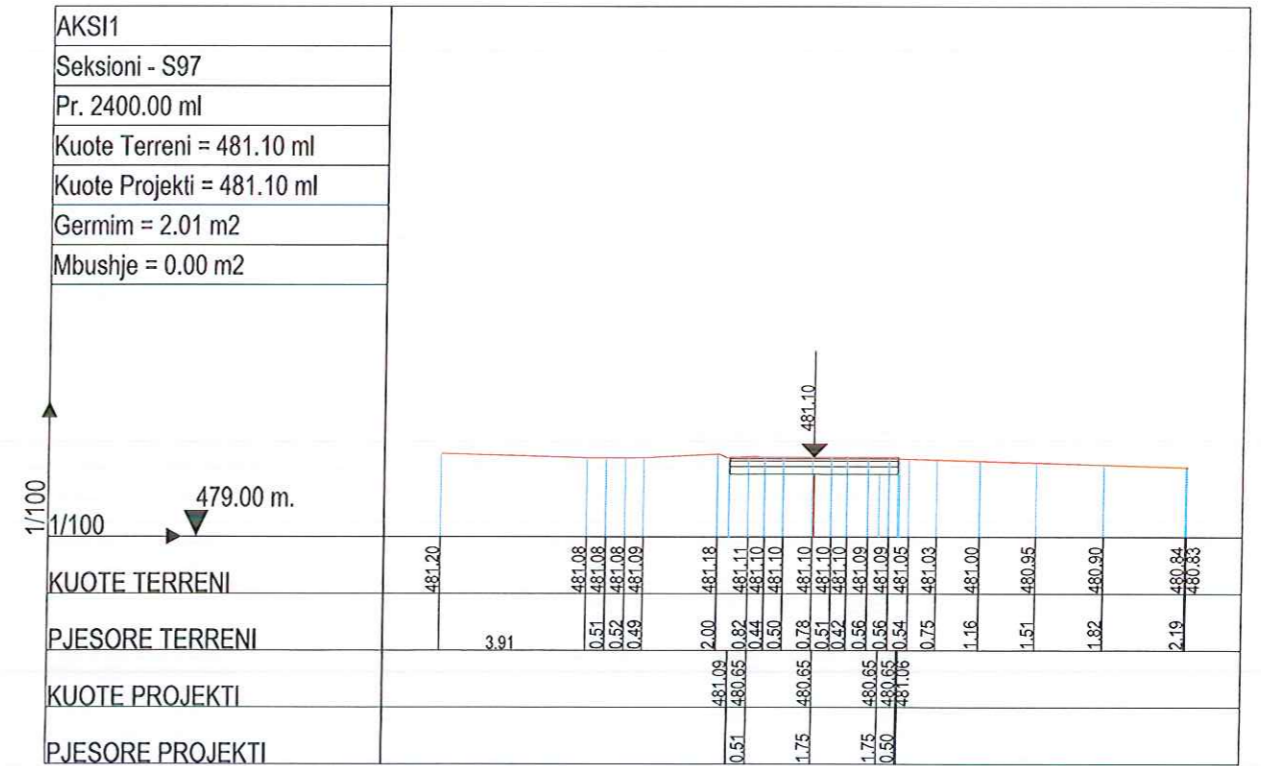
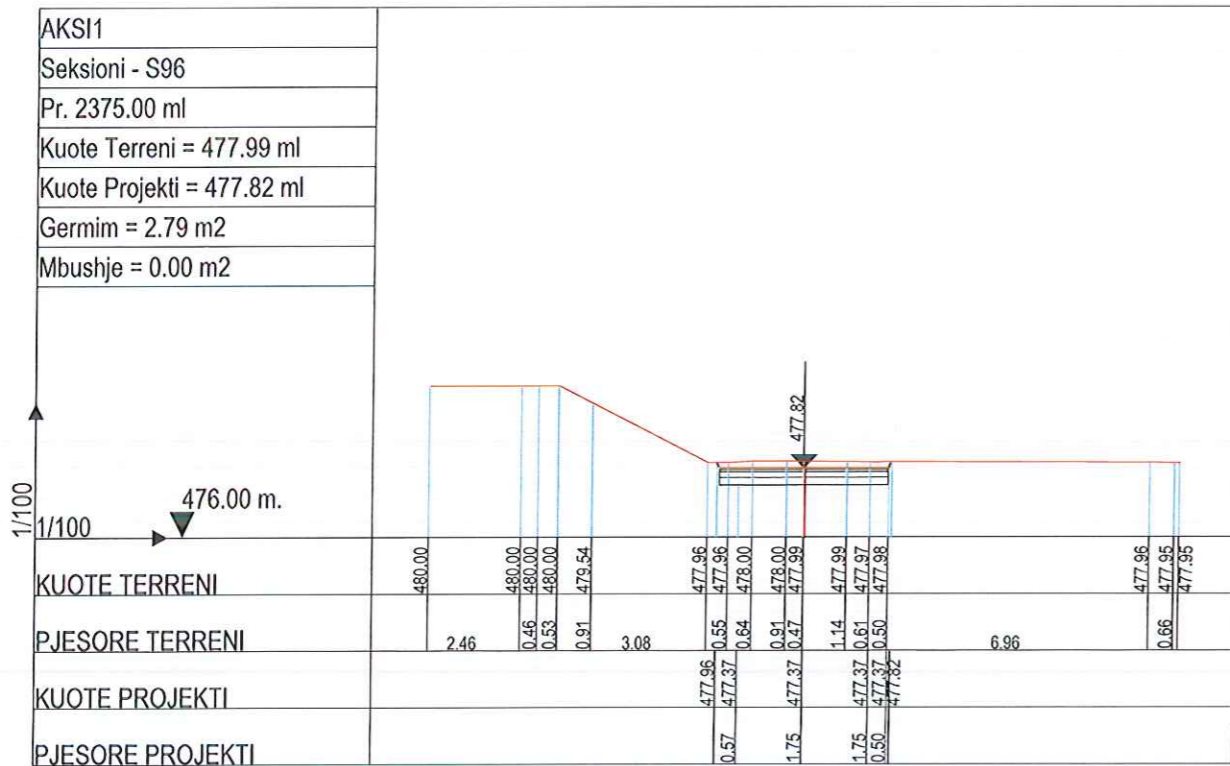
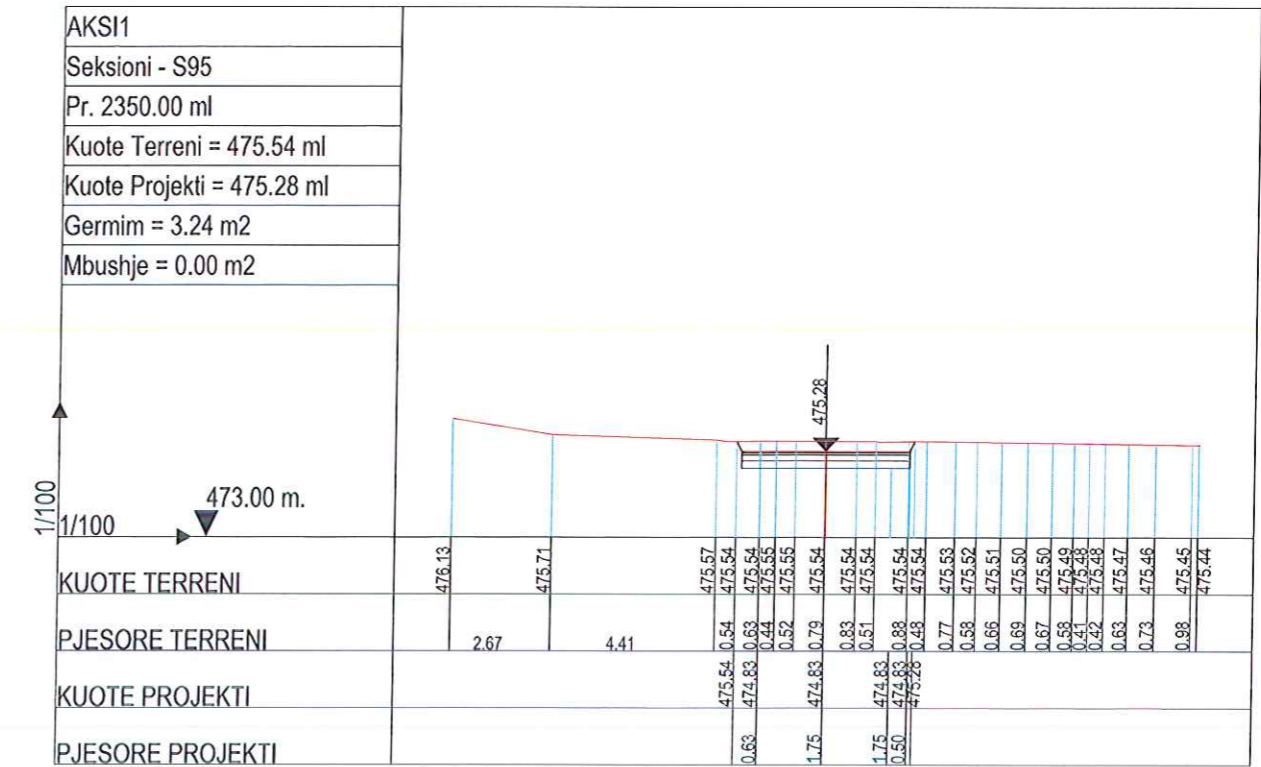
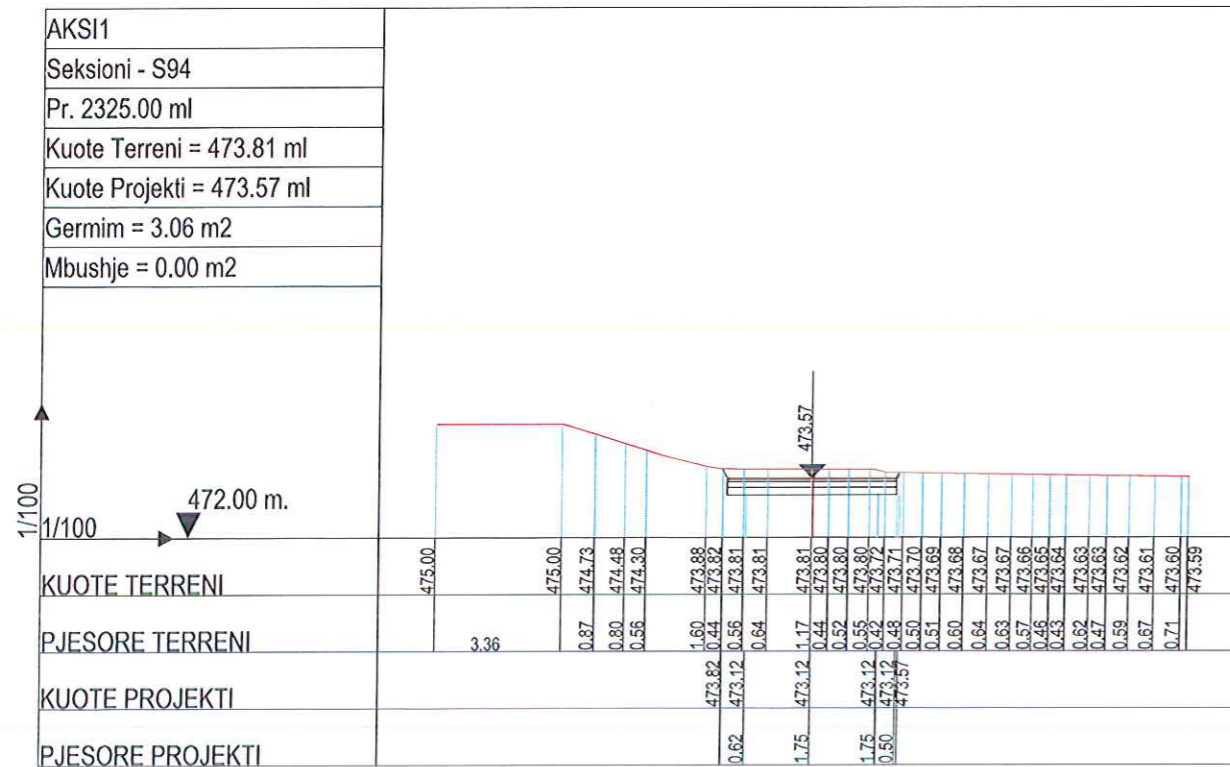

# POROSITESI : BASHKIA TROPOJË

OBJEKTI:  
"PROJEKT I RRUGES SE FSHATIT KASAJ, BASHKIA TROPOJË "

Emertimi: PROFILET TERTHORE

"ASI2STUDIO" Sh.p.k

Adresa:  
Kompleksi Vizon Plus, Tirane.



Projektues  
Ing. Mentor ÇOKAJ

SHKALLA FLETA

1 : 200 7 - 25

Tropojë 2022 Formet A2

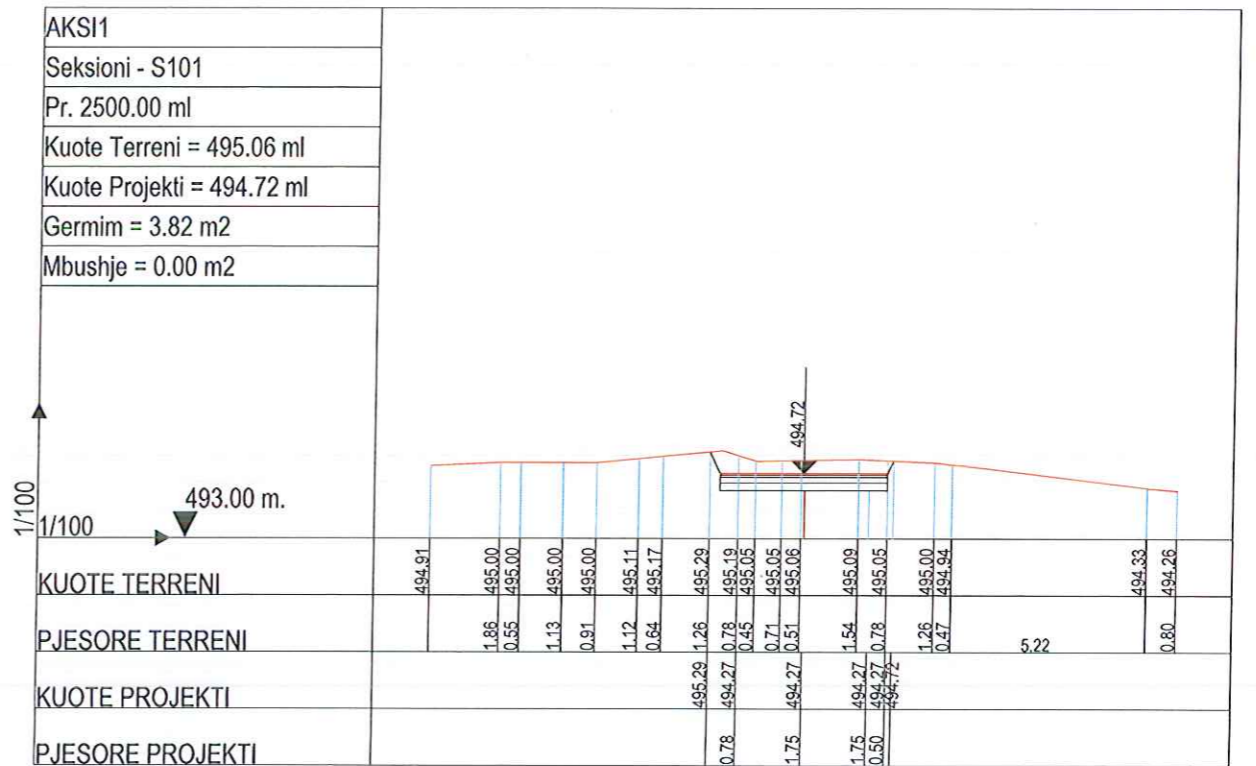
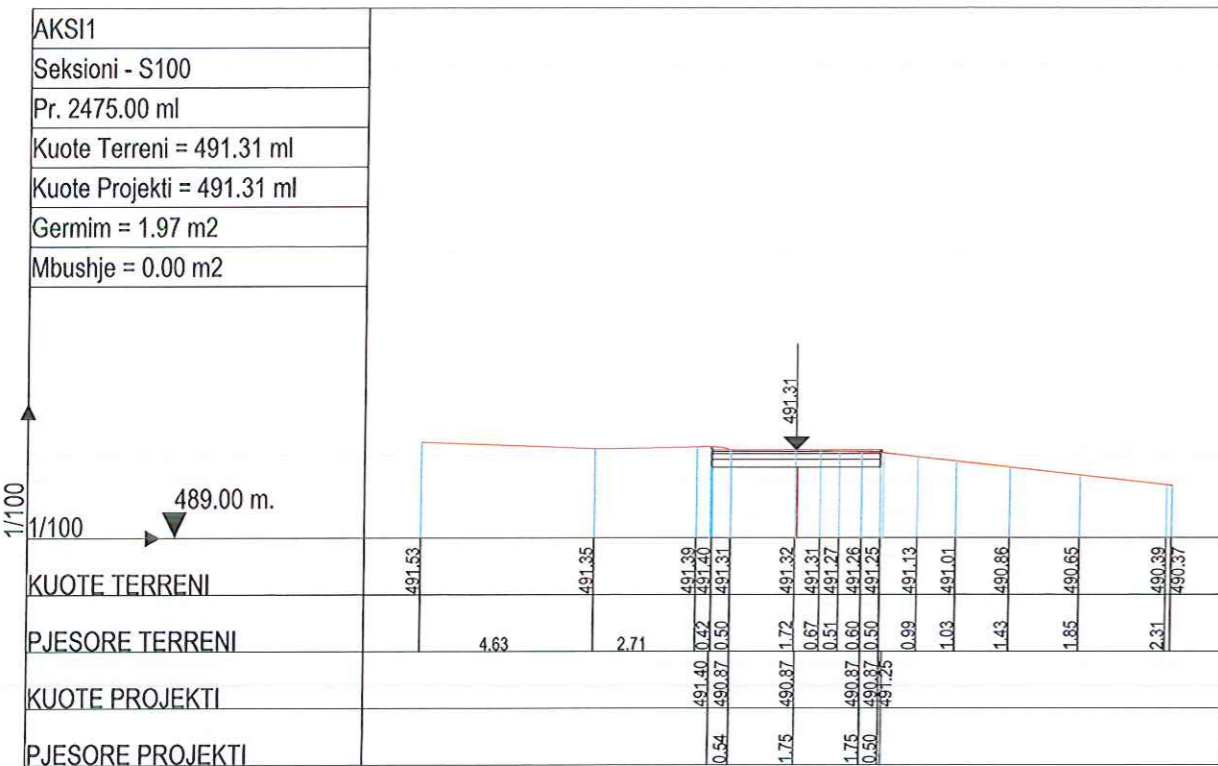
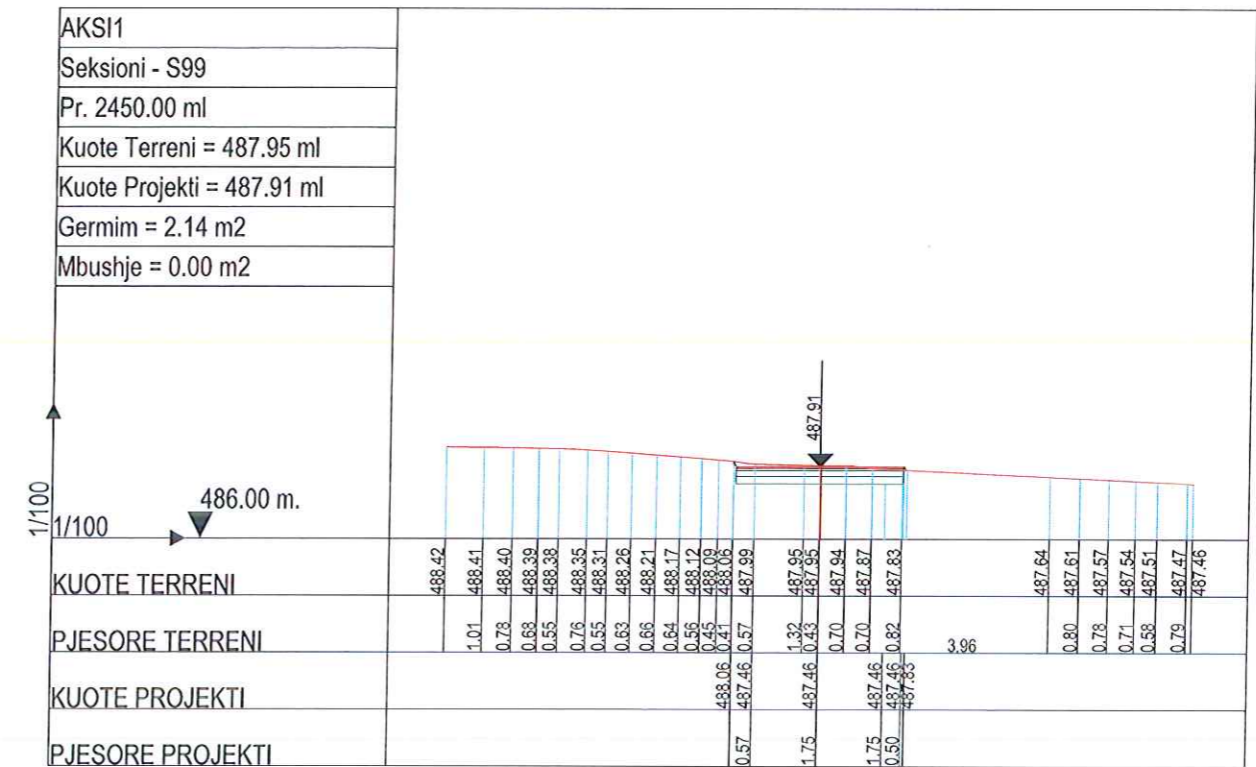
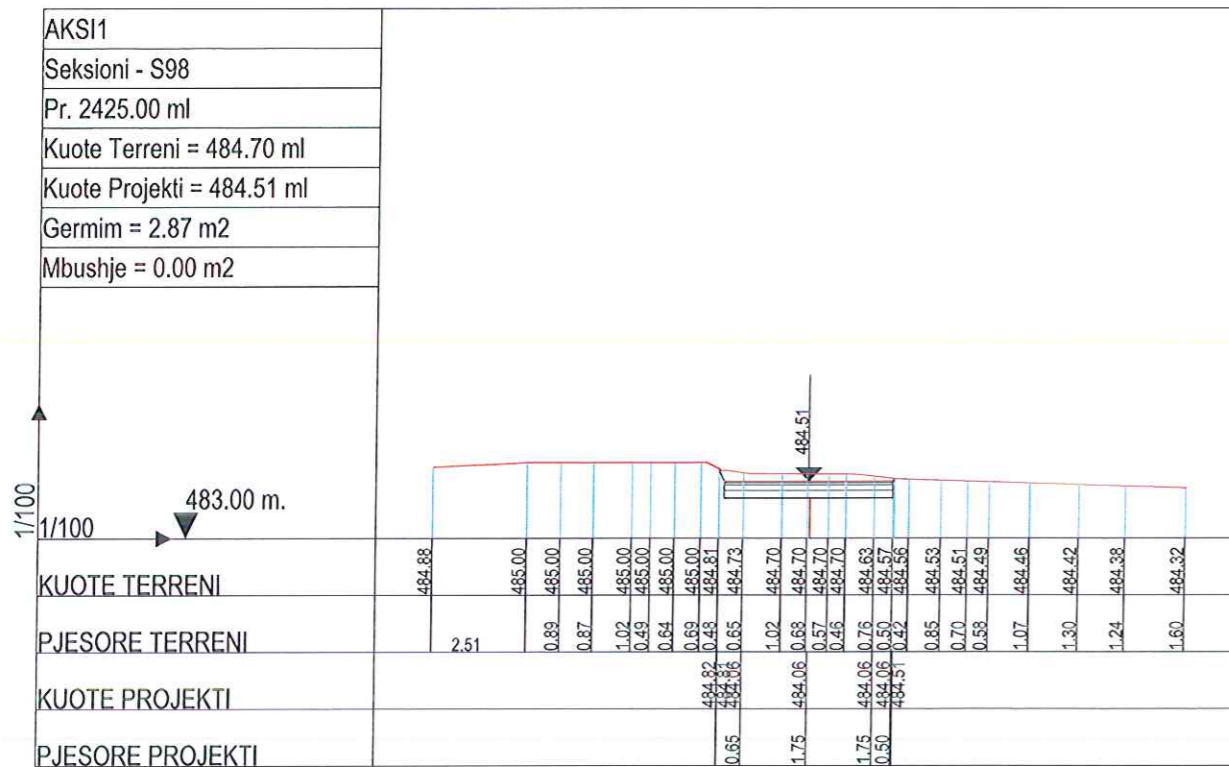

**POROSITESI : BASHKIA TROPOJË**  
 OBJEKTI:  
 "PROJEKT I RRUGES SE FSHATIT KASAJ, BASHKIA TROPOJË "

Emertimi: PROFILET TERTHORE  
 "ASI2STUDIO" Sh.p.k  
 Adresa:  
 Kompleksi Vizon Plus, Tirane.

ASIZ-STUDIO  
 Ing. MENTOR ÇOKAJ  
 Nr. Lic. X/1451  
 Projektues  
 Ing. Mentor ÇOKAJ

SHKALLA	FLETA
1 : 200	7 - 26
Tropojë 2022	Format A3

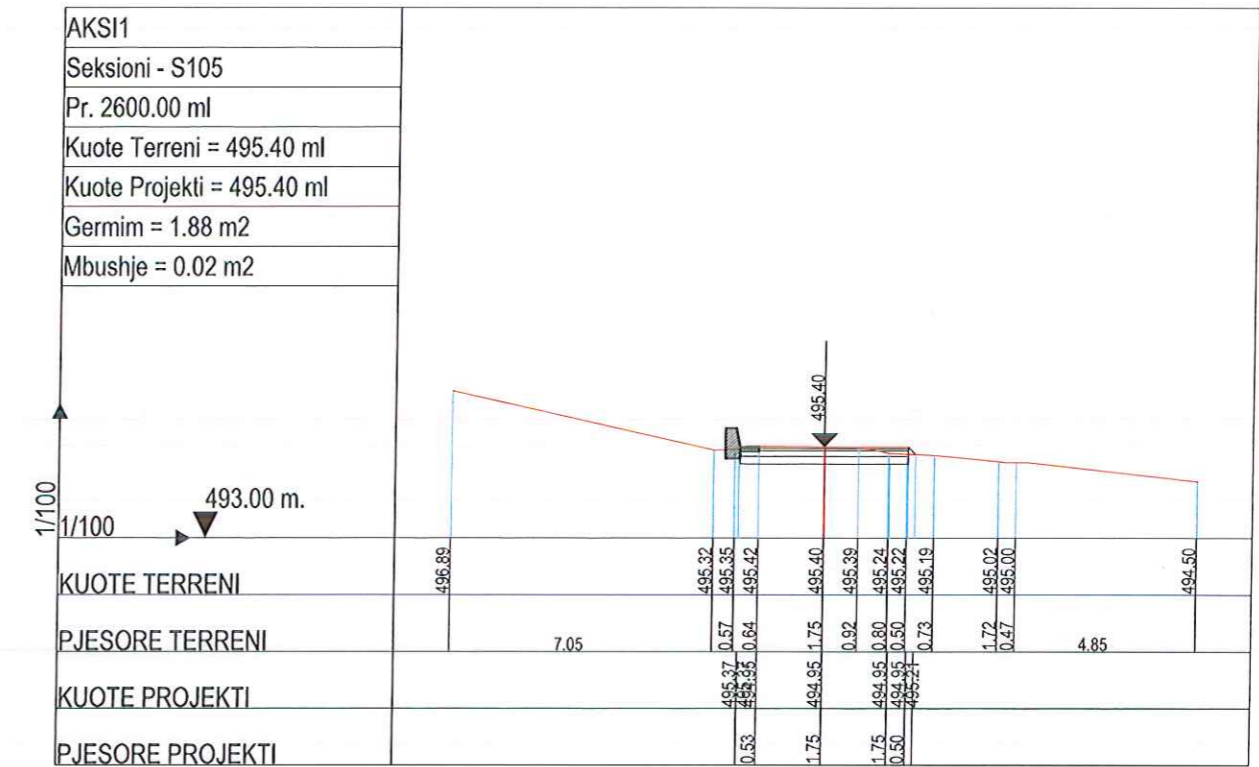
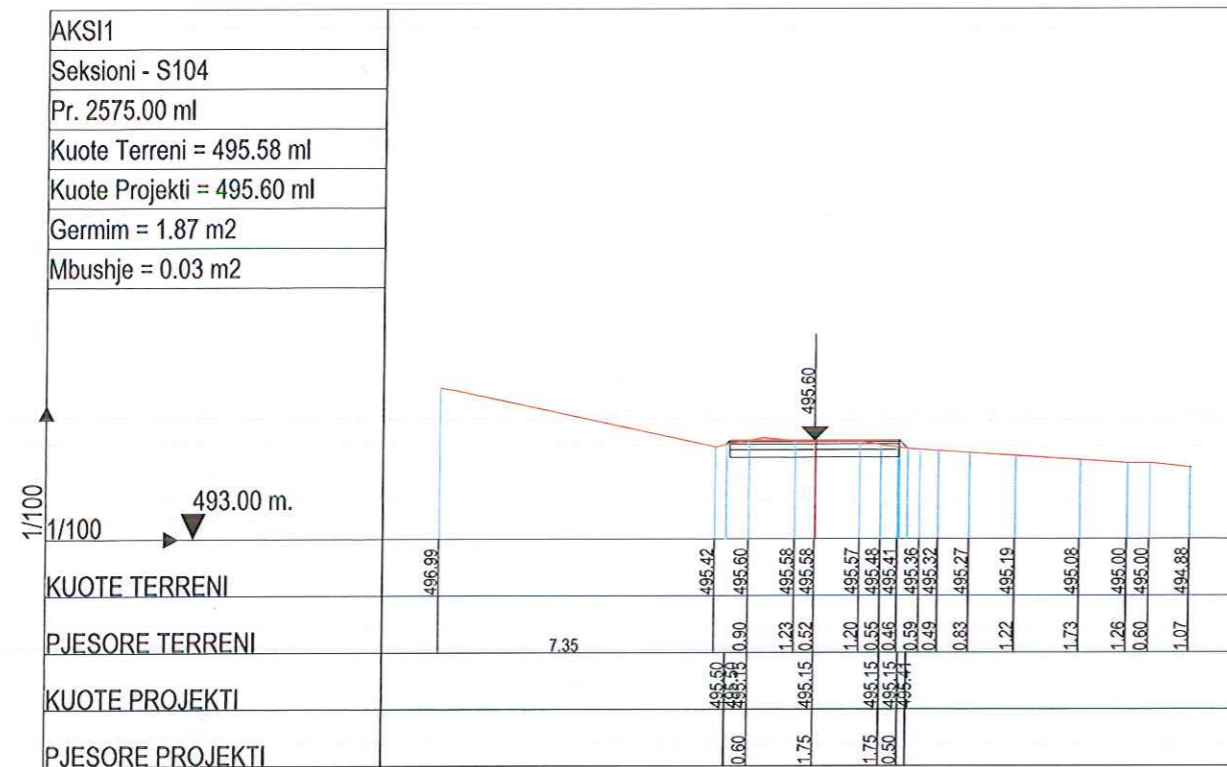
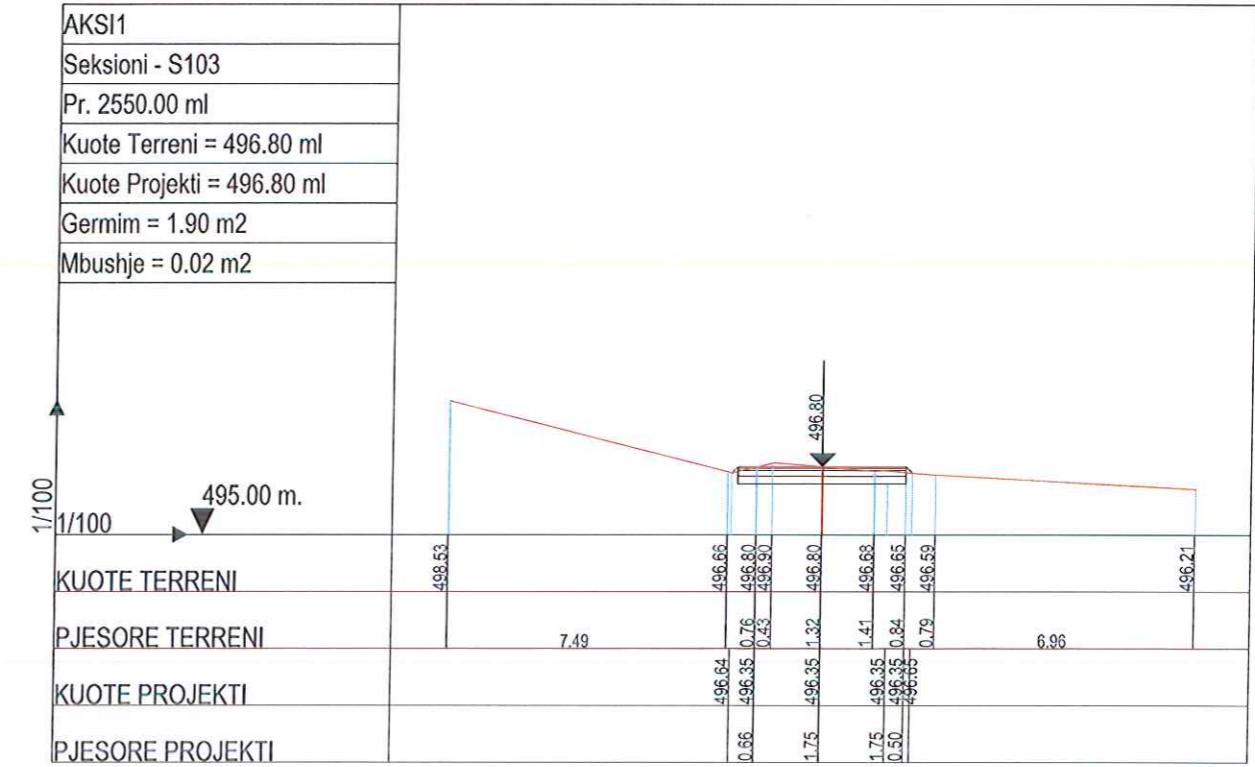
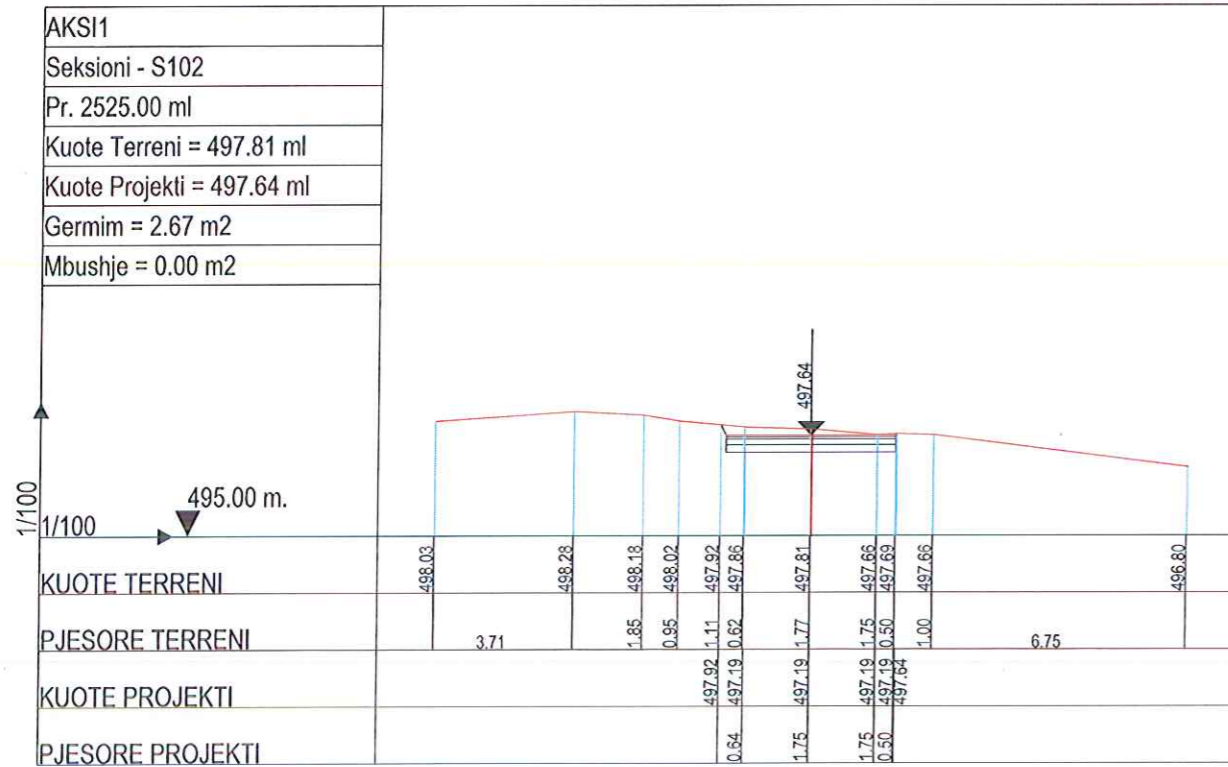

**POROSITESI : BASHKIA TROPOJË**  
 OBJEKTI:  
 "PROJEKT I RRUGES SE FSHATIT KASAJ, BASHKIA TROPOJË "

Emertimi: PROFILET TERTHORE  
 "ASI2STUDIO" Sh.p.k  
 Adresa:  
 Kompleksi Vizon Plus, Tirane.

ASIZ-STUDIO  
 Ing. MENTOR ÇOKAJ  
 Projektues  
 Ing. Mentor ÇOKAJ

SHKALLA	FLETA
1 : 200	7 - 27
Tirana 2022	Format A3

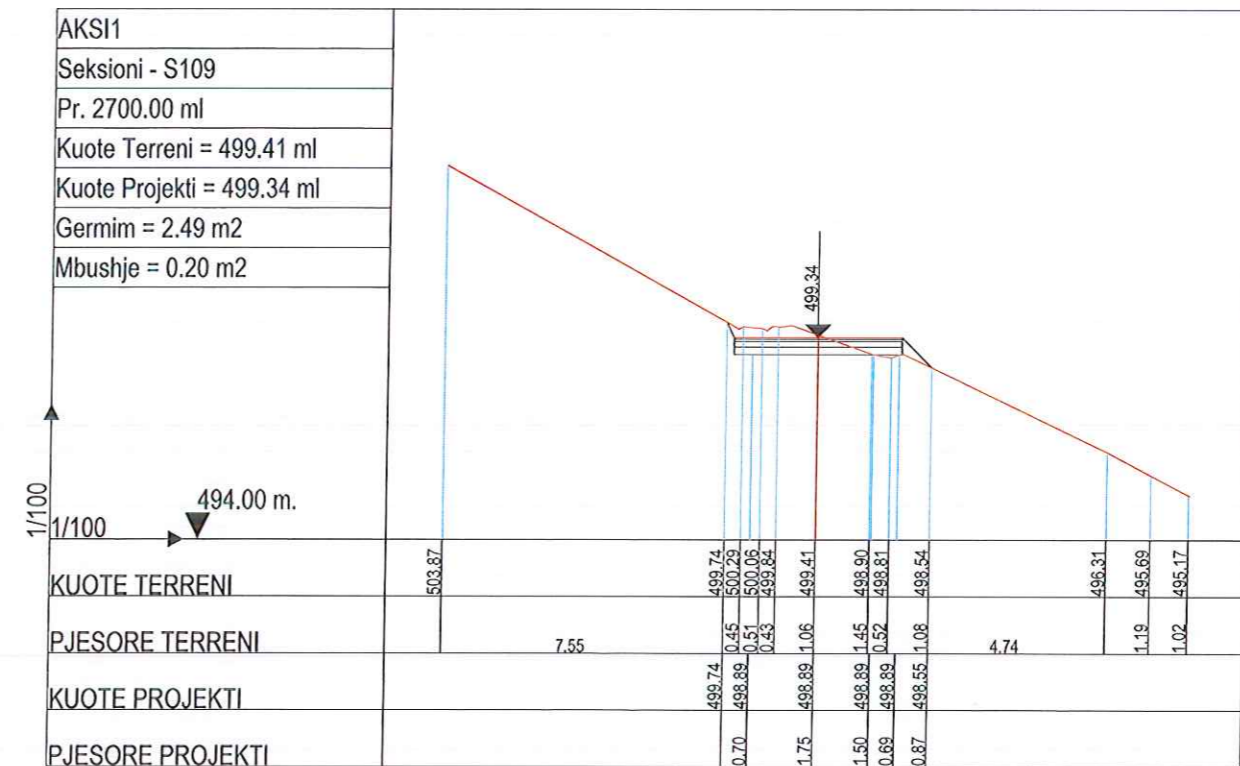
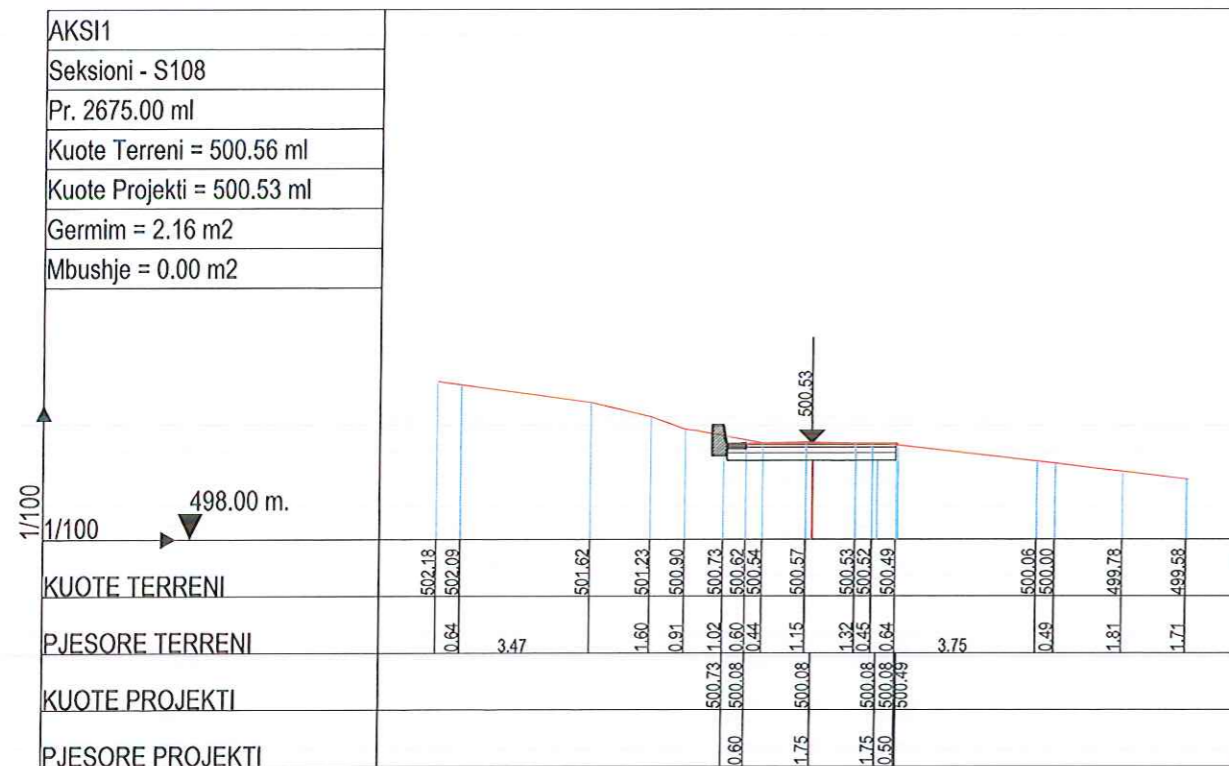
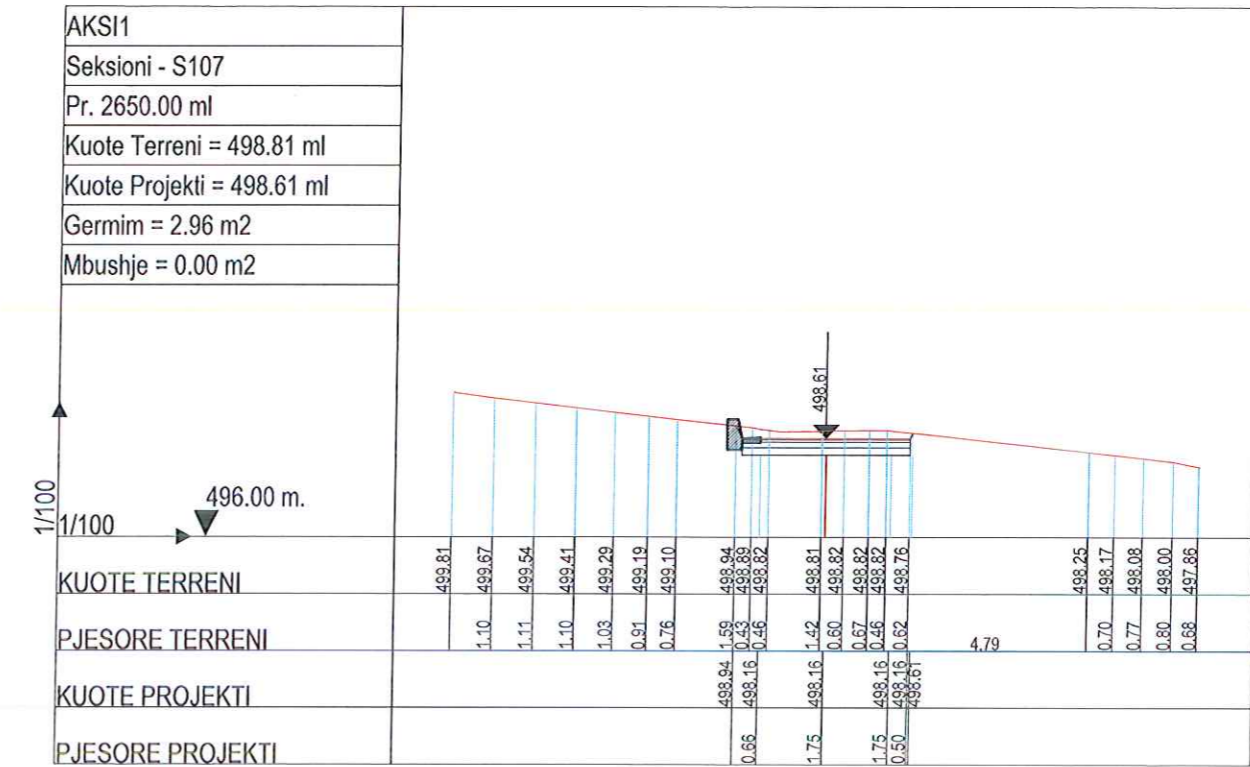
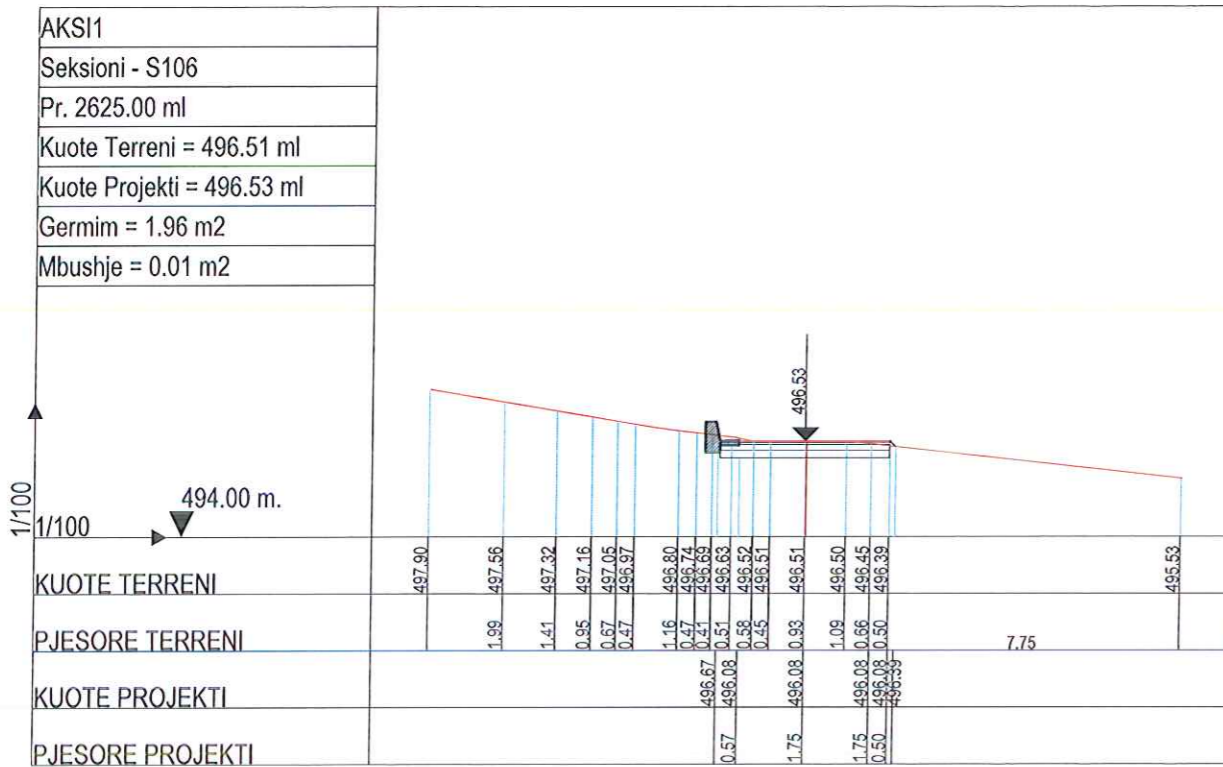

# POROSITESI : BASHKIA TROPOJË

OBJEKTI:  
"PROJEKT I RRUGES SE FSHATIT KASAJ, BASHKIA TROPOJË "

Emertimi: PROFILET TERTHORE



"ASI2STUDIO" Sh.p.k

Adresa:  
Kompleksi Vizon Plus, Tirane.

Ing. Mentor ÇOKAJ



Projektues

SHKALLA FLETA

1 : 200 7 - 28

Tropojë 2022 Format A3

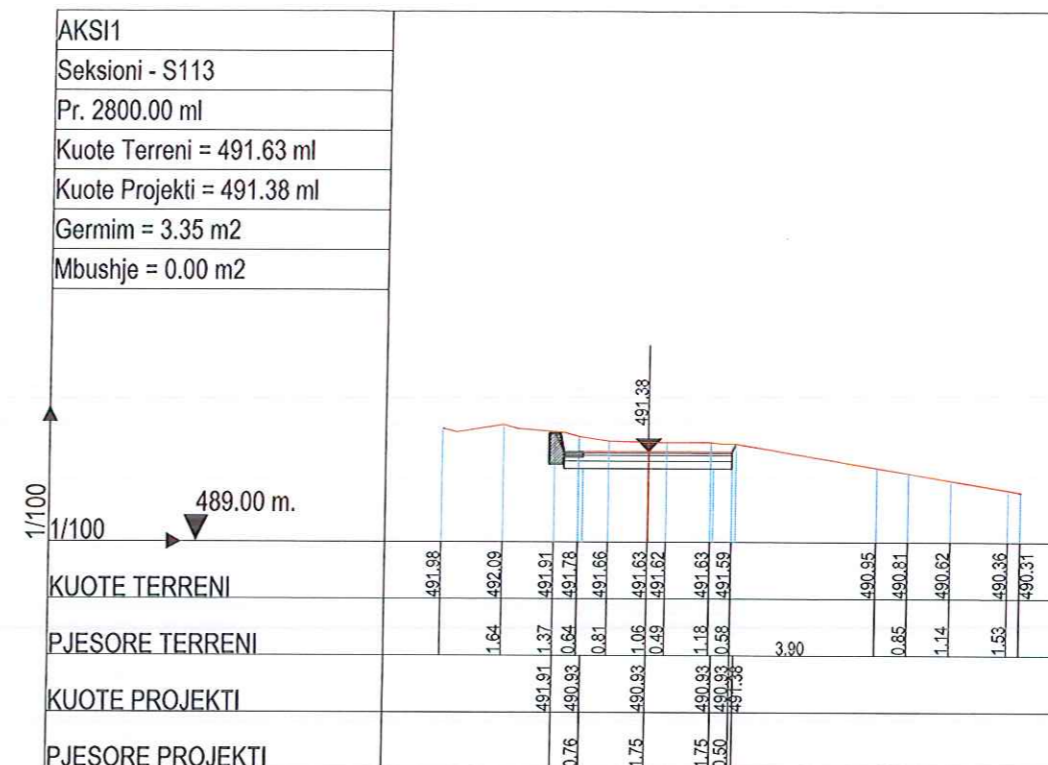
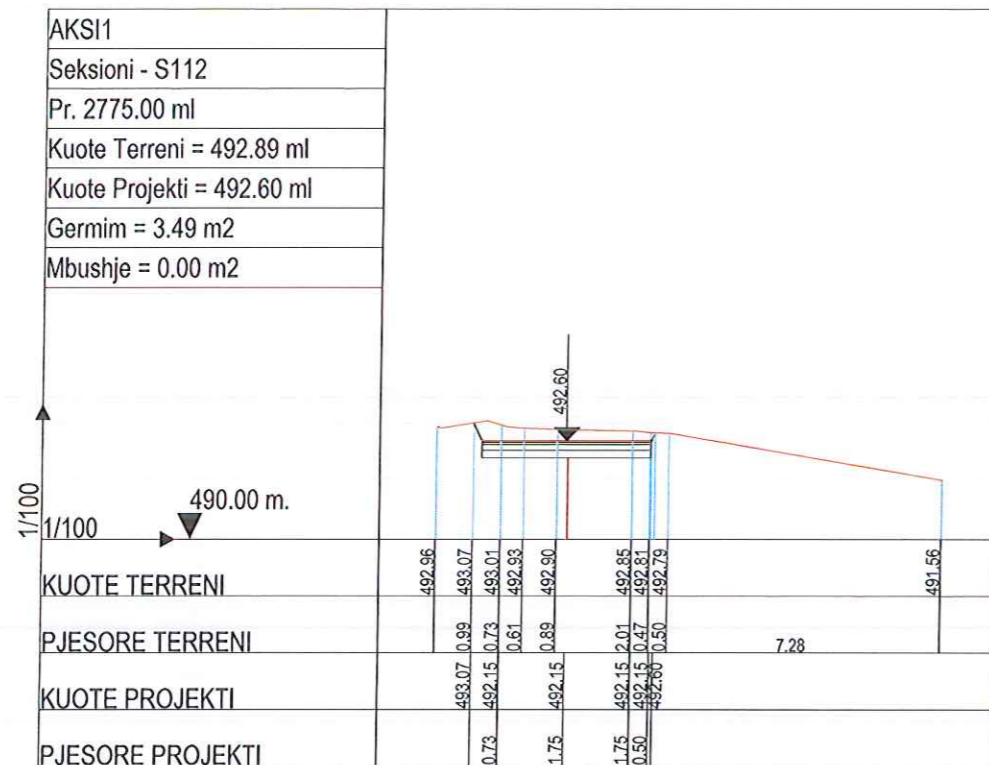
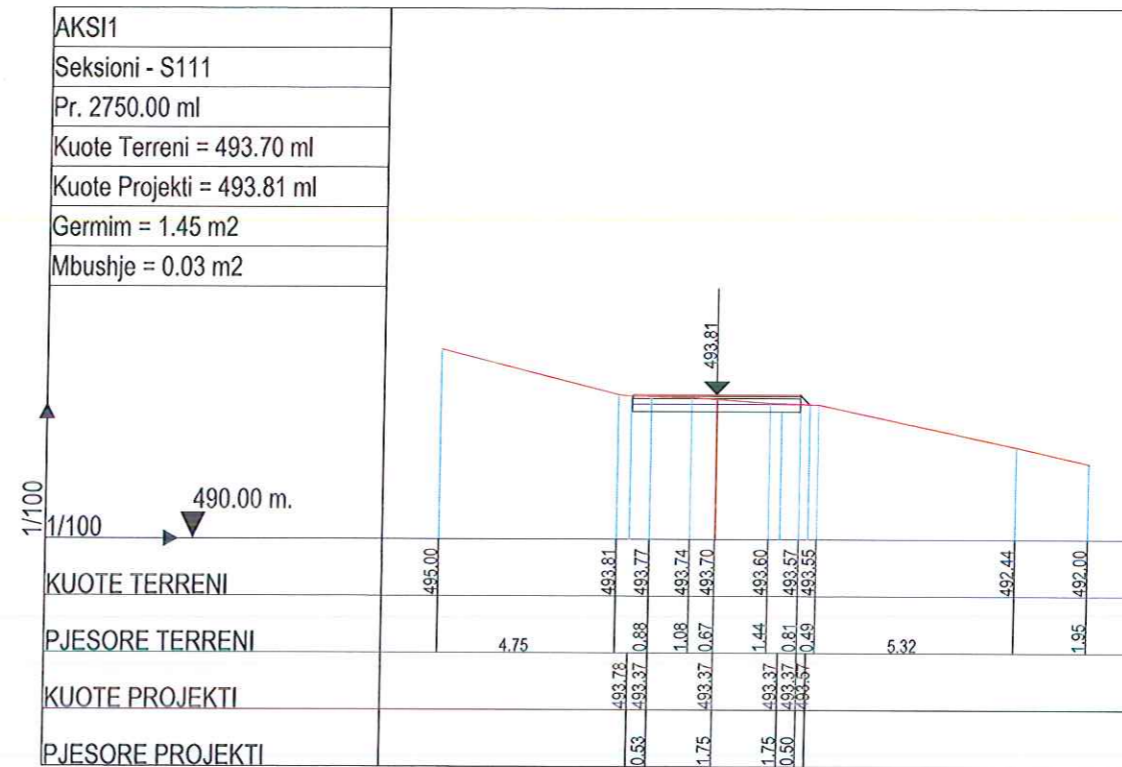
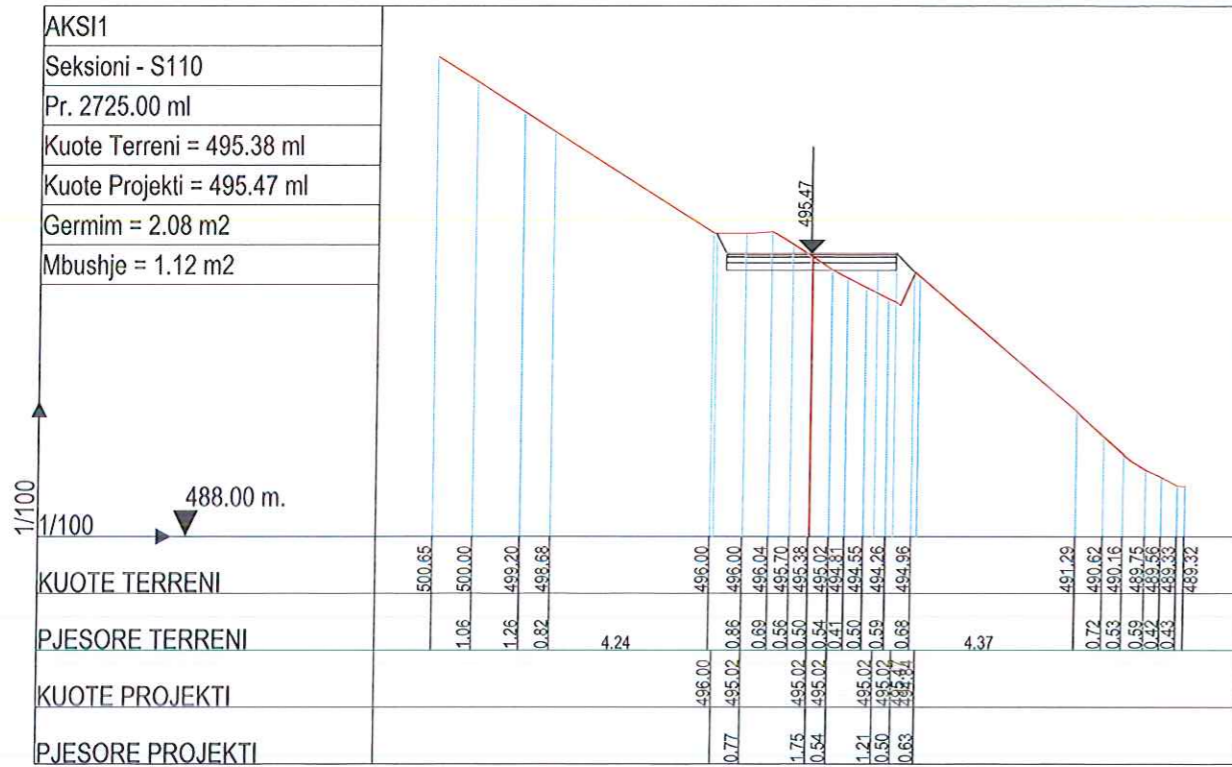

**POROSITESI : BASHKIA TROPOJË**  
 OBJEKTI:  
 "PROJEKT I RRUGES SE FSHATIT KASAJ, BASHKIA TROPOJË "

Emertimi: PROFILET TERTHORE  
 "ASI2STUDIO" Sh.p.k  
 Adresa:  
 Kompleksi Vizon Plus, Tirane.

ASIS-STUDIO  
 ING. MENTOR ÇOKAJ  
 Nr. Le. 21451  
 Projektim - Zhvillim  
 mentorcokej@gmail.com  
 Tel: 09 21 22 22

Projektues

SHKALLA	FLETA
1 : 200	7 - 29
Tropojë 2022	Format A3

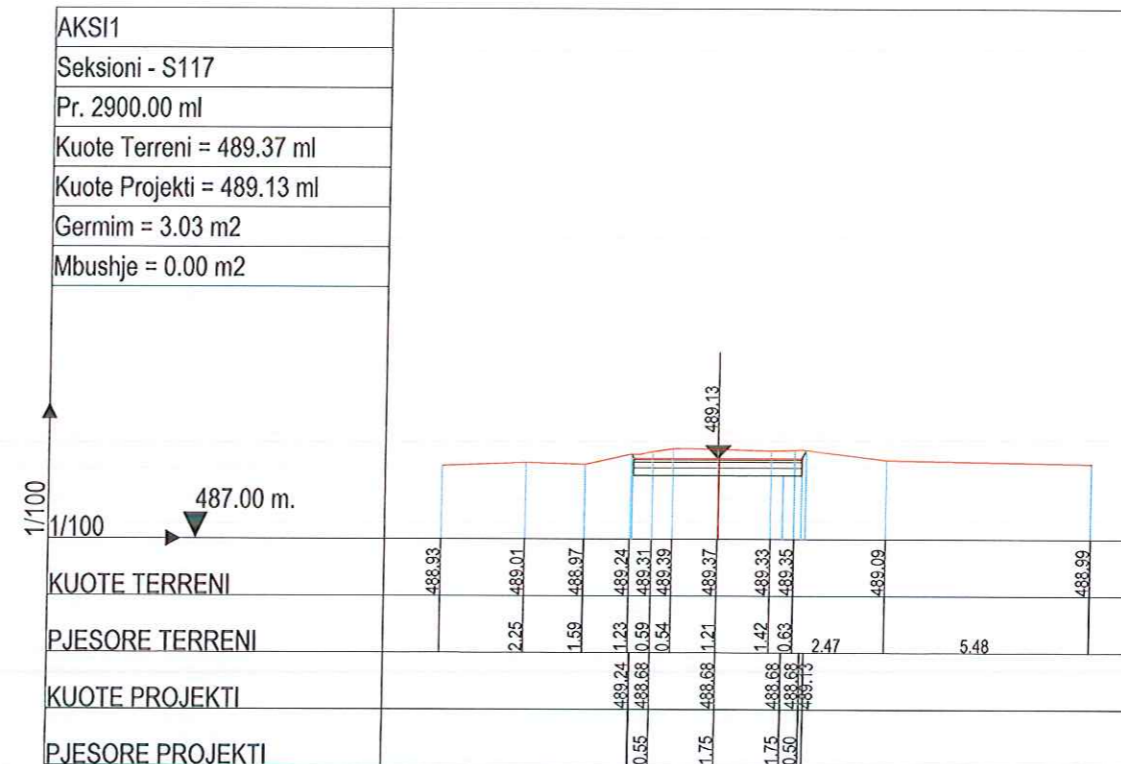
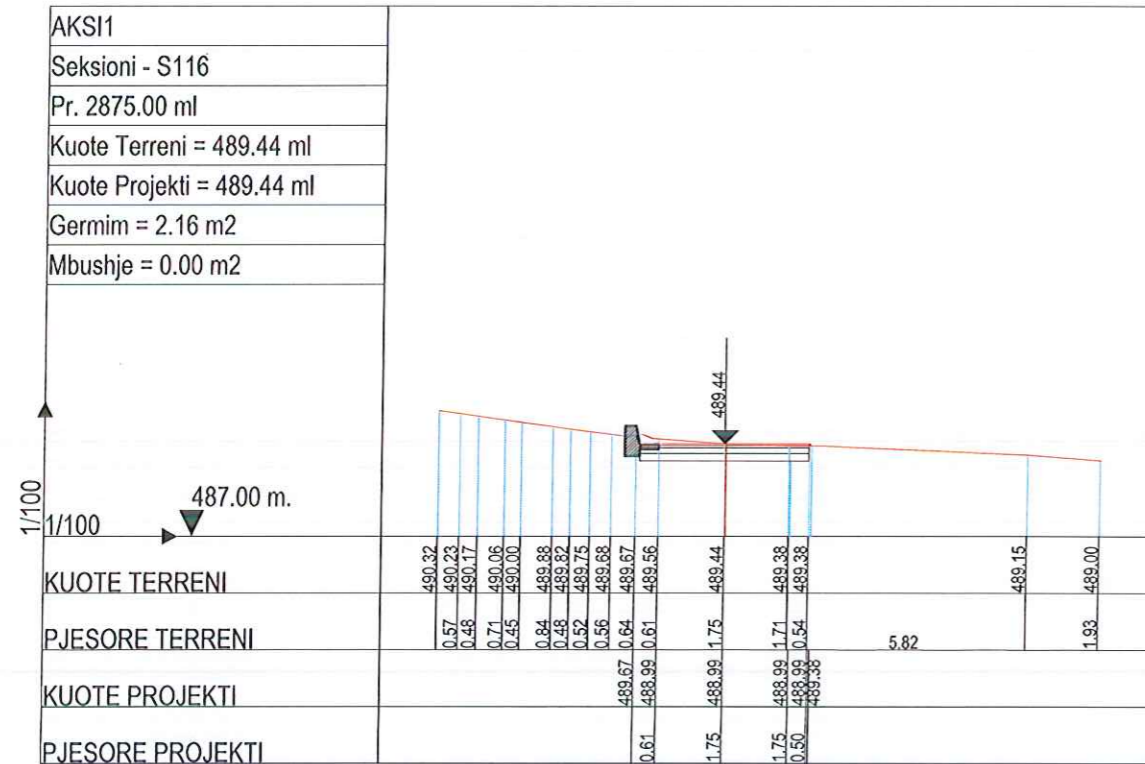
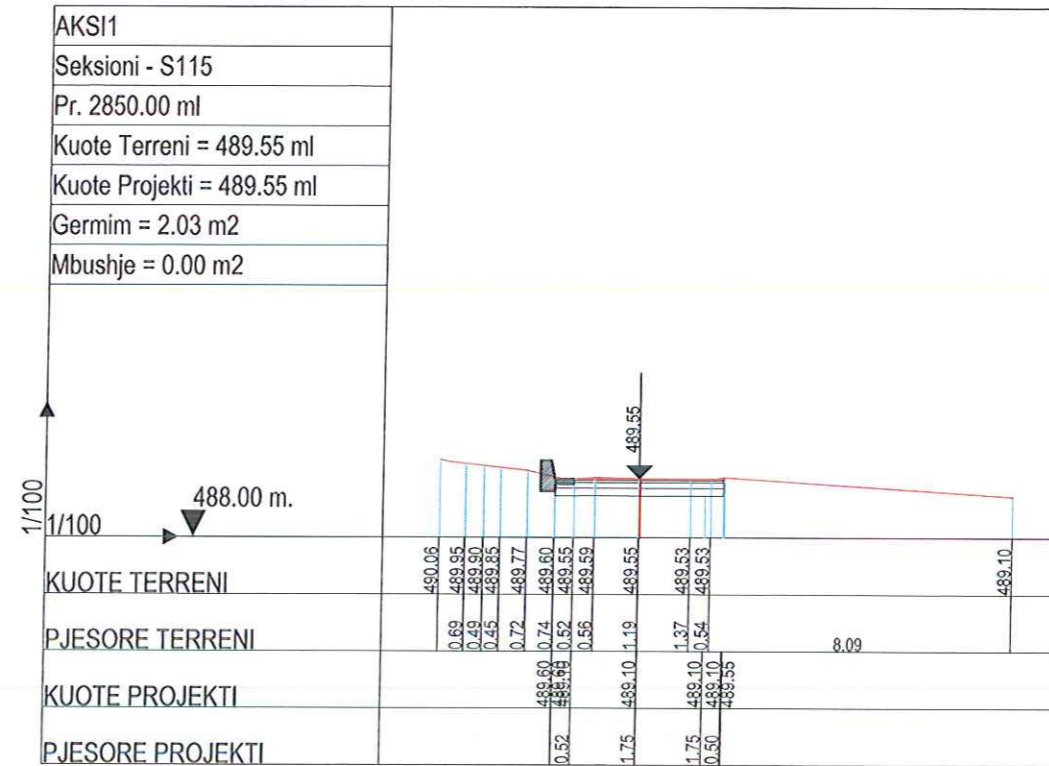
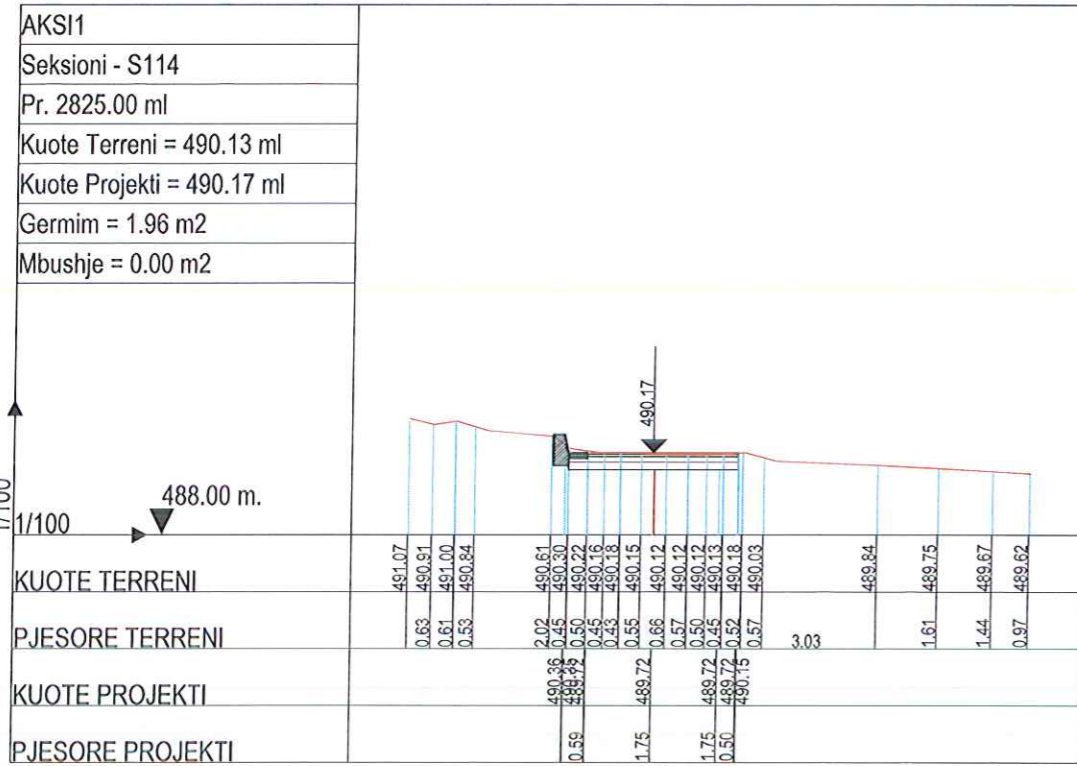

**POROSITESI : BASHKIA TROPOJË**  
 OBJEKTI:  
 "PROJEKT I RRUGES SE FSHATIT KASAJ, BASHKIA TROPOJË "

Emertimi: PROFILET TERTHORE  
 "ASI2STUDIO" Sh.p.k  
 Adresa:  
 Kompleksi Vizon Plus, Tirane.



Projektues  
 Ing. Mentor COKAJ

SHKALLA	FLETA
1 : 200	7 - 30
Tropojë 2022	Format A3



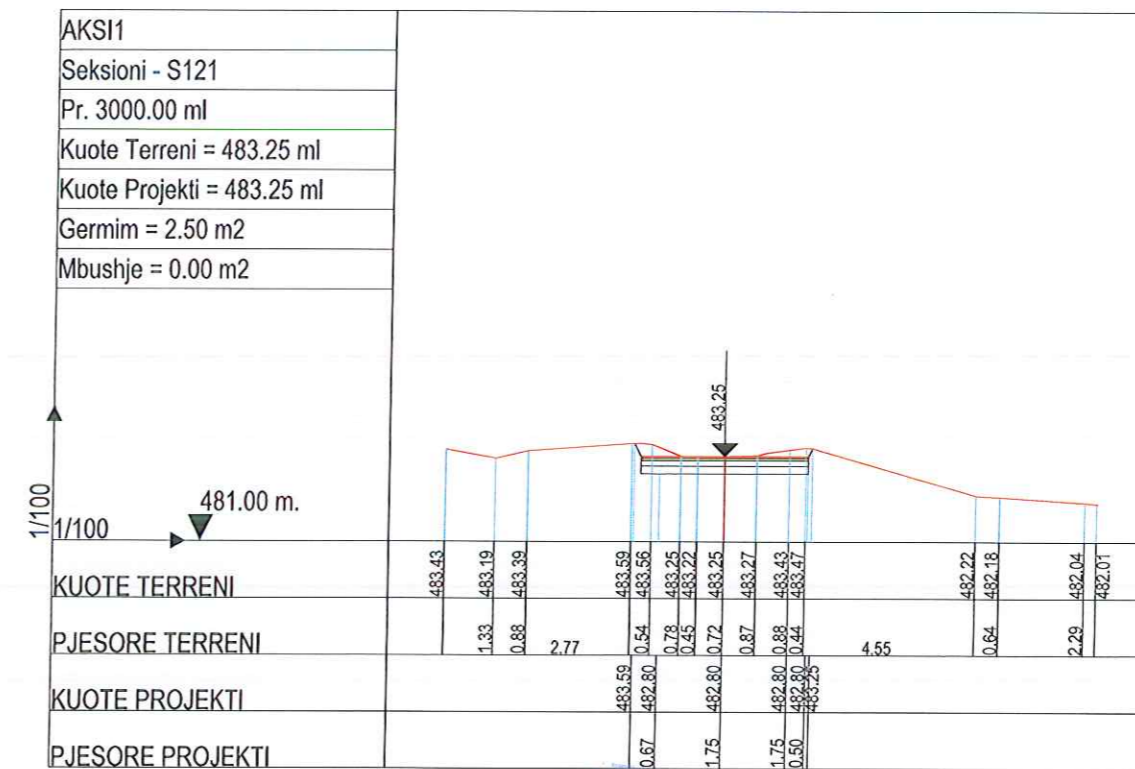
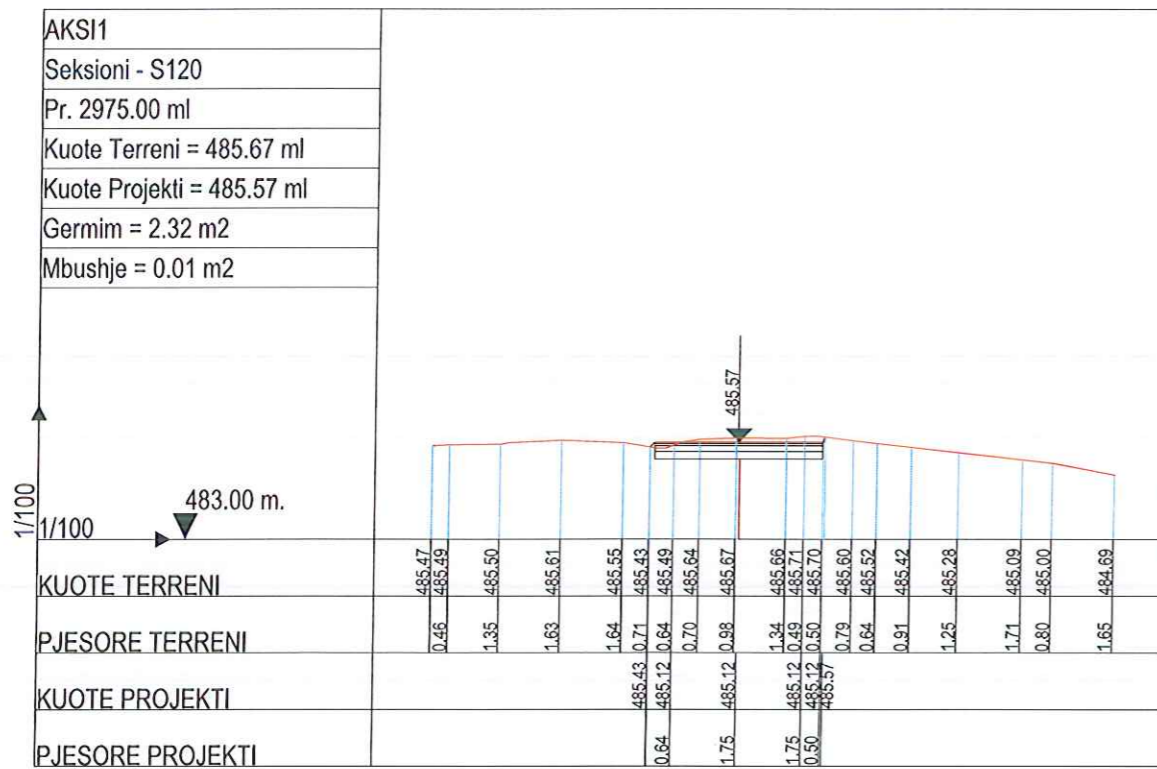
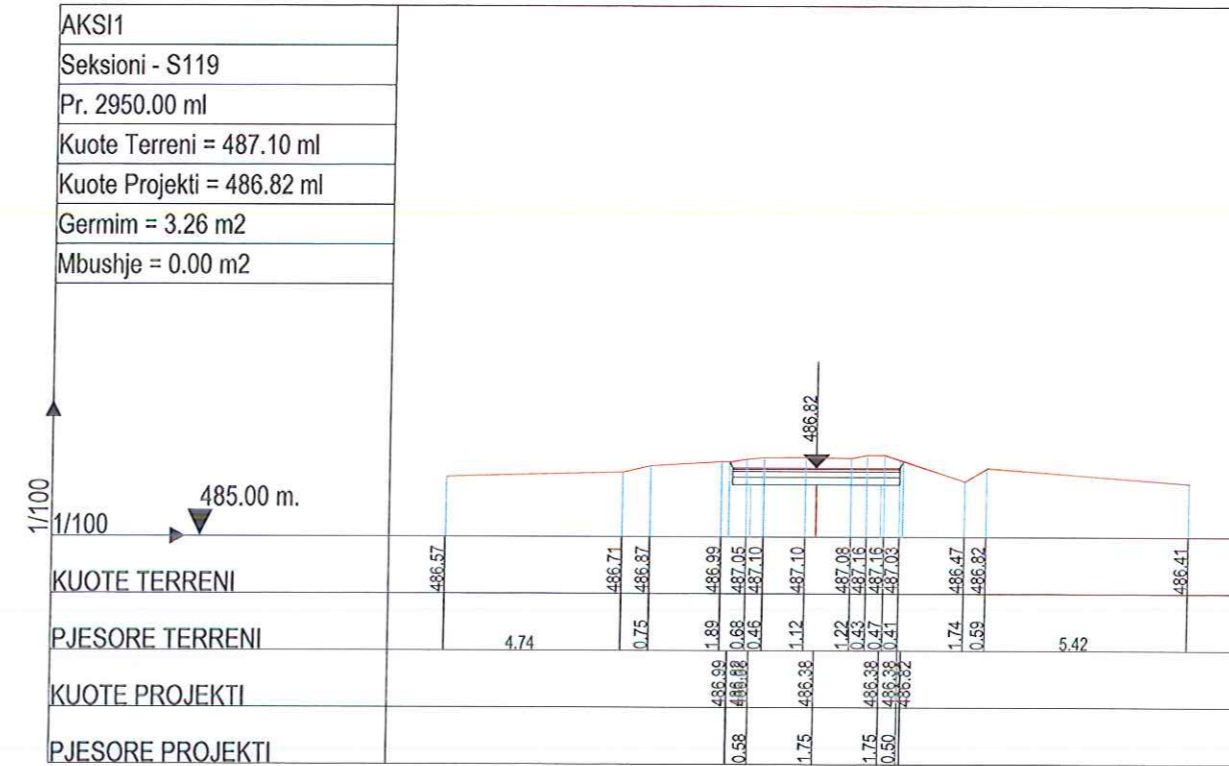
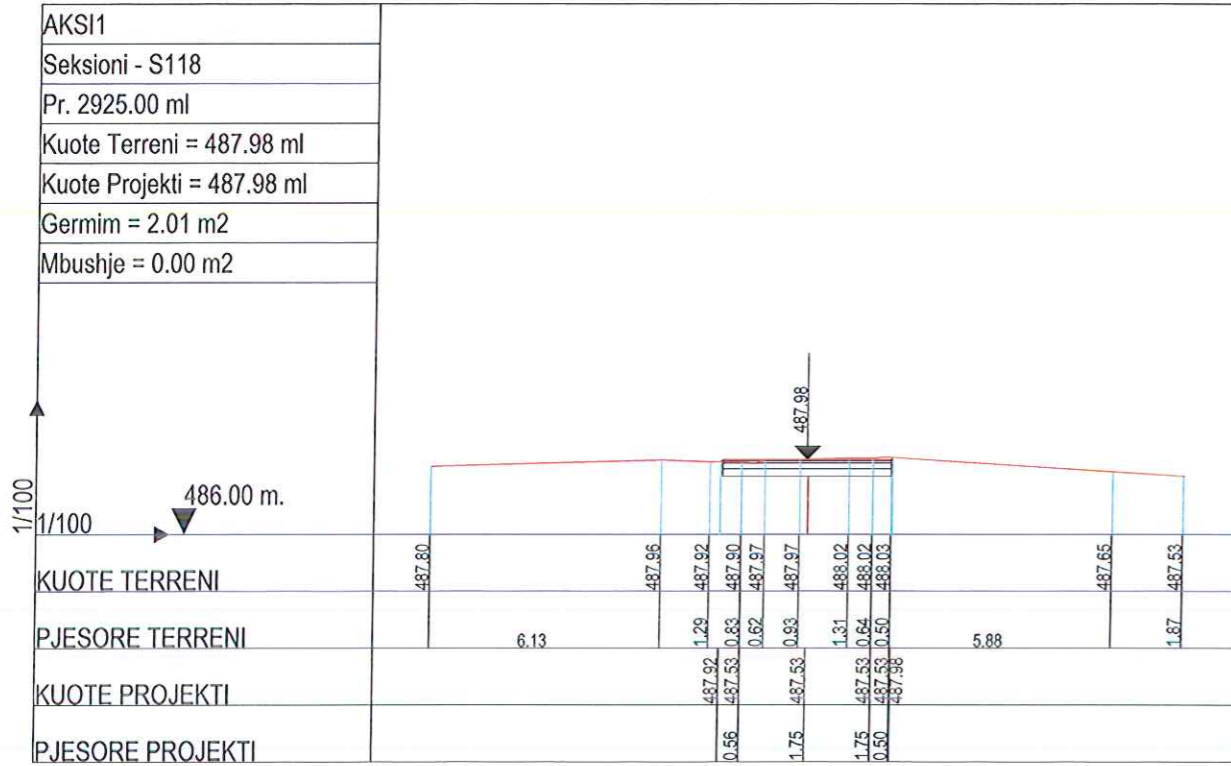

**POROSITESI : BASHKIA TROPOJË**  
 OBJEKTI:  
 "PROJEKT I RRUGES SE FSHATIT KASAJ, BASHKIA TROPOJË "

Emertimi: PROFILET TERTHORE  
 "ASI2STUDIO" Sh.p.k  
 Adresa:  
 Kompleksi Vizon Plus, Tirane.

ASI2-STUDIO  
 INZHENERI ÇOKAJ  
 Projektor - Zbatim  
 Nr. Lic. 3/1451  
 Ing. Mentor ÇOKAJ

Projektues

SHKALLA	FLETA
1 : 200	7 - 31
Tropojë 2022	Format A3



REPUBLIKA E SHQIPERISË  
BASHKIA TROPOJË

# PROJEKT ZBATIMI

OBJEKTI:

"PROJEKT I RRUGES SE FSHATIT KASAJ, BASHKIA TROPOJË"

9.PLANIMETRIA E NDRICIMIT



POROSITESI : BASHKIA TROPOJË

OBJEKTI:  
"PROJEKT I RRUGES SE FSHATIT KASAJ, BASHKIA TROPOJË "

Emertimi: PLANIMETRIA E NDRICIMIT



"ASI2STUDIO" Sh.p.k

Adresa:  
Kompleksi Vizon Plus, Tirane.



Projektues

SHKALLA FLETA

- 9 - 00

Tropojë 2022 Format A2

**LEGJENDE**

-  Shtylle ndricimi ( Hsh=7.0m)
-  Tub Fleksibel elektrik 2φ=80mm
-  Tub metalik Φ=168mm per kalim linje ne rruge
-  Tub fleksibel me 2 shtresa Φ=75mm per ndricim
-  Pusete kontrolli

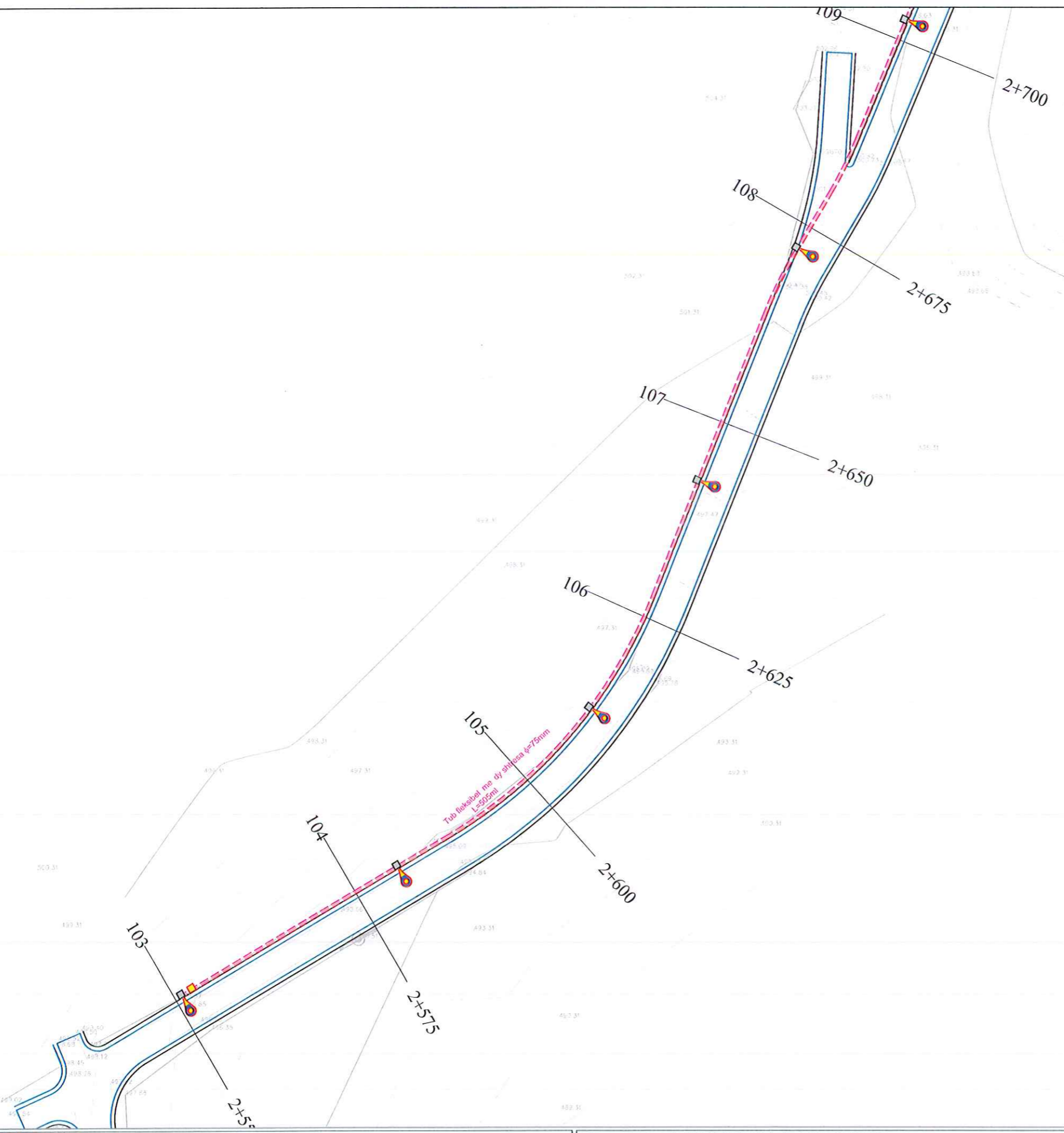

**POROSITESI : BASHKIA TROPOJË**  
 OBJEKTI:  
 "PROJEKT I RRUGES SE FSHATIT KASAJ, BASHKIA TROPOJË "

Emertimi: PLANIMETRIA E NDRICIMIT  
 "ASI2STUDIO" Sh.p.k  
 Adresa:  
 Kompleksi Vizon Plus, Tirane.

**ASI2-STUDIO**  
 Inj. Mentor COKAJ  
 Projektes  
 1. 05. 2022

Projektues

SHKALLA	FLETA
1 : 500	9 - 01
Tropis 2022	Format A3

**LEGJENDE**

-  Shtylle ndricimi (Hsh=7.0m)
-  Tub Fleksibel elektrik 2φ=80mm
-  Tub metalik Φ=168mm per kalim linje ne rruge
-  Tub fleksibel me 2 shtresa Φ=75mm per ndricim
-  Pusete kontrolli

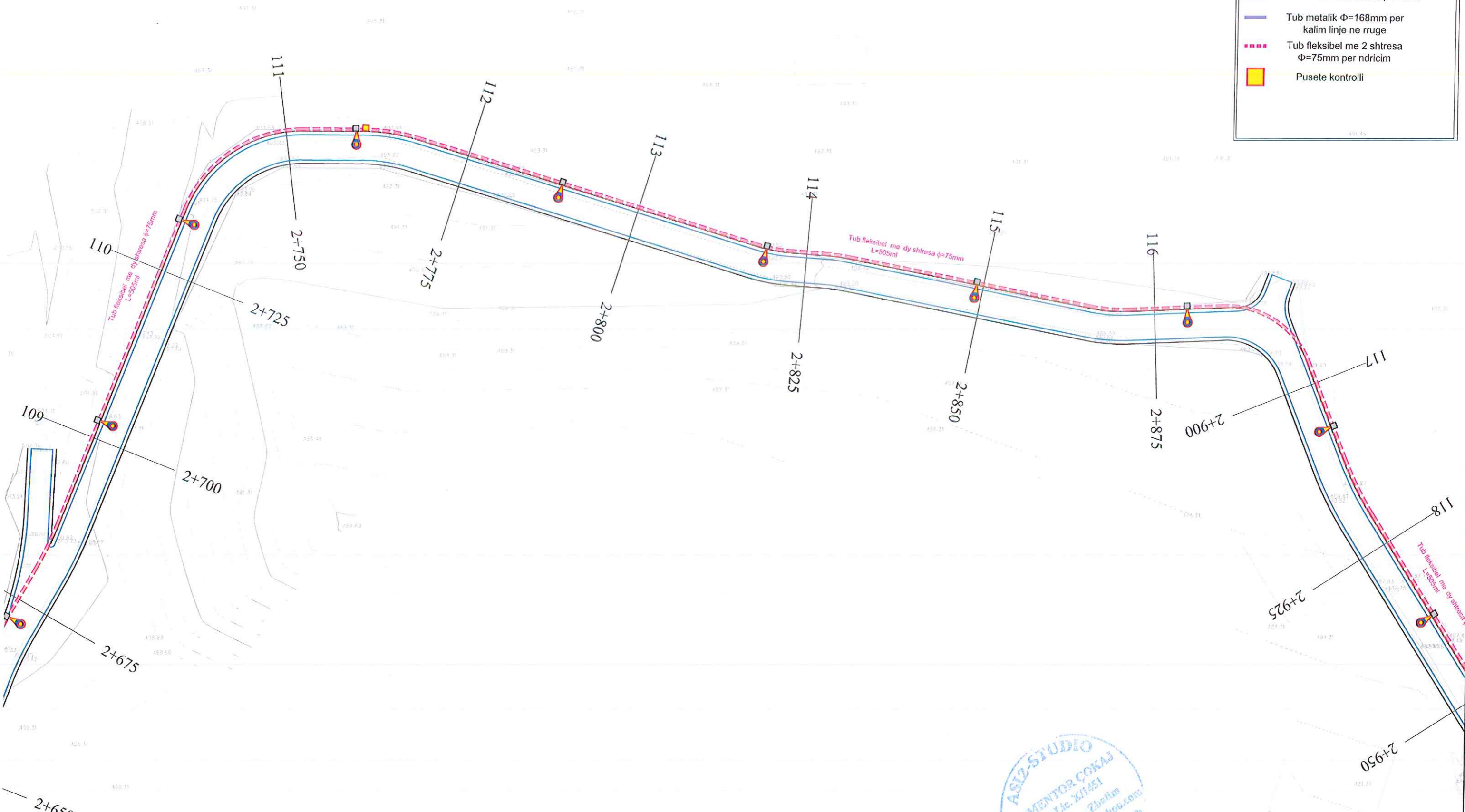

**POROSITESI : BASHKIA TROPOJË**  
 OBJEKTI:  
 "PROJEKT I RRUGES SE FSHATIT KASAJ, BASHKIA TROPOJË "

Emertimi: PLANIMETRIA E NDRICIMIT  
 "ASIZSTUDIO" Sh.p.k  
 Adresa:  
 Kompleksi Vizon Plus, Tirane.

Projektues  
 Ing. Mentor ÇOKAJ  
 Nr. Lic. XI/151  
 Projektues - Zbatim  
 mentorcokej@tqalnet.com

SHKALLA	FLETA
1 : 500	9 - 02
Tiranë 2022	Format A2



### LEGJENDE

-  Shtylle ndricimi (Hsh=7.0m)
-  Tub Fleksibel elektriku 2φ=80mm
-  Tub metalik φ=168mm per kalim linje ne rruge
-  Tub fleksibel me 2 shtresa φ=75mm per ndricim
-  Pusete kontrolli

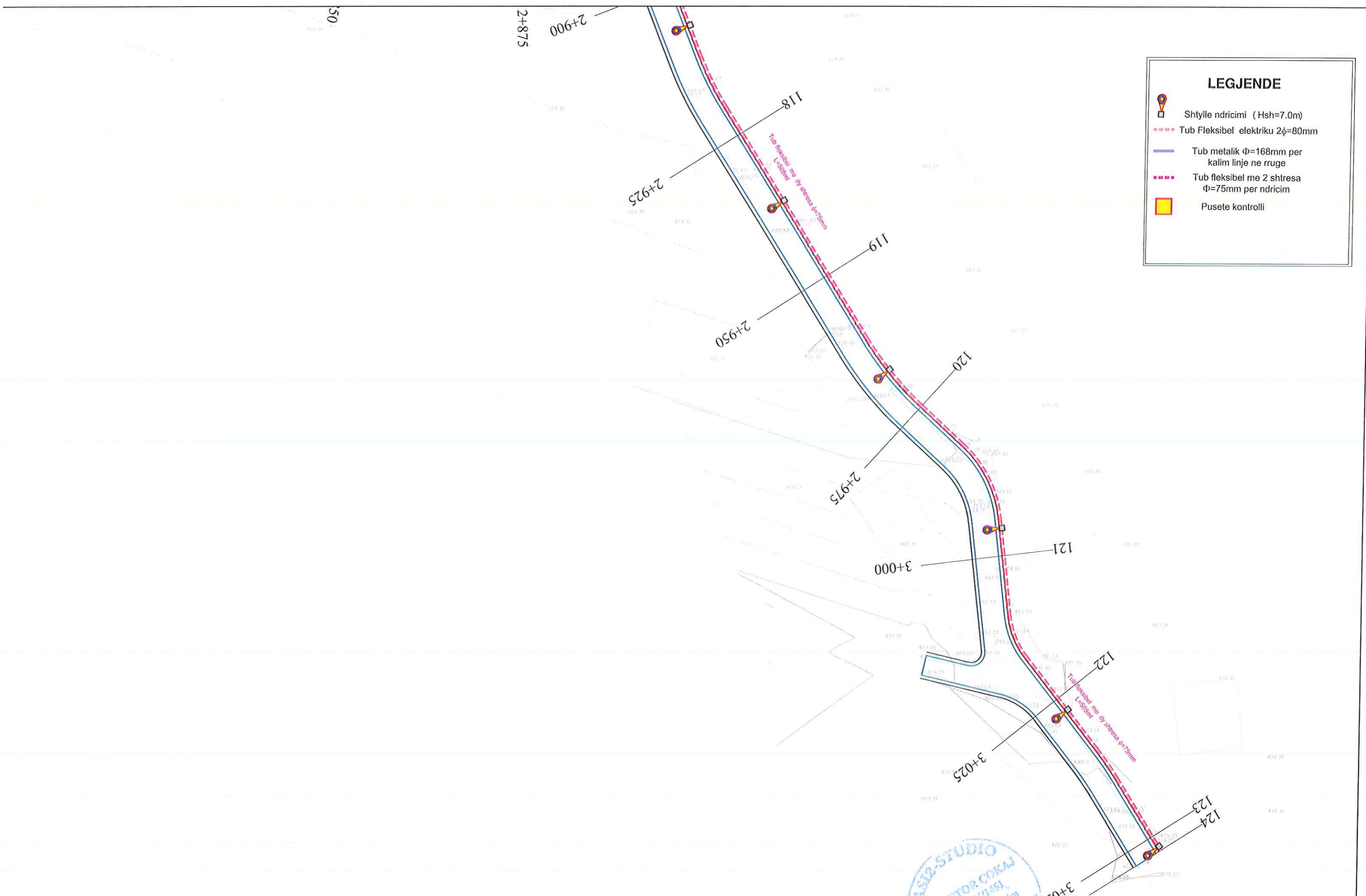

**POROSITESI : BASHKIA TROPOJË**  
 OBJEKTI:  
 "PROJEKT I RRUGES SE FSHATIT KASAJ, BASHKIA TROPOJË "

Emertimi: PLANIMETRIA E NDRICIMIT  
 "ASI2STUDIO" Sh.p.k  
 Adresa:  
 Kompleksi Vizon Plus, Tirane.

  
 Ing. Mentor ÇOKAJ  
 Projektohet dhe ndihet  
 mentor@okaj.com  
 Tel: 069 21 22 81

Projektohet nga  
 Projektohet nga  
 Projektohet nga

SHKALLA	FLETA
1 : 500	9 - 03
Tirane 2022	Format A2



REPUBLIKA E SHQIPERISË  
BASHKIA TROPOJË

# PROJEKT ZBATIMI

OBJEKTI:

"PROJEKT I RRUGES SE FSHATIT KASAJ, BASHKIA TROPOJË"

10.DETAJET E RRUGES



	<b>POROSITESI : BASHKIA TROPOJË</b>	Emertimi: DETAJET E RRUGES	Ing. Mentor COKAJ Projektues	SHKALLA	FLETA
	OBJEKTI: "PROJEKT I RRUGES SE FSHATIT KASAJ, BASHKIA TROPOJË "	 "ASIZSTUDIO" Sh.p.k Adresa: Kompleksi Vizon Plus, Tirane.			-
				Tropojë 2022	Format A3

## Hollësi e inkastrimit të kolonës së ndriçuesit me lartësi H=7m

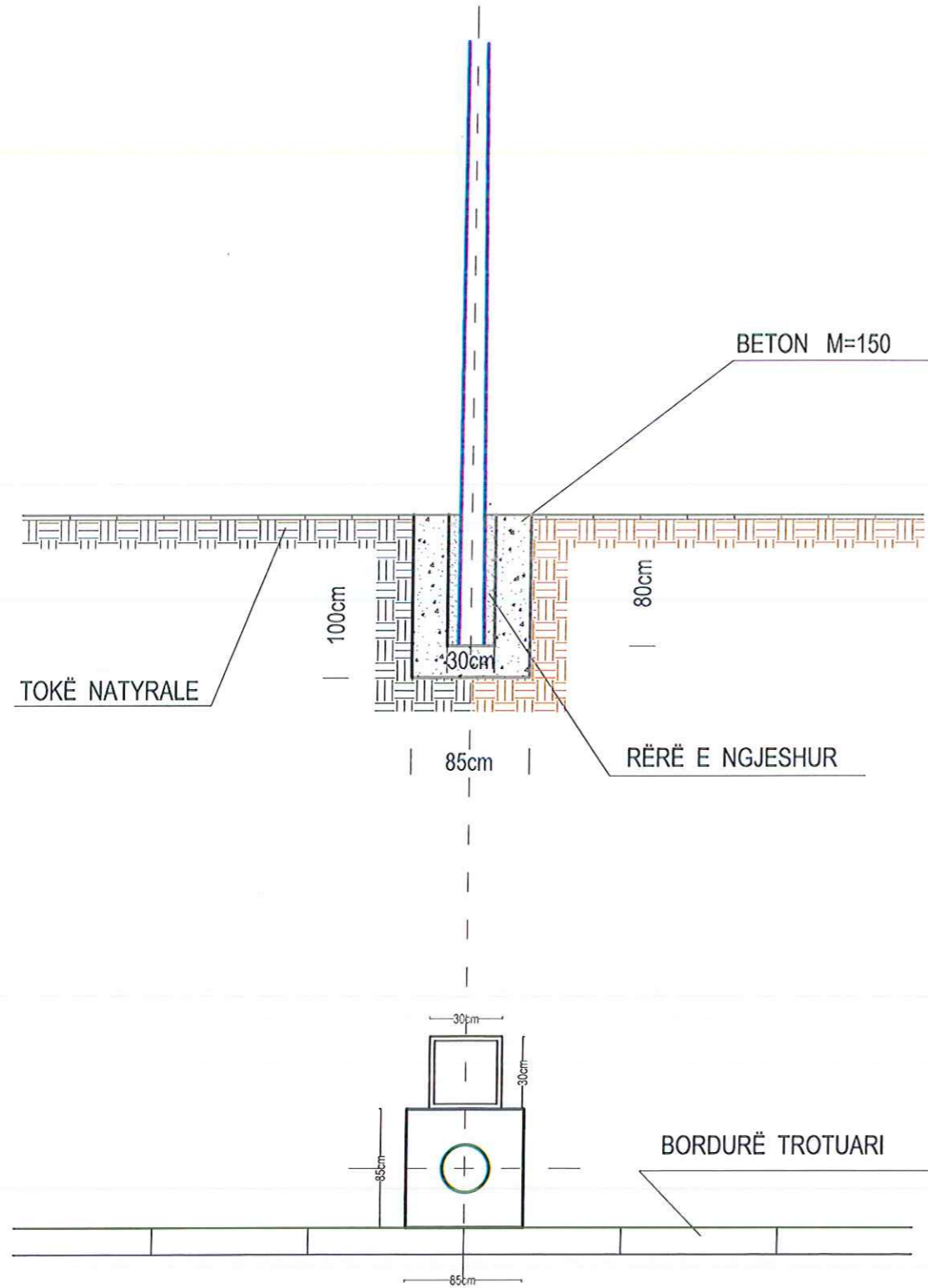

## Hollësi e vendosjes së pusetës

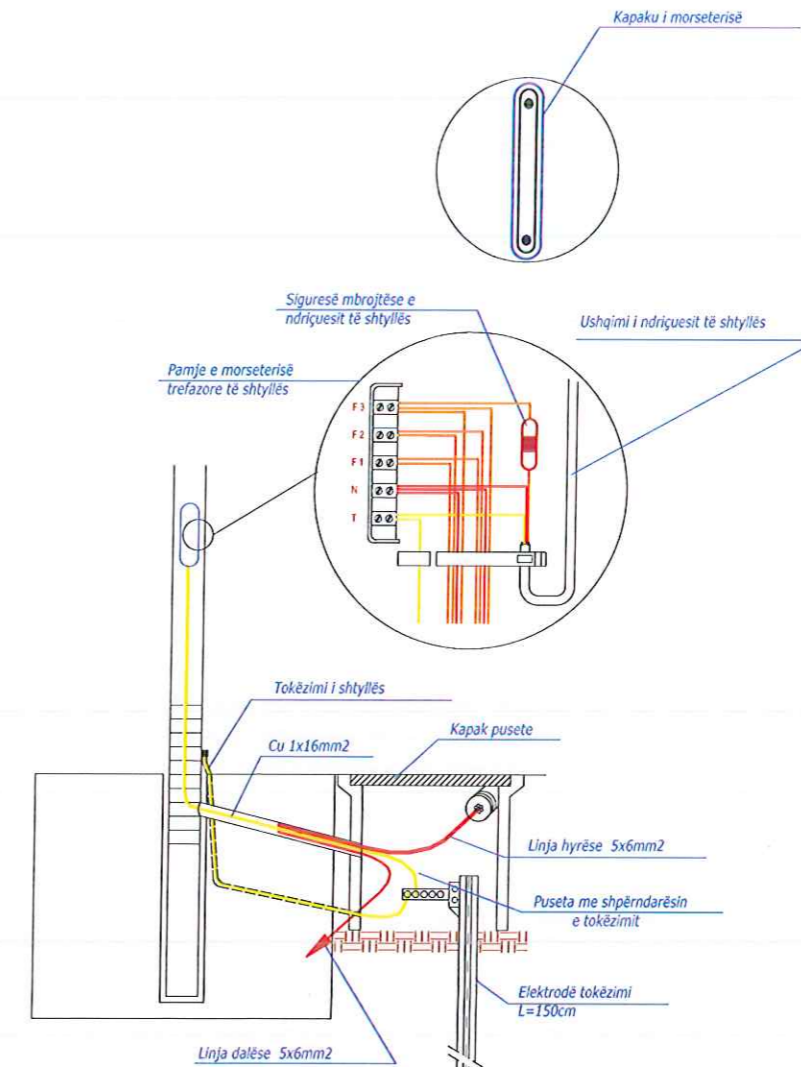
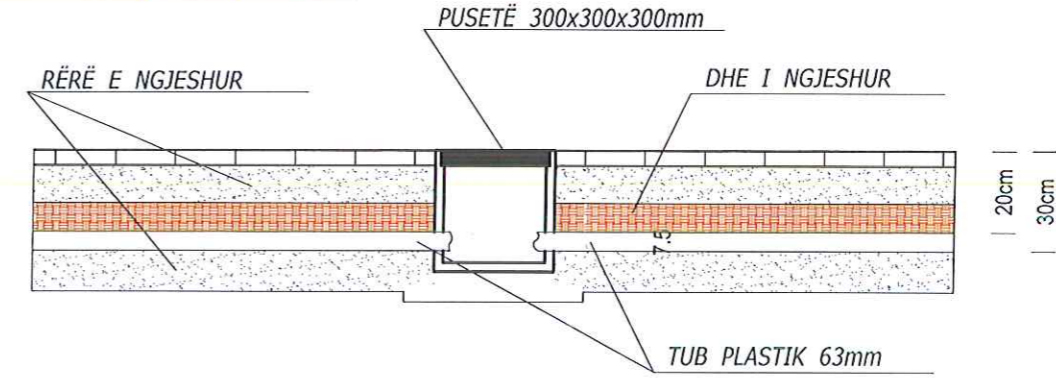

Re  
Puseta  
30x30x30



Prerje e kapakut prej gize

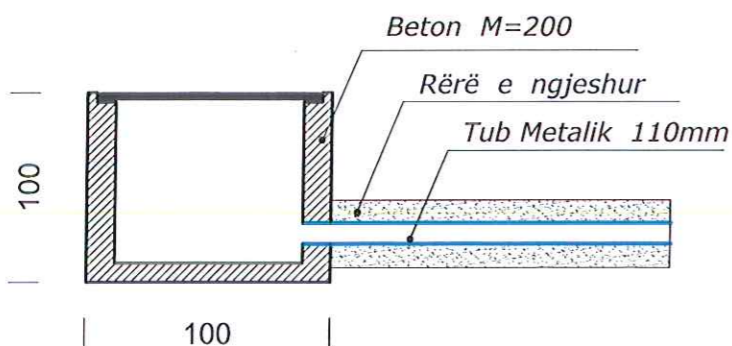

Prerje e vendosjes së pusotave

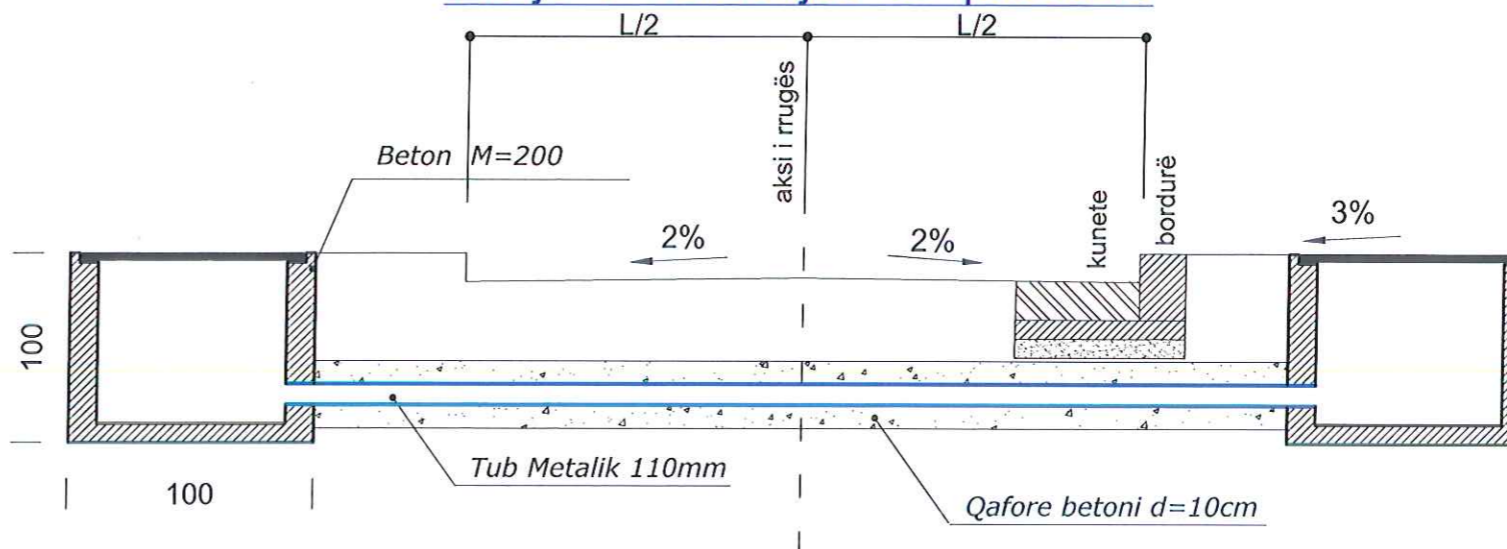

Kapaku i pusotës prej gize

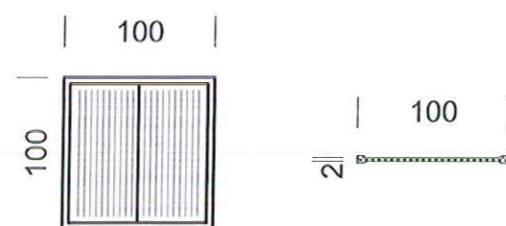

DETAJ I PUSOTES 0.5X0.5m PER LINJAT E NDRICIMIT

Kapaku i pusotës prej plastike

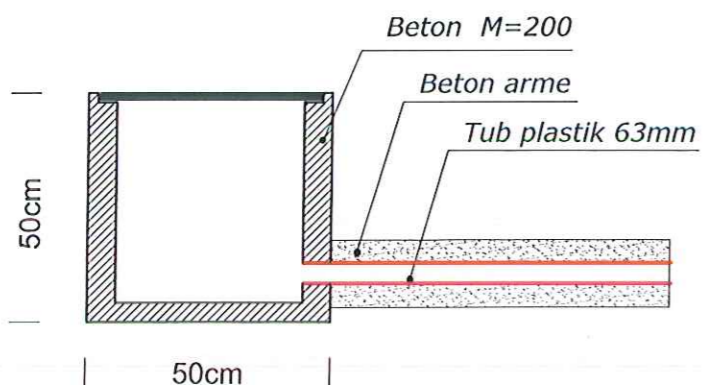

Prerje e vendosjes së pusotave

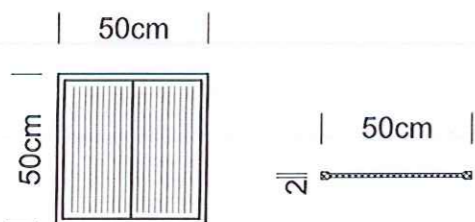
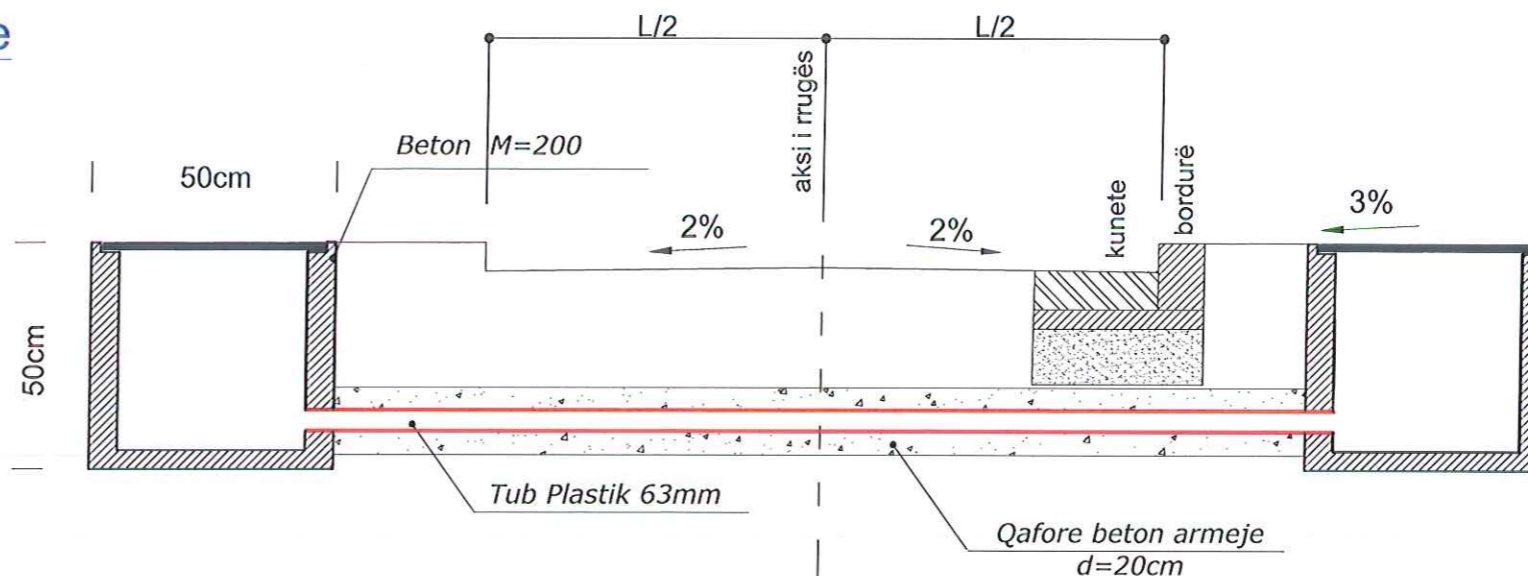

Kapaku i pusotës prej plastike

SHËNIME :

- Gjatë realizimit të intersektimeve kuota e vendosjes së pusotave mund të ndryshojë sipas rastit
- Tubi mund të vendoset me një pjerrësi të lehtë sipas nevojës , por gjithnjë thellësia minimale e vendosjes duhet te jete 50cm nga sip. e asfaltit.



 <b>POROSITESI : BASHKIA TROPOJË</b> OBJEKTI: "PROJEKT I RRUGES SE FSHATIT KASAJ, BASHKIA TROPOJË "	Emertimi: DETAJET E RRUGES <b>"ASIZSTUDIO" Sh.p.k</b> Adresa: Kompleksi Vizon Plus, Tirane.	Projektues Ing. Mentor COKAJ No. Lic. K/1451 2022-09-21 23:21:18	SHKALLA - Tropojë 2022	FLETA 10 - 02 Format A3



### Detaj i tokëzimit të shtyllës së ndriçimit

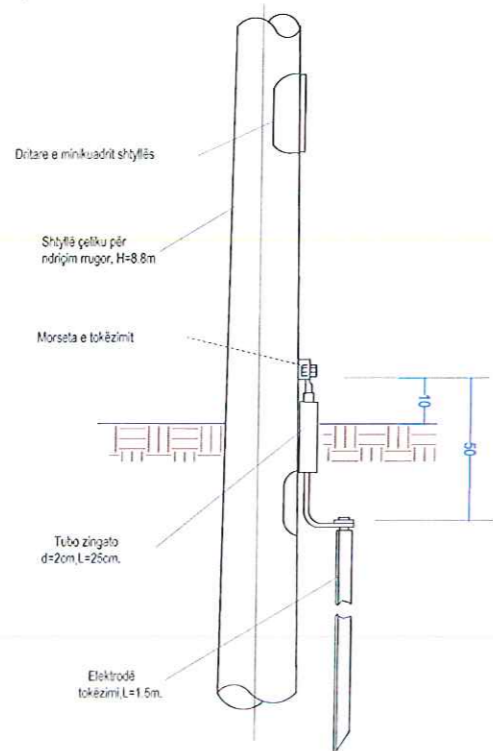

### Konstruksioni morseterisë

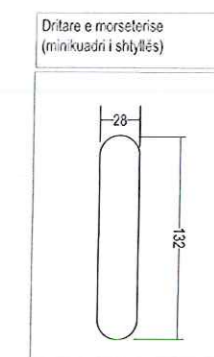
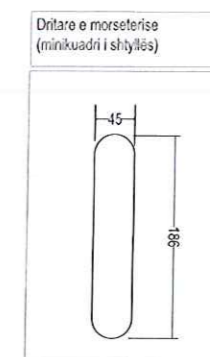
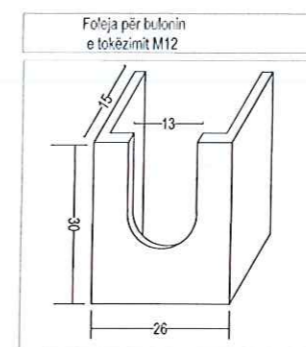
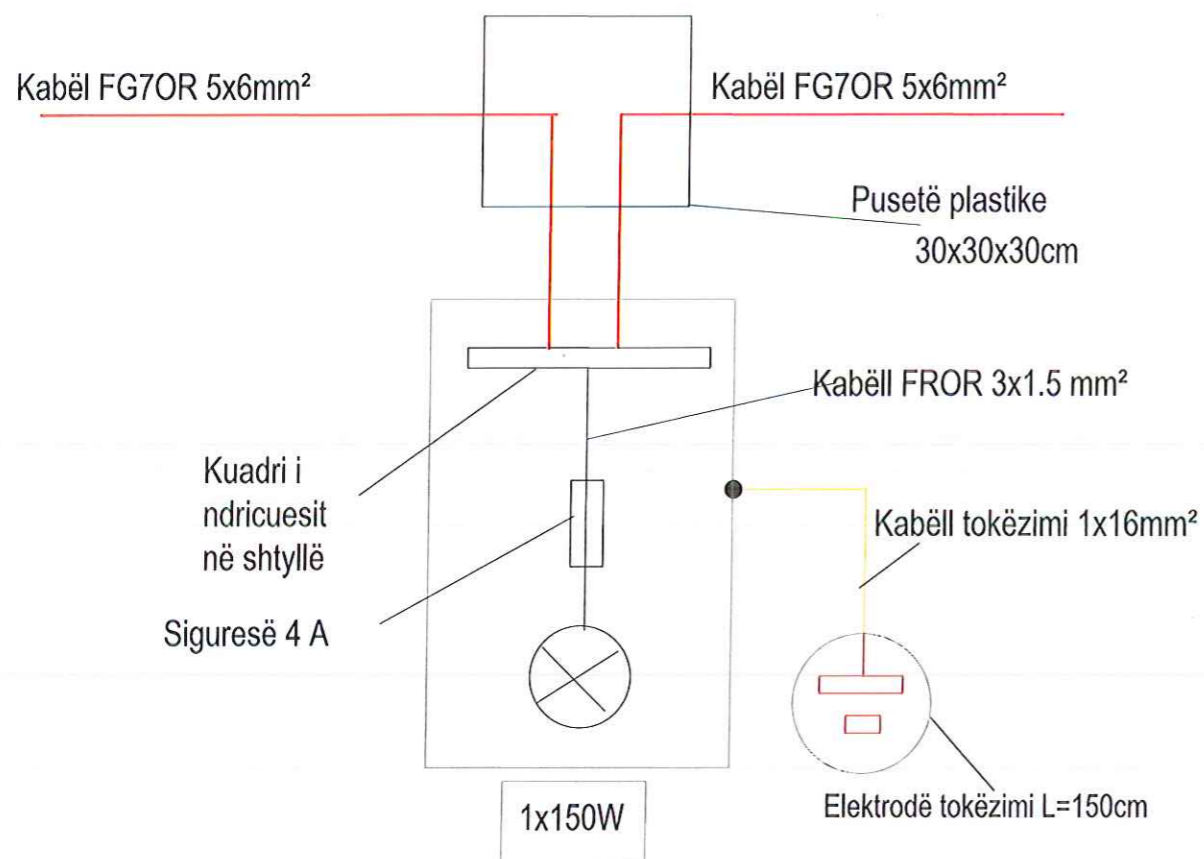
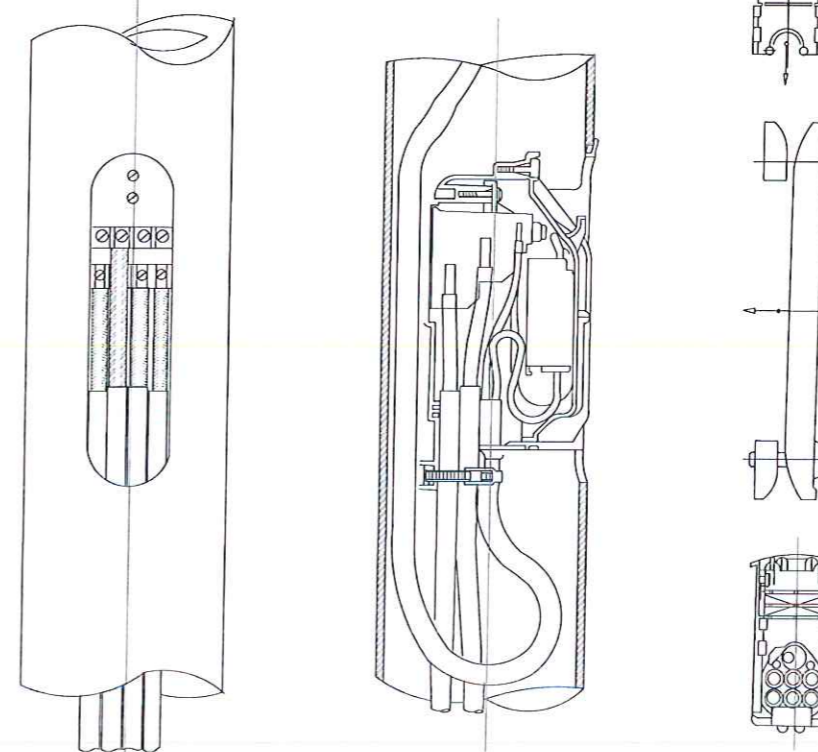

ASIZ-STUDIO  
 Ing. Mentor ÇOKAJ  
 Nr. Lic. K/1-  
 Projektues  
 Ing. Mentor ÇOKAJ  
 Mentorçokaj@yahoo.com  
 Tel: 060 21 23 318

	<b>POROSITESI : BASHKIA TROPOJË</b> OBJEKTI: "PROJEKT I RRUGES SE FSHATIT KASAJ, BASHKIA TROPOJË "	Emertimi: DETAJET E RRUGES "ASIZSTUDIO" Sh.p.k Adresa: Kompleksi Vizon Plus, Tirane.	Ing. Mentor ÇOKAJ Projektues	SHKALLA -	FLETA 10 - 03
				Tropojë 2022	Format A3

Planimetria e instalimit të rrjetit kabllor të ndriçimit,

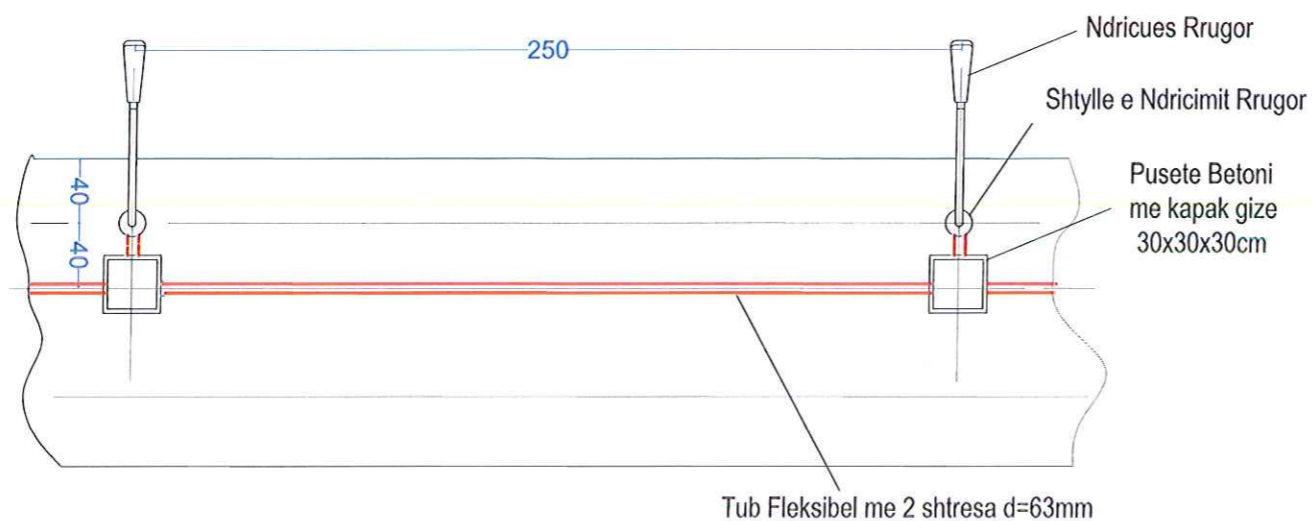

Shtrimi i kabllave te TU ne TP.direkt ne toke

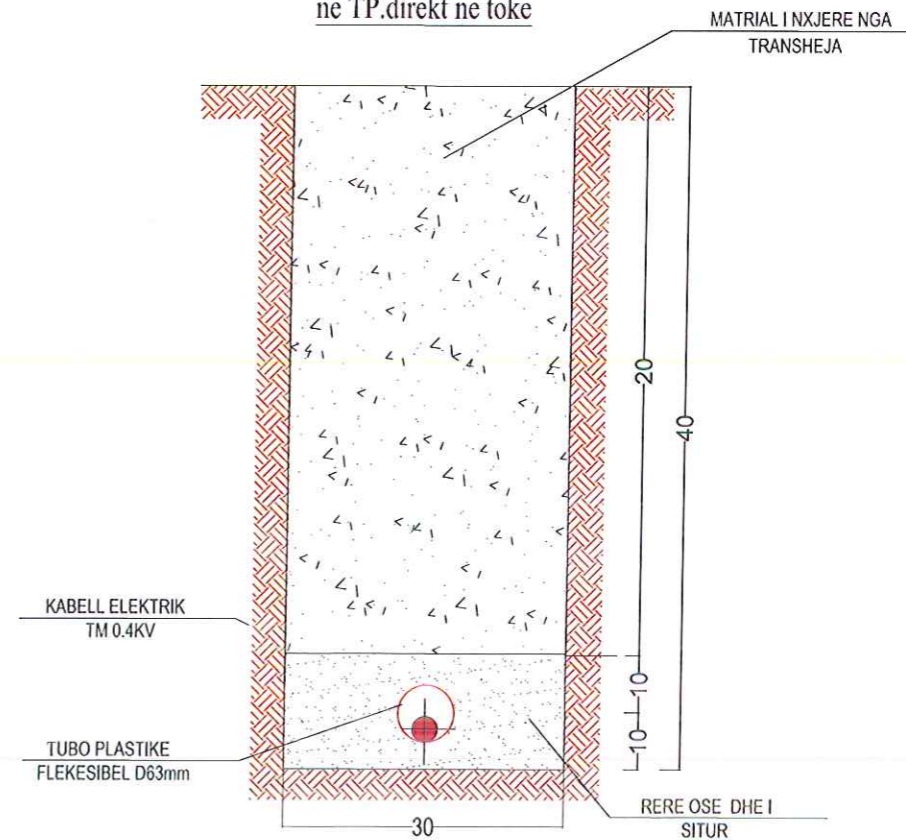

Detaj i montimit te pusetes dhe tokezimit te shtylles

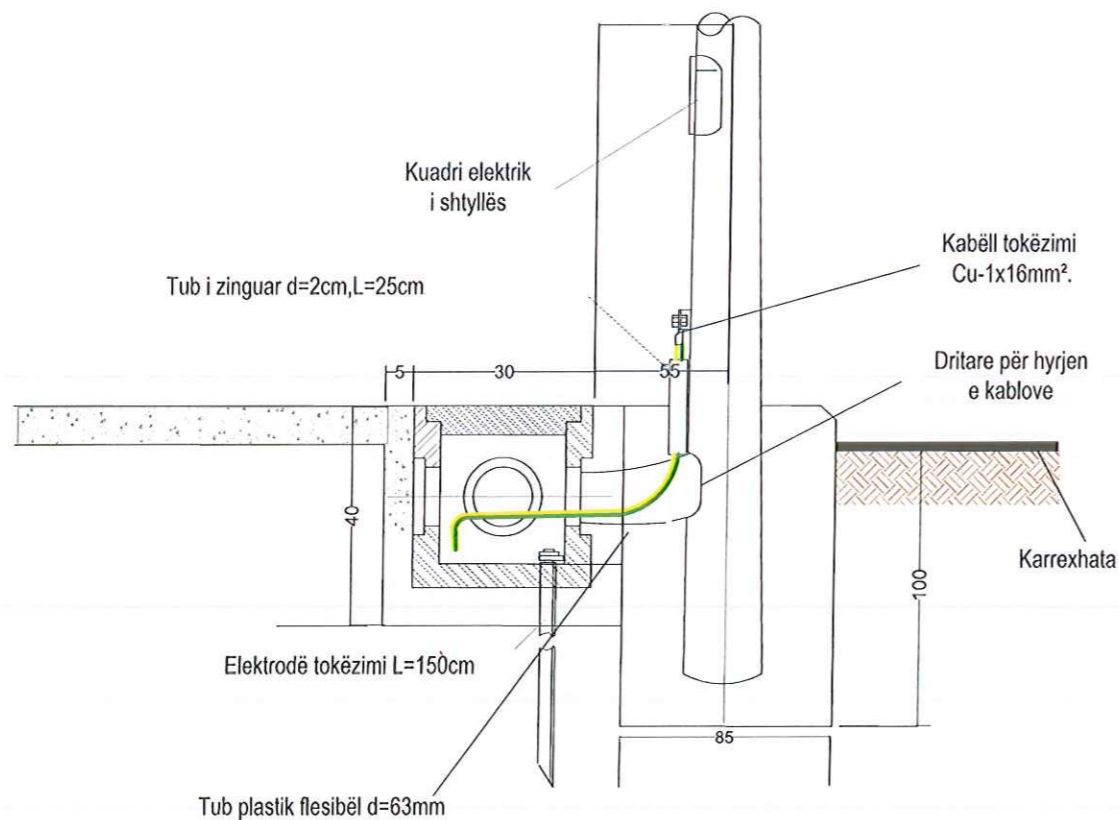

Shtrimi i kabllave te TU ne trasversimin e rrugeve

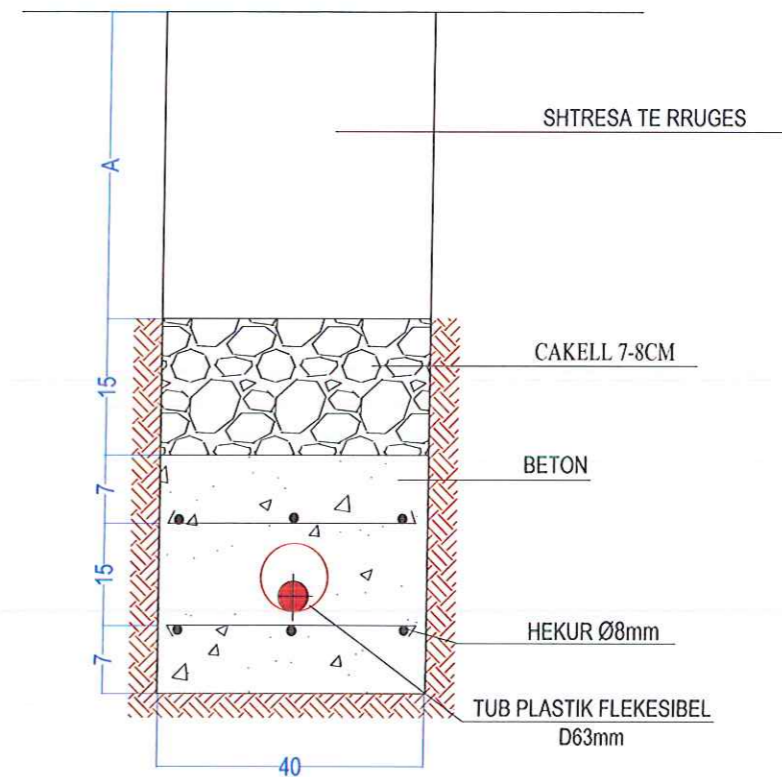

**POROSITESI : BASHKIA TROPOJË**

OBJEKTI:  
"PROJEKT I RRUGES SE FSHATIT KASAJ, BASHKIA TROPOJË "

Emertimi: DETAJET E RRUGES

"ASI2STUDIO" Sh.p.k

Adresa:  
Kompleksi Vizon Plus, Tirane.

Projektues  
Ing.Mentor COKAJ

Nr.Lic. X/14  
Ing.Mentor COKAJ - Zbatim  
Interreks.com

SHKALLA FLETA

- 10 - 04

Tropojë 2022 Format A3

# SHENJA LAJMERUESE

LAJMERIM PER NDERPRERJE NGA RRUGE DYTESORE, KTHESAT E KURBEZUARA, FEMIJET, KEMBESORET DHE PER NDALJE/DHENIE RRUGE

TREKENDESHI: E KUQE REFLEKTUESE  
 SFONDI: I ZI  
 SYMBOLI: E BARDHE REFLEKTUESE



# PERMASAT E SHENJAVE STANDARTE

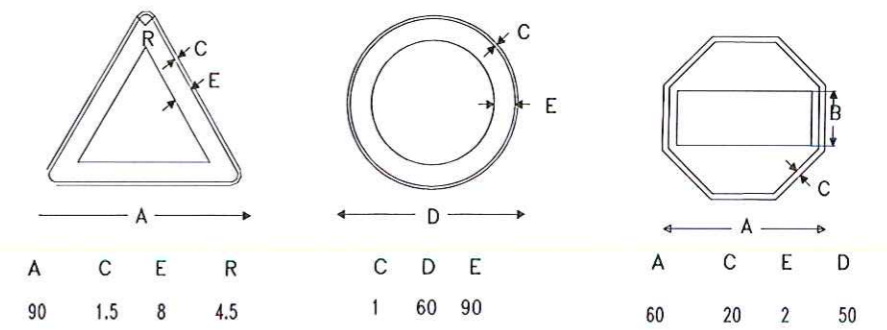

# SHENJA NDALUESE

SHENJAT PER KUFIRIN E SHPEJTESISE DHE NDALIM PARAKALIMIN

RRETHI: E KUQE REFLEKTUESE  
 SHENJA: E ZEZE REFLEKTUESE

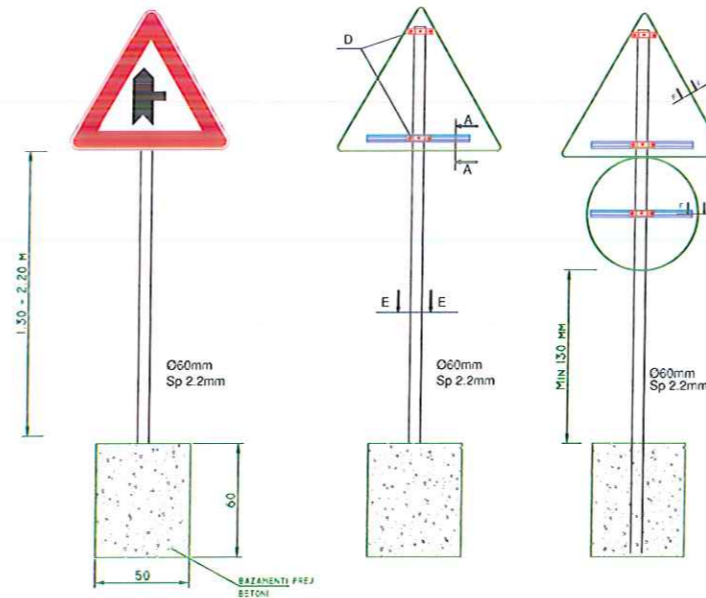

# TIPET E VIZIMEVE TE RRUGES

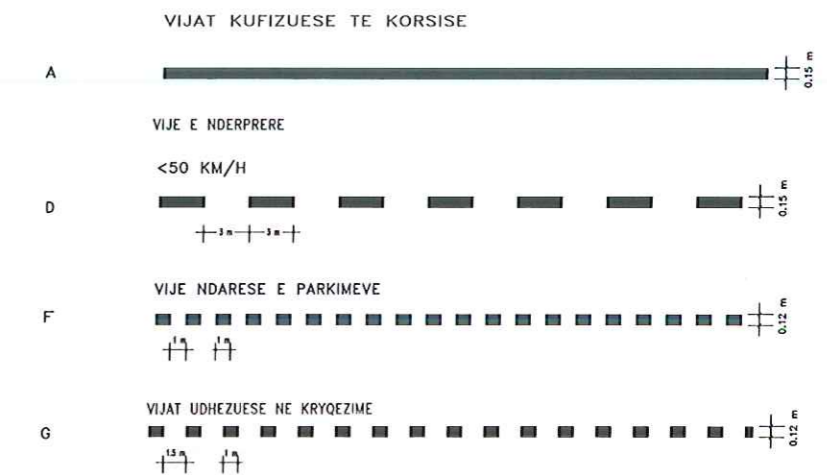

# SHENJA INFORMUESE

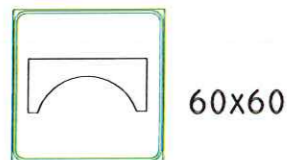

URE

**Shenim:** Shenjat rrugore per nga forma, madhesia, ngjyra reflektiviteti duhet te jene sipas Kodit Rrugor te Republikes se Shqiperise Materiali praparefektiv duhet te kete jetegjatesi 10vjet per Clasin 2 dhe 7 vjet per Clasin 1 Simboli brenda shenjes rrugore duhet te jete i realizuar me boje te trajtuar me pjekje e cila nuk humbet treguesit praparefektiv Shenja rrugore realizohet me llamarine çeliku e cila lyhet me boje opake kundrandra korozionit dhe trajtohet me pjekje.

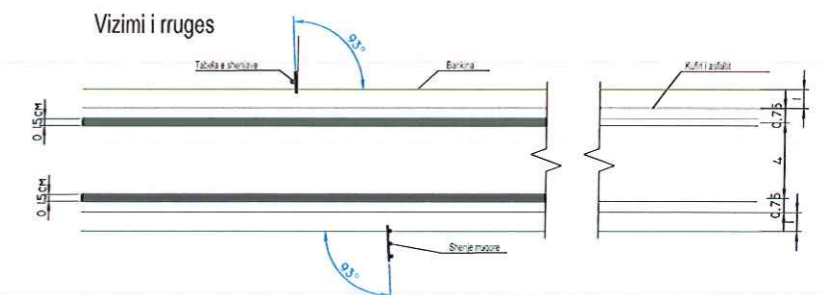
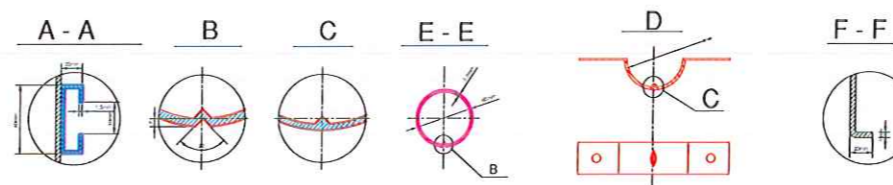

<b>POROSITESI : BASHKIA TROPOJË</b> Objekti: "Unaza e qytetit Bajram Curri, Faza e dyte"	Emertimi: DETAJET E RRUGES, SINJALISTIKA "ARABEL - STUDIO" Sh.p.k Adresa: Njesia Bashkiake nr.7, Rruga "Frosina Plaku" Pallati 21, Hyrja 1, Kati 2, Tirane. Email: arabelstudio@gmail.com	Drejtues i projektit Adm. Ana NISHKU Inxh. Ardi ARKAXHIU	Projektues Nd. Ardi ARKAXHIU Ark.Rigert HYRA Gjeo.Irfan BEGAJ	Elek. Altin ALLKAJ Top. Mustafa HOXHAI Hid. Hajredin MURGU	SHKALLA 1 - 50	FLETA 11 - 08
						Tropojë 2019

# VENDOSJA DHE MONTIMI I SHENJES RRUGORE

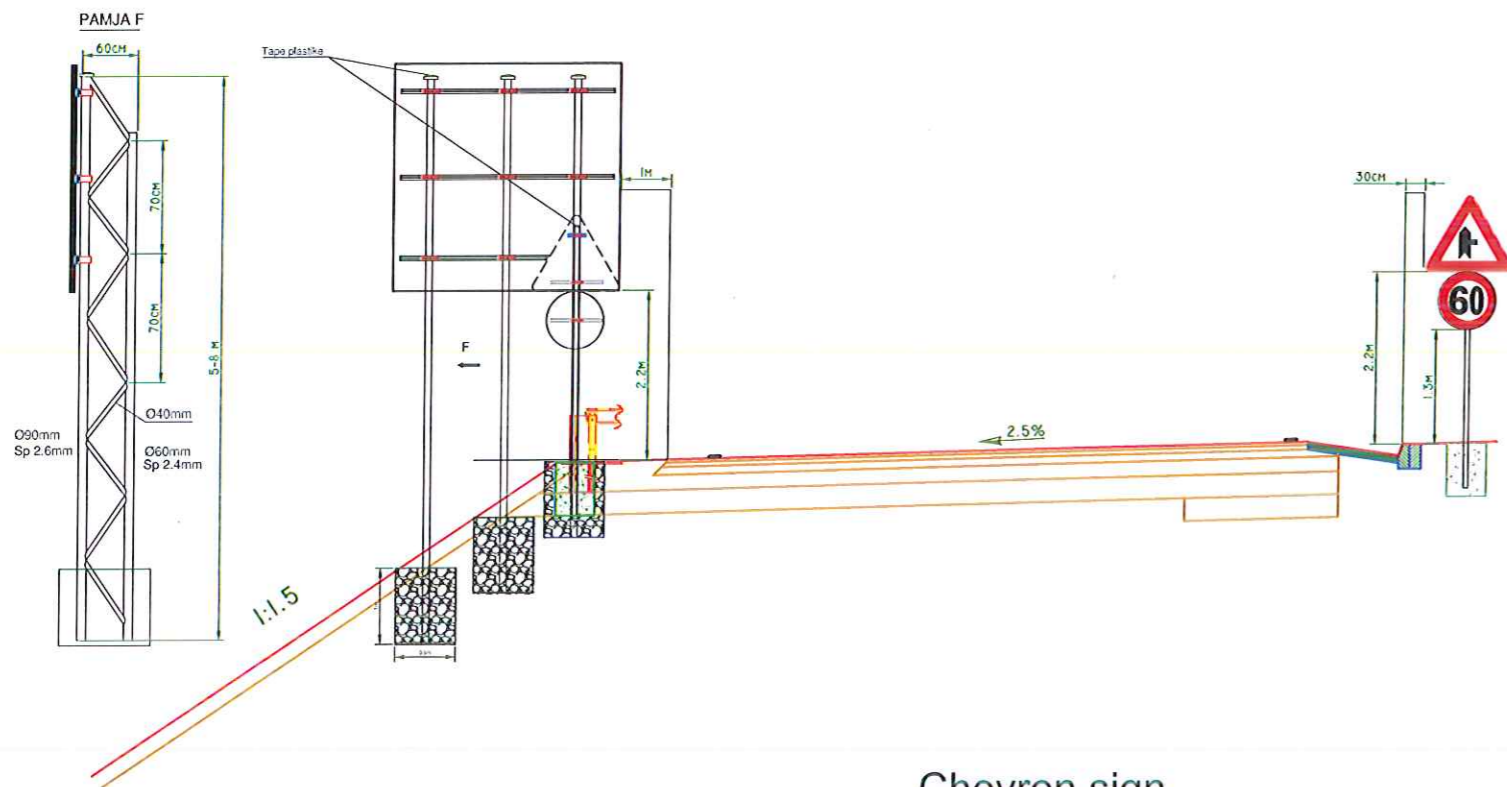

**Shenim:** Shenjat rrugore per nga forma, madhesia, ngjyra reflektiviteti duhet te jene sipas Kodit Rrugor te Republikes se Shqiperise Materiali praparefektiv duhet te kete jetegjatesi 10vjet per Clasin 2 dhe 7 vjet per Clasin 1 Simboli brenda shenjes rrugore duhet te jete i realizuar me boje te trajtuar me pjekje e cila nuk humbet treguesit praparefektiv Shenja rrugore realizohet me llamarine çeliku e cila lyhet me boje opake kundrandra korozionidhe trajtohet me pjekje. Tubat, bullonat, fashetat dhe konstruksionet mbajttese te shenjes duhet te xingohen ne te nxehte.

Chevron sign  
Kthese e menjehershme

## shenje e ishullit te trafikut

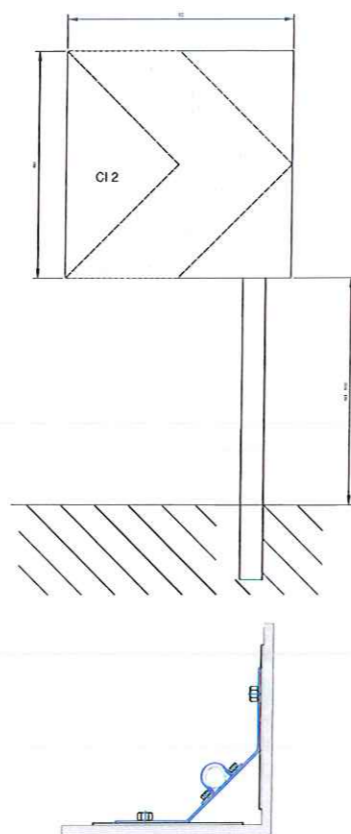
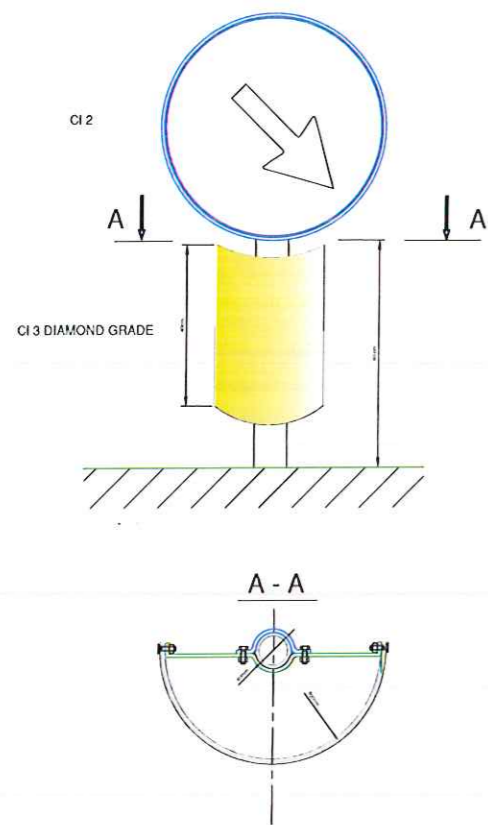

RRZAJE KTHESES	DISTANCA
100 - 200 m	20 m
200 - 400 m	30 m
> 400 m	50 m

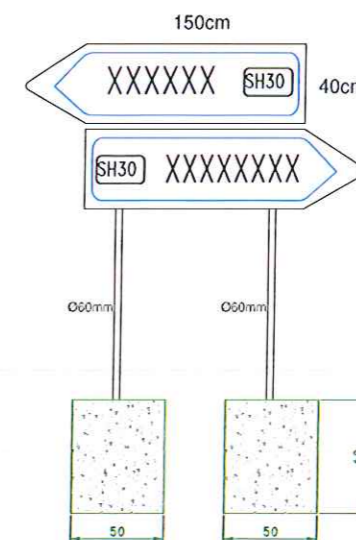
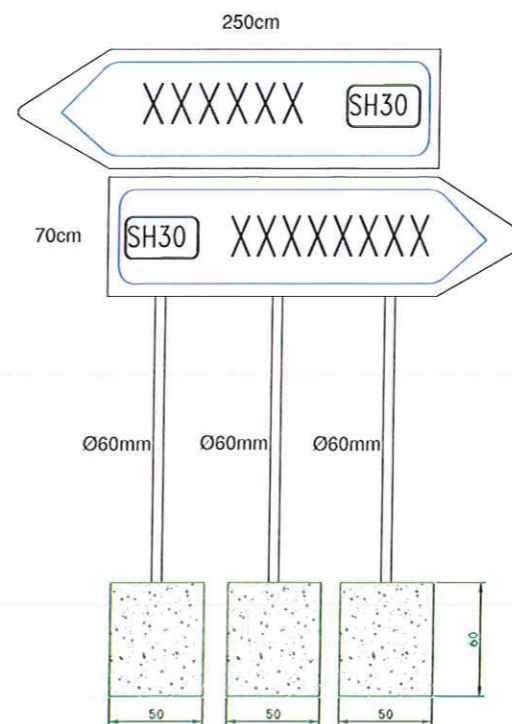

<b>POROSITESI : BASHKIA TROPOJË</b> Objekti: "Unaza e qytetit Bajram Curri, Faza e dyte"	Emertimi: DETAJET E RRUGES, SINJALISTIKA <b>"ARABEL - STUDIO" Sh.p.k</b> Adresa: Njesia Bashkiake nr.7, Rruga "Frosina Plaku" Pallati 21, Hyrja 1, Kati 2, Tirane. Email: arabelstudio@gmail.com	Drejtues i projektit Adm. Ana NISHKU Inxh. Ardi ARKAXHIU	Projektues Nd. Ardi ARKAXHIU Ark.Rigert HYRA Gjeo.Irfan BEGAJ	Elek. Altin ALLKAJ Top. Mustafa HOXHAIJ Hid. Hajredin MURGU	SHKALLA 1 - 50 Tropojë 2019	FLETA 11 - 09 Format A3
	ASIZ-STUDIO ING. MENTOR ÇOKAJ					

PLANIMETRIA E TOMBINOS D=Ø800mm (PAMJE NGA LART), Sh. 1:50

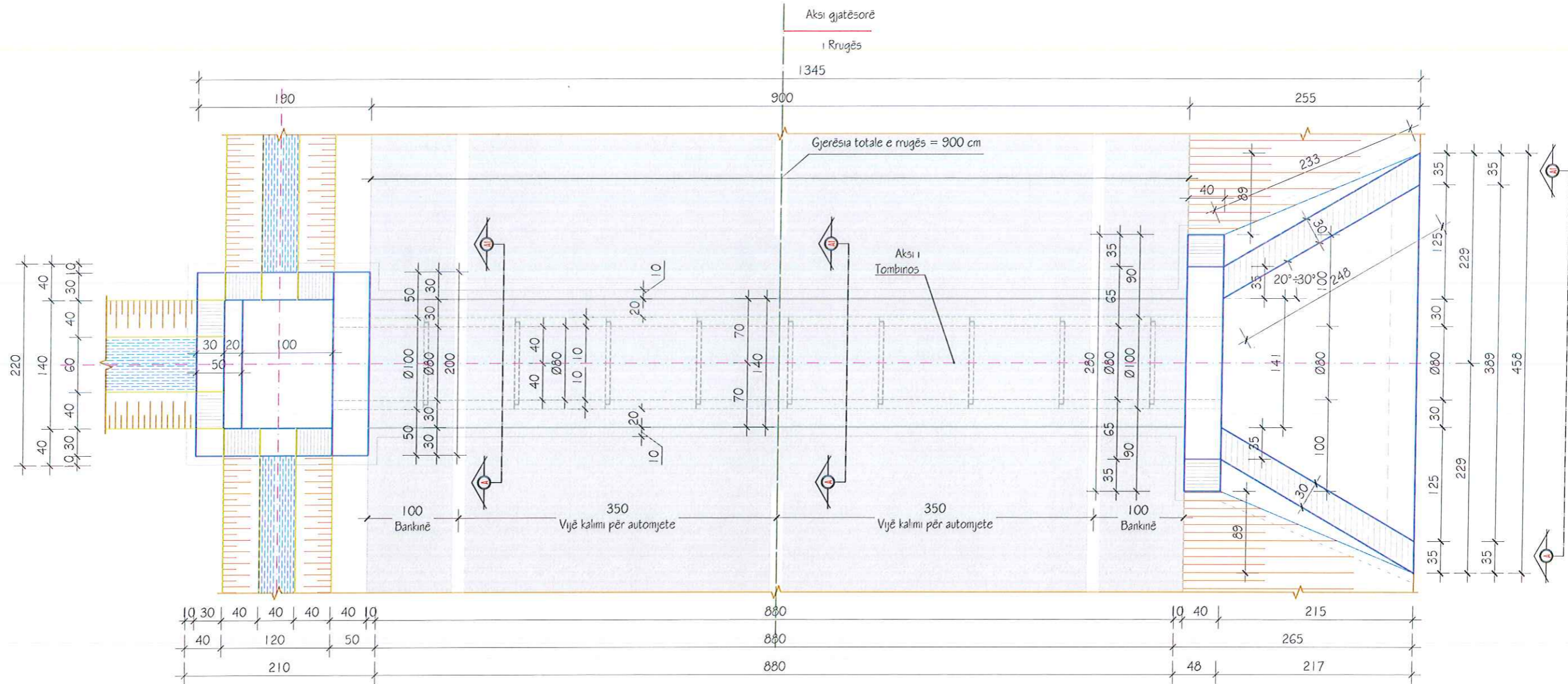

SHËNIME TEKNIKE:

1. Ky projekt i TIP Ø800mm është parashikuar për tombinot e reja që do të ndërtohen në aksin e ri të rrugës që do të rehabilitohet.
2. Përmasat e dhëna në vizatimin TIP duhet të rakordohen në vend dhe pas rakordimit vlera e përmasave duhet të jetë shumfish i 5-sës.
3. Rakordimi i pusetës në hyrje apo portali në dalje zbatohet duke u përshtatur terrenit ku ndodhet vepra dhe rakordimi i tyre do zbatohet sipas detajeve të dhëna në vizatime të veçanta.
4. Për rastin e terreneve jo të pjerrët tombinoja zbatohet në të dyja anët me portale.



**POROSITESI : BASHKIA TROPOJË**

OBJEKTI:  
"PROJEKT I RRUGES SE FSHATIT KASAJ, BASHKIA TROPOJË "

Emertimi: DETAJET E RRUGES



"ASI2STUDIO" Sh.p.k

Adresa:  
Kompleksi Vizon Plus, Tirane.



Projektues

Ing. Mentor ÇOKAJ

SHKALLA FLETA

- 10 - 05

Tropojë 2022 Format A3

PRERJA GJATËSORE NË AKSIN E TOMBINOS D=Ø800mm, Sh. 1:50

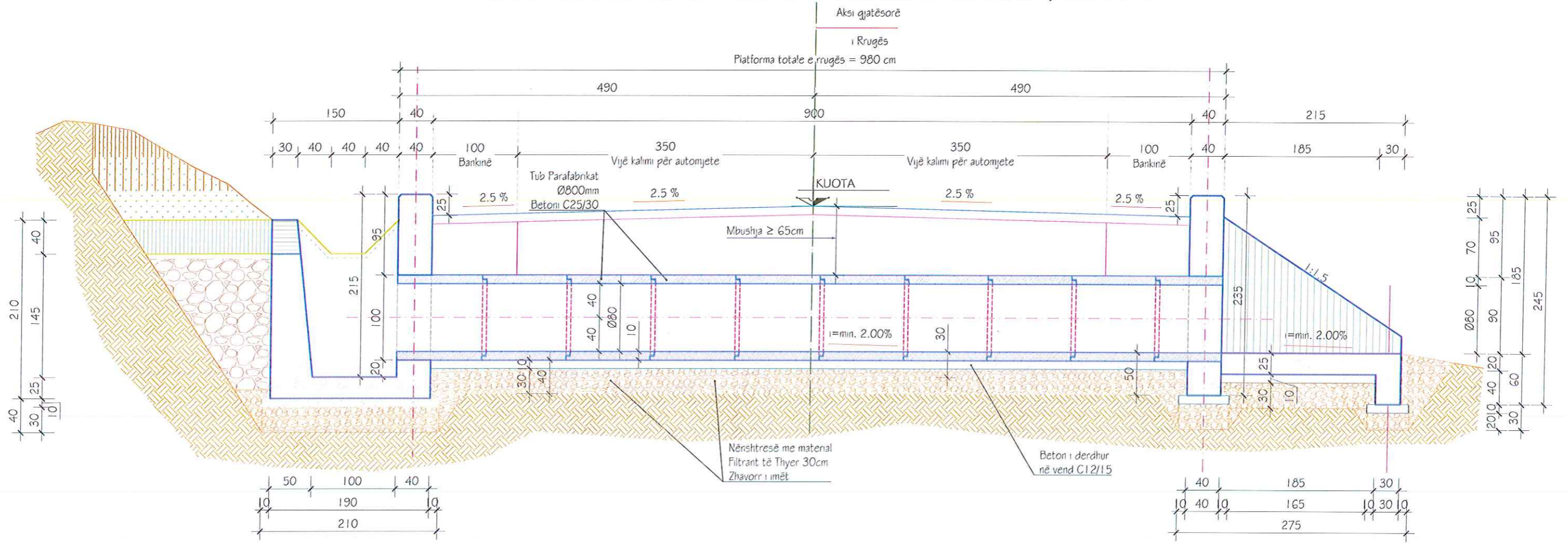

PRERJA B-B, Sh. 1:50

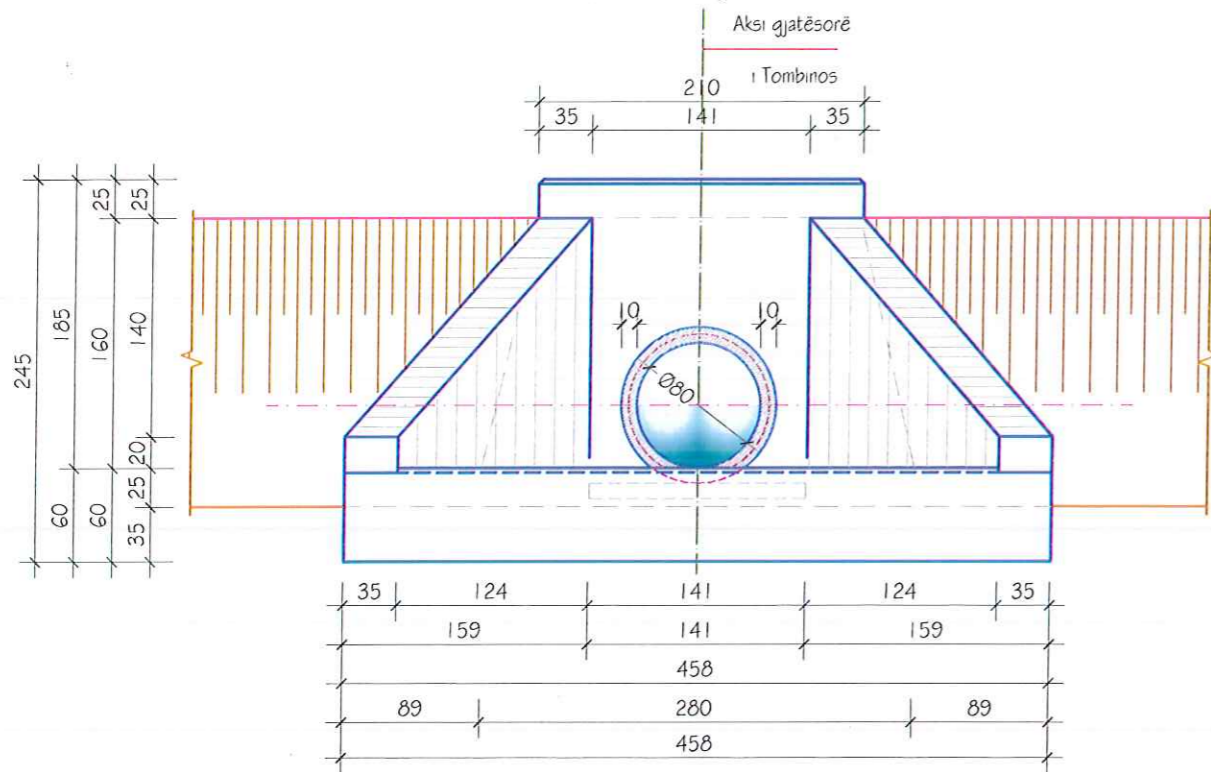

**POROSITESI : BASHKIA TROPOJË**

OBJEKTI:  
"PROJEKT I RRUGES SE FSHATIT KASAJ, BASHKIA TROPOJË"

Emertimi: DETAJET E RRUGES



"ASI2STUDIO" Sh.p.k

Adresa:  
Kompleksi Vizon Plus, Tirane.



Ing. Mentor ÇOKAJ

Projektues

SHKALLA FLETA

- 10 - 06

Tiranië 2022 Format A3

PLANIMETRIA E TOMBINOS (PAMJE NGA LART) D=Ø800mm  
PORTAL I DREJTË, Sh. 1:50

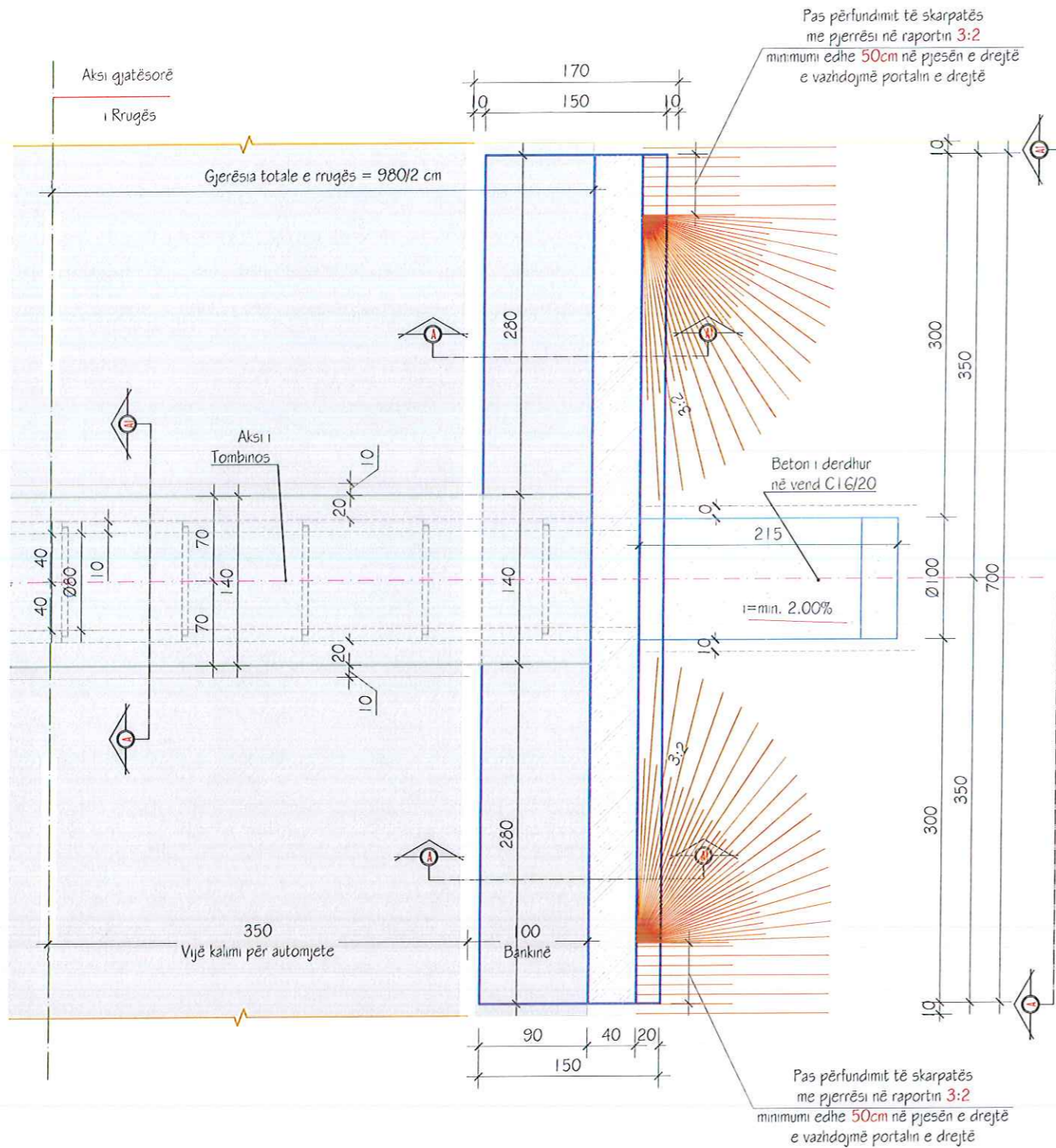

PRERJA GJATËSORE NË AKSIN E TOMBINOS D=Ø800mm  
PORTAL I DREJTË, Sh. 1:50

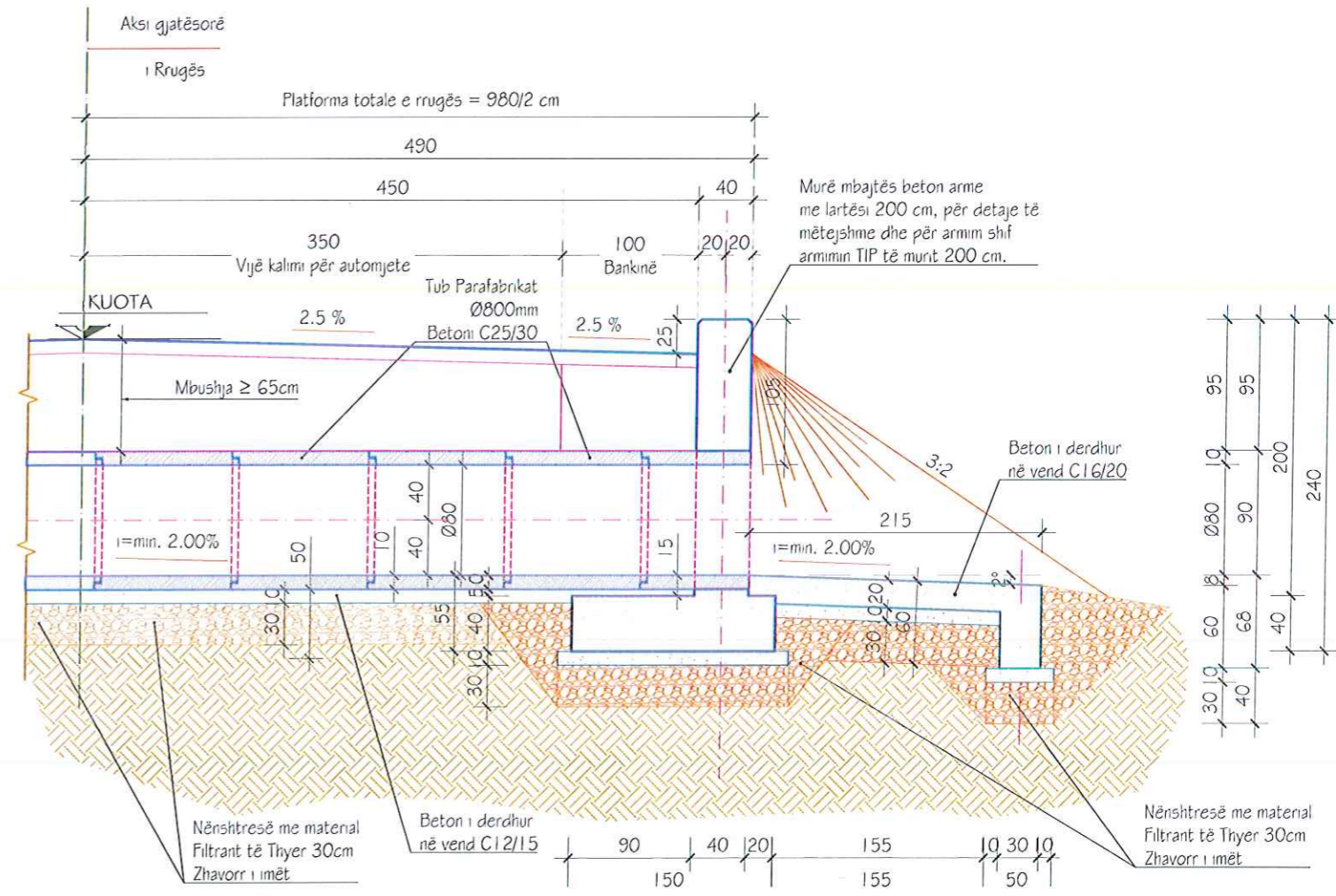

PRERJA B-B, Sh. 1:50

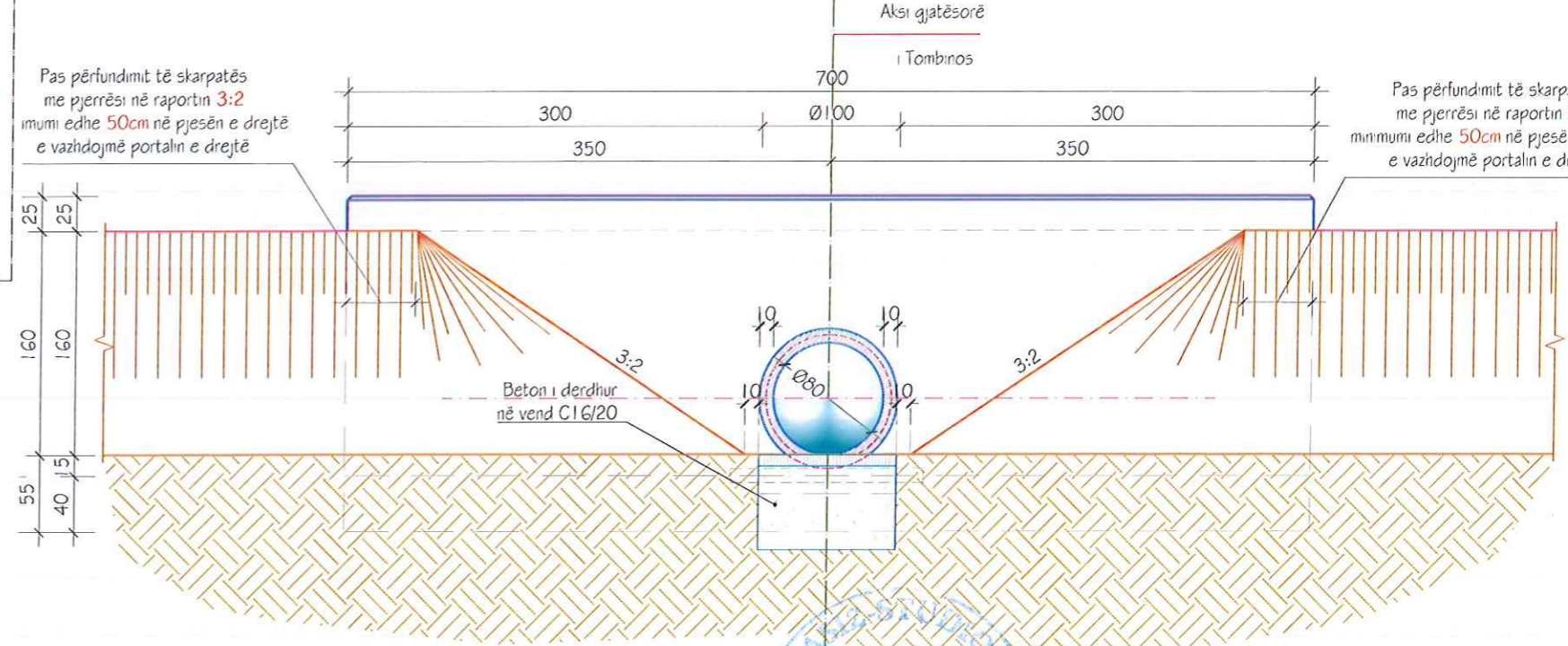

**POROSITESI : BASHKIA TROPOJË**  
OBJEKTI:  
"PROJEKT I RRUGES SE FSHATIT KASAJ, BASHKIA TROPOJË "

Emertimi: DETAJET E RRUGES  
"ASI2STUDIO" Sh.p.k  
Adresa:  
Kompleksi Vizion Plus, Tirane.

Ing. MENTOR ÇOKAJ  
Nr. Projektues  
Projekimi - Zbatimi  
mentor@yaho.com

SHKALLA	FLETA
-	10 - 07
Troncië 2022	Format A3

PRERJA C-C, Sh. 1:50

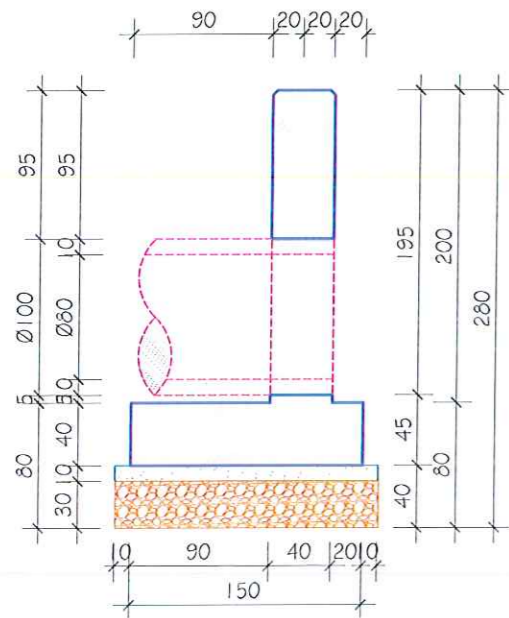

PRERJA A-A, Sh. 1:50

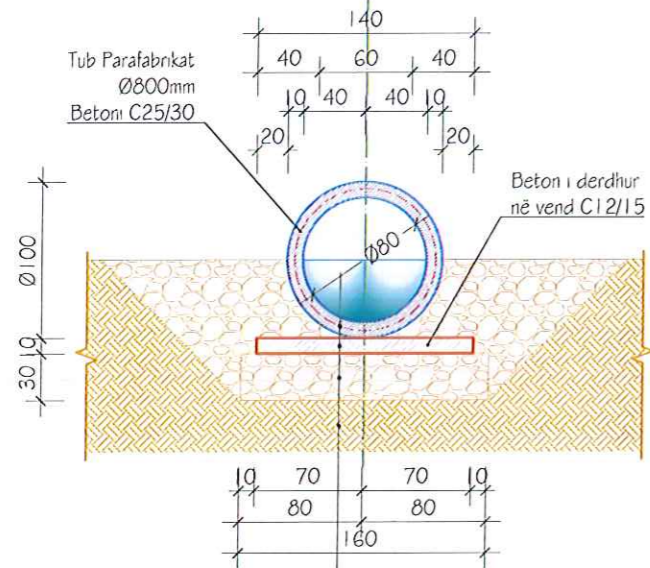

Tombino Ø800mm	- t=10 cm
Beton C12/15	- t=10 cm
Zhavorr i imët	- t=30 cm
Tokë natyrale	

ARMIMI I TUBIT D=80cm, SH.1:25

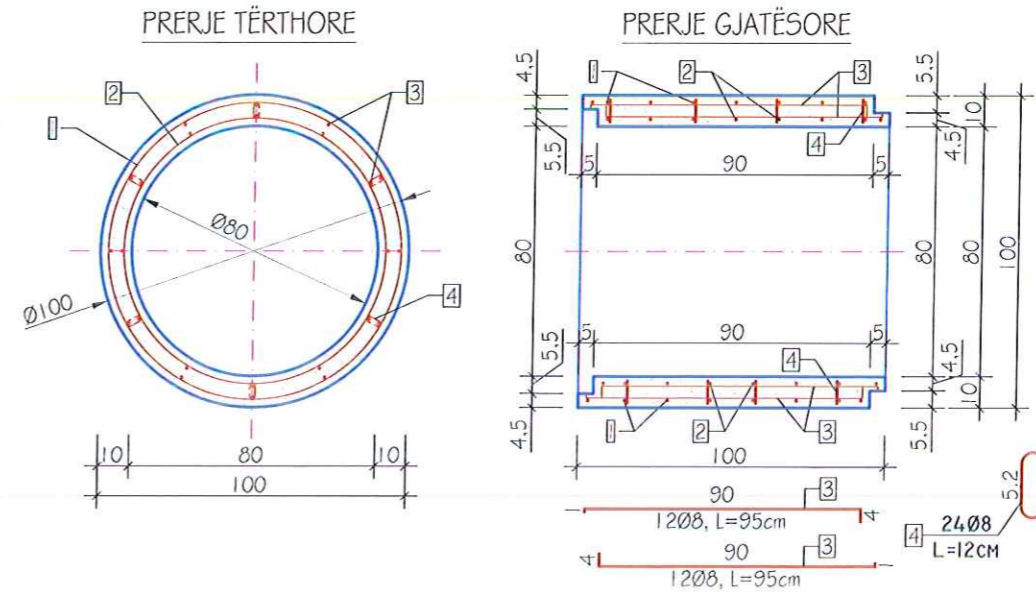

ARMATURA SPIRALE PER D=80cm

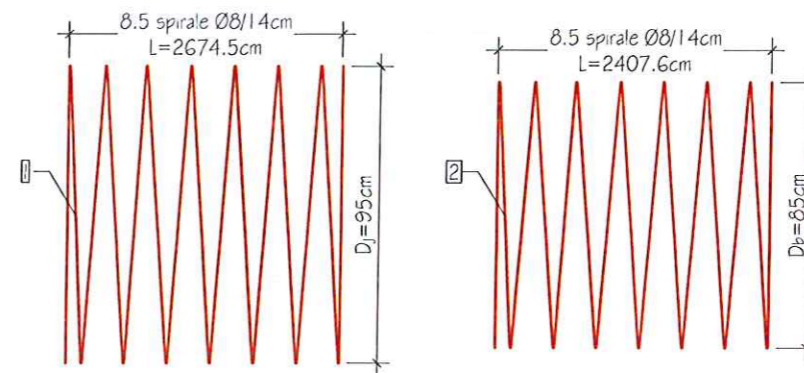

SHËNIM:  
HEKURI B500  
BETONI C25/30



## POROSITESI : BASHKIA TROPOJË

OBJEKTI:  
"PROJEKT I RRUGES SE FSHATIT KASAJ, BASHKIA TROPOJË "

Emertimi: DETAJET E RRUGES



"ASI2STUDIO" Sh.p.k

Adresa:  
Kompleksi Vizon Plus, Tirane.

Ing.Mentor COKAJ



Projektues

SHKALLA FLETA

- 10 - 08

Tropojë 2022 Format A3



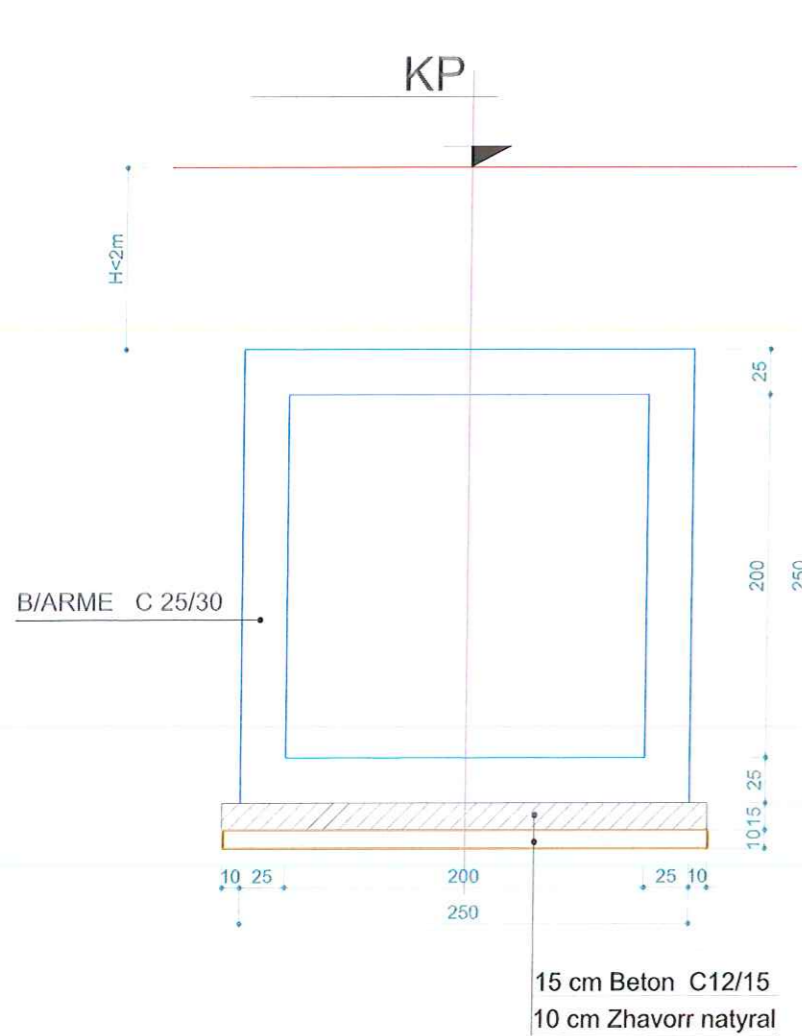

**MATERIALET**

TOMBINO KUTI : B/ARME C 25/30

THEMELI : BETON C 12/15

HEKURI : S500

SHTRESA MBROJTESE 5 cm

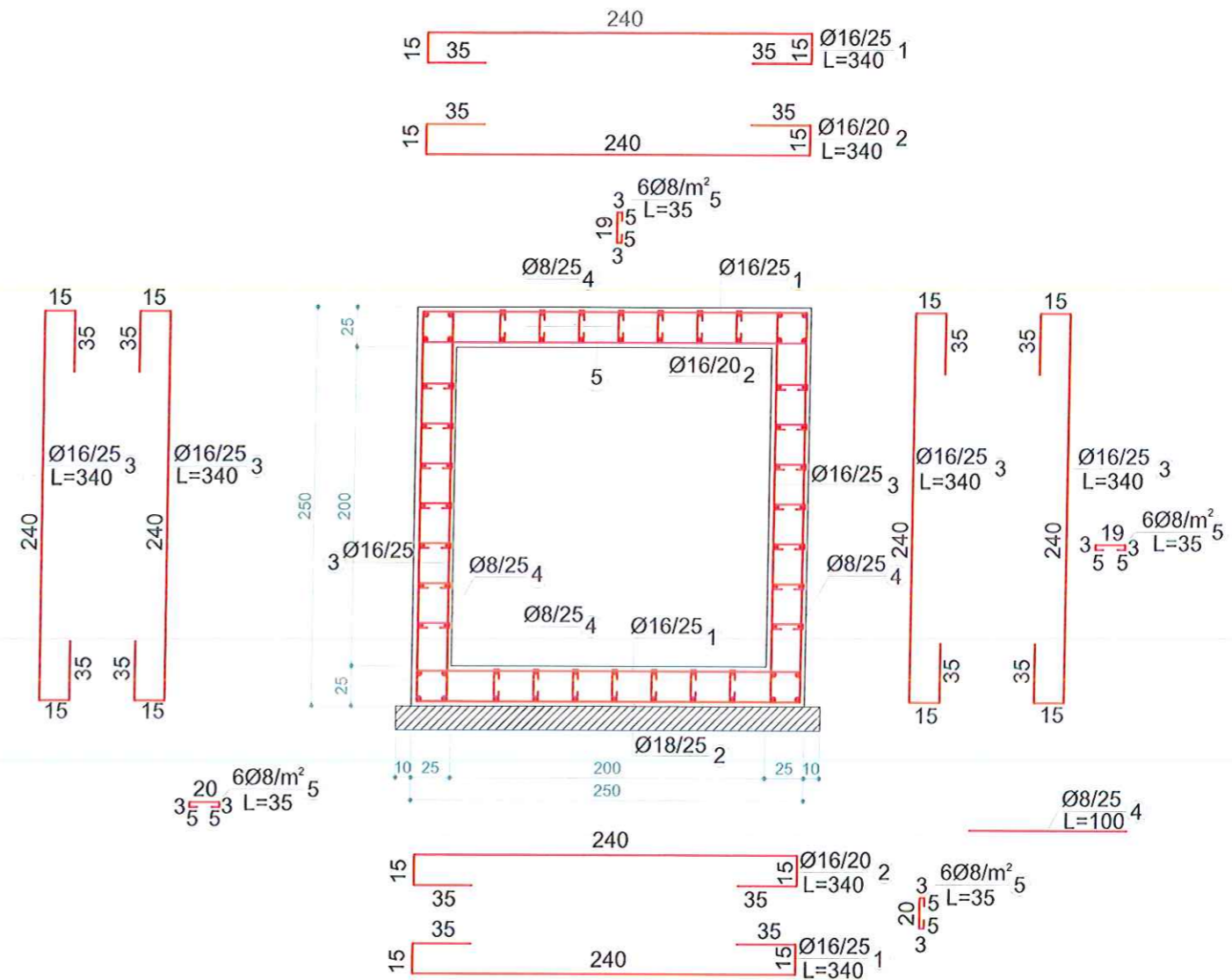

**TABELA E HEKURIT**

BOX 2X2M (PER 1ML)									
Lloji	Sasia	Poz	d	l(cm)	cope	l(m)	Pesha/nj (kg/ml)	Pesha (kg)	TOTALI (kg)
PRERJA a-a	1	1	16	340	8	27.2	1.578	42.93	42.93
		2	16	340	10	34	1.578	53.66	53.66
		3	16	340	16	54.4	1.578	85.86	85.86
		4	20	495	16	79.2	2.466	195.32	195.32
		5	20	495	48	237.6	2.466	585.96	585.96
SHUMA TOTALE (kg)									963.73



**POROSITESI : BASHKIA TROPOJË**

OBJEKTI:  
"PROJEKT I RRUGES SE FSHATIT KASAJ, BASHKIA TROPOJË "

Emertimi: DETAJET E RRUGES

"ASI2STUDIO" Sh.p.k

Adresa:  
Kompleksi Vizon Plus, Tirane.

Ing.Mentor COKAJ

Projektohet nga: Projektues

Projektim - Zbatim

mentor.cokaj@yahoo.com

069 21 23 212

SHKALLA FLETA

- 10 - 09

Tropojë 2022 Format A3

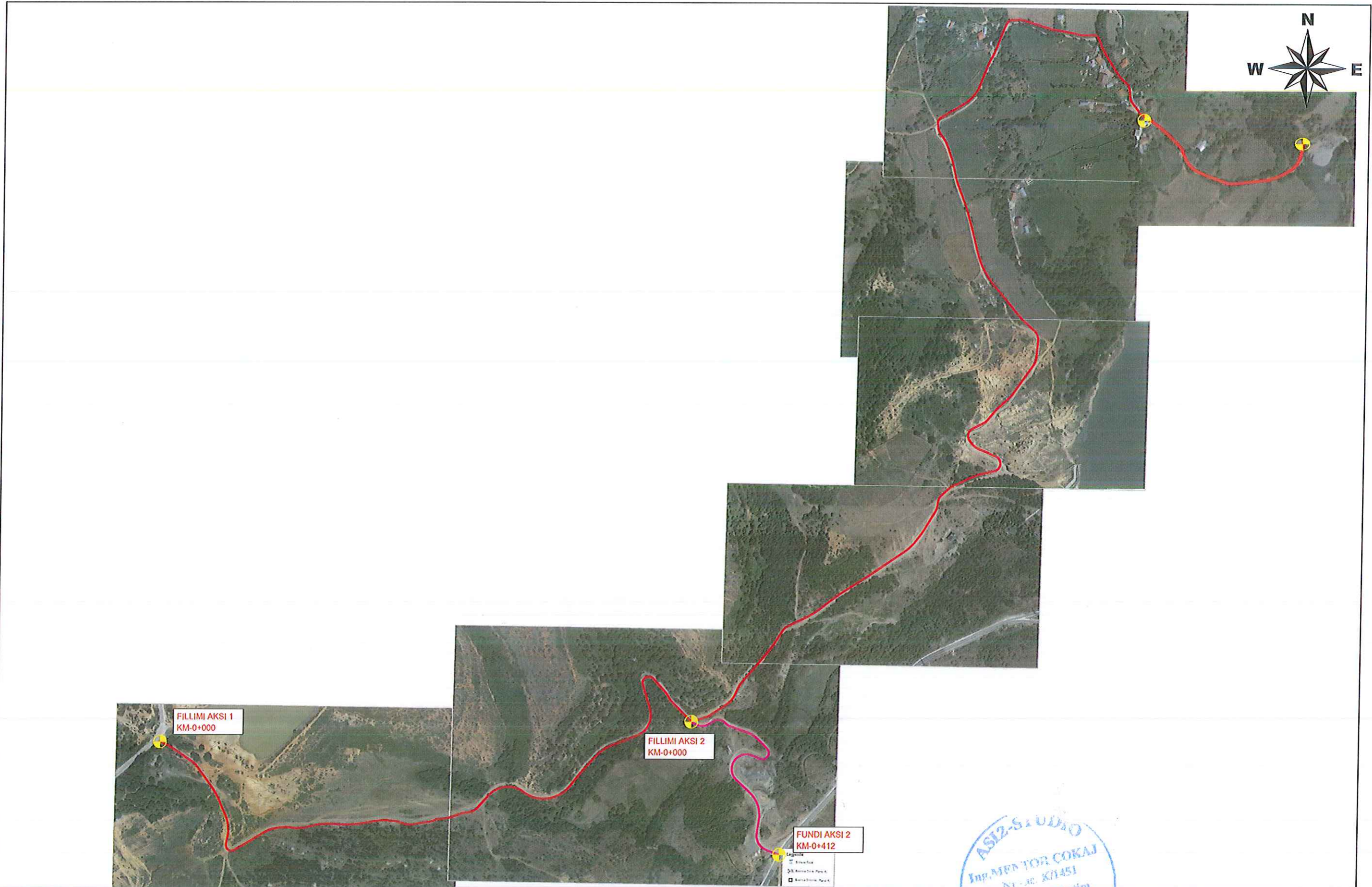

**POROSITESI : BASHKIA TROPOJË**

OBJEKTI:  
"PROJEKT I RRUGES SE FSHATIT KASAJ, BASHKIA TROPOJË "

Emertimi: 1.HOROGRAFIA

"ASI2STUDIO" Sh.p.k

Adresa:  
Kompleksi Vizon Plus, Tirane.

Ing.Mentor COKAJ



Projektues

SHKALLA FLETA

1 : 1000 1- 01

Tropojë 2022 Formati A3