

- Seksioni: 37  
 - Progresivi: 0+900.00  
 - Shkalla e vizatimit: 200.000  
 - Kuota reference: 465.00

- Shtres Asfaltobteon: 4cm  
 - Shtres binderi : 6cm  
 - Shtrese Stabilizanti: 15cm  
 - Cakull mbeturina kave: 20cm  
 - Siperfaqe Germim: 3.44m<sup>3</sup>

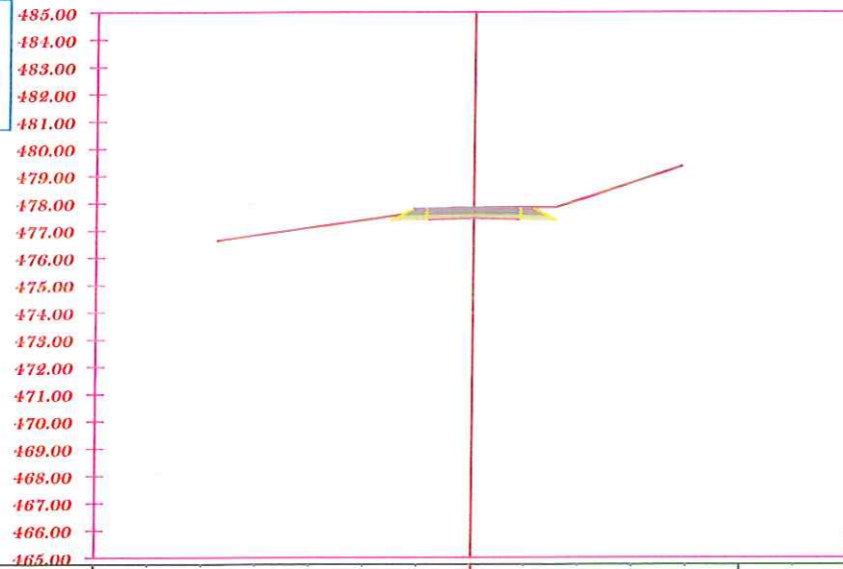

DISTANCA PARC. [m]	0.00	0.00	0.00	0.00	0.00	0.00	0.00	0.00	0.00
KUOTA TOKES [m]	476.85	477.12	477.39	477.67	477.84	477.84	478.14	478.79	
KUOTA FAKTIKE [m]	476.85	477.12	477.39	477.67	477.84	477.84	478.14	478.79	
KUOTA PROJEKTIT [m]	476.85	477.12	477.39	477.67	477.84	477.84	478.14	478.79	

- Seksioni: 38  
 - Progresivi: 0+925.00  
 - Shkalla e vizatimit: 200.000  
 - Kuota reference: 467.00

- Shtres Asfaltobteon: 4cm  
 - Shtres binderi : 6cm  
 - Shtrese Stabilizanti: 15cm  
 - Cakull mbeturina kave: 20cm  
 - Siperfaqe Germim: 3.01m<sup>3</sup>

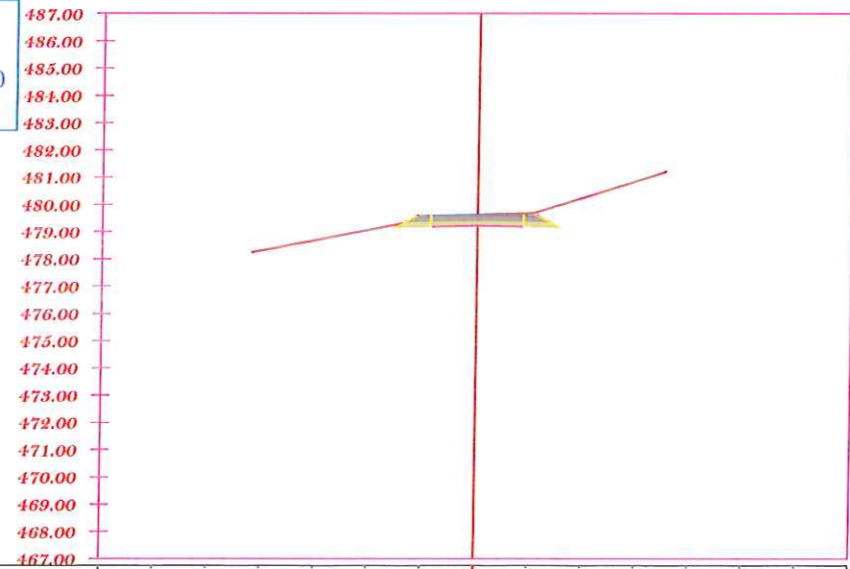

DISTANCA PARC. [m]	0.00	0.00	0.00	0.00	0.00	0.00	0.00	0.00	0.00
KUOTA TOKES [m]	478.32	478.70	479.08	479.46	479.63	479.68	480.26	480.87	
KUOTA FAKTIKE [m]	478.32	478.70	479.08	479.46	479.63	479.68	480.26	480.87	
KUOTA PROJEKTIT [m]	478.32	478.70	479.08	479.46	479.63	479.68	480.26	480.87	

 POROSITESI: Bashkia Tropojë	Objekti:	 "LAND POINT-AL " Rruga Xhemal Tafaj, Ndertesa nr 5	PROJEKTOI Projektues Ing. Mentor Cokaj	 SHKALLA 1 : 250 Tiranë 2022	FLETA F - 19 Format A3
	Studim Projektim Rrugët Rurale Segmenti "Rruga Bylbyl Breçani"				

- Seksioni: 39  
 - Progresivi: 0+950.00  
 - Shkalla e vizatimit: 200.000  
 - Kuota reference: 469.00

- Shtres Asfaltobton: 4cm  
 - Shtres binderi : 6cm  
 - Shtrese Stabilizanti: 15cm  
 - Cakull mbeturina kave: 20cm  
 - Siperfaqe Germim: 3.21m<sup>3</sup>

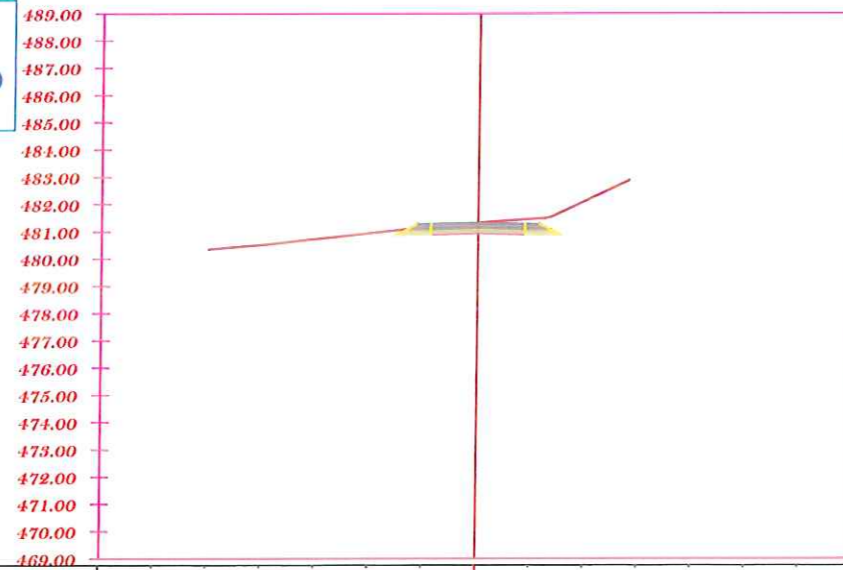



DISTANCA PARC. [m]	0.00	0.00	0.00	0.00	0.00	0.00	0.00
KUOTA TOKES [m]	480.34	480.51	480.72	480.94	481.16	481.32	481.45
KUOTA FAKTIKE [m]	480.34	480.51	480.72	480.94	481.16	481.32	481.45
KUOTA PROJEKTIT [m]	480.34	480.51	480.72	480.94	481.16	481.32	481.45

- Seksioni: 40  
 - Progresivi: 0+975.00  
 - Shkalla e vizatimit: 200.000  
 - Kuota reference: 470.00

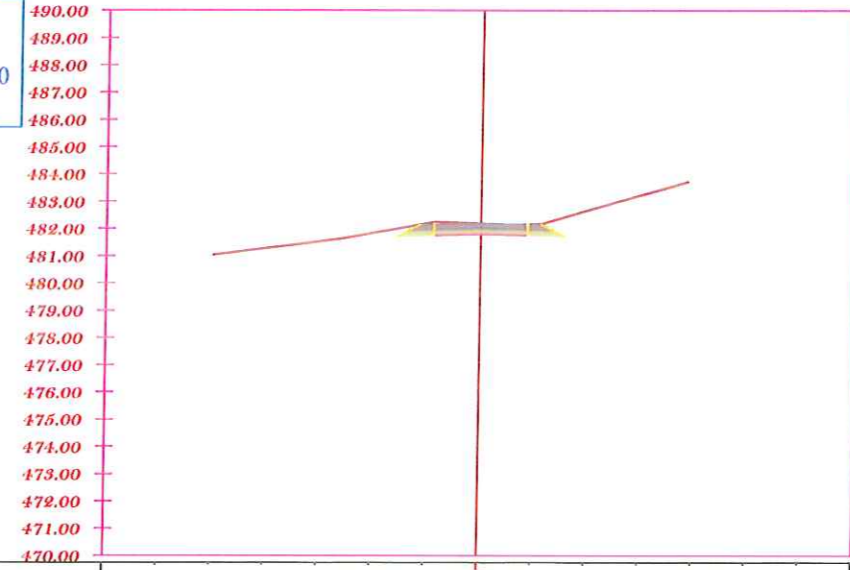
- Shtres Asfaltobton: 4cm  
 - Shtres binderi : 6cm  
 - Shtrese Stabilizanti: 15cm  
 - Cakull mbeturina kave: 20cm  
 - Siperfaqe Germim: 3.22m<sup>3</sup>



DISTANCA PARC. [m]	0.00	0.00	0.00	0.00	0.00	0.00	0.00
KUOTA TOKES [m]	481.04	481.29	481.53	481.84	482.19	482.19	482.17
KUOTA FAKTIKE [m]	481.04	481.29	481.53	481.84	482.19	482.19	482.17
KUOTA PROJEKTIT [m]	481.04	481.29	481.53	481.84	482.19	482.19	482.17

 POROSITESI: Bashkia Tropojë	Objekti:	 "LAND POINT-AL " Rruga Xhemal Tafaj; Ndertesa nr 5	Projektues Ing. Mentor Cokaj	SHKALLA	FLETA
	Studim Projektim Rrugët Rurale Segmenti "Rruga Bylbyl Breçani"			1 : 250	F - 20
				Tiranë 2022	Format A3



- Seksioni: 41  
 - Progresivi: 1+000.00  
 - Shkalla e vizatimit: 200.000  
 - Kuota reference: 470.00

- Shtres Asfaltbeton: 4cm  
 - Shtres binderi : 6cm  
 - Shtrese Stabilizanti: 15cm  
 - Cakull mbeturina kave: 20cm  
 - Siperfaqe Germim: 3.32m<sup>3</sup>

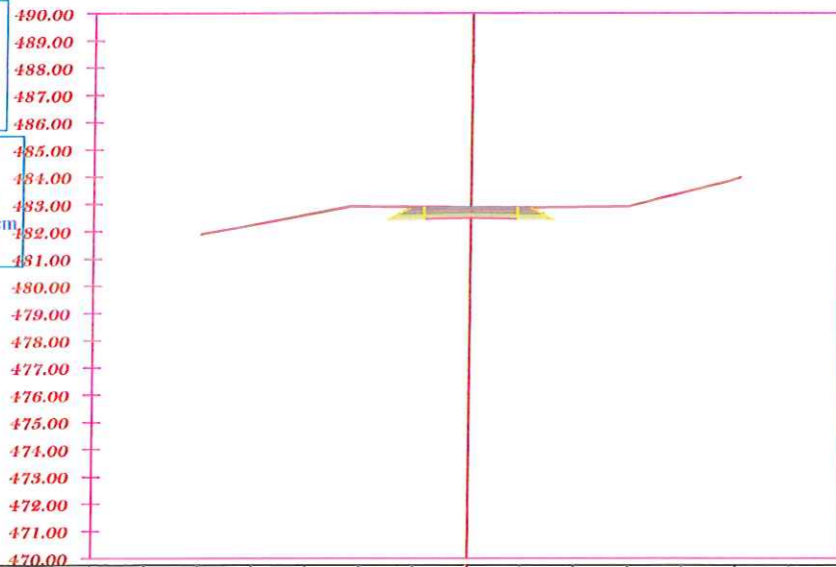

DISTANCA PARC. [m]	0.00	0.00	0.00	0.00	0.00	0.00	0.00	0.00	0.00	0.00
KUOTA TOKES [m]	481.90	481.90	482.26	482.64	482.92	482.91	482.96	482.89	482.90	482.96
KUOTA FAKTIKE [m]	481.90	482.26	482.64	482.92	482.91	482.96	482.89	482.90	482.96	482.96
KUOTA PROJEKTIT [m]	481.90	482.26	482.64	482.92	482.91	482.96	482.89	482.90	482.96	482.96

- Seksioni: 42  
 - Progresivi: 1+025.00  
 - Shkalla e vizatimit: 200.000  
 - Kuota reference: 472.00

- Shtres Asfaltbeton: 4cm  
 - Shtres binderi : 6cm  
 - Shtrese Stabilizanti: 15cm  
 - Cakull mbeturina kave: 20cm  
 - Siperfaqe Germim: 3.33m<sup>3</sup>

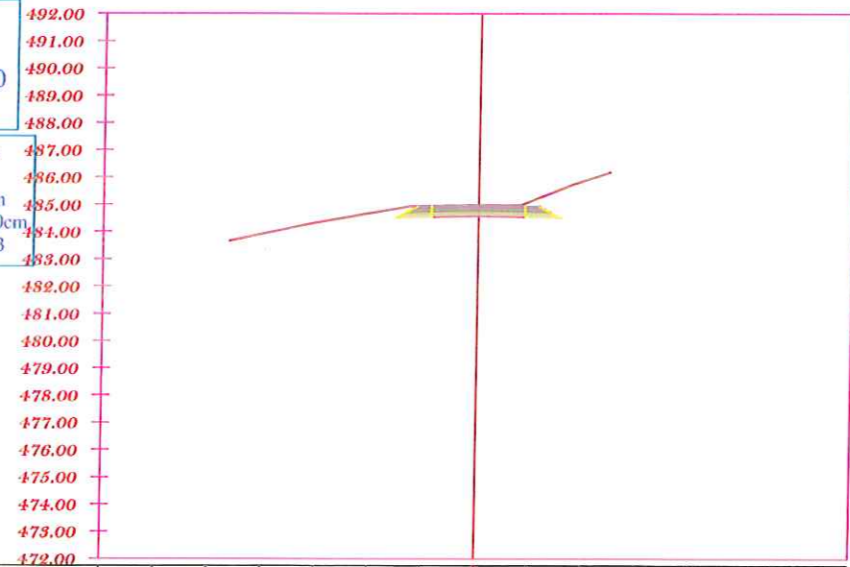

DISTANCA PARC. [m]	0.00	0.00	0.00	0.00	0.00	0.00	0.00	0.00	0.00	0.00
KUOTA TOKES [m]	483.95	484.36	484.70	484.95	484.98	484.98	484.98	484.98	484.98	484.98
KUOTA FAKTIKE [m]	483.95	484.36	484.70	484.95	484.98	484.98	484.98	484.98	484.98	484.98
KUOTA PROJEKTIT [m]	483.95	484.36	484.70	484.95	484.98	484.98	484.98	484.98	484.98	484.98



Objekti:  
 Studim Projektim Rrugët Rurale  
 Segmenti "Rruga Bylbyl Breçani"



PROJEKTOI  
 "LAND POINT-AL "  
 Rruga Xhemal Tafaj;  
 Ndertesna nr 5

Projektues:  
 Ing. Mentor Cokaj



SHKALLA  
 1 : 250  
 Tiranë 2022

FLETA  
 F - 21  
 Format A3

- Seksioni: 43  
 - Progresivi: 1+050.00  
 - Shkalla e vizatimit: 200.000  
 - Kuota reference: 475.00

- Shtreses Asfaltobeton: 4cm  
 - Shtreses binderi : 6cm  
 - Shtresese Stabilizanti: 15cm  
 - Cakull mbeturina kave: 20cm  
 - Siperfaqe Germim: 3.36m<sup>3</sup>

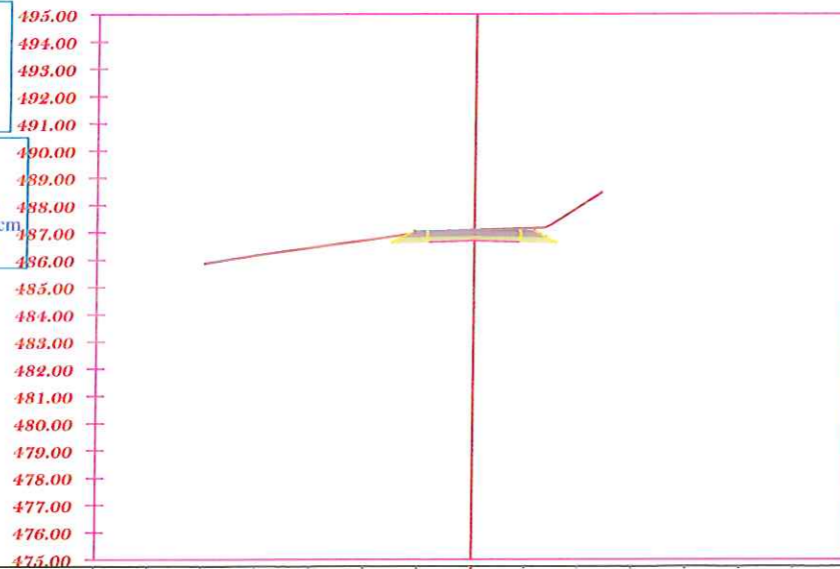

DISTANCA PARC. [m]	0.00	0.00	0.00	0.00	0.00	0.00	0.00
KUOTA TOKES [m]	485.87	486.18	486.45	486.72	487.00	487.09	487.15
KUOTA FAKTIKE [m]	485.87	486.18	486.45	486.72	487.00	487.09	487.15
KUOTA PROJEKTIT [m]	485.87	486.18	486.45	486.72	487.00	487.09	487.15

- Seksioni: 44  
 - Progresivi: 1+075.00  
 - Shkalla e vizatimit: 200.000  
 - Kuota reference: 477.00

- Shtreses Asfaltobeton: 4cm  
 - Shtreses binderi : 6cm  
 - Shtresese Stabilizanti: 15cm  
 - Cakull mbeturina kave: 20cm  
 - Siperfaqe Germim: 2.91m<sup>3</sup>

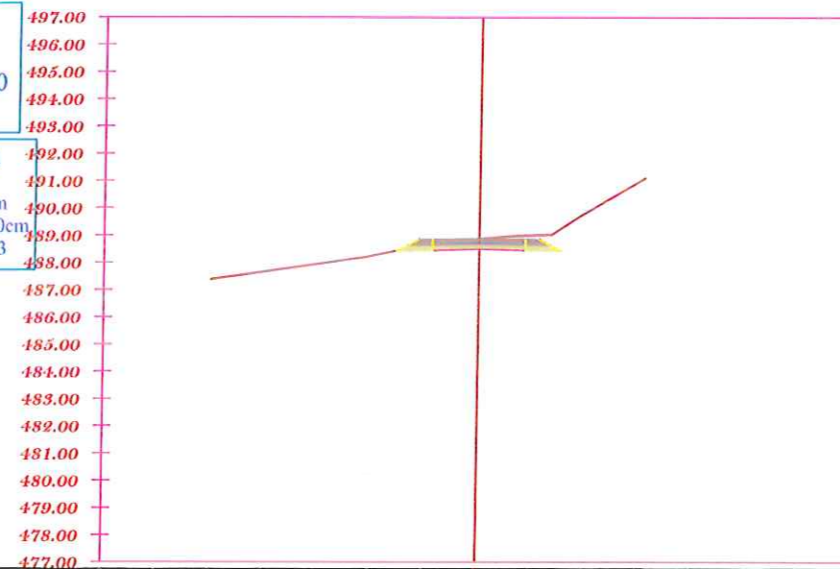

DISTANCA PARC. [m]	0.00	0.00	0.00	0.00	0.00	0.00	0.00
KUOTA TOKES [m]	487.38	487.66	487.94	488.24	488.64	488.37	488.99
KUOTA FAKTIKE [m]	487.38	487.66	487.94	488.24	488.64	488.37	488.99
KUOTA PROJEKTIT [m]	487.38	487.66	487.94	488.24	488.64	488.37	488.99

12-STU  
 Ing. MENTOR ÇOKAJ  
 Projektues



Objekti:  
 Studim Projektim Rrugët Rurale  
 Segmenti "Rruga Bylbyl Breçani"



PROJEKTOI  
 "LAND POINT-AL "  
 Rruga Xhemal Tafaj,  
 Ndertesë nr 5

Projektues  
 Ing. Mentor Çokaj

SHKALLA  
 1 : 250  
 Tiranë 2022

FLETA  
 F - 22  
 Format A3



- Seksioni: 45  
 - Progresivi: 1+100.00  
 - Shkalla e vizatimit: 200.000  
 - Kuota reference: 479.00

- Shtres Asfaltobteon: 4cm  
 - Shtres binderi : 6cm  
 - Shtrese Stabilizanti: 15cm  
 - Cakull mbeturina kave: 20cm  
 - Siperfaqe Germim: 3.02m<sup>3</sup>

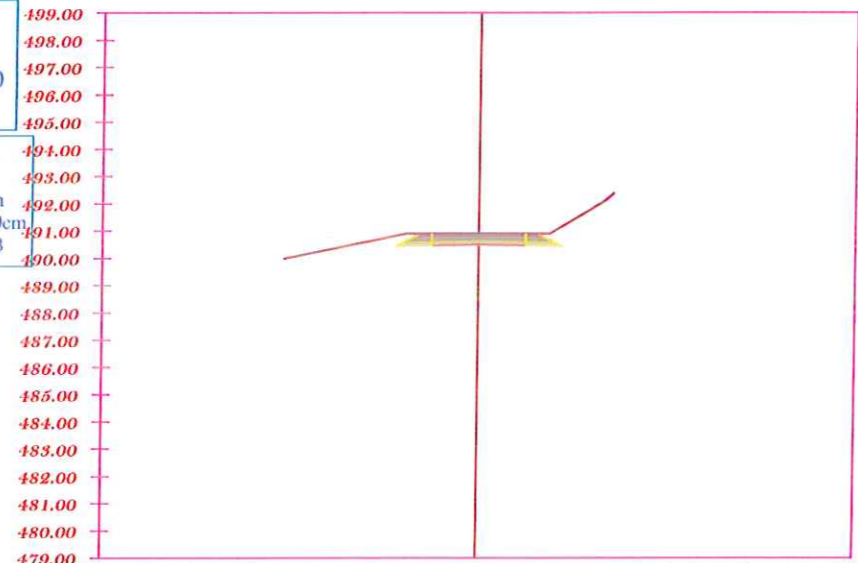

DISTANCA PARC. [m]		0.00	0.00	0.00	<b>490.98-0.00</b>	0.00	0.00
KUOTA TOKES [m]		490.23	490.63	490.90	<b>490.98</b>	490.90	491.71
KUOTA FAKTIKE [m]		490.23	490.63	490.90	<b>490.98</b>	490.90	491.71
KUOTA PROJEKTIT [m]		490.23	490.63	490.90	<b>490.98</b>	490.90	491.71

- Seksioni: 46  
 - Progresivi: 1+125.00  
 - Shkalla e vizatimit: 200.000  
 - Kuota reference: 481.00

- Shtres Asfaltobteon: 4cm  
 - Shtres binderi : 6cm  
 - Shtrese Stabilizanti: 15cm  
 - Cakull mbeturina kave: 20cm  
 - Siperfaqe Germim: 3.11m<sup>3</sup>

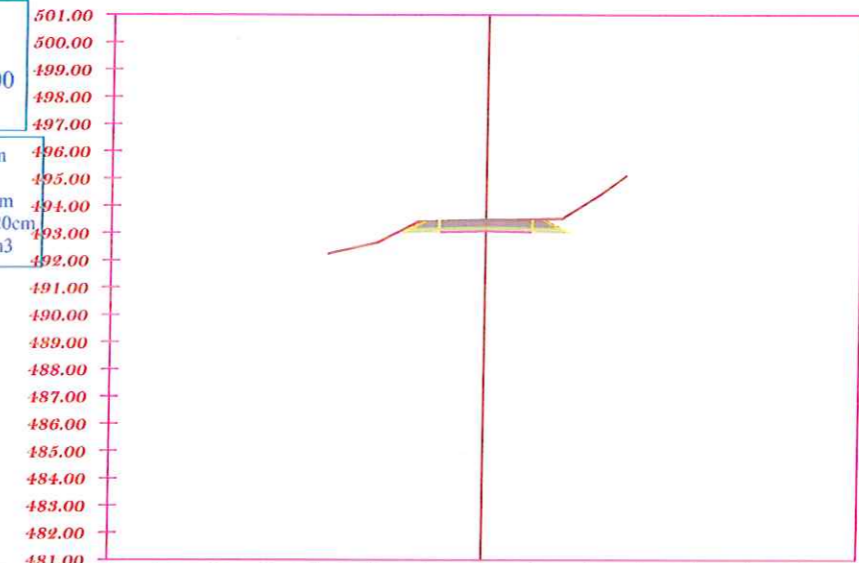

DISTANCA PARC. [m]		0.00	0.00	<b>493.48-0.00</b>	0.00	0.00
KUOTA TOKES [m]		492.67	493.44	<b>493.48</b>	493.52	494.26
KUOTA FAKTIKE [m]		492.67	493.44	<b>493.48</b>	493.52	494.26
KUOTA PROJEKTIT [m]		492.67	493.44	<b>493.48</b>	493.52	494.26



POROSITESI:  
 Bashkia Tropojë

Objekti:  
 Studim Projektim Rrugët Rurale  
 Segmenti "Ruga Bylbyl Breçani"

PROJEKTOI

**LAND POINT-AL**

"LAND POINT-AL "  
 Rruga Xhemal Tafaj;  
 Ndertesa nr 5

Projektues

Ing. Mentor Cokaj

*(Signature)*

SHKALLA  
 1 : 250  
 Tiranë 2022

FLETA  
 F - 23  
 Format A3

- Seksioni: 47  
 - Progresivi: 1+150.00  
 - Shkalla e vizatimit: 200.000  
 - Kuota reference: 483.00

- Shtres Asfaltobteon: 4cm  
 - Shtres binderi : 6cm  
 - Shtrese Stabilizanti: 15cm  
 - Cakull mbeturina kave: 20cm  
 - Siperfaqe Germim: 3.43m<sup>3</sup>

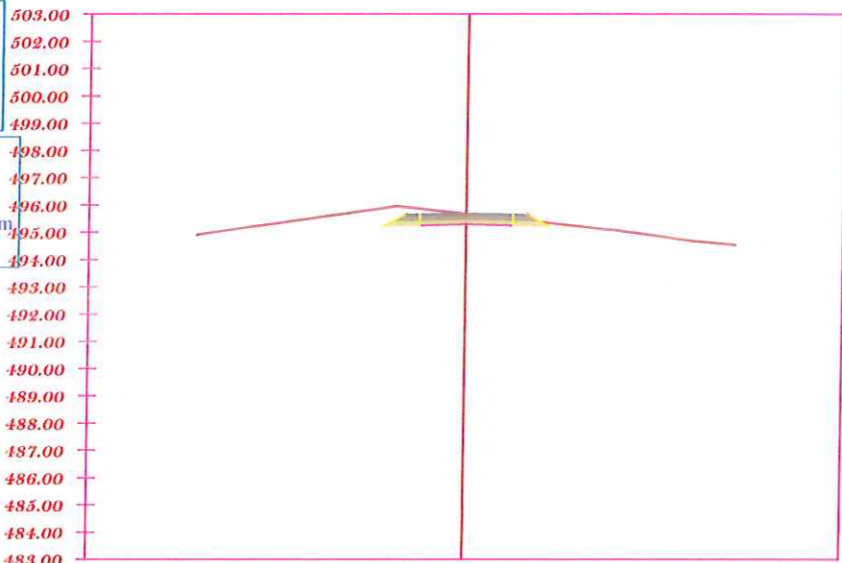

DISTANCA PARC. [m]	0.00	0.00	0.00	0.00	0.00	0.00	0.00	0.00	0.00	0.00
KUOTA TOKES [m]		+494.91	+495.21	+495.48	+495.76	+495.89	+495.78	+495.47	+495.24	+494.74
KUOTA FAKTIKE [m]		+494.51	+495.21	+495.48	+495.76	+495.89	+495.70	+495.37	+495.24	+494.51
KUOTA PROJEKTIT [m]		+494.51	+495.21	+495.48	+495.76	+495.89	+495.70	+495.37	+495.24	+494.51

- Seksioni: 48  
 - Progresivi: 1+175.00  
 - Shkalla e vizatimit: 200.000  
 - Kuota reference: 486.00

- Shtres Asfaltobteon: 4cm  
 - Shtres binderi : 6cm  
 - Shtrese Stabilizanti: 15cm  
 - Cakull mbeturina kave: 20cm  
 - Siperfaqe Germim: 3.47m<sup>3</sup>

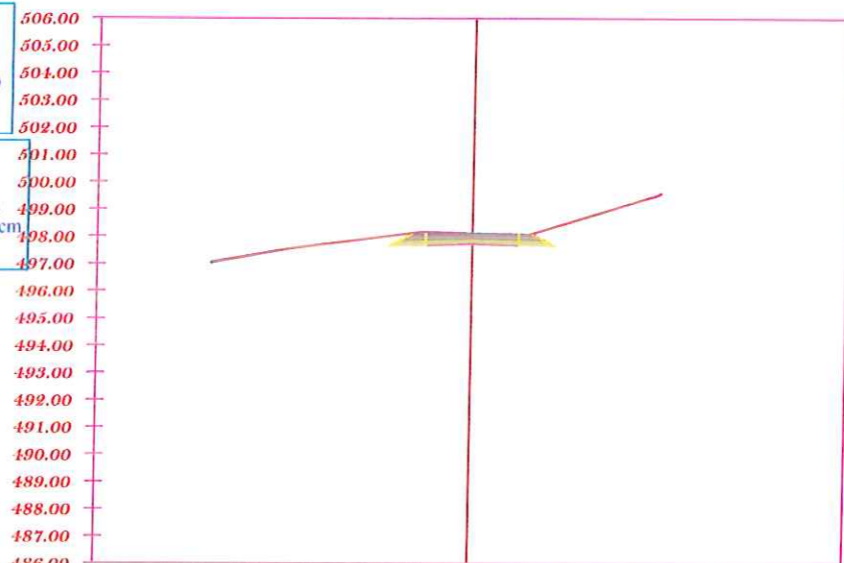

DISTANCA PARC. [m]	0.00	0.00	0.00	0.00	0.00	0.00	0.00	0.00	0.00	0.00
KUOTA TOKES [m]		+497.35	+497.66	+497.91	+498.16	+498.13	+498.08	+498.64	+499.24	
KUOTA FAKTIKE [m]		+497.35	+497.66	+497.91	+498.16	+498.13	+498.08	+498.64	+499.24	
KUOTA PROJEKTIT [m]		+497.35	+497.66	+497.91	+498.16	+498.13	+498.08	+498.64	+499.24	



POROSITESI:  
 Bashkia Tropojë

Objekti:  
 Studim Projektim Rrugët Rurale  
 Segmenti "Ruga Bylbyl Breçani"

PROJEKTOI

**LAND POINT-AL**

"LAND POINT-AL "  
 Rruga Xhemal Tafaj;  
 Ndertesa nr 5

Projektues  
 Ing. Mentor Cokaj

SHKALLA  
 1 : 250  
 Tiranë 2022

FLETA  
 F - 24  
 Format A3



- Seksioni: 49  
 - Progresivi: 1+200.00  
 - Shkalla e vizatimit: 200.000  
 - Kuota reference: 488.00

- Shtres Asfaltobteon: 4cm  
 - Shtres binderi : 6cm  
 - Shtrese Stabilizanti: 15cm  
 - Cakull mbeturina kave: 20cm  
 - Siperfaqe Germim: 3.10m<sup>3</sup>

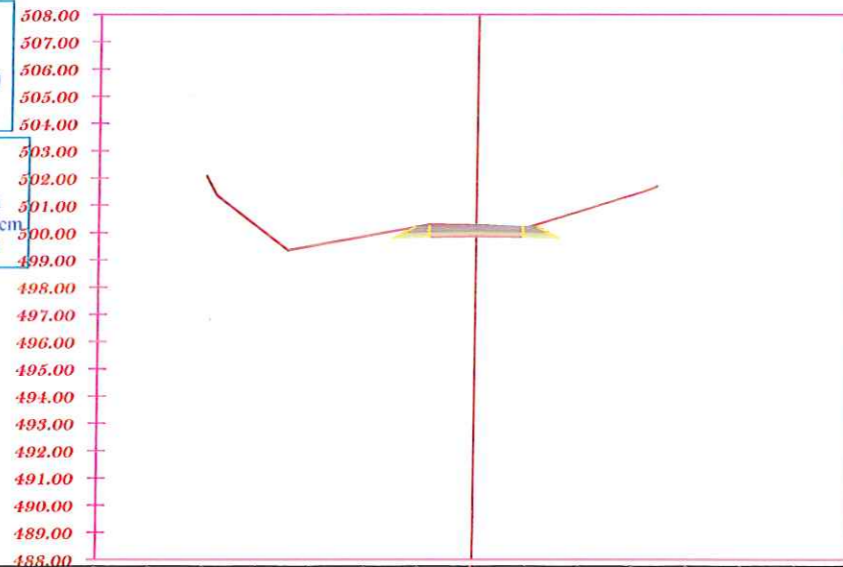

DISTANCA PARC. [m]	0.00	0.00	0.00	0.00	0.00	500.26	500.26	0.00	0.00	0.00
KUOTA TOKES [m]	502.07	500.12	499.53	499.89	500.25	500.26	500.22	500.83	501.44	
KUOTA FAKTIKE [m]	502.07	500.12	499.53	499.89	500.25	500.26	500.22	500.83	501.44	
KUOTA PROJEKTTIT [m]	502.07	500.12	499.53	499.89	500.25	500.26	500.22	500.83	501.44	

- Seksioni: 50  
 - Progresivi: 1+225.00  
 - Shkalla e vizatimit: 200.000  
 - Kuota reference: 491.00

- Shtres Asfaltobteon: 4cm  
 - Shtres binderi : 6cm  
 - Shtrese Stabilizanti: 15cm  
 - Cakull mbeturina kave: 20cm  
 - Siperfaqe Germim: 3.51m<sup>3</sup>

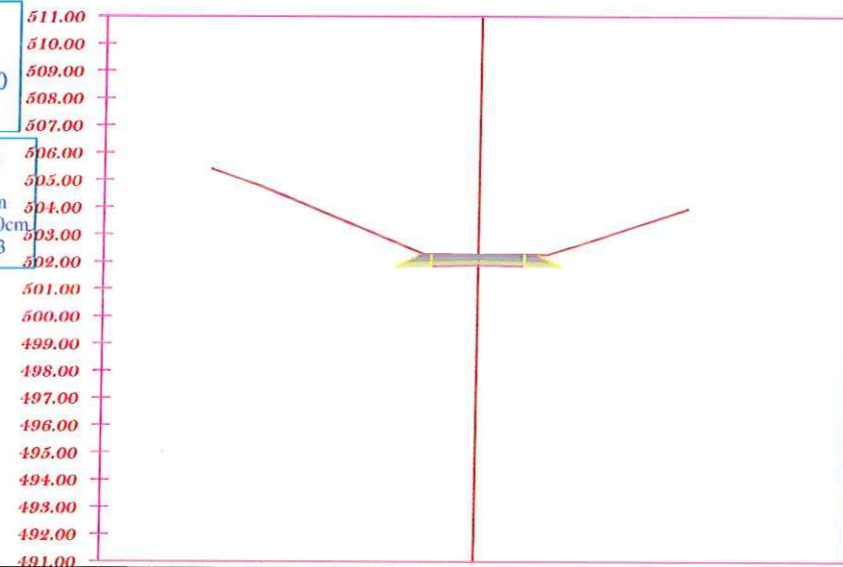

DISTANCA PARC. [m]	0.00	0.00	0.00	0.00	0.00	502.29	502.29	0.00	0.00	0.00
KUOTA TOKES [m]	505.40	504.70	503.89	503.09	502.29	502.29	502.28	502.70	503.35	
KUOTA FAKTIKE [m]	505.40	504.70	503.89	503.09	502.29	502.29	502.28	502.70	503.35	
KUOTA PROJEKTTIT [m]	505.40	504.70	503.89	503.09	502.29	502.29	502.28	502.70	503.35	



Objekti:  
 Studim Projektim Rrugët Rurale  
 Segmenti "Ruga Bylbyl Breçani"



PROJEKTOI

"LAND POINT-AL "  
 Rruga Xhemal Tafaj;  
 Ndertesa nr 5

Ing. Mentor Cokaj

Projektues



SHKALLA

1 : 250

Tiranë 2022

FLETA

F - 25

Format A3

- Seksioni: 51  
 - Progresivi: 1+250.00  
 - Shkalla e vizatimit: 200.000  
 - Kuota reference: 493.00

- Shtres Asfaltbteon: 4cm  
 - Shtres binderi : 6cm  
 - Shtrese Stabilizanti: 15cm  
 - Cakull mbeturina kave: 20cm  
 - Siperfaqe Germim: 3.41m<sup>3</sup>

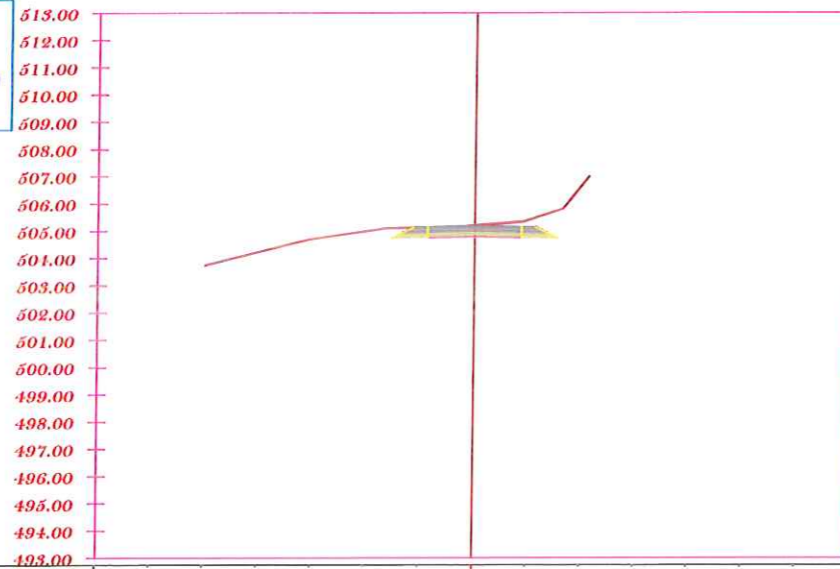

DISTANCA PARC. [m]	0.00	0.00	0.00	0.00	0.00	0.00	0.00	0.00
KUOTA TOKES [m]	503.74	504.23	504.71	505.00	505.12	505.19	505.40	506.73
KUOTA FAKTIKE [m]	503.74	504.23	504.71	505.00	505.12	505.19	505.40	506.73
KUOTA PROJEKTIT [m]	503.74	504.23	504.71	505.00	505.12	505.19	505.40	506.73

- Seksioni: 52  
 - Progresivi: 1+275.00  
 - Shkalla e vizatimit: 200.000  
 - Kuota reference: 493.00

- Shtres Asfaltbteon: 4cm  
 - Shtres binderi : 6cm  
 - Shtrese Stabilizanti: 15cm  
 - Cakull mbeturina kave: 20cm  
 - Siperfaqe Germim: 2.81m<sup>3</sup>

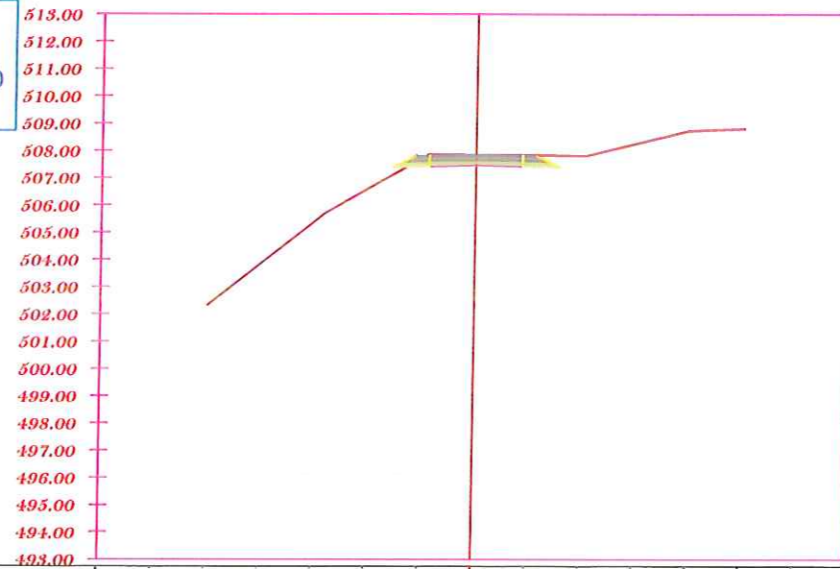

DISTANCA PARC. [m]	0.00	0.00	0.00	0.00	0.00	0.00	0.00	0.00
KUOTA TOKES [m]	502.35	503.88	505.42	506.62	507.74	507.85	507.83	508.73
KUOTA FAKTIKE [m]	502.35	503.88	505.42	506.62	507.74	507.85	507.83	508.73
KUOTA PROJEKTIT [m]	502.35	503.88	505.42	506.62	507.74	507.85	507.83	508.73

ING. MENTOR ÇOKAJ  
 (Signature and Stamp)



POROSITESI:  
 Objekti:  
 Studim Projektim Rrugët Rurale  
 Segmenti "Rruga Bylbyl Breçani"

PROJEKTOI  
 "LAND POINT-AL"  
 Rruga Xhemal Tafaj;  
 Ndertesë nr 5

Projektues  
 Ing. Mentor Cokaj

SHKALLA  
 1 : 250  
 Tiranë 2022

FLETA  
 F - 26  
 Format A3



- Seksioni: 53  
 - Progresivi: 1+300.00  
 - Shkalla e vizatimit: 200.000  
 - Kuota reference: 497.00

- Shtres Asfaltobteon: 4cm  
 - Shtres binderi : 6cm  
 - Shtrese Stabilizanti: 15cm  
 - Cakull mbeturina kave: 20cm  
 - Siperfaqe Germim: 2.73m<sup>3</sup>

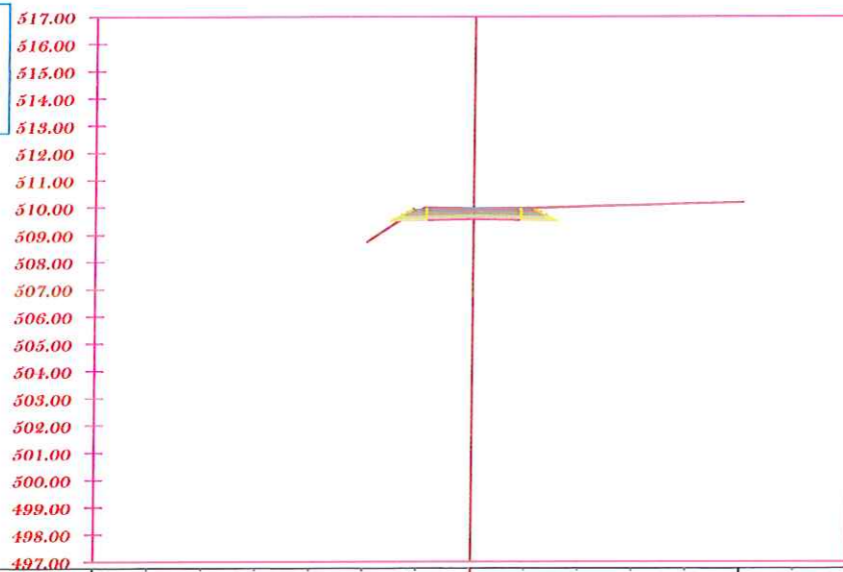

DISTANCA PARC. [m]			0.00	<b>509.97-0.00</b>	0.00	0.00	0.00	0.00	0.00
KUOTA TOKES [m]			509.88	<b>509.97</b>	509.97	510.03	510.08	510.13	510.18
KUOTA FAKTIKE [m]			509.88	<b>509.97</b>	509.97	510.03	510.08	510.13	510.18
KUOTA PROJEKTIT [m]			509.88	<b>509.97</b>	509.97	510.03	510.08	510.13	510.18

- Seksioni: 53  
 - Progresivi: 1+300.00  
 - Shkalla e vizatimit: 200.000  
 - Kuota reference: 497.00

- Shtres Asfaltobteon: 4cm  
 - Shtres binderi : 6cm  
 - Shtrese Stabilizanti: 15cm  
 - Cakull mbeturina kave: 20cm  
 - Siperfaqe Germim: 2.73m<sup>3</sup>

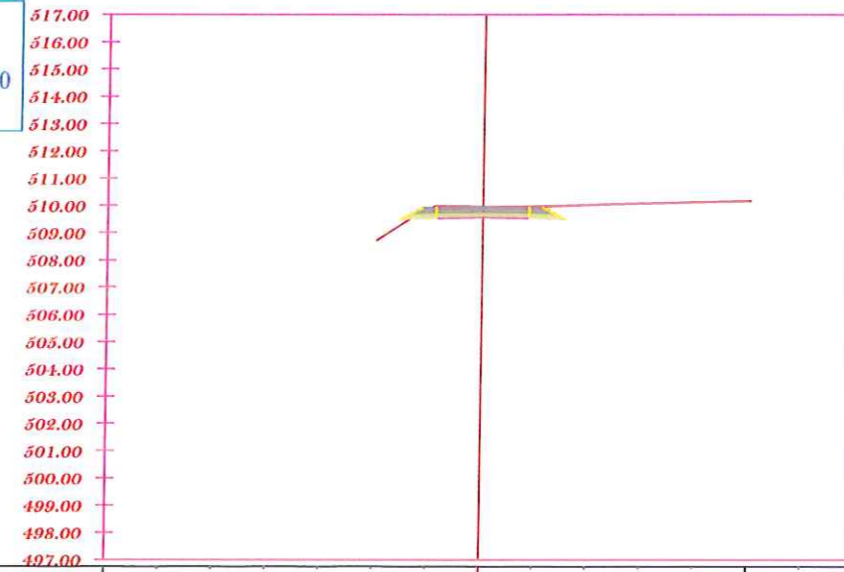

DISTANCA PARC. [m]			0.00	<b>509.97-0.00</b>	0.00	0.00	0.00	0.00	0.00
KUOTA TOKES [m]			509.88	<b>509.97</b>	509.97	510.03	510.08	510.13	510.18
KUOTA FAKTIKE [m]			509.88	<b>509.97</b>	509.97	510.03	510.08	510.13	510.18
KUOTA PROJEKTIT [m]			509.88	<b>509.97</b>	509.97	510.03	510.08	510.13	510.18



 POROSITESI: Bashkia Tropojë	Objekti:	PROJEKTOI	Projektues	SHKALLA	FLETA
	Studim Projektim Rrugët Rurale Segmenti "Rruga Bylbyl Breçani"	 "LAND POINT-AL " Rruga Xhemal Tafaj; Ndertesë nr 5	Ing. Mentor Cokaj 	1 : 250	F - 27
				Tiranë 2022	Format A3

- Seksioni: 55
- Progresivi: 1+350.00
- Shkalla e vizatimit: 200.000
- Kuota reference: 501.00

- Shtreses Asfaltobteon: 4cm
- Shtreses binderi : 6cm
- Shtreses Stabilizanti: 15cm
- Cakull mbeturina kave: 20cm
- Siperfaqe Germim: 2.61m<sup>3</sup>

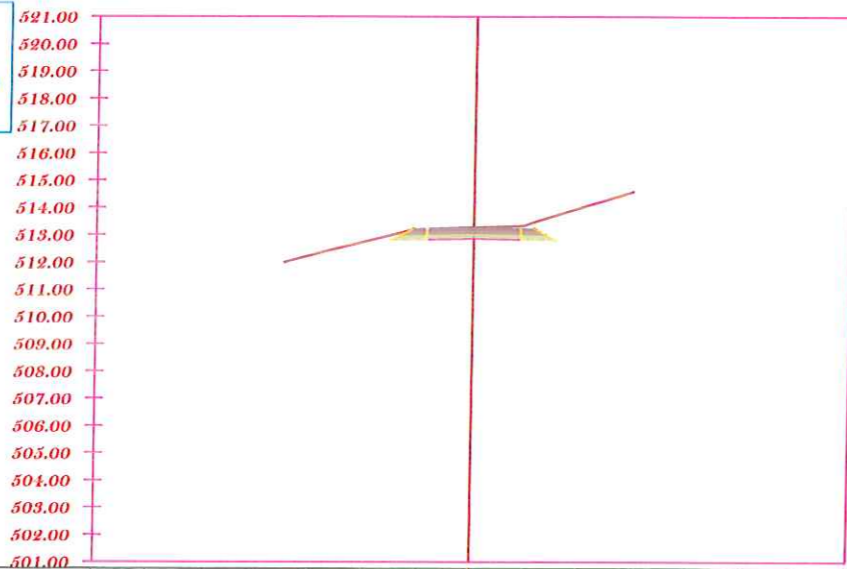



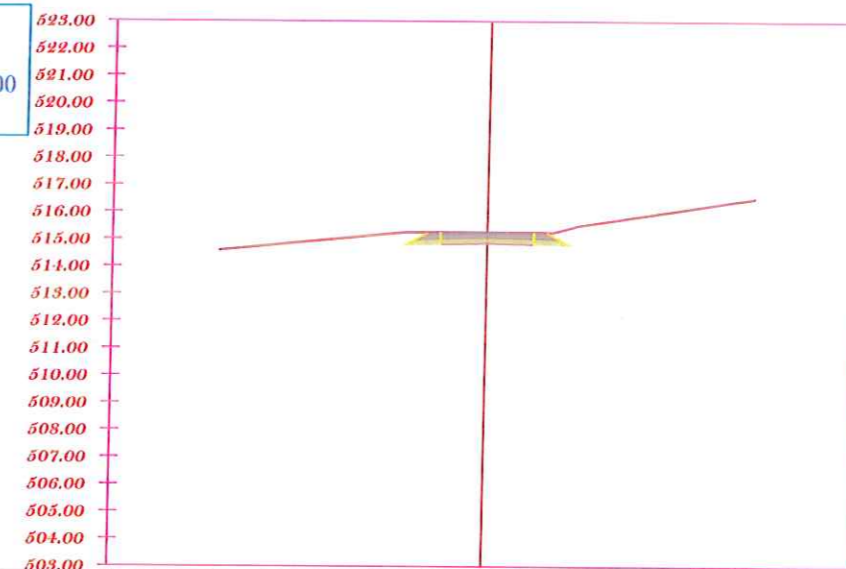

DISTANCA PARC. [m]							
KUOTA TOKES [m]							
KUOTA FAKTIKE [m]							
KUOTA PROJEKTIT [m]							

- Seksioni: 56
- Progresivi: 1+375.00
- Shkalla e vizatimit: 200.000
- Kuota reference: 503.00

- Shtreses Asfaltobteon: 4cm
- Shtreses binderi : 6cm
- Shtreses Stabilizanti: 15cm
- Cakull mbeturina kave: 20cm
- Siperfaqe Germim: 2.72m<sup>3</sup>

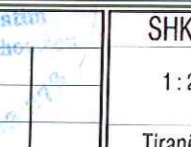

DISTANCA PARC. [m]							
KUOTA TOKES [m]							
KUOTA FAKTIKE [m]							
KUOTA PROJEKTIT [m]							

 POROSITESI: Bashkia Tropojë	Objekti: Studim Projektim Rrugët Rurale Segmenti "Rruga Bylbyl Breçani"	 PROJEKTOI "LAND POINT-AL" Rruga Xhemal Tafaj; Ndertesë nr 5	Projektues Ing. Mentor Cokaj		 SHKALLA 1 : 250 Tiranë 2022	FLETA F - 28 Format A3
						



- Seksioni: 57  
 - Progresivi: 1+400.00  
 - Shkalla e vizatimit: 200.000  
 - Kuota reference: 504.00

- Shtreses Asfaltobteon: 4cm  
 - Shtreses binderi : 6cm  
 - Shtreses Stabilizanti: 15cm  
 - Cakull mbeturina kave: 20cm  
 - Siperfaqe Germim: 2.53m<sup>3</sup>

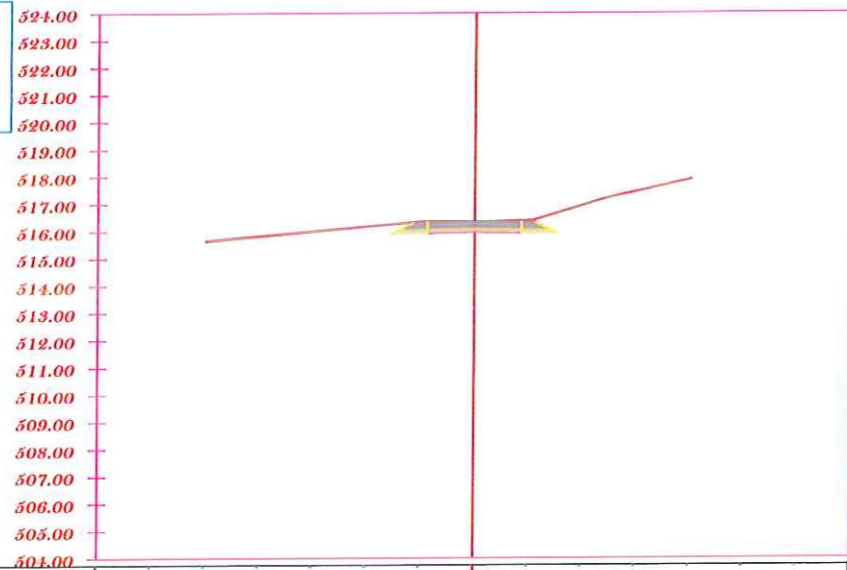



DISTANCA PARC. [m]	0.00	0.00	0.00	0.00	0.00	0.00	0.00	0.00	0.00	0.00
KUOTA TOKES [m]	515.65	515.82	516.00	516.17	516.35	516.36	516.39	516.94	517.45	517.89
KUOTA FAKTIKE [m]	515.65	515.82	516.00	516.17	516.35	516.36	516.39	516.94	517.45	517.89
KUOTA PROJEKTIT [m]	515.65	515.82	516.00	516.17	516.35	516.36	516.39	516.94	517.45	517.89

- Seksioni: 58  
 - Progresivi: 1+425.00  
 - Shkalla e vizatimit: 200.000  
 - Kuota reference: 506.00

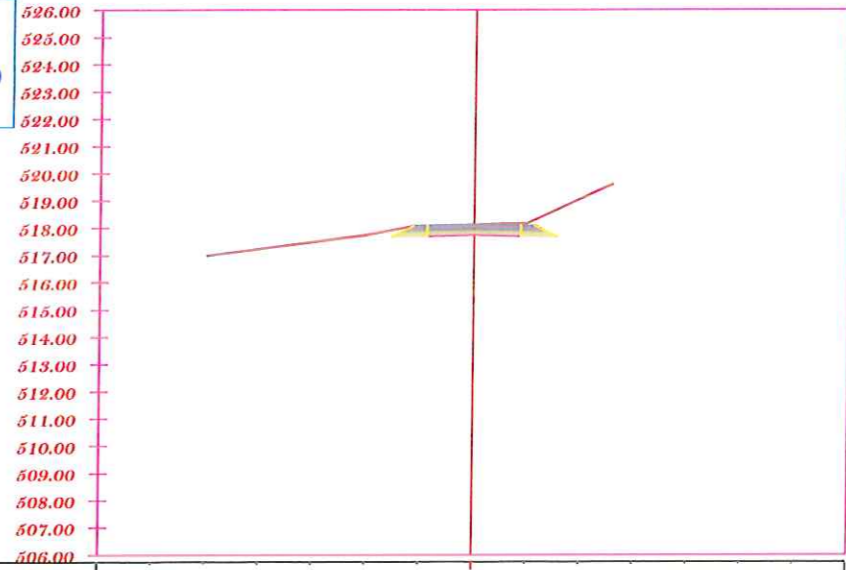
- Shtreses Asfaltobteon: 4cm  
 - Shtreses binderi : 6cm  
 - Shtreses Stabilizanti: 15cm  
 - Cakull mbeturina kave: 20cm  
 - Siperfaqe Germim: 2.64m<sup>3</sup>



DISTANCA PARC. [m]	0.00	0.00	0.00	0.00	0.00	0.00	0.00	0.00	0.00	0.00
KUOTA TOKES [m]	517.00	517.25	517.50	517.76	518.08	518.14	518.20	518.20	519.10	519.10
KUOTA FAKTIKE [m]	517.00	517.25	517.50	517.76	518.08	518.14	518.20	518.20	519.10	519.10
KUOTA PROJEKTIT [m]	517.00	517.25	517.50	517.76	518.08	518.14	518.20	518.20	519.10	519.10

 POROSITESI: Bashkia Tropojë	Objekti: Studim Projektim Rrugët Rurale Segmenti "Rruga Bylbyl Breçani"	 PROJEKTOI "LAND POINT-AL " Rruga Xhemal Tafaj; Ndertesa nr 5	Projektues		SHKALLA 1 : 250 Tiranë 2022	FLETA F - 29 Format A3
			Ing. Mentor Cokaj	 Mentor Cokaj Inxhinier i Rrugëve Nr. 10, Rr. "Zëbra"		

- Seksioni: 59
- Progresivi: 1+450.00
- Shkalla e vizatimit: 200.000
- Kuota reference: 507.00

- Shtres Asfaltobeton: 4cm
- Shtres binderi : 6cm
- Shtrese Stabilizanti: 15cm
- Cakull mbeturina kave: 20cm
- Siperfaqe Germim: 2.67m<sup>3</sup>

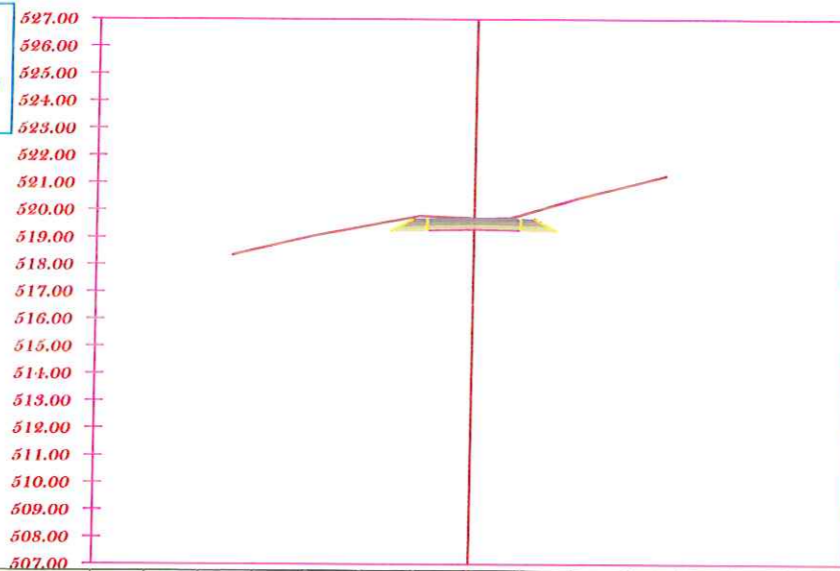

DISTANCA PARC. [m]									
KUOTA TOKES [m]									
KUOTA FAKTIKE [m]									
KUOTA PROJEKTIT [m]									

- Seksioni: 60
- Progresivi: 1+475.00
- Shkalla e vizatimit: 200.000
- Kuota reference: 509.00

- Shtres Asfaltobeton: 4cm
- Shtres binderi : 6cm
- Shtrese Stabilizanti: 15cm
- Cakull mbeturina kave: 20cm
- Siperfaqe Germim: 2.54m<sup>3</sup>

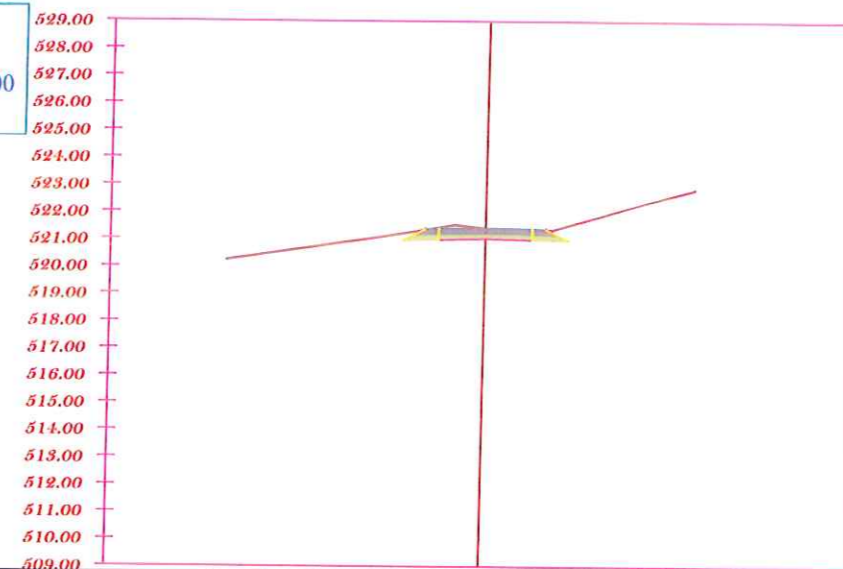

DISTANCA PARC. [m]									
KUOTA TOKES [m]									
KUOTA FAKTIKE [m]									
KUOTA PROJEKTIT [m]									



POROSITESI:  
Objekti:  
Studim Projektim Rrugët Rurale  
Segmenti "Rruga Bylbyl Breçani"



PROJEKTOI  
"LAND POINT-AL "  
Rruga Xhemal Tafaj;  
Ndertesa nr 5

Projektues  
Ing. Mentor Cokaj

SHKALLA  
1 : 250  
Tiranë 2022

FLETA  
F - 30  
Format A3





- Seksioni: 61  
 - Progresivi: 1+500.00  
 - Shkalla e vizatimit: 200.000  
 - Kuota reference: 513.00

- Shtres Asfaltobteon: 4cm  
 - Shtres binderi : 6cm  
 - Shtrese Stabilizanti: 15cm  
 - Cakull mbeturina kave: 20cm  
 - Siperfaqe Germim: 2.1m3

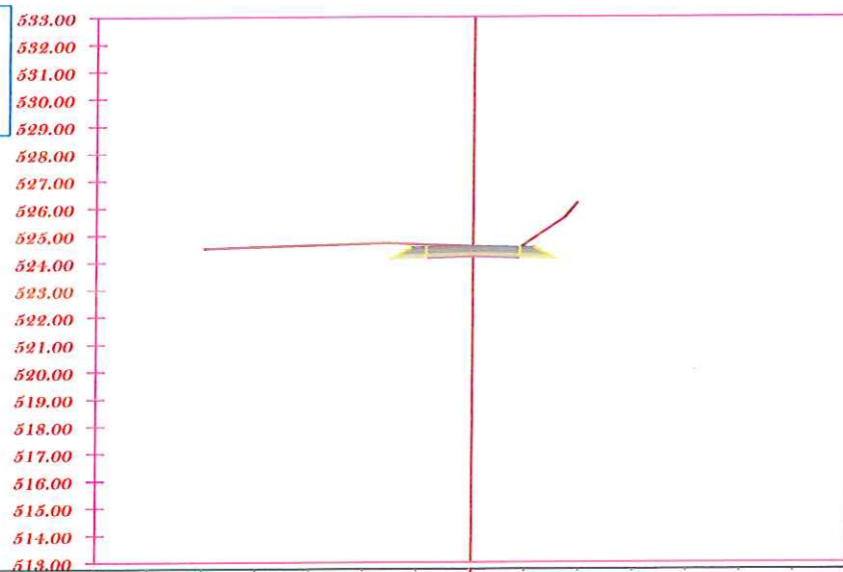



DISTANCA PARC. [m]	0.00	0.00	0.00	0.00	0.00	0.00	0.00
KUOTA TOKES [m]	524.51	524.58	524.63	524.69	524.67	524.59	524.71
KUOTA FAKTIKE [m]	524.51	524.58	524.63	524.69	524.67	524.59	524.71
KUOTA PROJEKTIT [m]	524.51	524.58	524.63	524.69	524.67	524.59	524.71

- Seksioni: 62  
 - Progresivi: 1+525.00  
 - Shkalla e vizatimit: 200.000  
 - Kuota reference: 516.00

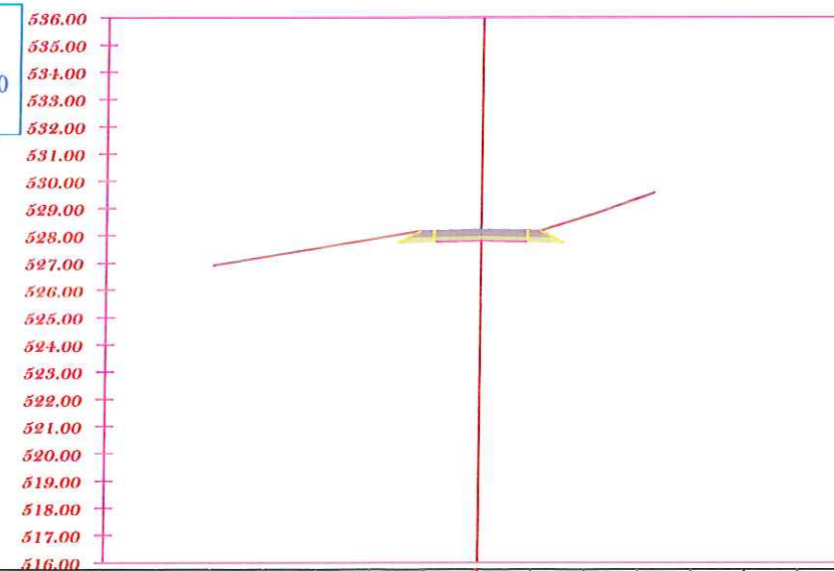
- Shtres Asfaltobteon: 4cm  
 - Shtres binderi : 6cm  
 - Shtrese Stabilizanti: 15cm  
 - Cakull mbeturina kave: 20cm  
 - Siperfaqe Germim: 2.78m3



DISTANCA PARC. [m]	0.00	0.00	0.00	0.00	0.00	0.00	0.00
KUOTA TOKES [m]	526.91	527.24	527.56	527.89	528.17	528.24	528.19
KUOTA FAKTIKE [m]	526.91	527.24	527.56	527.89	528.17	528.24	528.19
KUOTA PROJEKTIT [m]	526.91	527.24	527.56	527.89	528.17	528.24	528.19

 POROSITESI: Bashkia Tropojë	Objekti:	 "LAND POINT-AL " Rruga Xhemal Tafaj; Ndertesa nr 5	PROJEKTOI Projektues Ing. Mentor Cokaj	 MENTOR ÇOKAJ Inxhinier i Zbatimit	SHKALLA	FLETA
	Studim Projektim Rrugët Rurale Segmenti "Rruga Bylbyl Breçani"				1 : 250	F - 31
					Tiranë 2022	Format A3

- Seksioni: 63  
 - Progresivi: 1+550.00  
 - Shkalla e vizatimit: 200.000  
 - Kuota reference: 517.00

- Shtres Asfaltobteon: 4cm  
 - Shtres binderi : 6cm  
 - Shtrese Stabilizanti: 15cm  
 - Cakull mbeturina kave: 20cm  
 - Siperfaqe Germim: 2.94m<sup>3</sup>

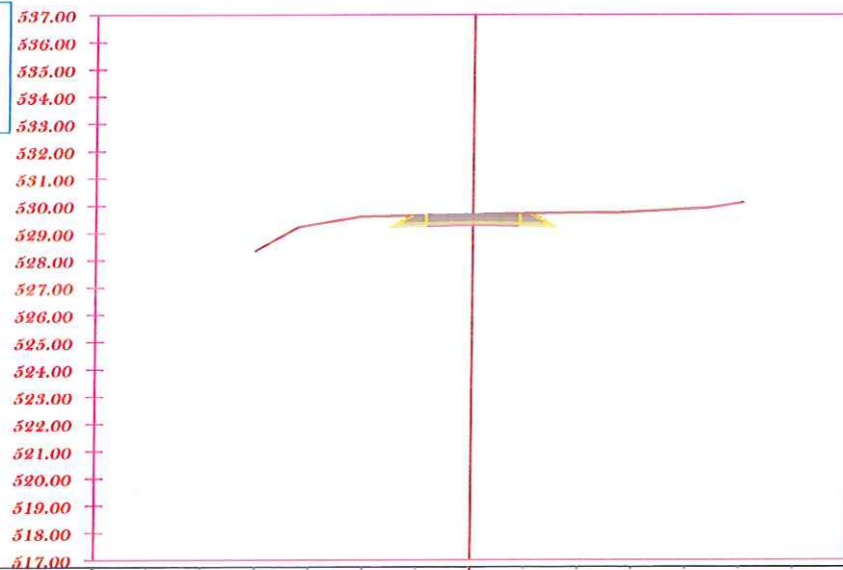

DISTANCA PARC. [m]										
KUOTA TOKES [m]										
KUOTA FAKTIKE [m]										
KUOTA PROJEKTIT [m]										

- Seksioni: 64  
 - Progresivi: 1+575.00  
 - Shkalla e vizatimit: 200.000  
 - Kuota reference: 519.00

- Shtres Asfaltobteon: 4cm  
 - Shtres binderi : 6cm  
 - Shtrese Stabilizanti: 15cm  
 - Cakull mbeturina kave: 20cm  
 - Siperfaqe Germim: 2.74m<sup>3</sup>

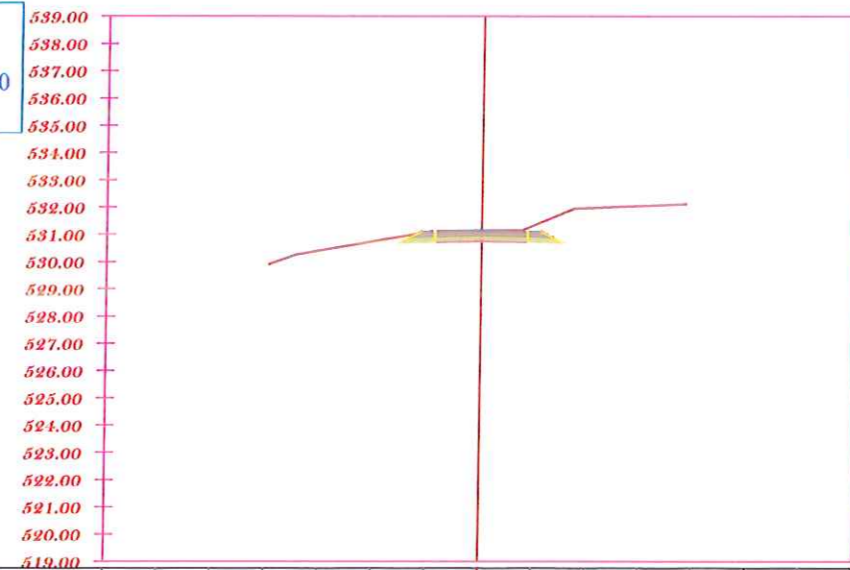

DISTANCA PARC. [m]										
KUOTA TOKES [m]										
KUOTA FAKTIKE [m]										
KUOTA PROJEKTIT [m]										



POROSITESI:  
 Objekti:  
 Studim Projektim Rrugët Rurale  
 Segmenti "Rruga Bylbyl Breçani "



PROJEKTOI  
 "LAND POINT-AL "  
 Rruga Xhemal Tafaj;  
 Ndertesha nr 5

Projektues  
 Ing. Mentor Cokaj

SHKALLA  
 1 : 250  
 Tiranë 2022

FLETA  
 F - 32  
 Format A3





- Seksioni: 65  
 - Progresivi: 1+600.00  
 - Shkalla e vizatimit: 200.000  
 - Kuota reference: 520.00

- Shtres Asfaltobteon: 4cm  
 - Shtres binderi : 6cm  
 - Shtrese Stabilizanti: 15cm  
 - Cakull mbeturina kave: 20cm  
 - Siperfaqe Germim: 2.83m<sup>3</sup>

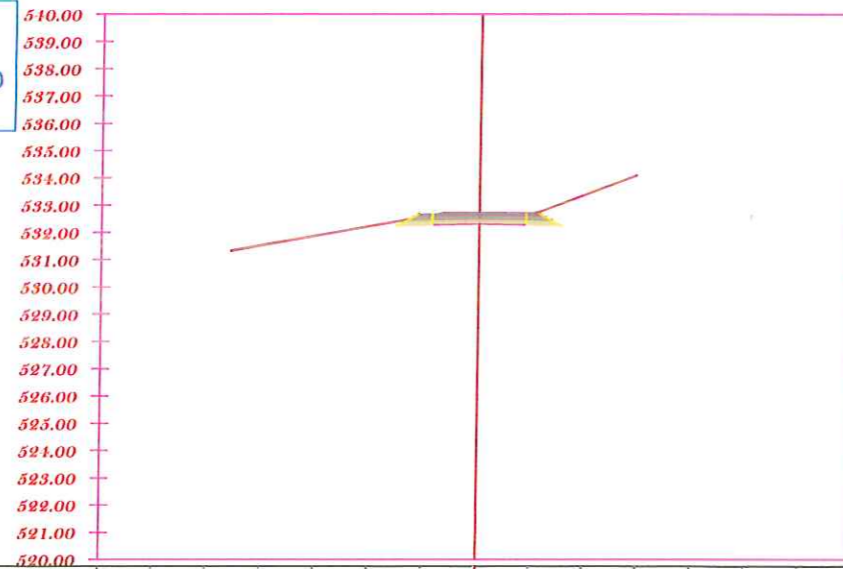

DISTANCA PARC. [m]	0.00	0.00	0.00	0.00	0.00	0.00
KUOTA TOKES [m]	531.54	531.89	532.24	532.59	532.71	532.70
KUOTA FAKTIKE [m]	531.54	531.89	532.24	532.59	532.71	532.70
KUOTA PROJEKTIT [m]	531.54	531.89	532.24	532.59	532.71	532.70

- Seksioni: 66  
 - Progresivi: 1+625.00  
 - Shkalla e vizatimit: 200.000  
 - Kuota reference: 521.00

- Shtres Asfaltobteon: 4cm  
 - Shtres binderi : 6cm  
 - Shtrese Stabilizanti: 15cm  
 - Cakull mbeturina kave: 20cm  
 - Siperfaqe Germim: 2.81m<sup>3</sup>

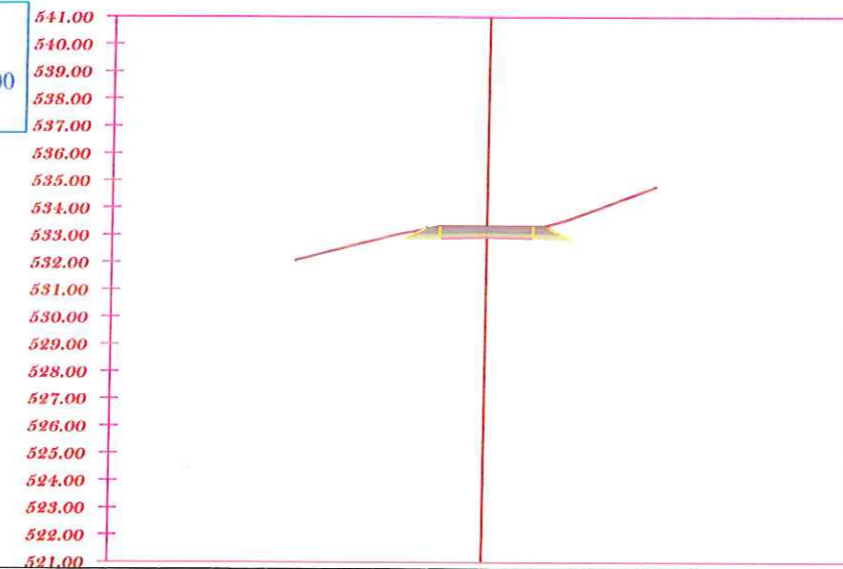

DISTANCA PARC. [m]	0.00	0.00	0.00	0.00	0.00	0.00
KUOTA TOKES [m]	532.96	532.87	532.97	533.32	533.32	533.67
KUOTA FAKTIKE [m]	532.96	532.87	532.97	533.32	533.32	533.67
KUOTA PROJEKTIT [m]	532.96	532.87	532.97	533.32	533.32	533.67



Objekti:  
 Studim Projektim Rrugët Rurale  
 Segmenti "Rruga Bylbyl Breçani"



PROJEKTOI

"LAND POINT-AL "  
 Rruga Xhemal Tafaj;  
 Ndertesa nr 5

Projektues

Ing. Mentor Cokaj

SHKALLA

1 : 250

Tiranë 2022

FLETA

F - 33

Format A3



- Seksioni: 67  
 - Progresivi: 1+650.00  
 - Shkalla e vizatimit: 200.000  
 - Kuota reference: 521.00

- Shtres Asfaltobeton: 4cm  
 - Shtres binderi : 6cm  
 - Shtrese Stabilizanti: 15cm  
 - Cakull mbeturina kave: 20cm  
 - Siperfaqe Germim: 2.74m<sup>3</sup>

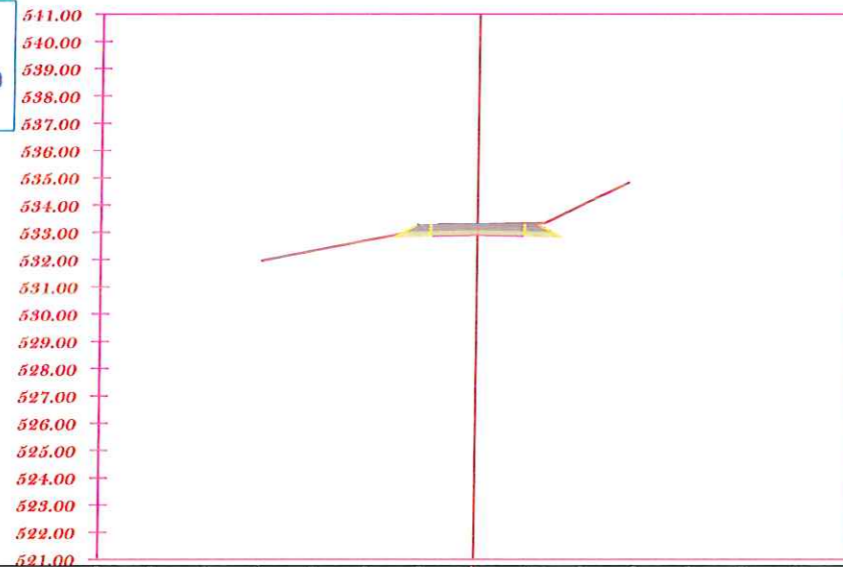



DISTANCA PARC. [m]	0.00	0.00	0.00	0.00	0.00	0.00
KUOTA TOKES [m]	531.97	532.35	532.72	533.15	533.29	533.33
KUOTA FAKTIKE [m]	531.97	532.35	532.72	533.15	533.29	533.33
KUOTA PROJEKTIT [m]	531.97	532.35	532.72	533.15	533.29	533.33

- Seksioni: 68  
 - Progresivi: 1+675.00  
 - Shkalla e vizatimit: 200.000  
 - Kuota reference: 520.00

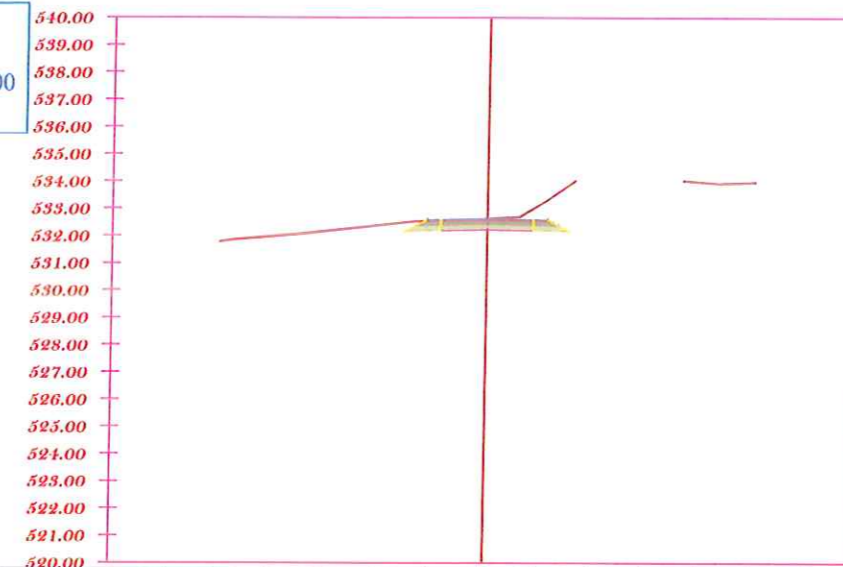
- Shtres Asfaltobeton: 4cm  
 - Shtres binderi : 6cm  
 - Shtrese Stabilizanti: 15cm  
 - Cakull mbeturina kave: 20cm  
 - Siperfaqe Germim: 4.01m<sup>3</sup>



DISTANCA PARC. [m]	0.00	0.00	0.00	0.00	0.00	0.00
KUOTA TOKES [m]	531.78	531.99	532.18	532.40	532.55	532.63
KUOTA FAKTIKE [m]	531.78	531.99	532.18	532.40	532.55	532.63
KUOTA PROJEKTIT [m]	531.78	531.99	532.18	532.40	532.55	532.63

 POROSITESI: Bashkia Tropojë	Objekti: Studim Projektim Rrugët Rurale Segmenti "Rruga Bylbyl Breçani"	PROJEKTOI 		Projektues Ing. Mentor Cokaj		SHKALLA 1 : 250	FLETA F - 34
		"LAND POINT-AL " Rruga Xhemal Tafaj; Ndertes nr 5				Tiranë 2022	Format A3



- Seksioni: 69  
 - Progresivi: 1+700.00  
 - Shkalla e vizatimit: 200.000  
 - Kuota reference: 518.00

- Shtres Asfaltobteon: 4cm  
 - Shtres binderi : 6cm  
 - Shtrese Stabilizanti: 15cm  
 - Cakull mbeturina kave: 20cm  
 - Siperfaqe Germim: 3.11m<sup>3</sup>

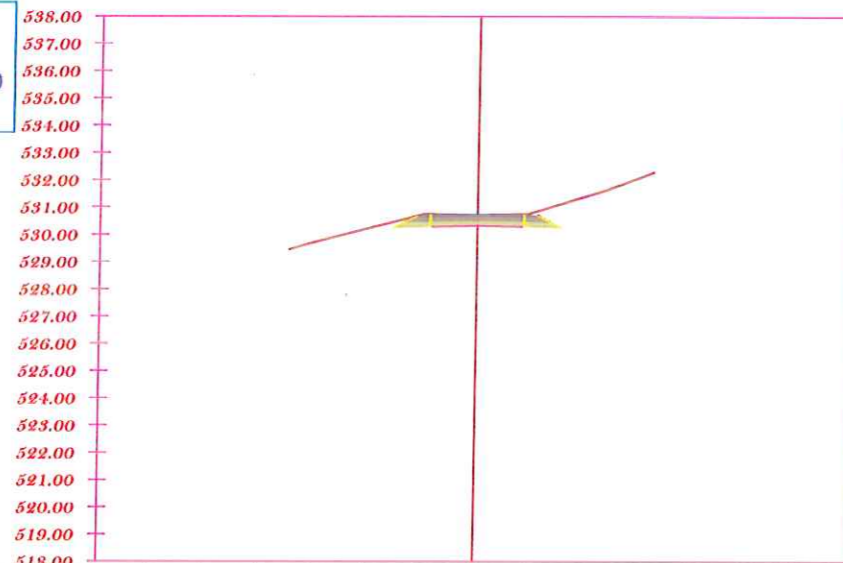

DISTANCA PARC. [m]			0.00	0.00	0.00	0.00	0.00	0.00	0.00
KUOTA TOKES [m]			529.72	530.24	530.75	530.72	530.79	531.40	532.08
KUOTA FAKTIKE [m]			529.72	530.24	530.75	530.72	530.79	531.40	532.08
KUOTA PROJEKTIT [m]			529.72	530.24	530.75	530.72	530.79	531.40	532.08

- Seksioni: 70  
 - Progresivi: 1+725.00  
 - Shkalla e vizatimit: 200.000  
 - Kuota reference: 516.00

- Shtres Asfaltobteon: 4cm  
 - Shtres binderi : 6cm  
 - Shtrese Stabilizanti: 15cm  
 - Cakull mbeturina kave: 20cm  
 - Siperfaqe Germim: 2.78m<sup>3</sup>

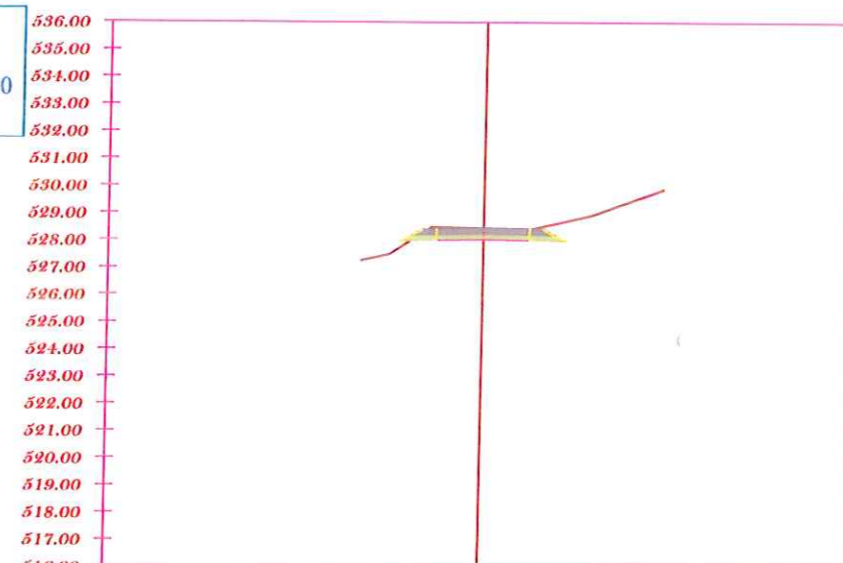

DISTANCA PARC. [m]			0.00	0.00	0.00	0.00	0.00	0.00	0.00
KUOTA TOKES [m]			527.38	528.45	528.45	528.45	528.47	528.88	529.63
KUOTA FAKTIKE [m]			527.38	528.45	528.45	528.45	528.47	528.88	529.63
KUOTA PROJEKTIT [m]			527.38	528.45	528.45	528.45	528.47	528.88	529.63



POROSITESI:  
 Bashkia Tropojë

Objekti:  
 Studim Projektim Rrugët Rurale  
 Segmenti "Rruga Bylbyl Breçani"

PROJEKTOI  
 "LAND POINT-AL "

Rruga Xhemal Tafaj;  
 Ndertesha nr 5



Projektues  
 Ing. Mentor Cokaj

SHKALLA  
 1 : 250

FLETA  
 F - 35

Tiranë 2022  
 Format A3



- Seksioni: 71  
 - Progresivi: 1+750.00  
 - Shkalla e vizatimit: 200.000  
 - Kuota reference: 515.00

- Shtres Asfaltobteon: 4cm  
 - Shtres binderi : 6cm  
 - Shtrese Stabilizanti: 15cm  
 - Cakull mbeturina kave: 20cm  
 - Siperfaqe Germim: 2.01m<sup>3</sup>

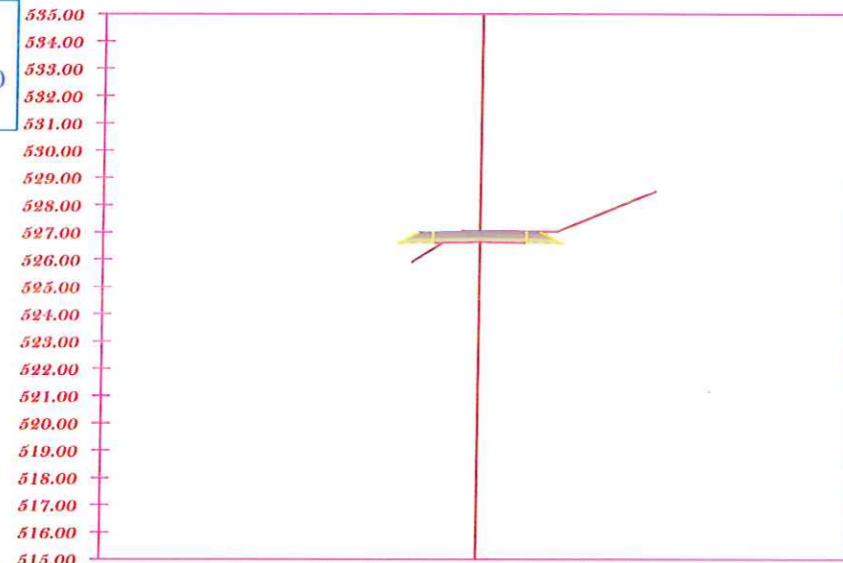

DISTANCA PARC. [m]			0.00			
KUOTA TOKES [m]		526.23	527.04	527.08	527.49	528.31
KUOTA FAKTIKE [m]		526.23	527.04	527.08	527.49	528.31
KUOTA PROJEKTIT [m]		526.23	527.04	527.08	527.49	528.31

- Seksioni: 72  
 - Progresivi: 1+775.00  
 - Shkalla e vizatimit: 200.000  
 - Kuota reference: 514.00

- Shtres Asfaltobteon: 4cm  
 - Shtres binderi : 6cm  
 - Shtrese Stabilizanti: 15cm  
 - Cakull mbeturina kave: 20cm  
 - Siperfaqe Germim: 1.97m<sup>3</sup>

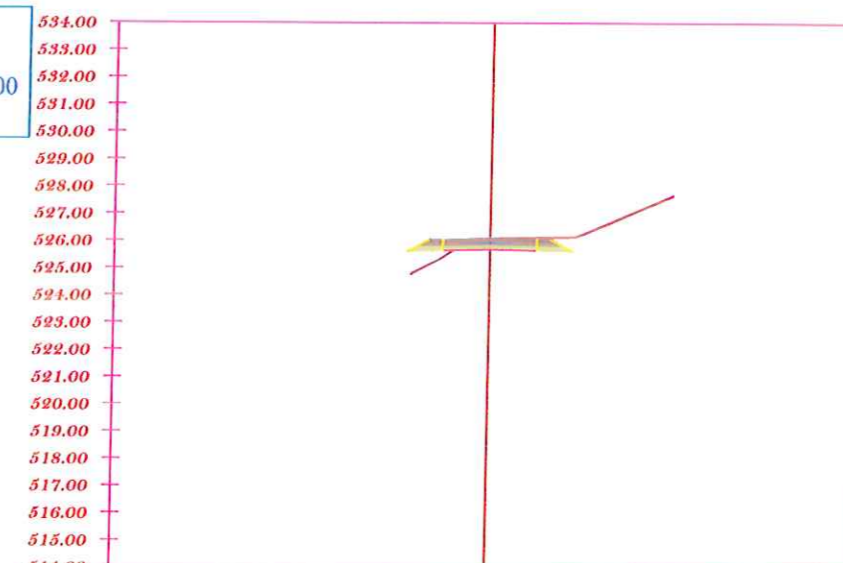

DISTANCA PARC. [m]			0.00			
KUOTA TOKES [m]		525.26	526.09	526.13	526.49	527.33
KUOTA FAKTIKE [m]		525.26	526.09	526.13	526.49	527.33
KUOTA PROJEKTIT [m]		525.26	526.09	526.13	526.49	527.33



Objekti:  
 Studim Projektim Rrugët Rurale  
 Segmenti "Rruga Bylbyl Breçani"



PROJEKTOI

"LAND POINT-AL "  
 Rruga Xhemal Tafaj;  
 Ndertesha nr 5

Projektues

Ing. Mentor Cokaj



SHKALLA

1 : 250

Tiranë 2022

FLETA

F - 36

Format A3



- Seksioni: 73  
 - Progresivi: 1+800.00  
 - Shkalla e vizatimit: 200.000  
 - Kuota reference: 513.00

- Shtres Asfaltobton: 4cm  
 - Shtres binderi : 6cm  
 - Shtrese Stabilizanti: 15cm  
 - Cakull mbeturina kave: 20cm  
 - Siperfaqe Germim: 2.81m<sup>3</sup>

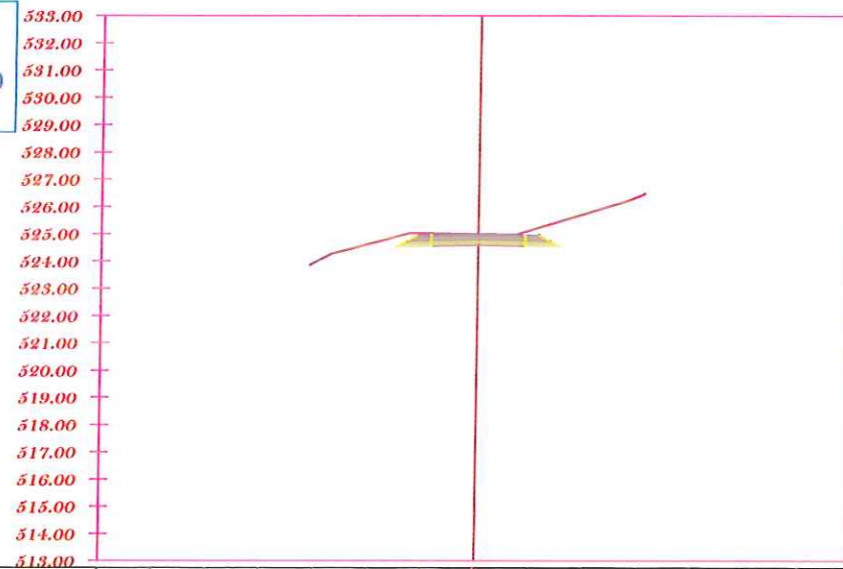

DISTANCA PARC. [m]									
KUOTA TOKES [m]									
KUOTA FAKTIKE [m]									
KUOTA PROJEKTIT [m]									

- Seksioni: 74  
 - Progresivi: 1+825.00  
 - Shkalla e vizatimit: 200.000  
 - Kuota reference: 512.00

- Shtres Asfaltobton: 4cm  
 - Shtres binderi : 6cm  
 - Shtrese Stabilizanti: 15cm  
 - Cakull mbeturina kave: 20cm  
 - Siperfaqe Germim: 3.21m<sup>3</sup>

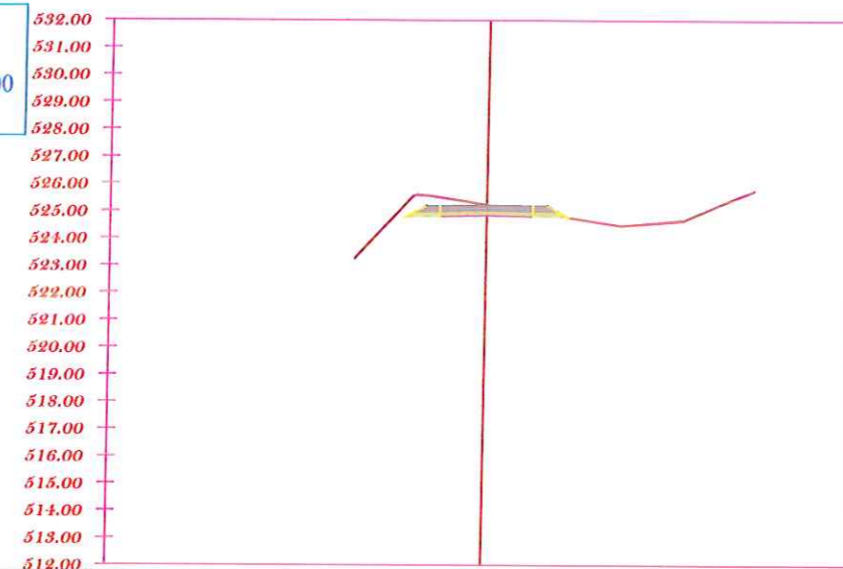

DISTANCA PARC. [m]									
KUOTA TOKES [m]									
KUOTA FAKTIKE [m]									
KUOTA PROJEKTIT [m]									



Objekti:  
 Studim Projektim Rrugët Rurale  
 Segmenti "Rruga Bylbyl Breçani"



PROJEKTOI

"LAND POINT-AL "  
 Rruga Xhemal Tafaj;  
 Ndertesha nr 5

Projektues  
 Ing. Mentor Cokaj



SHKALLA  
 1 : 250  
 Tiranë 2022

FLETA  
 F - 37  
 Format A3

- Seksioni: 75  
 - Progresivi: 1+850.00  
 - Shkalla e vizatimit: 200.000  
 - Kuota reference: 511.00

- Shtres Asfaltobton: 4cm  
 - Shtres binderi : 6cm  
 - Shtrese Stabilizanti: 15cm  
 - Cakull mbeturina kave: 20cm  
 - Siperfaqe Germim: 2.74m<sup>3</sup>

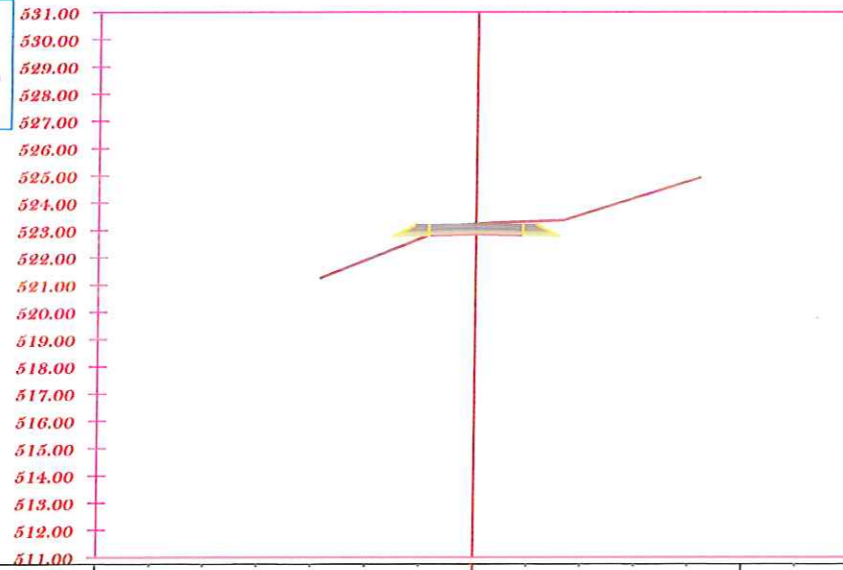



DISTANCA PARC. [m]			0.00						
KUOTA TOKES [m]			521.93	522.71	523.23	523.32	523.60	524.21	524.82
KUOTA FAKTIKE [m]			521.93	522.71	523.23	523.32	523.60	524.21	524.82
KUOTA PROJEKTIT [m]			521.93	522.71	523.23	523.32	523.60	524.21	524.82

- Seksioni: 76  
 - Progresivi: 1+875.00  
 - Shkalla e vizatimit: 200.000  
 - Kuota reference: 508.00

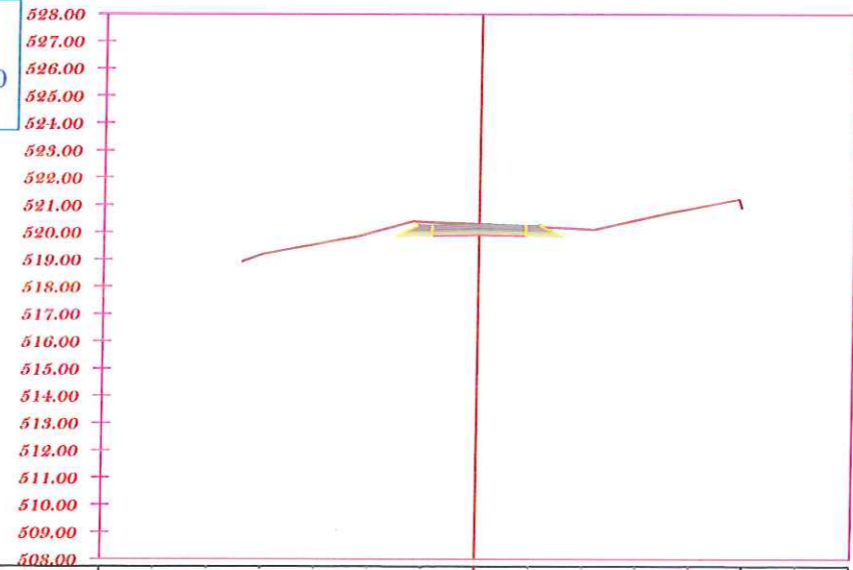
- Shtres Asfaltobton: 4cm  
 - Shtres binderi : 6cm  
 - Shtrese Stabilizanti: 15cm  
 - Cakull mbeturina kave: 20cm  
 - Siperfaqe Germim: 2.61m<sup>3</sup>



DISTANCA PARC. [m]			0.00						
KUOTA TOKES [m]			519.20	519.57	519.98	520.37	520.36	520.21	520.12
KUOTA FAKTIKE [m]			519.20	519.57	519.98	520.37	520.36	520.21	520.12
KUOTA PROJEKTIT [m]			519.20	519.57	519.98	520.37	520.36	520.21	520.12

 POROSITESI: Bashkia Tropojë	Objekti:	 PROJEKTOI "LAND POINT-AL" Rruga Xhemal Tafaj; Ndertesha nr 5	Projektues		SHKALLA 1 : 250 Tiranë 2022	FLETA F - 38 Format A3
			Studim Projektim Rrugët Rurale Segmenti "Rruga Bylbyl Breçani"	Ing. Mentor Cokaj		





- Seksioni: 77  
 - Progresivi: 1+900.00  
 - Shkalla e vizatimit: 200.000  
 - Kuota reference: 505.00

- Shtres Asfaltobton: 4cm  
 - Shtres binderi : 6cm  
 - Shtrese Stabilizanti: 15cm  
 - Cakull mbeturina kave: 20cm  
 - Siperfaqe Germim: 3.08m<sup>3</sup>

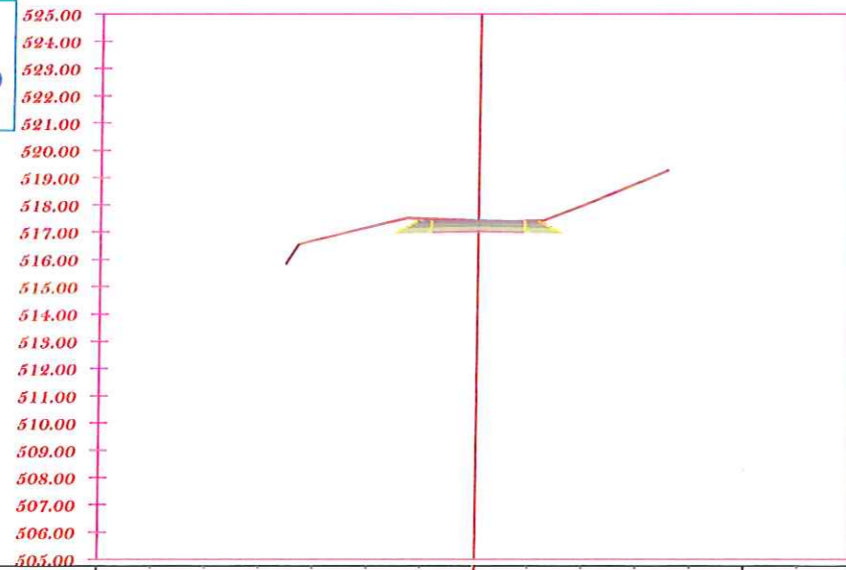



DISTANCA PARC. [m]		0.00	0.00	0.00	0.00	0.00	0.00	0.00
KUOTA TOKES [m]		516.72	517.21	517.50	517.43	517.42	518.02	518.85
KUOTA FAKTIKE [m]		516.72	517.21	517.50	517.43	517.42	518.02	518.85
KUOTA PROJEKTTIT [m]		516.72	517.21	517.50	517.43	517.42	518.02	518.85

- Seksioni: 78  
 - Progresivi: 1+925.00  
 - Shkalla e vizatimit: 200.000  
 - Kuota reference: 503.00

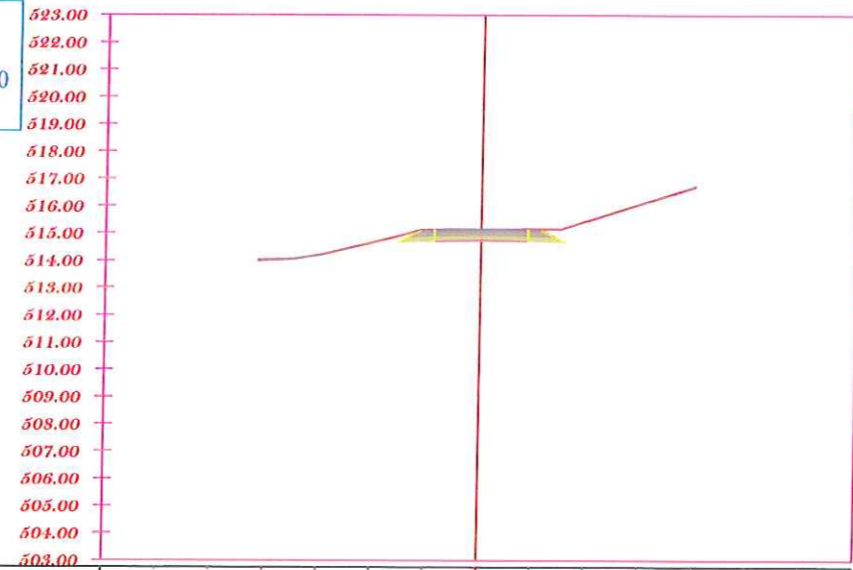
- Shtres Asfaltobton: 4cm  
 - Shtres binderi : 6cm  
 - Shtrese Stabilizanti: 15cm  
 - Cakull mbeturina kave: 20cm  
 - Siperfaqe Germim: 2.91m<sup>3</sup>



DISTANCA PARC. [m]		0.00	0.00	0.00	0.00	0.00	0.00	0.00
KUOTA TOKES [m]		514.02	514.21	514.68	515.12	515.15	515.16	515.49
KUOTA FAKTIKE [m]		514.02	514.21	514.68	515.12	515.15	515.16	515.49
KUOTA PROJEKTTIT [m]		514.02	514.21	514.68	515.12	515.15	515.16	515.49

 POROSITESI: Bashkia Tropojë	Objekti: Studim Projektim Rrugët Rurale Segmenti "Rruga Bylbyl Breçani"	 PROJEKTOI "LAND POINT-AL " Rruga Xhemal Tafaj; Ndertesë nr 5	Projektues		SHKALLA 1 : 250 Tiranë 2022	FLETA F - 39 Format A3
			Ing. Mentor Cokaj			

- Seksioni: 79  
 - Progresivi: 1+945.11  
 - Shkalla e vizatimit: 200.000  
 - Kuota reference: 504.00

- Shtres Asfaltbteon: 4cm  
 - Shtres binderi : 6cm  
 - Shtrese Stabilizanti: 15cm  
 - Cakull mbeturina kave: 20cm  
 - Siperfaqe Germim: 2.51m<sup>3</sup>

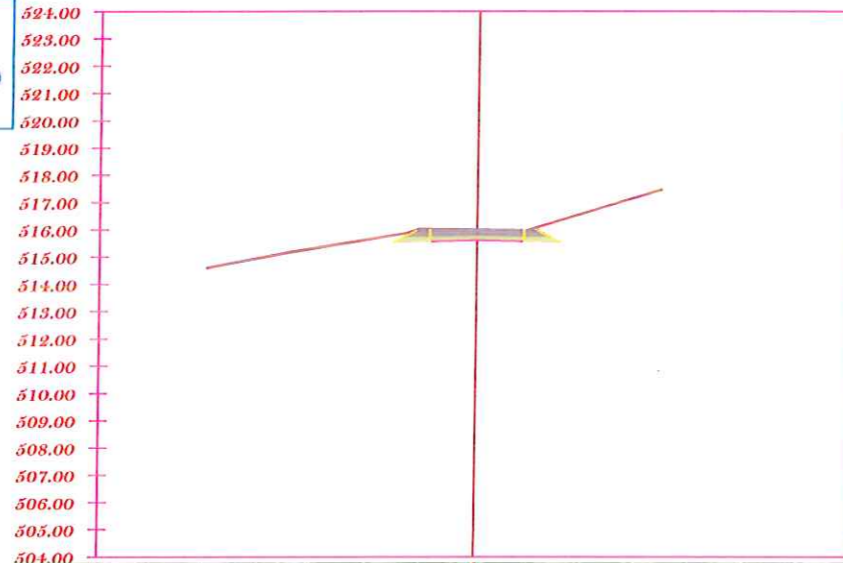

DISTANCA PARC. [m]	0.00	0.00	0.00	0.00	0.00	0.00	0.00	0.00	0.00
KUOTA TOKES [m]	514.60	514.97	515.33	515.65	516.02	516.04	516.02	516.62	517.22
KUOTA FAKTIKE [m]	514.60	514.97	515.33	515.65	516.02	516.04	516.02	516.62	517.22
KUOTA PROJEKTIT [m]	514.60	514.97	515.33	515.65	516.02	516.04	516.02	516.62	517.22



**POROSITESI:**  
 Bashkia Tropojë

**Objekti:**  
 Studim Projektim Rugët Rurale  
 Segmenti "Rruga Bylbyl Breçani"



**PROJEKTOI**  
 "LAND POINT-AL "  
 Rruga Xhemal Tafaj;  
 Ndertesa nr 5

**Projektues**  
 Ing. Mentor Cokaj

*(Signature)*

<b>SHKALLA</b> 1 : 250	<b>FLETA</b> F - 40
Tiranë 2022	Format A3



PROJEKTOI  
LAND POINT-AL

REPUBLIKA E SHQIPERISË  
BASHKIA TROPOJE





MIRATOHET  
KRYETARI I BASHKISE

Z. REXHE BYBERI

# PROJEKT ZBATIMI

OBJEKTI I RRUGËS "BYLBYL BREÇANI", LAGJIA BREÇAN, FSHATI MARKAJ, BASHKIA TROPOJË

## HIDROGRAFIA

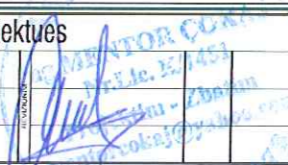
 <b>POROSITESI:</b> Bashkia Tropojë	<b>Objekti:</b> Studim Projektim Rrugët Rurale Segmenti "Ruga Bylbyl Breçani "	 <b>PROJEKTOI</b> "LAND POINT-AL " Rruga Xhemal Tafaj; Ndertesa nr 5	<b>Projektues</b> Ing. Mentor ÇOKAJ		<b>SHKALLA</b>	<b>FLETA</b>
	Tiranë 2022				Format A3	

# HIDROGRAFIA

TOMBINO Ø600 B/A

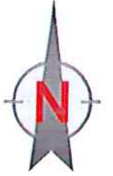

PRERJE NE AKS E TOMBINOS

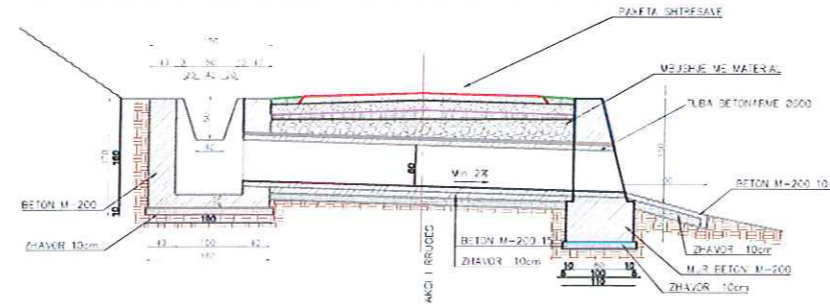

VOLUMET E PUNES

EMERTIMI	m <sup>3</sup>
PUSETA	3.30
PORTALI	3.60
DHEMBI + SHITESA	0.10
<b>TOTALI</b>	<b>7.0</b>
SHITESA ZHAVORRI	1.23

PRERJA 1-1

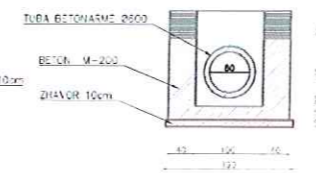

PLANIMETRIA

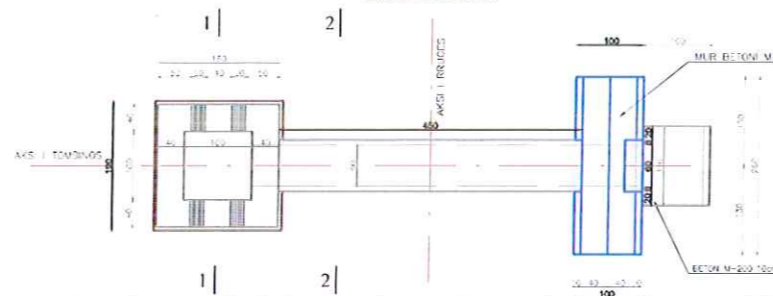

PRERJA 2-2

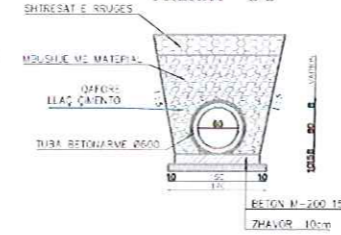

PRERJE NE AKS E TOMBINOS

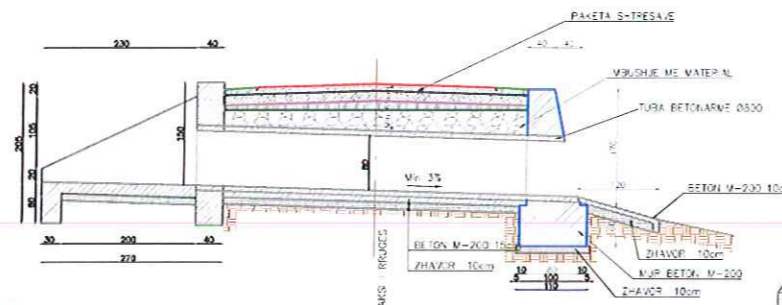

VOLUMET E PUNES

EMERTIMI	m <sup>3</sup>
PORTALI HYRIJES	3.05
PORTALI I DALJES	4.35
DHEMBI + SHITESA	1.80
<b>TOTALI</b>	<b>9.2</b>
SHITESA ZHAVORRI	1.60

PAMJA BALLORE

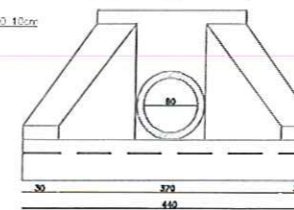

PLANIMETRIA

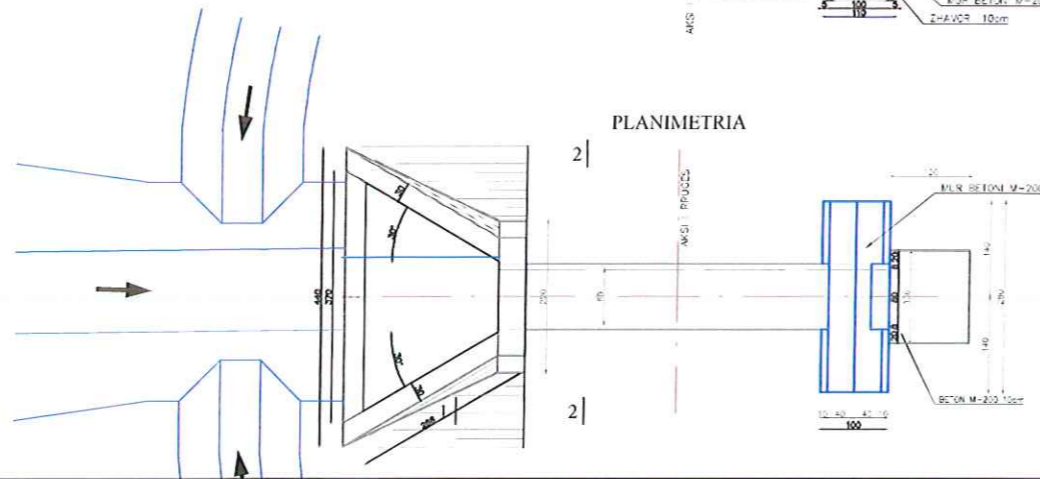

PRERJA 2-2

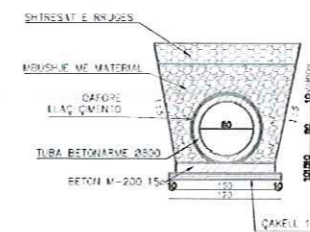

POROSITESI:

Bashkia Tropojë

Objekti:

Studim Projektim Rrugët Rurale  
Segmenti "Rruga Bylbyl Breçani"

PROJEKTOI

LAND  
POINT-AL

"LAND POINT-AL"

Rruga Xhemal Tafaj;  
Ndertesa nr 5

Projektues

Ing. Mentor COKAJ

SHKALLA

1: 10000

Tiranë 2022

FLETA

G-01

Format A3





PROJEKTOI  
LAND POINT-AL

REPUBLIKA E SHQIPERISË  
BASHKIA TROPOJE



MIRATOHET  
KRYETARI I BASHKISE

Z. REXHE BYBERI

# PROJEKT ZBATIMI

OBJEKTI I RRUGËS "BYLBYL BREÇANI", LAGJIA BREÇAN, FSHATI MARKAJ, BASHKIA TROPOJË

## PLANIMETRIA E NDRICIMIT

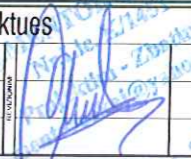
 POROSITESI: Bashkia Tropojë	Objekti: Studim Projektim Rrugët Rurale Segmenti "Ruga Bylbyl Breçani"	PROJEKTOI		Projektues		SHKALLA	FLETA
			"LAND POINT-AL " Rruga Xhemal Tafaj; Nderesa nr 5	Ing. Mentor COKAJ		Tiranë 2022	Format A3

# PLANIMETRIA E NDRICIMIT

## LEGJENDE

-  Shtyllë ndricimi (Hsh=7.0m)
-  Tub fiekabel elektrik F=80mm
-  Tub metallik F=168mm per kabl m linje ne rruge
-  Tub fiekabel me 2 shtrësa F=76mm per ndricim
-  Puseta kontrolli

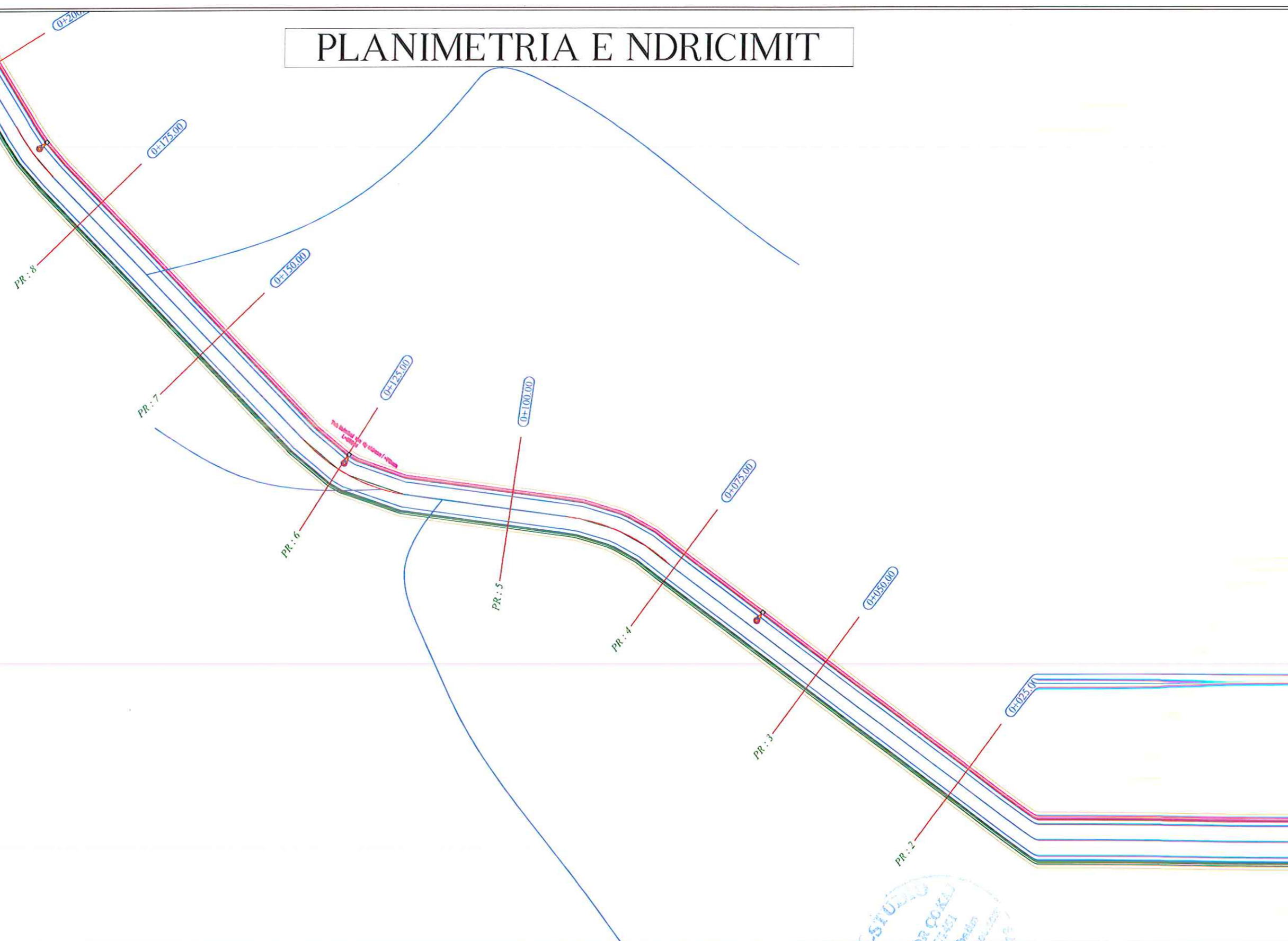

 POROSITESI: Bashkia Tropojë	Objekti: Studim Projektim Rrugët Rurale Segmenti "Rruga Bylbyl Breçani"	PROJEKTOI  "LAND POINT-AL" Rruga Xhemal Tafaj; Ndertesë nr 5	Projektues Ing. Mentor COKAJ 	SHI 1: Tirar
				







# PLANIMETRIA E NDRICIMIT

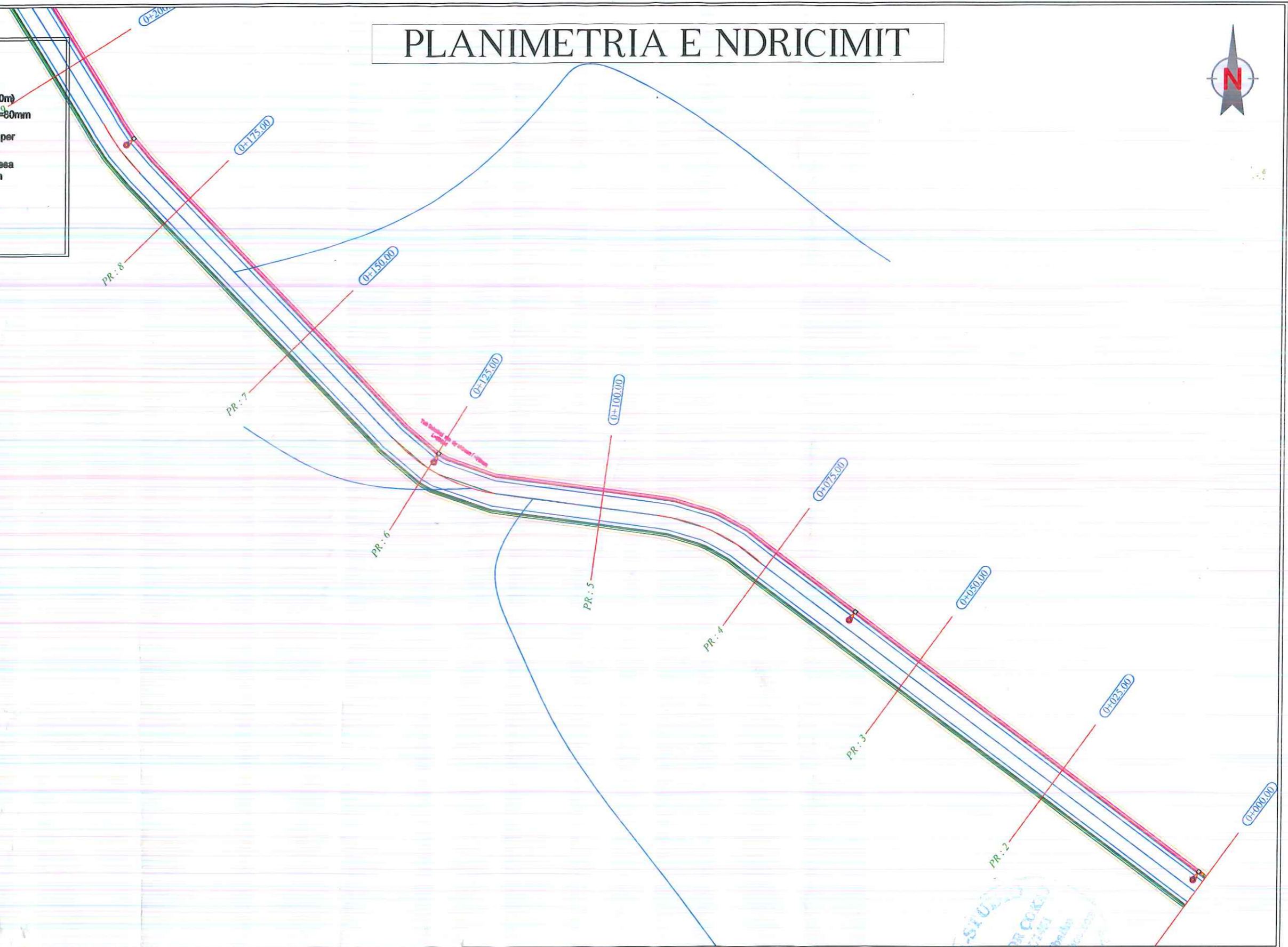

- LEGJENDE**
-  Shtyllë ndricimi (Hsh=7.0m)
  -  Tub fleksibel elektrik 2f =80mm
  -  Tub metalik F =168mm per kalim linje ne rruge
  -  Tub fleksibel me 2 shtresa F =76mm per ndricim
  -  Puseta kontrolli

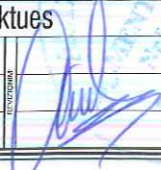

 <b>POROSITESI:</b> Bashkia Tropojë	<b>Objekti:</b> Studim Projektim Rrugët Rurale Segmenti "Rruga Bylbyl Breçani"	<b>PROJEKTOI</b>		<b>Projektues</b>			<b>SHKALLA</b>	<b>FLETA</b>
			<b>"LAND POINT-AL "</b> Rruga Xhemal Tafaj; Ndertesë nr 5	Ing. Mentor COKAJ			1 : 500	H-01
							Tiranë 2022	Format A3



# PLANIMETRIA E NDRICIMIT



**LEGJENDE**

- Shtyllë ndricimi (H=7.0m)
- Tub fleksibel elektrik 2f =80mm
- Tub metalik F=168mm per kalim linjë ne rruge
- Tub fleksibel me 2 shtresa F=75mm per ndricim
- Puseta kontrolli

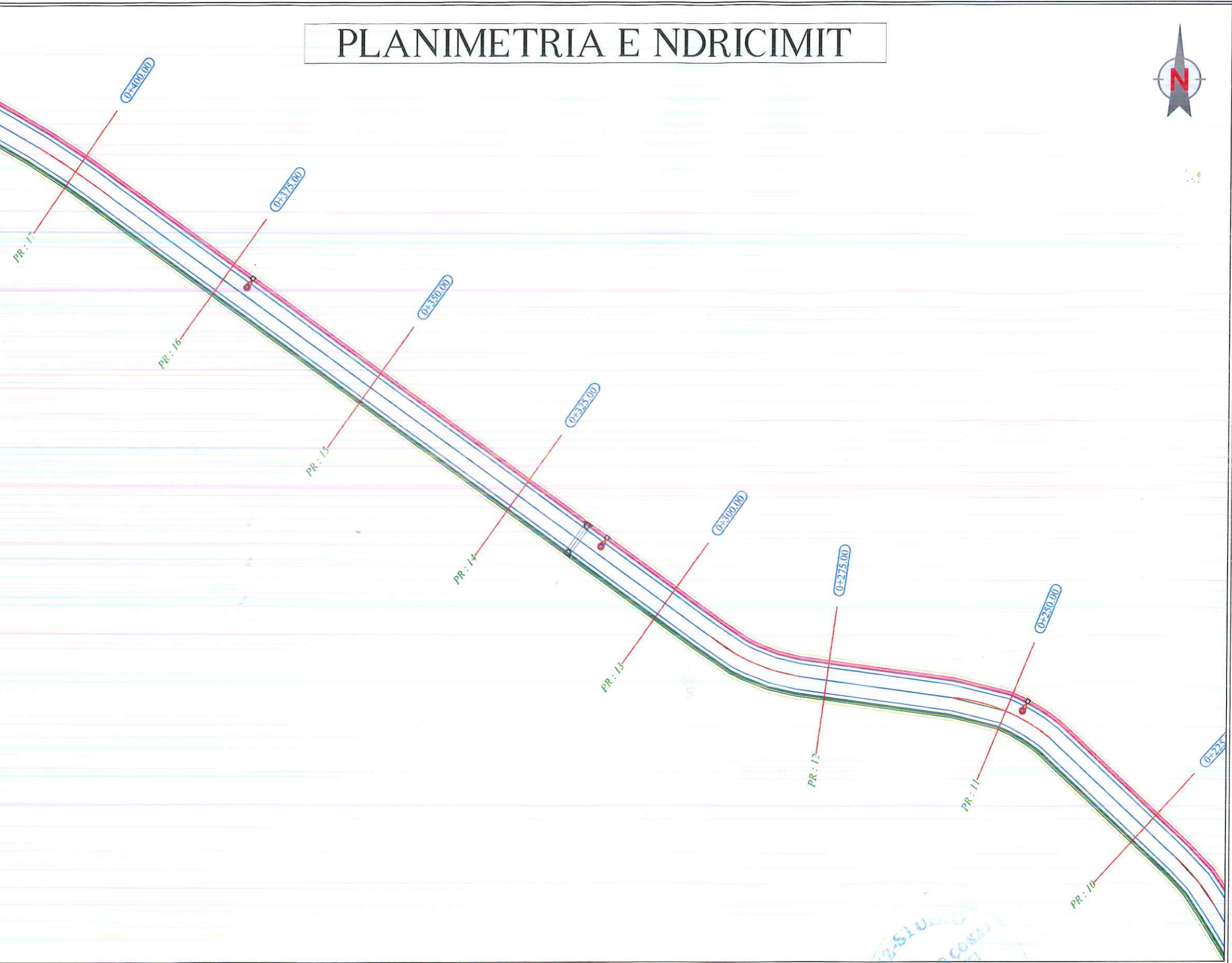

 POROSITESI: Bashkia Tropojë	Objekti: Studim Projektim Rrugët Rurale Segmenti "Rruga Bylbyl Breçani"	 PROJEKTOI "LAND POINT-AL" Rruga Xhemal Tafaj; Ndertesa nr 5	Projektues Ing. Mentor ÇOKAJ 			SHKALLA 1 : 500	FLETA H-02
						Tiranë 2022	Format A3



# PLANIMETRIA E NDRICIMIT



## LEGJENDE

- Shtyllë ndricimi (Hoh=7.0m)
- Tub Fleksibel elektriku 2f =80mm
- Tub metalik F =168mm per kalim linje ne rruge
- Tub fleksibel me 2 shtresa F =75mm per ndricim
- Pusete kontrolli

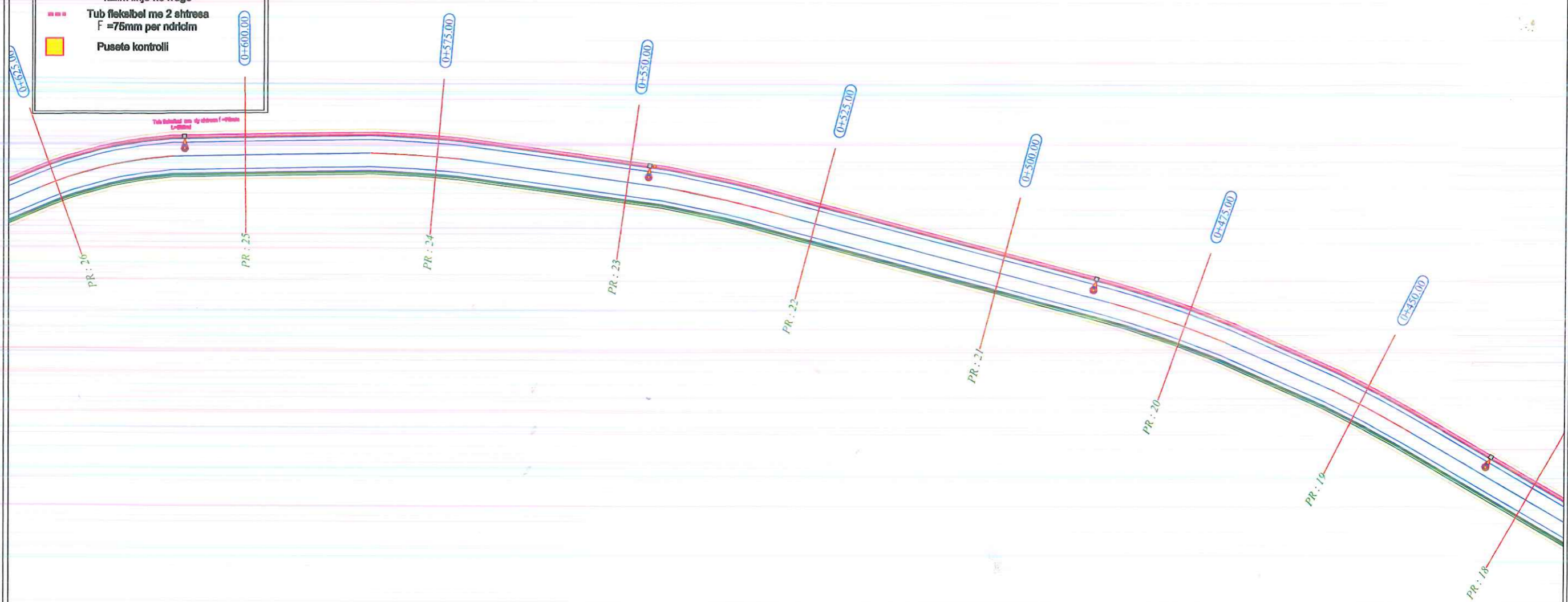

 POROSITESI: Bashkia Tropojë	Objekti: Studim Projektim Rrugët Rurale Segmenti "Rruga Bylbyl Breçani"	 PROJEKTOI "LAND POINT-AL " Rruga Xhemal Tafaj; Ndertesa nr 5	Projektues				SHKALLA	FLETA
			Ing. Mentor COKAJ					1 : 500
						Tiranë 2022	Format A3	

# PLANIMETRIA E NDRICIMIT



- LEGJENDE**
- Shtyllë ndricimi (Hsh=7.0m)
  - Tub fiekabel elektriku 2f =80mm
  - Tub metalik F =168mm per kalim linje ne rruge
  - Tub fiekabel me 2 shtresa F =75mm per ndricim
  - Pusete kontrolli

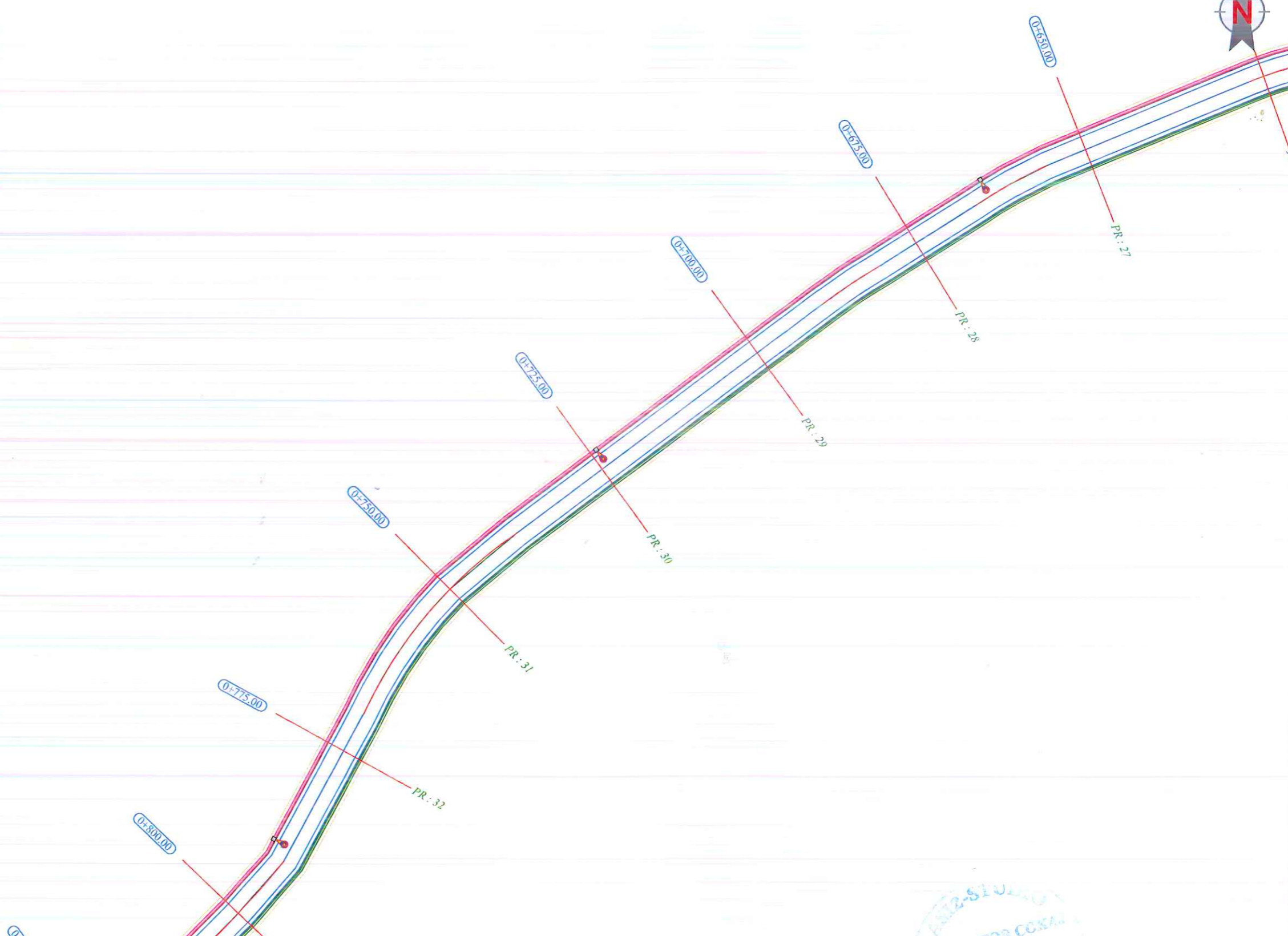

 POROSITESI: Bashkia Tropojë	Objekti: Studim Projektim Rrugët Rurale Segmenti "Rruga Bylbyl Breçani"	 PROJEKTOI "LAND POINT-AL" Rruga Xhemal Tafaj; Ndertesa nr 5	Projektues		SHKALLA	FLETA
			Ing. Mentor COKAJ		1 : 500	H-04
					Tiranë 2022	Format A3



# PLANIMETRIA E NDRICIMIT

## LEGJENDE

-  Shtyllë ndricimi (Hah=7.0m)
-  Tub Fiekalbel elektriku 2f =80mm
-  Tub metallik F =168mm per kalim linje ne ruge
-  Tub fiekalbel me 2 shtresa F =76mm per ndricim
-  Pusete kontrolli

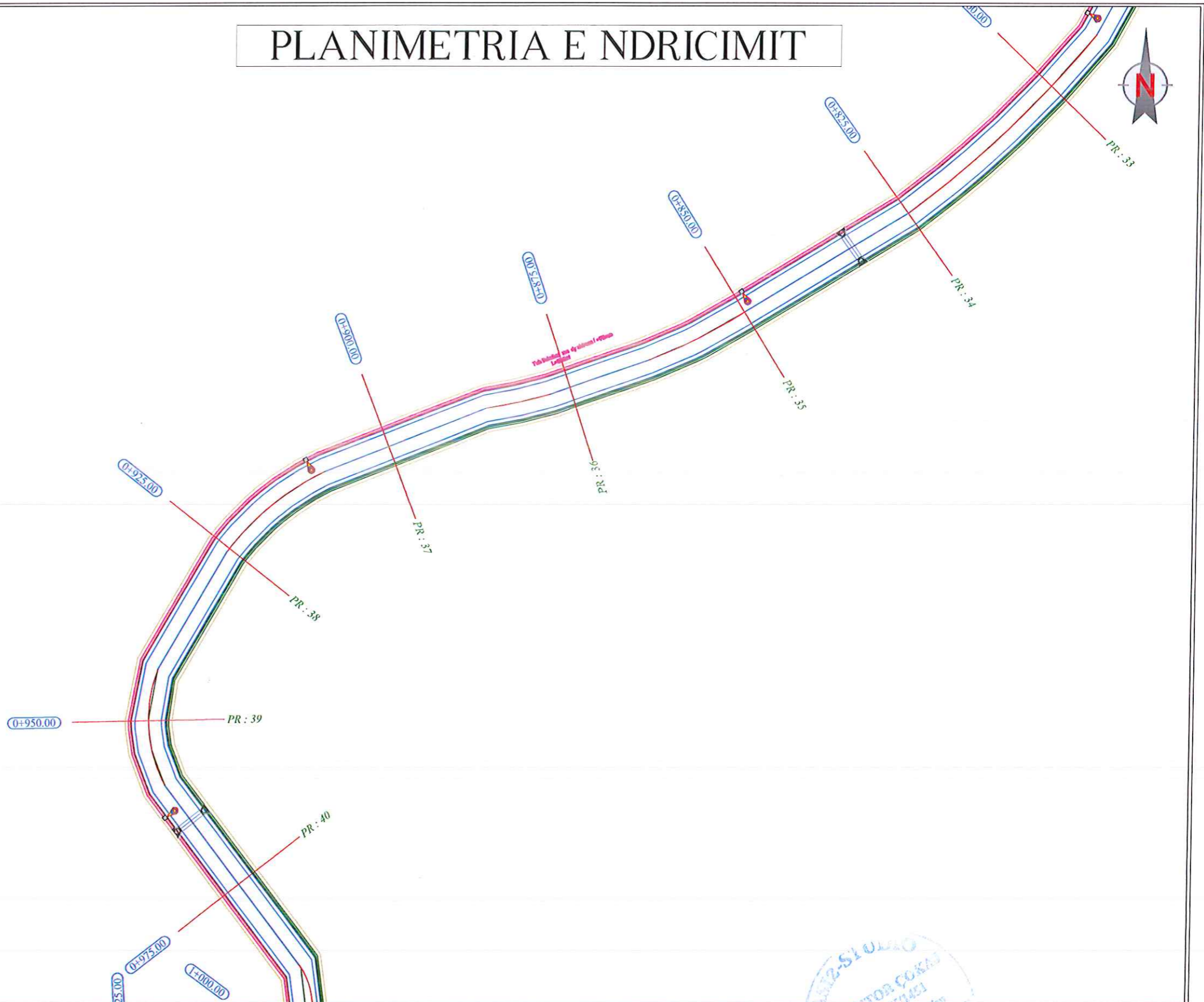

# PLANIMETRIA E NDRICIMIT



## LEGJENDE

- Shtyllë ndricimi (Hsh=7.0m)
- Tub fletelbel elektriku 2f =80mm
- Tub metalik F =168mm per kalim linje ne rruge
- Tub fletelbel me 2 shtresa F =76mm per ndricim
- Pusete kontrolli

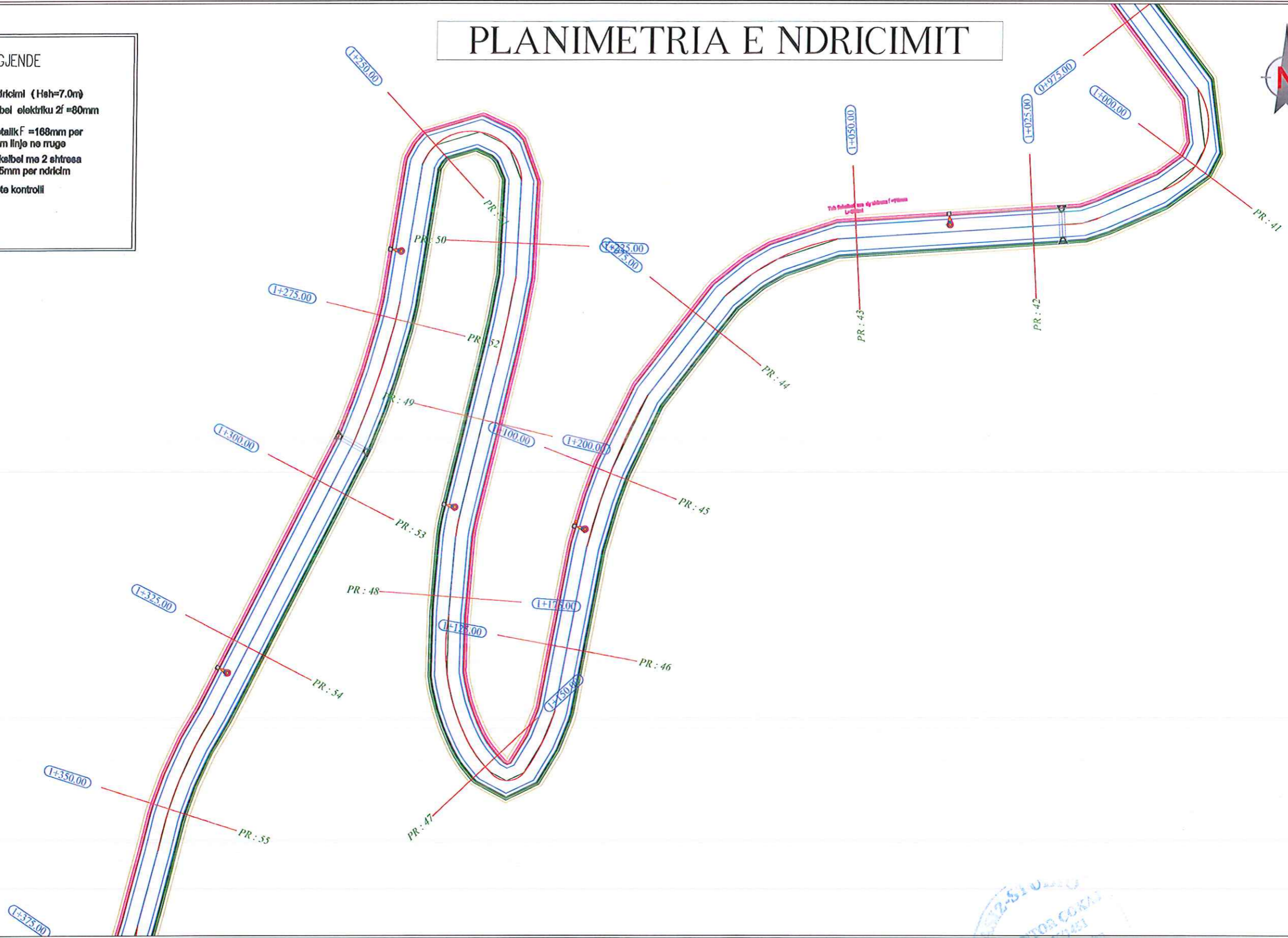

	<b>POROSITESI:</b> Bashkia Tropojë	<b>Objekti:</b> Studim Projektim Rrugët Rurale Segmenti "Ruga Bylbyl Breçani"	<b>PROJEKTOI</b> 	"LAND POINT-AL" Rruga Xhemal Tafaj; Ndertesha nr 5	<b>Projektues</b> Ing. Mentor COKAJ		<b>SHKALLA</b> 1 : 500 Tiranë 2022	<b>FLETA</b> H-06 Format A3
	<div style="text-align: right; font-size: small; color: blue;">                 12-51-0000                  MENTOR COKAJ                  Inxhinjeri                  Rruga Xhemal Tafaj                  Ndertesha nr 5             </div>							





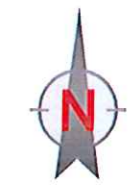

# PLANIMETRIA E NDRICIMIT

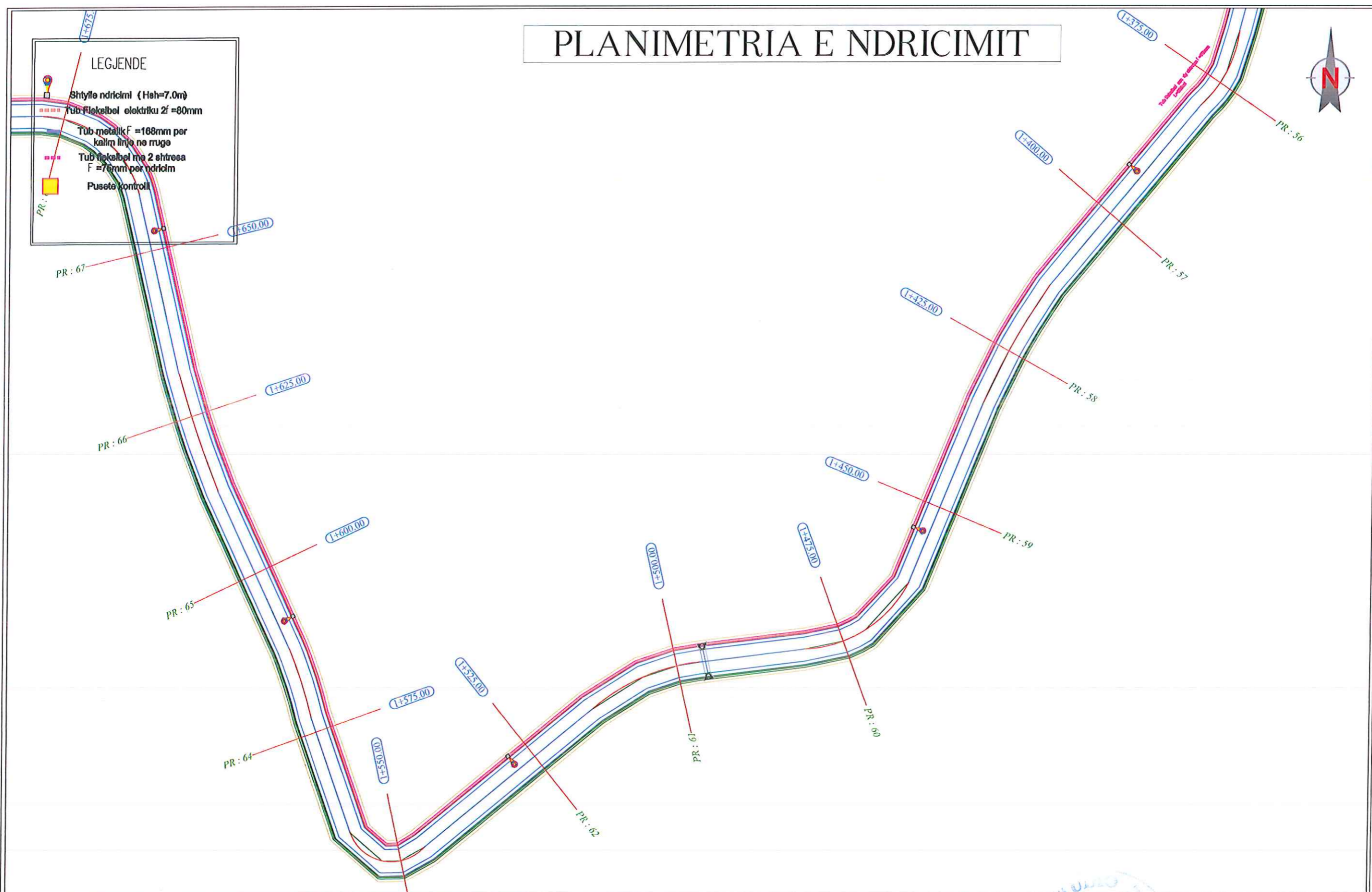

**LEGJENDE**



- Shtyllë ndricimi (Hsh=7.0m)
- Tub fidelebel elektriku 2f =80mm
- Tub metalik F =168mm per kalim linje ne rruge
- Tub fidelebel me 2 shtresa F =76mm per ndricim
- Pusete kontrolli







<b>POROSITESI:</b>  Bashkia Tropojë	<b>Objekti:</b> Studim Projektim Rrugët Rurale Segmenti "Rruga Bylbyl Breçani"	<b>PROJEKTOI</b>  "LAND POINT-AL " Rruga Xhemal Tafaj; Ndertesa nr 5		<b>Projektues</b> Ing. Mentor COKAJ 		<b>SHKALLA</b> 1 : 500	<b>FLETA</b> H-07
						Tiranë 2022	Format A3

# PLANIMETRIA E NDRICIMIT

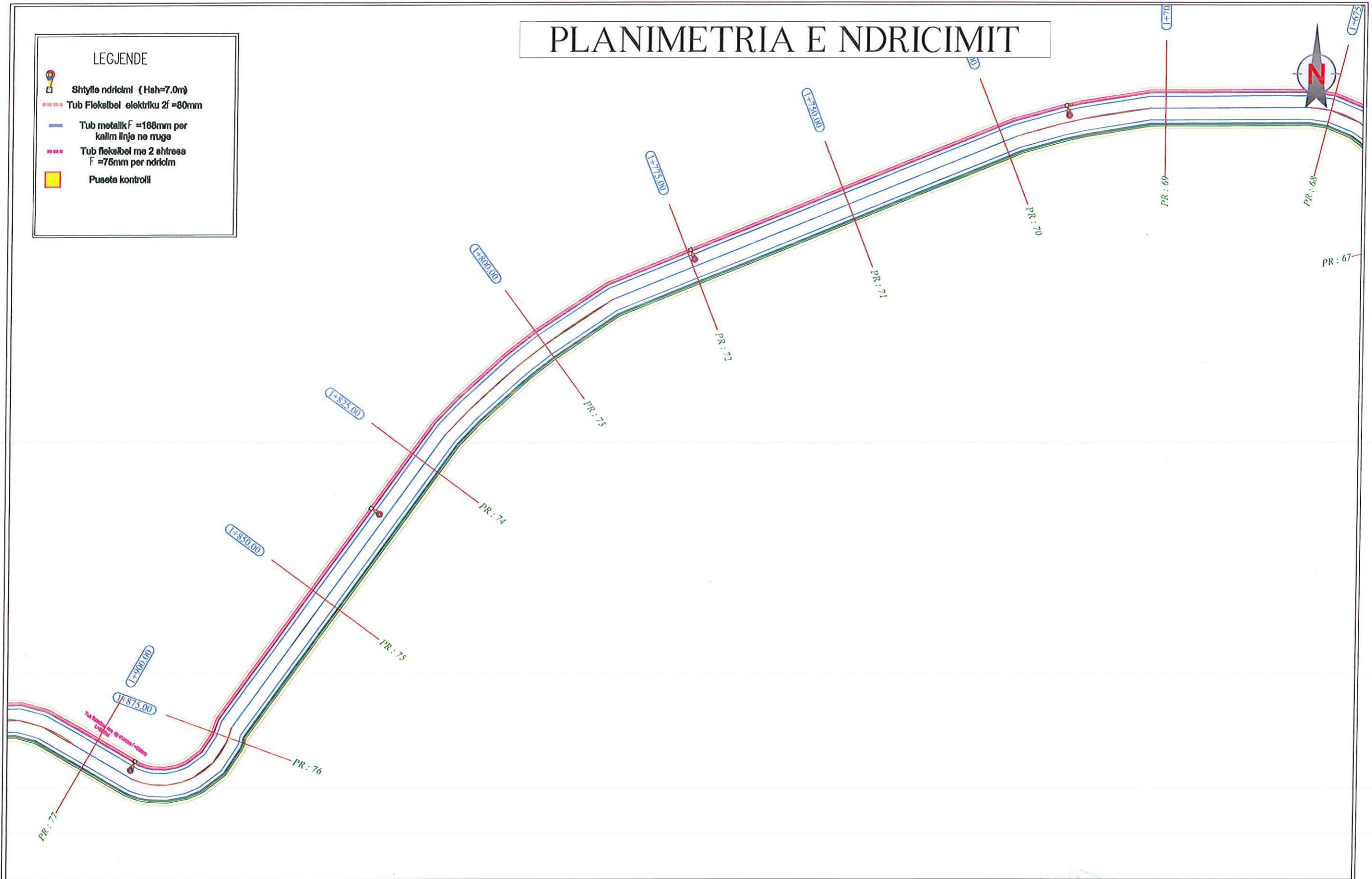
## LEGJENDE

-  Shtyllë ndricimi (Hsh=7.0m)
-  Tub fiekabel elektriku 2f =80mm
-  Tub metallik F =168mm per kalm linje ne rruge
-  Tub fiekabel me 2 shtrësa F =76mm per ndricim
-  Pusete kontrolli







 POROSITESI: Bashkia Tropojë	Objekti: Studim Projektim Rrugët Rurale Segmenti "Rruga Bylbyl Breçani"	PROJEKTOI		Projektues			SHKALLA	FLETA
		 "LAND POINT-AL " Rruga Xhemal Tafaj; Ndertesa nr 5	Ing. Mentor COKAJ		1 : 500	H-08		
							Tiranë 2022	Format A3





# PLANIMETRIA E NDRICIMIT

## LEGJENDE

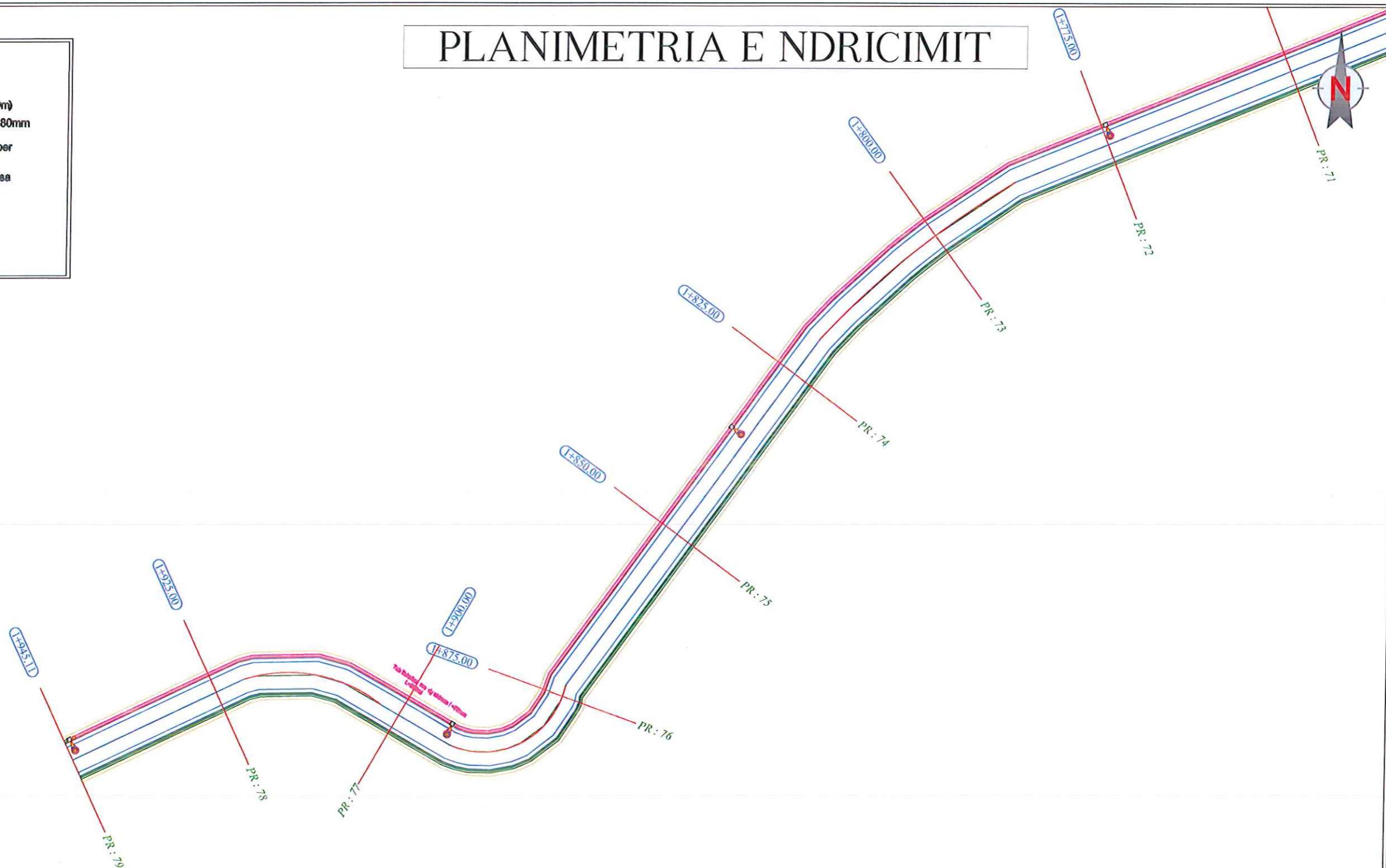
-  Shtyllë ndricimi (Hsh=7.0m)
-  Tub Fiekëlbel elektriku 2f =80mm
-  Tub metallik F =168mm per kalim linje ne rruge
-  Tub fiekëlbel me 2 shtresa F =76mm per ndricim
-  Puseta kontrolli



 <b>POROSITESI:</b> Bashkia Tropojë	<b>Objekti:</b> Studim Projektim Rrugët Rurale Segmenti "Ruga Bylbyl Breçani"	<b>PROJEKTOI</b>		<b>Projektues</b>		<b>SHKALLA</b> 1 : 500	<b>FLETA</b> H-09
				"LAND POINT-AL " Ing. Mentor COKAJ		Tiranë 2022	Format A3



PROJEKTOI  
LAND POINT-AL

REPUBLIKA E SHQIPERISË  
BASHKIA TROPOJE





MIRATOHET  
KRYETARI I BASHKISE

Z. REXHE BYBERI

# PROJEKT ZBATIMI

OBJEKTI I RRUGËS "BYLBYL BREÇANI", LAGJIA BREÇAN, FSHATI MARKAJ, BASHKIA TROPOJË

## PLANIMETRIA E SINJALISTIKES





 <b>POROSITESI:</b> Bashkia Tropojë	<b>Objekti:</b> Studim Projektim Rrugët Rurale Segmenti "Ruga Bylbyl Breçani"	 <b>PROJEKTOI</b> "LAND POINT-AL " Rruga Xhemal Tafaj; Nderresa nr 5	<b>Projektues</b> Ing. Mentor ÇOKAJ  Lic. 8145 Zbatim	<b>SHKALLA</b>	<b>FLETA</b>
				Tiranë 2022	Format A3

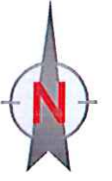





# PLANIMETRIA E SINJALISTIKES

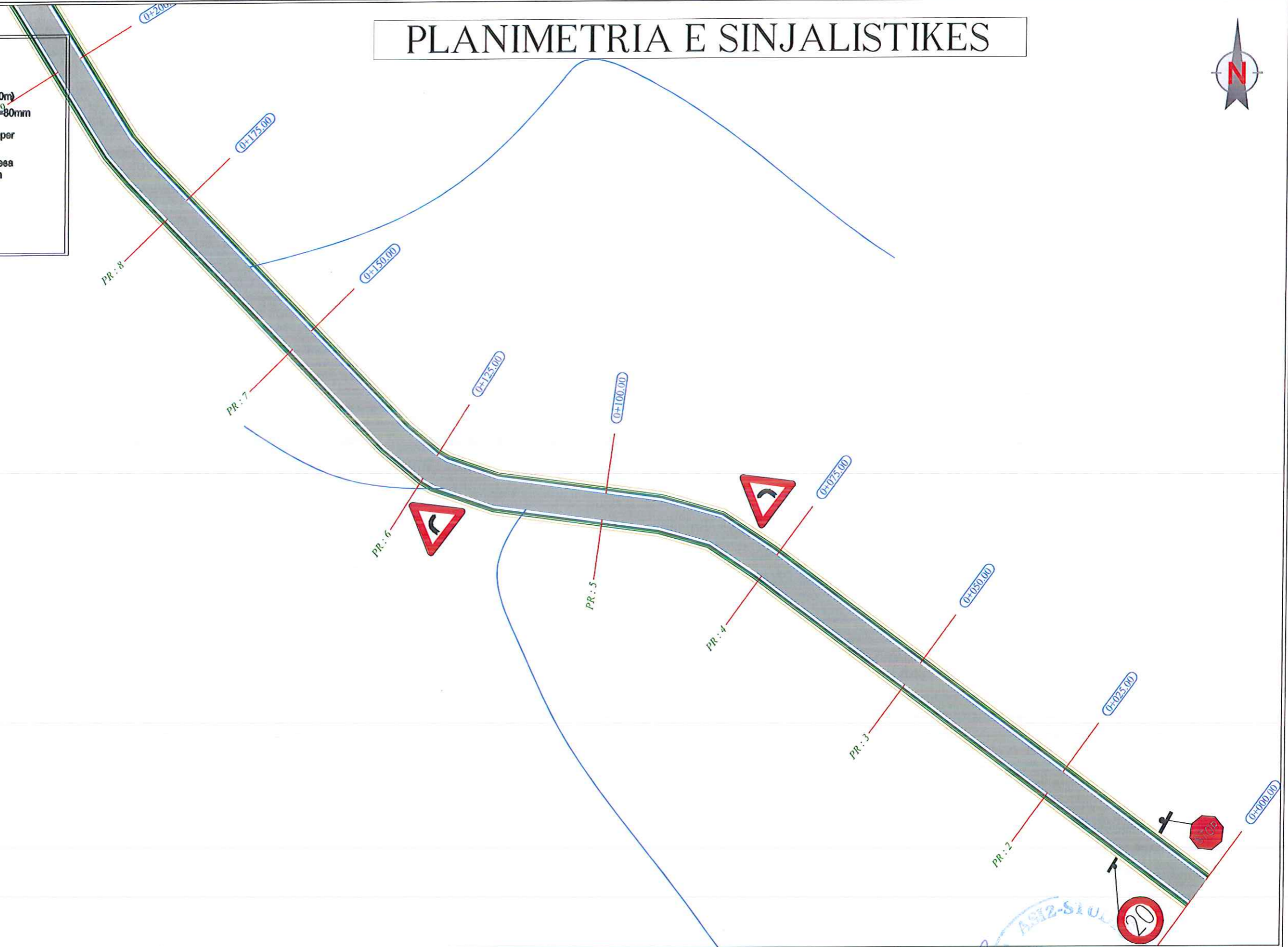

## LEGJENDE

-  Shtyllë ndriçimi (Hsh=7.0m)
-  Tub Fleksibel elektrik  $\varnothing$  = 80mm
-  Tub metalik F = 168mm per kalim linje ne ruge
-  Tub fleksibel me 2 shtrrea F = 75mm per ndriçim
-  Puseta kontrolli



 POROSITESI: Bashkia Tropojë	Objekti: Studim Projektim Rrugët Rurale Segmenti "Rruga Bylbyl Breçani"	PROJEKTOI 	"LAND POINT-AL" Rruga Xhemal Tafaj; Ndertesa nr 5	Projektues Ing. Mentor COKAJ	SHKALLA 1 : 500 Tiranë 2022	FLETA I-01 Format A3
	AS12-S101 					

# PLANIMETRIA E SINJALISTIKES



**LEGJENDE**

- Shtyllë ndricimi (Hajr=7.0m)
- Tub Fiekëlbel elektrik 2f =80mm
- Tub metalik F=168mm per kalim linje ne rruge
- Tub fiekëlbel me 2 shtresa F=76mm per ndricim
- Puseta kontrolli

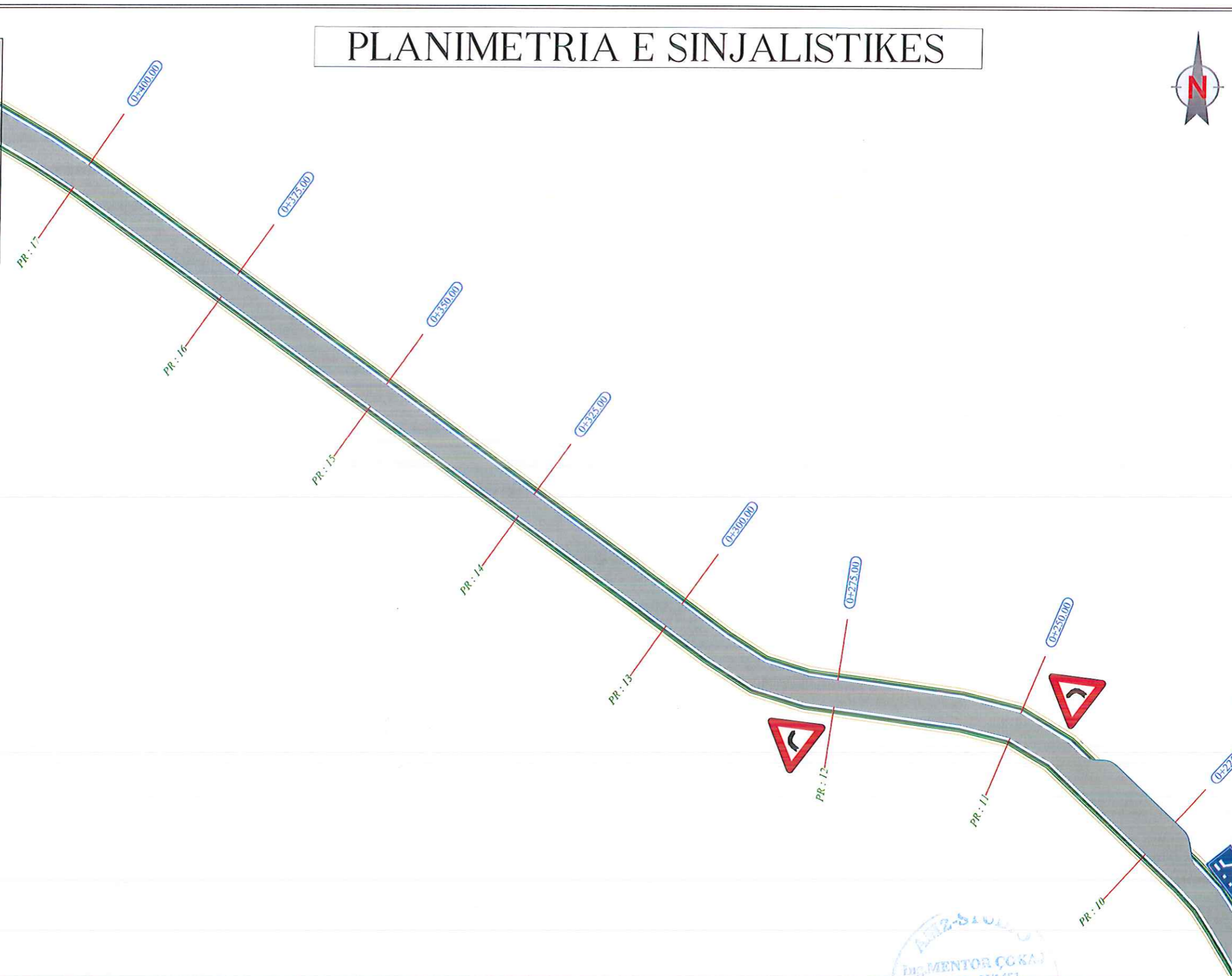

 POROSITESI: Bashkia Tropojë	Objekti: Studim Projektim Rrugët Rurale Segmenti "Rruga Bylbyl Breçani"	PROJEKTOI <b>LAND POINT-AL</b>		Projektues Ing. Mentor ÇOKAJ	SHKALLA 1 : 500	FLETA I-02
		"LAND POINT-AL " Rruga Xhemal Tafaj; Ndertesha nr 5		Tiranë 2022	Format A3	



# PLANIMETRIA E SINJALISTIKES



## LEGJENDE

- Shtyllë ndricimi (Hsh=7.0m)
- Tub fiekalbel elektriku 2f =80mm
- Tub metalik F =168mm per kalim linje ne ruge
- Tub fiekalbel me 2 shtrresa F =76mm per ndricim
- Pusete kontrolli

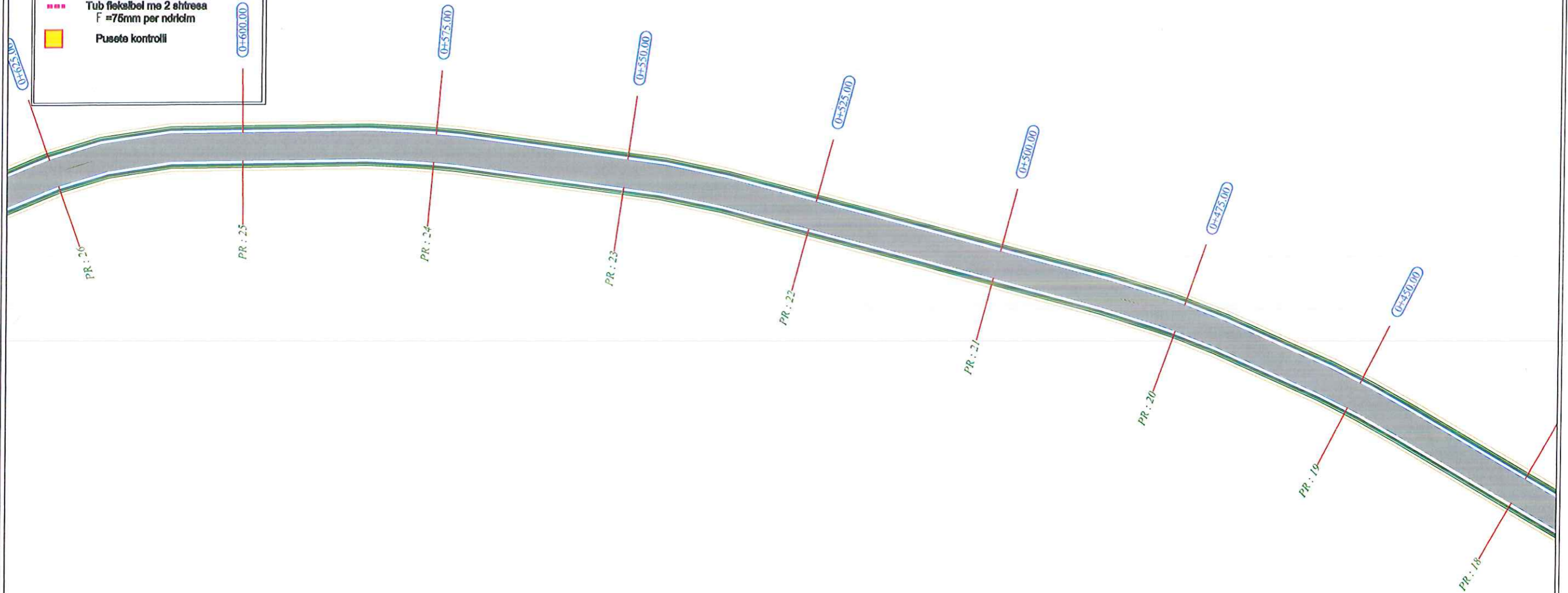

 POROSITESI: Bashkia Tropojë	Objekti: Studim Projektim Rrugët Rurale Segmenti "Rruga Bylbyl Breçani"	PROJEKTOI  "LAND POINT-AL " Rruga Xhemal Tafaj, Ndertesë nr 5	Projektues Ing. Mentor COKAJ 	SHKALLA 1 : 500 Tiranë 2022	FLETA I-03 Format A3

# PLANIMETRIA E SINJALISTIKES

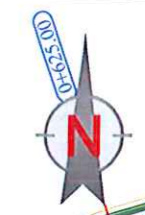

**LEGJENDE**

- Shtyllë ndërcim (Hsh=7.0m)
- Tub Fleksibel elektrik 2f =80mm
- Tub metallik F =168mm per kalim linje në ruge
- Tub fleksibel me 2 shtreë F =76mm per ndërcim
- Pusëtë kontrolli

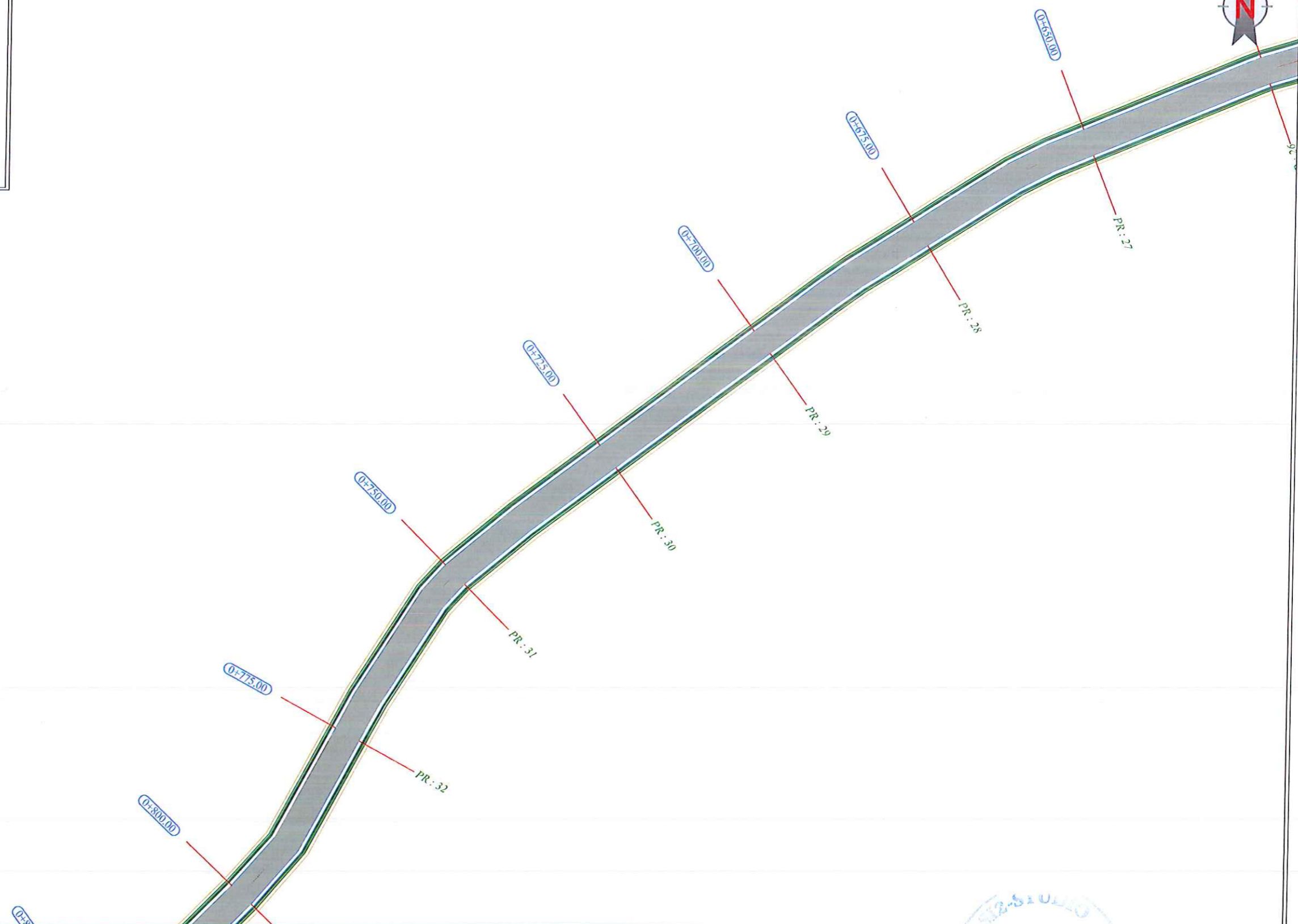





 POROSITESI: Bashkia Tropojë	Objekti: Studim Projektim Rrugët Rurale Segmenti "Rruga Bylbyl Breçani"	PROJEKTOI 		Projektues Ing. Mentor COKAJ		SHKALLA 1 : 500	FLETA I-04
		"LAND POINT-AL " Rruga Xhemal Tafaj; Ndertesa nr 5				Tiranë 2022	Format A3





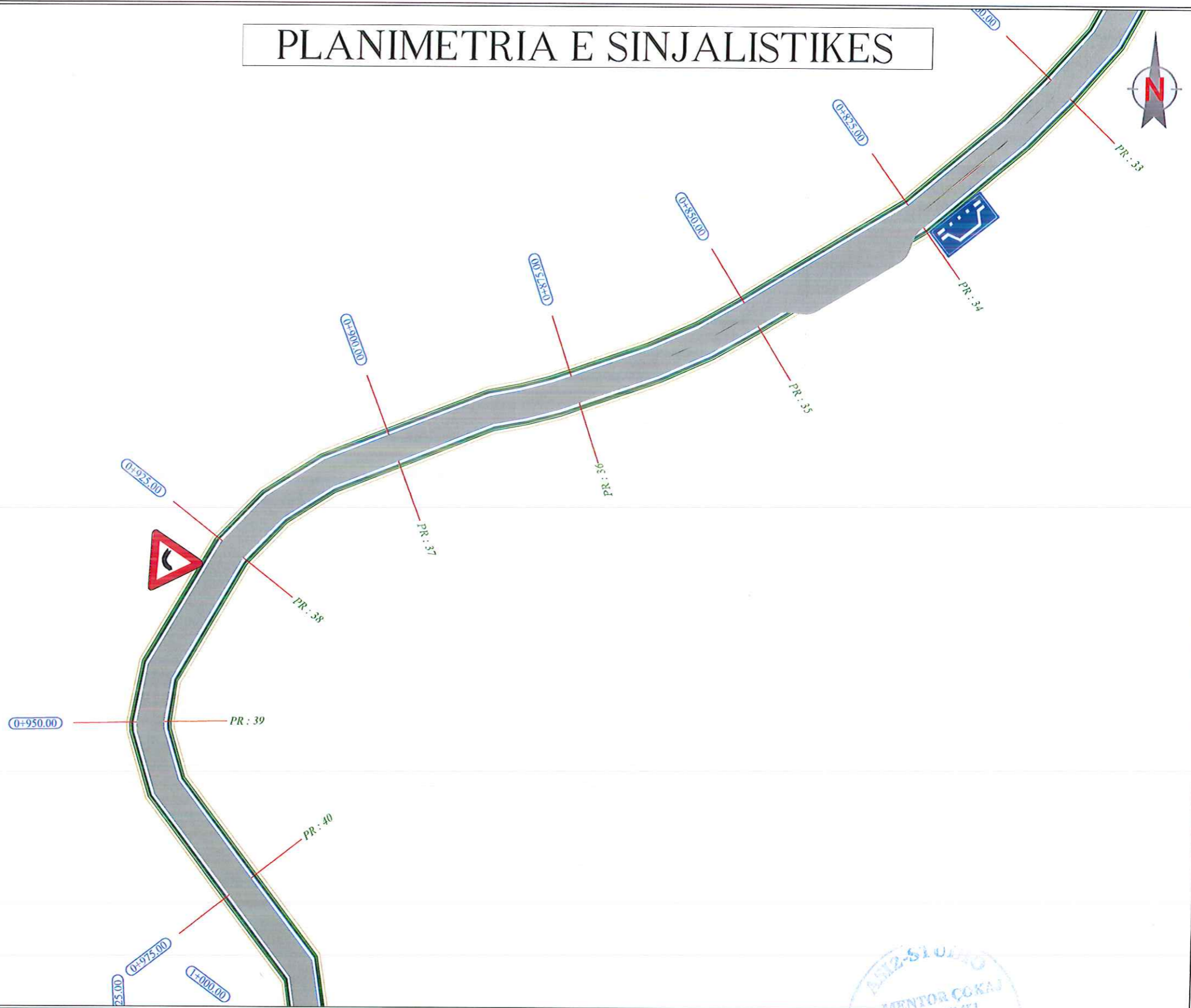

# PLANIMETRIA E SINJALISTIKES

## LEGJENDE

-  Shtyllë ndricimi (Hsh=7.0m)
-  Tub Fiekabel elektriku 2f =80mm
-  Tub metalik F =168mm per kalim linje ne ruge
-  Tub fiekabel me 2 shtresa F =76mm per ndricim
-  Pusete kontrolli





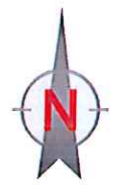

	POROSITESI: Bashkia Tropojë	Objekti: Studim Projektim Rrugët Rurale Segmenti "Rruga Bylbyl Breçani"	PROJEKTOI 	"LAND POINT-AL" Rruga Xhemal Tafaj; Ndertesa nr 5	Projektues Ing. Mentor ÇOKAJ		SHKALLA 1 : 500 Tiranë 2022	FLETA I-05 Format A3
								



# PLANIMETRIA E SINJALISTIKES

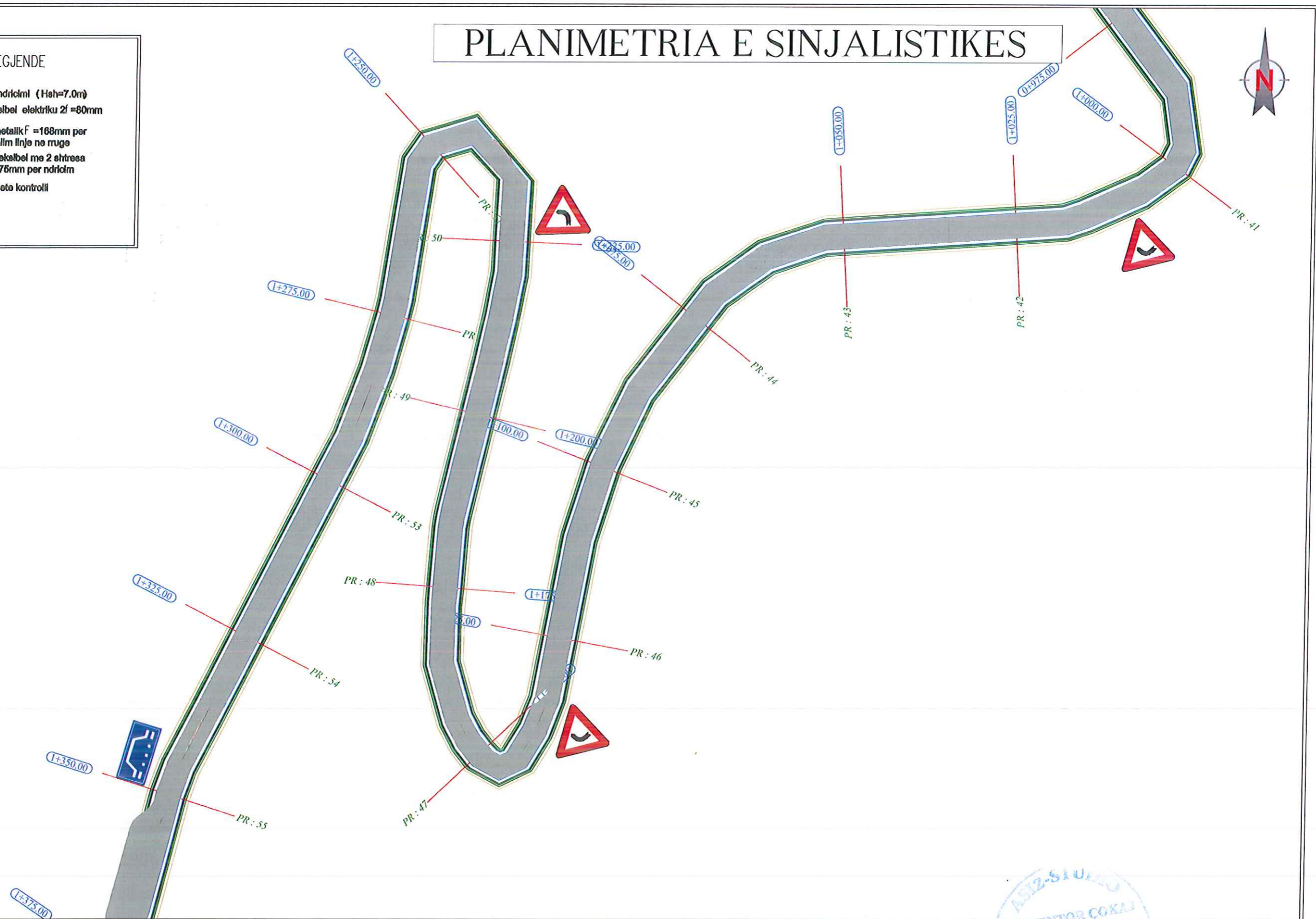

## LEGJENDE

-  Shtyllë ndricimi (Hsh=7.0m)
-  Tub fiekalbel elektriku 2f =80mm
-  Tub metallik F =168mm per kalim linje ne ruge
-  Tub fiekalbel me 2 shtresa F =76mm per ndricim
-  Pusete kontrolli



 POROSITESI: Bashkia Tropojë	Objekti: Studim Projektim Rrugët Rurale Segmenti "Rruga Bylbyl Breçani"	 PROJEKTOI "LAND POINT-AL" Rruga Xhemal Tafaj; Nderresa nr 5	Projektues Ing. Mentor COKAJ		SHKALLA 1 : 500 Tiranë 2022	FLETA I-06 Format A3
						



# PLANIMETRIA E SINJALISTIKES

**LEGJENDE**

- Shtyllë ndricimi (Hsh=7.0m)
- Tub fleksibel elektriku 2f =80mm
- Tub metalik F =168mm per kalim linje ne rruge
- Tub fleksibel me 2 shtresa F =75mm per ndricim
- Pusete kontrolli

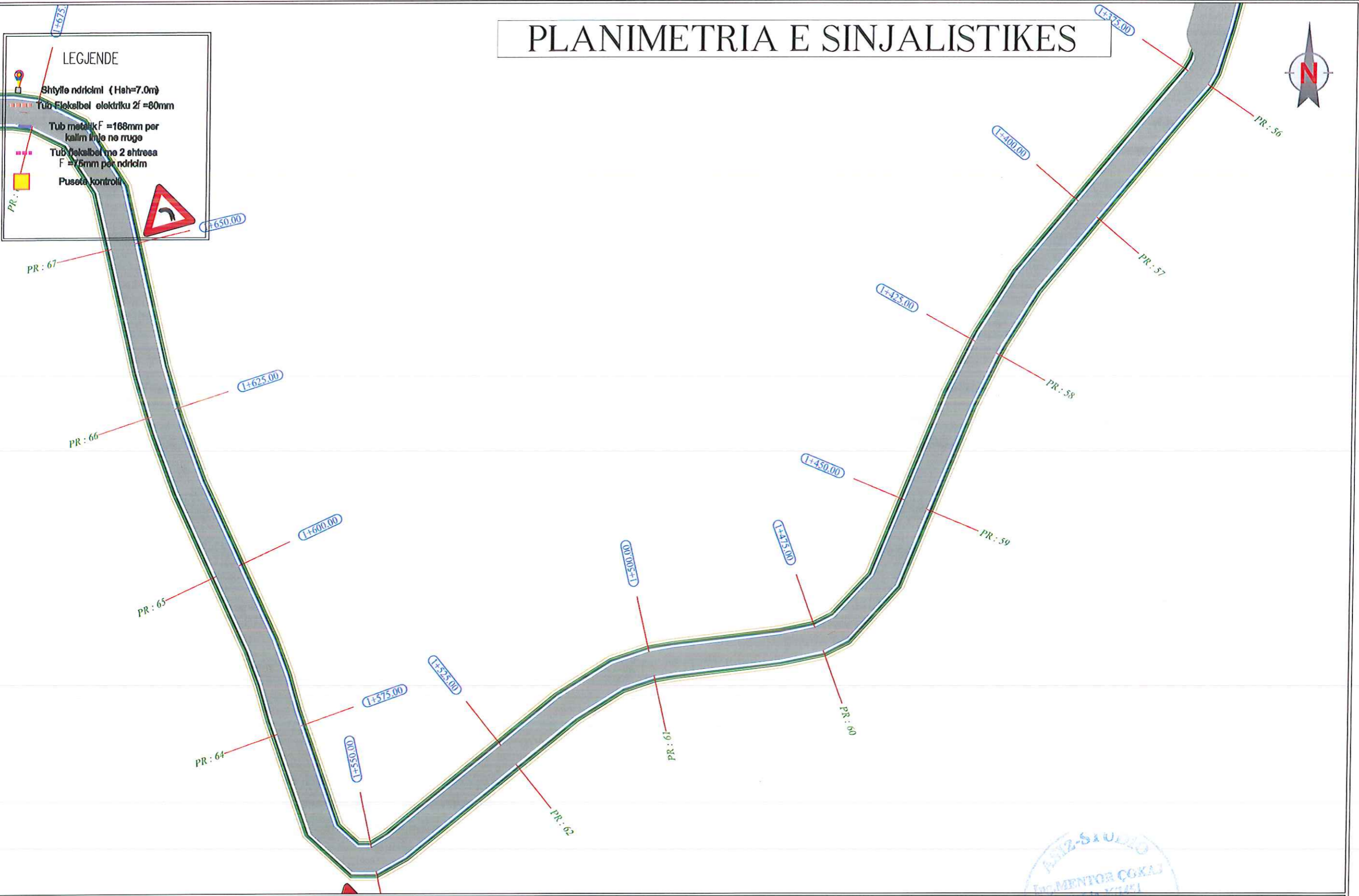





<b>POROSITESI:</b> 	<b>Objekti:</b> Studim Projektim Rrugët Rurale Segmenti "Rruga Bylbyl Breçani"	<b>PROJEKTOI</b> 	<b>"LAND POINT-AL "</b>		<b>Projektues</b> Ing. Mentor ÇOKAJ	SHKALLA 1 : 500	FLETA I-07
			Rruga Xhemal Tafaj; Ndertesa nr 5				

# PLANIMETRIA E SINJALISTIKES

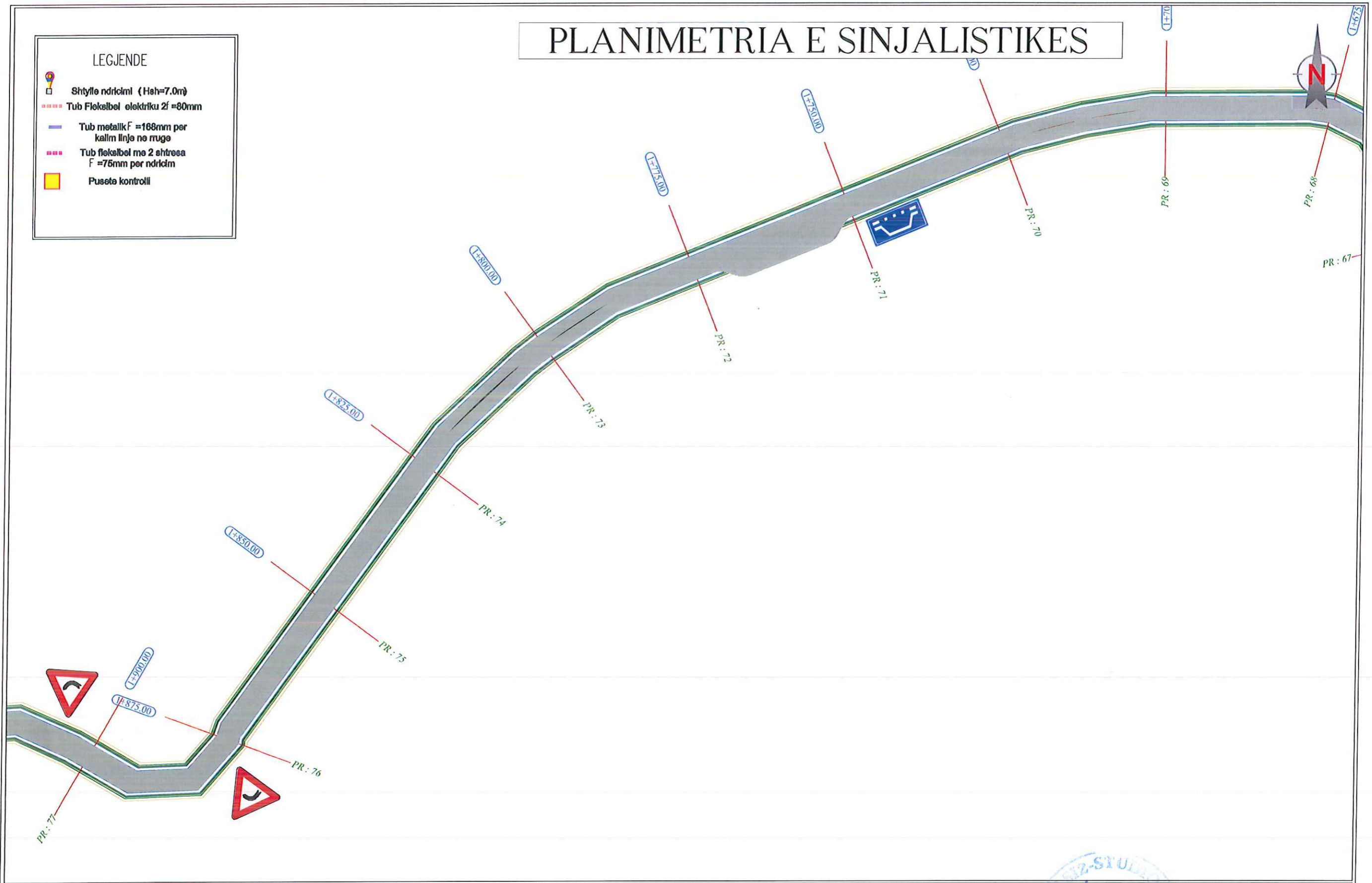
## LEGJENDE

-  Shtyllë ndriçimi (Hoh=7.0m)
-  Tub fiekabel elektriku 2f =80mm
-  Tub metalik F =168mm per kallm linje ne ruge
-  Tub fiekabel me 2 shtresa F =76mm per ndricim
-  Puseta kontrolli



<b>POROSITESI:</b>  Bashkia Tropojë	<b>Objekti:</b> Studim Projektim Rrugët Rurale Segmenti "Rruga Bylbyl Breçani"	<b>PROJEKTOI</b>  "LAND POINT-AL " Rruga Xhemal Tafaj; Nderresa nr 5	<b>Projektues</b> Ing. Mentor COKAJ		<b>SHKALLA</b> 1 : 500	<b>FLETA</b> I-08
					Tiranë 2022	Format A3





# PLANIMETRIA E SINJALISTIKES

## LEGJENDE

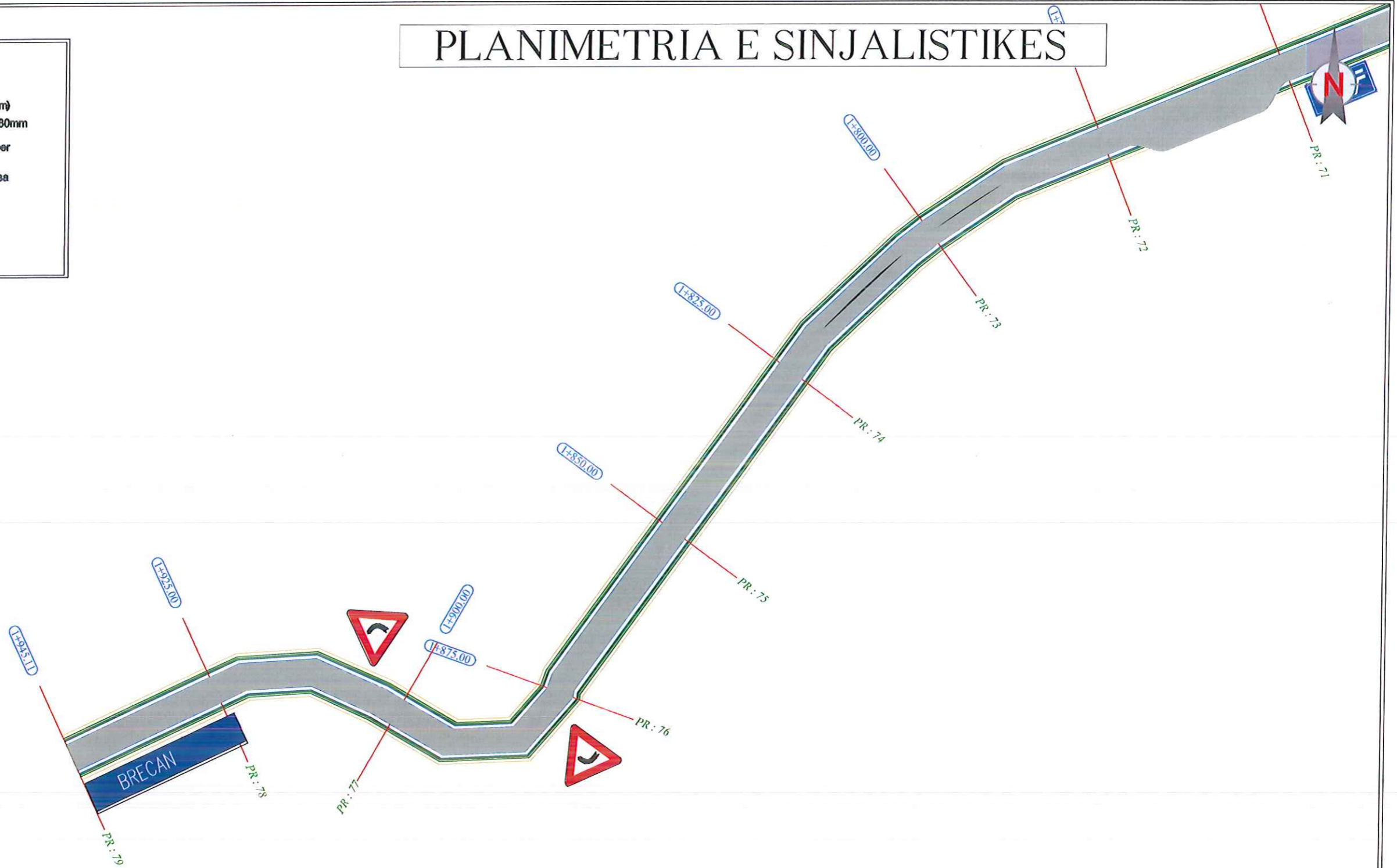
-  Shtyllë ndriçimi (Hsh=7.0m)
-  Tub Fiekelbel elektriku 2f =80mm
-  Tub metalik F =168mm per kalim linje ne ruge
-  Tub fiekelbel me 2 shtresa F =76mm per ndriçim
-  Puseta kontrolli



 POROSITESI: Bashkia Tropojë	Objekti: Studim Projektim Rrugët Rurale Segmenti "Ruga Bylbyl Breçani"	 PROJEKTOI "LAND POINT-AL" Rruga Xhemal Tafaj; Nderresa nr 5	Projektues Ing. Mentor ÇOKAJ	SHKALLA 1 : 500	FLETA I-09
	Tiranë 2022		Format A3		

PROJEKTOI  
LAND POINT-AL

REPUBLIKA E SHQIPERISË  
BASHKIA TROPOJE





MIRATOHET  
KRYETARI I BASHKISE

Z. REXHE BYBERI

# PROJEKT ZBATIMI

OBJEKTI I RRUGËS "BYLBYL BREÇANI", LAGJIA BREÇAN, FSHATI MARKAJ, BASHKIA TROPOJË

PROFILE TIP

 POROSITESI: Bashkia Tropojë	Objekti:	 PROJEKTOI "LAND POINT-AL " Rruga Xhemal Tafaj; Ndertesa nr 5	Projektues	 N. Le. K/1451	SHKALLA	FLETA
	Studim Projektim Rrugët Rurale Segmenti "Rruga Bylbyl Breçani"		Ing. Mentor COKAJ		Tiranë 2022	Format A3





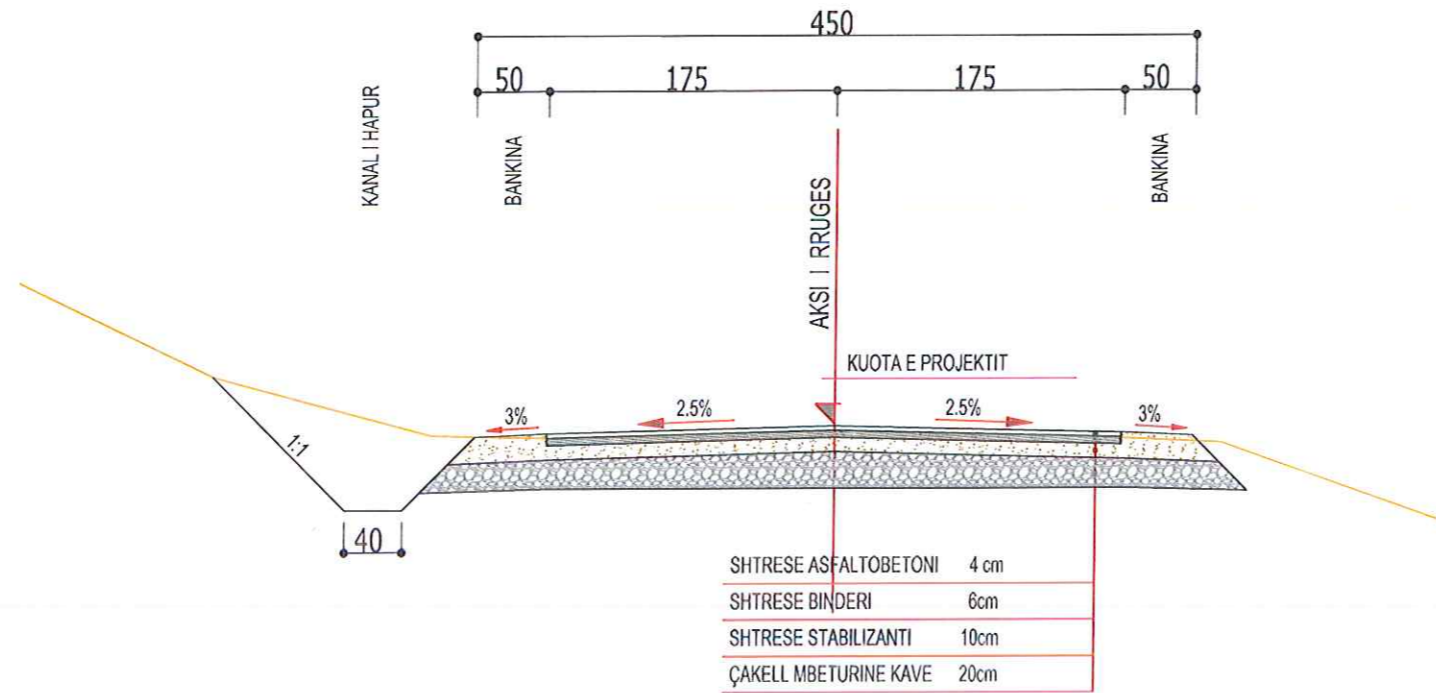

# PROFILE TIP

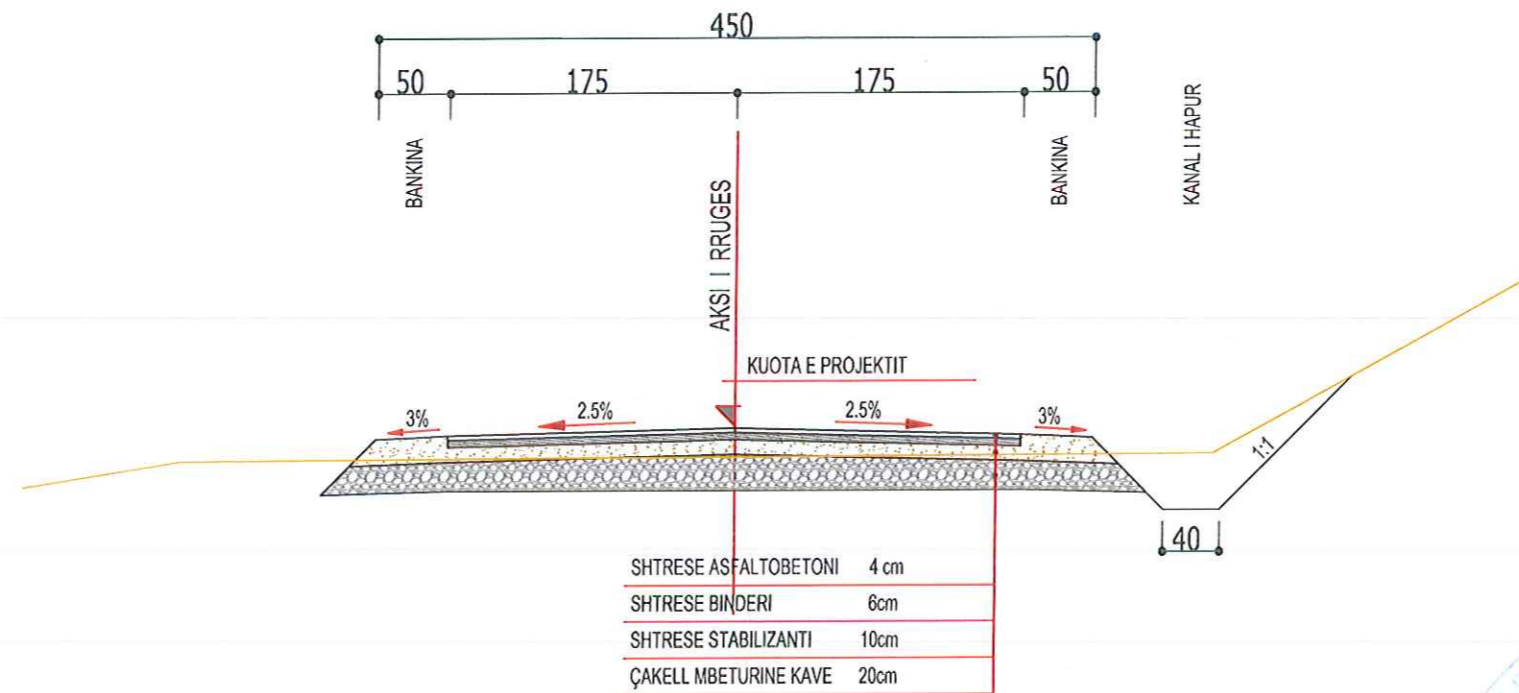

## PROFIL TERTHOR TIP 2



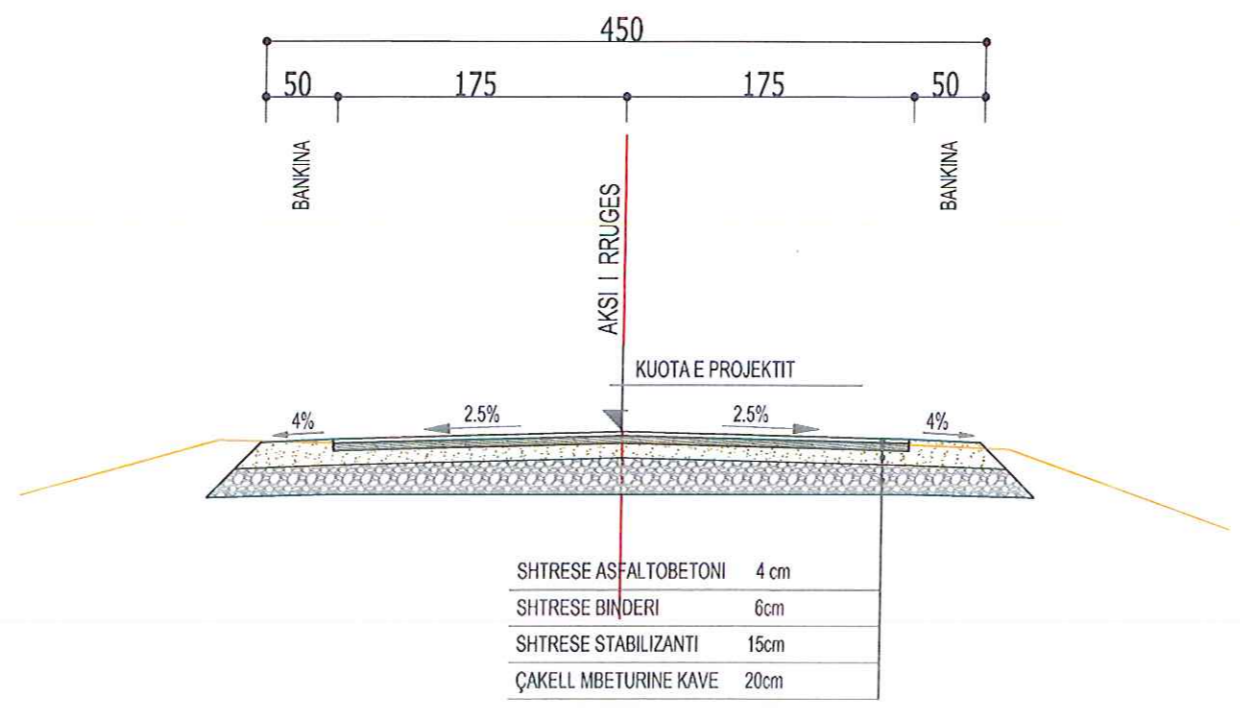
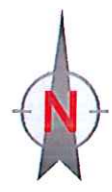

 <b>POROSITESI:</b> Bashkia Tropojë	<b>Objekti:</b> Studim Projektim Rugët Rurale Segmenti "Rruga Bylbyl Breçani"	<b>PROJEKTOI</b>		<b>Projektues</b>		<b>SHKALLA</b> 1 : 1000	<b>FLETA</b> J-01
			<b>"LAND POINT-AL "</b> Rruga Xhemal Tafaj; Ndertesa nr 5	Ing. Mentor COKAJ 			

# PROFILE TIP

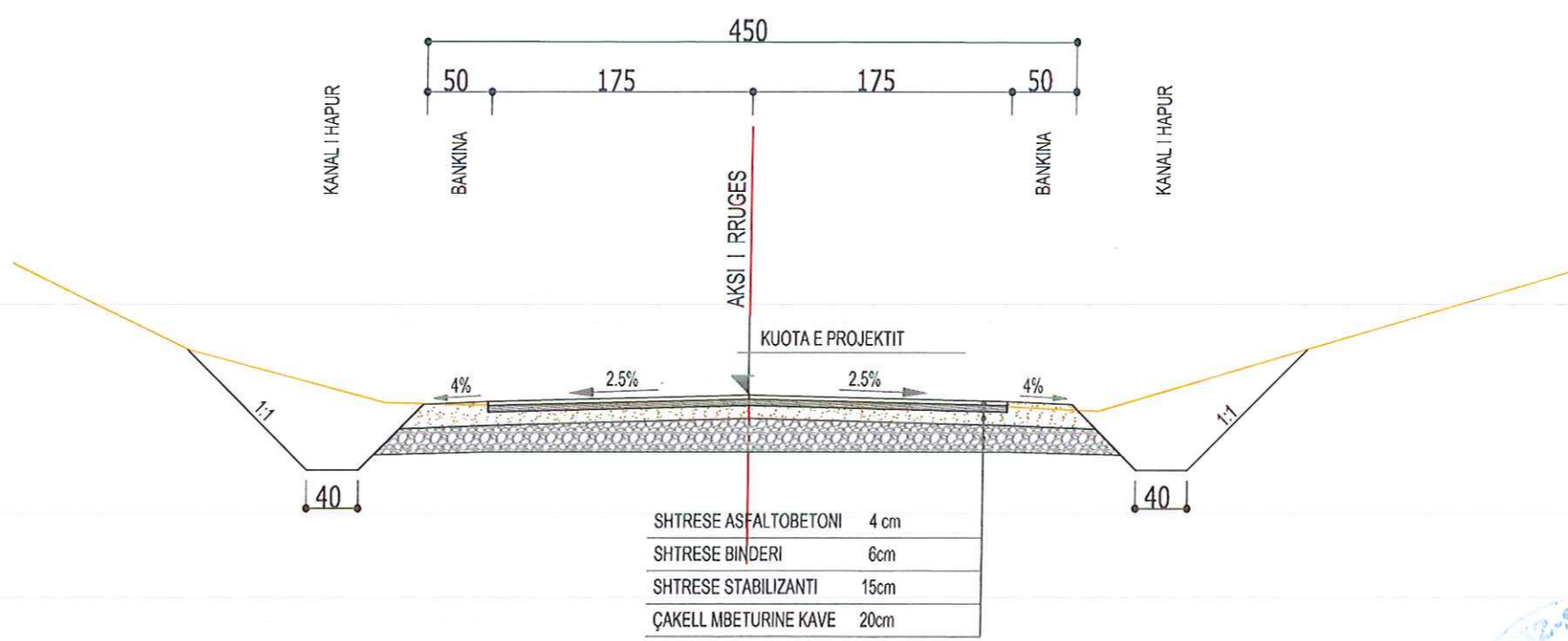

# PROFIL TERTHOR TIP 4



 <b>POROSITESI:</b> Bashkia Tropojë	<b>Objekti:</b> Studim Projektim Rrugët Rurale Segmenti "Rruga Bylbyl Breçani"	<b>PROJEKTOI</b>  "LAND POINT-AL" Rruga Xhemal Tafaj; Ndertesa nr 5	<b>Projektues</b> Ing. Mentor COKAJ		<b>SHKALLA</b> 1 : 1000	<b>FLETA</b> J-02
				Tiranë 2022	Format A3	





# PROFILE TIP

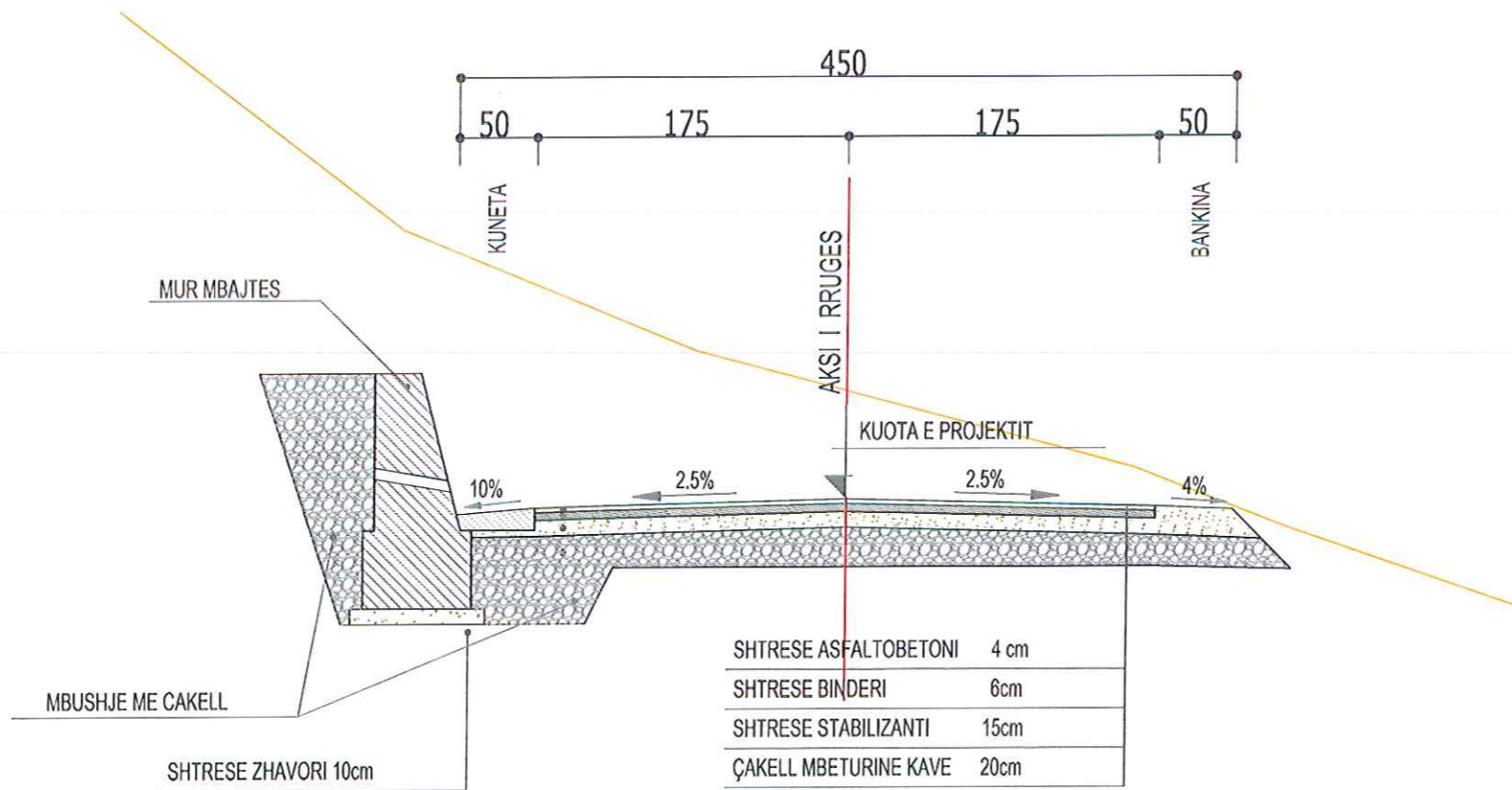

PROFIL TERTHOR TIP 5



<b>POROSITESI:</b>  Bashkia Tropojë	<b>Objekti:</b> Studim Projektim Rugët Rurale Segmenti "Rruga Bylbyl Breçani"	<b>PROJEKTOI</b> 	"LAND POINT-AL " Rruga Xhemal Tafaj; Ndertesa nr 5	<b>Projektues</b> Ing. Mentor ÇOKAJ	<b>SHKALLA</b> 1 : 1000 Tiranë 2022	<b>FLETA</b> J-03 Format A3
			(Signature)	(Signature)		

PROJEKTOI  
LAND POINT-AL

REPUBLIKA E SHQIPERISË  
BASHKIA TROPOJE





MIRATOHET  
KRYETARI I BASHKISE

Z. REXHE BYBERI

# PROJEKT ZBATIMI

OBJEKTI I RRUGËS "BYLBYL BREÇANI", LAGJIA BREÇAN, FSHATI MARKAJ, BASHKIA TROPOJË

## DETAJE TE RRUGES

 <b>POROSITESI:</b> Bashkia Tropojë	<b>Objekti:</b> Studim Projektim Rrugët Rurale Segmenti "Rruga Bylbyl Breçani"	<b>PROJEKTOI</b>		<b>Projektues</b>		<b>SHKALLA</b>	<b>FLETA</b>
			"LAND POINT-AL " Rruga Xhemal Tafaj; Ndertesa nr 5	Ing. Mentor COKAJ			Tiranë 2022



## Hollësi e inkastrimit të kolonës së ndriçuesit me lartësi H=7m

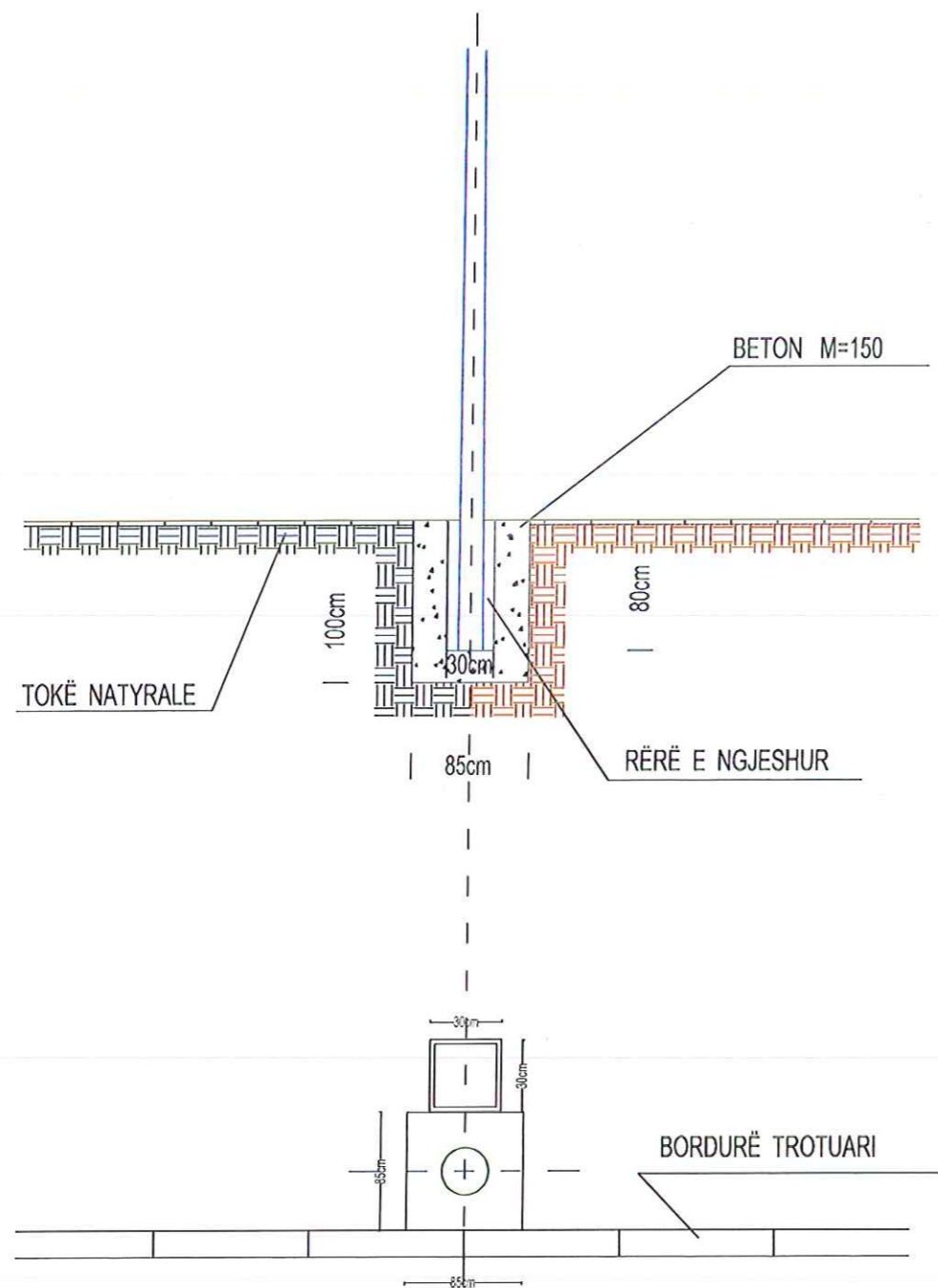

## Hollësi e vendosjes së pusëtës

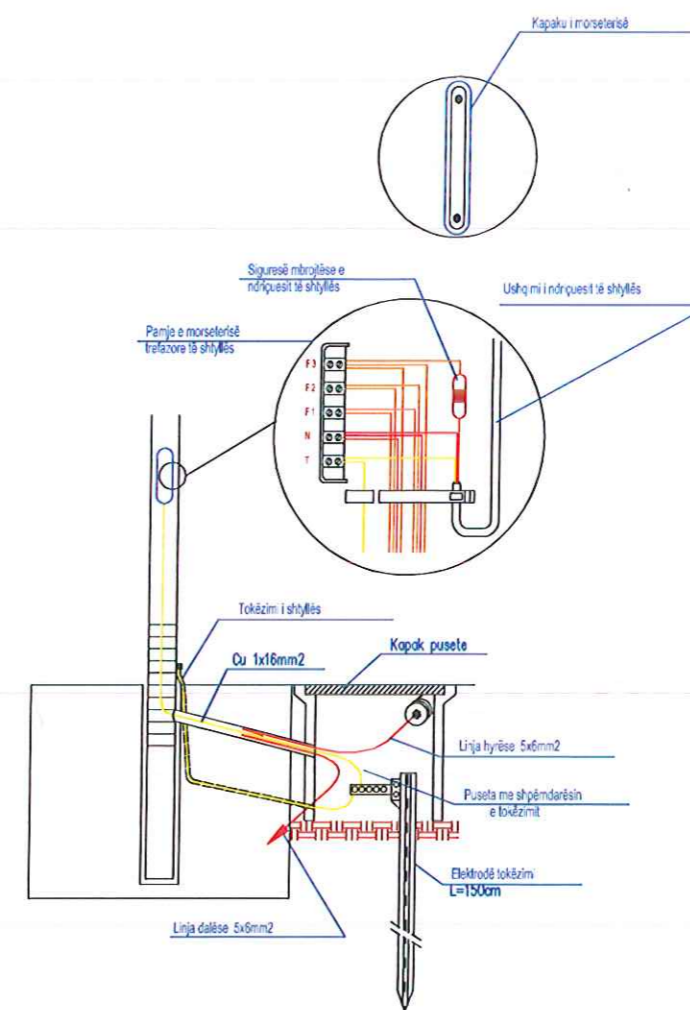
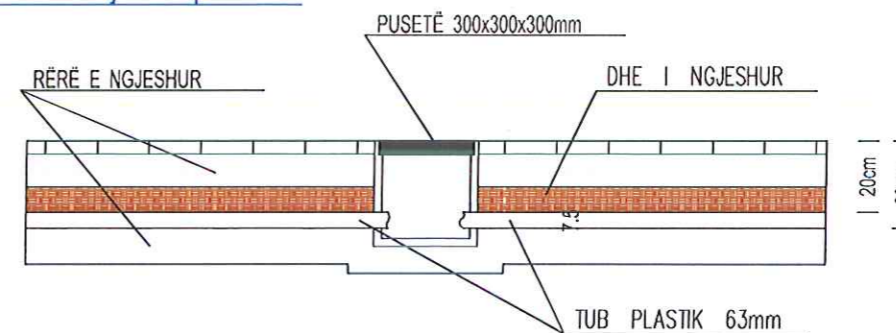

<b>POROSITESI:</b>  Bashkia Tropojë	<b>Objekti:</b> Studim Projektim Rrugët Rurale Segmenti "Rruga Bylbyl Breçani"	<b>PROJEKTOI</b>  "LAND POINT-AL " Rruga Xhemal Tafaj; Ndertesa nr 5	<b>Projektues</b> Ing. Mentor COKAJ		<b>SHKALLA</b> 1 : 1000	<b>FLETA</b> J-04
			(Signature and Stamp of Ing. Mentor COKAJ)		Tiranë 2022	Format A3

DETAJ I Pusetes 1X1m PER LINJAT REZEVE

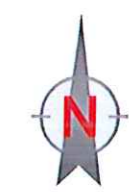

Prerje e kapakut prej gize

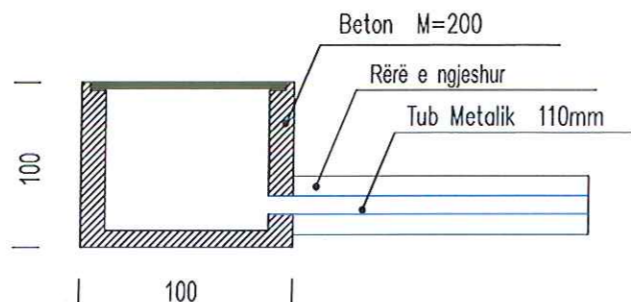

Kapaku i pusetës prej gize

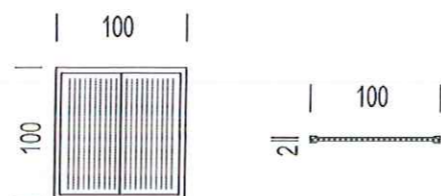
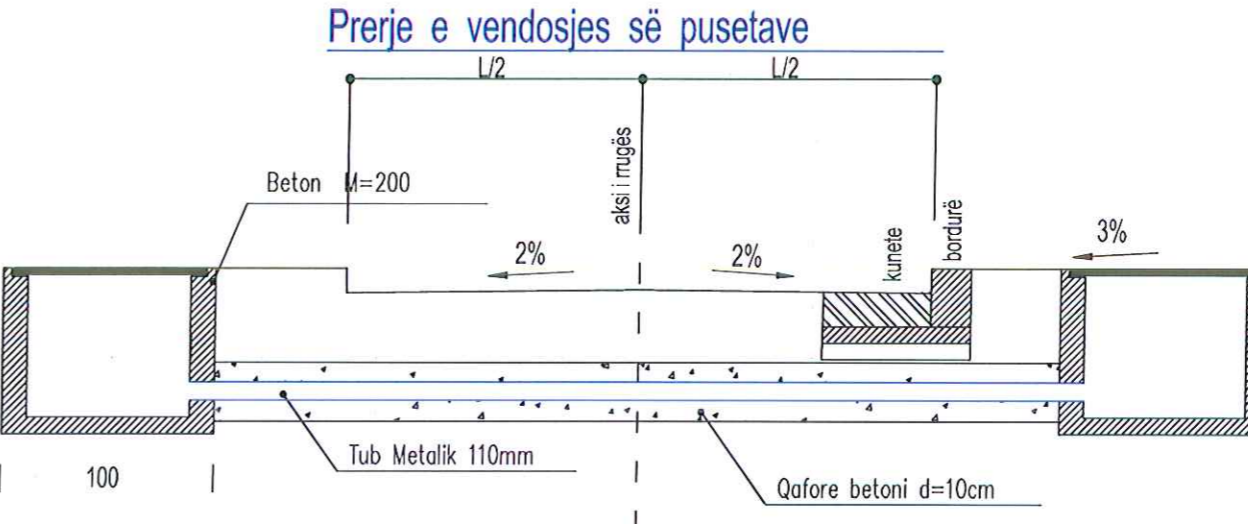

DETAJ I Pusetes 0.5X0.5m PER LINJAT E NDRICIMIT

Kapaku i pusetës prej plastike

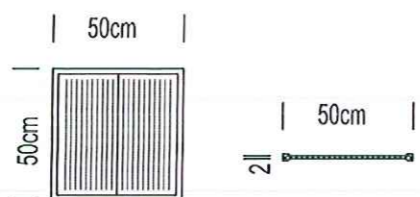
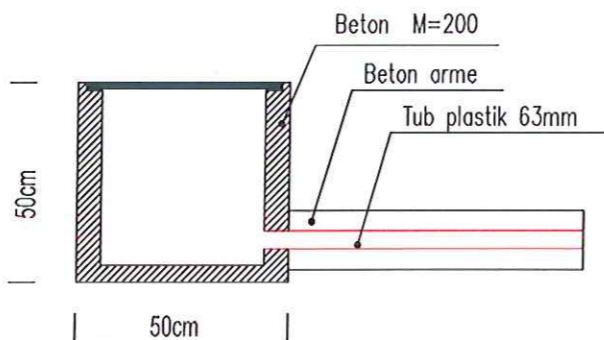

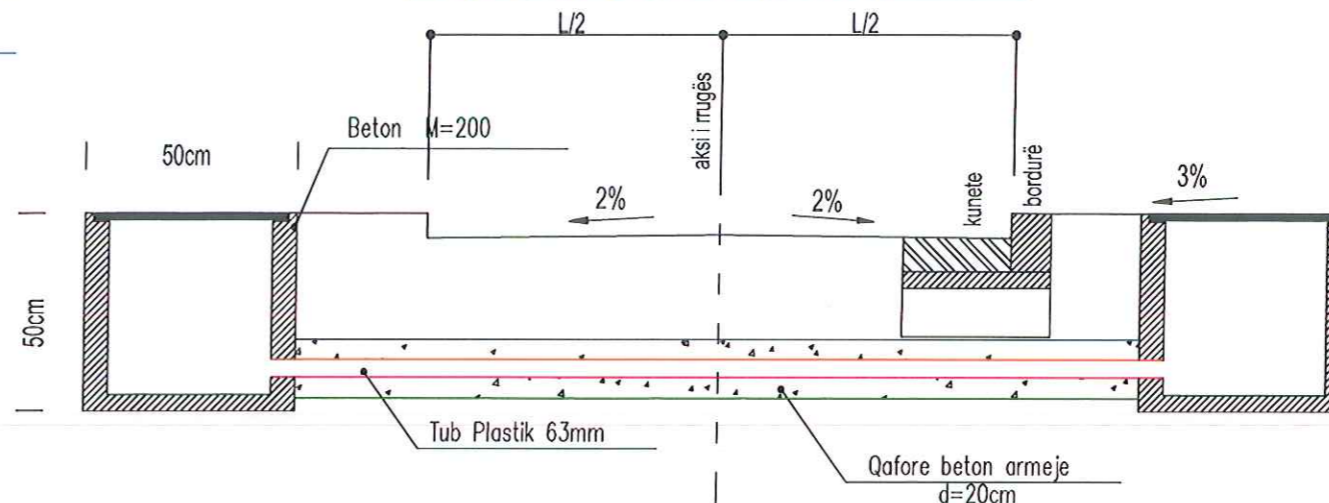

Kapaku i pusetës prej plastike

Prerje e vendosjes së pusetave



SHËNIME :

- Gjatë realizimit të intersektimeve kuota e vendosjes së pusetave mund të ndryshojë sipas rastit
- Tubi mund të vendoset me një pjerrësi të lehtë sipas nevojës , por gjithnjë thellësia minimale e vendosjes duhet te jete 50cm nga sip. e asfaltit.

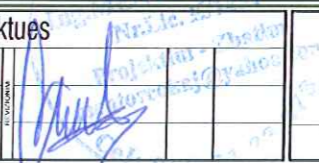
 POROSITESI: Bashkia Tropojë	Objekti: Studim Projektim Rrugët Rurale Segmenti "Rruga Bylbyl Breçani"	 PROJEKTOI "LAND POINT-AL" Rruga Xhemal Tafaj; Ndertes nr 5	Projektues Ing. Mentor COKAJ		SHKALLA 1 : 1000	FLETA J-05
					Tiranë 2022	Format A3





Detaj i tokëzimit të shtyllës së ndriçimit

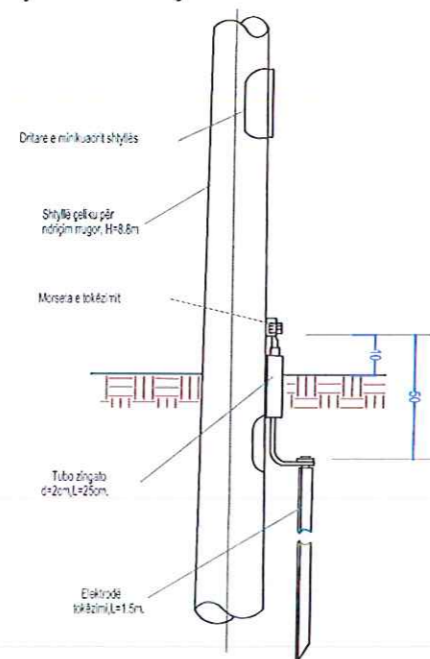

Konstruksioni morseterisë

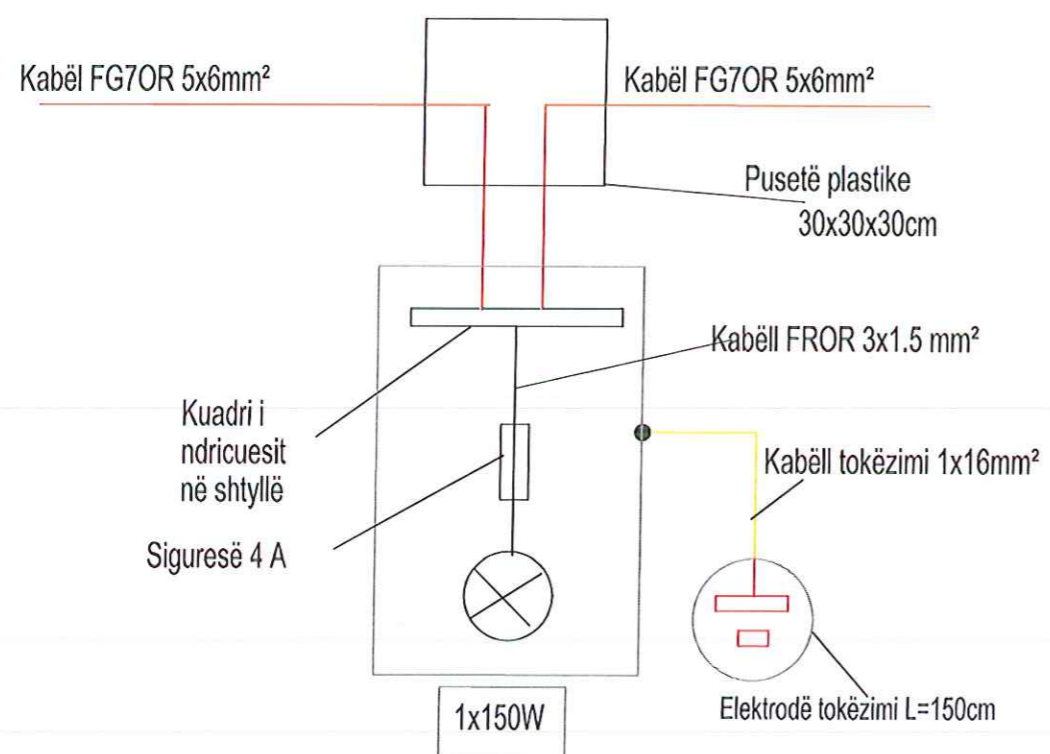
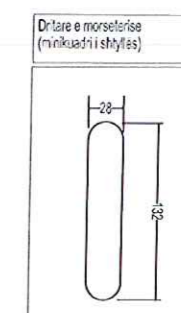
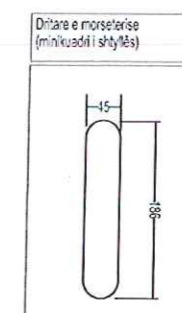
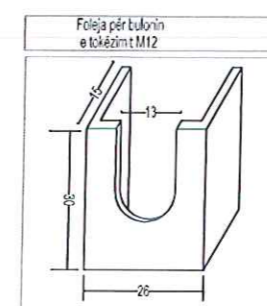
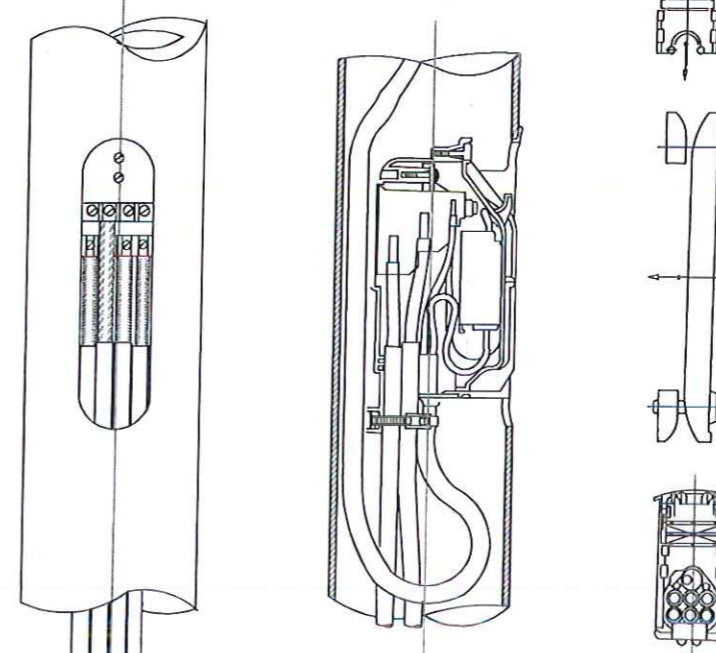

 <p>POROSITESI: Bashkia Tropojë</p>	<p>Objekti: Studim Projektim Rrugët Rurale Segmenti "Rruga Bylbyl Breçani"</p>	 <p>PROJEKTOI "LAND POINT-AL" Rruga Xhemal Tafaj; Nderesa nr 5</p>	<p>Projektues Ing. Mentor COKAJ</p>		<p>SHKALLA 1 : 1000</p>	<p>FLETA J-06</p>
			<p>Tiranë 2022</p>		<p>Format A3</p>	



Planimetria e instalimit të rrjetit kabllor të ndricimit,

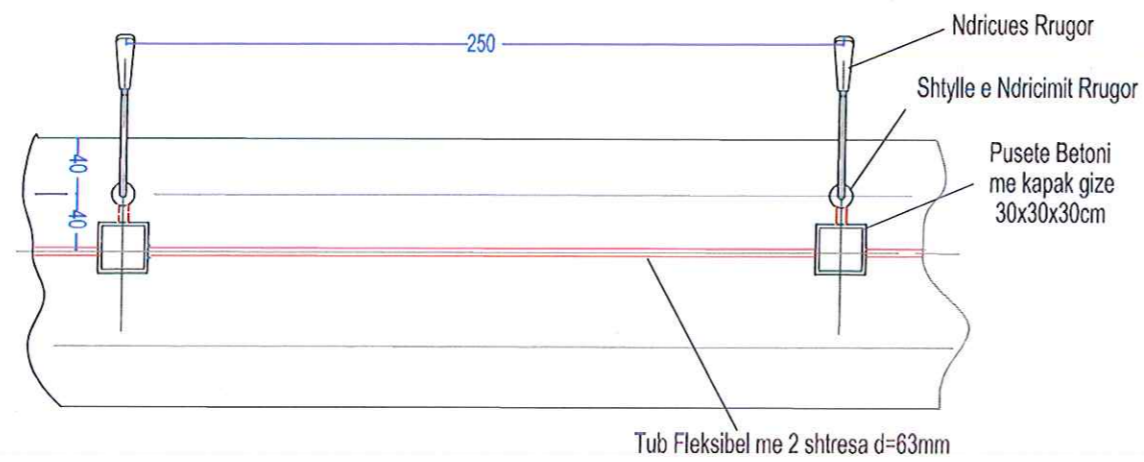

kabllove te TU  
ne TP.direkt ne toke

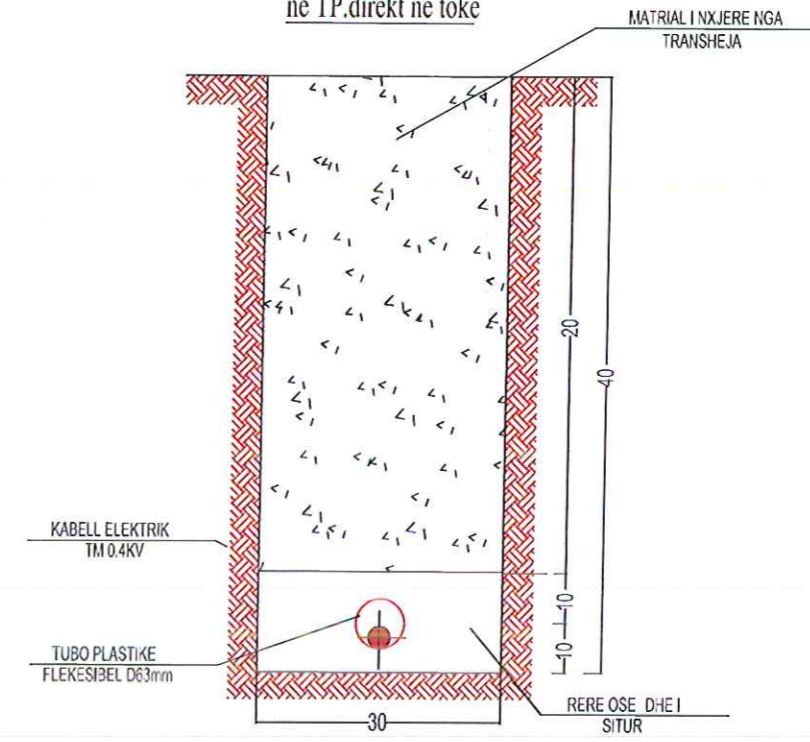

montimit te pusetes dhe tokezimit te shtylles

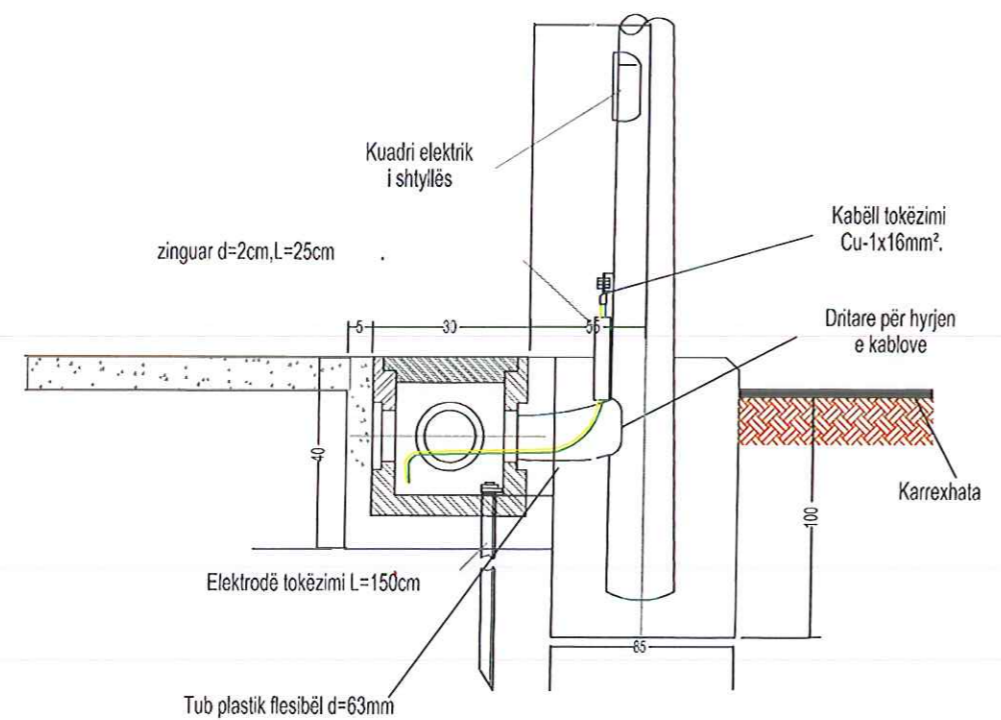

kabllove te TU  
ne trasversimin e rrugeve

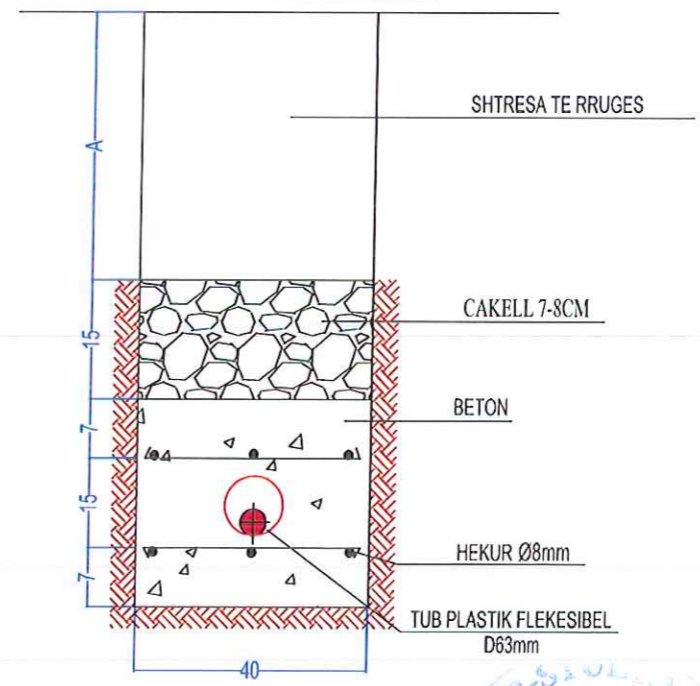

 <p>POROSITESI: Bashkia Tropojë</p>	<p>Objekti: Studim Projektim Rrugët Rurale Segmenti "Rruga Bylbyl Breçani"</p>	 <p>PROJEKTOI "LAND POINT-AL "</p>	<p>Projektues</p>		<p>SHKALLA 1 : 1000</p>	<p>FLETA J-07</p>
			<p>Rruga Xhemal Tafaj; Ndertesha nr 5</p>	<p>Ing. Mentor COKAJ</p>		



## SHENJA LAJMERUESE

LAJMERIM PER NDERPRERJE NGA RRUGE DYTESORE, KTHESAT E KURBEZUARA, FEMIJET, KEMBESORET DHE PER NDALJE/DHENIE RRUGE

trekëndeshi: e kuqe reflektuese  
sfondi: i zi  
Symboli: e bardhe reflektuese



## SHENJA NDALUESE

shenjat per kufirin e shpejtesise dhe ndalim parakalimin

rrethi: e kuqe reflektuese  
shenja: e zeze reflektuese



## SHENJA INFORMUESE

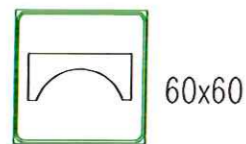

URE

Shenim: Shenjat rrugore per nga forma, madhesia, ngjyra reflektiviteti duhet te jene sipas Kodit Rrugor te Republikes se Shqiperise Materiali praparefektiv duhet te kete jetegjatesi 10vjet per Clasin 2 dhe 7 vjet per Clasin 1 Simboli brenda shenjes rrugore realizuar me boje te trajtuar me pjekje e cila nuk humbet treguesit praparefektiv Shenja rrugore realizohet me llamarinine cel ku e cila lyhet me boje opake kur drandra korozionit dhe trajtohet me pjekje.

## PERMASAT E SHENJAVE STANDARTE

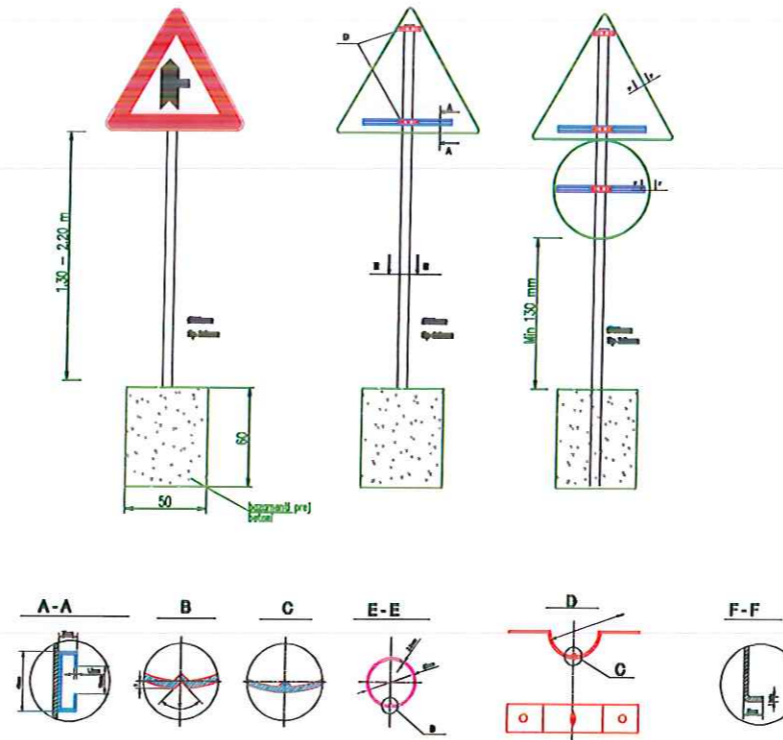
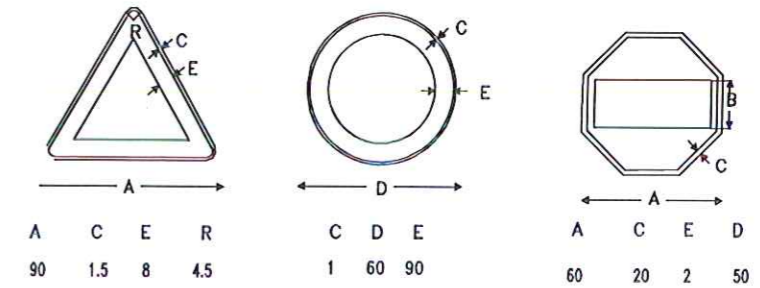

## TIPET E VIZIMEVE TE RRUGES

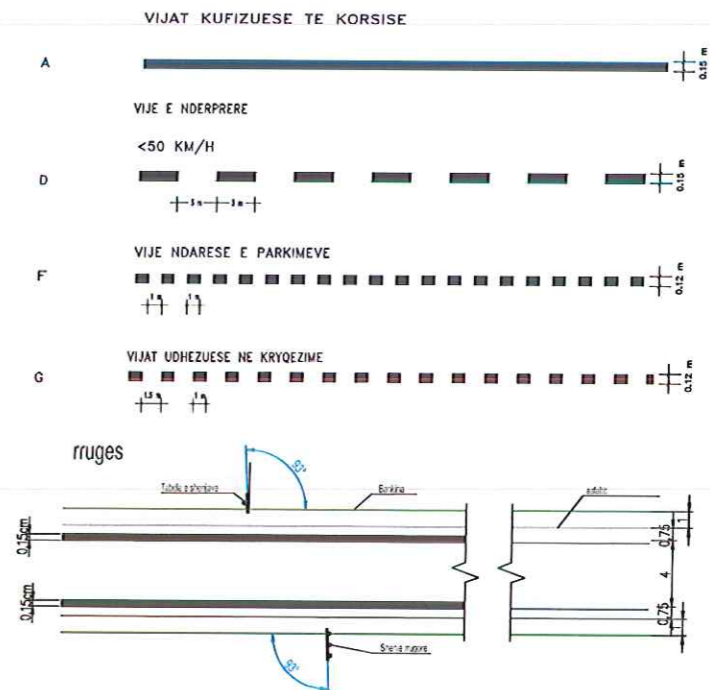

<b>POROSITESI:</b> 	<b>Objekti:</b> Studim Projektim Rrugët Rurale Segmenti "Rruga Bylbyl Breçani"	<b>PROJEKTOI</b> 		<b>Projektues</b> Ing. Mentor COKAJ		<b>SHKALLA</b> 1 : 1000	<b>FLETA</b> J-08
		"LAND POINT-AL" Rruga Xhemal Tafaj; Nderesa nr 5				Tiranë 2022	Format A3

## VENDOSJA DHE MONTIMI I SHENJES RRUGORE

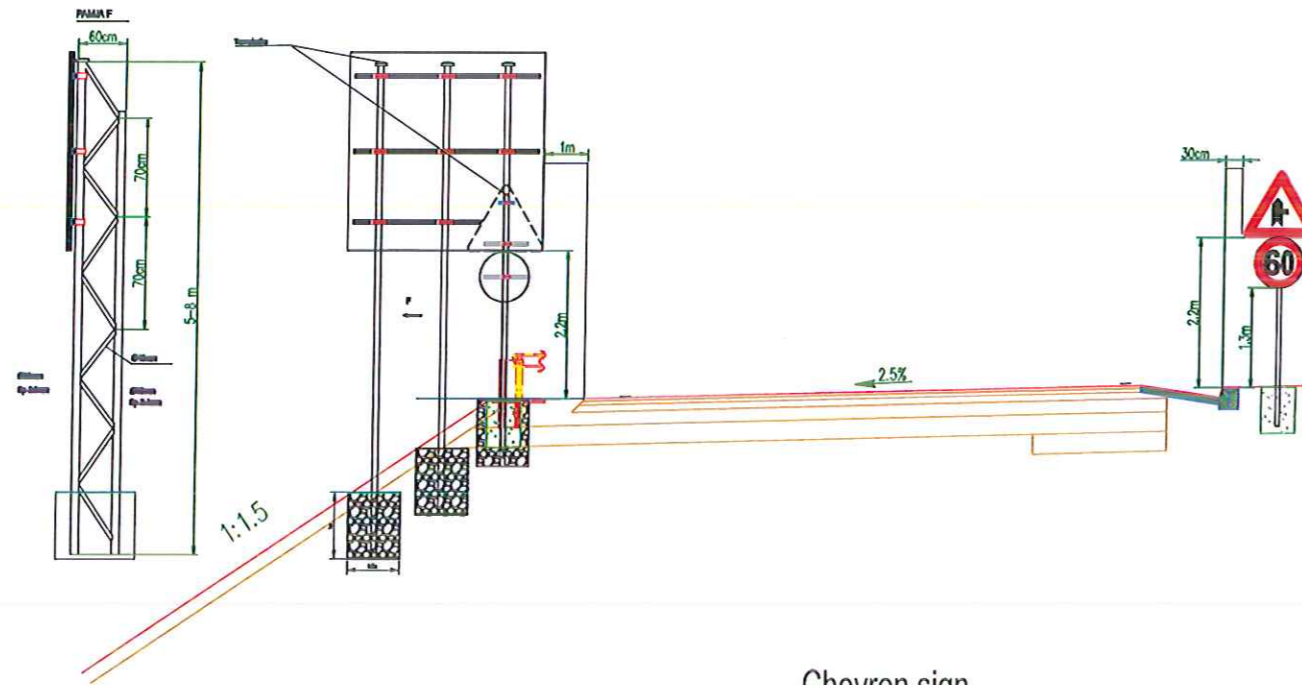
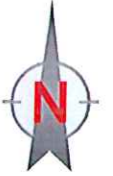

**Shenim:** Shenjat rrugore per nga forma, madhesia, ngjyra reflektiviteti duhet te jene sipas Kodit Rrugor te Republikes se Shqiperise Materiali praparefektiv duhet te kete jetegjatesi 10vjet per Clasin 2 dhe 7 vjet per Clasin 1 Simboli brenda realizuar me boje te trajtuar me pjekje e cila nuk humbet treguesit praparefektiv Shenja rrugore realizohet me llamarine çeliku e cila lyhet me boje opake kundrandra korozionit dhe trajtohet me pjekje. Tubat, bullonat, fashetat dhe konstrukcionet mbajtese te shenjes duhet te xingohen ne te nxehte.

Chevron sign  
Kthese e menjehershme

shenje e ishullit te trafikut

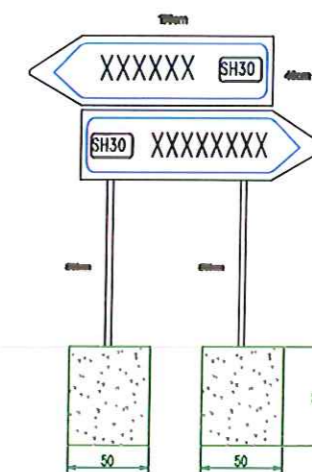
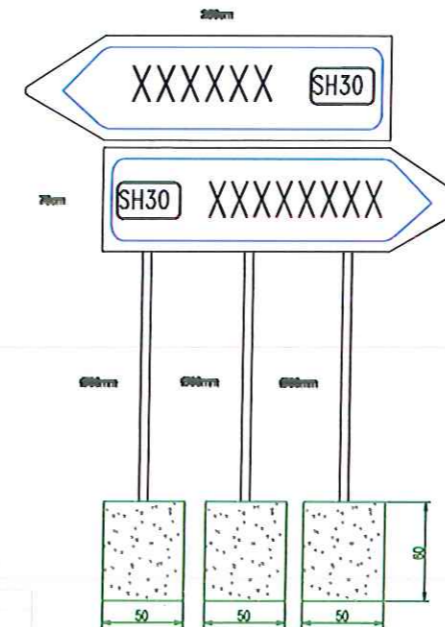
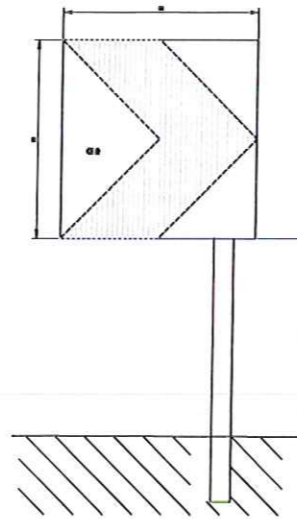
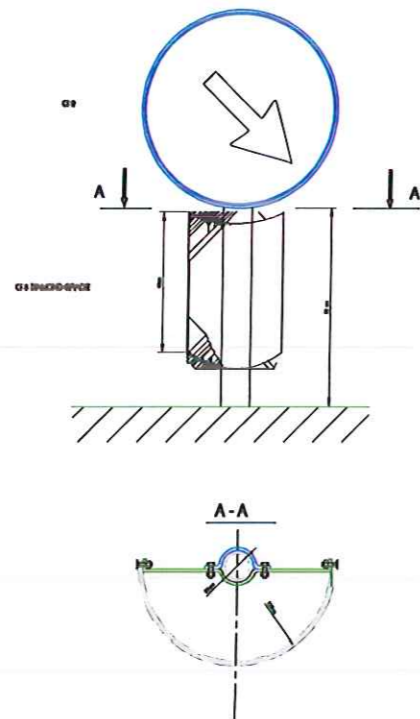

Distanca e chevrons signs

PREZJA E KATHESIS	DISTANCA
100-200 m	25 m
200-400 m	35 m
> 400 m	50 m

POROSITESI:  
Bashkia Tropojë

Objekti:  
Studim Projektim Rrugët Rurale  
Segmenti "Rruga Bylbyl Breçani"

PROJEKTOI  
LAND  
POINT-AL

"LAND POINT-AL"  
Rruga Xhemal Tafaj;  
Ndertesë nr 5

Projektues

Ing. Mentor ÇOKAJ

SHKALLA

1 : 1000

Tiranë 2022

FLETA

J-09

Format A3