



BASHKIA KRUJË

## PROJEKT PREVENTIV ZBATIMI

EMËRTIMI : SISTEMIM - ASFALTIM I RRUGËS SË " ZALLJANEVE ", FSHATI ZALLË

NJESIA ADMINISTRATIVE FUSHE KRUJE, BASHKIA KRUJE

PROJEKTUESI

" ERALD - G " shpk

INVESTITORI

KRYETARI I BASHKISË

**ARTUR BUSHI**



REPUBLIKA E SHQIPËRISË  
BASHKIA KRUIJË

EMERTIMI

PROJEKT PREVENTIV ZBATIMI  
SISTEMIM-ASFALTIM I RRUGËS SË  
" ZALLJANEVE "

NJESIA ADMINISTRATIVE  
FUSHE KRUIJE

BASHKIA KRUIJE

EMERTIMI I FLETËS

PLANIMETRIA E PËRGJITHSHME

PROJEKTUESI

\* ERALD - G \* shpk

FLETA U-01

SH 1 : 5000

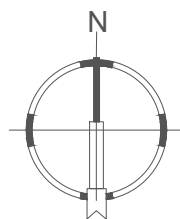



REPUBLIKA E SHQIPËRISË  
BASHKIA KRUIJË

EMERTIMI

PROJEKT PREVENTIV ZBATIMI  
SISTEMIM-ASFALTIM I RRUGËS  
SË " ZALLJANEVE "

NJESIA ADMINISTRATIVE FUSHË KRUIJË

BASHKIA KRUIJË

EMERTIMI I FLETËS

PLANIMETRIA CS-1 - CS-8

PROJEKTUESI

" ERALD - G " shpk

FLETA U-02

SH 1 : 850



REPUBLIKA E SHQIPËRISË  
BASHKIA KRUIJË

EMERTIMI

PROJEKT PREVENTIV ZBATIMI  
SISTEMIM-ASFALTIM I RRUGËS  
SË " ZALLJANEVE "

NJESIA ADMINISTRATIVE FUSHË KRUIJË  
BASHKIA KRUIJE

EMERTIMI I FLETËS

PLANIMETRIA CS-8 - CS-16

PROJEKTUESI

" ERALD - G " shpk

FLETA U-03

SH 1 : 850



REPUBLIKA E SHQIPËRISË  
BASHKIA KRUJË

EMERTIMI

PROJEKT PREVENTIV ZBATIMI  
SISTEMIM-ASFALTIM I RRUGËS  
SË " ZALLJANEVE "

NJESIA ADMINISTRATIVE FUSHË KRUJË

BASHKIA KRUJË

EMERTIMI | FLETËS

PLANIMETRIA CS-15 - CS-24

PROJEKTUESI

" ERALD - G " shpk

FLETA U-04

SH 1 : 850





REPUBLIKA E SHQIPËRISË  
BASHKIA KRUJË

EMERTIMI

PROJEKT PREVENTIV ZBATIMI  
SISTEMIM-ASFALTIM I RRUGËS  
SË " ZALLJANEVE "

NJESIA ADMINISTRATIVE FUSHË KRUJË

BASHKIA KRUJE

EMERTIMI I FLETËS

PLANIMETRIA CS-1 - CS-8

PROJEKTUESI

" ERALD - G " shpk

FLETA U-05

SH 1 : 850

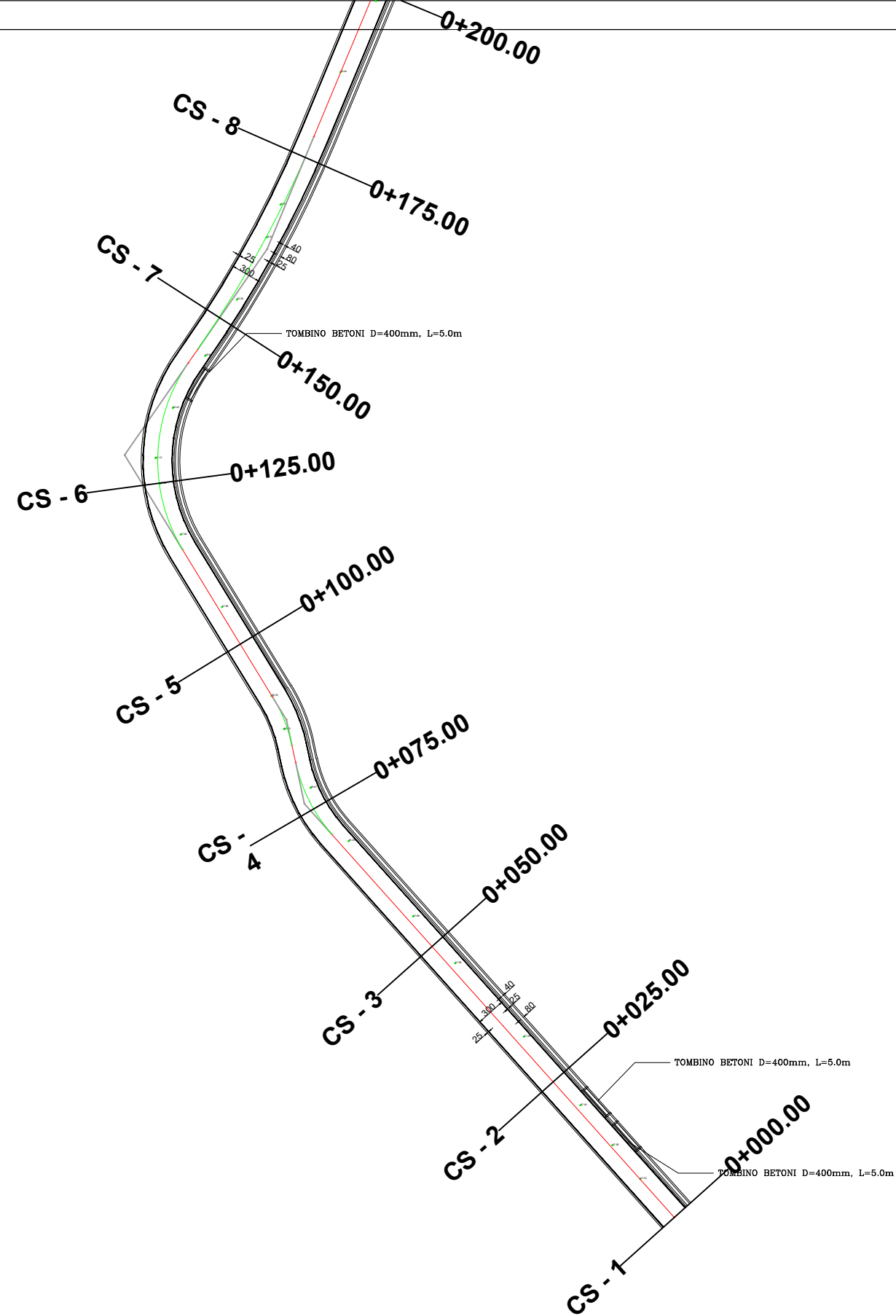

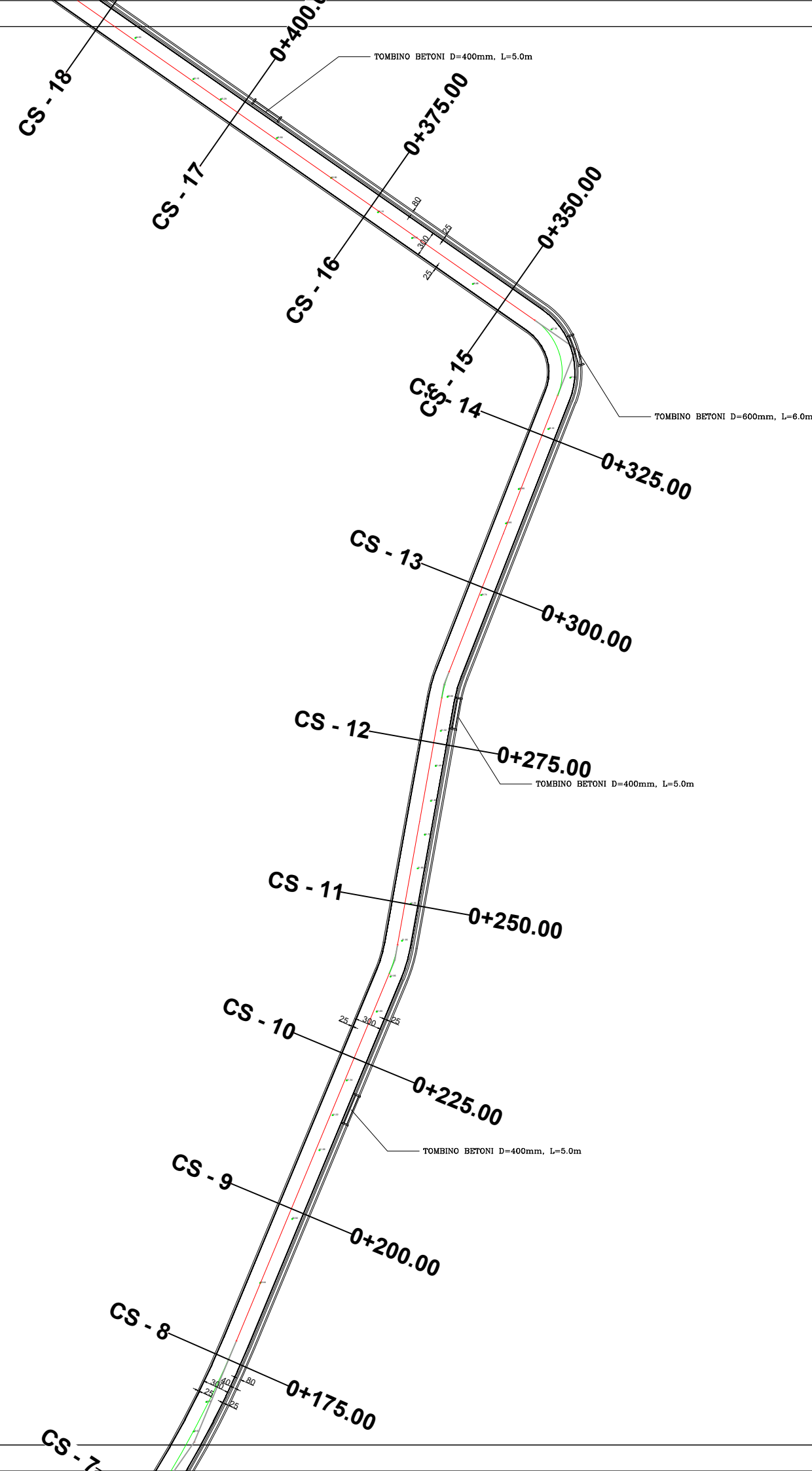

REPUBLIKA E SHQIPËRISË  
BASHKIA KRUIJË

EMERTIMI

PROJEKT PREVENTIV ZBATIMI  
SISTEMIM-ASFALTIM I RRUGËS  
SË " ZALLJANEVE "

NJESIA ADMINISTRATIVE FUSHË KRUIJË  
BASHKIA KRUIJË

EMERTIMI | FLETËS

PLANIMETRIA CS-8 - CS-16

PROJEKTUESI

" ERALD - G " shpk

FLETA U-06

SH 1 : 850



REPUBLIKA E SHQIPËRISË  
BASHKIA KRUJË

EMERTIMI

PROJEKT PREVENTIV ZBATIMI  
SISTEMIM-ASFALTIM I RRUGËS  
SË " ZALLJANEVE "

NJESIA ADMINISTRATIVE FUSHË KRUJË

BASHKIA KRUJE

EMERTIMI I FLETËS

PLANIMETRIA CS-15 - CS-24

PROJEKTUESI

" ERALD - G " shpk

FLETA U-04

SH 1 : 850

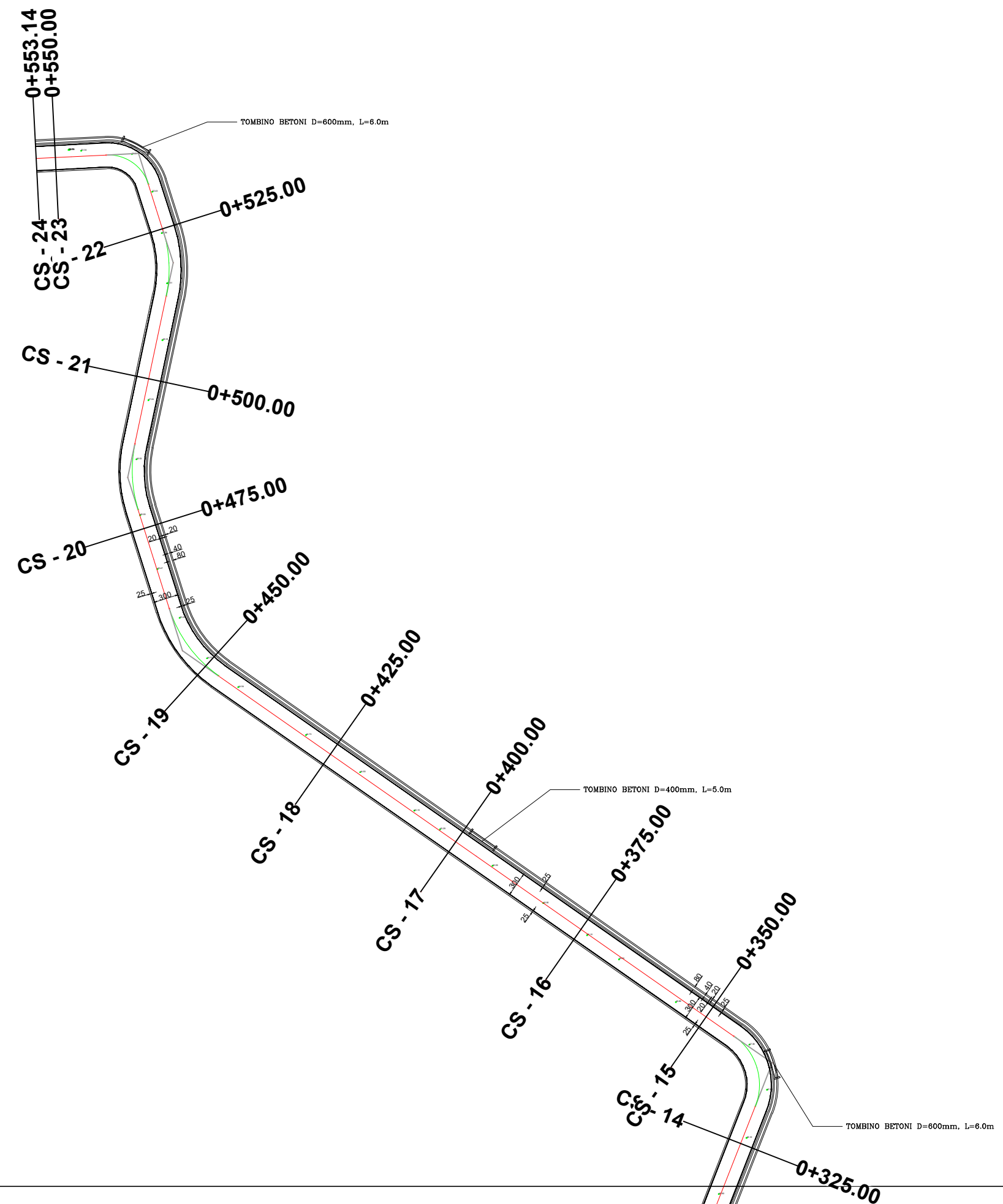



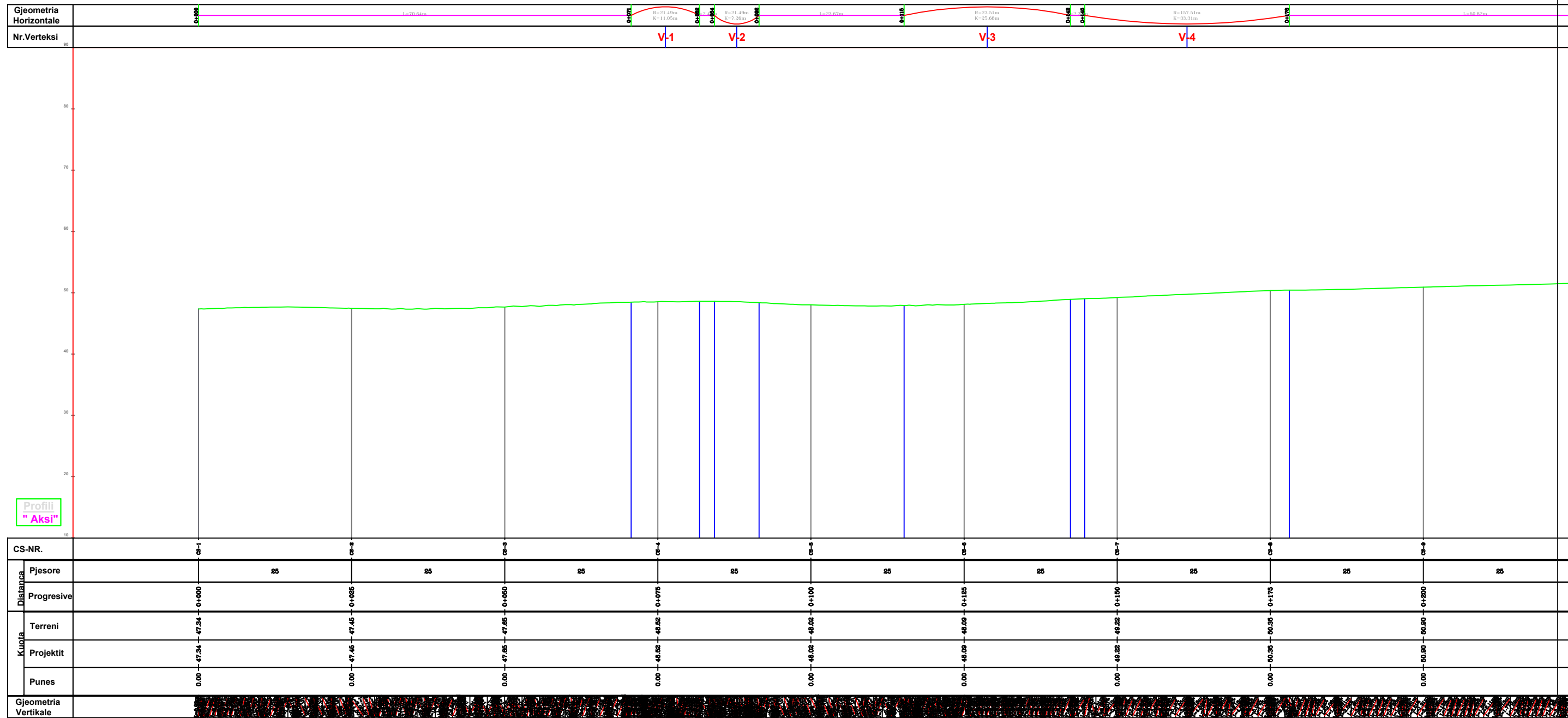

Profili "Aksi"



REPUBLICA E SHQIPËRISË	EMERTIMI	EMERTIMI   FLETËS	PROJEKTUESI
	BASHKIA KRUIJË	PROJEKT PREVENTIV ZBATIMI SISTEMIM-ASFALTIM I RRUGËS SË " ZALLEVE "	" ERALD - G " shpk
	NJESIA ADMINISTRATIVE FUSHË KRUIJË, BASHKIA KRUIJE	PROFILI GJATESOR	
			FLETA U16

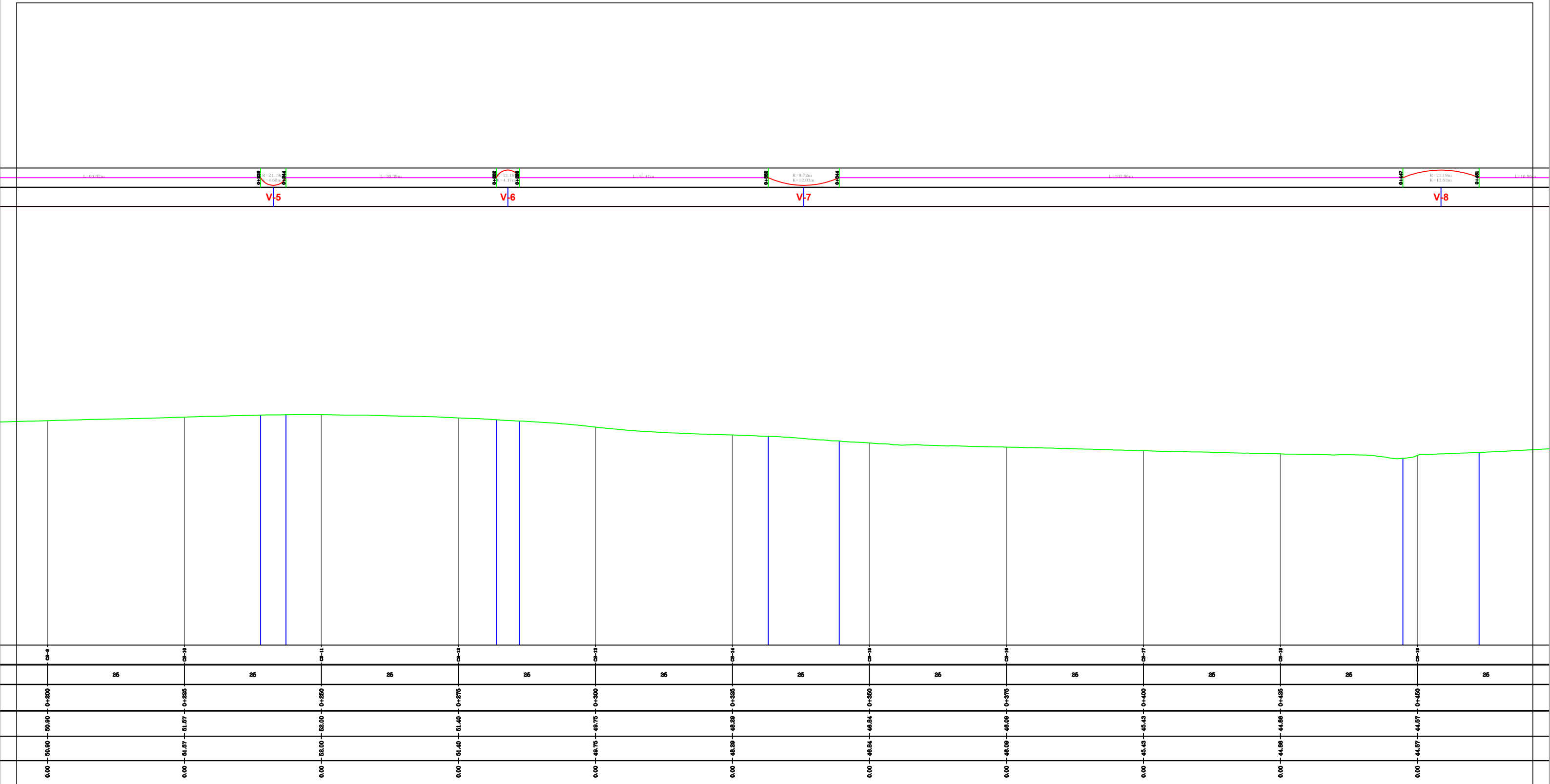

REPUBLIKA E SHQIPËRISË  
BASHKIA KRUIJË

EMERTIMI  
PROJEKT PREVENTIV ZBATIMI  
SISTEMIM-ASFALTIM I RRUGËS SË " ZALLEVE "  
NJESIA ADMINISTRATIVE FUSHË KRUIJË, BASHKIA KRUIJE

EMERTIMI I FLETËS  
PROFILI GJATESOR

PROJEKTUESI  
" ERALD - G " shpk

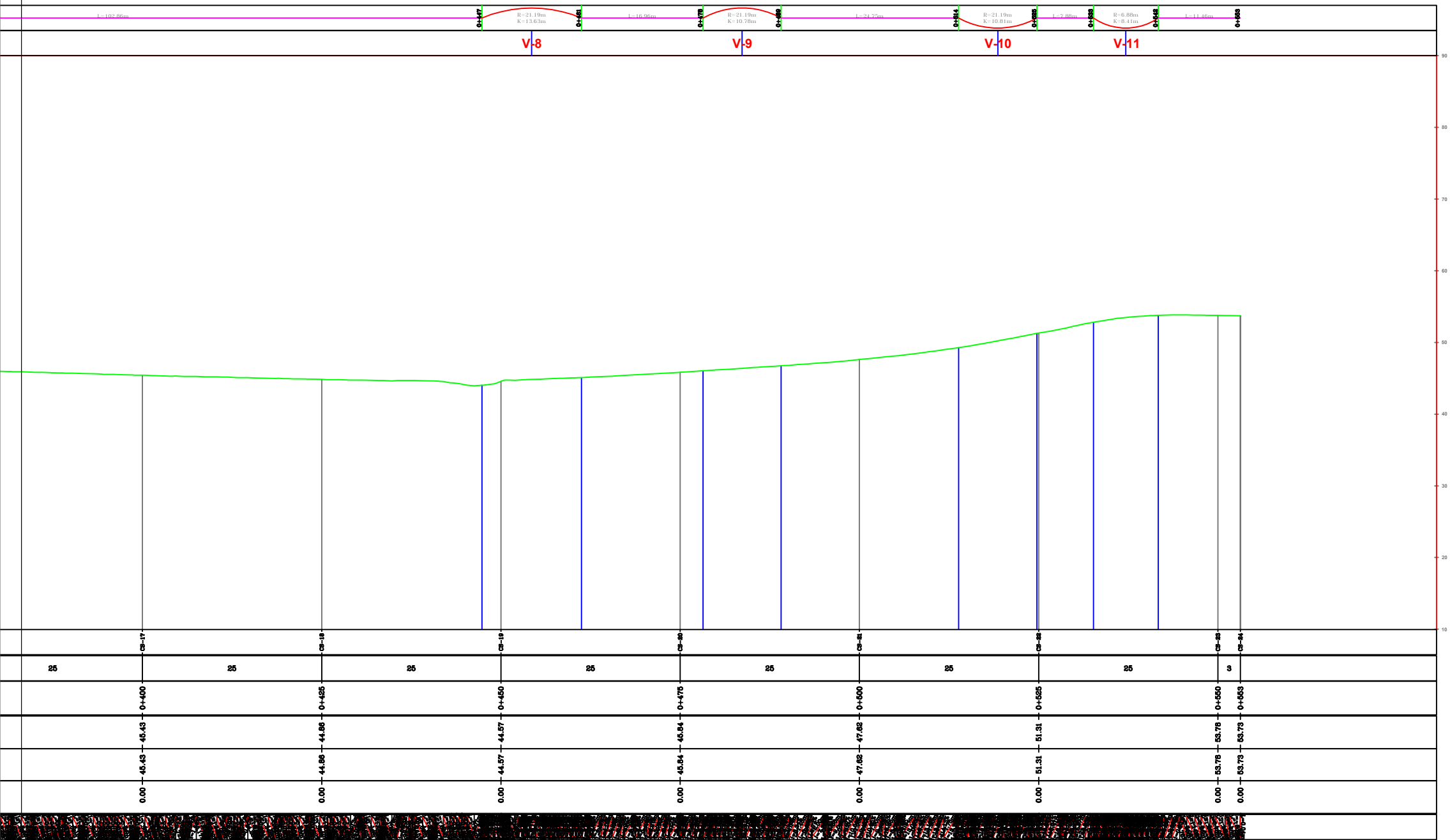

REPUBLIKA E SHQIPËRISË  
BASHKIA KRUIJË

EMERTIMI  
PROJEKT PREVENTIV ZBATIMI  
SISTEMIM-ASFALTIM I RRUGËS SË " ZALLEVE "  
NJESIA ADMINISTRATIVE FUSHË KRUIJË, BASHKIA KRUIJE

EMERTIMI I FLETËS  
PROFILI GJATESOR

PROJEKTUESI  
" ERALD - G " shpk



REPUBLIKA E SHQIPËRISË

BASHKIA KRUJË

EMERTIMI  
 PROJEKT PREVENTIV ZBATIMI  
 SISTEMIM-ASFALTIM I RRUGËS SË " ZALLJANEVE "

NJESIA ADMINISTRATIVE FUSHË KRUJË  
 BASHKIA KRUJË

EMERTIMI I FLETËS

PROFILIET TERTHORE

PROJEKTUESI

" ERALD - G " shpk

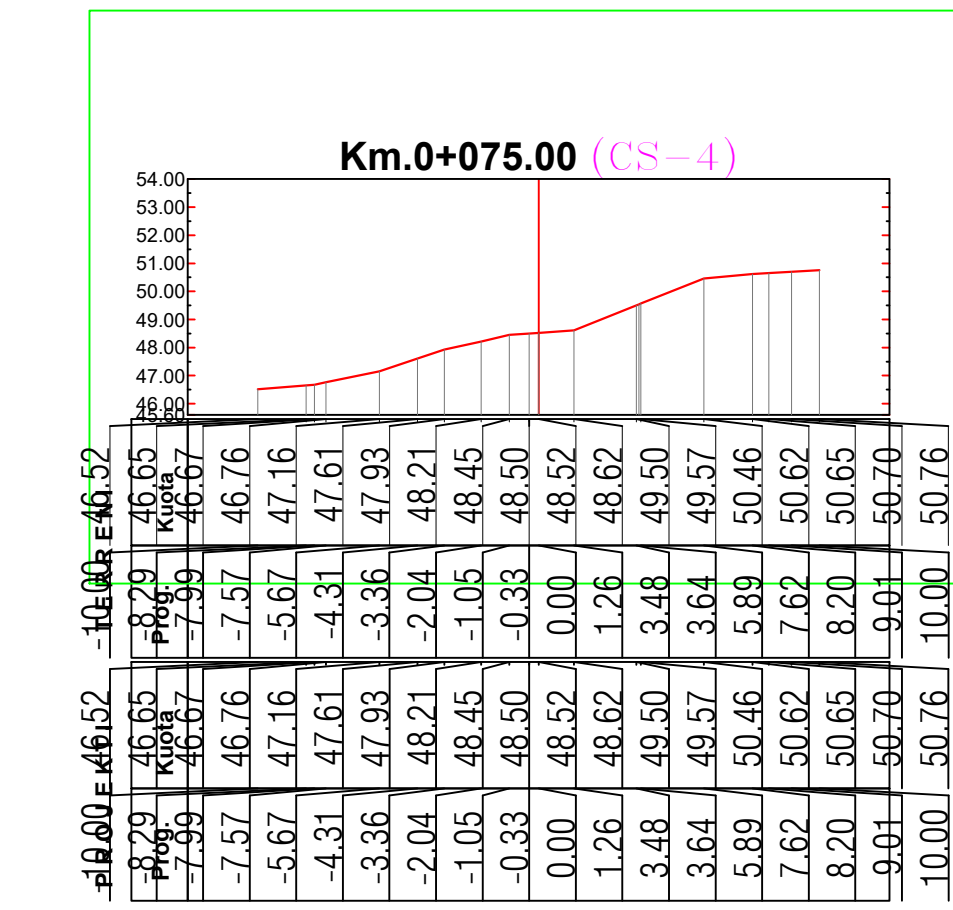
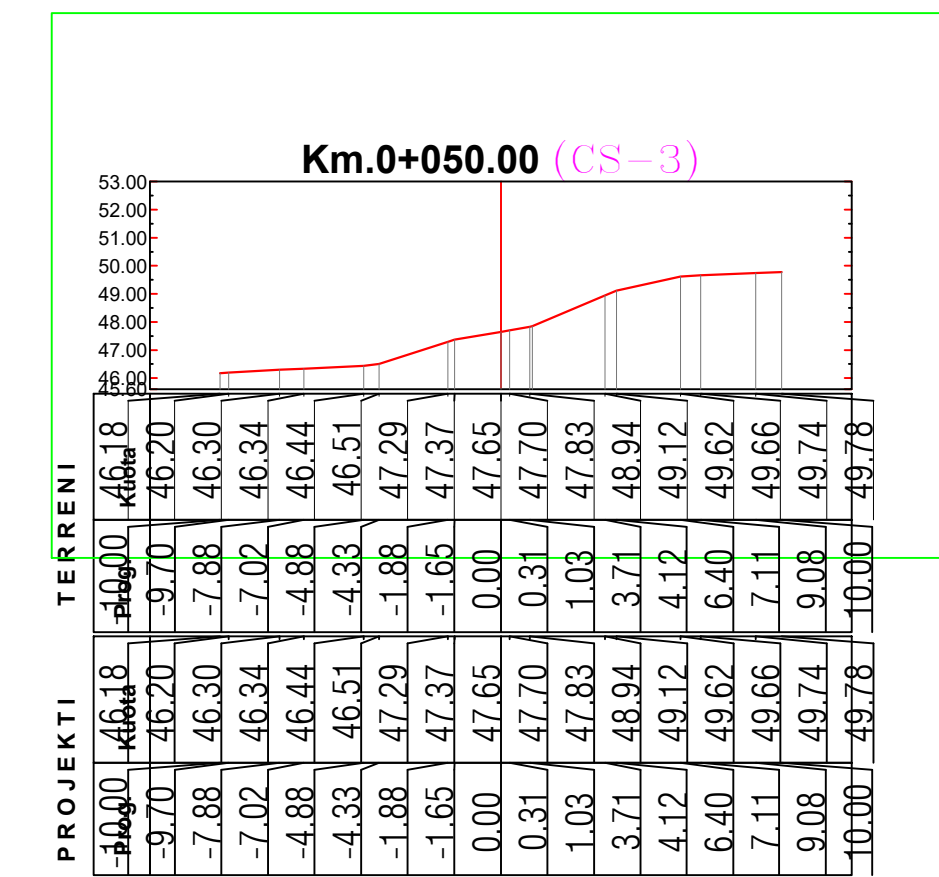
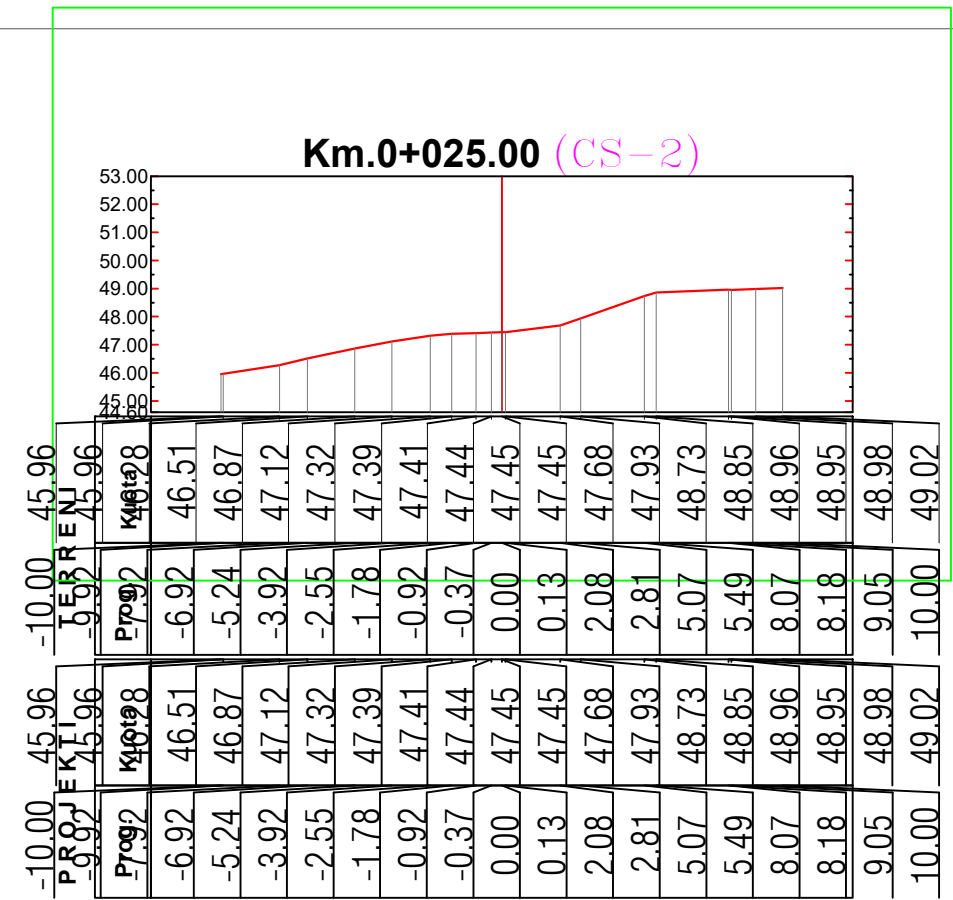
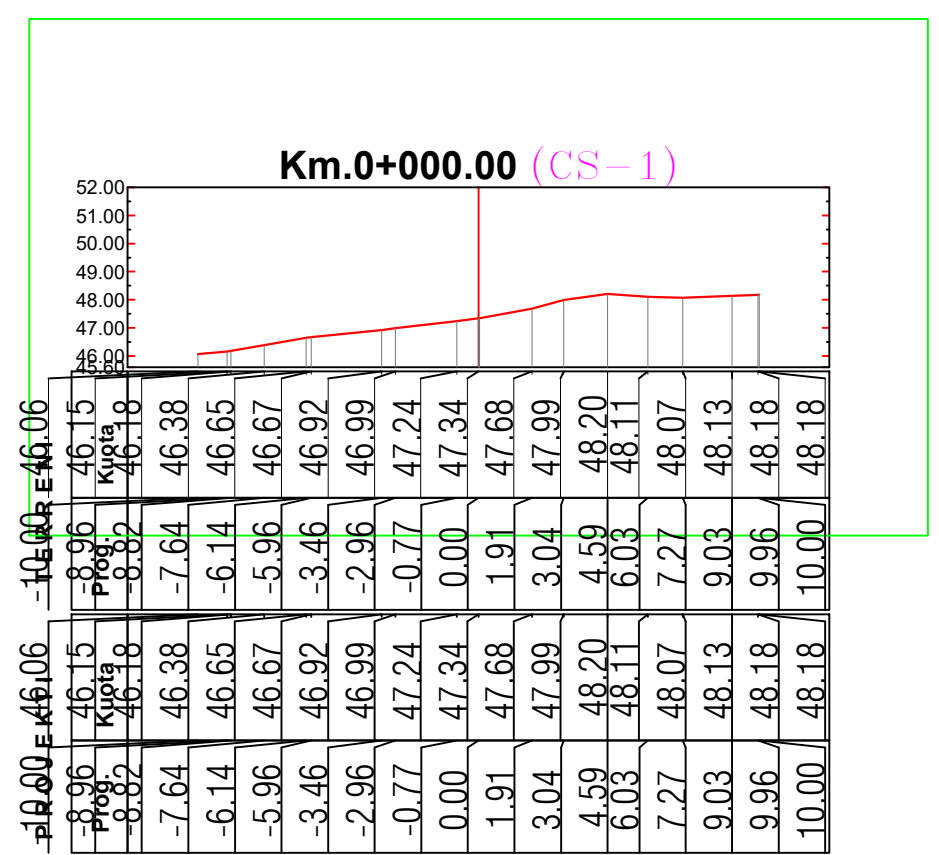



REPUBLIKA E SHQIPËRISË

BASHKIA KRUIJË

EMERTIMI  
 PROJEKT PREVENTIV ZBATIMI  
 SISTEMIM-ASFALTIM I RRUGËS SË " ZALLJANEVE "  
 NJESIA ADMINISTRATIVE FUSHË KRUIJË  
 BASHKIA KRUIJE

EMERTIMI I FLETËS  
 PROJEKT TERTHORE

PROJEKTUESI  
 " ERALD - G " shpk

PROJEKTI	Kuota	TERRENI	PROJEKTI	Kuota	TERRENI
-10.00	47.92	-10.00	47.92	47.92	47.92
-9.43	47.93	-9.43	47.93	47.93	47.93
-8.76	47.94	-8.76	47.94	47.94	47.94
-7.72	47.97	-7.72	47.97	47.97	47.97
PROJEKTI	47.97	TERRENI	47.97	47.97	47.97
Prog.	47.97	Kuota	47.97	47.97	47.97
5.87	47.95	-5.87	47.95	47.95	47.95
-4.67	48.01	-4.67	48.01	48.01	48.01
-4.42	48.04	-4.42	48.04	48.04	48.04
-4.03	48.13	-4.03	48.13	48.13	48.13
-2.97	48.41	-2.97	48.41	48.41	48.41
-2.29	48.59	-2.29	48.59	48.59	48.59
-1.53	48.89	-1.53	48.89	48.89	48.89
-0.34	49.15	-0.34	49.15	49.15	49.15
0.00	49.22	0.00	49.22	49.22	49.22
1.37	49.33	1.37	49.33	49.33	49.33
2.47	49.45	2.47	49.45	49.45	49.45
2.81	49.50	2.81	49.50	49.50	49.50
3.35	49.60	3.35	49.60	49.60	49.60
4.26	49.75	4.26	49.75	49.75	49.75
4.85	49.84	4.85	49.84	49.84	49.84
5.70	49.92	5.70	49.92	49.92	49.92
7.04	49.95	7.04	49.95	49.95	49.95
7.15	49.96	7.15	49.96	49.96	49.96
8.60	49.96	8.60	49.96	49.96	49.96
9.60	49.95	9.60	49.95	49.95	49.95
10.00	49.95	10.00	49.95	49.95	49.95

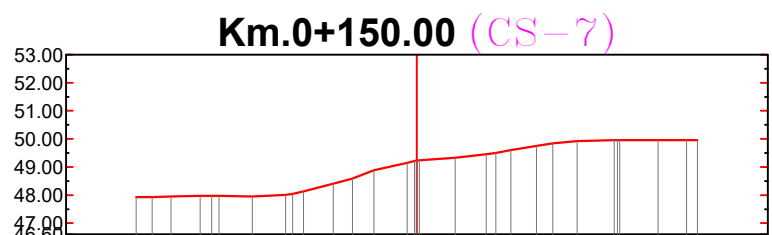

Km.0+150.00 (CS-7)

PROJEKTI	Kuota	TERRENI	PROJEKTI	Kuota	TERRENI
-10.00	47.68	-10.00	47.68	47.68	47.68
-8.03	47.78	-8.03	47.78	47.78	47.78
-6.06	47.89	-6.06	47.89	47.89	47.89
-5.68	47.91	-5.68	47.91	47.91	47.91
-5.44	47.92	-5.44	47.92	47.92	47.92
-3.34	47.96	-3.34	47.96	47.96	47.96
-1.61	47.98	-1.61	47.98	47.98	47.98
-0.99	47.99	-0.99	47.99	47.99	47.99
0.00	48.02	0.00	48.02	48.02	48.02
1.35	48.06	1.35	48.06	48.06	48.06
2.22	48.28	2.22	48.28	48.28	48.28
3.69	48.86	3.69	48.86	48.86	48.86
6.02	49.68	6.02	49.68	49.68	49.68
8.38	50.02	8.38	50.02	50.02	50.02
9.88	50.31	9.88	50.31	50.31	50.31
10.00	50.33	10.00	50.33	50.33	50.33

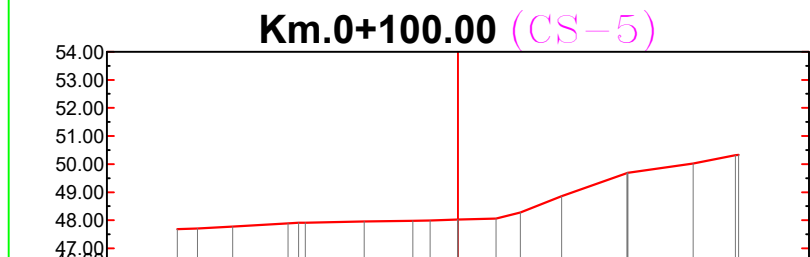

Km.0+100.00 (CS-5)

PROJEKTI	Kuota	TERRENI	PROJEKTI	Kuota	TERRENI
-10.00	48.42	-10.00	48.42	48.42	48.42
-9.06	48.56	-9.06	48.56	48.56	48.56
-8.47	48.61	-8.47	48.61	48.61	48.61
-7.54	48.78	-7.54	48.78	48.78	48.78
PROJEKTI	48.99	TERRENI	48.99	48.99	48.99
Prog.	49.11	Kuota	49.11	49.11	49.11
-5.42	49.44	-5.42	49.44	49.44	49.44
-4.51	49.97	-4.51	49.97	49.97	49.97
-4.10	50.11	-4.10	50.11	50.11	50.11
-2.99	50.24	-2.99	50.24	50.24	50.24
-1.92	50.31	-1.92	50.31	50.31	50.31
-1.47	50.31	-1.47	50.31	50.31	50.31
-0.46	50.34	-0.46	50.34	50.34	50.34
0.00	50.35	0.00	50.35	50.35	50.35
0.26	50.36	0.26	50.36	50.36	50.36
1.56	50.43	1.56	50.43	50.43	50.43
2.45	50.43	2.45	50.43	50.43	50.43
3.08	50.43	3.08	50.43	50.43	50.43
4.51	50.46	4.51	50.46	50.46	50.46
4.63	50.46	4.63	50.46	50.46	50.46
6.11	50.49	6.11	50.49	50.49	50.49
6.81	50.53	6.81	50.53	50.53	50.53
7.63	50.52	7.63	50.52	50.52	50.52
9.00	50.54	9.00	50.54	50.54	50.54
9.15	50.55	9.15	50.55	50.55	50.55
9.48	50.55	9.48	50.55	50.55	50.55
10.00	50.56	10.00	50.56	50.56	50.56

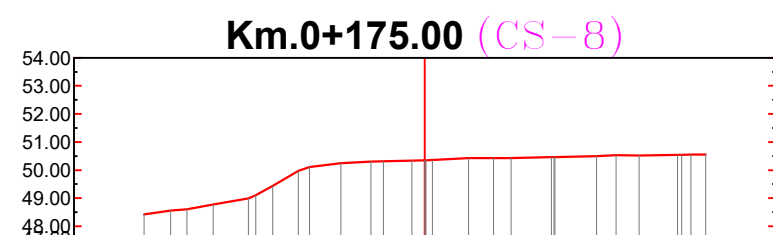

Km.0+175.00 (CS-8)

PROJEKTI	Kuota	TERRENI	PROJEKTI	Kuota	TERRENI
-10.00	48.05	-10.00	48.05	48.05	48.05
-9.74	48.07	-9.74	48.07	48.07	48.07
-7.72	48.21	-7.72	48.21	48.21	48.21
PROJEKTI	48.21	TERRENI	48.21	48.21	48.21
Prog.	48.21	Kuota	48.21	48.21	48.21
-5.71	48.22	-5.71	48.22	48.22	48.22
-5.44	48.22	-5.44	48.22	48.22	48.22
-3.69	48.20	-3.69	48.20	48.20	48.20
-3.11	48.18	-3.11	48.18	48.18	48.18
-1.67	48.11	-1.67	48.11	48.11	48.11
-0.78	48.12	-0.78	48.12	48.12	48.12
0.00	48.09	0.00	48.09	48.09	48.09
0.34	48.07	0.34	48.07	48.07	48.07
1.54	48.34	1.54	48.34	48.34	48.34
2.36	48.51	2.36	48.51	48.51	48.51
3.87	49.04	3.87	49.04	49.04	49.04
4.38	49.25	4.38	49.25	49.25	49.25
6.19	49.43	6.19	49.43	49.43	49.43
6.39	49.45	6.39	49.45	49.45	49.45
7.70	49.49	7.70	49.49	49.49	49.49
8.41	49.51	8.41	49.51	49.51	49.51
8.52	49.51	8.52	49.51	49.51	49.51
10.00	49.56	10.00	49.56	49.56	49.56

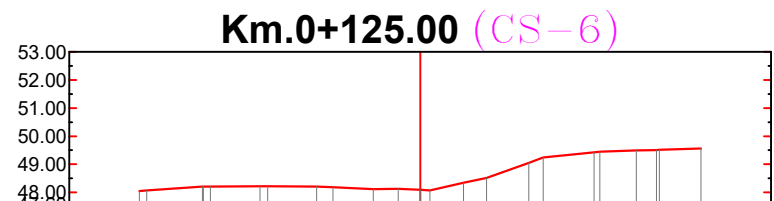

Km.0+125.00 (CS-6)



REPUBLIKA E SHQIPËRISË

BASHKIA KRUJË

EMERTIMI  
 PROJEKT PREVENTIV ZBATIMI  
 SISTEMIM-ASFALTIM I RRUGËS SË " ZALLJANEVE "  
 NJESIA ADMINISTRATIVE FUSHË KRUJË  
 BASHKIA KRUJË

EMERTIMI | FLETËS  
 PROFILET TERTHORE

PROJEKTUESI  
 " ERALD - G " shpk

-10.00	48.35	-10.00	48.35	48.35
-9.62	48.39	-9.62	48.39	48.39
-8.93	48.45	-8.93	48.45	48.45
-7.90	48.82	-7.90	48.82	48.82
<b>PROR</b>	<b>K10.23</b>	<b>PROR</b>	<b>K10.23</b>	<b>PROR</b>
<b>PROR</b>	<b>K10.63</b>	<b>PROR</b>	<b>K10.63</b>	<b>PROR</b>
-4.87	50.41	-4.87	50.41	50.41
-4.46	50.63	-4.46	50.63	50.63
-2.84	51.59	-2.84	51.59	51.59
-2.73	51.62	-2.73	51.62	51.62
-2.14	51.73	-2.14	51.73	51.73
-1.01	51.95	-1.01	51.95	51.95
-0.81	51.98	-0.81	51.98	51.98
0.00	52.00	0.00	52.00	52.00
0.71	52.01	0.71	52.01	52.01
1.22	52.03	1.22	52.03	52.03
2.44	52.89	2.44	52.89	52.89
3.25	53.28	3.25	53.28	53.28
4.16	53.60	4.16	53.60	53.60
5.28	54.07	5.28	54.07	54.07
5.88	54.03	5.88	54.03	54.03
7.32	54.08	7.32	54.08	54.08
7.60	54.05	7.60	54.05	54.05
9.22	53.97	9.22	53.97	53.97
9.33	53.96	9.33	53.96	53.96
10.00	53.97	10.00	53.97	53.97

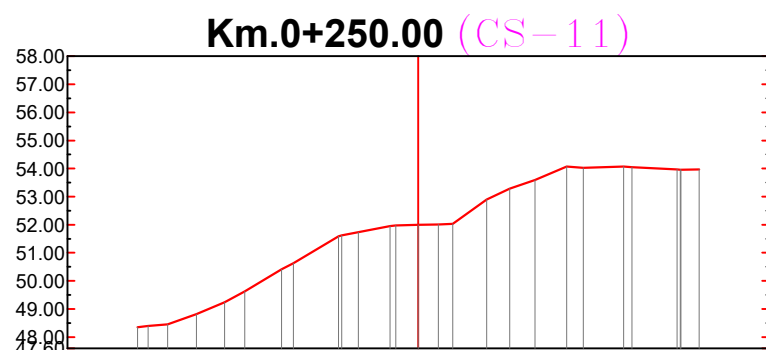

Km.0+250.00 (CS-11)

-10.00	49.23	-10.00	49.23	49.23
-9.56	49.31	-9.56	49.31	49.31
-8.01	49.81	-8.01	49.81	49.81
-6.50	49.91	-6.50	49.91	49.91
<b>PROR</b>	<b>K10.98</b>	<b>PROR</b>	<b>K10.98</b>	<b>PROR</b>
<b>PROR</b>	<b>K10.15</b>	<b>PROR</b>	<b>K10.15</b>	<b>PROR</b>
-3.68	50.40	-3.68	50.40	50.40
-3.44	50.48	-3.44	50.48	50.48
-2.88	50.59	-2.88	50.59	50.59
-1.92	50.79	-1.92	50.79	50.79
-1.51	50.82	-1.51	50.82	50.82
-0.39	50.87	-0.39	50.87	50.87
0.00	50.90	0.00	50.90	50.90
0.65	50.94	0.65	50.94	50.94
1.14	50.97	1.14	50.97	50.97
2.32	51.02	2.32	51.02	51.02
2.67	51.04	2.67	51.04	51.04
2.82	51.04	2.82	51.04	51.04
4.20	51.06	4.20	51.06	51.06
4.98	51.07	4.98	51.07	51.07
5.73	51.10	5.73	51.10	51.10
7.15	51.15	7.15	51.15	51.15
7.26	51.15	7.26	51.15	51.15
7.52	51.15	7.52	51.15	51.15
8.79	51.16	8.79	51.16	51.16
9.31	51.17	9.31	51.17	51.17
10.00	51.20	10.00	51.20	51.20
-10.00	48.25	-10.00	48.25	48.25

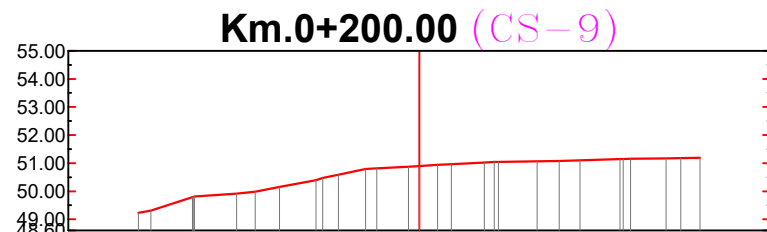

Km.0+200.00 (CS-9)

-10.00	48.39	-10.00	48.39	48.39
-9.99	48.39	-9.99	48.39	48.39
-9.34	48.51	-9.34	48.51	48.51
<b>PROR</b>	<b>K10.65</b>	<b>PROR</b>	<b>K10.65</b>	<b>PROR</b>
<b>PROR</b>	<b>K10.71</b>	<b>PROR</b>	<b>K10.71</b>	<b>PROR</b>
-5.99	49.26	-5.99	49.26	49.26
-5.28	49.61	-5.28	49.61	49.61
-4.27	50.18	-4.27	50.18	50.18
-3.25	50.72	-3.25	50.72	50.72
-2.55	50.95	-2.55	50.95	50.95
-1.22	51.31	-1.22	51.31	51.31
-0.82	51.34	-0.82	51.34	51.34
0.00	51.40	0.00	51.40	51.40
0.82	51.46	0.82	51.46	51.46
1.37	51.48	1.37	51.48	51.48
2.85	51.55	2.85	51.55	51.55
4.35	52.24	4.35	52.24	52.24
4.88	52.38	4.88	52.38	52.38
6.07	53.00	6.07	53.00	53.00
6.91	53.34	6.91	53.34	53.34
7.79	53.48	7.79	53.48	53.48
8.94	53.71	8.94	53.71	53.71
9.51	53.65	9.51	53.65	53.65
10.00	53.58	10.00	53.58	53.58

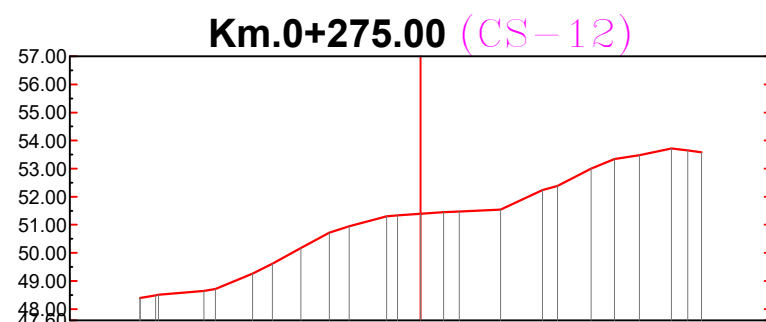

Km.0+275.00 (CS-12)

-10.00	48.26	-10.00	48.26	48.26
-9.96	48.26	-9.96	48.26	48.26
-9.76	48.30	-9.76	48.30	48.30
-8.43	48.76	-8.43	48.76	48.76
<b>PROR</b>	<b>K10.17</b>	<b>PROR</b>	<b>K10.17</b>	<b>PROR</b>
<b>PROR</b>	<b>K10.51</b>	<b>PROR</b>	<b>K10.51</b>	<b>PROR</b>
-5.37	50.25	-5.37	50.25	50.25
-5.25	50.31	-5.25	50.31	50.31
-3.84	50.89	-3.84	50.89	50.89
-3.26	51.12	-3.26	51.12	51.12
-2.32	51.31	-2.32	51.31	51.31
-1.09	51.50	-1.09	51.50	51.50
-0.79	51.51	-0.79	51.51	51.51
0.00	51.57	0.00	51.57	51.57
0.74	51.62	0.74	51.62	51.62
1.07	51.66	1.07	51.66	51.66
2.27	52.15	2.27	52.15	52.15
3.24	52.65	3.24	52.65	52.65
3.80	52.89	3.80	52.89	52.89
5.15	53.50	5.15	53.50	53.50
5.33	53.56	5.33	53.56	53.56
6.86	53.22	6.86	53.22	53.22
7.57	53.04	7.57	53.04	53.04
8.39	52.76	8.39	52.76	52.76
9.74	52.40	9.74	52.40	52.40
9.92	52.40	9.92	52.40	52.40
10.00	52.42	10.00	52.42	52.42

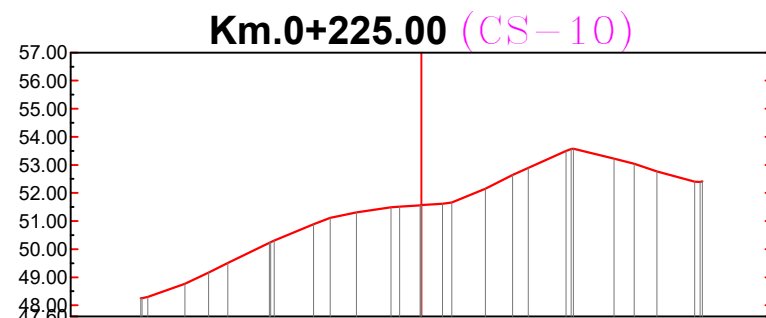

Km.0+225.00 (CS-10)



REPUBLIKA E SHQIPËRISË

BASHKIA KRUJË

EMERTIMI  
 PROJEKT PREVENTIV ZBATIMI  
 SISTEMIM-ASFALTIM I RRUGËS SË " ZALLJANEVE "  
 NJESIA ADMINISTRATIVE FUSHË KRUJË  
 BASHKIA KRUJË

EMERTIMI I FLETËS  
 PROFILET TERTHORE

PROJEKTUESI  
 " ERALD - G " shpk

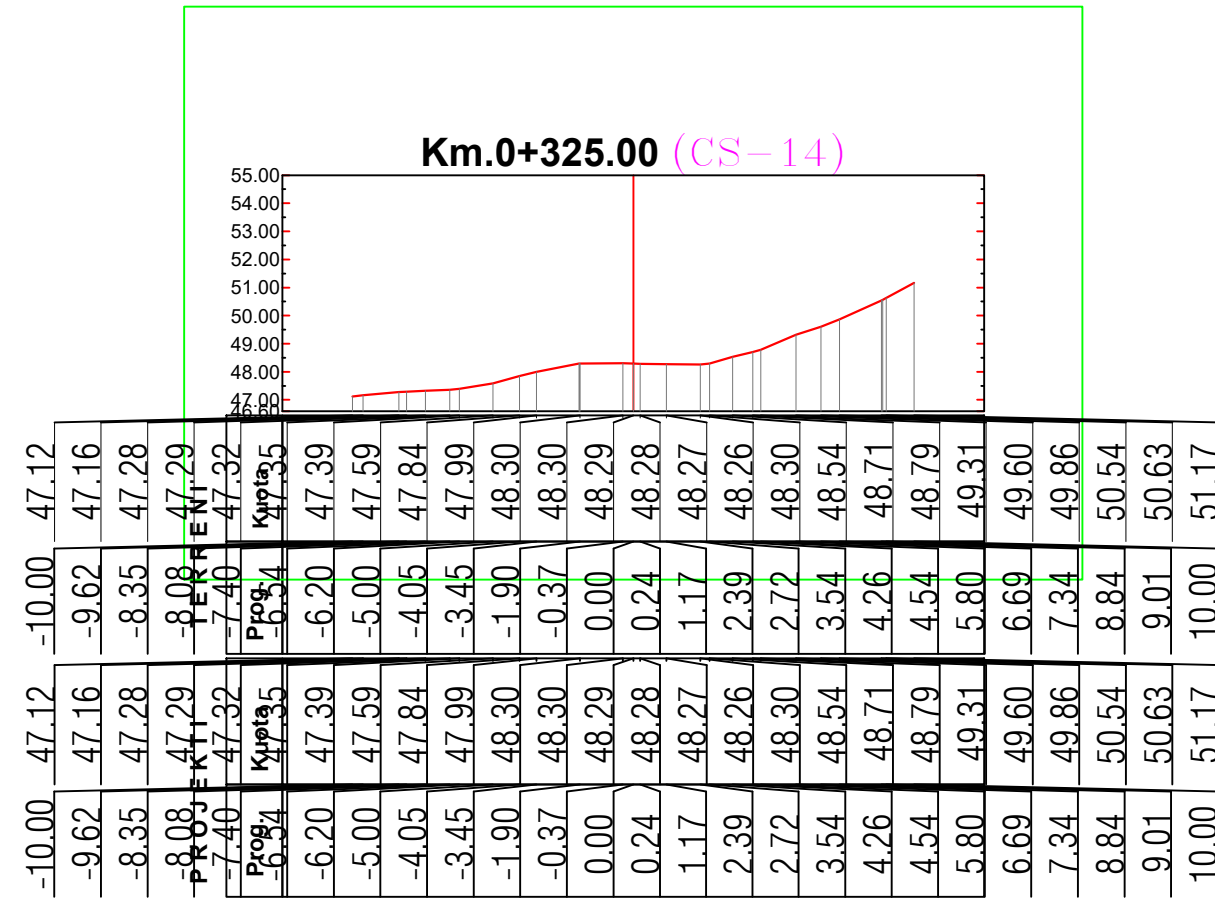
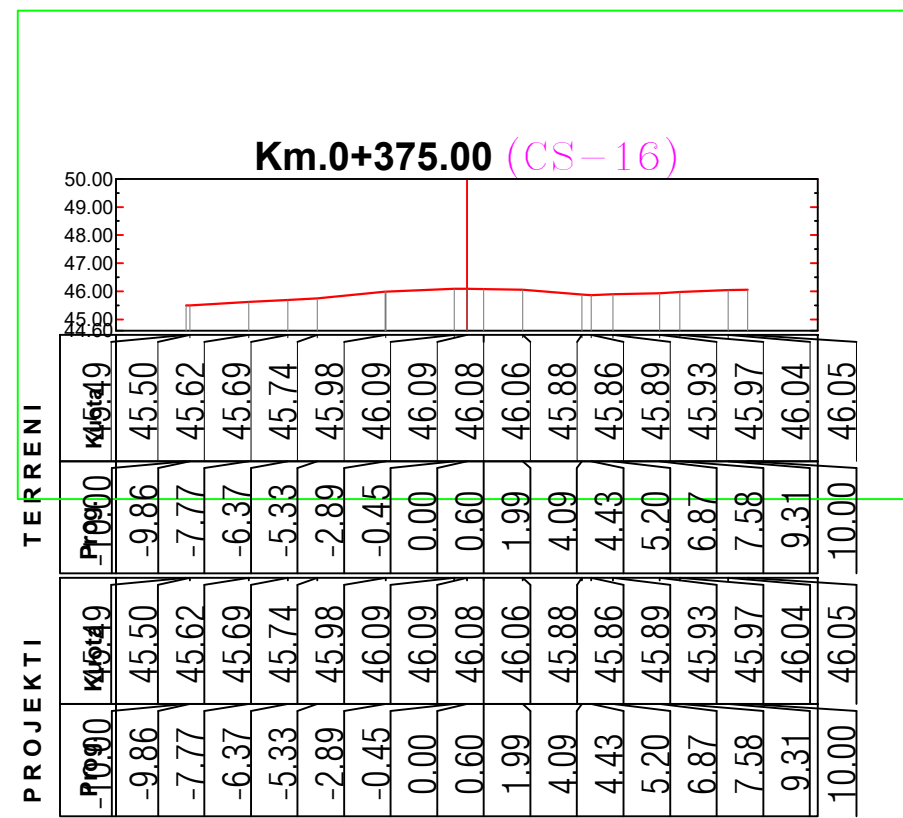
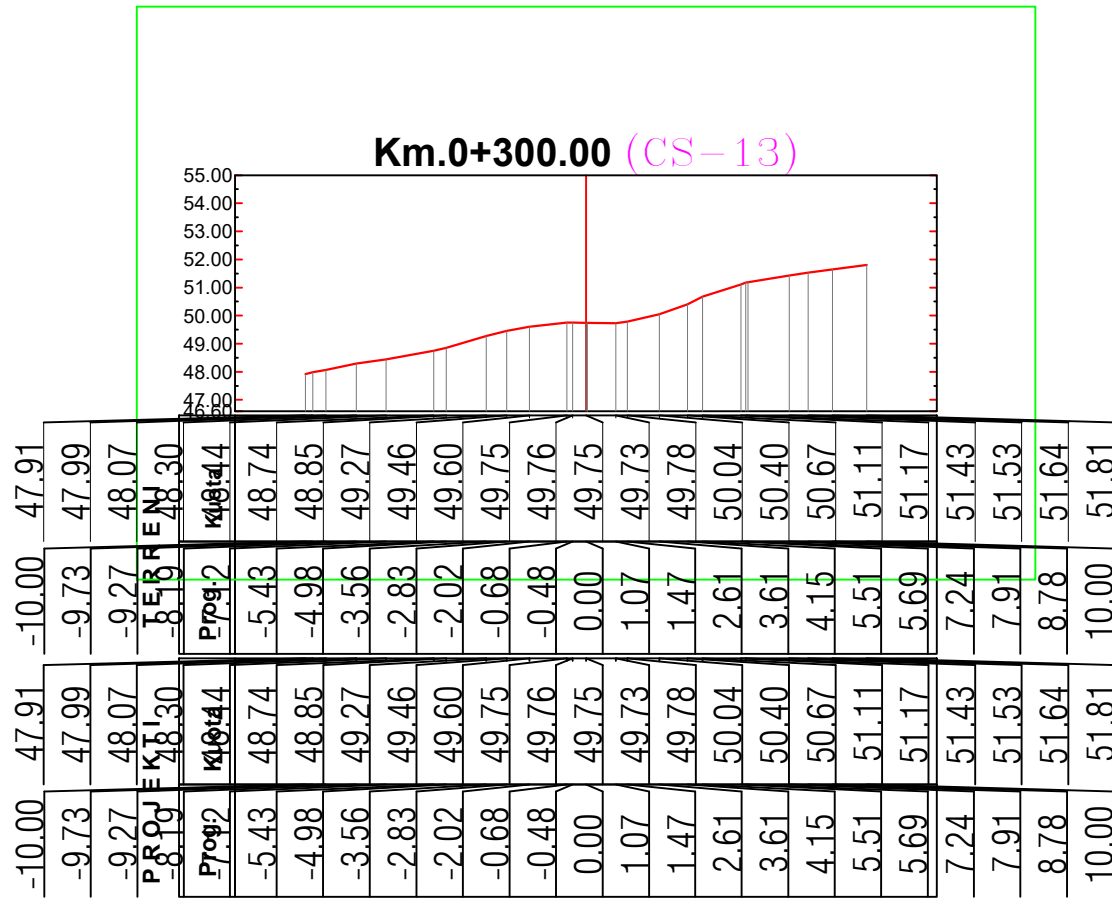
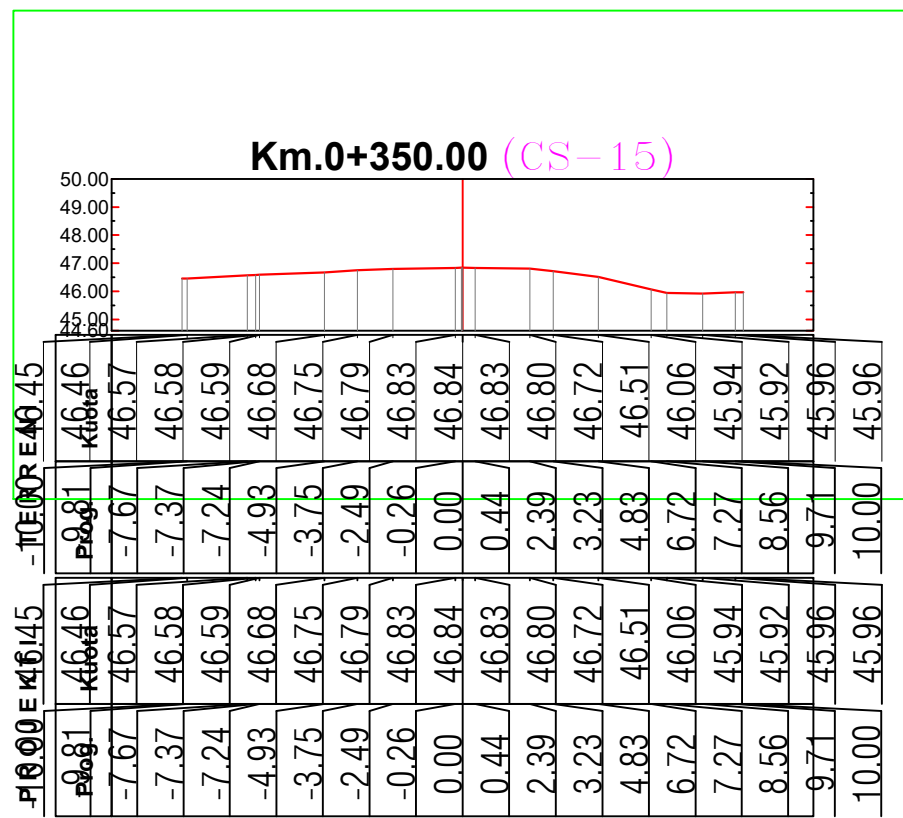



REPUBLIKA E SHQIPËRISË

BASHKIA KRUJË

EMERTIMI  
 PROJEKT PREVENTIV ZBATIMI  
 SISTEMIM-ASFALTIM I RRUGËS SË " ZALLJANEVE "  
 NJESIA ADMINISTRATIVE FUSHË KRUJË  
 BASHKIA KRUJË

EMERTIMI I FLETËS  
 PROFILET TERTHORE

PROJEKTUESI  
 " ERALD - G " shpk

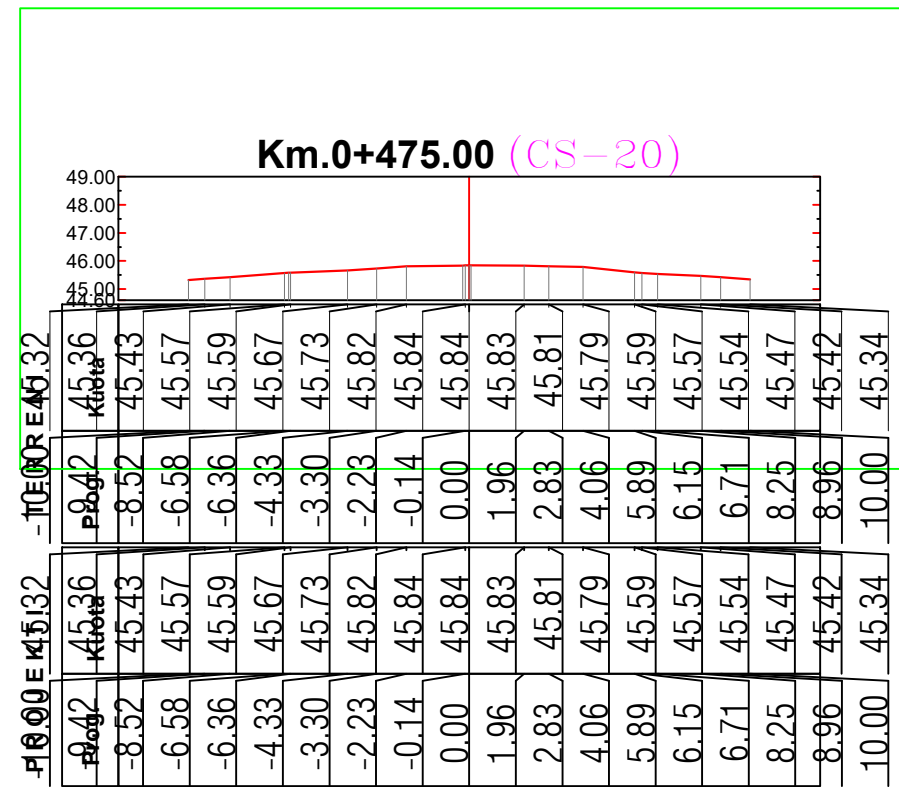
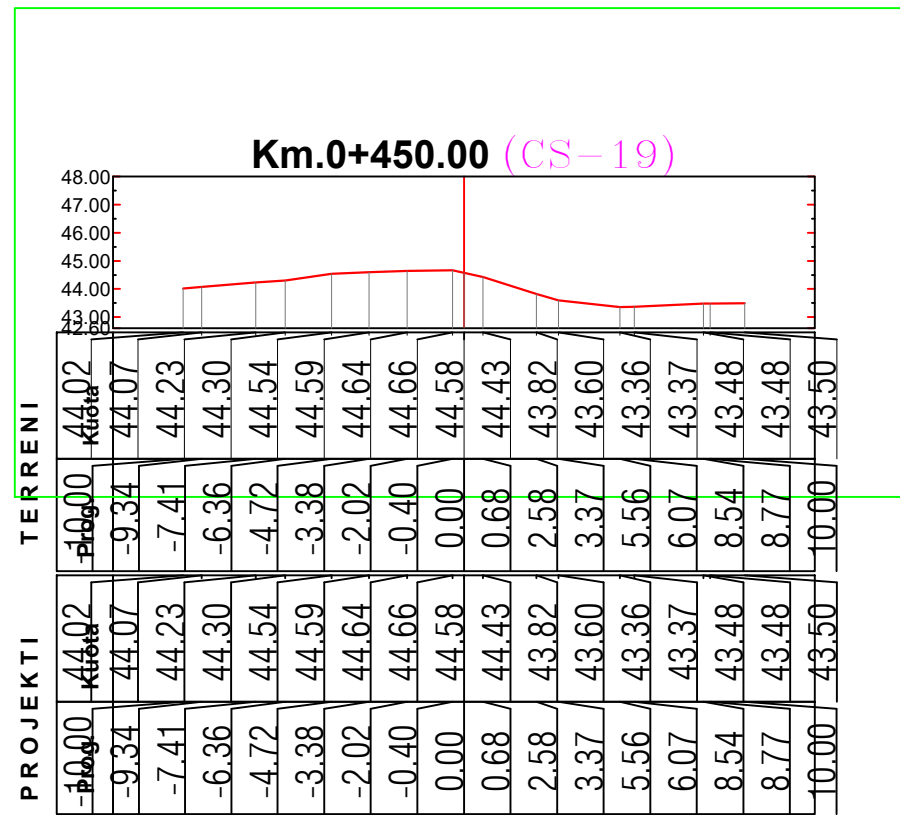
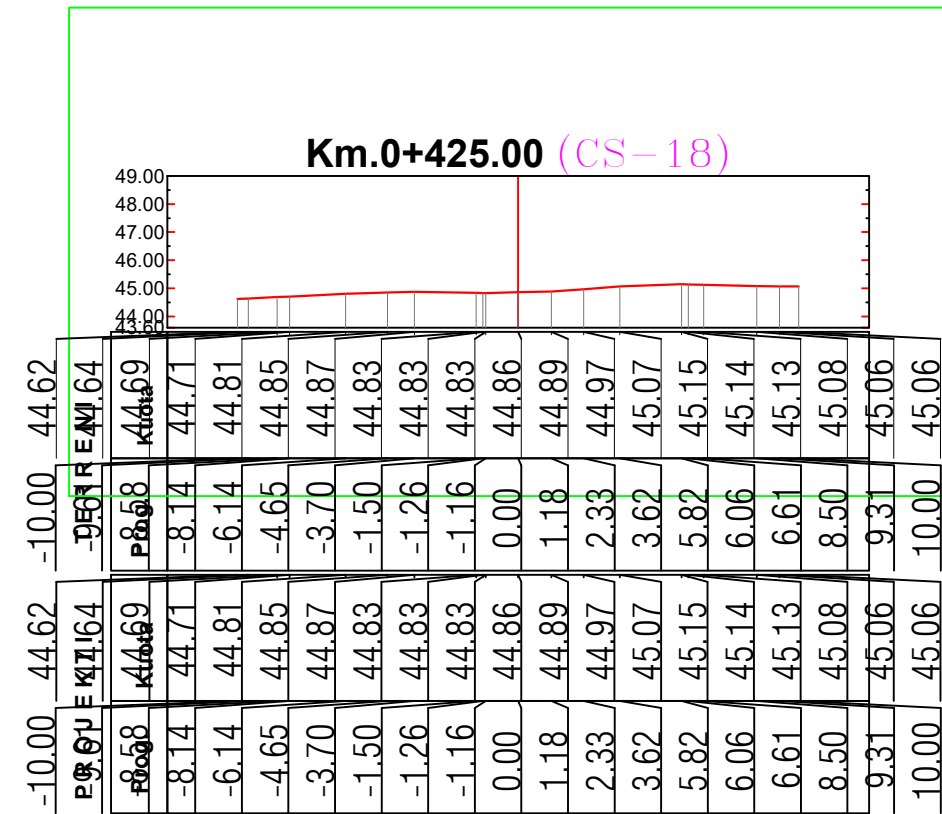
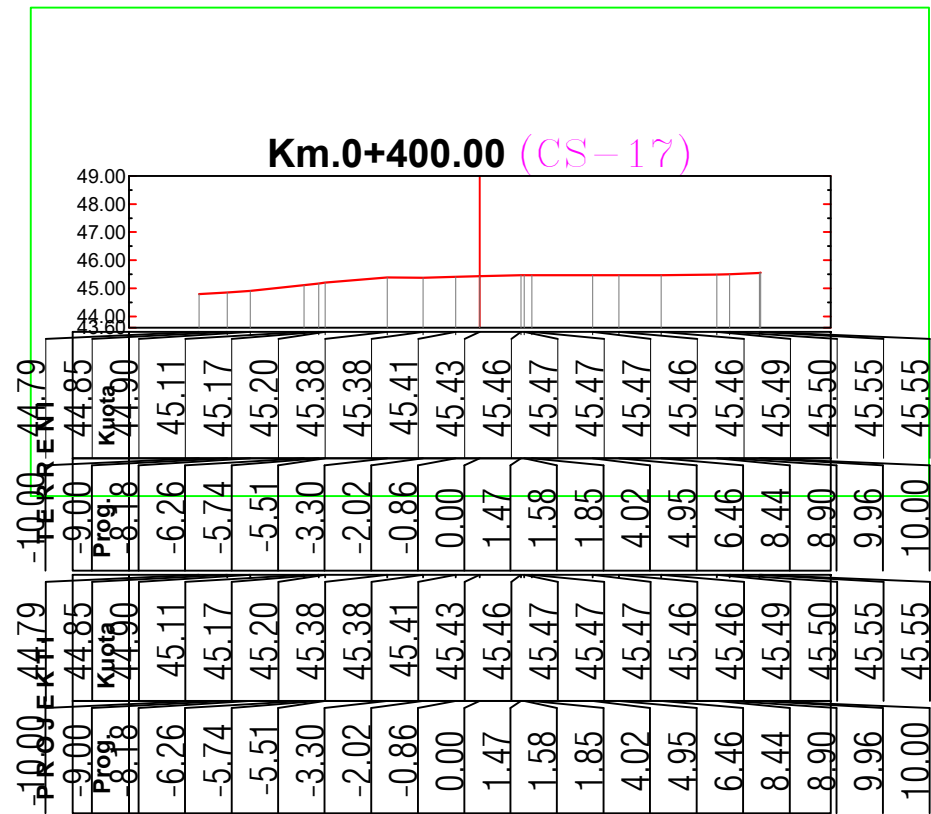





REPUBLIKA E SHQIPËRISË

BASHKIA KRUJË

EMERTIMI  
 PROJEKT PREVENTIV ZBATIMI  
 SISTEMIM-ASFALTIM I RRUGËS SË " ZALLJANEVE "  
 NJESIA ADMINISTRATIVE FUSHË KRUJË  
 BASHKIA KRUJË

EMERTIMI I FLETËS  
 PROFILET TERTHORE

PROJEKTUESI  
 " ERALD - G " shpk

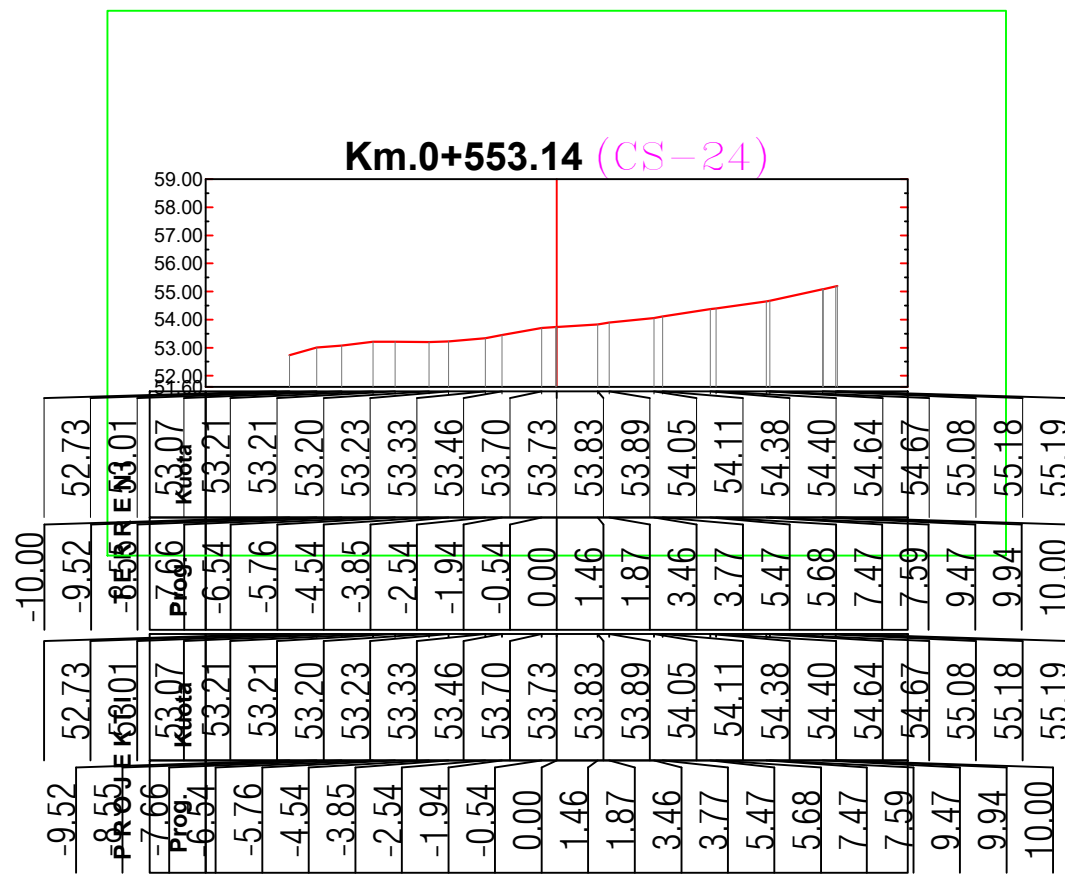
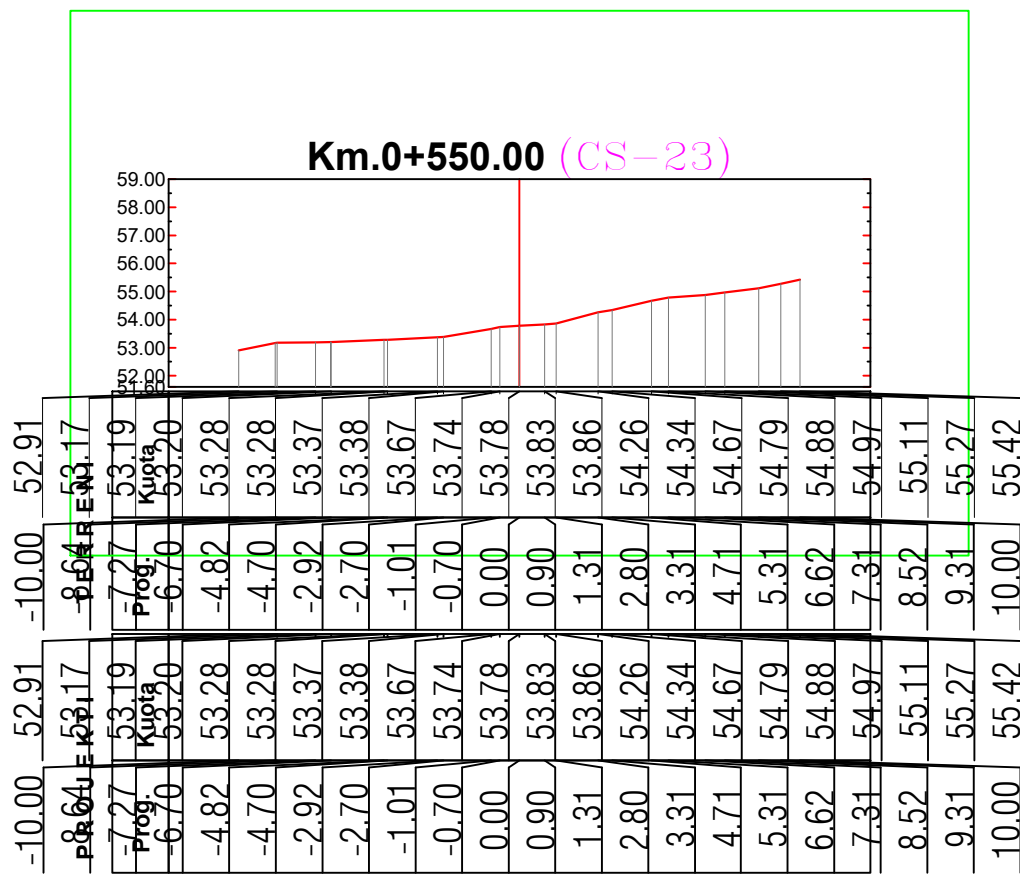
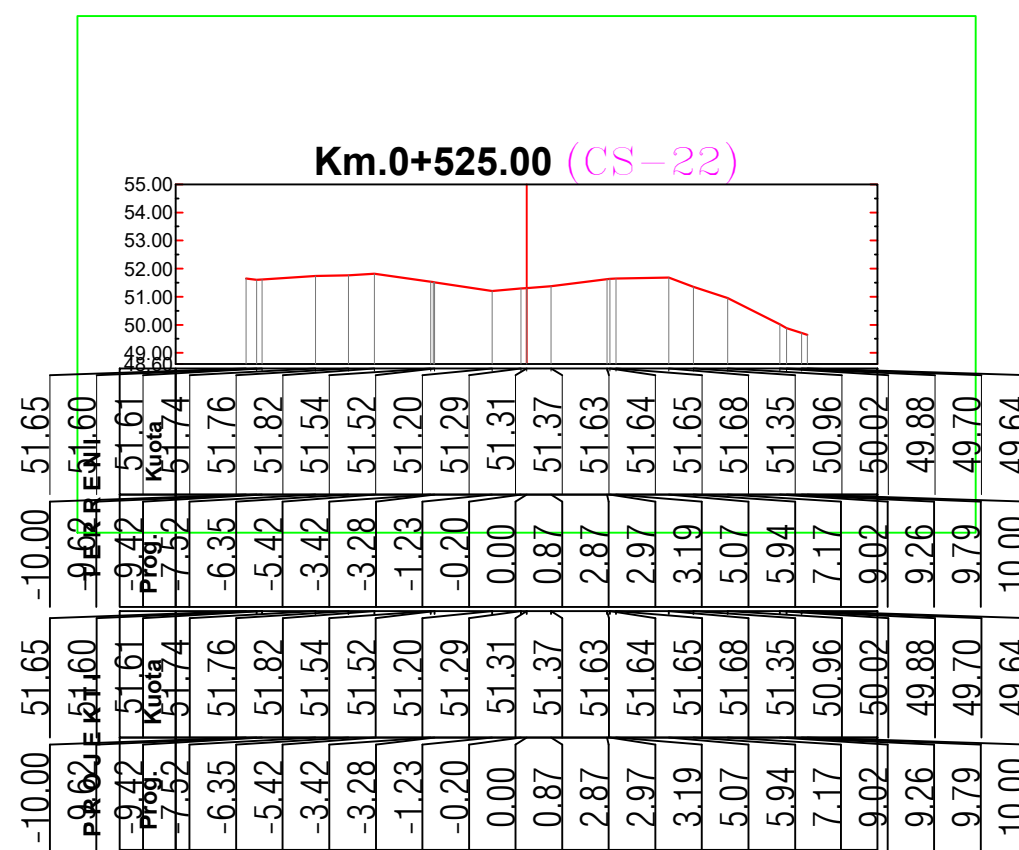
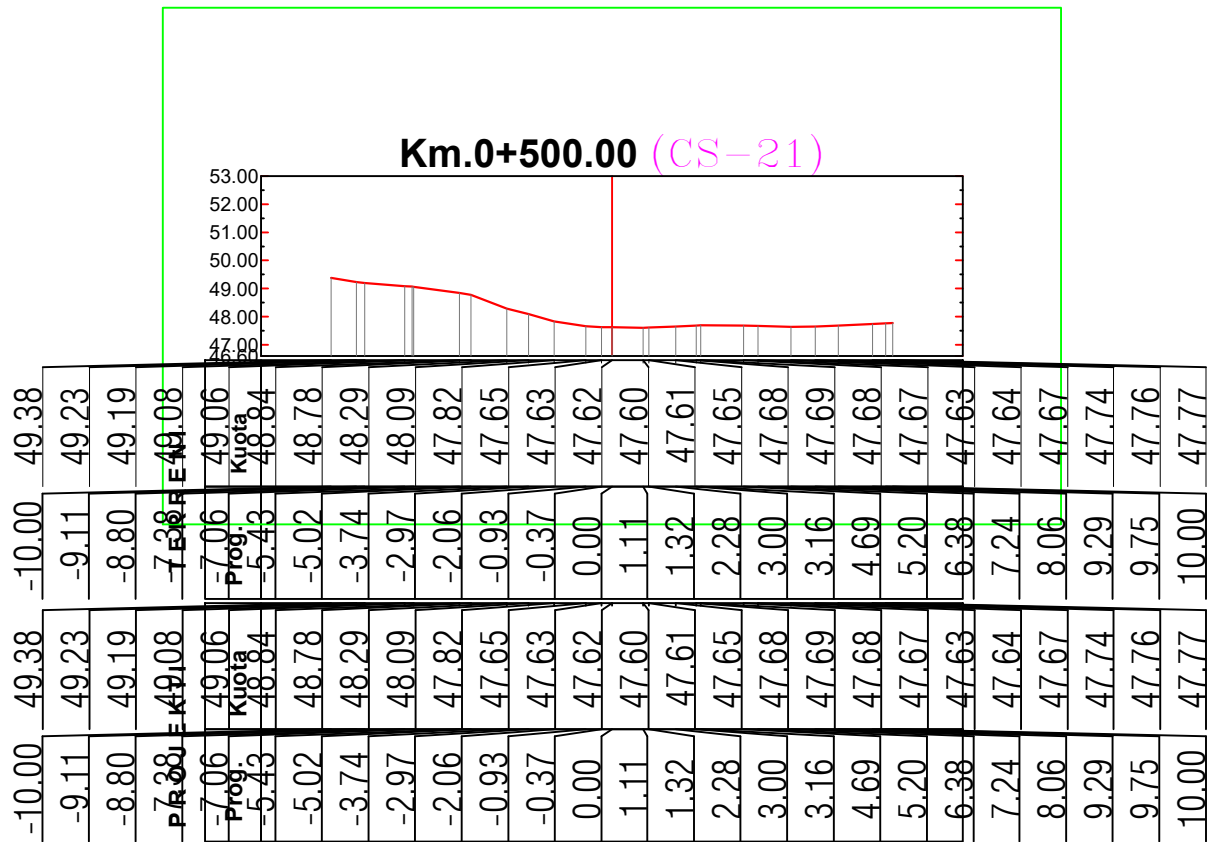

### HOLLESI NDERTIMORE TE TOMBINOS Ø400mm, L=5m

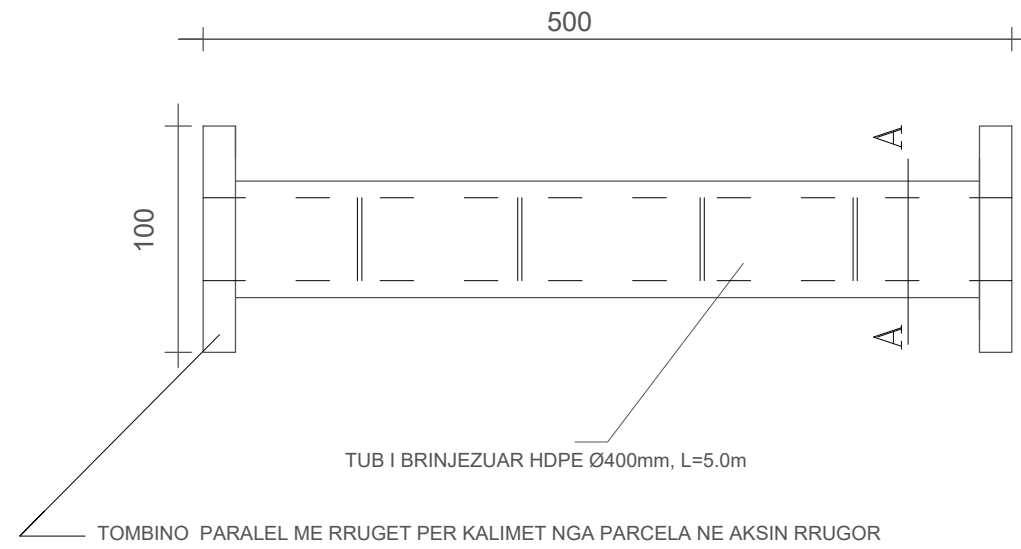

#### PRERJE A-A

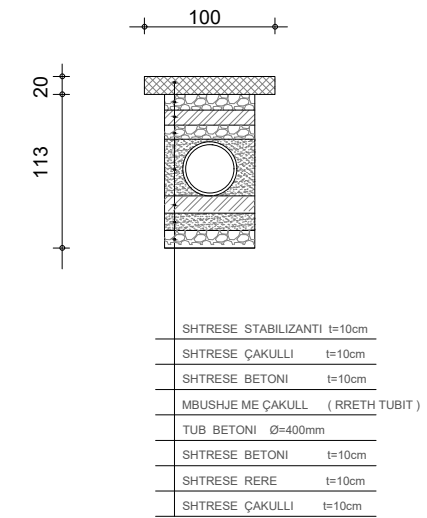

### HOLLESI NDERTIMORE TE TOMBINOS Ø=600mm,L=6m

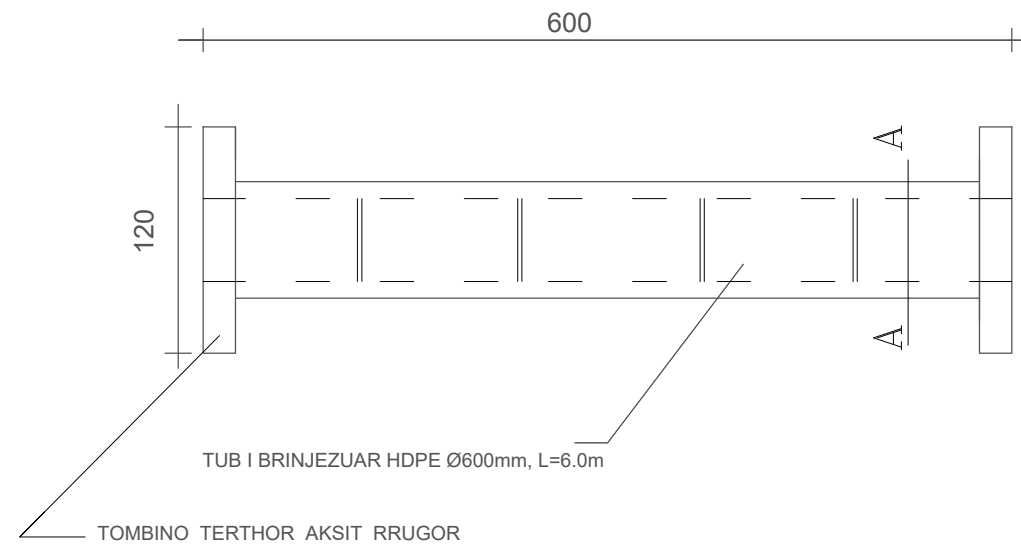

#### PRERJE A-A

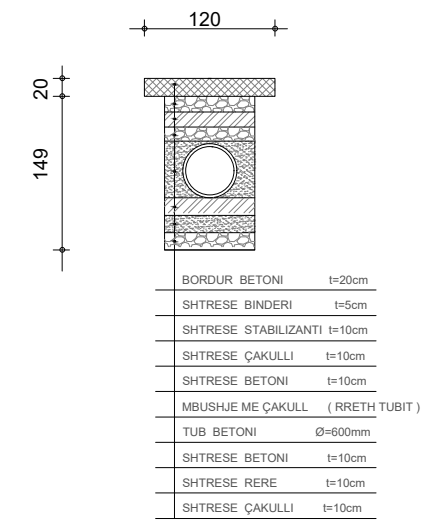

REPUBLIKA E SHQIPËRISË

BASHKIA KRUIJË

EMERTIMI  
 PROJEKT PREVENTIV ZBATIMI  
 SISTEMIM-ASFALTIM I RRUGËS SË " ZALLJANEVE "  
 NJESIA ADMINISTRATIVE FUSHË KRUIJË  
 BASHKIA KRUIJE

EMERTIMI I FLETËS

TOMBINO

PROJEKTUESI

" ERALD - G " shpk

## PROFILI TERTHORE TIP 1

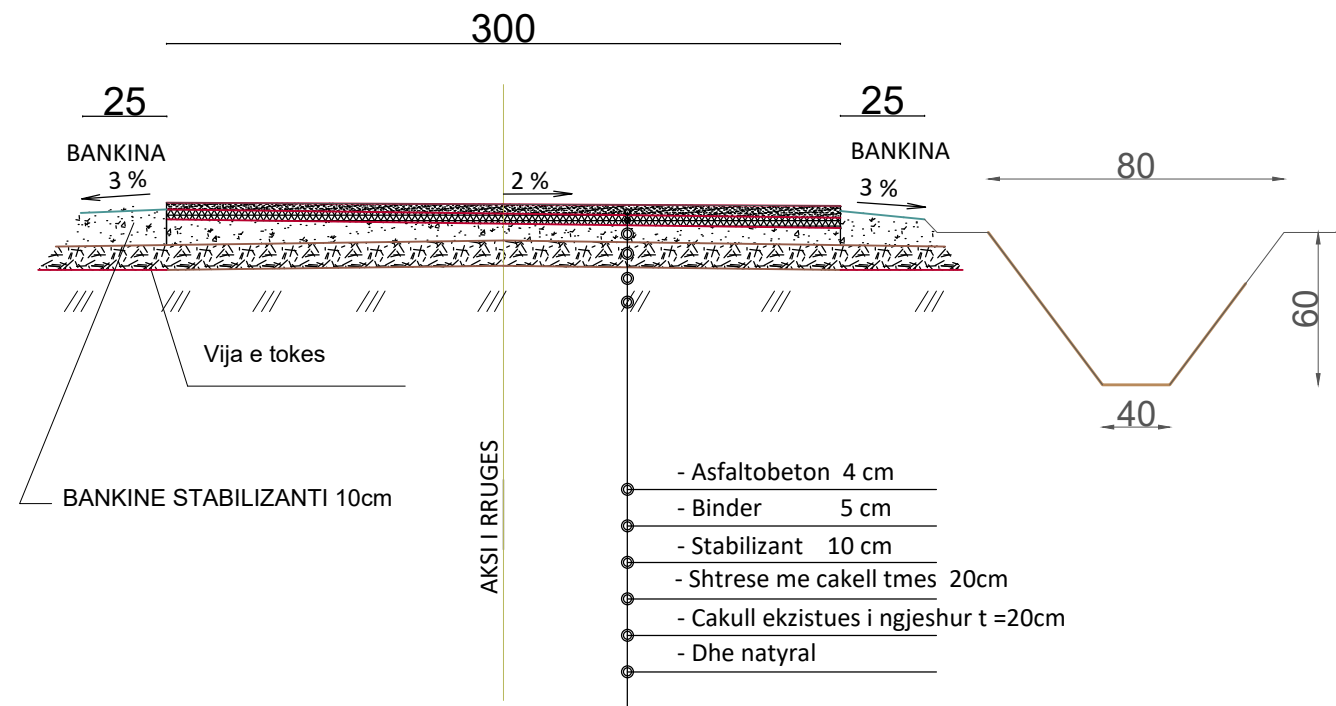

## DETAJ I KUNETES ( PA MURE )

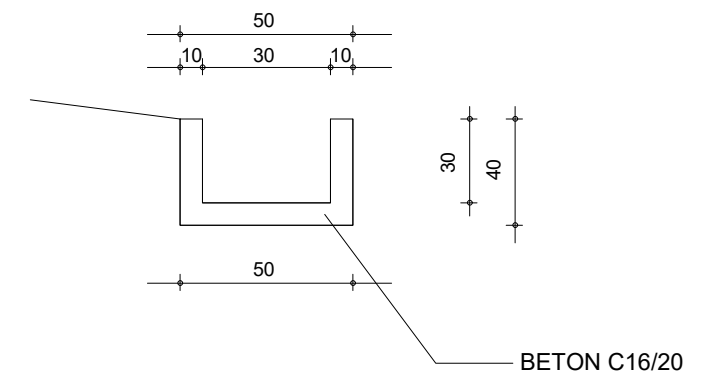

## DETAJ MURI MBAJTES

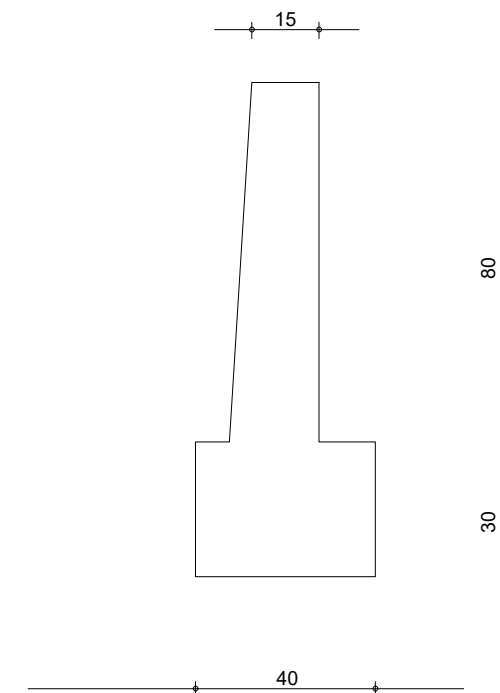

### SHENIME:

- GJATESIA E MUREVE MBAJTES ESHTË 19m
- NE RASTIN KUR NUK ESHTË E NEVOJSHME REALIZIMI I MUREVE , NE VEND TE TYRE TE BEHET KUNETE 90m



REPUBLIKA E SHQIPËRISË

BASHKIA KRUJË

EMERTIMI

PROJEKT PREVENTIV ZBATIMI  
SISTEMIM-ASFALTIM I RRUGËS SË " ZALLJANEVE "

NJESIA ADMINISTRATIVE FUSHË KRUJË

BASHKIA KRUJE

EMERTIMI I FLETËS

TOMBINO

PROJEKTUESI

" ERALD - G " shpk