

09-PROFILA DHE DETAJE TIP (RRUGË DHE SINJALISTIKË)

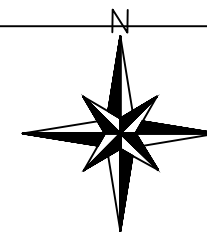

PUSETE KONTROLLI D=1000 mm H=1500-2000 mm SHK 1:50

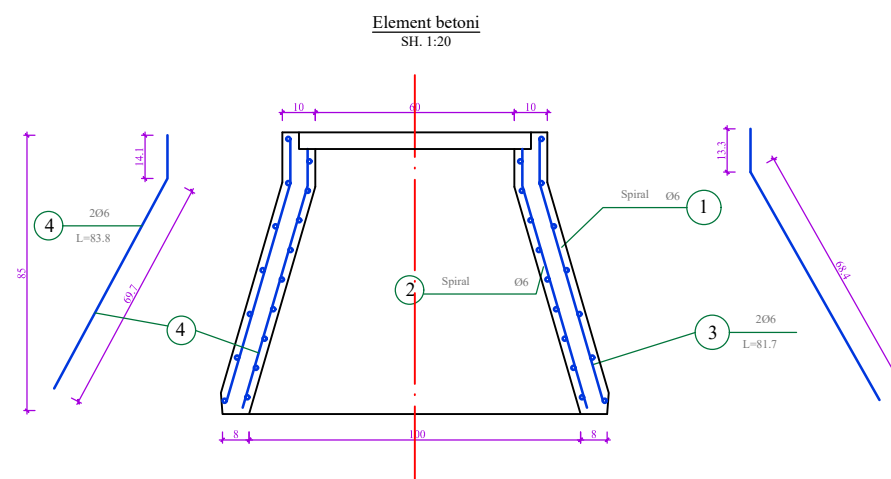
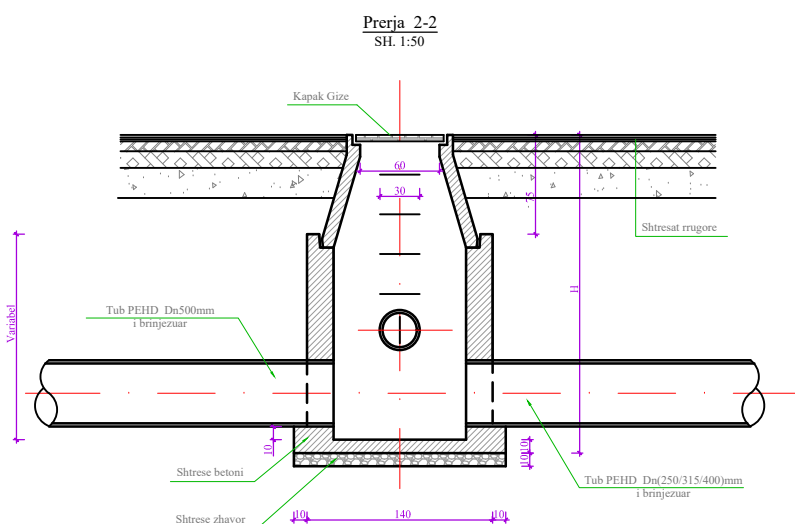
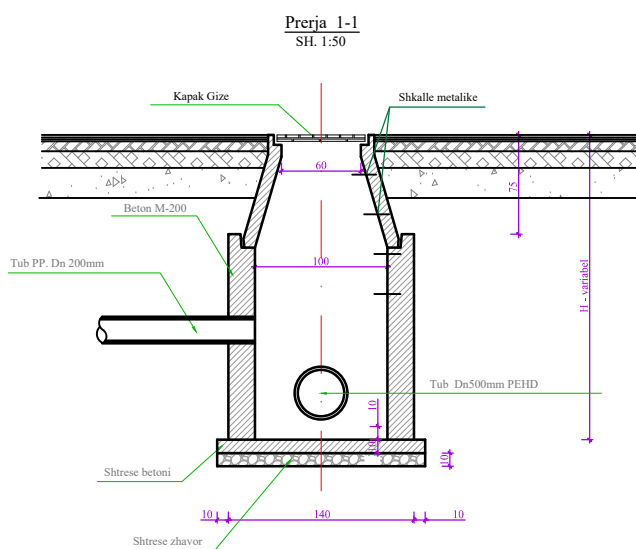

PUSETE KONTROLLI 800x800 mm SHK 1:50

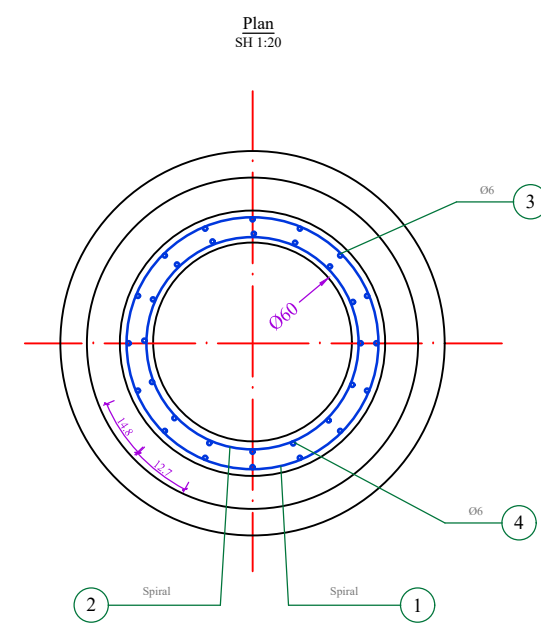
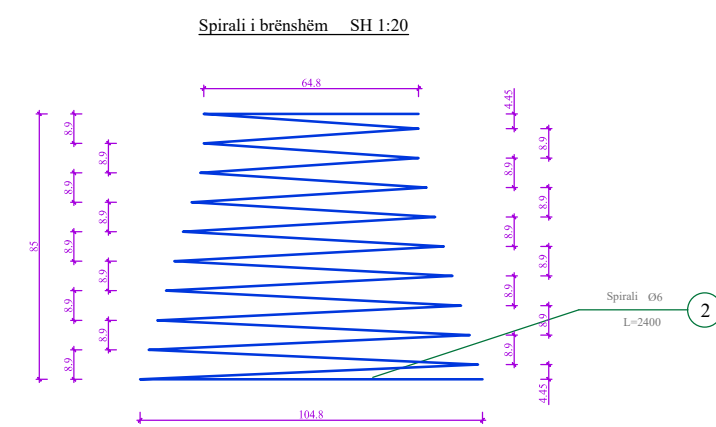
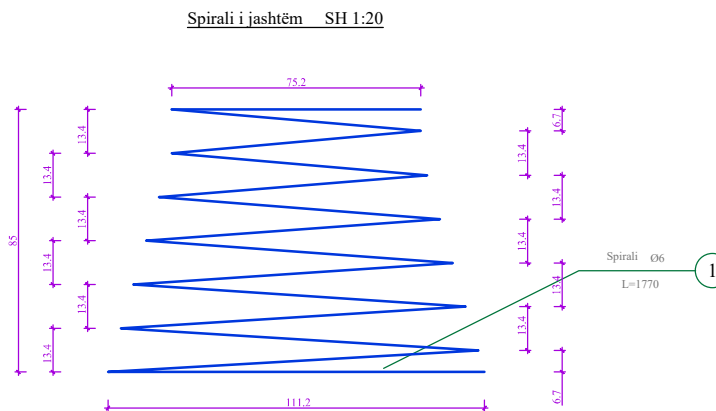
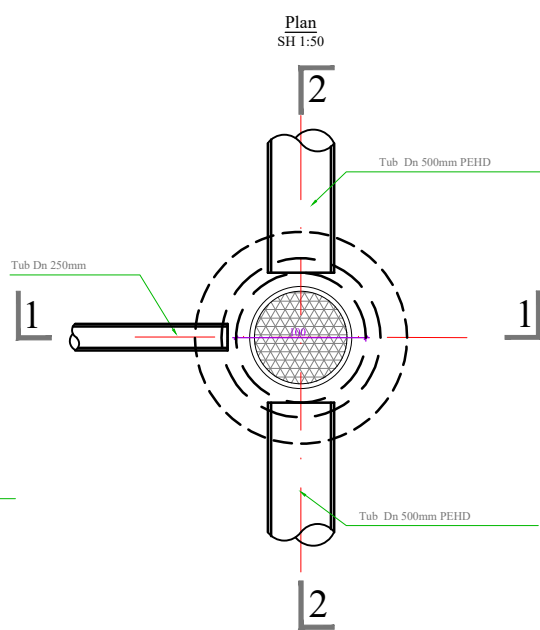
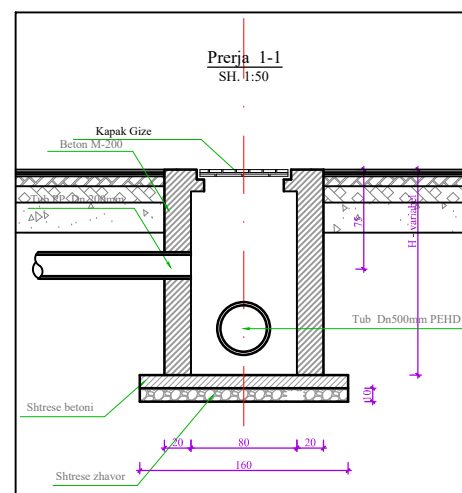

- SHËNIM:**
1. Numri i degëve të kolektorëve dhe pozicionimi i tyre do të merret sipas planimetrisë së rrjetit të K.U.Z.
 2. Lartësia e pusëtës do të merret sipas profilit gjatësor të K.U.Z.
 3. Për realizimin e pusëtës do të përdoret beton M-250.
 4. Poshtë pusëtës do të vendoset shtresë 10cm beton i varfër dhe nën të 10cm shtresë çakëll ose zhavor.
 5. Kapaku i gizës do të ketë diametër Ø60cm dhe do t'i rezistojë një ngarkese jo më të vogël se 15ton.
 6. Detajet janë vizatuar në cm.



OBJEKTI: NDERTIMI I RRUGEVE "BEDRI KARAPICI", "HAMNDI PEPO"DHE "BERNARDIN PALJA".

Projektoi :
Ing.A.JAKOVA
Ing.G.ISLAMI
Ing.S.MYRSELI
Ing.P.SHKURTI

Ark.M.DADO
Ing.Gjeol.Xh.KASMI
Ing.Mjedis.E.CALI
Top.A.BECECI

Projektoi :
"S&L STUDIO SH.P.K"
Projektim-kupervizion-cosnulence

FAZA	PROJEKT ZBATIMI	PROFILI TIP
DORËZIM	1.0	SHKALLA
		Nr. I FLETËS 001

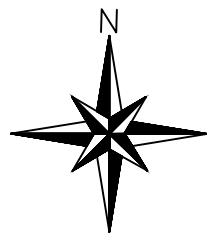

DETAJE TE RRETHIMIT ME MUR DEKORATIV SH 1::25

DETAJE TE RRETHIMIT ME MUR DEKORATIV SH 1::25



TABELA E VOLUMEVE PER NJESI GJATESE MURI RRETHUES						
Murature + Themeli						
Nr.	ELEMENTI	SUPERFAQJA m ²	SASIA Cope	GJATESIA m	VOLUMI TOT m ³	
1	Per themele	0.48	1	1	0.48	
2	Mur tulle	0.23	1	1	0.23	
Konstruksioni metalik						
Nr.	BEKUR KANGJELLA	ELEMENTI	GJATE SIA m	SASIA Cope	PE SHA NJESI kg/m	VOLUMI TOT kg
1		Shufra d = 20mm	9.2	1	2.48	22.82
2		Kolona 50x50mm, s=5mm	0.9	0.5	7.85	3.53
3		Shiza hekau	8	15	0.2	3.00
SASIA TOTALE						29.35



REPUBLIKA E SHQIPËRISË
BASHKIA E TIRANËS

OBJEKTI: NDERTIMI I RRUGEVE "BEDRI
KARAPICI", "HAMNDI PEPO"DHE
"BERNARDIN PALJA".

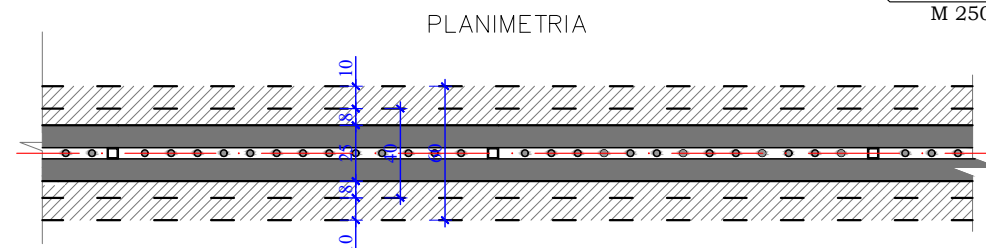
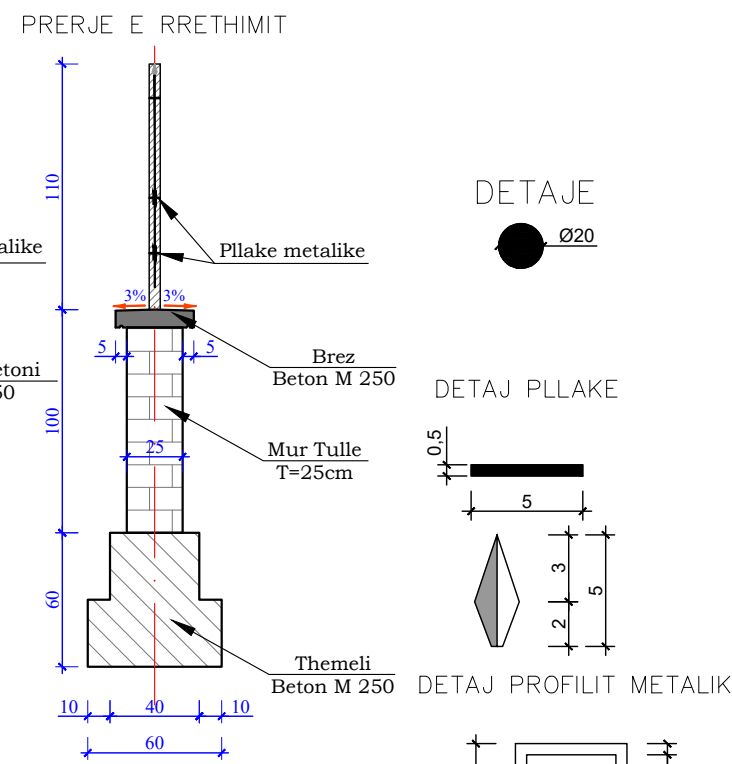
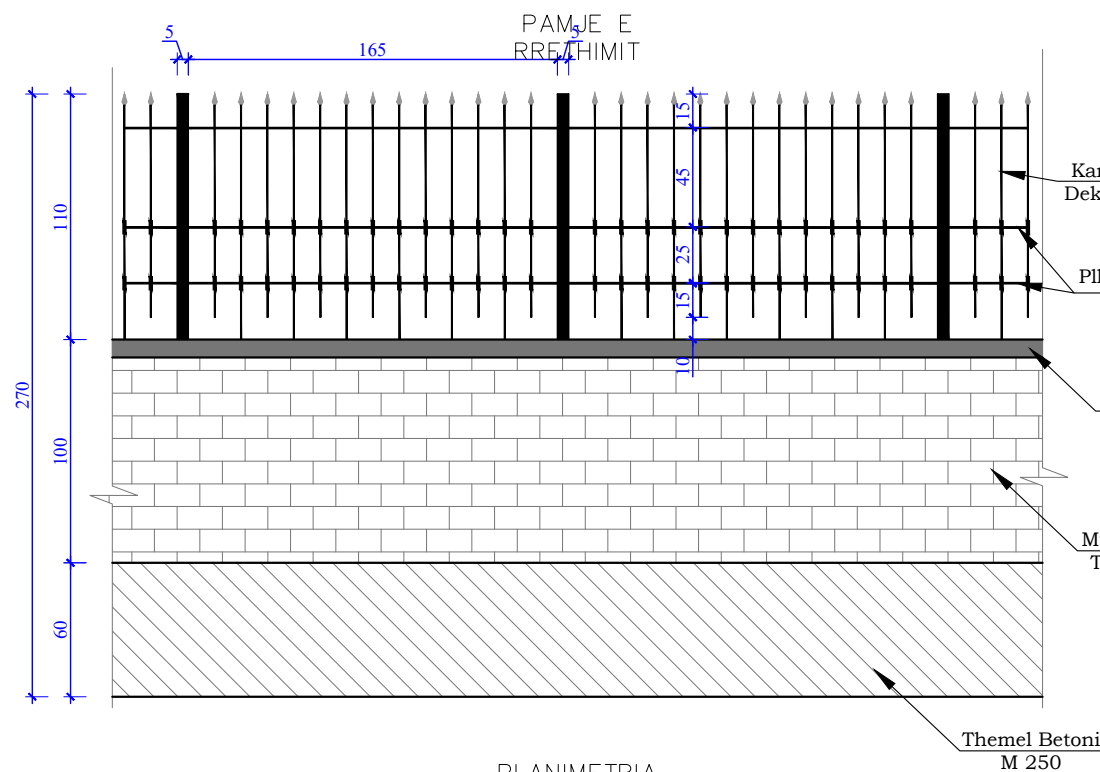
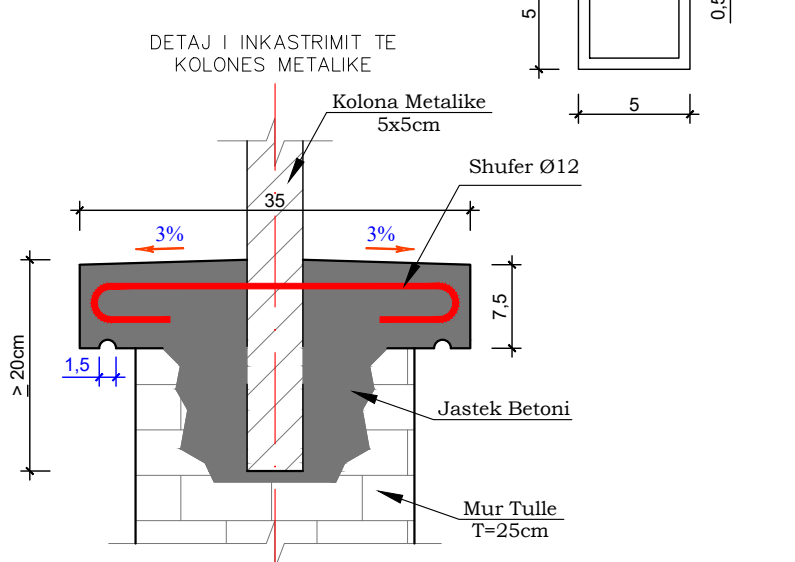
Projektoi :
Ing.A.JAKOVA
Ing.G.ISLAMI
Ing.S.MYRSELI
Ing.P.SHKURTI
Ark.M.DADO
Ing.Gjeol.Xh.KASMI
Ing.Mjedis.E.CALI
Top.A.BECECI

Projektoi :
"S&L STUDIO SH.P.K"
Projektim-kupervizion-cosnulence
RALD-G
PROJEKTIM DESIGN
SUPERVISION KOLAUDIM

FAZA	PROJEKT ZBATIMI	PROFILE TIP DHE DETAJE
DORËZIM	1.0	SHKALLA Nr. I FLETËS 001

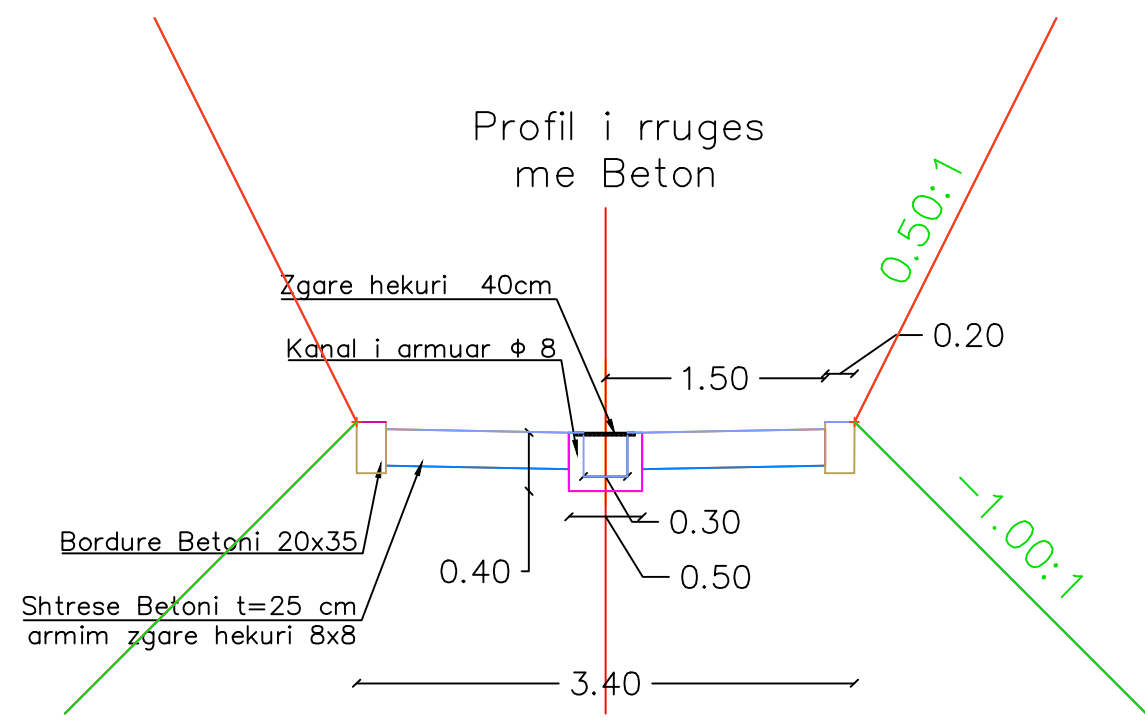
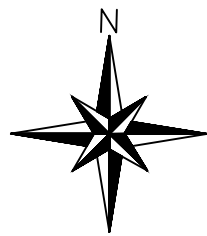

Grile Metalike per Drenimin e Ujrave te Shiut

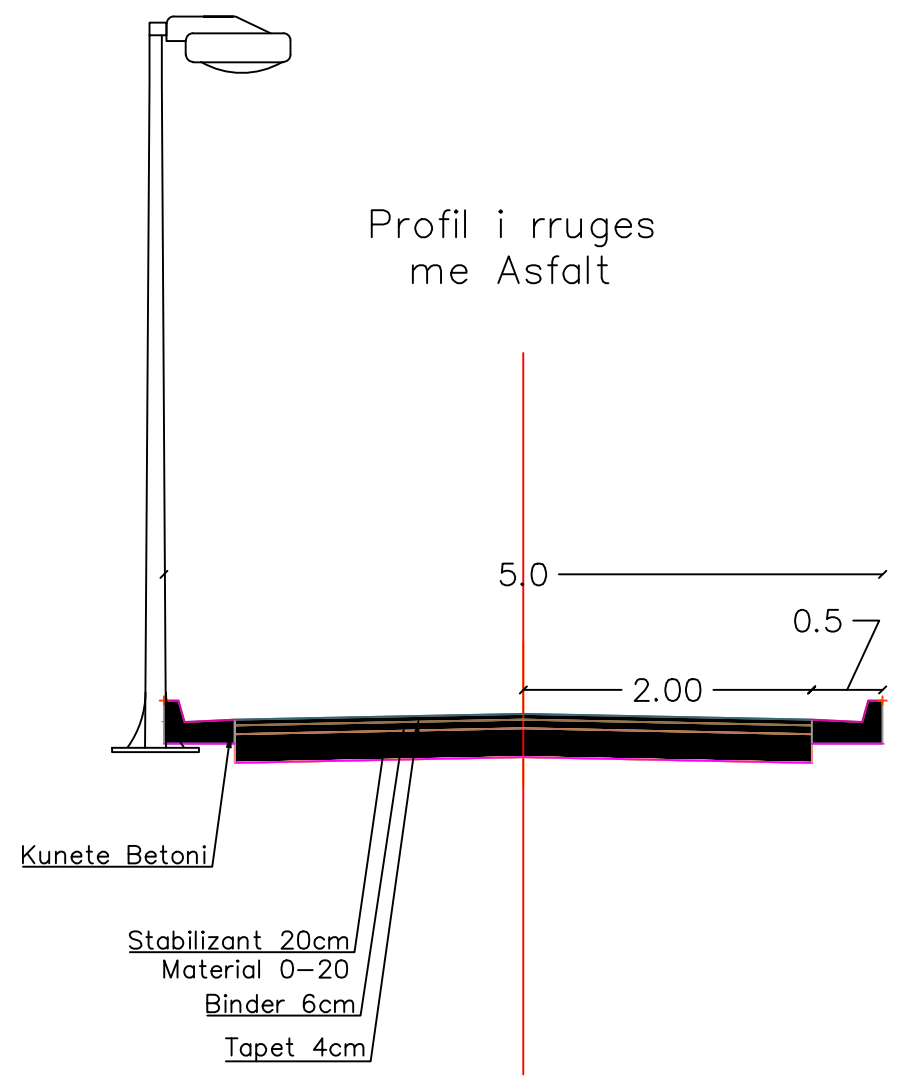
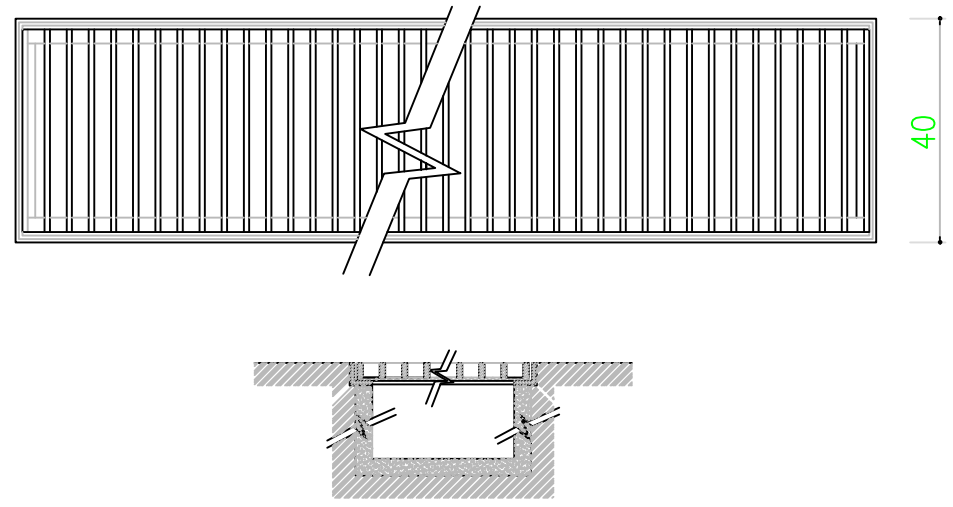

REPUBLIKA E SHQIPËRISË
BASHKIA E TIRANËS

OBJEKTI: NDERTIMI I RRUGEVE "BEDRI KARAPICI", "HAMNDI PEPO"DHE "BERNARDIN PALJA".

Projektoi :
Ing.A.JAKOVA
Ing.G.ISLAMI
Ing.S.MYRSELI
Ing.P.SHKURTI

Ark.M.DADO
Ing.Gjeol.Xh.KASMI
Ing.Mjedis.E.CALI
Top.A.BECECI

Projektoi :
"S&L STUDIO SH.P.K"
Projektim-kupervizion-cosnulence

FAZA	PROJEKT ZBATIMI	PROFILE TIP DHE DETAJE	
DORËZIM	1.0	SHKALLA	
		Nr. I FLETËS	001

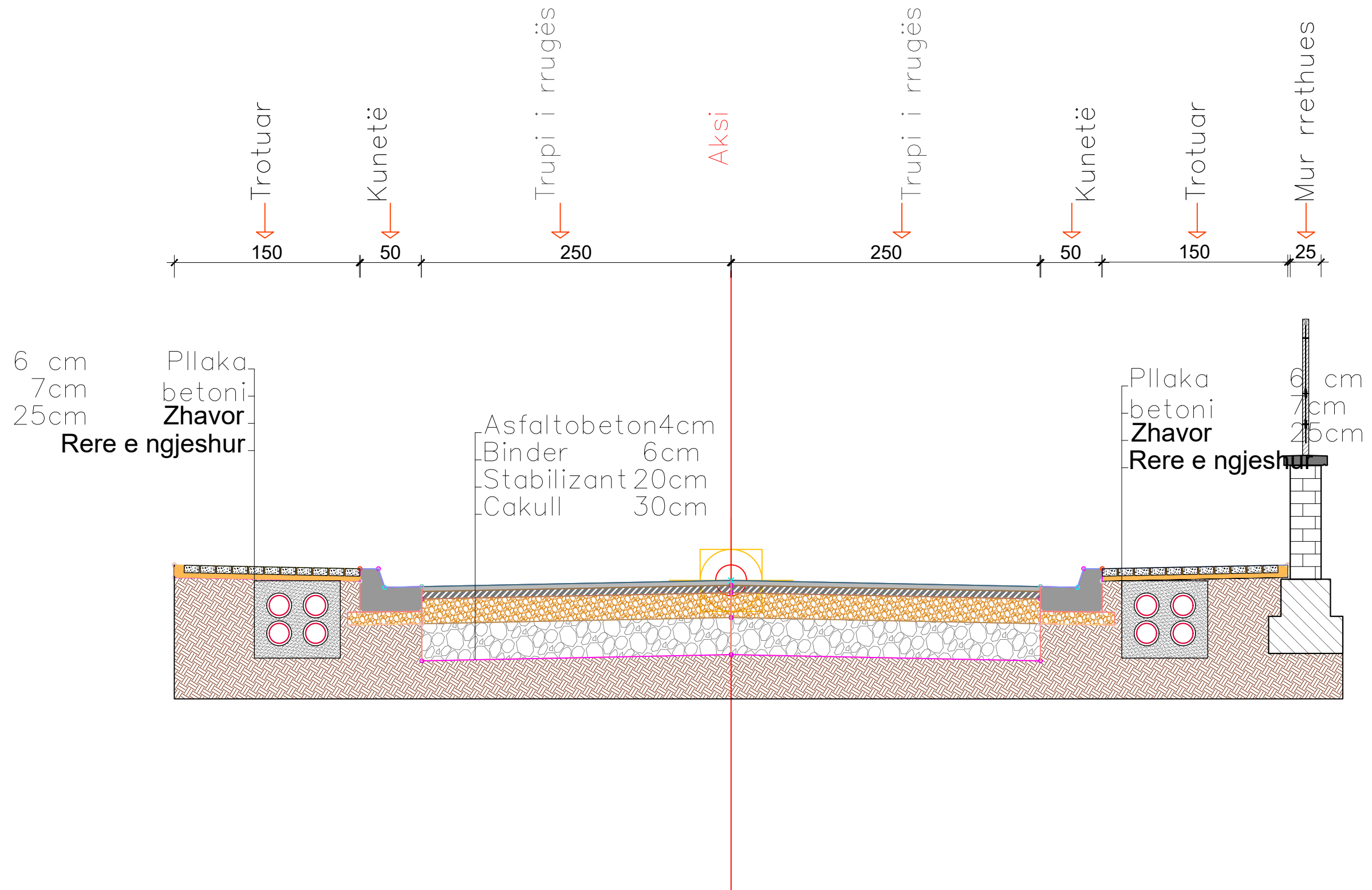
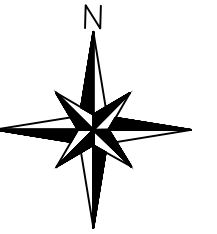

REPUBLIKA E SHQIPËRISË
BASHKIA E TIRANËS

OBJEKTI: NDERTIMI I RRUGEVE "BEDRI
KARAPICI", "HAMNDI PEPO" DHE
"BERNARDIN PALJA".

Projektoi :

Ing.A.JAKOVA
Ing.G.ISLAMI
Ing.S.MYRSELI
Ing.P.SHKURTI

Ark.M.DADO
Ing.Gjeol.Xh.KASMI
Ing.Mjedis.E.CALI
Top.A.BECECI

Projektoi :

"S&L STUDIO SH.P.K"

Projektim-kupervizion-cosnulence



FAZA

DORËZIM

PROJEKT ZBATIMI

1.0

PROFILE TIP DHE DETAJE

SHKALLA

Nr. I FLETËS 001

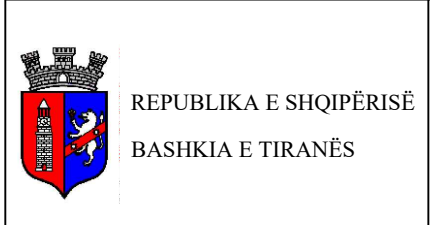
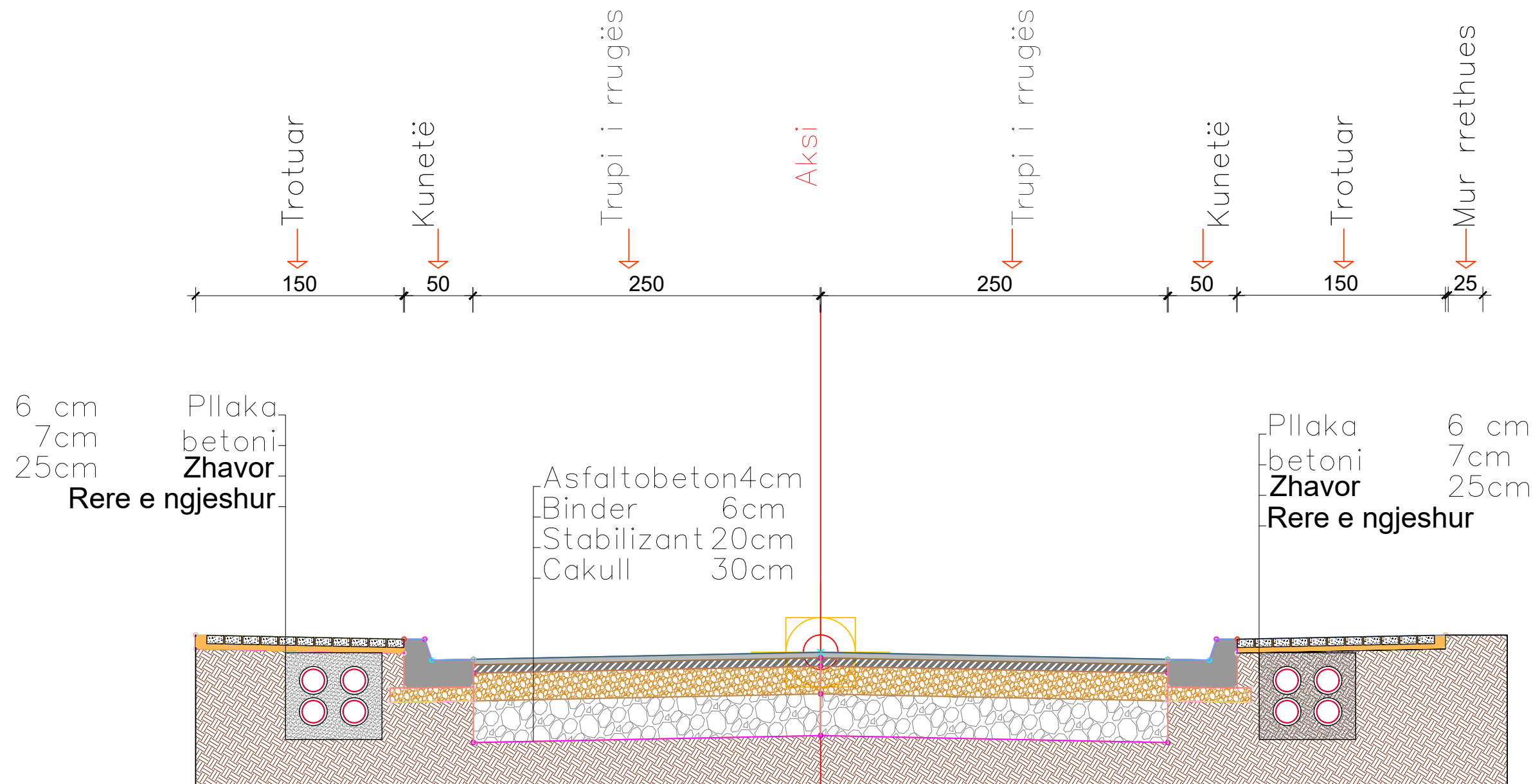
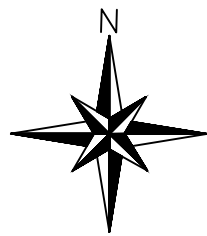

OBJEKTI: NDERTIMI I RRUGEVE "BEDRI KARAPICI", "HAMNDI PEPO" DHE "BERNARDIN PALJA".

Projektoi :
 Ing.A.JAKOVA
 Ing.G.ISLAMI
 Ing.S.MYRSELI
 Ing.P.SHKURTI
 Ark.M.DADO
 Ing.Gjeol.Xh.KASMI
 Ing.Mjedis.E.CALI
 Top.A.BECECI

Projektoi :
"S&L STUDIO SH.P.K"
 Projektim-kupervizion-cosnulence

 PROJEKTIM DESIGN
 SUPERVISION KOLAUDIM

FAZA
DORËZIM

PROJEKT ZBATIMI
1.0

PROFILE TIP DHE DETAJE
 SHKALLA
 Nr. I FLETËS 001

SHENJAT NDALUESE

Sinjalet E Drejtimit

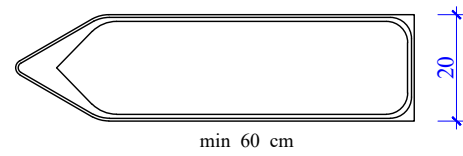

SINJALET E RREZIKUT

Kthese Vendkalim kembesoresh



SINJALET E PERPARESISE

Kryqezim me te drejte perparesie

PERMASAT E SHENJAVE RRUGORE

PERMASAT E SHENJAVE RRUGORE

Shenje kuadratike

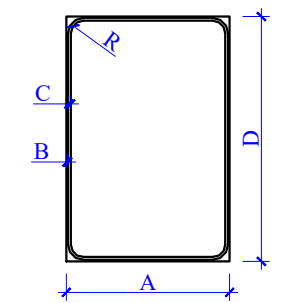

A	B	C	D	R
65	0.4	0.8	95	3

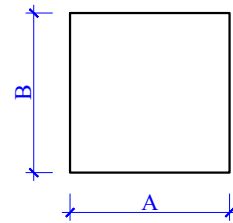

A	B
60	60

Modular i shenjave trekendore

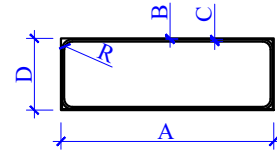

A	B	C	D	R
80	0.4	0.8	27	3

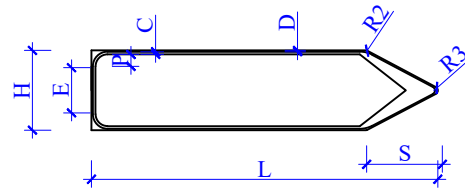

C	D	E	H	L
1	0.5	15	20	60
N	R1	R2	R3	P
12	6	10	1.5	2.5

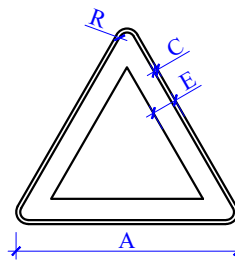

A	C	E	R
60	1.5	8	4.5

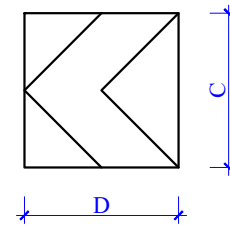

C	D
60	60

Dim vogel

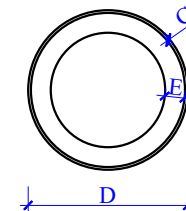

C	D	E
1	60	7.5

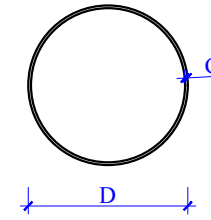

C	D
1	60
Dim vogel	0.8
	40

Dim vogel

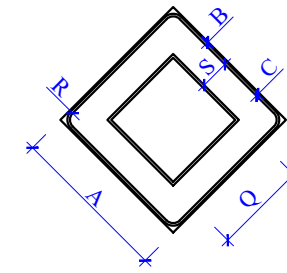

A	B	C	Q	R	S
60	0.5	1	40	3.5	1.1

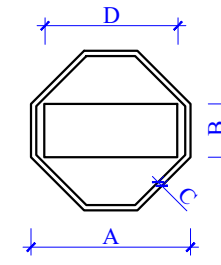

A	B	C	D
90	30	3	75
Dim vogel	60	20	2
			50

Dim vogel

MENYRA E VENDOSJES SE TABELAVE RRUGORE

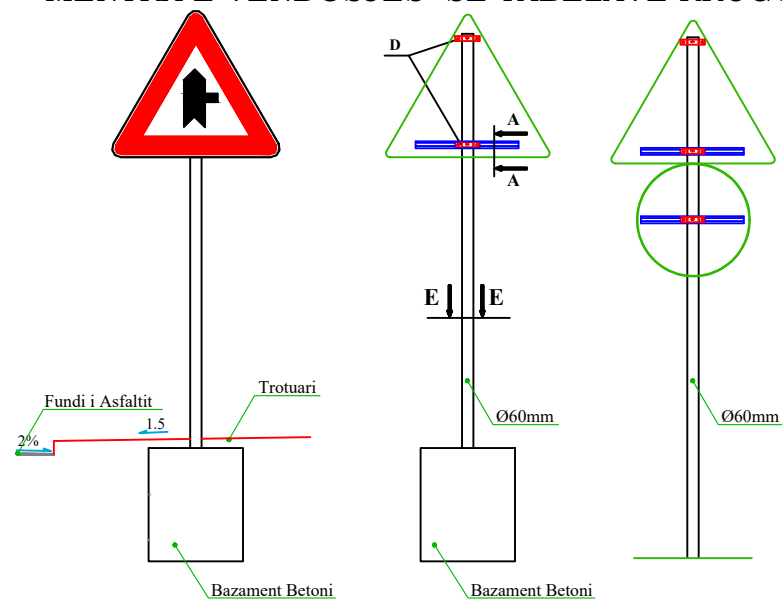

DIMENSIONET E SHIGJETAVE TE DREJTIMIT TE LEVIZJES

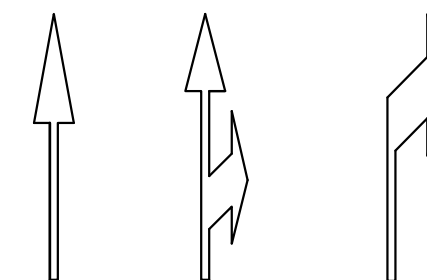
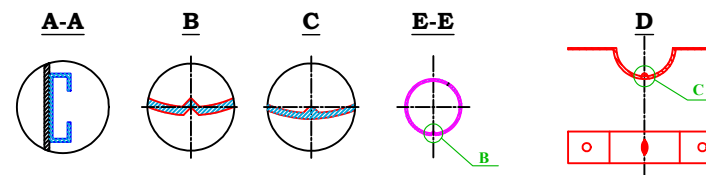

REPUBLIKA E SHQIPËRISË
BASHKIA E TIRANËS

OBJEKTI: NDERTIMI I RRUGEVE "BEDRI KARAPICI", "HAMNDI PEPO"DHE "BERNARDIN PALJA".

Projektoi :

Ing.A.JAKOVA
Ing.G.ISLAMI
Ing.S.MYRSELI
Ing.P.SHKURTI

Ark.M.DADO
Ing.Gjeol.Xh.KASMI
Ing.Mjedis.E.CALI
Top.A.BECECI

Projektoi :

"S&L STUDIO SH.P.K"

Projektim-kupervizion-cosnulence



FAZA

DORËZIM

PROJEKT ZBATIMI

1.0

DETAJE SINJALISTIKE

SHKALLA

Nr. I FLETËS 001

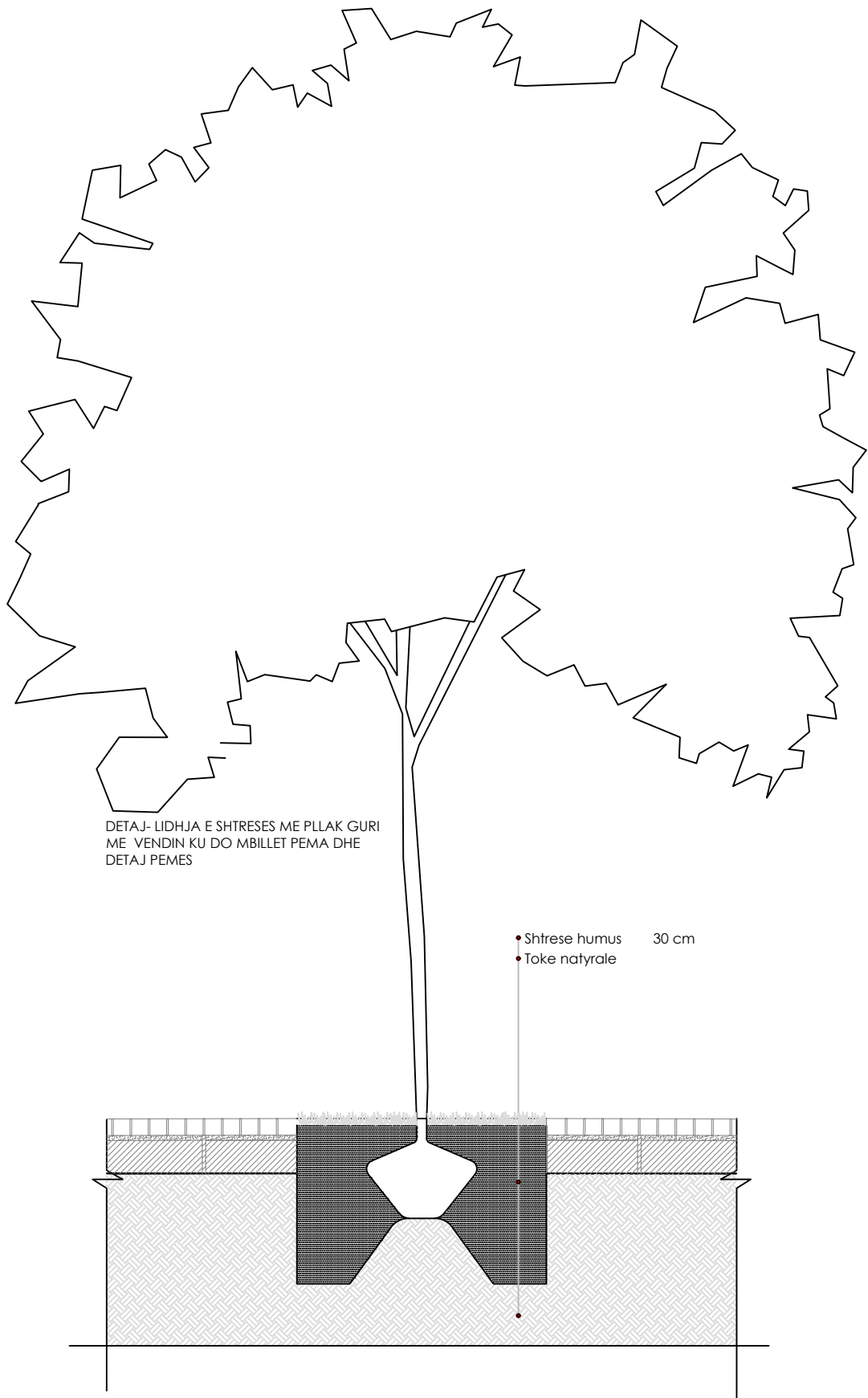
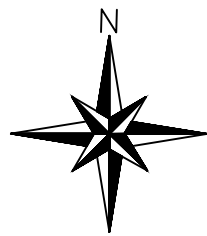

DETAJ- LIDHJA E SHITRESËS ME PLLAK GURI
ME VENDIN KU DO MBILLET PEMA DHE
DETAJ PEMËS

- Shtrese humus 30 cm
- Toke natyrale

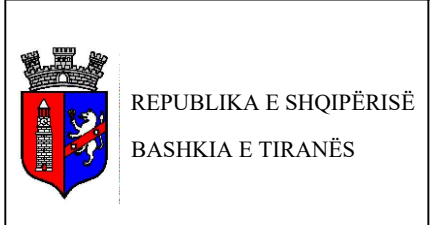

OBJEKTI: NDERTIMI I RRUGEVE "BEDRI
KARAPICI", "HAMNDI PEPO" DHE
"BERNARDIN PALJA".

Projekttoi :
Ing.A.JAKOVA
Ing.G.ISLAMI
Ing.S.MYRSELI
Ing.P.SHKURTI
Ark.M.DADO
Ing.Gjeol.Xh.KASMI
Ing.Mjedis.E.CALI
Top.A.BECECI



Projekttoi :
"S&L STUDIO SH.P.K"
Projektim-kupervizion-cosnulence
R A L D - G
PROJEKTIM DESIGN
SUPERVISION KOLAUDIM

FAZA
DORËZIM

PROJEKT ZBATIMI
1.0

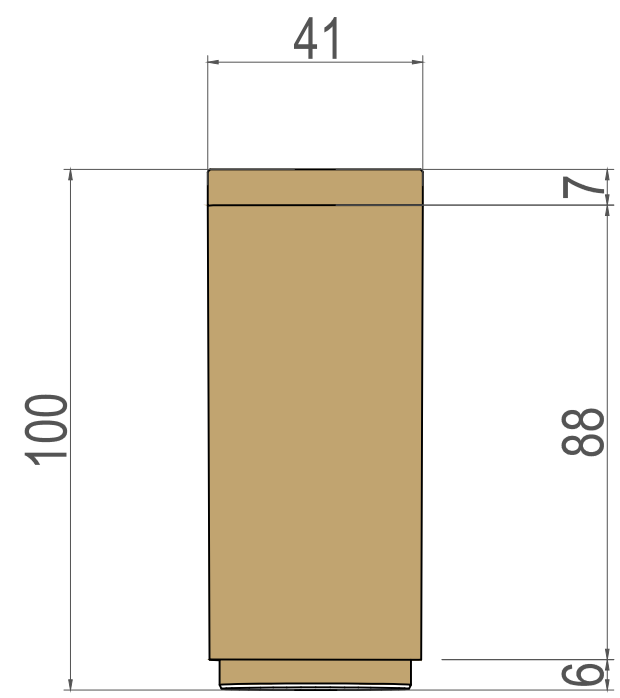
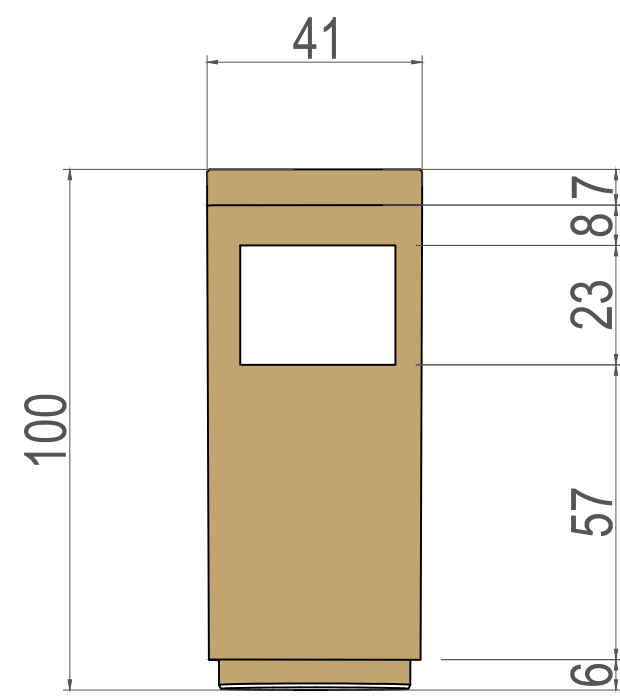
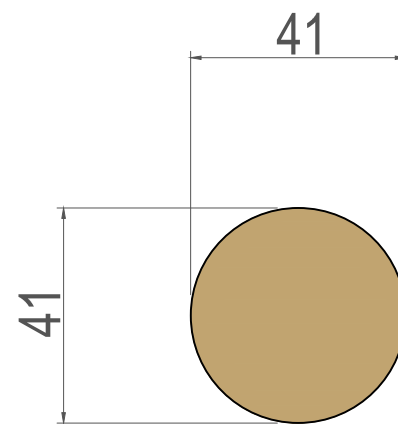
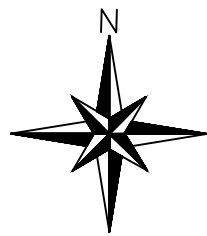
DETAJE GJELBERIMI
SHKALLA
Nr. I FLETËS 001



 REPUBLIKA E SHQIPËRISË BASHKIA E TIRANËS	OBJEKTI: NDERTIMI I RRUGEVE "BEDRI KARAPICI", "HAMNDI PEPO"DHE "BERNARDIN PALJA".	Projektoi : Ing.A.JAKOVA Ing.G.ISLAMI Ing.S.MYRSELI Ing.P.SHKURTI		Ark.M.DADO Ing.Gjeol.Xh.KASMI Ing.Mjedis.E.CALI Top.A.BECECI		Projektoi : "S&L STUDIO SH.P.K" Projektim-kupervizion-cosnulence	FAZA	PROJEKT ZBATIMI	PROFILE TIP DHE DETAJE	
		 PROJEKTIM DESIGN SUPERVISION KOLAUDIM		DORËZIM	1.0	SHKALLA				
				Nr. I FLETËS	001					