

MIRATOHET

KRYETARI I BASHKIS

REXHE BYBERI



## PROJEKT ZBATIMI

OBJEKTI: URA KEMBESORE

URE Hd = 4m PAC Nj. Ad. BYTYÇ  
URE Hd = 5m PAC Nj. Ad. BYTYÇ  
URE Hd = 6m PAC Nj. Ad. BYTYÇ  
URE Hd = 6m DEGE -1- Nj. Ad. FIERZE  
URE Hd = 6m DEGE -2- Nj. Ad. FIERZE  
URE Hd = 6m PALÇ -1- Nj. Ad. LEKBIBAJ  
URE Hd = 6m PALÇ -2- Nj. Ad. LEKBIBAJ

DHJETOR 2022

URE KËMBËSORE HD = 4M  
 PLANIMETRIA SH-1:50

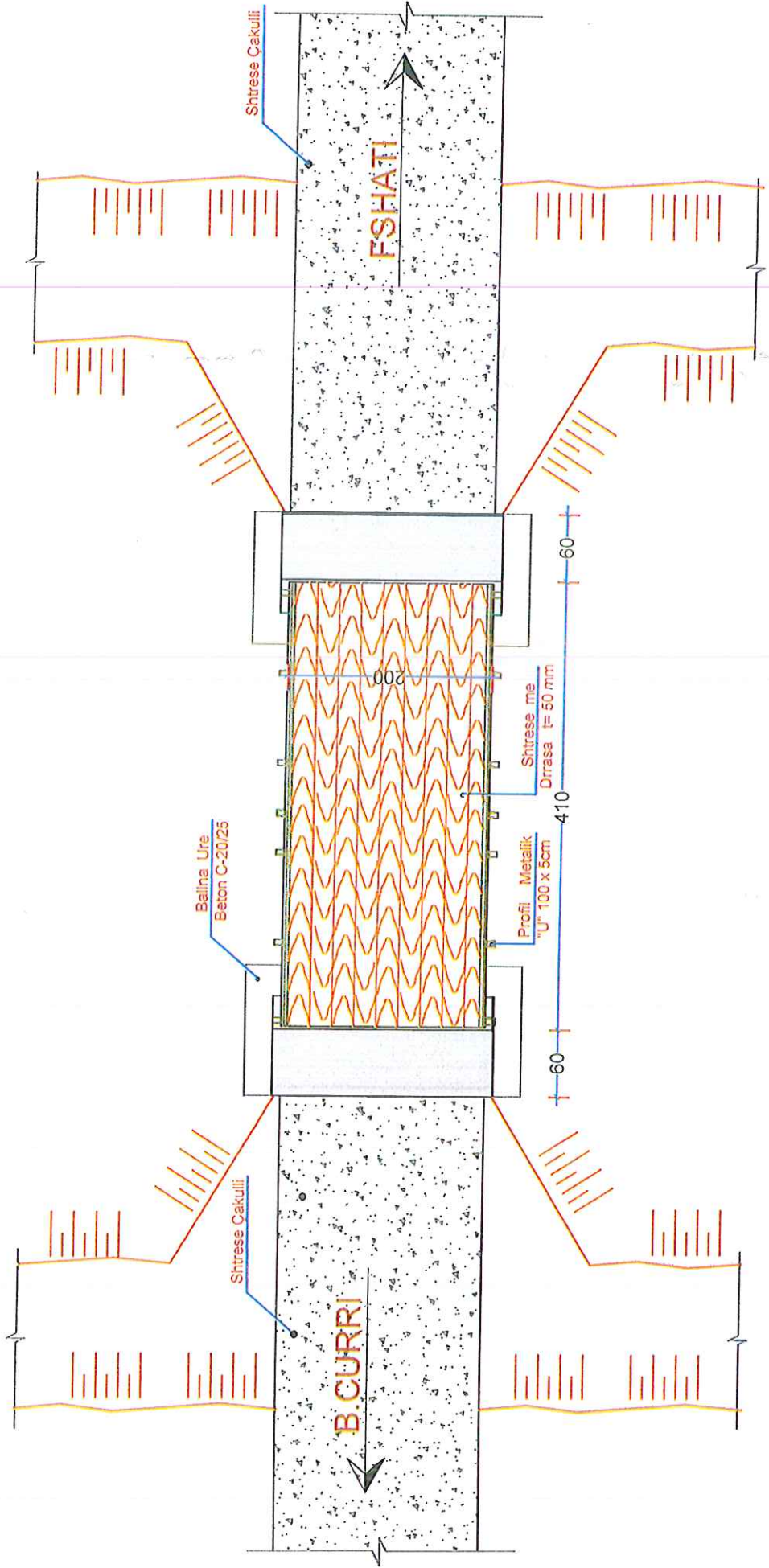

 <b>ZYRA E URBANISTIKES</b> <small>Adresat: bashk. "Naim Frashëri" Bll.Çum                  Nr.133/133/133                  Email: bashkia@bashkia.com</small>		<b>OBJEKTI: URE KEMBESORE</b>	
<b>PIROPSITES:</b> <b>BASHKIA TROPOJE</b>		<b>EMERTIMI I FLETES:</b> <b>PLANIMETRIA</b>	
AUTORE TE PROJEKTTI:		IRIQ. EGZON MUHAMETAJ	
Top. MUHAMET KUÇANA		FLETA NR:	
DATE		1. 100	
2022		2022	

URE KËMBËSORE HD = 4M  
 PRERJA (PAMJA) GJATËSORE SH-1:50

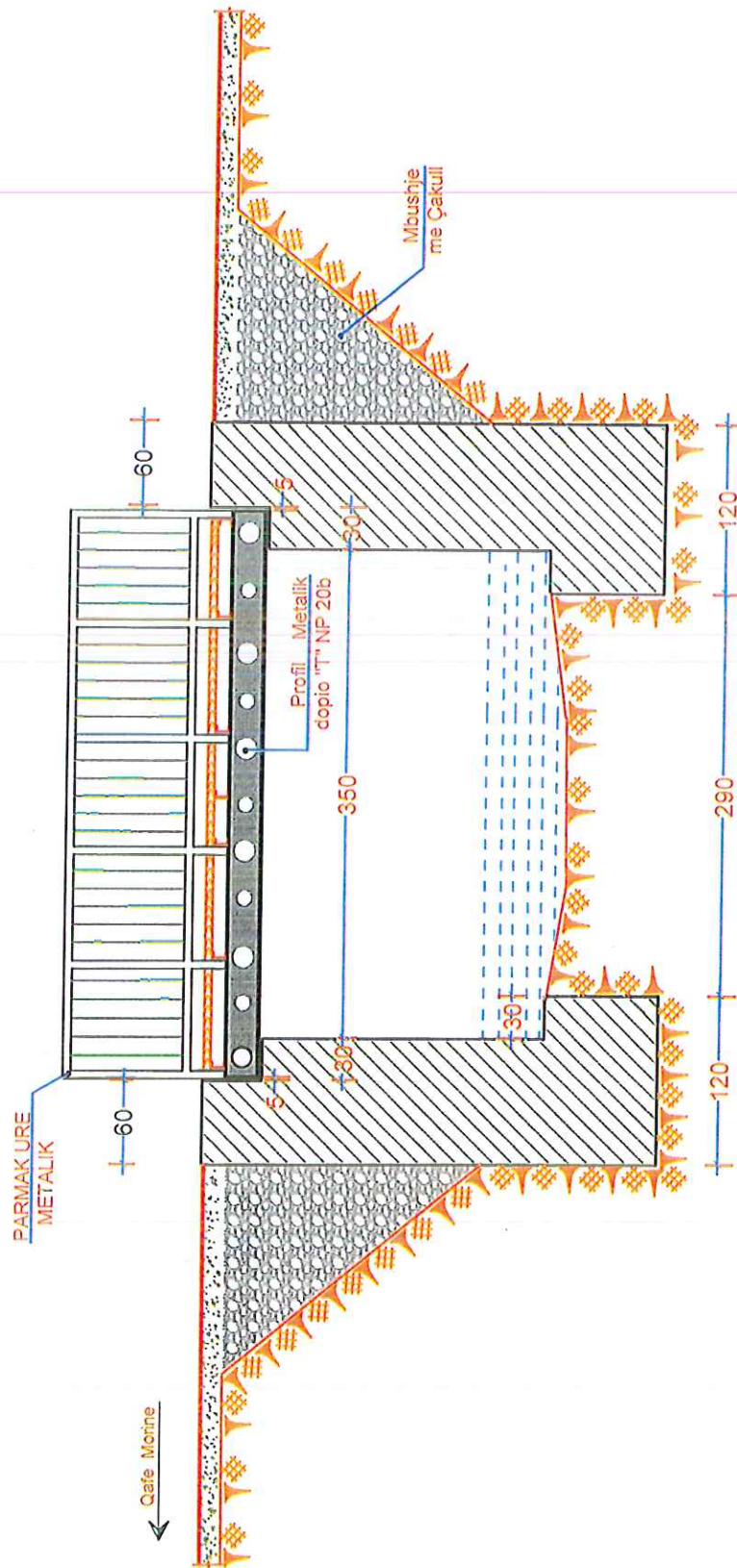

<b>ZYRA E URBANISTIKES</b> Adresa: Sheshi "Uem Ismail" 01, Gëm tel. +3552122270 Email: bashkatropeje@zera.al		<b>OBJEKTI : URE KEMBESORE</b>	
<b>AUTORE TE PROJEKTIT :</b> Ing. EGZON MUHAMETAJ		<b>EMERTIMI I FLETES :</b> PRERJA GJATESORE	
Top. MUHAMET KUCANA		FLETANR: SHKALLA	DATE 1 : 100 2022
<b>POROSITES :</b> BASHKIA TROPOJE			

URE KËMBËSORE HD = 5M  
 PLANIMETRIA SH-1:50

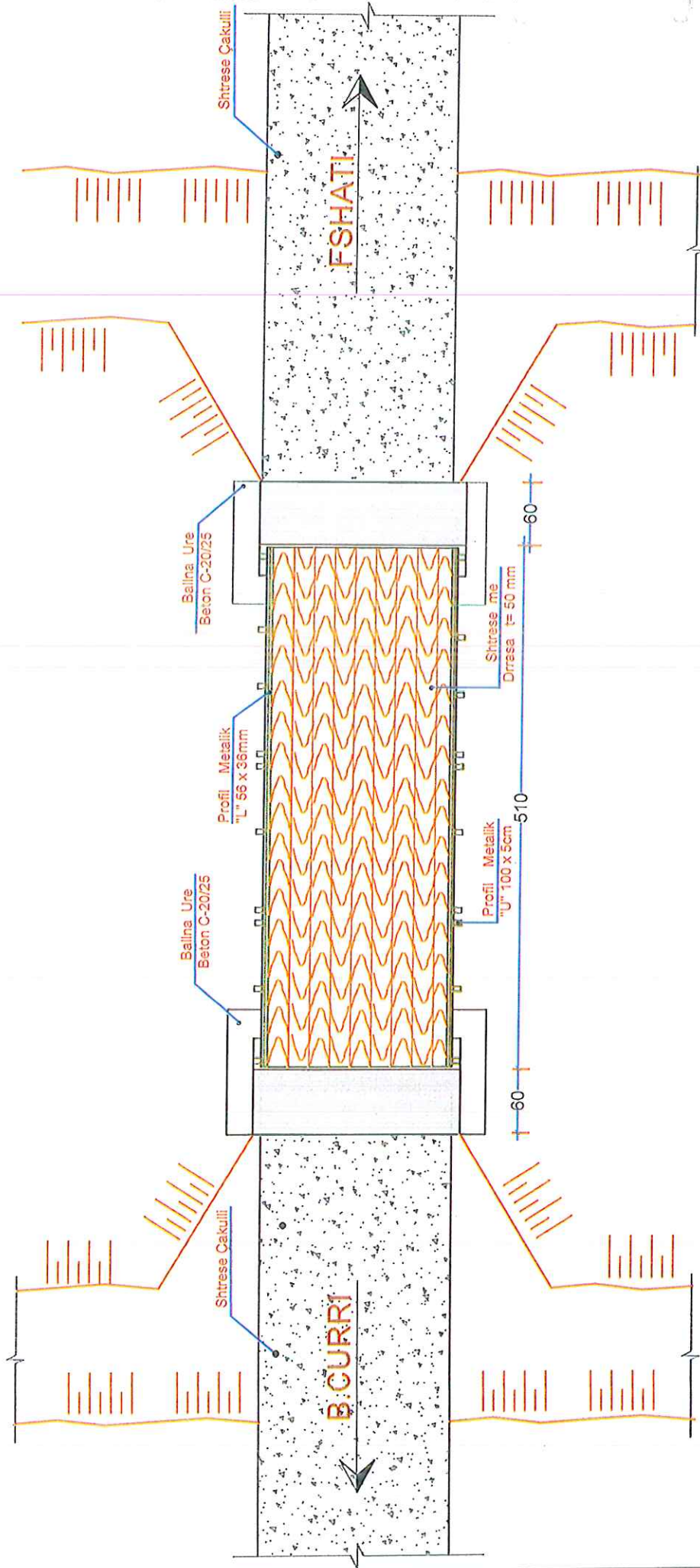

<b>ZYRA E URBANISTIKES</b> <small>Adresa: Sheshi "Lum Haxhiu" 90 Cm                  Nr. 55532277                  Email: bashkia@tpproje.com</small>		<b>OBJEKTI : URE KEMBESORE</b>	
<b>PROJESITËS :</b> BASHKIA TROPOJE		<b>EMERTIMI I FLETES :</b> PLANIMETRIA	
<b>AUTORE TE PROJEKTIT :</b> Ing. EGZON MUHAMETAJ Top. MUHAMET RUCANA		FLETA NR:	SHKALLA:
		1 : 100	DATE:
			2022

URE KËMBËSORE HD = 5M  
 PRERJA (PAMJA) GJATËSORE SH-1:50

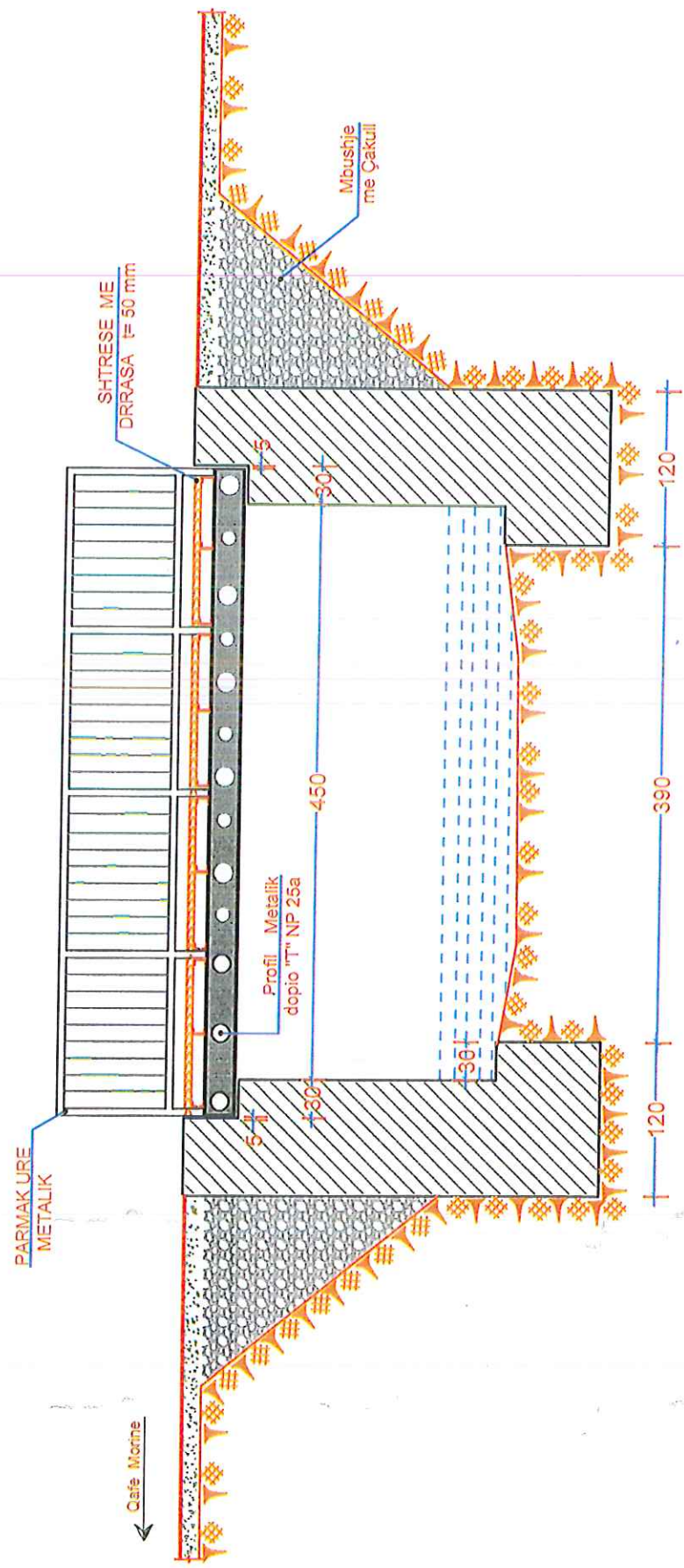

<b>ZYRA E URBANISTIKES</b> Adresa: Sheshi "Uem Iqjan" 8, Cam nr. 5-52122079 Email: <a href="mailto:urbanistik@basha.com">urbanistik@basha.com</a>		<b>OBJEKTI: URE KEMBESORE</b>	
AUTORE TE PROJEKTTIT : Ing. EGZON MUHAMETAJ		EMERTIMI I FLETES : PRERJA GJATESORE	
Top: MUHAMET KUÇANA		FLETA NR: SHKALLA	
POROSITES : BASHKIA TROPOJE		DATE : 2022	
1 : 100		1 : 100	

URE KËMBËSORE HD = 6M  
 PLANIMETRIA SH-1:50

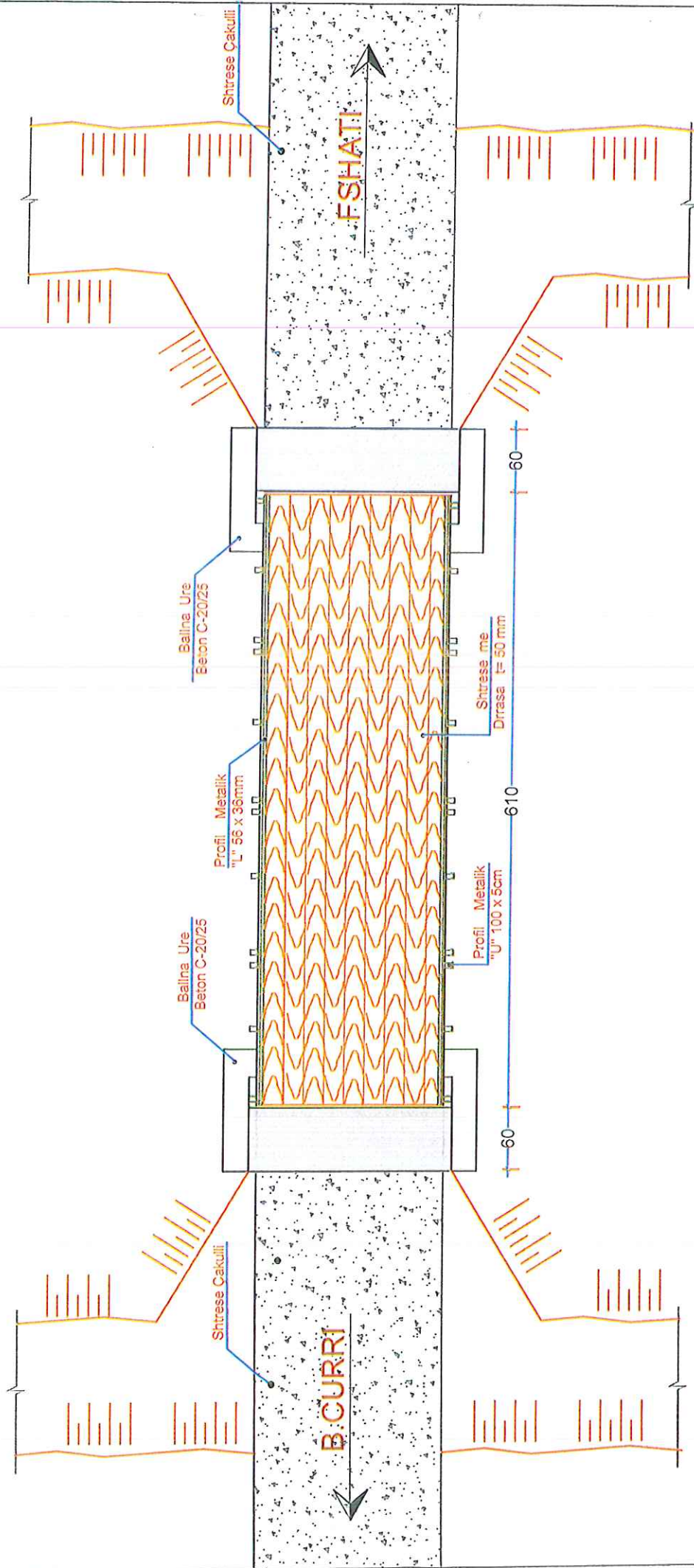

<b>ZYRA E URBANISTIKES</b> <small>Adresa: Sheshi "Naim Fiqajit" 0100                  Tel. +3552122375                  E-mail: zyra@urbanistikeshk.com</small>		<b>OBJEKTI : URE KEMBESORE</b>	
<b>PROJESITËS :</b> <b>BASHKIA TROPOJE</b>		<b>EMERTIMI / FLETES :</b> <b>PLANIMETRIA</b>	
Ing. EGZON MUHAMETAJ		FLETA NR. 1	
Top. MUHAMET KUÇANA		SHKALLA 1 : 100	
		DATE 2022	

URE KËMBËSORE HD = 6M

PRERJA (PAMJA) GJATËSORE SH-1:50

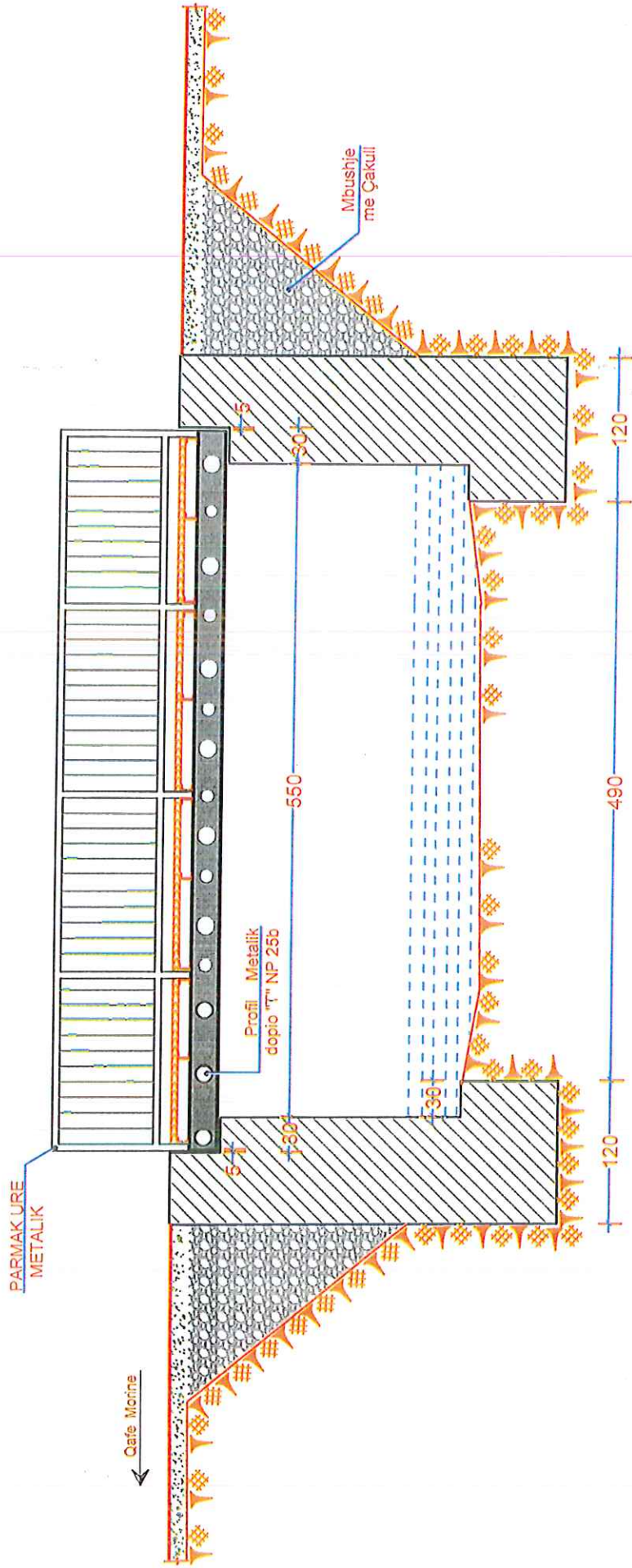

<b>ZYRA E URBANISTIKES</b> Adresat: "Shahin" "Umm Hajar" 11.0km Idr. +3552122277 E-mail: bashkia@bshkija.gov.al	<b>OBJEKTI: URE KEMBESORE</b>	
	EMERTIMI I FLETES: <b>PRERJA GJATESORE</b>	
<b>PROSITËS:</b> <b>BASHKIA TROPOJE</b>	AUTORE TE PROJEKTIT:	SHKALLA
	Ing. EGZON MUHAMETAJ	1 : 100
	Top. MUHAMET KUÇANA	DATE
		2022

URE KËMBËSORE Hd = 4m, Hd = 5m e Hd = 6m  
 PRERJA (PAMJA) BALLORERE SH-1:50

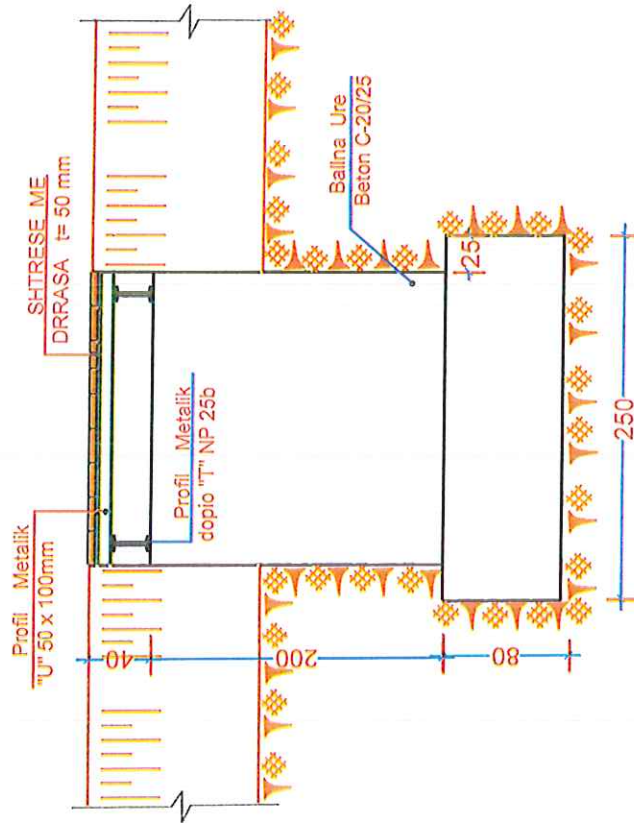
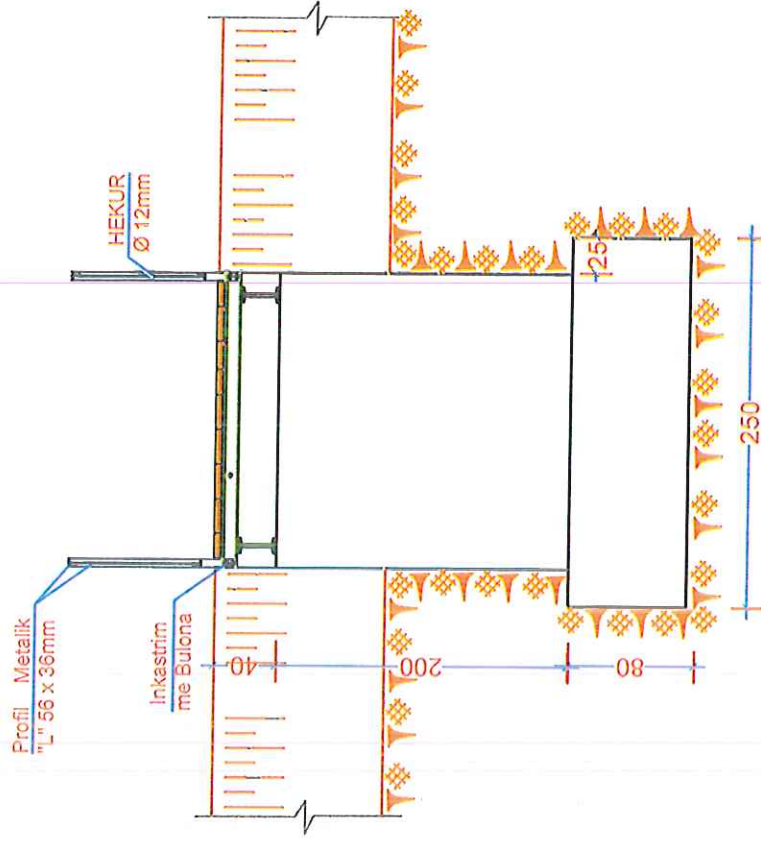

<b>ZYRA E URBANISTIKES</b> Adresat: Sheshi "Uem Isjulen" B.Cem Nr. - 332323279 Email: bashk@urbancem.com		<b>OBJEKTI: URE KEMBESORE</b>	
<b>EMERTIMI I FLETES:</b> PRERJA TERTHORE		AUTORE TE PROJEKTTIT : Ing. EZZON MUHAMETAJ Top. MUHAMET KUÇANA	
POROSITES: <b>BASHKIA TROPOJE</b>		SHKALLA 1 : 100	DATE 2022



## PARMAK URE

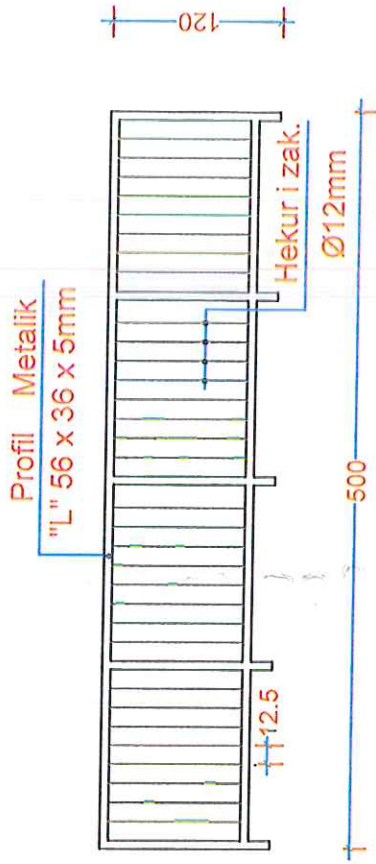

## TABELA E KONSTRUKSIONIT

TIPI I ELEMENTIT	LARTËSIA ne mm	GJERËSIA ne mm	TRASHËSIA ne mm	PESHA kg/ml
Profil doppio "T" NP 20b	200	102	9	31.1
Profil doppio "T" NP 25a	250	116	8	38.1
Profil doppio "T" NP 25b	250	118	10	42.0
Profil "U"	100	48	5.3	10.0
Profil "L"	56	36	5	3.46
Hekur Ø			12	0.9

<b>ZYRA E URBANISTIKES</b> Adresa: Sheshi "Uem Hqdar" 0,0km tel: +3552122273 Email: bashkia@bashkia.gov.al		<b>OBJEKTI: URE KEMBESORE</b>	
<b>PAROSITES:</b> <b>BASHKIA TROPOJE</b>		EMERTIMI I FLETES : <b>PARMAKU I URES</b>	
Ing. EGZON MUHAMETAJ Top. MUHAMET KUÇANA		FLETA NR. : SHKALLA : 1 : 100	
		DATE : 2022	

BASHKIA TROPOJE

MIRATO HET

KRYETARI I BASHKIS

REXHEZ BYBERI



# PROJEKT ZBATIMI

OBJEKTI: URA KEMBESORE

URE Hd = 2 x 5 m GONPEPAJ Nj. Ad. LEKBIBAJ

URE Hd = 2 x 6 m PAC Nj. Ad. BYTYÇ

URE Hd = 2 x 6 m LUZHE Nj. Ad. LLUGAJ

DHJETOR 2022

URE KËMBËSORE Hd = 2 x 5m e Hd = 2 x 6m  
 PRERJA (PAMJA) BALLORERE SH-1:50

PRERJA 1 - 1

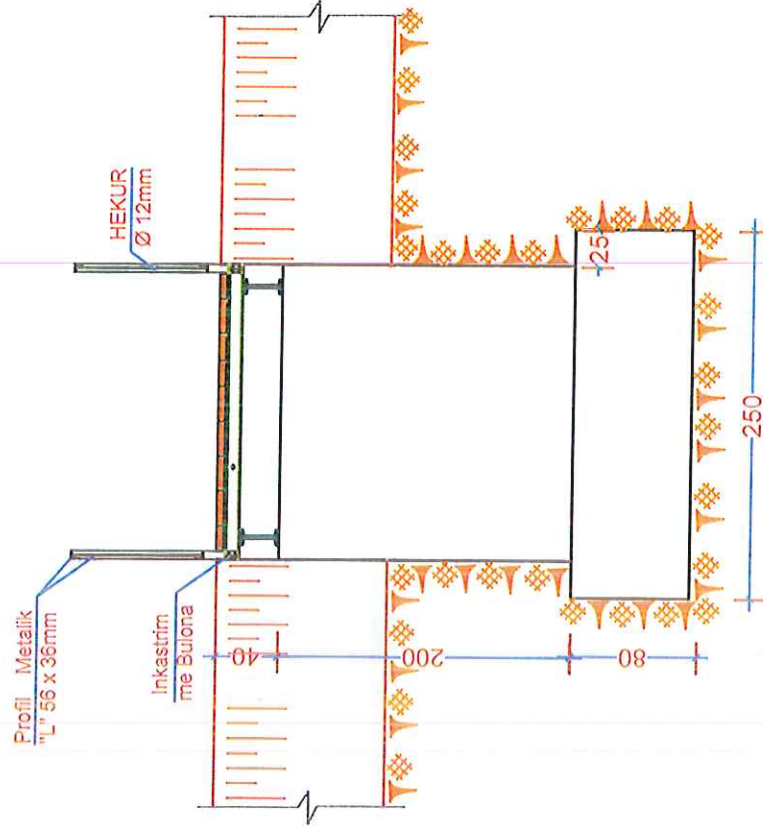

PRERJA 2 - 2

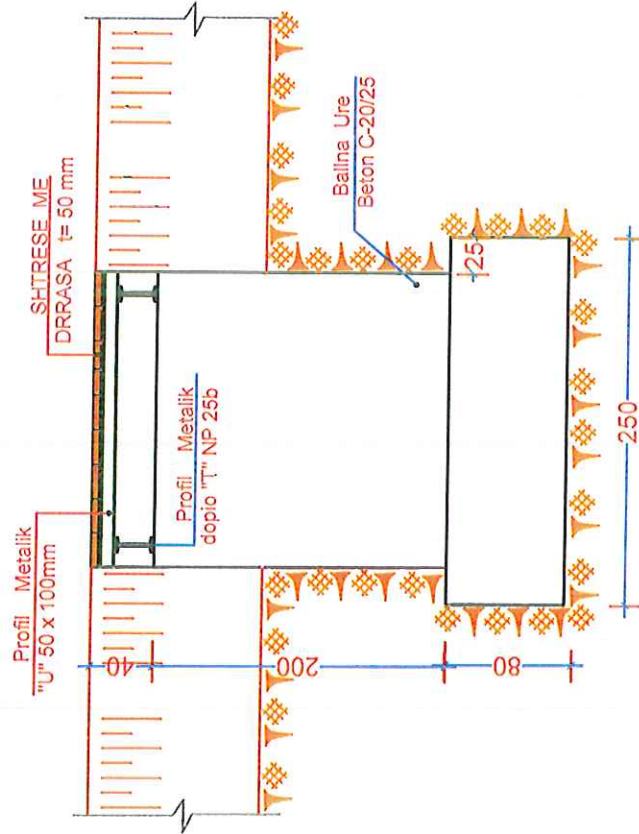

<b>ZYRA E URBANISTIKES</b> Adresat: Sheshi "Jure Bejdar" D.Gm tel. +3552122273 Email: bashk@urbanistikeshk.gov.al		<b>OBJEKTI: URE KEMBESORE</b>	
<b>POROSITES:</b> <b>BASHKIA TROPOJE</b>		EMERTIMI I FLETES: <b>PRERJA TERTHORE</b>	
Ing. EGZON MUHAMETAJ Top. MUHAMET KUCANA		FLETANR.:	SHKALLA: 1 : 100
		DATE:	2022

URE KËMBËSORE Hd = 2 x 5m e Hd = 2 x 6m  
 PLANIMETRI E PRERJE SH-1:50

PLANI

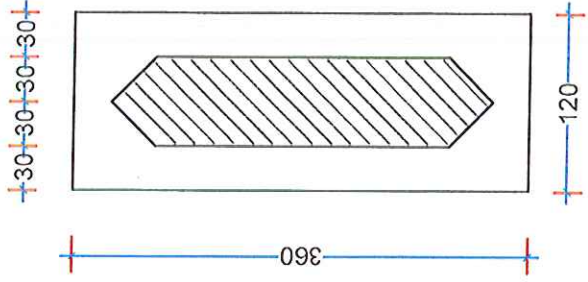

PAMJA BALLORE

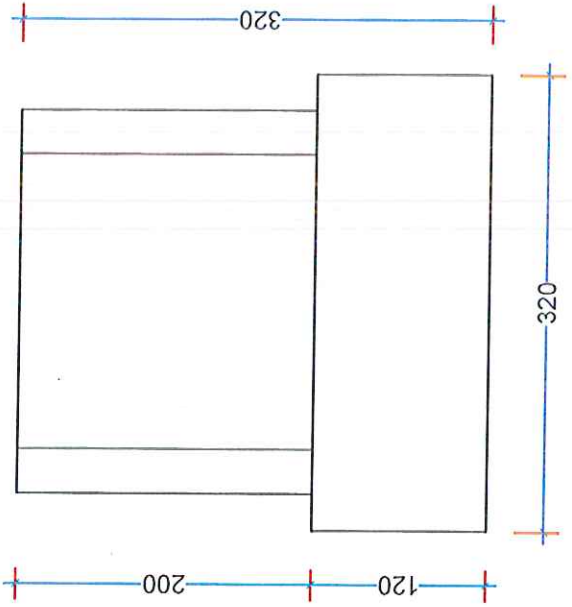

PRERJA 1 - 1

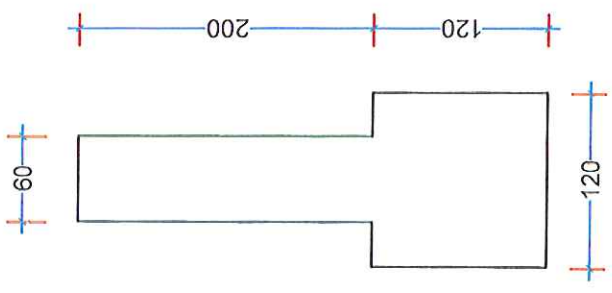

PRERJA 1 - 1

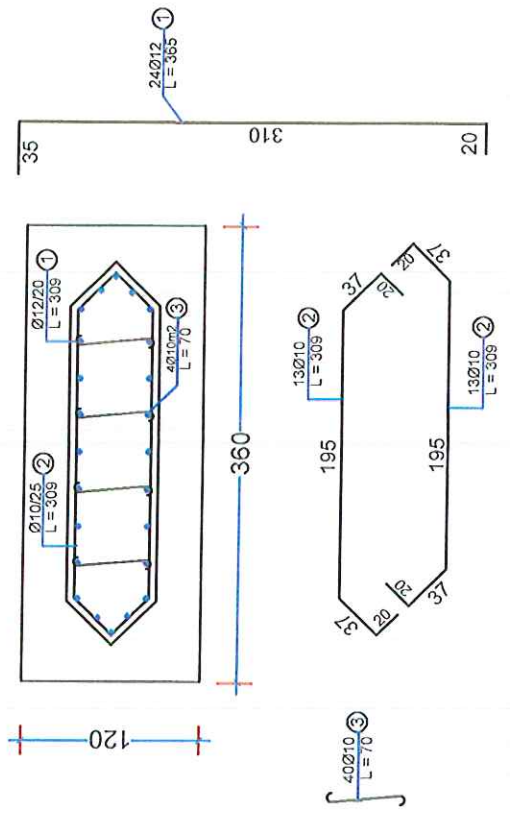

 ZYRA E URBANISTIKES Adresat: Sheshi "Nëmi i Hajrit" B.Dum Nr. 1-055/1222/19 Email: zyra@urbantropoje.com		OBJEKTI : URE KËMBËSORE EMERTIMI I FLETES : PILA E URES	
AUTORE TE PROJEKTTIT : Ing. EGZON MUHAMETAJ Top. MUHAMET KUÇANA		FLETA NR. : SHKALLA : 1 : 100	
POPOSITESI : BASHKIA TROPOJE		DATE : 2022	

URE KËMBËSORE HD = 2 x 6M  
 PRERJA (PAMJA) GJATËSORE SH-1:62.5

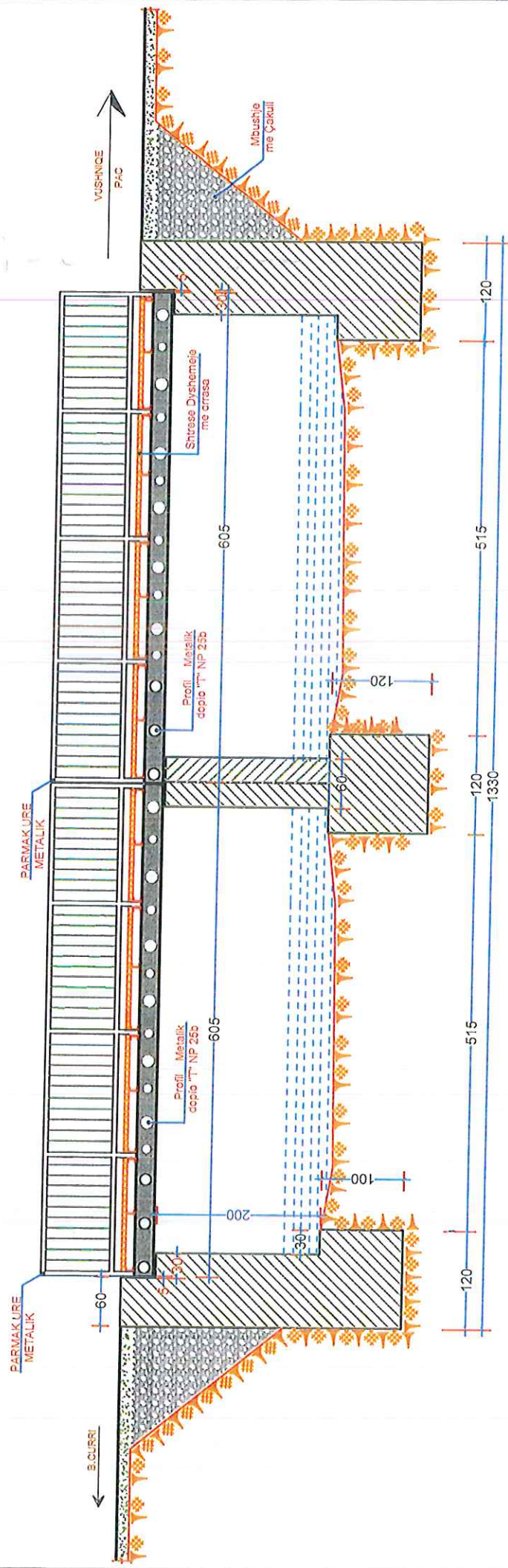

OBJEKTI URE KËMBËSORE	
EMERTIMI I FLETES: PRERJA GJATËSORE	
IPR. EÇSON: MURAHANIETAJ	SHKALLA: DATE
TOP: MUHAMMET RUCIANA	1 : 100 2022
ZYRA E URBANISTIKES (Adresa: Bulevardi "Nënë Tereza" Nr. 10, Tiranë) PËRQISITËS: BASHKIA TROPOLJE	

URE KËMBËSORE HD = 2 X 6M  
 PRERJA (PAMJA) GJATËSORE SH-1:50

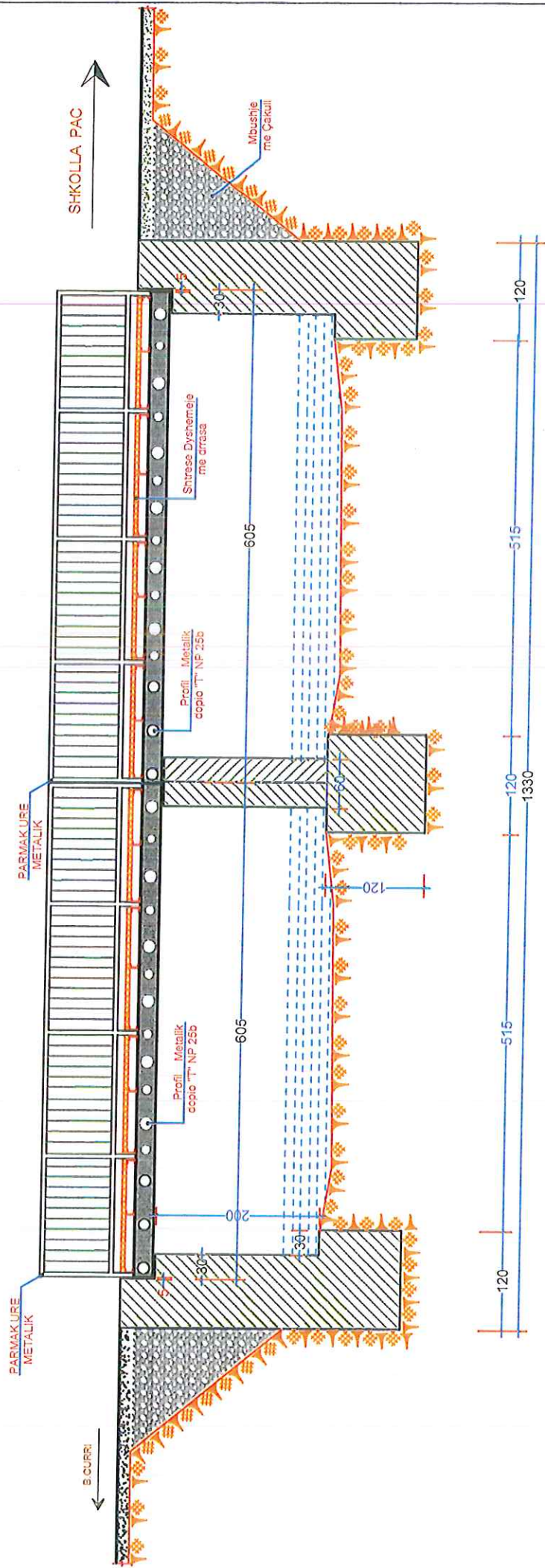

 <b>ZYRA E URBANISTIKES</b> <small>Adresa: Shkup, "Musa Kallia" 5, 000                  Tel: 021 244 22 22                  E-mail: zyk@post.btm.mk</small>		<b>OBJEKTI: URE KËMBËSORE</b>	
AUTORITE E PROJEKTIT:		EMËRTIMI I FLETËS:	
ING. EGZON MUHAMETAJ Top. MUHAMET KUÇANA		<b>PRERJA GJATËSORE</b>	
PROJEKTI:		FLETË NR.:	
<b>BASHKUA TROPJUE</b>		SHKALLA:	
		DATE:	
		1: 100	
		2022	

URE KËMBËSORE TUTAJ (PAC) HD = 2 X 6M  
 PLANIMETRIA SH-1:50

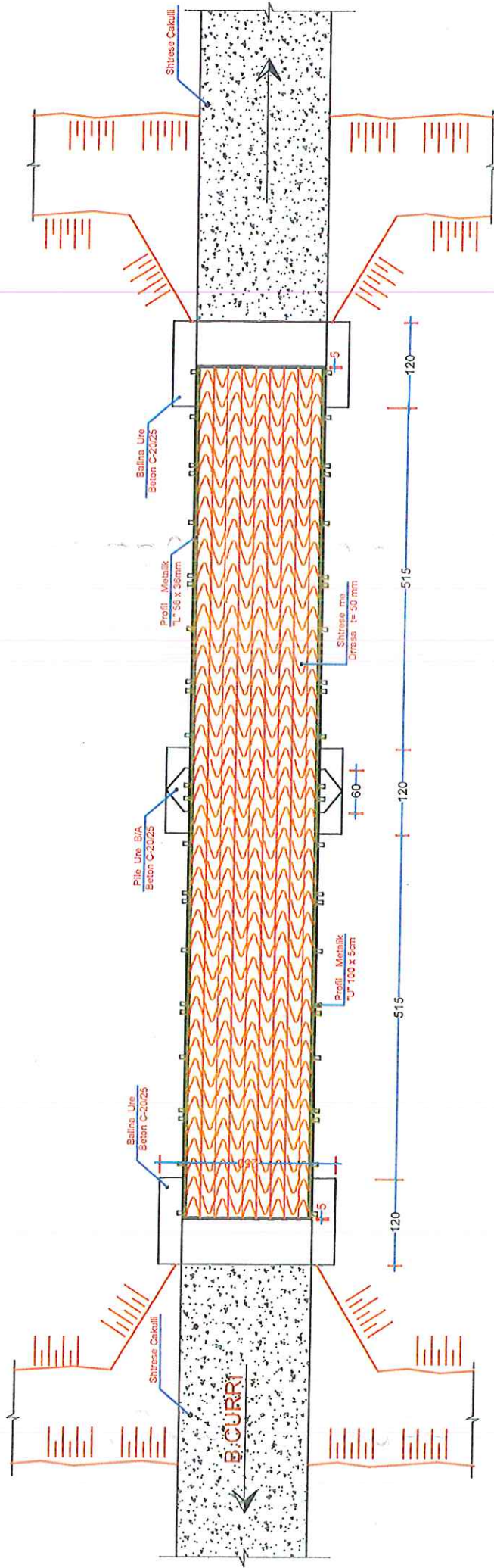

<b>ZYRA E URBANISTIKES</b> Adresa: Shkollë "Naim Frashëri" 11000 Nr. 100/1033333		<b>OBJEKTI: URE KËMBËSORE</b>	
PROJEKTI: <b>BASHKËIA TROPICALE</b>		EMERTIMI I FLETES: <b>PLANIMETRIA</b>	
Autori: DR. ECZON MUHAMETAJ Topi: INJENIERI NGJAJA		FLETA NR. SHALLA DATE 1: 100 2022	

URE KËMBËSORE VUSHNIQE (LUZHE) HD = 2 x 6M  
 PLANIMETRIA SH-1:50

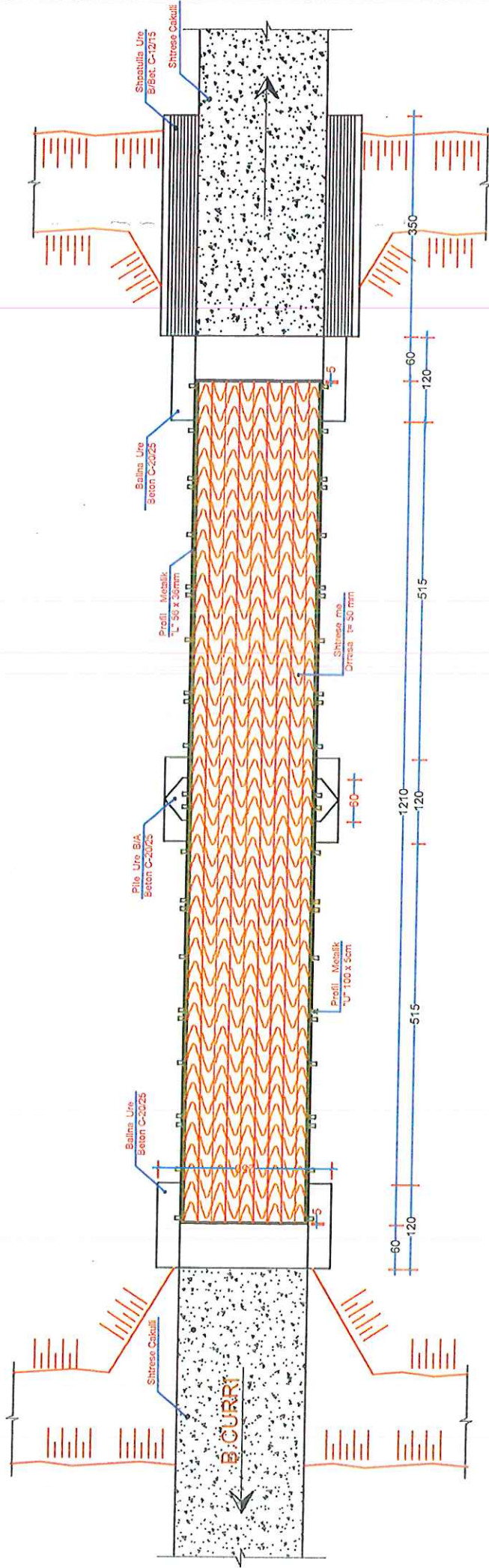

 <p>ZYRA E URBANISTIKES          Adresa: Durrës, Vllaznimit 110m          Tërbënie: 069 440 0000</p>		OBJEKTI : URE KEMBESORE EMERTIMI I FLETES : PLANIMETRIA	
AUTORE TE PROJEKTIT : ING. EGZON MURAHMETAJ		FLETA NR : 1 : 100	
POROSITES : BASHKIA TROPOJE		SHKALLA : DATE : 2022	



URE KËMBËSORE GJONPEPAJ HD = 2 x 5 M  
 PLANIMETRIA SH-1:50

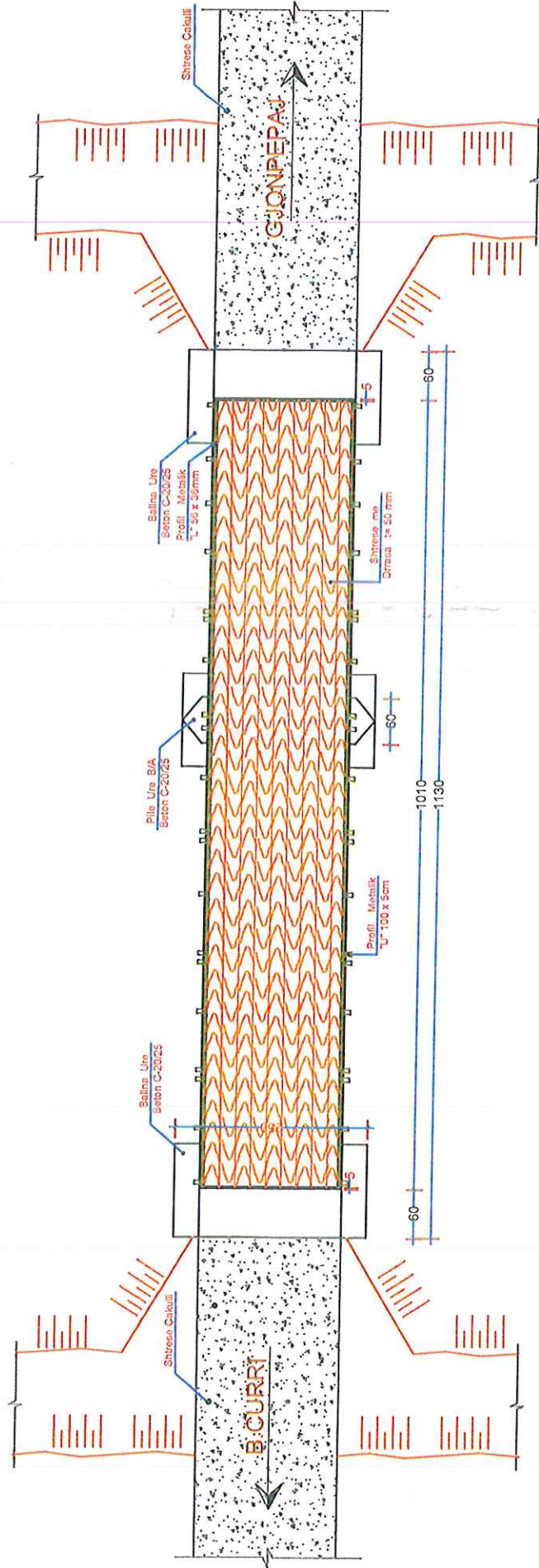

<b>ZYRA E URBANISTIKES</b> <small>Ministria e Punëve Publike dhe Transportit</small> <b>BASHKIA TROPOJE</b>		<b>OBJEKTI : URE KËMBËSORE</b>	
<b>AUTORE TE PROJEKTT :</b> Ing. EGZON MUHAMETAJ Top. MUHAMET KUÇANA		<b>EMERTIMI I FLETES :</b> PLANIMETRIA	
<b>PROJEKTTES :</b> Bashkia Tropoje		<b>SHKALLA :</b> 1 : 100	
DATE :		DATE : 2022	

# URA PASAREL BUJAN PAMJA GJATESORE

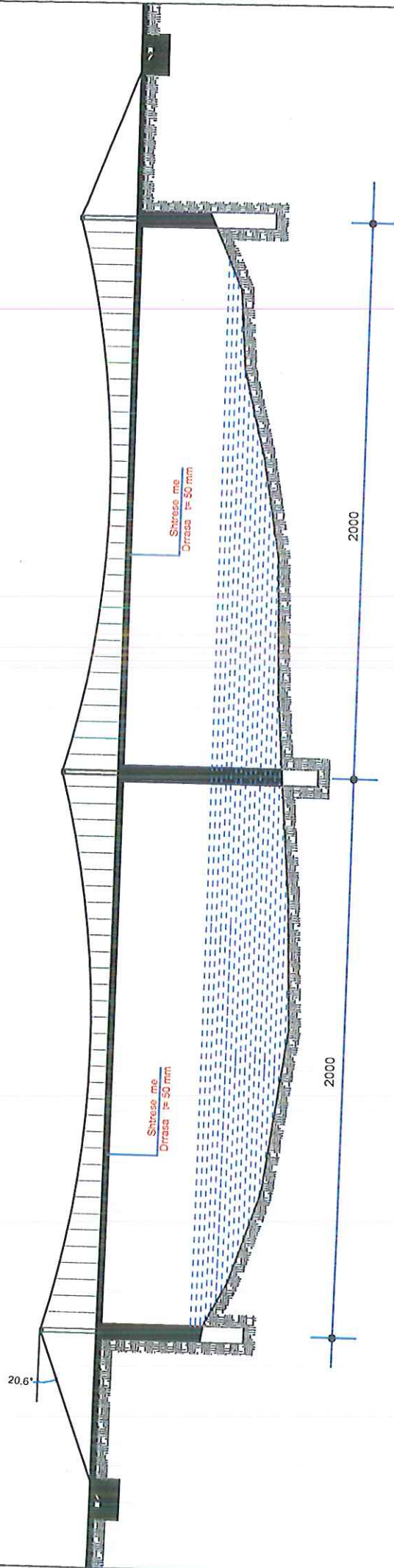

## PRERJA TERTHORE

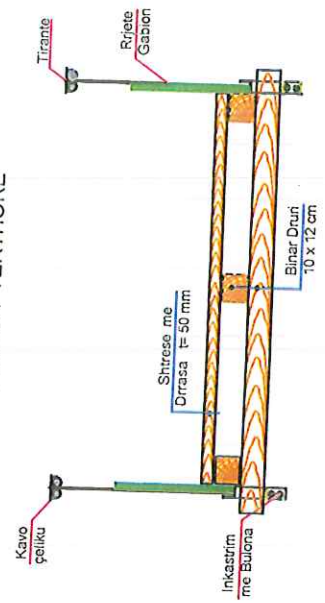

<b>ZYRA E URBANISTIKES</b> Adresa: Basha "Naim Hylaj" D. Curi Nr. 1-3/021/132373 Email: <a href="mailto:zyra@urbanistikeshq.com">zyra@urbanistikeshq.com</a>	<b>OBJEKTI : URE TIP "PASAREL" BUJAN</b>	
	<b>AUTORE TE PROJEKTTI :</b> Ing. EZON MUHAMETAJ Tek. MUSTAF VATORI	
<b>POROSITES :</b> <b>BASHKIA TROPOJE</b>	<b>EMERTIMI I LETES :</b> PAMJE E PRERJE	<b>LETA NR. / SHKALLA</b> 2 / 1:100
		<b>DATE</b> 2023