

PROJEKT ELEKTRIK DHE MNZ

RIKONSTRUKSION I ISH HOTELIT TE ISH UZINES SE FERROKROMIT,
NE QYTETIN E BURRELIT

Klienti : **BASHKIA BURREL**

Projektoi : **DERBI-E sh.p.k.**



"Rruga e Dibres" Pallati Andi Konstruksion
Shk.1, Ap.3, Tirane, Albania
Mob: +355 67 20 57534
E-mail: derbie.studio@gmail.com,

PLANIMETRIA KATI PERDHE -NDRICIMI

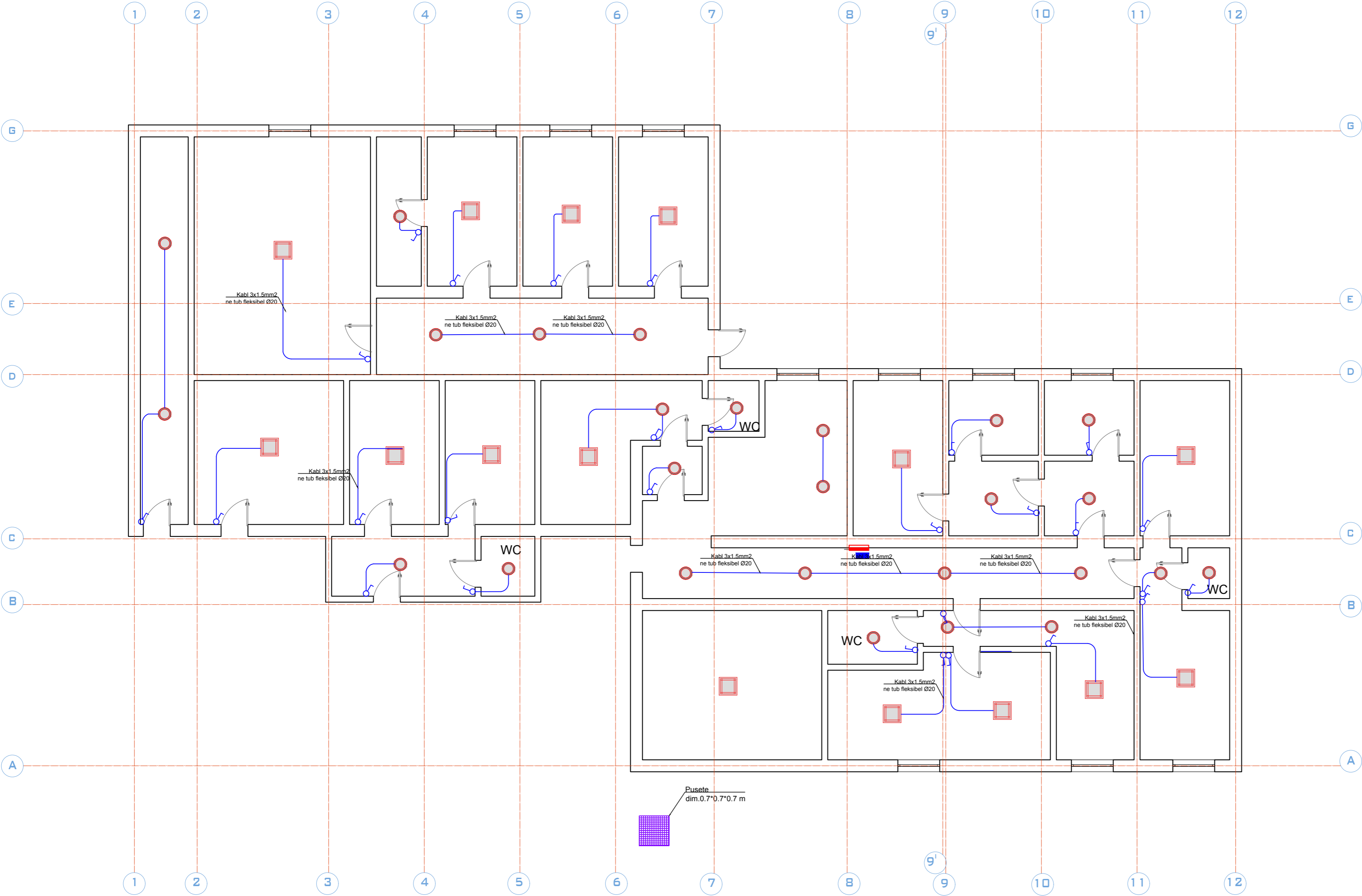

Projekti : RIKONSTRUKSION			
Klienti : BASHKIA BURREL			
DERBI-E sh.p.k. "Rruga e Dibres" Pallati Andi Konstruksion Shk.1, Ap.3, Tirane, Albania Mob: +355 67 20 57534 E-mail: derbie.studio@gmail.com,			
Arkitekti : Olger Qirjaqi (Nr. Lic. A.1017/2)			
Inxhinier Konstruktore : Bexhet Dedja (Nr. Lic. K.1184/3)			
Inxhinier Hidroteknike : Edmond Theodhori (Nr. Lic. K.0783/2)			
Inxhinier Elektrike : Besnik Kaliqi (Nr. Lic. E.0964/2)			
Emertimi i Objektivit : Rikonstruksion i ish hotelit te ish uzines se ferrokromit			
Emertimi i vizatimit : Planimetria e katit perdhe ,NDRICIMI			
Kodi i vizatimit	Shkalla	Formati	A 3
	1 : 100	Fleta	1

PLANIMETRIA KATI PARE-NDRICIMI

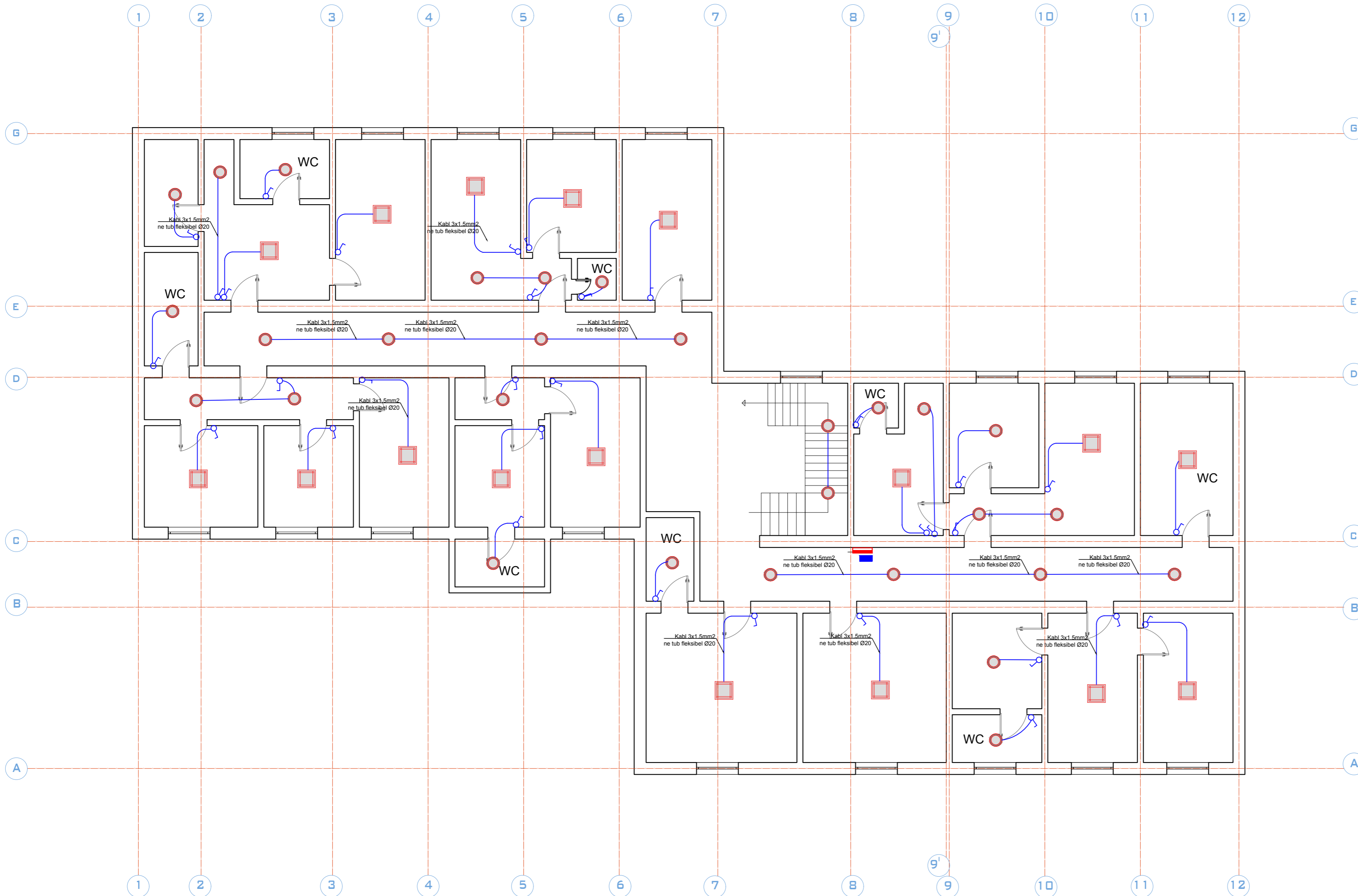

Projekti : RIKONSTRUKSION			
Klienti : BASHKIA BURREL			
DERBI-E sh.p.k. "Rruga e Dibres" Pallati Andi Konstruksion Shk.1, Ap.3, Tirane, Albania Mob: +355 67 20 57534 E-mail: derbie.studio@gmail.com,			
Arkitekt : Olger Qirjaqi (Nr. Lic. A.1017/2)			
Inxhinier Konstruktor : Bexhet Dedja (Nr. Lic. K.1184/3)			
Inxhinier Hidroteknik : Edmond Theodhori (Nr. Lic. K.0783/2)			
Inxhinier Elektrik : Besnik Kaliqi (Nr. Lic. E.0964/2)			
Emertimi i Objektivit : Rikonstruksion i ish hotelit te ish uzines se ferrokromit			
Emertimi i vizatimit : Planimetria e katit pare, NDRICIMI			
Kodi i vizatimit	Shkalla	Formati	A 3
	1 : 100	Fleta	2

PLANIMETRIA KATI DYTE -NDRICIMI

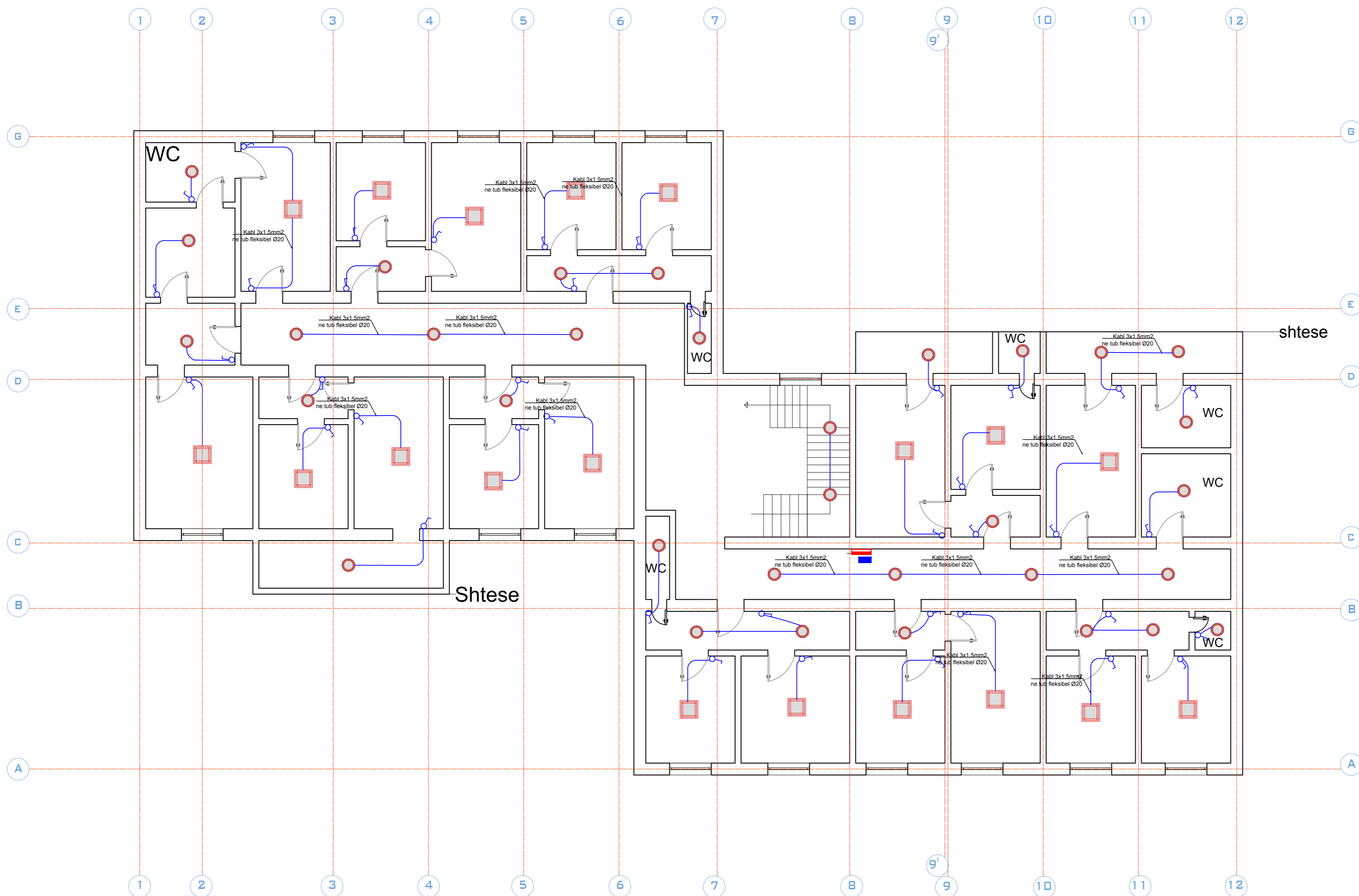

Projekti : RIKONSTRUKSION			
Klienti : BASHKIA BURREL			
DERBI-E sh.p.k. "Rruga e Dibres" Pallati Andi Konstruksion Shk.1, Ap.3, Tirane, Albania Mob: +355 67 20 57534 E-mail: derbie.studio@gmail.com,			
Arkitekt : Olger Qirjaqi (Nr. Lic. A.1017/2)			
Inxhinier Konstruktor : Bexhet Dedja (Nr. Lic. K.1184/3)			
Inxhinier Hidroteknik : Edmond Theodhori (Nr. Lic. K.0783/2)			
Inxhinier Elektrik : Besnik Kaliqi (Nr. Lic. E.0964/2)			
Emertimi i Objektivit : Rikonstruksion i ish hotelit te ish uzines se ferrokromit			
Emertimi i vizatimit : Planimetria e katit dyte, NDRICIMI			
Kodi i vizatimit	Shkalla	Formati	A 3
	1 : 100	Fleta	3

PLANIMETRIA KATI TRETE -NDRICIMI

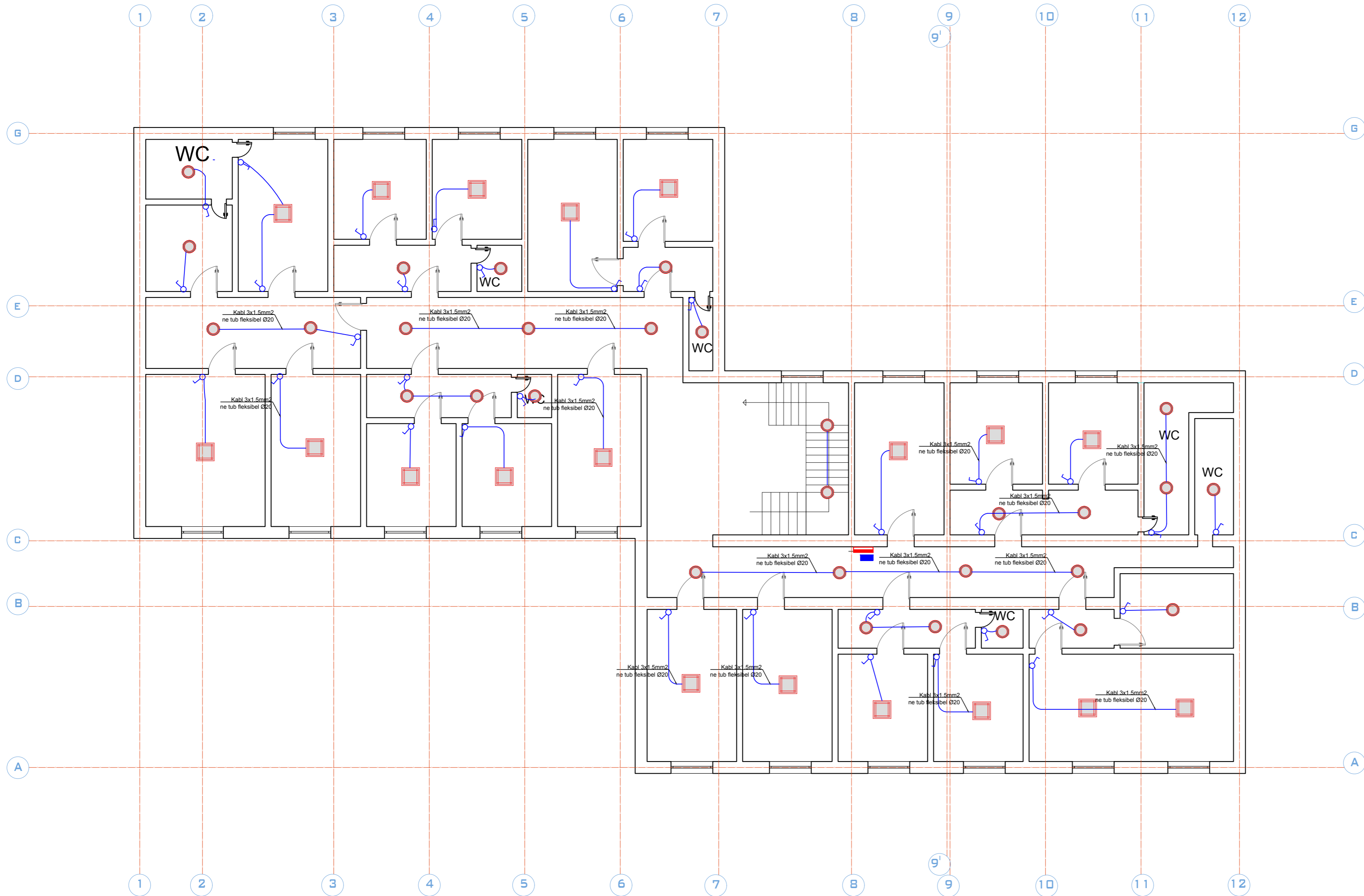

Projekti : RIKONSTRUKSION			
Klienti : BASHKIA BURREL			
DERBI-E sh.p.k. "Rruga e Dibres" Pallati Andi Konstruksion Shk.1, Ap.3, Tirane, Albania Mob: +355 67 20 57534 E-mail: derbie.studio@gmail.com,			
Arkitekt : Olger Qirjaqi (Nr. Lic. A.1017/2)			
Inxhinier Konstrktor : Bexhet Dedja (Nr. Lic. K.1184/3)			
Inxhinier Hidroteknik : Edmond Theodhori (Nr. Lic. K.0783/2)			
Inxhinier Elektrik : Besnik Kaliqi (Nr. Lic. E.0964/2)			
Emertimi i Objektivit : Rikonstruksion i ish hotelit te ish uzines se ferrokromit			
Emertimi i vizatimit : Planimetria e katit trete,NDRICIMI			
Kodi i vizatimit	Shkalla	Formati	A 3
	1 : 100	Fleta	4

PLANIMETRIA KATI KATER -NDRICIMI

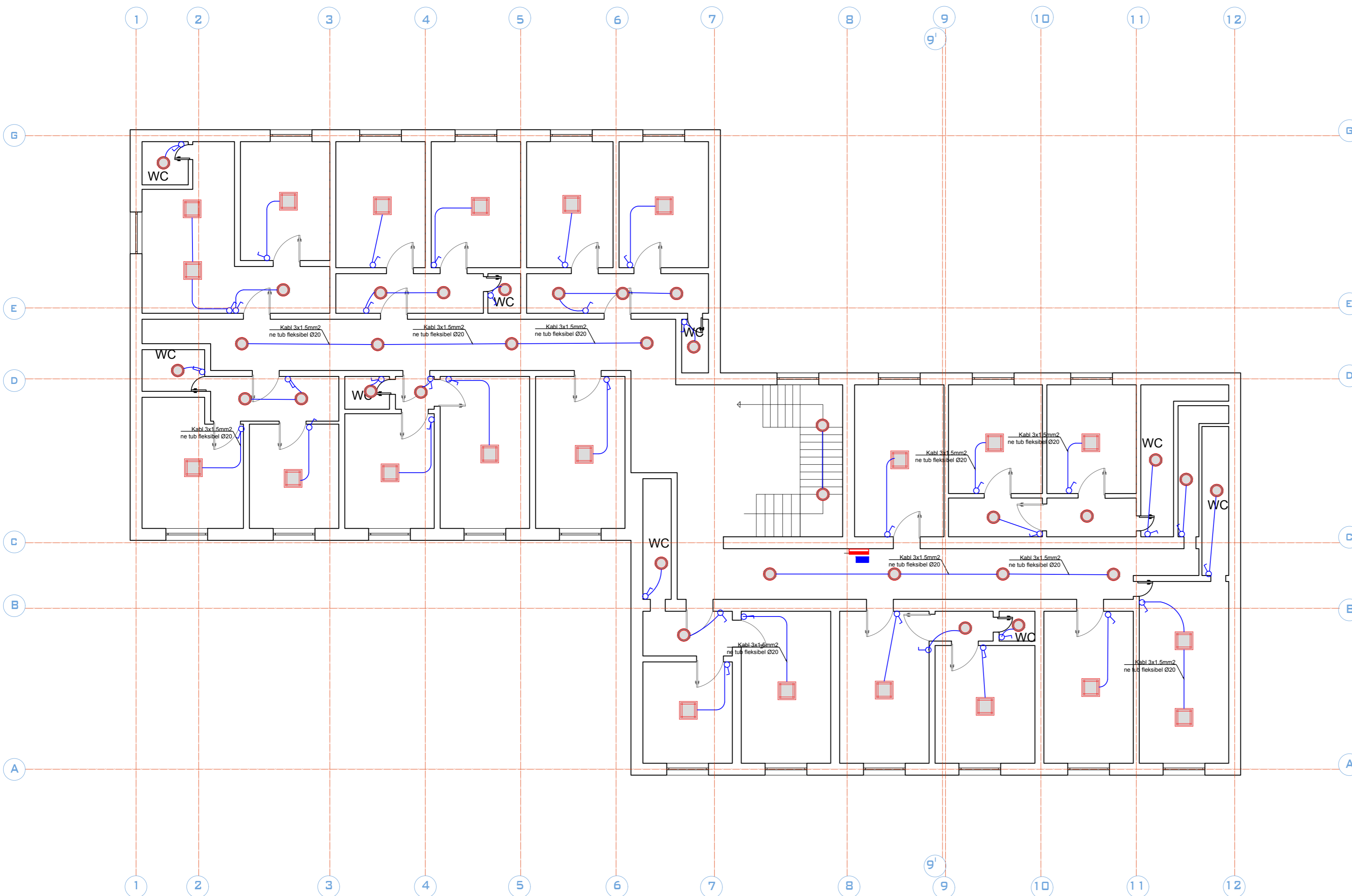

Projekti : RIKONSTRUKSION			
Klienti : BASHKIA BURREL			
DERBI-E sh.p.k. "Rruga e Dibres" Pallati Andi Konstruksion Shk.1, Ap.3, Tirane, Albania Mob: +355 67 20 57534 E-mail: derbie.studio@gmail.com,			
Arkitekti : Olger Qirjaqi (Nr. Lic. A.1017/2)			
Inxhinier Konstruktore : Bexhet Dedja (Nr. Lic. K.1184/3)			
Inxhinier Hidroteknike : Edmond Theodhori (Nr. Lic. K.0783/2)			
Inxhinier Elektrike : Besnik Kaliqi (Nr. Lic. E.0964/2)			
Emertimi i Objektivit : Rikonstruksion i ish hotelit te ish uzines se ferrokromit			
Emertimi i vizatimit : Planimetria e katit kater, NDRICIMI			
Kodi i vizatimit	Shkalla	Formati	A 3
	1 : 100	Fleta	5

PLANIMETRIA KATI PERDHE -MNZ

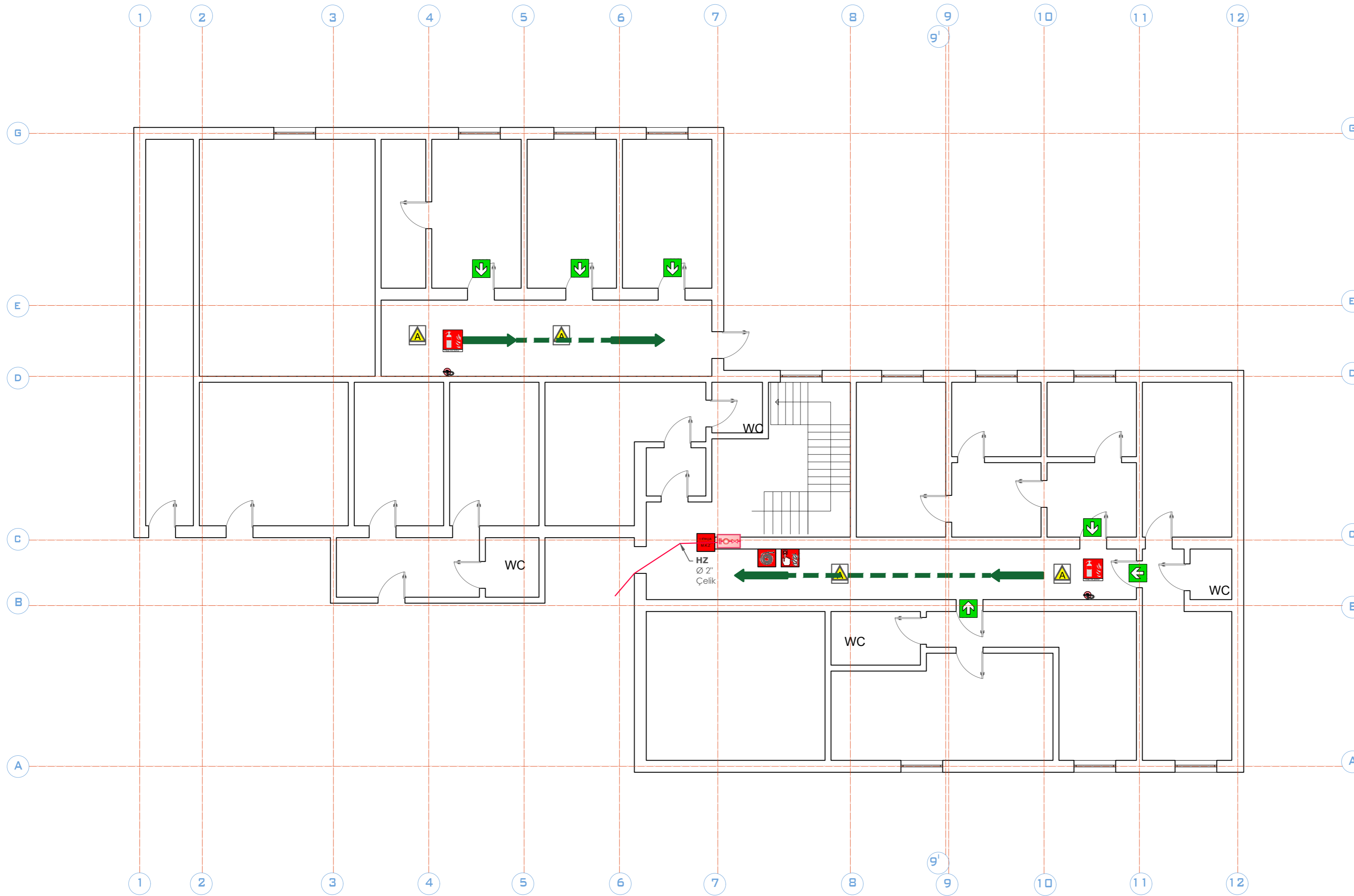

LEGJENDA :

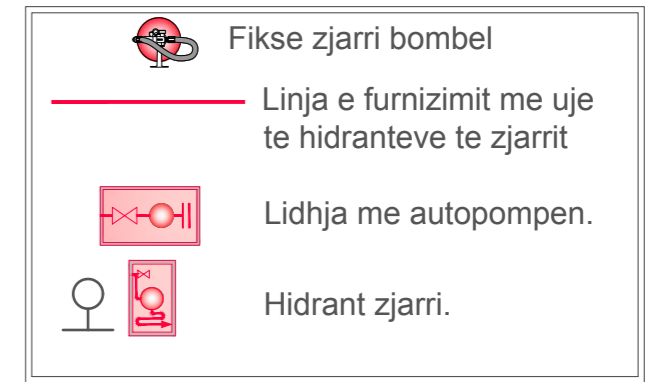

SINJALISTIKA :



Projekti : RIKONSTRUKSION			
Klienti : BASHKIA BURREL			
DERBI-E sh.p.k. "Rruga e Dibres" Pallati Andi Konstruksion Shk.1, Ap.3, Tirane, Albania Mob: +355 67 20 57534 E-mail: derbie.studio@gmail.com,			
Arkitekti : Olger Qirjaqi (Nr. Lic. A.1017/2)			
Inxhinier Konstruktore : Bexhet Dedja (Nr. Lic. K.1184/3)			
Inxhinier Hidroteknike : Edmond Theodhori (Nr. Lic. K.0783/2)			
Inxhinier Elektrike : Besnik Kaliqi (Nr. Lic. E.0964/2)			
Emertimi i Objektivit : Rikonstruksion i ish hotelit te ish uzines se ferrokromit			
Emertimi i vizatimit : Planimetria e katit perdhe ,MNZ			
Kodi i vizatimit	Shkalla	Formati	A 3
	1 : 100	Fleta	6

PLANIMETRIA KATI PARE-MNZ

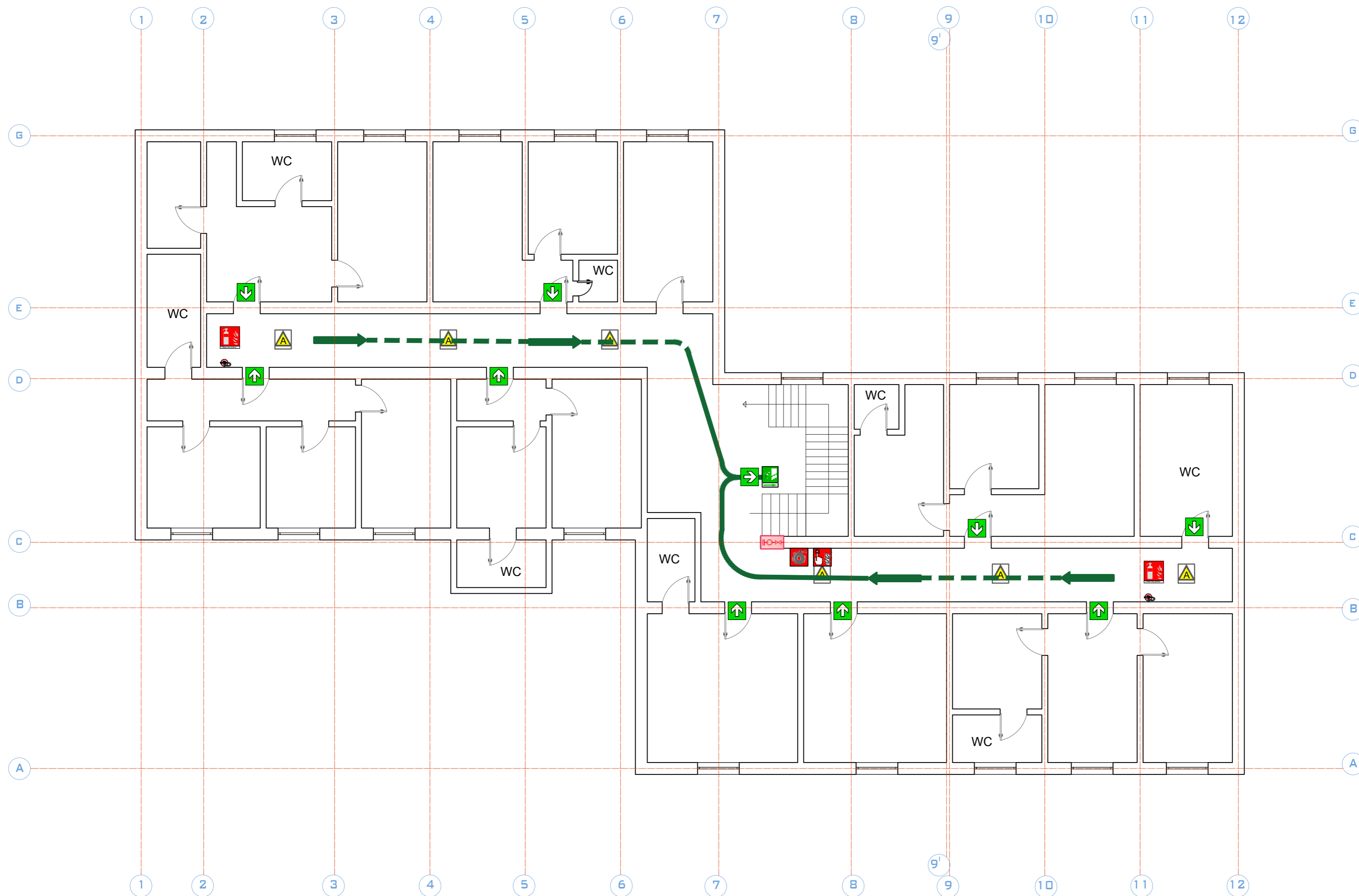

LEGJENDA :

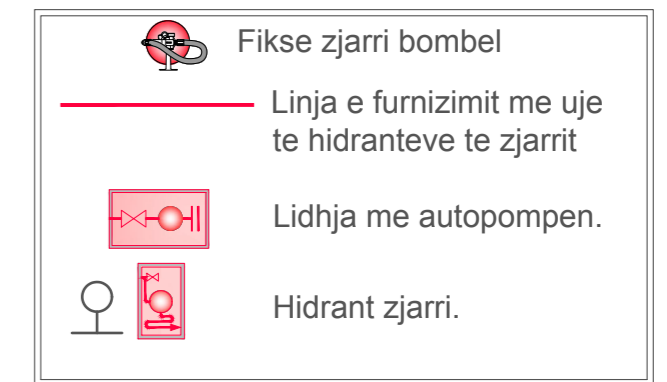

SINJALISTIKA :



Projekti :
RIKONSTRUKSION

Klienti : **BASHKIA BURREL**

DERBI-E sh.p.k.
"Rruga e Dibres" Pallati Andi Konstruksion Shk.1, Ap.3,
Tirane, Albania
Mob: +355 67 20 57534
E-mail: derbie.studio@gmail.com,

Arkitekt :
Olger Qirjaqi (Nr. Lic. A.1017/2)

Inxhinier Konstruktore :
Bexhet Dedja (Nr. Lic. K.1184/3)

Inxhinier Hidroteknik :
Edmond Theodhori (Nr. Lic. K.0783/2)

Inxhinier Elektrik :
Besnik Kaliqi (Nr. Lic. E.0964/2)

Emertimi i Objektivit : Rikonstruksion i ish hotelit te ish uzines se ferrokromit

Emertimi i vizatimit :
Planimetria e katit pare,MNZ

Kodi i vizatimit	Shkalla	Formati	A 3
	1 : 100	Fleta	7

PLANIMETRIA KATI DYTE -MNZ

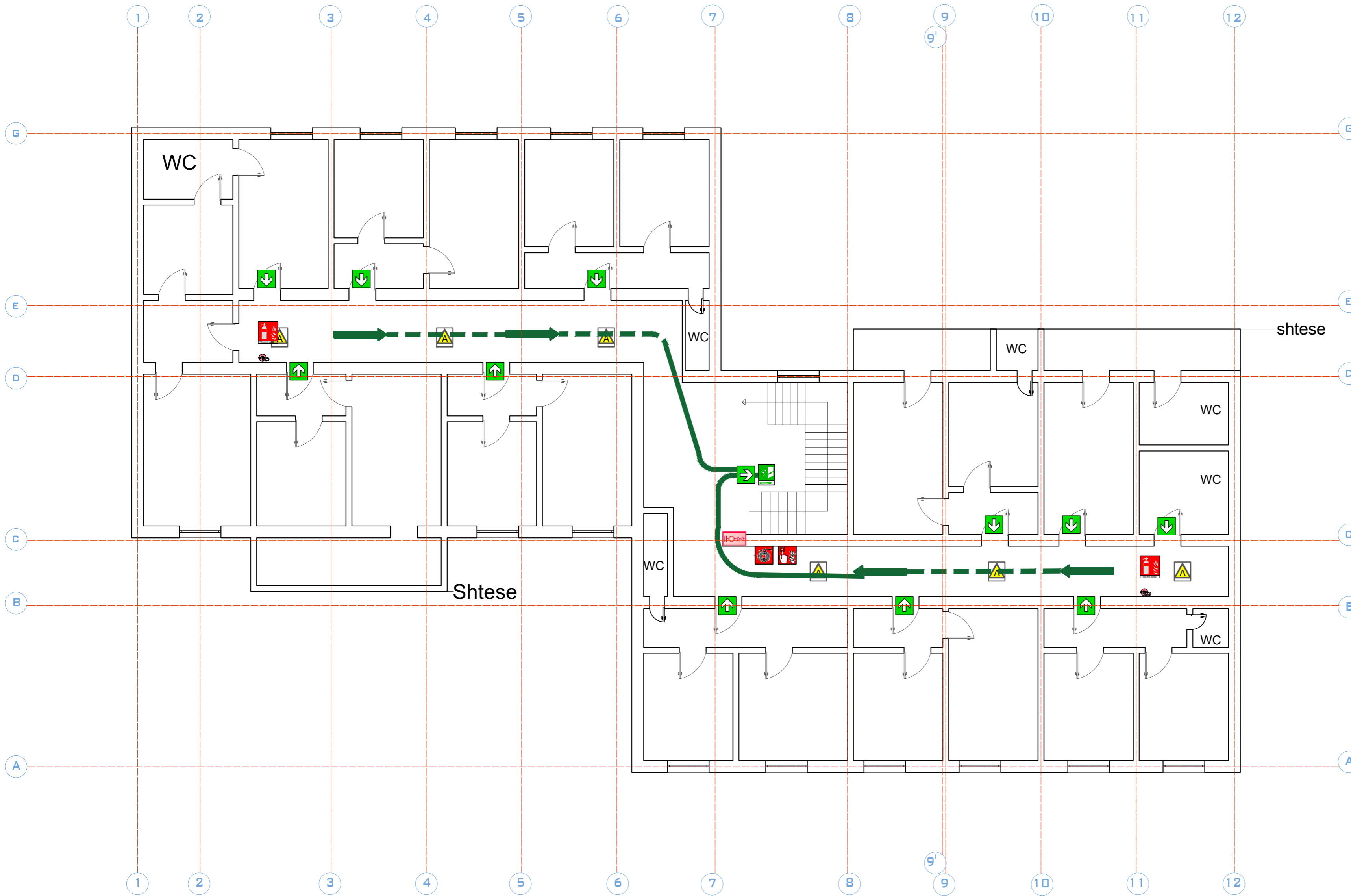

LEGJENDA :

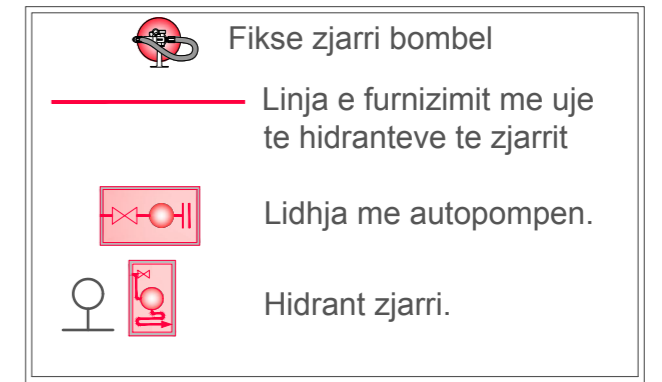

SINJALISTIKA :



Projekti :
RIKONSTRUKSION

Klienti : **BASHKIA BURREL**

DERBI-E sh.p.k.
"Rruga e Dibres" Pallati Andi Konstruksion Shk.1, Ap.3,
Tirane, Albania
Mob: +355 67 20 57534
E-mail: derbie.studio@gmail.com,

Arkitekt :
Olger Qirjaqi (Nr. Lic. A.1017/2)

Inxhinier Konstruktor :
Bexhet Dedja (Nr. Lic. K.1184/3)

Inxhinier Hidroteknik :
Edmond Theodhori (Nr. Lic. K.0783/2)

Inxhinier Elektrik :
Besnik Kaliqi (Nr. Lic. E.0964/2)

Emertimi i Objektivit : Rikonstruksion i ish hotelit te ish uzines se ferrokromit

Emertimi i vizatimit :
Planimetria e katit dyte, MNZ

Kodi i vizatimit	Shkalla	Formati	A 3
	1 : 100	Fleta	8

PLANIMETRIA KATI TRETE -MNZ

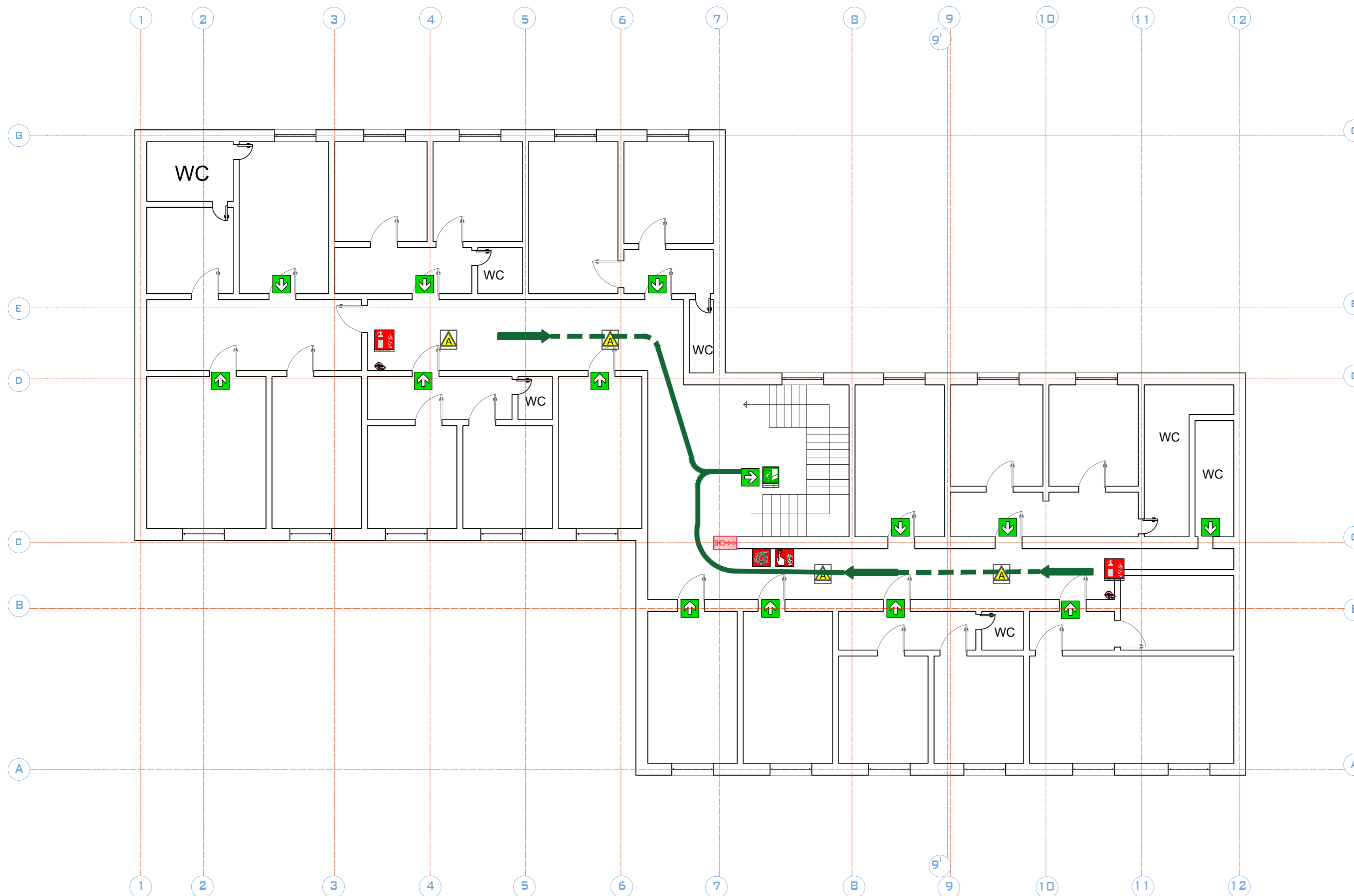

LEGJENDA :

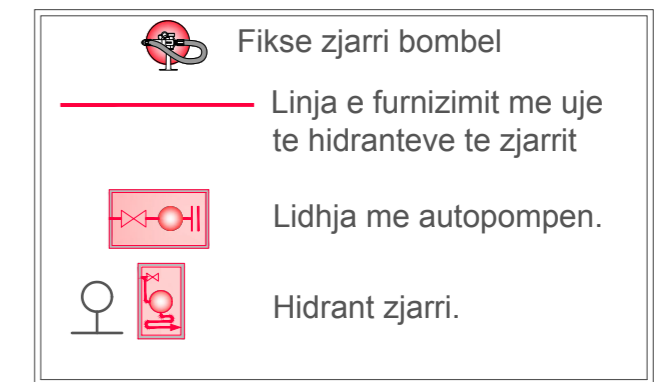

SINJALISTIKA :



Projekti :
RIKONSTRUKSION

Klienti : **BASHKIA BURREL**

DERBI-E sh.p.k.
"Rruga e Dibres" Pallati Andi Konstruksion Shk.1, Ap.3,
Tirane, Albania
Mob: +355 67 20 57534
E-mail: derbie.studio@gmail.com,

Arkitekt :
Olger Qirjaqi (Nr. Lic. A.1017/2)

Inxhinier Konstruktore :
Bexhet Dedja (Nr. Lic. K.1184/3)

Inxhinier Hidroteknik :
Edmond Theodhori (Nr. Lic. K.0783/2)

Inxhinier Elektrik :
Besnik Kaliqi (Nr. Lic. E.0964/2)

Emertimi i Objektivit : Rikonstruksion i ish hotelit te ish zines se ferrokromit

Emertimi i vizatimit :
Planimetria e katit trete, MNZ

Kodi i vizatimit	Shkalla	Formati	A 3
	1 : 100	Fleta	9

PLANIMETRIA KATI KATER -MNZ

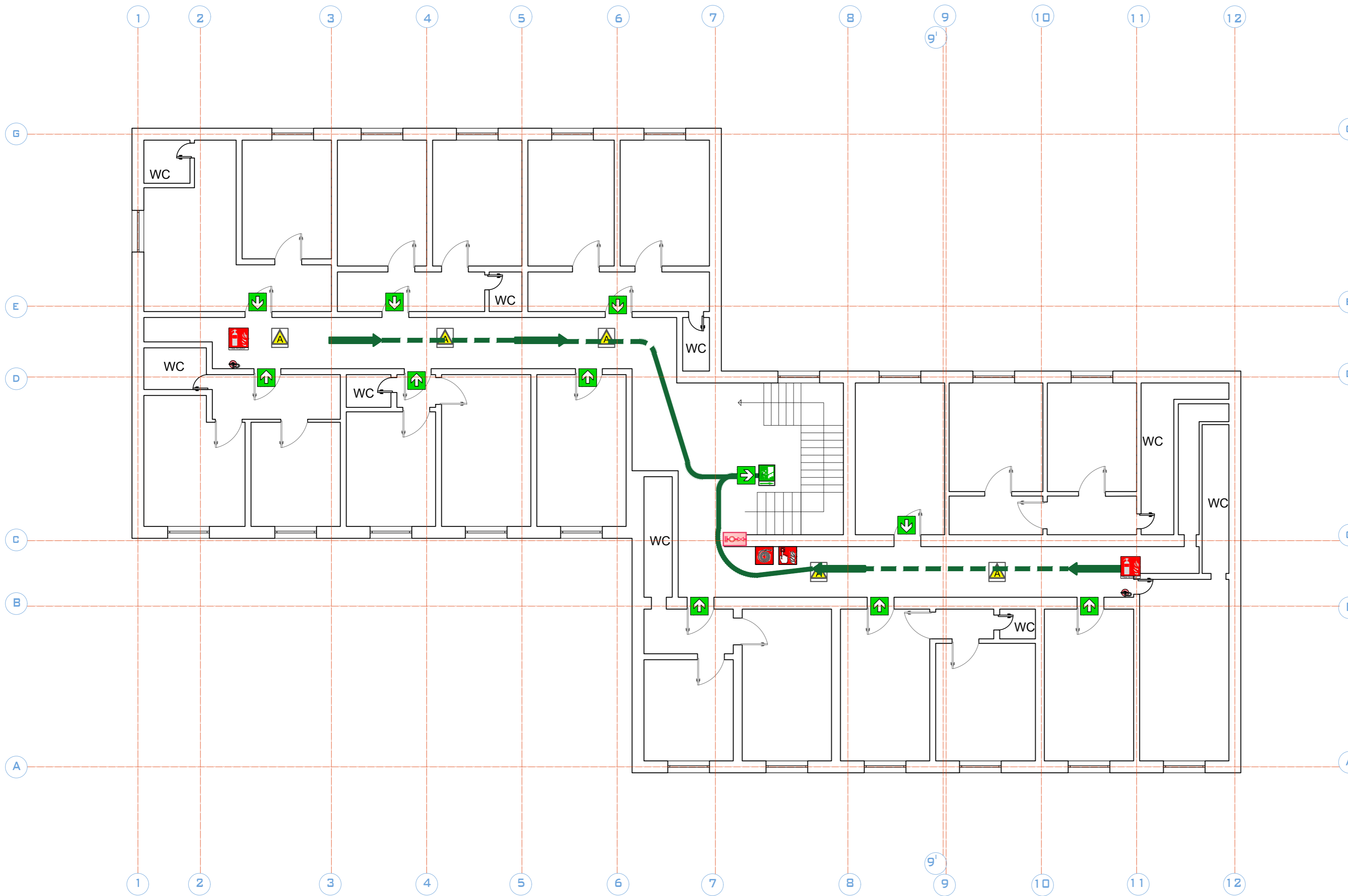

LEGJENDA :

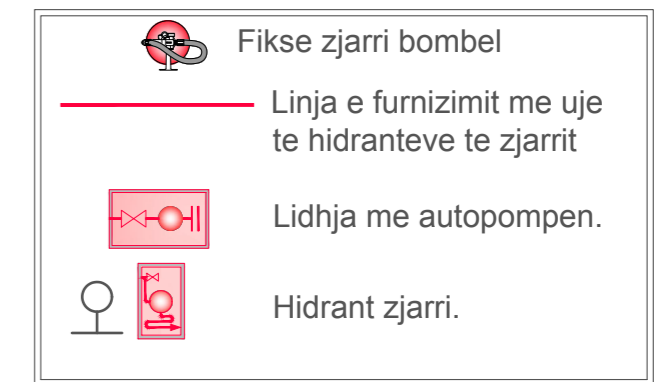

SINJALISTIKA :



Projekti :
RIKONSTRUKSION

Klienti : **BASHKIA BURREL**

DERBI-E sh.p.k.
"Rruga e Dibres" Pallati Andi Konstruksion Shk.1, Ap.3,
Tirane, Albania
Mob: +355 67 20 57534
E-mail: derbie.studio@gmail.com,

Arkitekt :
Olger Qirjaqi (Nr. Lic. A.1017/2)

Inxhinier Konstruktor :
Bexhet Dedja (Nr. Lic. K.1184/3)

Inxhinier Hidroteknik :
Edmond Theodhori (Nr. Lic. K.0783/2)

Inxhinier Elektrik :
Besnik Kaliqi (Nr. Lic. E.0964/2)

Emertimi i Objektivit : Rikonstruksion i ish hotelit te ish uzines se ferrokromit



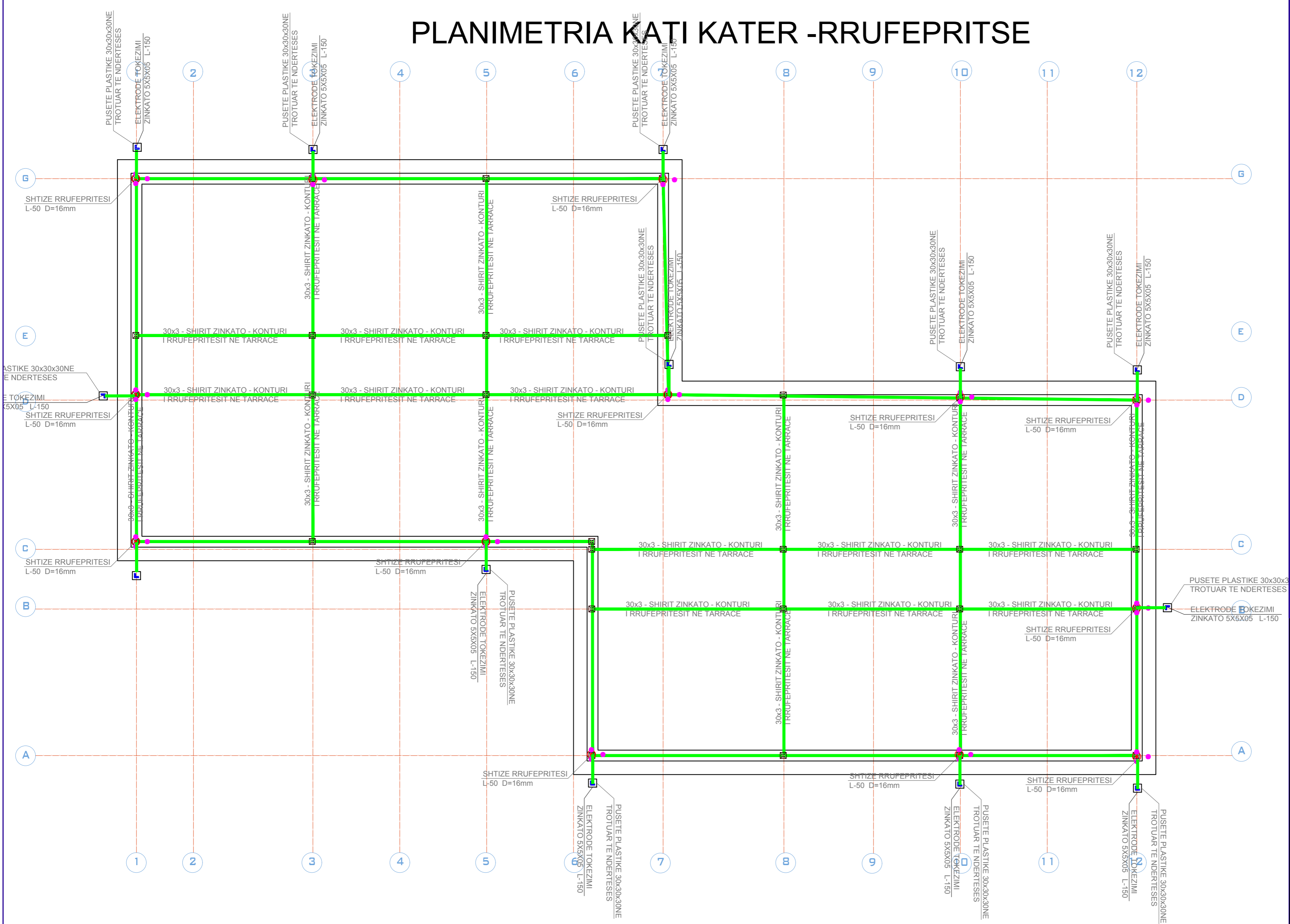

Emertimi i vizatimit :
Planimetria e katit kater,MNZ

Kodi i vizatimit	Shkalla	Formati	A 3
	1 : 100	Fleta	10

PLANIMETRIA KATI KATER -RRUFEPRITSE

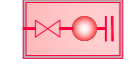

LEGJENDA :

-  Fikse zjarri bombel
-  Linja e furnizimit me uje te hidranteve te zjarrit
-  Lidhja me autopompen.
-  Hidrant zjarri.

SINJALISTIKA :

-  Sinjalistike Klasa e zjarrit A
-  Sinjalistike lidhje me autopompen.
-  Sinjalistike alarm zjarri.
-  Sinjalistike hidrant zjarri.
-  Sinjalistike zbritje shkallesh.
-  Drejtim dalje.
-  Fikse zjarri me bombel

Projekti : RIKONSTRUKSION			
Klienti : BASHKIA BURREL			
DERBI-E sh.p.k. "Rruga e Dibres" Pallati Andi Konstruksion Shk.1, Ap.3, Tirane, Albania Mob: +355 67 20 57534 E-mail: derbie.studio@gmail.com,			
Arkitekt : Olger Qirjaqi (Nr. Lic. A.1017/2)			
Inxhinier Konstrktor : Bexhet Dedja (Nr. Lic. K.1184/3)			
Inxhinier Hidroteknik : Edmond Theodhori (Nr. Lic. K.0783/2)			
Inxhinier Elektrik : Besnik Kaliqi (Nr. Lic. E.0964/2)			
Emertimi i Objektivit : Rikonstruksion i ish hotelit te ish uzines se ferrokromit			
Emertimi i vizatimit : Planimetria e katit kater,MNZ			
Kodi i vizatimit	Shkalla	Formati	A 3
	1 : 100	Fleta	10

FIKSIMI I RRUFEPRITESIT NE PARAPET

SKEMA Nr.5/1

FIKSIMI I RRUFEPRITESIT NE KAPSE

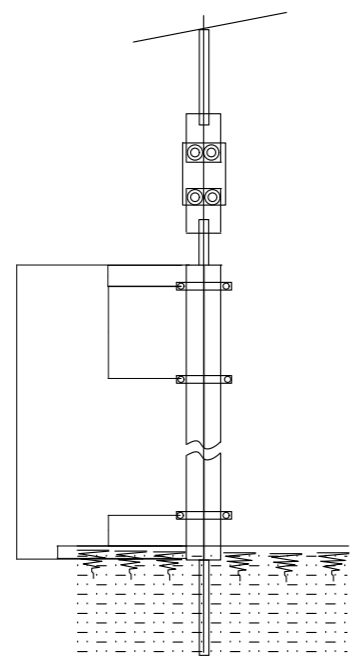
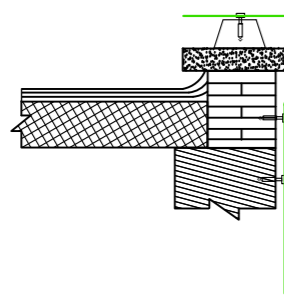
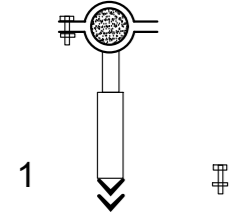

SHKEPUTESI PER MATJE

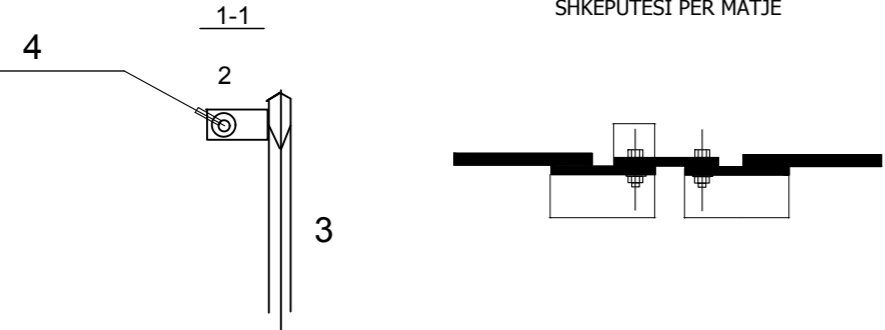

SHENIM :

1. zbritesat e tokezimit mbrojtjes mund te jene shirit i zinguar 40 x 4 mm ose
2. perçjelles bakri cu 50 mm²
3. rezistenca e tokezimit mbrojtjes duhet te jete jo me e madhe se 4 om
4. ne qofte se pas matjes rezulton me e madhe se 4 ohm atehere duhet te shtojme numrin e elektrodave te tokezimit
5. zbritesi duhet te futet ne tubin mbrojtjes te kablove nr.1,2,3,4,5,6, elektroda tokezimi me gjatesi l =1500 mm
6. lidhja e shiritit te tokezimit me elektrodat do te behet me morseteri perkatese ose bulon + dado + kapikorda
7. ne qofte se do te pedorim shirit tokezimi lame 40 x 4 mm mund te perdorim edhe saldimin me elektroda
8. konturi i tokezimit mbrojtjes do te lidhet me zbritesin me dy degezime

ELEMENTE MONTIMI

DETAJE PER MONTIMIN E INSTALIMIT TE MBROJTJES NGA SHKARKIMET ATMOSFERIKE

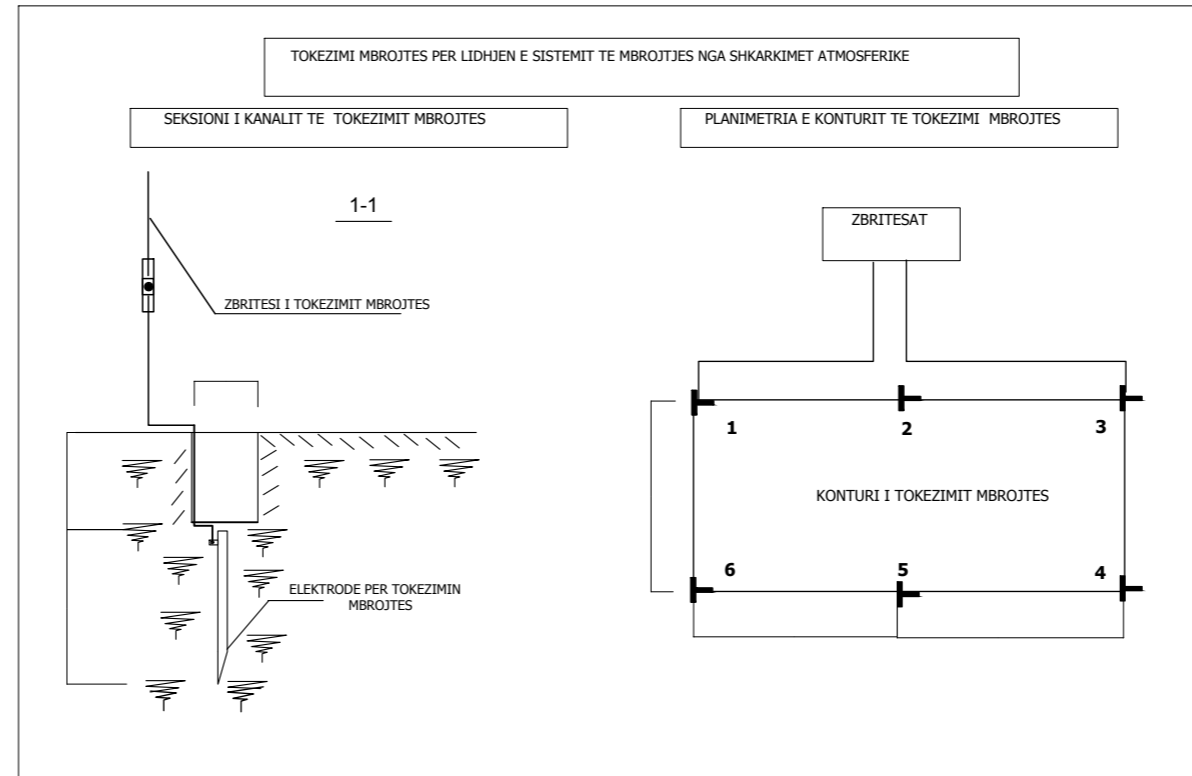
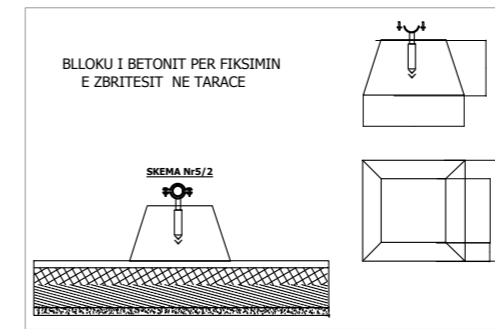
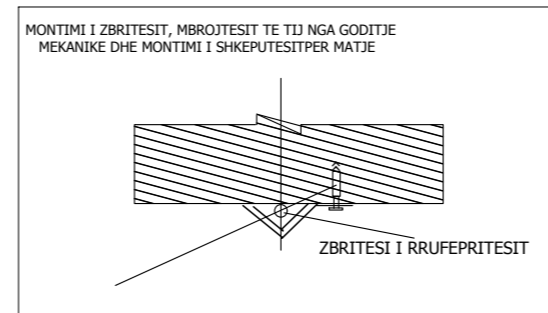

LEGJENDA :

- Fikse zjarri bombel
- Linja e furnizimit me uje te hidranteve te zjarrit
- Lidhja me autopompen.
- Hidrant zjarri.

SINJALISTIKA :

- Sinjalistike Klasa e zjarrit A
- Sinjalistike lidhje me autopompen.
- Sinjalistike alarm zjarri.
- Sinjalistike hidrant zjarri.
- Sinjalistike zbritje shkallësh.
- Drejtim dalje.
- Fikse zjarri me bombel

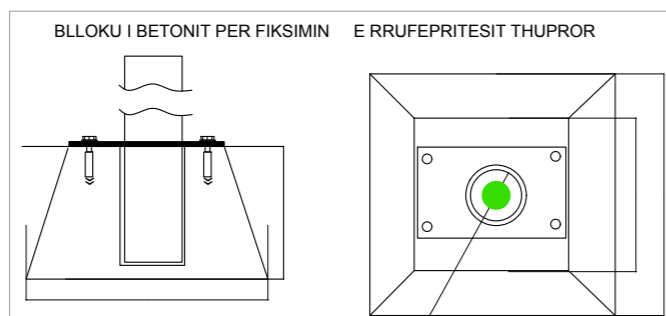
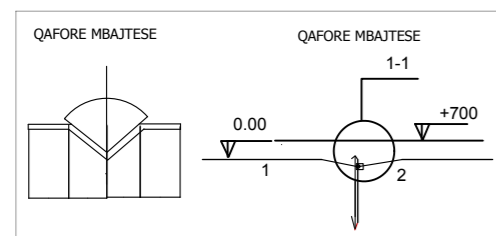

SHENIME TEKNIKE
 1. MBROJTJESIT DO TE JETE NE FORMEN E MBROJTJESIT SHPURTOR.
 2. ZBRITJESIT E MBROJTJESIT BASHKON NE SHKARKIMET NE TËRËSI.
 3. SHKARKIMET MBROJTJESIT DO TE JENË NE TËRËSI MBROJTJESIT NE TËRËSI.
 4. SHKARKIMET MBROJTJESIT DO TE JENË NE TËRËSI MBROJTJESIT NE TËRËSI.
 5. SHKARKIMET MBROJTJESIT DO TE JENË NE TËRËSI MBROJTJESIT NE TËRËSI.
 6. SHKARKIMET MBROJTJESIT DO TE JENË NE TËRËSI MBROJTJESIT NE TËRËSI.
 7. SHKARKIMET MBROJTJESIT DO TE JENË NE TËRËSI MBROJTJESIT NE TËRËSI.
 8. SHKARKIMET MBROJTJESIT DO TE JENË NE TËRËSI MBROJTJESIT NE TËRËSI.
 9. SHKARKIMET MBROJTJESIT DO TE JENË NE TËRËSI MBROJTJESIT NE TËRËSI.
 10. SHKARKIMET MBROJTJESIT DO TE JENË NE TËRËSI MBROJTJESIT NE TËRËSI.

SKEMA E TOKEZIMIT MBROJTJES MONTIMI

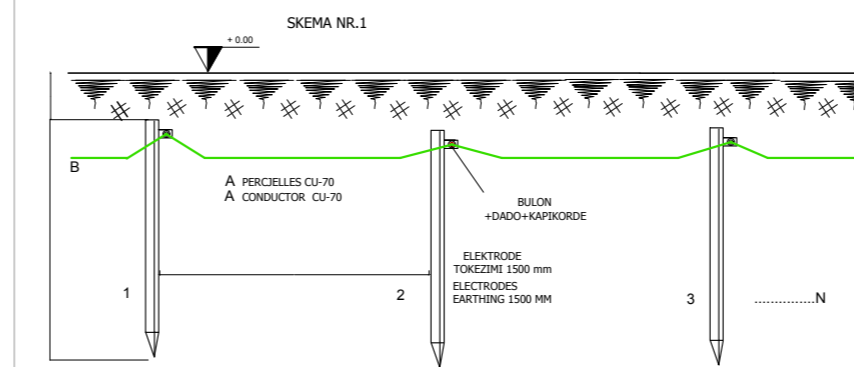

A-Shiriti tokezimi 40x4 ose perçjelles CU 70
 Nr-1,2,3,N. Elektroda tokezimi
 B-Zbritesashiriti tokezimi 40x4 ose perçjelles Cu-70

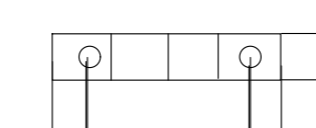

Projekti : **RIKONSTRUKSION**

Klienti : **BASHKIA BURREL**

DERBI-E sh.p.k.
 "Rruga e Dibres" Pallati Andi Konstruksion Shk.1, Ap.3,
 Tirane, Albania
 Mob: +355 67 20 57534
 E-mail: derbie.studio@gmail.com,

Arkitekt : **Olger Qirjaqi** (Nr. Lic. A.1017/2)

Inxhinier Konstruktore : **Bexhet Dedja** (Nr. Lic. K.1184/3)

Inxhinier Hidroteknike : **Edmond Theodhori** (Nr. Lic. K.0783/2)

Inxhinier Elektrike : **Besnik Kaliqi** (Nr. Lic. E.0964/2)

Emertimi i Objektivit : Rikonstruksion i ish hotelit te ish uzines se ferrokromit



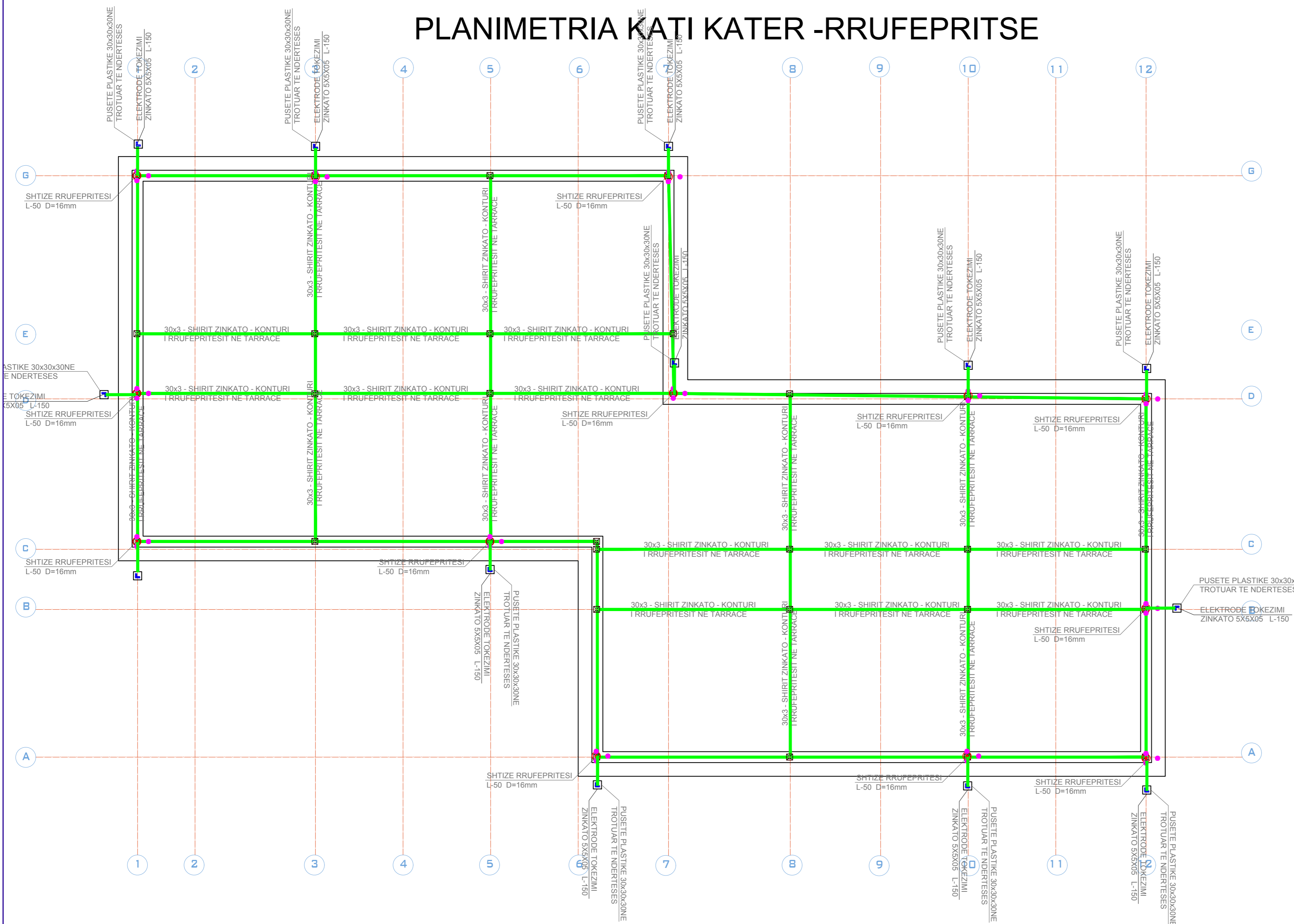

Emertimi i vizatimit : **Planimetria e katit kater,MNZ**

Kodi i vizatimit	Shkalla	Formati	A 3
	1 : 100	Fleta	10

PLANIMETRIA KATI KATER -RRUFEPRITSE

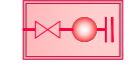

LEGJENDA :

-  Fikse zjarri bombel
-  Linja e furnizimit me uje te hidranteve te zjarrit
-  Lidhja me autopompen.
-  Hidrant zjarri.

SINJALISTIKA :

-  Sinjalistike Klasa e zjarrit A
-  Sinjalistike lidhje me autopompen.
-  Sinjalistike alarm zjarri.
-  Sinjalistike hidrant zjarri.
-  Sinjalistike zbritje shkallesh.
-  Drejtim dalje.
-  Fikse zjarri me bombel

Projekti : RIKONSTRUKSION			
Klienti : BASHKIA BURREL			
DERBI-E sh.p.k. "Rruga e Dibres" Pallati Andi Konstruksion Shk.1, Ap.3, Tirane, Albania Mob: +355 67 20 57534 E-mail: derbie.studio@gmail.com,			
Arkitekt : Olger Qirjaqi (Nr. Lic. A.1017/2)			
Inxhinier Konstruktor : Bexhet Dedja (Nr. Lic. K.1184/3)			
Inxhinier Hidroteknik : Edmond Theodhori (Nr. Lic. K.0783/2)			
Inxhinier Elektrik : Besnik Kaliqi (Nr. Lic. E.0964/2)			
Emertimi i Objektivit : Rikonstruksion i ish hotelit te ish uzines se ferrokromit			
Emertimi i vizatimit : Planimetria e katit kater,MNZ			
Kodi i vizatimit	Shkalla	Formati	A 3
	1 : 100	Fleta	10

PLANIMETRIA KATI KATER -RRUFEPRITSE

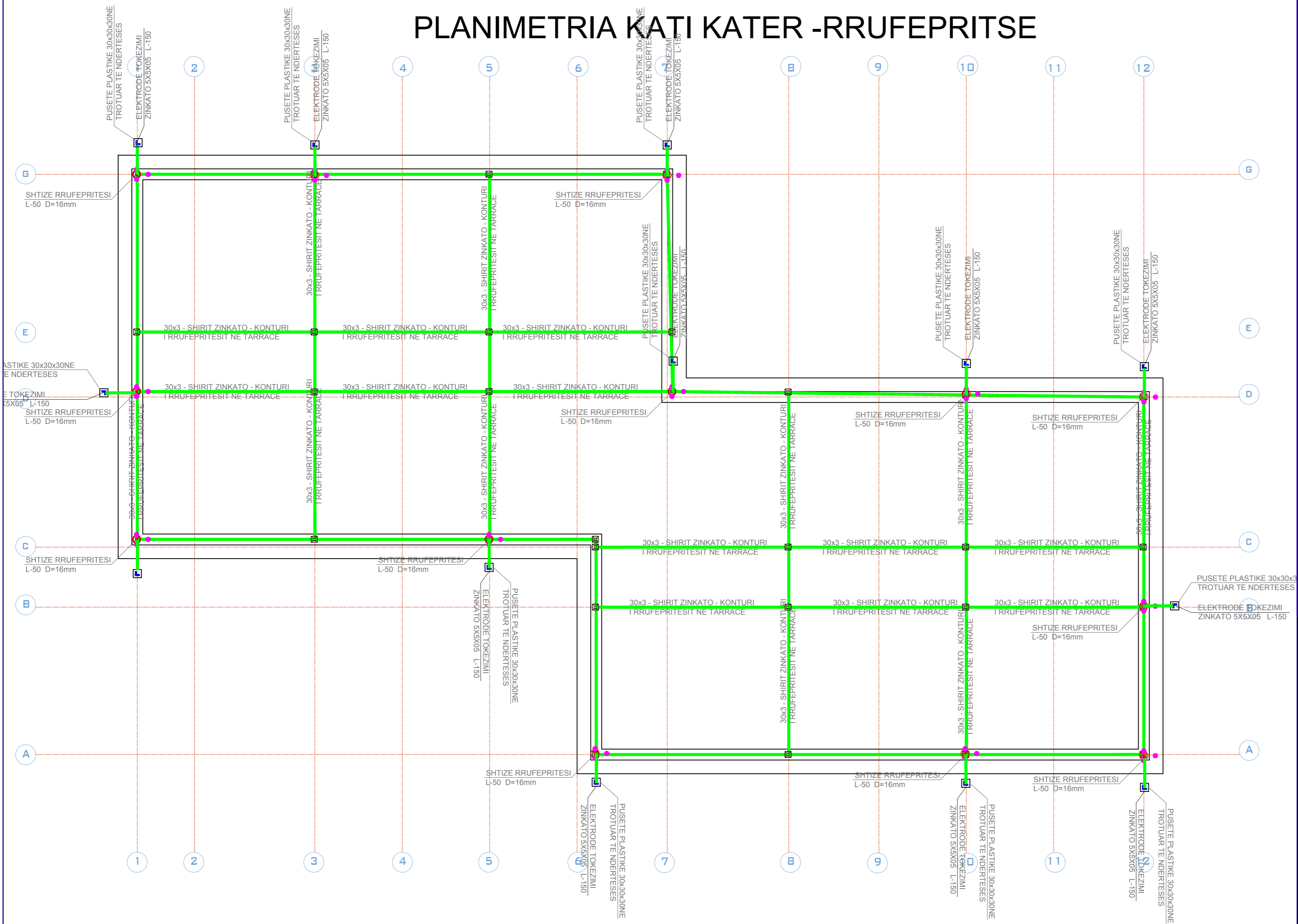

LEGJENDA :

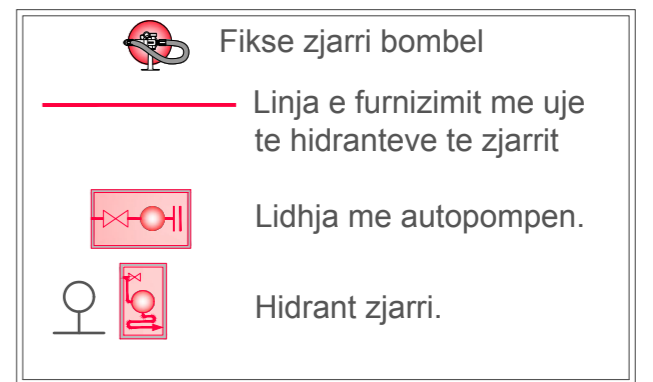

SINJALISTIKA :



Projekti : RIKONSTRUKSION			
Klienti : BASHKIA BURREL			
DERBI-E sh.p.k. "Rruga e Dibres" Pallati Andi Konstruksion Shk.1, Ap.3, Tirane, Albania Mob: +355 67 20 57534 E-mail: derbie.studio@gmail.com,			
Arkitekt : Olger Qirjaqi (Nr. Lic. A.1017/2)			
Inxhinier Konstruktor : Bexhet Dedja (Nr. Lic. K.1184/3)			
Inxhinier Hidroteknik : Edmond Theodhori (Nr. Lic. K.0783/2)			
Inxhinier Elektrik : Besnik Kaliqi (Nr. Lic. E.0964/2)			
Emertimi i Objektivit : Rikonstruksion i ish hotelit te ish uzines se ferrokromit			
Emertimi i vizatimit : Planimetria e katit kater,MNZ			
Kodi i vizatimit	Shkalla	Formati	A 3
	1 : 100	Fleta	10