



BASHKIA VAU DEJES

MIRATOHET
KRYETARI I BASHKISË
Z. MARK BABANI

PROJEKT ZBATIMI
RIKONSTRUKSION I RRUGEVE TE
LAGJES LISEN

PROJEKTOI:

"LENI-ING" SH.P.K



TIRANË 2023

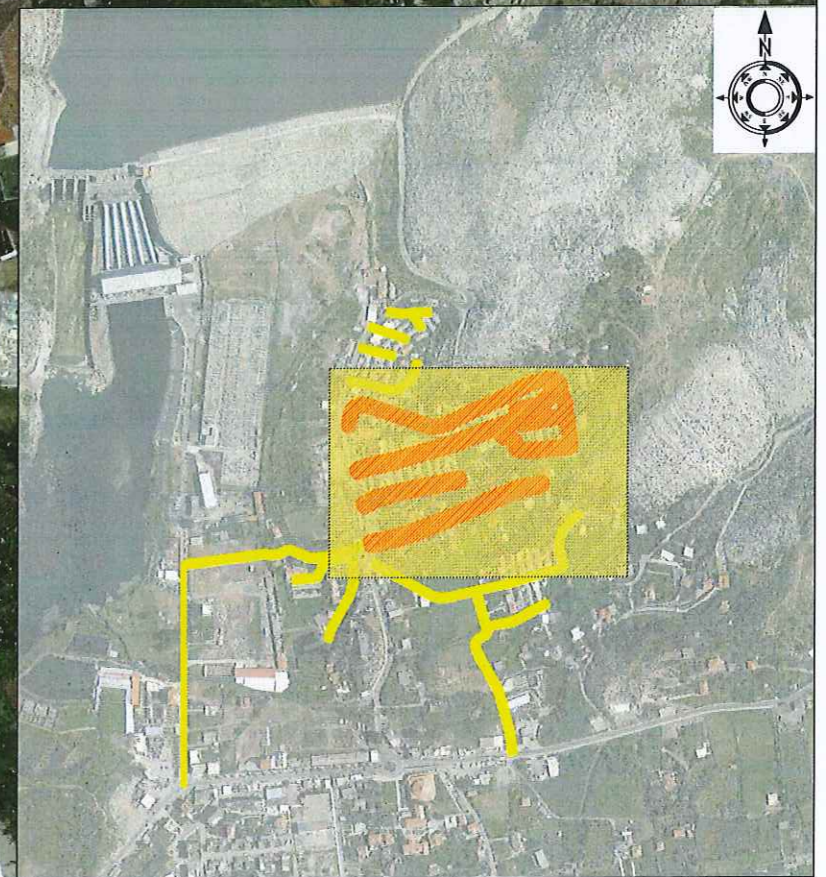
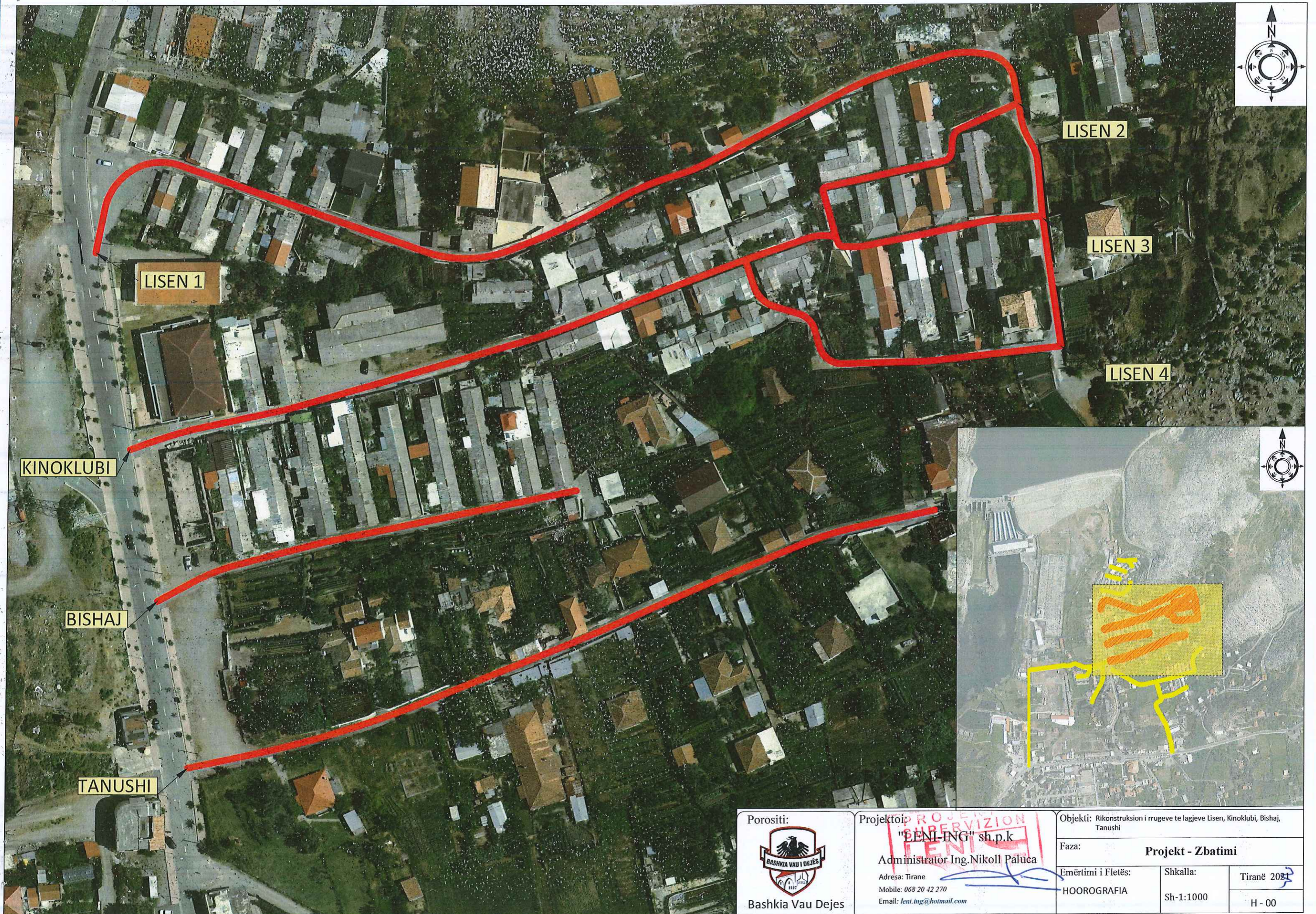

Porositi:  Bashkia Vau Dejes	Projektoi: "LENLING" sh.p.k Administrator Ing.Nikoll Paluca Adresa: Tirane Mobile: 068 20 42 270 Email: len.ing@hotmail.com	Objekti: Rikonstrukon i rrugeve te lagjeve Lisen, Kinoklubi, Bishaj, Tanushi		
		Faza: Projekt - Zbatimi		
		Emërtimi i Fletës: HOOROGRAFIA	Shkalla: Sh-1:1000	Tiranë 2021 H - 00

TOPOGRAFIA E RRUGES

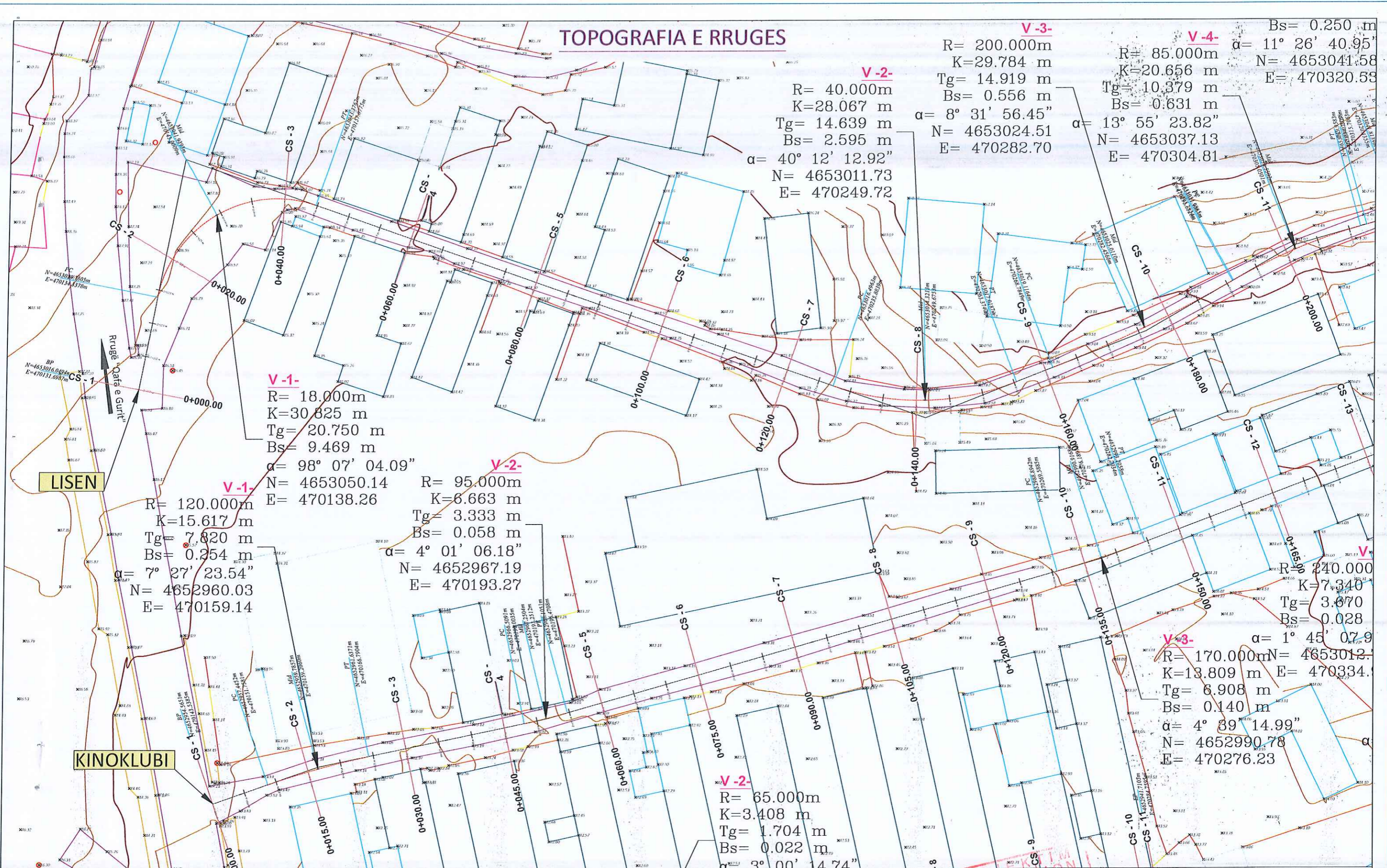

V-1-
 R= 18.000m
 K=30.825 m
 Tg= 20.750 m
 Bs= 9.469 m
 $\alpha = 98^\circ 07' 04.09''$
 N= 4653050.14
 E= 470138.26

V-2-
 R= 95.000m
 K=6.663 m
 Tg= 3.333 m
 Bs= 0.058 m
 $\alpha = 4^\circ 01' 06.18''$
 N= 4652967.19
 E= 470193.27

V-2-
 R= 40.000m
 K=28.067 m
 Tg= 14.639 m
 Bs= 2.595 m
 $\alpha = 40^\circ 12' 12.92''$
 N= 4653011.73
 E= 470249.72

V-3-
 R= 200.000m
 K=29.784 m
 Tg= 14.919 m
 Bs= 0.556 m
 $\alpha = 8^\circ 31' 56.45''$
 N= 4653024.51
 E= 470282.70

V-4-
 R= 85.000m
 K=20.656 m
 Tg= 10.379 m
 Bs= 0.631 m
 $\alpha = 13^\circ 55' 23.82''$
 N= 4653037.13
 E= 470304.81

Bs= 0.250 m
 $\alpha = 11^\circ 26' 40.95''$
 N= 4653041.58
 E= 470320.53

V-1-
 R= 120.000m
 K=15.617 m
 Tg= 7.820 m
 Bs= 0.254 m
 $\alpha = 7^\circ 27' 23.54''$
 N= 4652960.03
 E= 470159.14

V-3-
 R= 240.000m
 K=7.340 m
 Tg= 3.670 m
 Bs= 0.028 m
 $\alpha = 1^\circ 45' 07.9''$
 N= 4653012.7
 E= 470334.7

V-2-
 R= 170.000m
 K=13.809 m
 Tg= 6.908 m
 Bs= 0.140 m
 $\alpha = 4^\circ 39' 14.99''$
 N= 4652990.78
 E= 470276.23

V-2-
 R= 65.000m
 K=3.408 m
 Tg= 1.704 m
 Bs= 0.022 m
 $\alpha = 3^\circ 00' 14.74''$

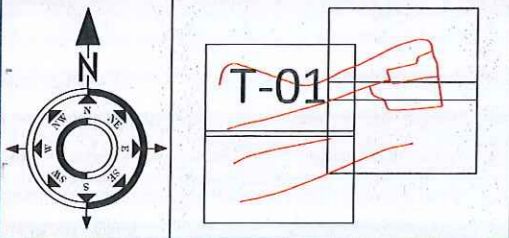

	RRUGE NATYRALE		RRUGE ASFALT EKZISTUES
	NDERTESA		PORTE
	IZOIPSE		RRETHIM

Porositi:

 Bashkia Vau Dejës

Projektor:
 "LENI-ING" sh.p.k
 Administrator Ing. Nikoll Paluca
 Adresa: Tirane
 Mobile: 068 20 42 370
 Email: leni.ing@hotmail.com

Objekti: Rikonstrukion i rrugeve te lagjeve Lisen, Kinoklubi, Bishaj, Tanushi

Faza: **Projekt - Zbatimi**

Emërtimi i Fletës: TOPOGRAFIA E RRUGES	Shkalla: Sh-1:500	Tiranë 2023 T-01
---	----------------------	---------------------

TOPOGRAFIA E RRUGES

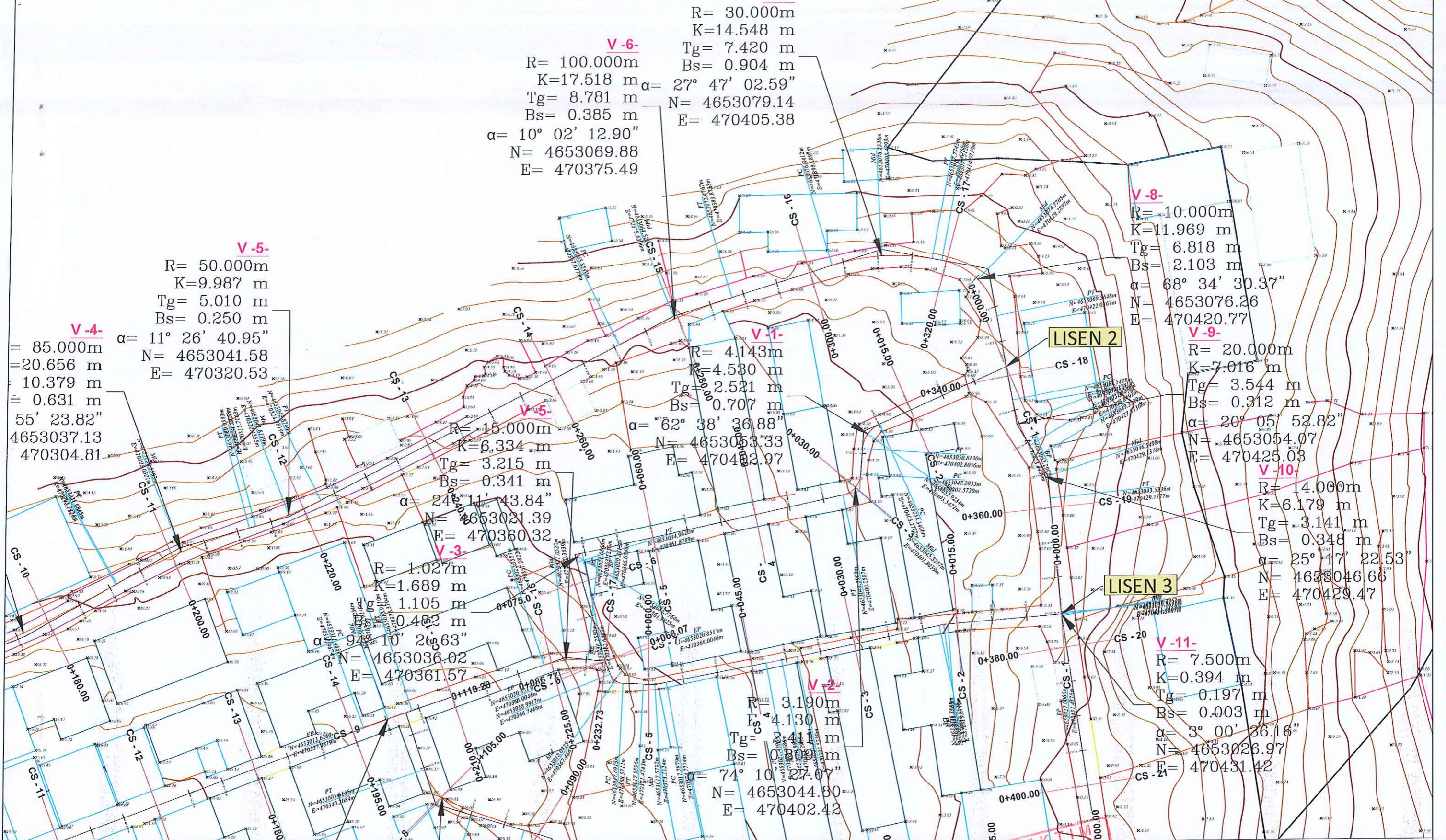

$R = 30.000m$
 $K = 14.548m$
 $Tg = 7.420m$
 $Bs = 0.904m$
 $\alpha = 27^\circ 47' 02.59''$
 $N = 4653079.14$
 $E = 470405.38$

V-5-
 $R = 50.000m$
 $K = 9.987m$
 $Tg = 5.010m$
 $Bs = 0.250m$

V-4-
 $R = 85.000m$
 $K = 20.656m$
 $Tg = 10.379m$
 $Bs = 0.631m$
 $\alpha = 11^\circ 26' 40.95''$
 $N = 4653041.58$
 $E = 470320.53$

V-8-
 $R = 10.000m$
 $K = 11.969m$
 $Tg = 6.818m$
 $Bs = 2.103m$
 $\alpha = 68^\circ 34' 30.37''$
 $N = 4653076.26$
 $E = 470420.77$

V-1-
 $R = 4.143m$
 $K = 4.530m$
 $Tg = 2.521m$
 $Bs = 0.707m$
 $\alpha = 62^\circ 38' 36.88''$
 $N = 4653053.33$
 $E = 470402.97$

V-5-
 $R = 15.000m$
 $K = 6.334m$
 $Tg = 3.215m$
 $Bs = 0.341m$
 $\alpha = 24^\circ 11' 43.84''$
 $N = 4653021.39$
 $E = 470360.32$

V-9-
 $R = 20.000m$
 $K = 7.016m$
 $Tg = 3.544m$
 $Bs = 0.312m$
 $\alpha = 20^\circ 05' 52.82''$
 $N = 4653054.07$
 $E = 470425.03$

V-3-
 $R = 1.027m$
 $K = 1.689m$
 $Tg = 1.105m$
 $Bs = 0.482m$
 $\alpha = 94^\circ 10' 23.63''$
 $N = 4653036.02$
 $E = 470361.57$

V-10-
 $R = 14.000m$
 $K = 6.179m$
 $Tg = 3.141m$
 $Bs = 0.348m$
 $\alpha = 25^\circ 17' 22.53''$
 $N = 4653046.66$
 $E = 470429.47$

V-2-
 $R = 3.190m$
 $K = 4.130m$
 $Tg = 0.809m$
 $Bs = 0.309m$
 $\alpha = 74^\circ 10' 27.07''$
 $N = 4653044.80$
 $E = 470402.42$

V-11-
 $R = 7.500m$
 $K = 0.394m$
 $Tg = 0.197m$
 $Bs = 0.003m$
 $\alpha = 3^\circ 00' 36.16''$
 $N = 4653026.97$
 $E = 470431.42$

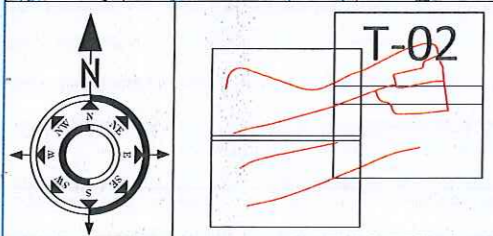

	RRUGE NATYRALE		RRUGE ASFALT EKZISTUES
	NDERTESA		PORTE
	IZOIPSE		RRETHIM

Porositi:

Bashkia Vau Dejës

Projektoi:

"LENI-ING" sh.p.k

Administrator Ing. Nikoll Paluca

Adresa: Tirane

Mobile: 068 20 42 270

Email: leni.ing@hotmail.com

Objekti: Rikonstrukion i rrugeve te lagjeve Lisën, Kinoklubi, Bishaj, Tanushi		
Faza: Projekt - Zbatimi		
Emërtimi i Fletës: TOPOGRAFIA E RRUGES	Shkalla: Sh-1:500	Tiranë 2021 T-02

TOPOGRAFIA E RRUGES

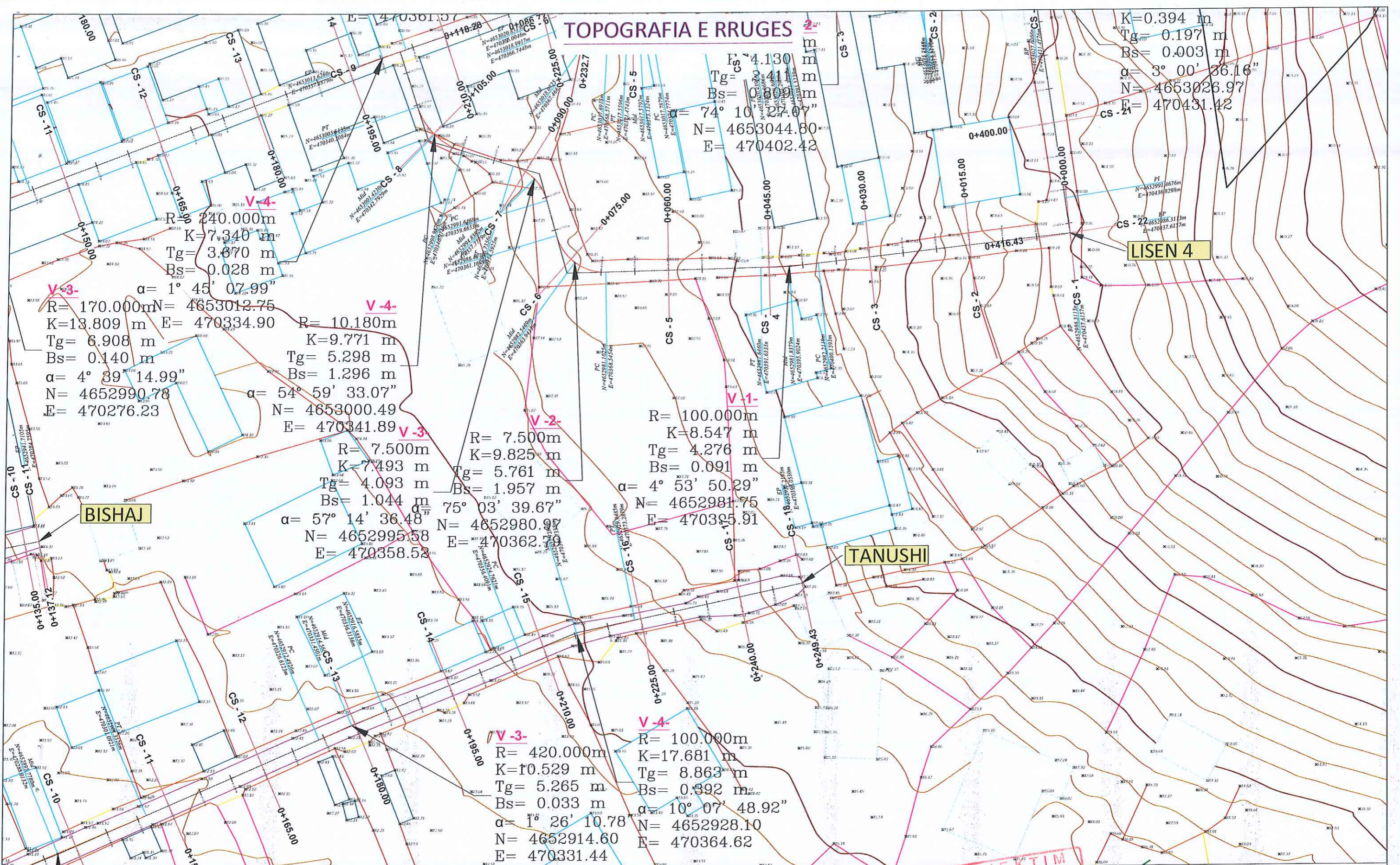

V-3-
 $R = 170.000\text{m}$
 $K = 13.809\text{m}$
 $Tg = 6.908\text{m}$
 $Bs = 0.140\text{m}$
 $\alpha = 4^\circ 39' 14.99''$
 $N = 4652990.78$
 $E = 470276.23$

V-4-
 $R = 240.000\text{m}$
 $K = 7.340\text{m}$
 $Tg = 3.670\text{m}$
 $Bs = 0.028\text{m}$
 $\alpha = 1^\circ 45' 07.99''$
 $N = 4653012.75$
 $E = 470334.90$

V-3-
 $R = 7.500\text{m}$
 $K = 7.493\text{m}$
 $Tg = 4.093\text{m}$
 $Bs = 1.044\text{m}$
 $\alpha = 57^\circ 14' 36.48''$
 $N = 4652995.58$
 $E = 470358.53$

V-2-
 $R = 7.500\text{m}$
 $K = 9.825\text{m}$
 $Tg = 5.761\text{m}$
 $Bs = 1.957\text{m}$
 $\alpha = 75^\circ 03' 39.67''$
 $N = 4652980.07$
 $E = 470362.00$

V-1-
 $R = 100.000\text{m}$
 $K = 8.547\text{m}$
 $Tg = 4.276\text{m}$
 $Bs = 0.091\text{m}$
 $\alpha = 4^\circ 53' 50.29''$
 $N = 4652981.75$
 $E = 470365.91$

V-3-
 $R = 420.000\text{m}$
 $K = 10.529\text{m}$
 $Tg = 5.265\text{m}$
 $Bs = 0.033\text{m}$
 $\alpha = 1^\circ 26' 10.78''$
 $N = 4652914.60$
 $E = 470331.44$

V-4-
 $R = 100.000\text{m}$
 $K = 17.681\text{m}$
 $Tg = 8.863\text{m}$
 $Bs = 0.392\text{m}$
 $\alpha = 10^\circ 07' 48.92''$
 $N = 4652928.10$
 $E = 470364.62$

$K = 0.394\text{m}$
 $Tg = 0.197\text{m}$
 $Bs = 0.003\text{m}$
 $\alpha = 3^\circ 00' 36.16''$
 $N = 4653026.97$
 $E = 470431.42$

LISEN 4

BISHAJ

TANUSHI

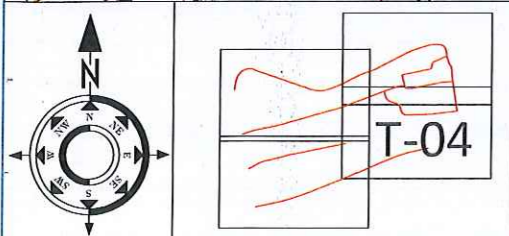

- RRUGE NATYRALE
- NDERTESA
- IZOIPSE
- RRUGE ASFALT EKZISTUES
- PORTE
- RRETHIM

Porositi:

Bashkia Vau Dejes

Projektor:

"LENI-ING" sh.p.k

Administrator Ing. Nikoll Paluca

Adresa: Tirane

Mobile: 068 20 42 270

Email: leni.ing@hotmail.com

Objekti: Rikonstrukion i rrugeve te lagjeve Lisën, Kinoklubi, Bishaj, Tanushi		
Faza: Projekt - Zbatimi		
Emërtimi i Fletës: TOPOGRAFIA E RRUGES	Shkalla: Sh-1:500	Tiranë 2021 T-04

PLANIMETRIA E RRUGES

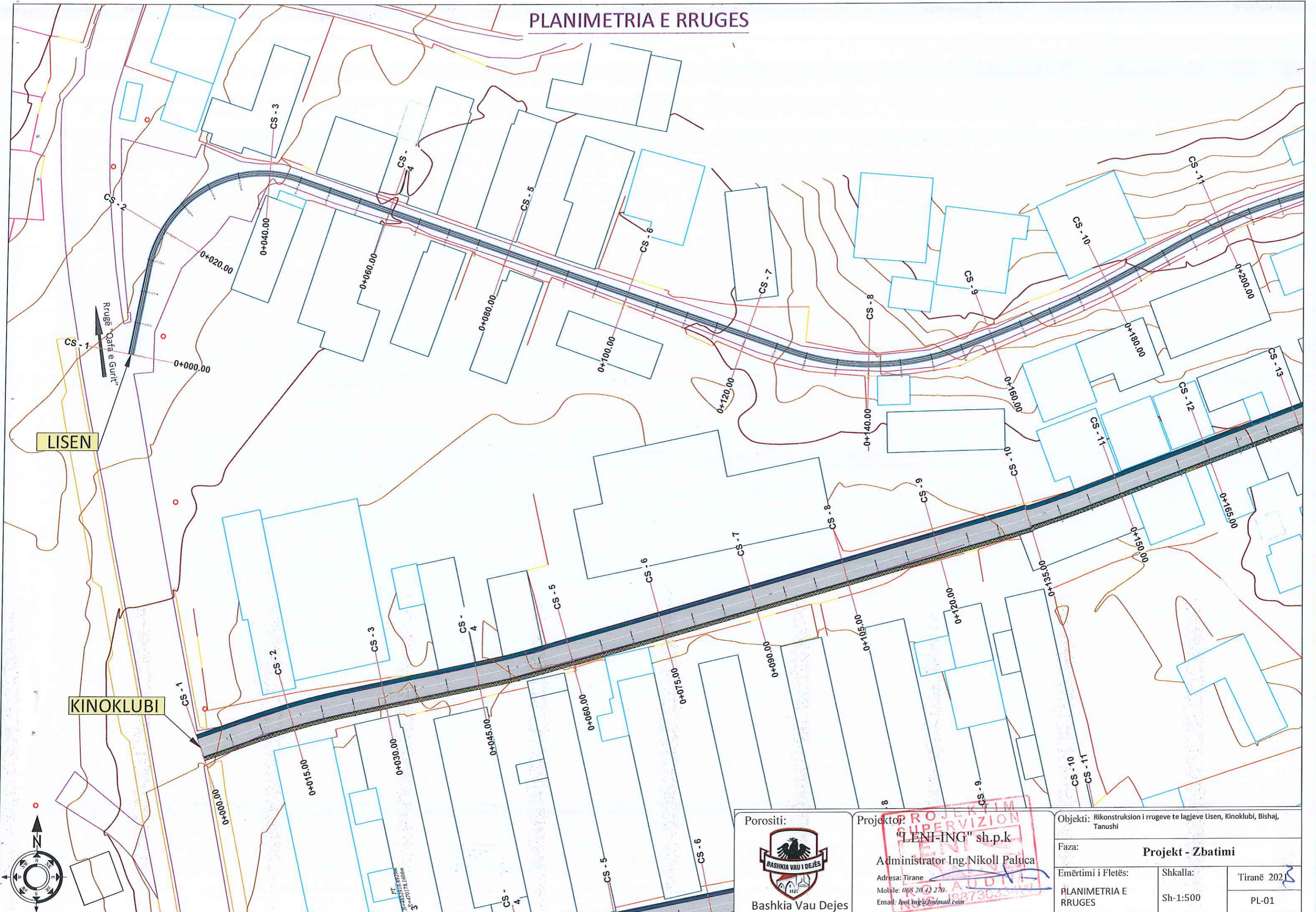

LISEN

KINOKLUBI

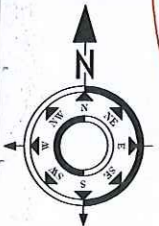

Porositi:



Bashkia Vau Dejës

Projektor:

"LENI-ING" sh.p.k

Administrator Ing. Nikoll Paluca

Adresa: Tirane
 Mobile: 068 20 43 270
 Email: leni.ing@hotmail.com

Objekti: Rikonstrukcion i rrugeve te lagjeve Lisen, Kinoklubi, Bishaj, Tanushi		
Faza: Projekt - Zbatimi		
Emërtimi i Fletës: PLANIMETRIA E RRUGES	Shkalla: Sh-1:500	Tiranë 2021 PL-01

PLANIMETRIA E RRUGES

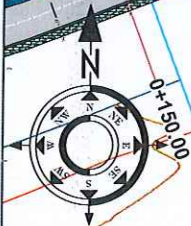
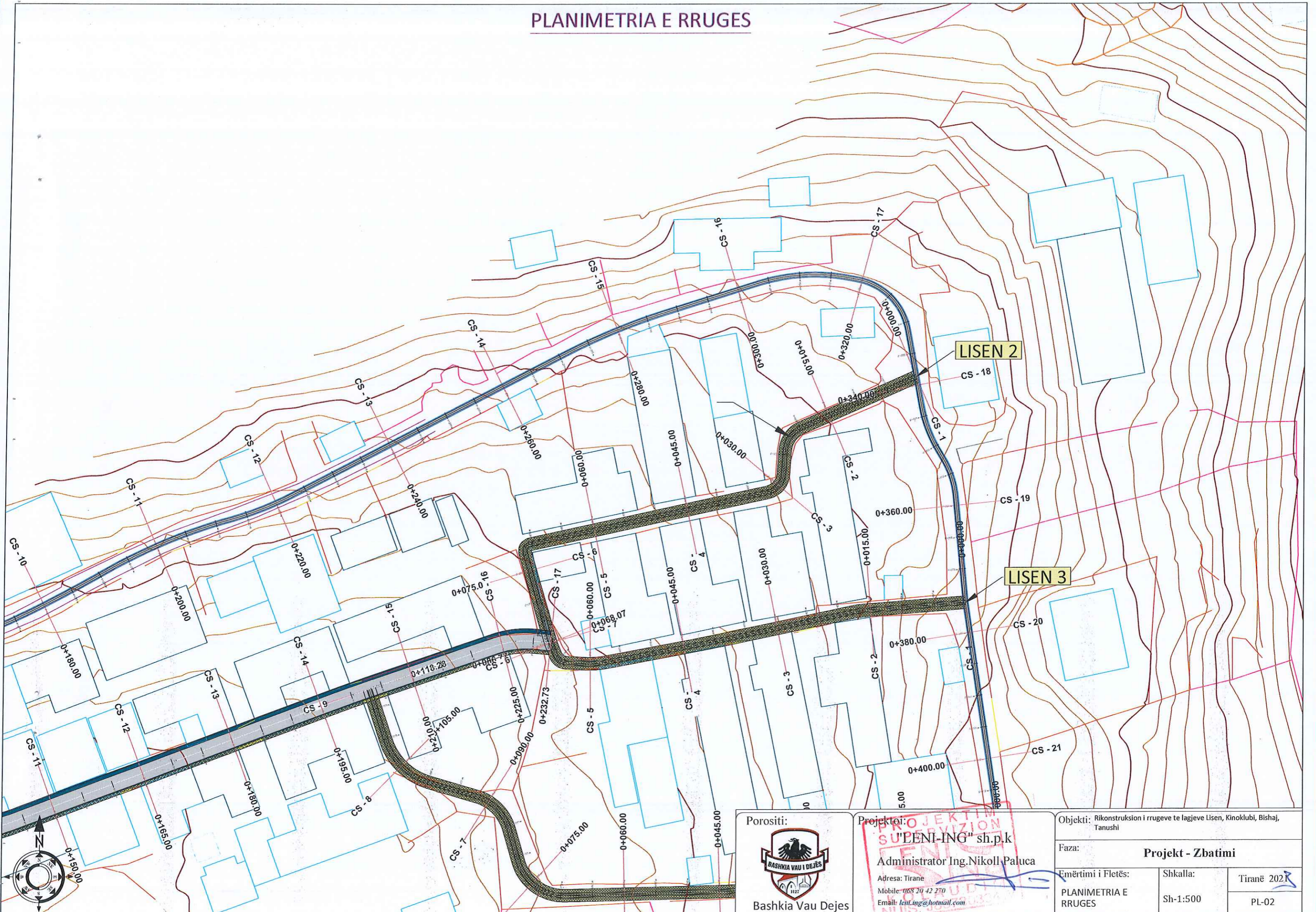

Porositi:



Bashkia Vau Dejës

Projektori:

"SUP'LENI-ING" sh.p.k

Administrator Ing. Nikoll Paluca

Adresa: Tirane

Mobile: 068 20 42 270

Email: leni_ing@hotmail.com

Objekti: Rikonstrukcion i rrugeve te lagjeve Lisen, Kinoklubi, Bishaj, Tanushi		
Faza:	Projekt - Zbatimi	
Emërtimi i Fletës:	Shkalla:	Tiranë 2021
PLANIMETRIA E RRUGES	Sh-1:500	PL-02

PLANIMETRIA E RRUGES

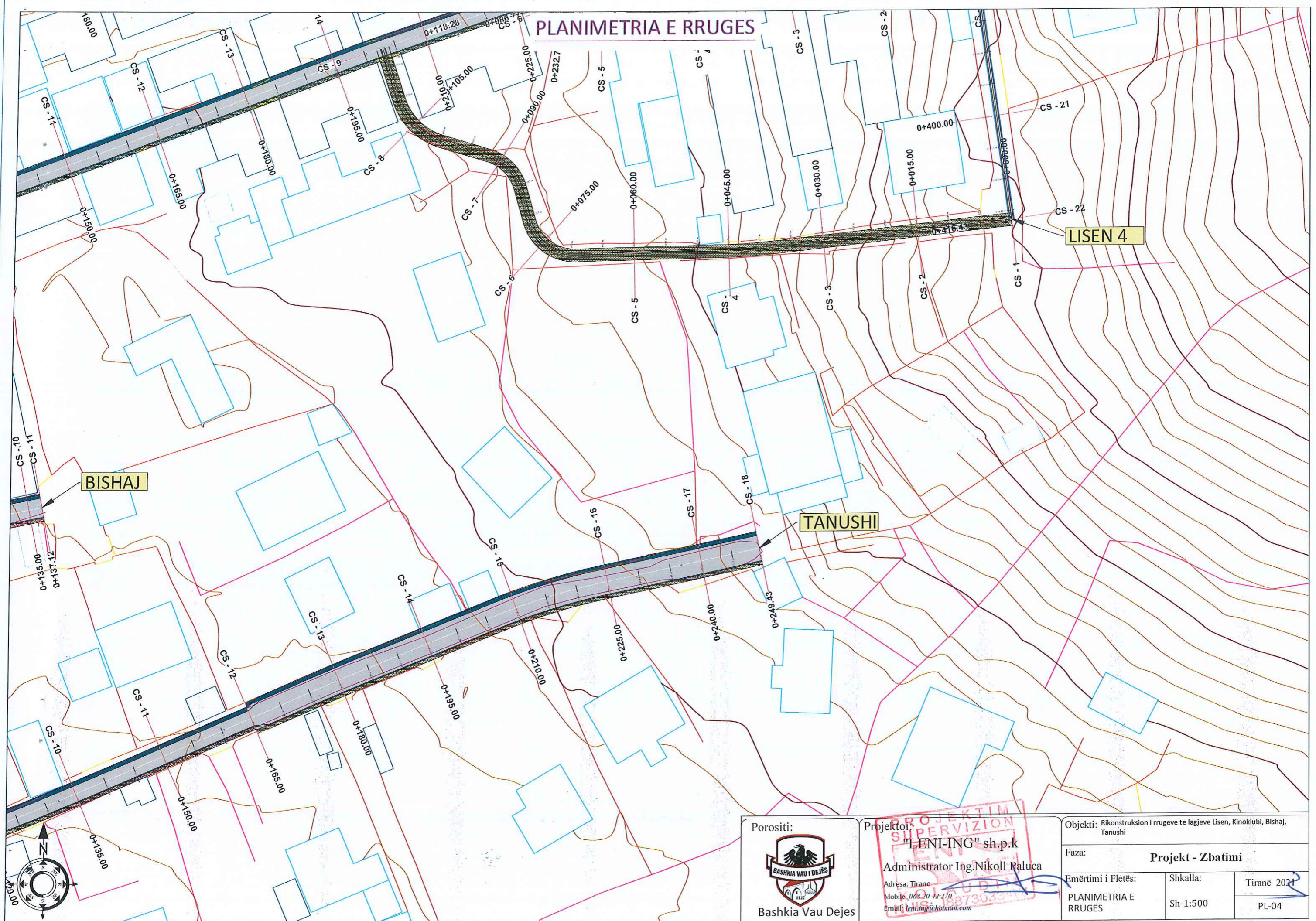

BISHAJ

TANUSHI

LISEN 4

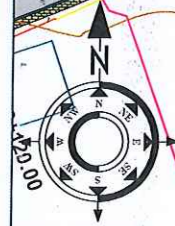

Porositi:



Bashkia Vau Dejës

Projektor:

"LENI-ING" sh.p.k

Administrator Ing. Nikoll Raluca

Adresa: Tirane
 Mobile: 068 20 42 270
 Email: leni.ing@hotmail.com

Objekti: Rikonstrukcion i rrugeve te lagjeve Lisen, Kinoklubi, Bishaj, Tanushi		
Faza:		Projekt - Zbatimi
Emërtimi i Fletës:	Shkalla:	Tiranë 2021
PLANIMETRIA E RRUGES	Sh-1:500	PL-04

PROFILI GJATESORE

PROFILI GJATESOR
AKSI I RRUGES LISEN I
SH_H - 1:1000
SH_V - 1:200

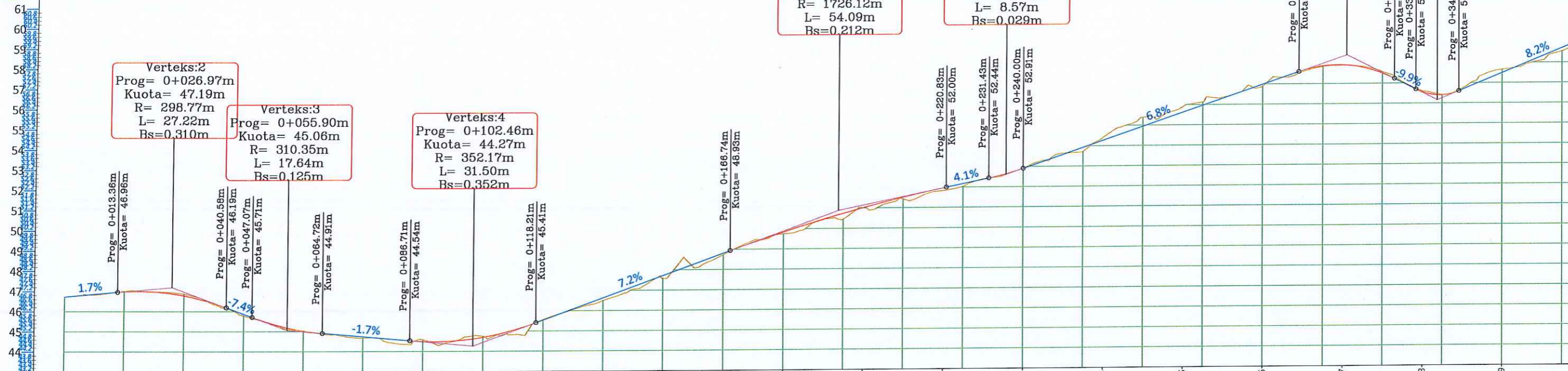

NR I PRERJES	CS - 1	CS - 2	CS - 3	CS - 4	CS - 5	CS - 6	CS - 7	CS - 8	CS - 9	CS - 10	CS - 11	CS - 12	CS - 13	CS - 14	CS - 15	CS - 16	CS - 17	CS - 18	CS - 19	
DIST. PJESORE	20.0 m	20.0 m	20.0 m	20.0 m	20.0 m	20.0 m	20.0 m	20.0 m	20.0 m	20.0 m	20.0 m	20.0 m	20.0 m	20.0 m	20.0 m	20.0 m	20.0 m	20.0 m	20.0 m	
DIST. PROGRESIVE	+0+000	+0+020	+0+040	+0+060	+0+080	+0+100	+0+120	+0+140	+0+160	+0+180	+0+200	+0+220	+0+240	+0+260	+0+280	+0+300	+0+320	+0+340	+0+360	
KUOTA TOKES	46.73	47.01	46.16	45.03	44.56	44.67	45.57	46.83	48.26	49.75	51.03	51.84	52.91	54.40	55.90	56.88	57.91	56.59	57.65	
KUOTA PROJEKTTIT	46.73	47.00	46.23	45.03	44.65	44.56	45.54	46.99	48.44	49.84	51.02	51.97	52.91	54.27	55.63	56.99	57.93	56.56	57.49	
KUOTA PUNES	0.00	-0.01	0.07	0.00	0.09	-0.11	-0.03	0.16	0.18	0.09	-0.01	0.13	0.00	-0.13	-0.27	0.10	0.02	-0.04	-0.16	
GJEO. VERTIKALE	L=13.36 i=1.73%	R=298.77 K=27.22 i=-7.38%	R=310.35 K=17.64 L=21.99 i=-1.70%	R=352.17 K=31.50 L=48.53 i=7.25%	R=1726.12 K=54.09 L=1126.41 i=4.72%	R=319.47 K=8.57 L=69.04 i=6.80%	R=143.47 K=23.98 L=12.24 i=10.74%	R=59.34 K=10.74 L=20.05 i=17.23%	L=40.71 i=8.18%											
GJEO. HORIZONTALE	L=13.96	φ=98°07'04" L=30.82 R=18.00		L=82.51		φ=40°12'13" L=28.07 R=40.00	φ=8°31'56" L=29.78 R=200.00	φ=13°55'24" L=20.66 R=85.00	φ=11°26'41" L=11.99 R=50.00	L=48.02	φ=10°02'13" L=17.52 R=100.00	L=15.09	φ=27°14'03" L=14.55 R=30.00	φ=60°34'30" L=11.97 R=10.00	φ=12°24' L=7.61 R=14.00	φ=20°05'25" L=16.18 R=20.00	φ=17°23' L=16.45 R=14.00	φ=3°00' L=0.3		
KILOMETRAZHI	-0.01		0.05		0.10		0.15		0.20		0.25		0.30		0.35		0.40		0.45	

Porositi:



Bashkia Vau Dejës

Projektor:

"LENI-ING" sh.p.k

Administrator Ing. Nikoll Paluca

Adresa: Tirane

Mobile: 068 20 42 270

Email: leni.ing@hotmail.com

Objekti: Rikonstrukjon i rrugeve te lagjeve Lisen, Kinoklubi, Bishaj, Tanushi

Faza: **Projekt - Zbatimi**

Emërtimi i Fletës: Shkalla: Tiranë 2024

PROFILI GJATESORE ShH-1:1000 ShV-1:200 PGI-01

PROFILI GJATESORE

PROFILI GJATESOR
AKSI I RRUGES LISEN 1
SH_H - 1:1000
SH_V - 1:200

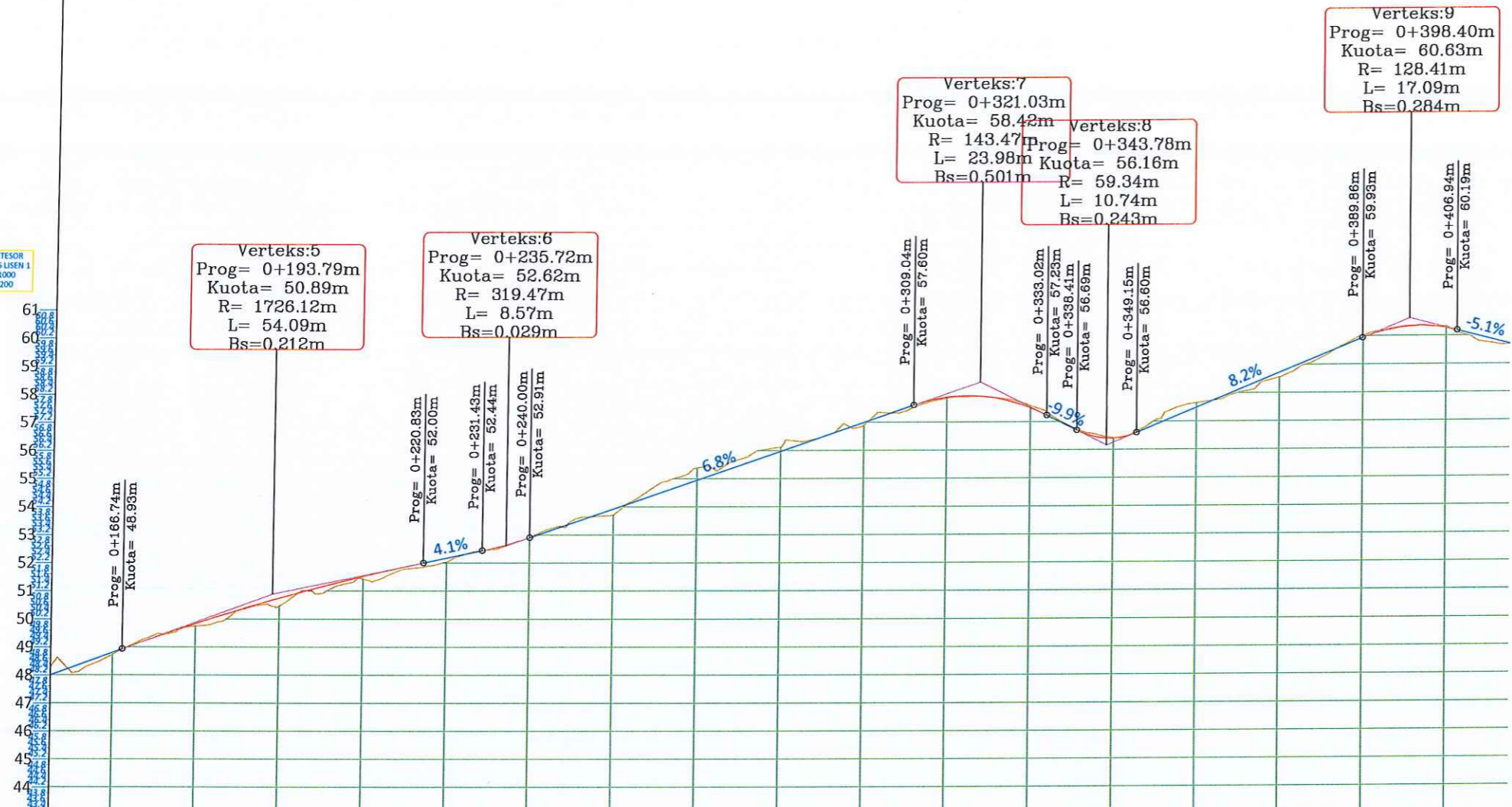

NR I PRERJES	CS - 9	CS - 10	CS - 11	CS - 12	CS - 13	CS - 14	CS - 15	CS - 16	CS - 17	CS - 18	CS - 19	CS - 20	CS - 21	CS - 22
DIST. PJESORE	20.0 m	20.0 m	20.0 m	20.0 m	20.0 m	20.0 m	20.0 m	20.0 m	20.0 m	20.0 m	20.0 m	20.0 m	16.4 m	
DIST. PROGRESIVE	0+160	0+180	0+200	0+220	0+240	0+260	0+280	0+300	0+320	0+340	0+360	0+380	0+400	0+416
KUOTA TOKES	48.26	49.75	51.03	51.84	52.91	54.40	55.90	56.88	57.91	56.59	57.65	59.01	60.35	59.70
KUOTA PROJEKTI	48.44	49.84	51.02	51.97	52.91	54.27	55.63	56.99	57.93	56.56	57.49	59.12	60.36	59.70
KUOTA PUNES	0.18	0.09	-0.01	0.13	0.00	-0.13	-0.27	-0.10	0.02	-0.04	-0.16	0.11	0.00	0.00
GJEO. VERTIKALE			R = 1726.12 K = 54.09	L = 10.60 i = 4.12%	R = 319.47 K = 8.57	L = 69.04 i = 6.80%		R = 143.47 K = 23.98	i = -9.32%	R = 59.34 K = 10.74	L = 40.71 i = 8.18%		R = 128.41 K = 17.09	L = 9.48 i = -5.1%
GJEO. HORIZONTALE	L = 5.80 φ = 8°31'56" R = 200.00	L = 0.16 φ = 13°55'24" R = 85.00	L = 20.66 φ = 11°26'4" R = 50.00	L = 0.95 φ = 11°26'4" R = 50.00	L = 48.02	L = 17.52 φ = 10°02'13" R = 100.00	L = 15.09	L = 14.55 φ = 27°47'03" R = 30.00	L = 11.97 φ = 68°34'30" R = 10.00	L = 12.24 φ = 20°03'52" R = 20.00	L = 17.23 φ = 3°00'36" R = 14.00	L = 16.45 φ = 3°00'36" R = 7.50	L = 35.72	L = 5.22
KILOMETRAZHI	0	0.05	0.10	0.15	0.20	0.25	0.30	0.35	0.40	0.45	0.50	0.55	0.60	0.63

Porositi:



Bashkia Vau Dejës

Projektori:

PROJEKTIM SUPERVIZION
"LENI-ING" sh.p.k

Administrator Ing. Nikoll Paluca

Adresa: Tirane
Mobile: 068 20 42 270
Email: leni.ing@hotmail.com

Objekti: Rikonstruksion i rrugëve të lagjeve Lisen, Kinoklubi, Bishaj, Tanushi	
Faza:	Projekt - Zbatimi
Spërtimi i Fletës:	Shkalla:
PROFILI GJATESORE LISEN	ShH-1:1000 ShV-1:200
	Tiranë 2021 PGJ-02

PROFILAT GJATESORE

PROFILI GJATESOR
AKSI I RRUGES LISEN 2
SH.H - 1:1000
SH.V - 1:200

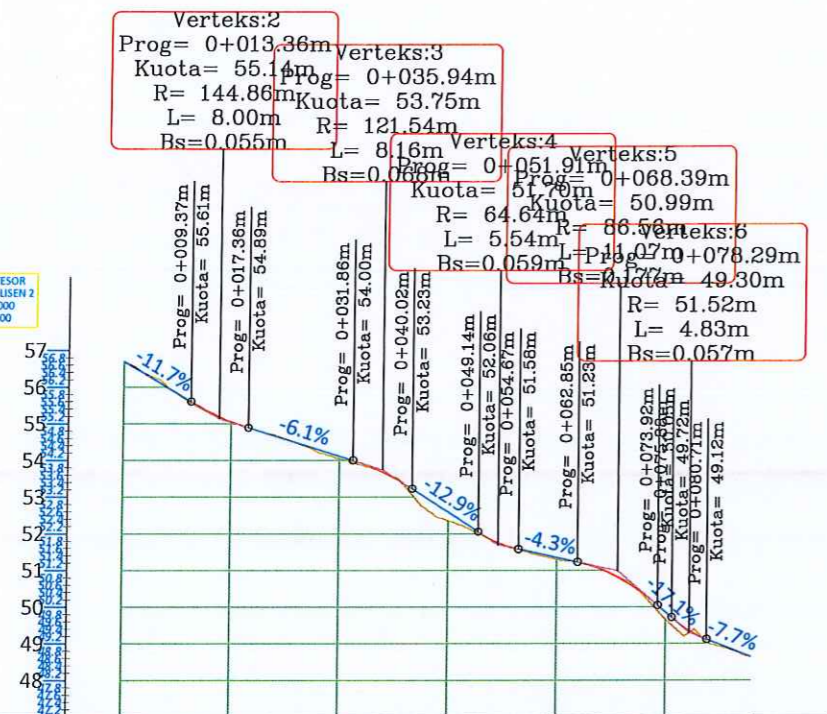

PROFILI GJATESOR
AKSI I RRUGES LISEN 3
SH.H - 1:1000
SH.V - 1:200

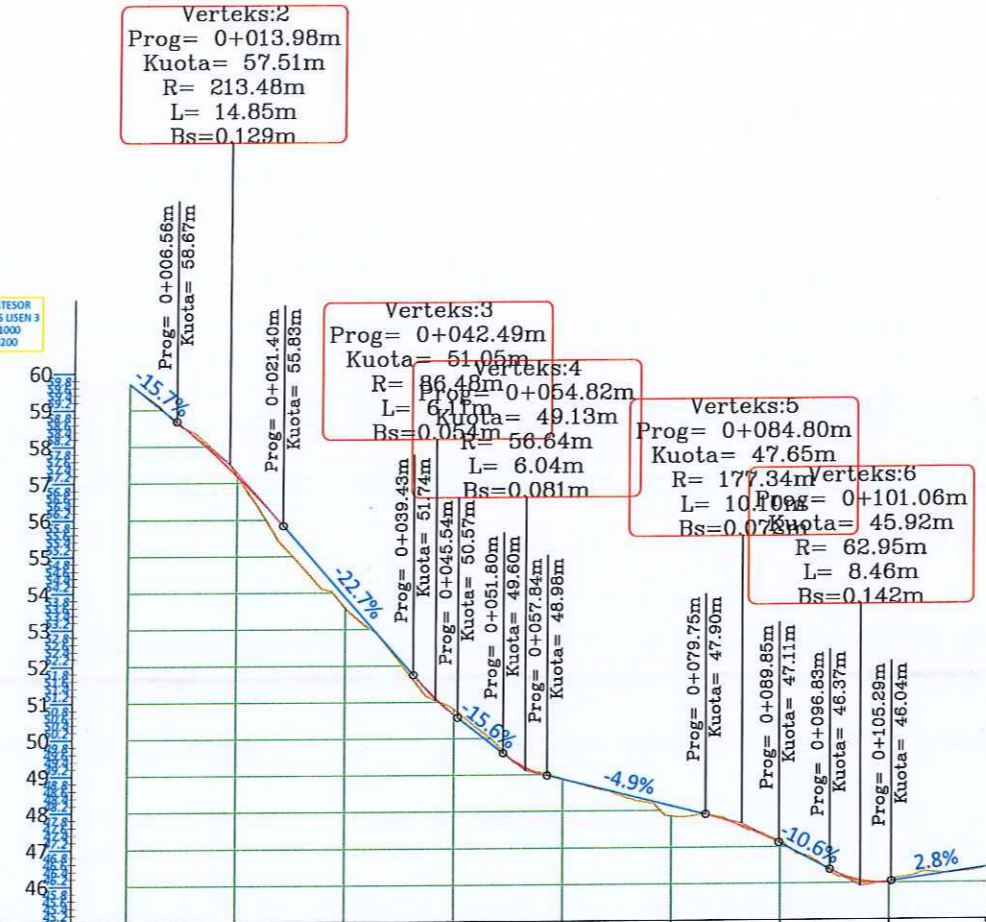

PROFILI GJATESOR
AKSI I RRUGES LISEN 4
SH.H - 1:1000
SH.V - 1:200

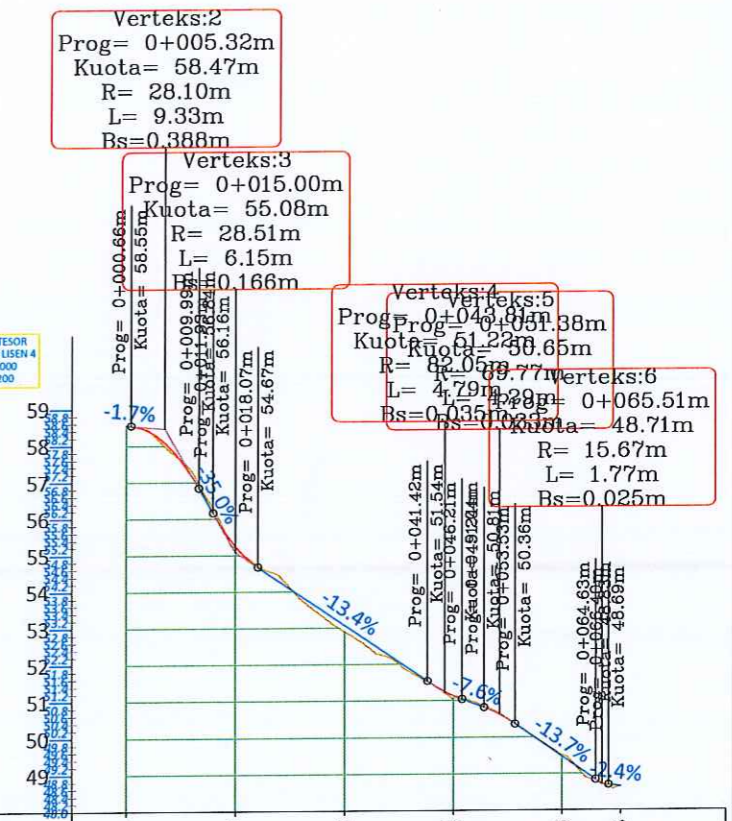

NRI PRERJES	CS-1	CS-2	CS-3	CS-4	CS-5	CS-6	CS-7	
DIST. PJESORE	15.0 m	15.0 m	15.0 m	15.0 m	15.0 m	11.8 m		
DIST. PROGRESIVE	+0+000	+0+015	+0+030	+0+045	+0+060	+0+075	+0+087	
KUOTA TOKES	56.70	55.05	54.05	52.36	51.31	49.66	48.65	
KUOTA PROJEKTTIT	56.70	55.06	54.12	52.59	51.35	49.86	48.65	
KUOTA PUNES	0.00	0.01	0.07	0.23	0.05	0.20	0.00	
GJEO. VERTIKALE	i = -11.66% R = 144.85 K = 8.00	i = -6.14% R = 121.54 K = 8.16	i = -12.48% R = 64.64 K = 5.54	i = -4.29% R = 86.56 K = 11.67	i = -11.66% R = 51.52 K = 4.83	i = -11.66% R = 51.52 K = 4.83	i = -7.70% R = 51.52 K = 4.83	
GJEO. HORIZONTALE	L=19.84 φ = 62°34'37.14"	L=14.50 φ = 4°53'50"	L=38.26 φ = 94°10'27"	L=38.26 φ = 94°10'27"	L=14.70 φ = 11°02'27"	L=14.70 φ = 11°02'27"	L=14.70 φ = 11°02'27"	
KILOMETRAZHI	-0.01			0.05			0.10	

NRI PRERJES	CS-1	CS-2	CS-3	CS-4	CS-5	CS-6	CS-7	CS-8	CS-9	
DIST. PJESORE	15.0 m	15.0 m	15.0 m	15.0 m	15.0 m	15.0 m	15.0 m	13.3 m		
DIST. PROGRESIVE	+0+000	+0+015	+0+030	+0+045	+0+060	+0+075	+0+090	+0+105	+0+118	
KUOTA TOKES	59.70	57.19	53.59	50.80	48.89	47.86	47.15	46.00	46.41	
KUOTA PROJEKTTIT	59.70	57.18	53.88	50.66	48.87	48.13	47.10	46.04	46.41	
KUOTA PUNES	0.00	-0.01	0.29	-0.14	-0.02	0.28	-0.05	0.03	0.00	
GJEO. VERTIKALE	i = -15.70% R = 213.48 K = 14.85	i = -22.65% R = 86.48 K = 6.04	i = -15.70% R = 56.64 K = 6.04	i = -4.92% R = 177.34 K = 10.10	i = -10.60% R = 62.95 K = 8.46	i = -10.60% R = 62.95 K = 8.46	i = -2.82% R = 54.59 K = 4.83	i = 2.82% R = 54.59 K = 4.83	i = 2.82% R = 54.59 K = 4.83	
GJEO. HORIZONTALE	L=37.68 φ = 4°53'50"	L=23.09 φ = 75°10'34"	L=23.09 φ = 75°10'34"	L=23.09 φ = 75°10'34"	L=8.56 φ = 54°59'35"	L=8.56 φ = 54°59'35"	L=8.56 φ = 54°59'35"	L=8.56 φ = 54°59'35"	L=8.56 φ = 54°59'35"	
KILOMETRAZHI	-0.01		0.03		0.06		0.09		0.12	

NRI PRERJES	CS-1	CS-2	CS-3	CS-4	CS-5	CS-6	
DIST. PJESORE	15.0 m	15.0 m	15.0 m	15.0 m	8.1 m		
DIST. PROGRESIVE	+0+000	+0+015	+0+030	+0+045	+0+060	+0+068	
KUOTA TOKES	58.56	55.21	52.90	51.06	49.51	48.65	
KUOTA PROJEKTTIT	58.56	55.25	53.07	51.14	49.47	48.65	
KUOTA PUNES	0.00	0.04	0.17	0.08	-0.04	0.00	
GJEO. VERTIKALE	i = -12.74% R = 28.10 K = 9.33	i = -13.40% R = 28.51 K = 6.15	i = -13.40% R = 28.51 K = 6.15	i = -7.70% R = 82.06 K = 4.79	i = -13.70% R = 15.67 K = 1.77	i = -13.70% R = 15.67 K = 1.77	
GJEO. HORIZONTALE	L=16.31 φ = 71°24'59"	L=20.79 φ = 11°18'04"	L=20.79 φ = 11°18'04"	L=14.54 φ = 130°09'41.36"	L=14.54 φ = 130°09'41.36"	L=14.54 φ = 130°09'41.36"	
KILOMETRAZHI	-0.01		0.03		0.06	0.10	

Porositi:

Bashkia Vau Dejës

Projektoi:

PROJEKTIM INZHINIERI
"LENING" sh.p.k

Administrator Ing. Nikoll Paluca

Adresa: Tirane
Mobile: 068 20 42 270
Email: len.ing@hotmail.com

NIJIS: J83/30334W

Objekti: Rikonstruksion i rrugëve të lagjeve Lisen, Kinoklubi, Bishaj, Tanushi

Faza: **Projekt - Zbatimi**

Emërtimi i Fletës:	Shkalla:	Tiranë 2021
PROFILI GJATESORE LISEN	ShH-1:1000 ShV-1:200	PGJ-03

PROFILAT TERTHORE

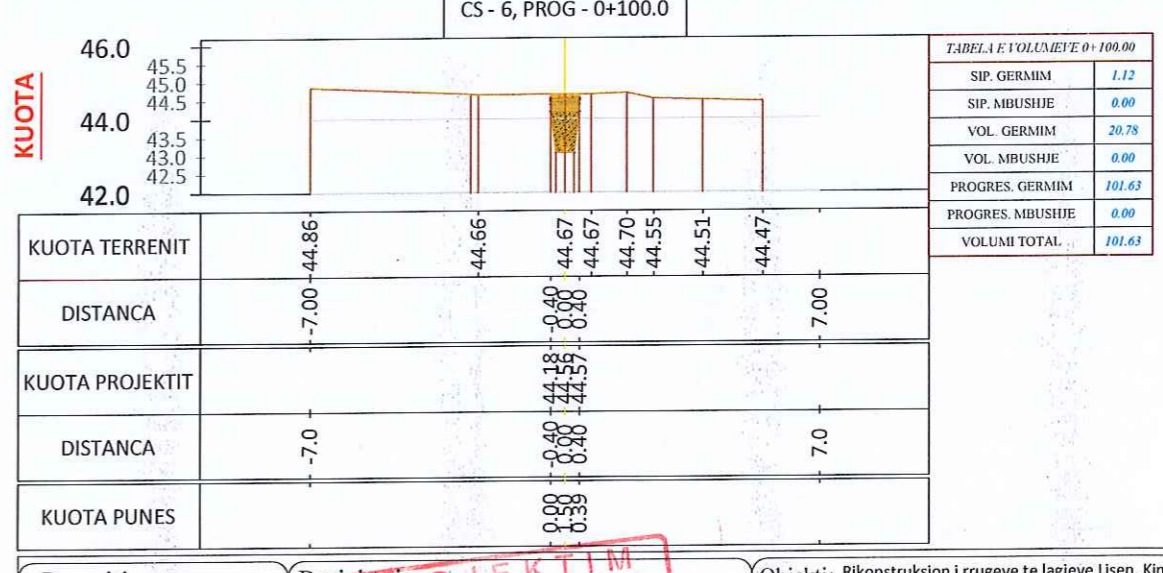
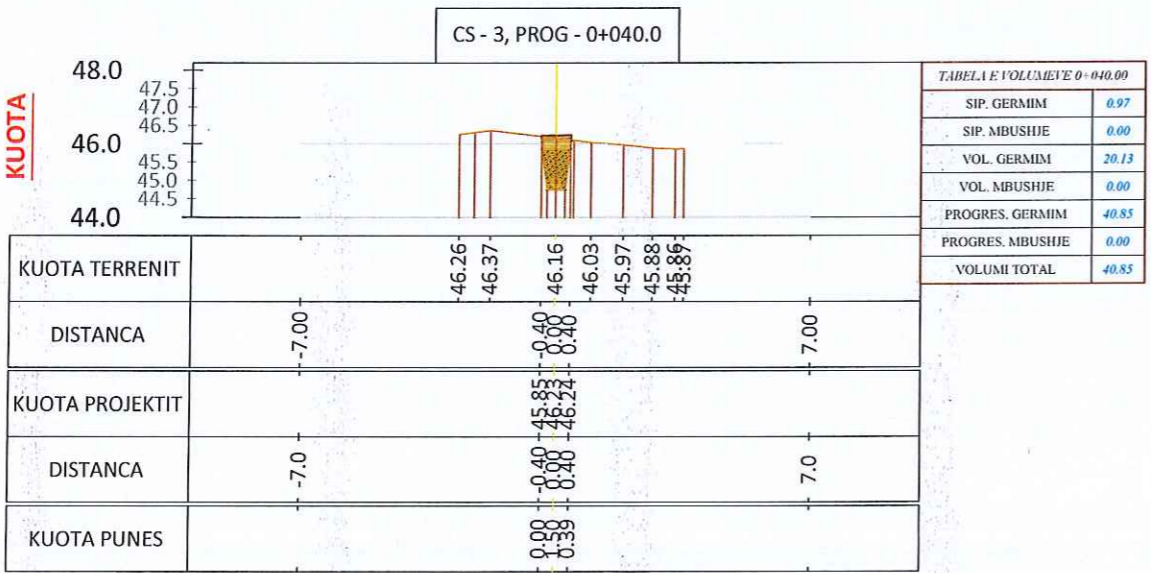
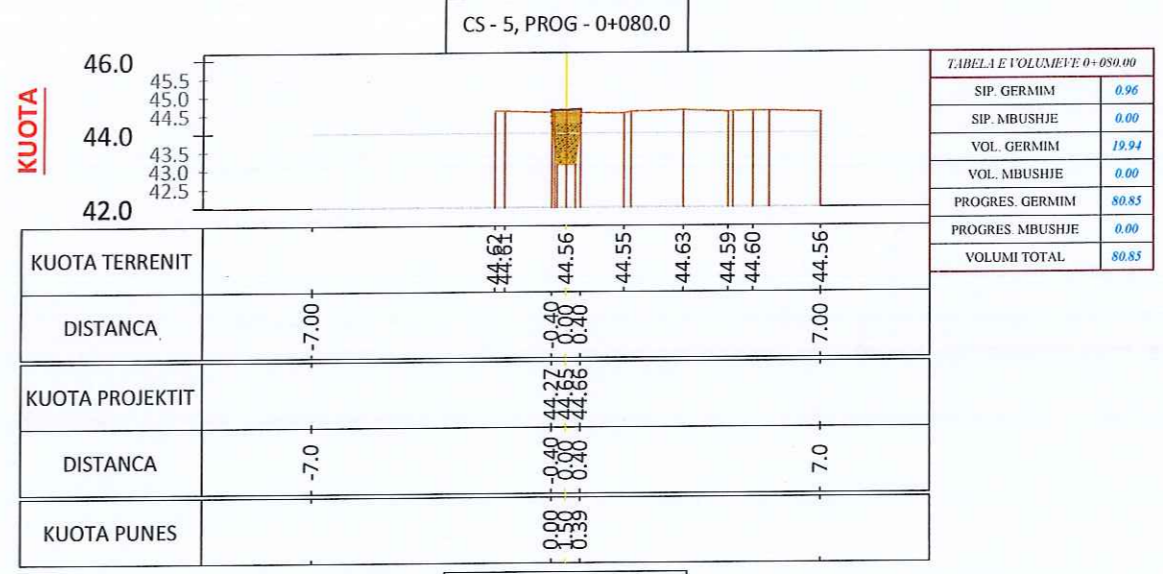
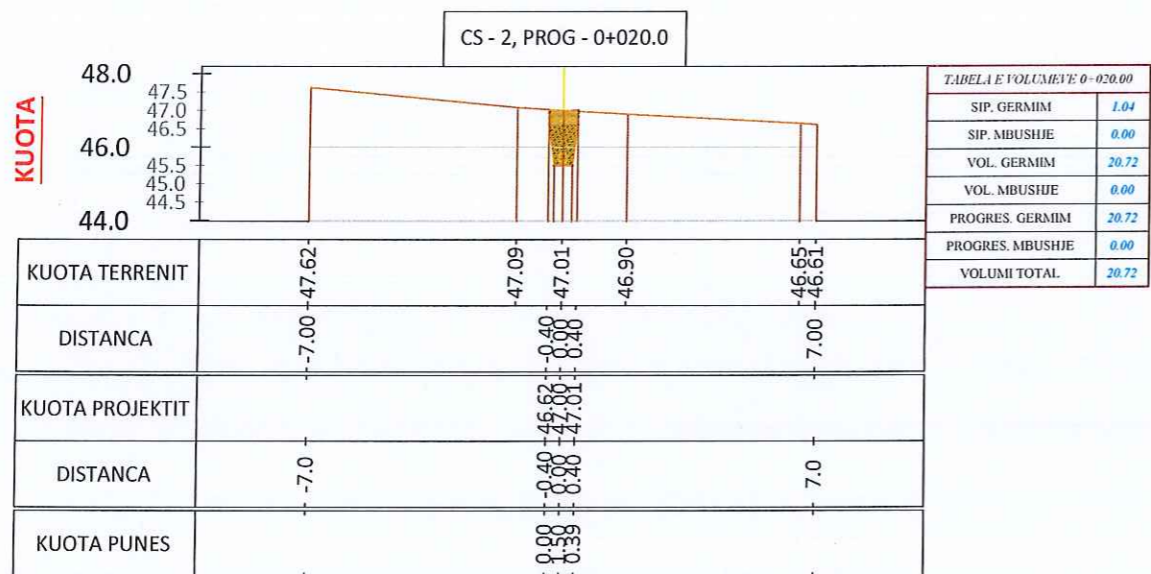
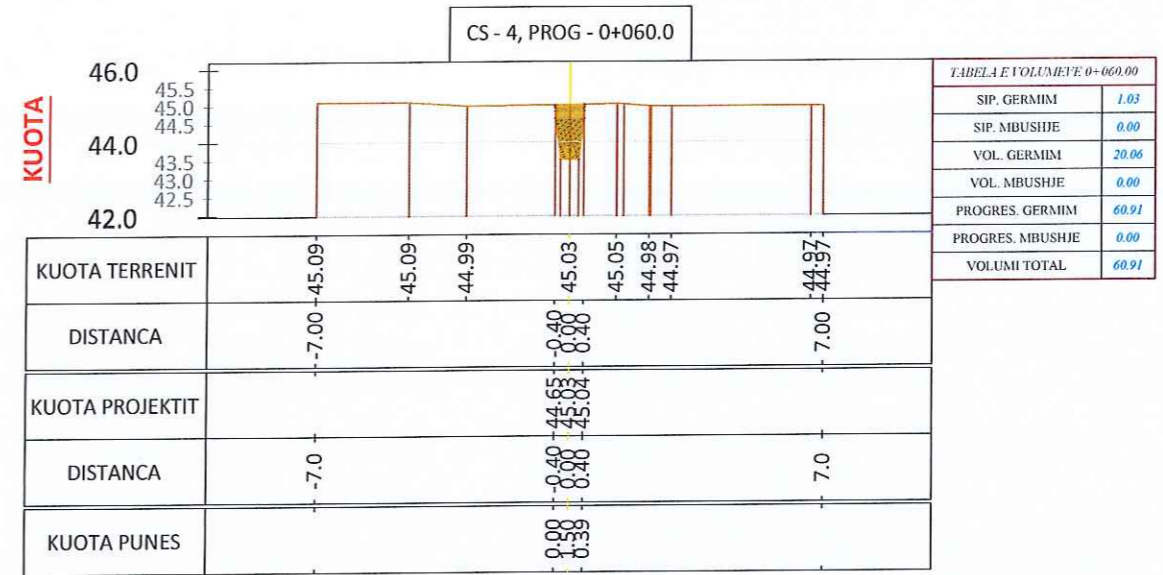
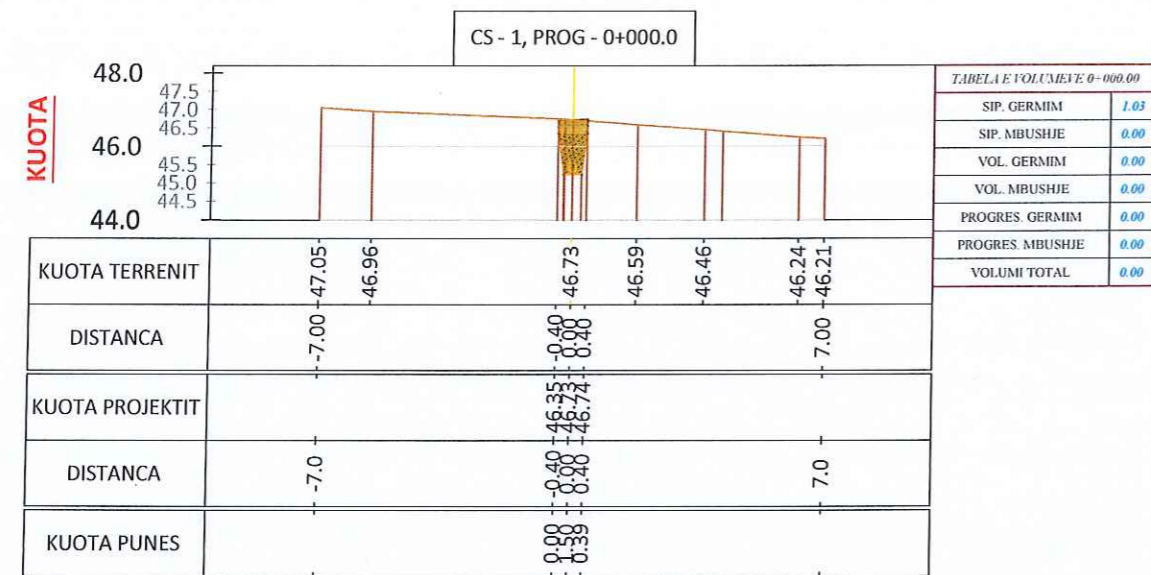

Porositi:  Bashkia Vau Dejës	Projektor:  Administrator Ing. Nikoll Paluca Adresa: Tirane Mobile: 068 20 42 270 Email: leni.ing@hotmail.com	Objekti: Rikonstrukcion i rrugeve te lagjeve Lisen, Kinoklubi, Bishaj, Tanushi Faza: Projekt - Zbatimi Emërtimi i Fletës: PROFILAT TERTHORE LISEN Shkalla: Sh-1:200 Tiranë 2021 PT-01
---	---	---

PROFILAT TERTHORE

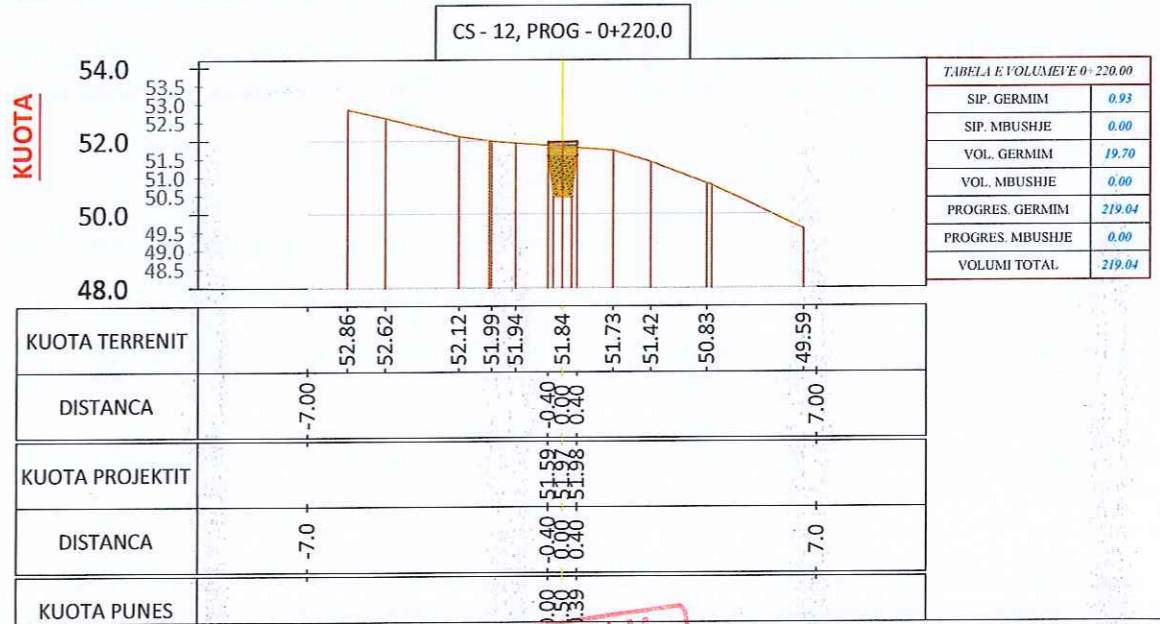
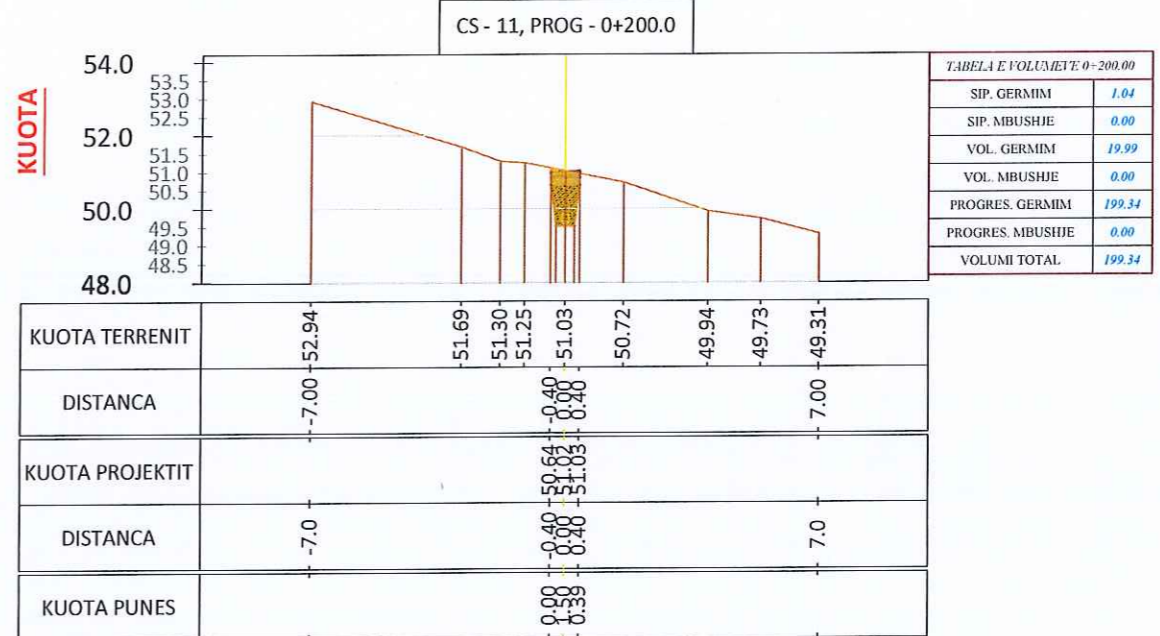
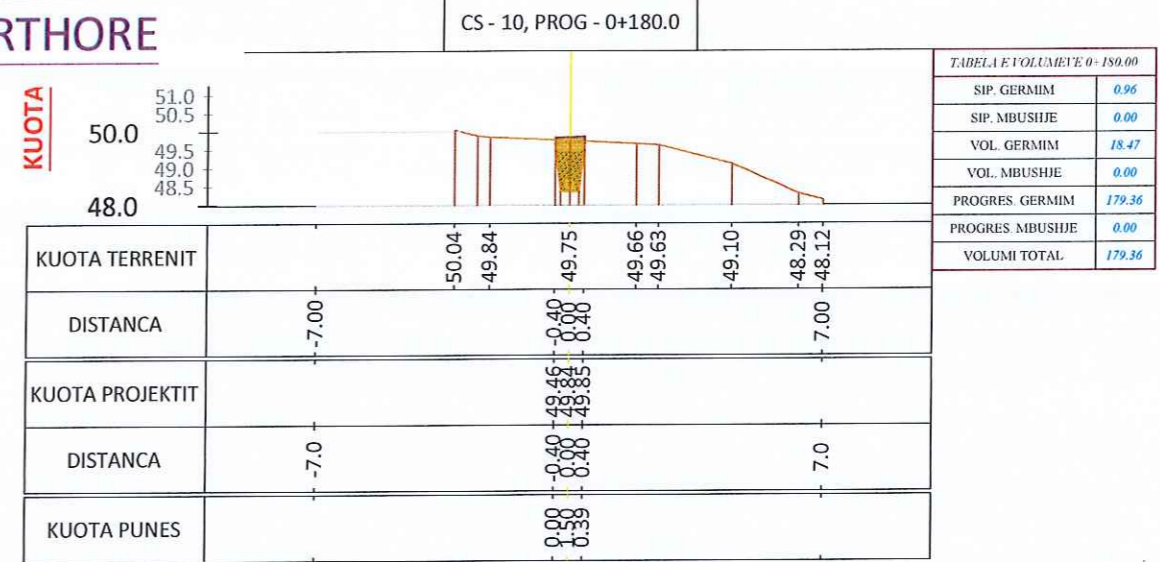
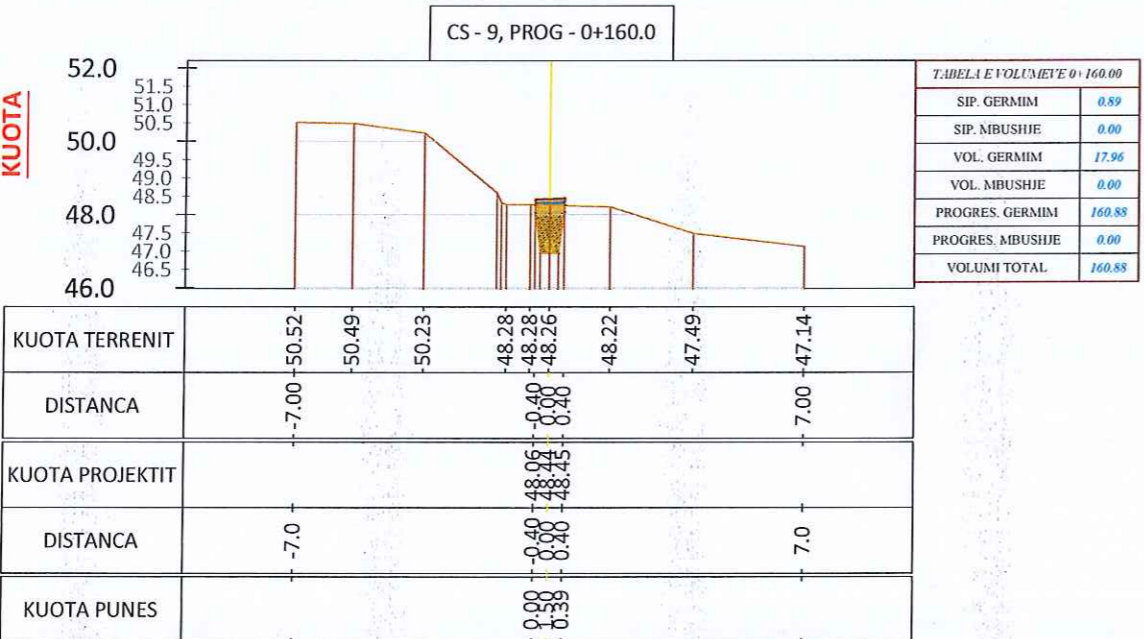
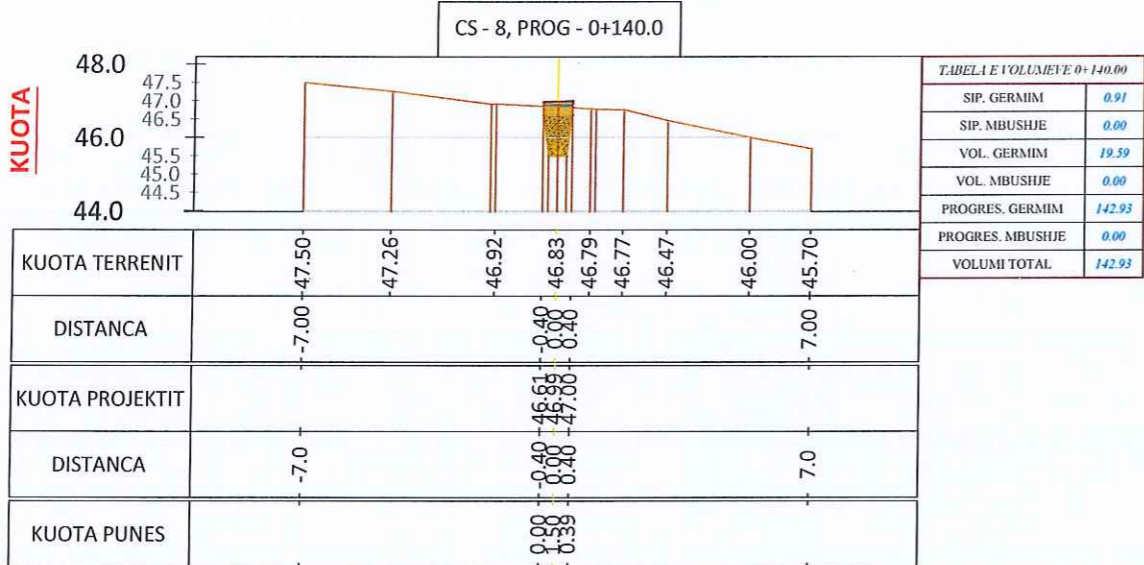
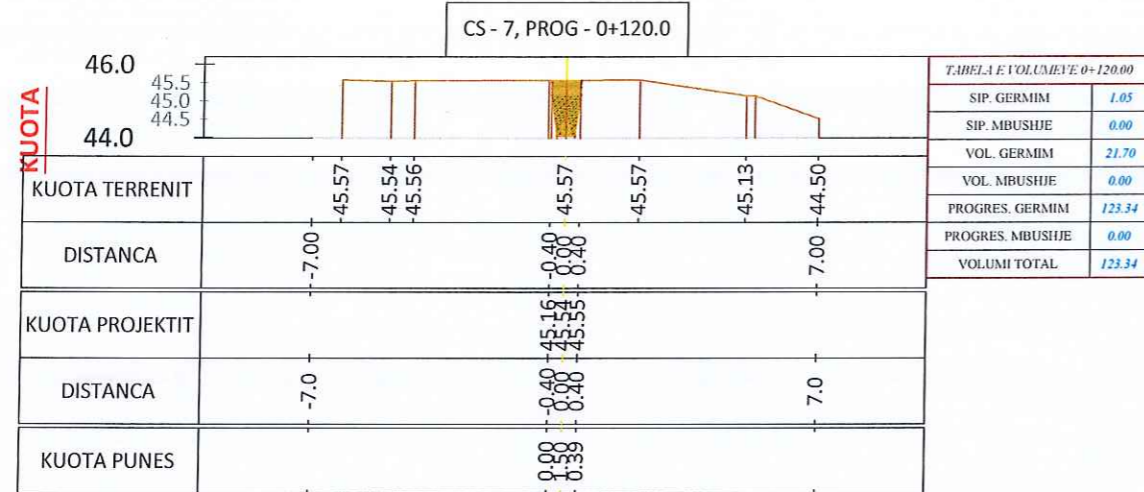

Porositi:

Projektori: "LENING" sh.p.k
Administrator Ing. Nikoll Paluca
Adresa: Tirane
Mobile: 068 20 22 270
Email: leni.ing@hotmail.com

Objekti: Rikonstruksion i rrugeve te lagjeve Lisen, Kinoklubi, Bishaj, Tanushi

Faza: **Projekt - Zbatimi**

Emërtimi i Fletës: PROFILAT TERTHORE LISEN

Shkalla: Sh-1:200

Tiranë 2021
PT-02

PROFILAT TERTHORE

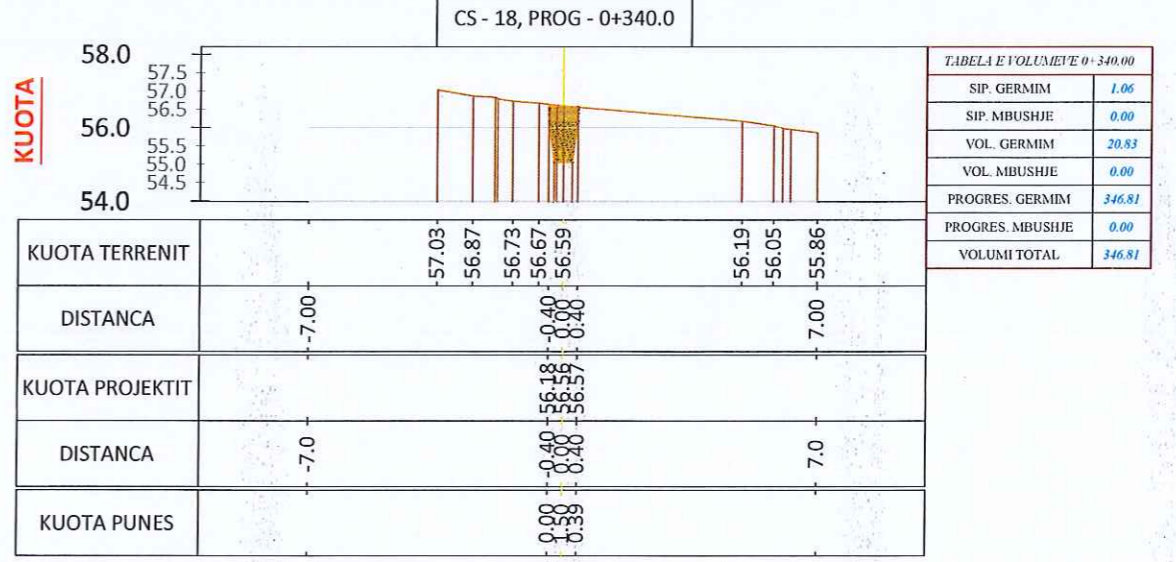
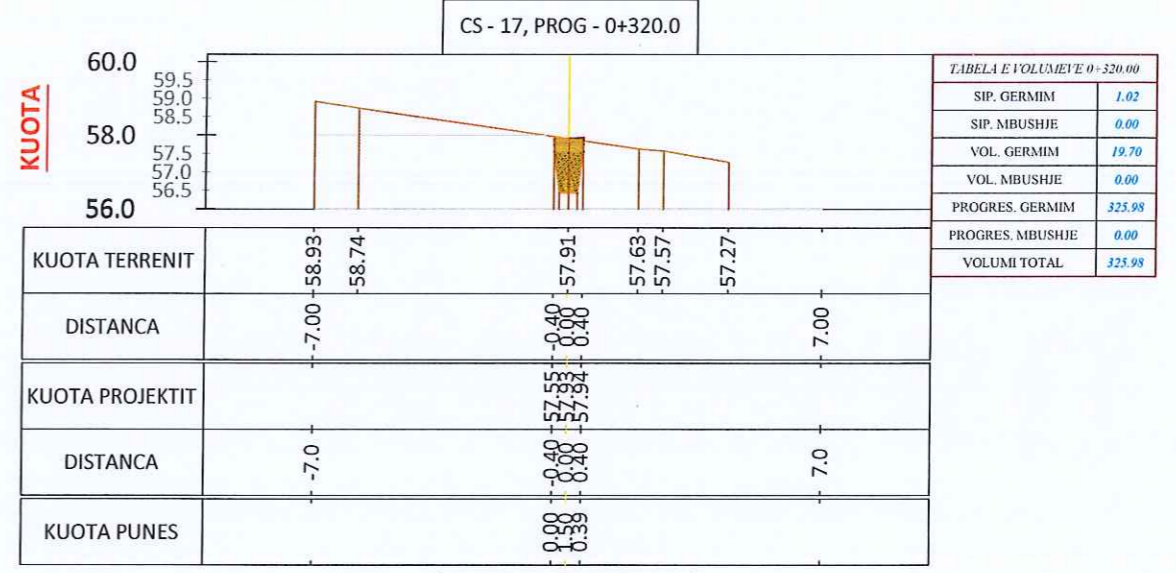
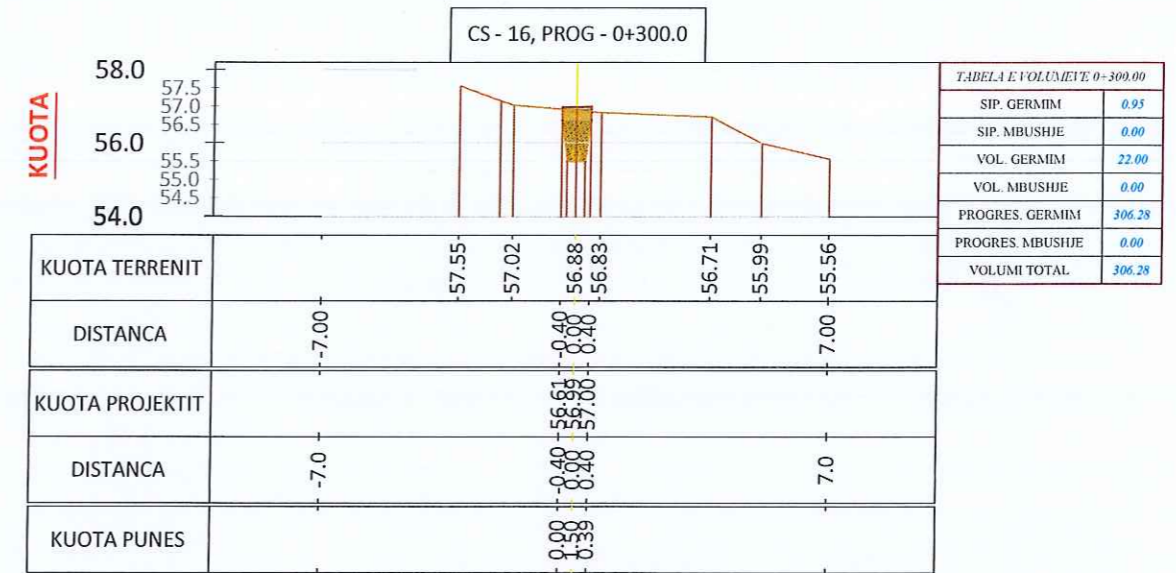
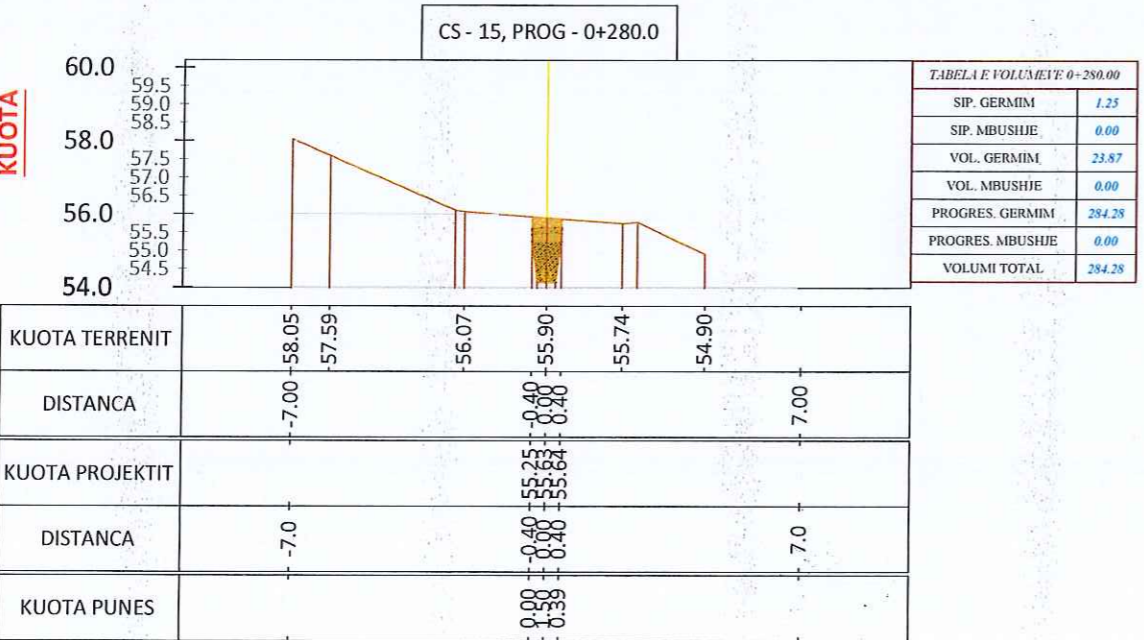
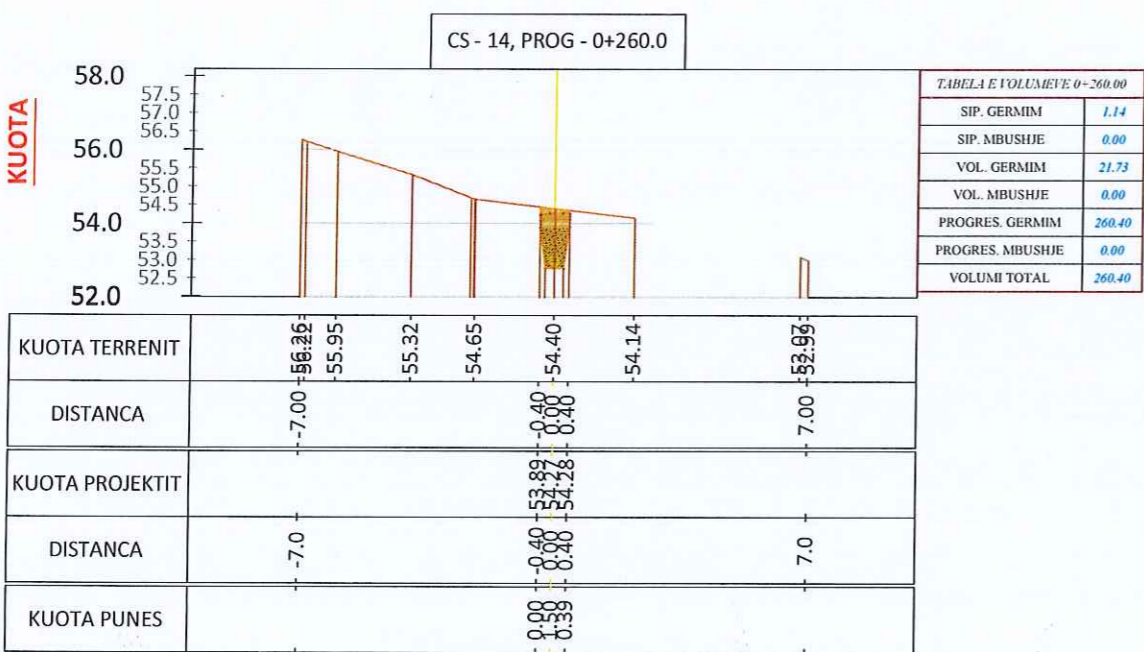
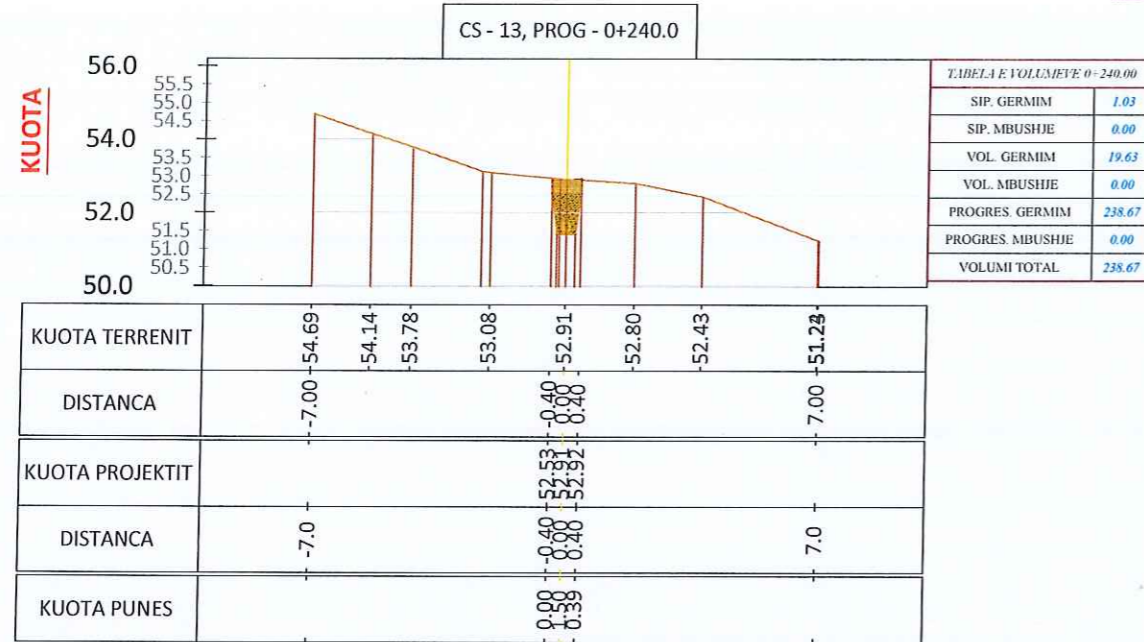

Porositi: Bashkia Vau Dejës	Projektoji: "LENI-ING" sh.p.k Administrator Ing. Nikoll Paluca Adresa: Tirane Mobile: 068 20 42 270 Email: leni.ing@hotmail.com	Objekti: Rikonstruksion i rrugëve te lagjeve Lisen, Kinoklubi, Bishaj, Tanushi	Faza:
		Projekt - Zbatimi	
Emërtimi i Fletës: PROFILAT TERTHORE LISEN		Shkalla: Sh-1:200	Tiranë 2023 PT-03

PROFILAT TERTHORE

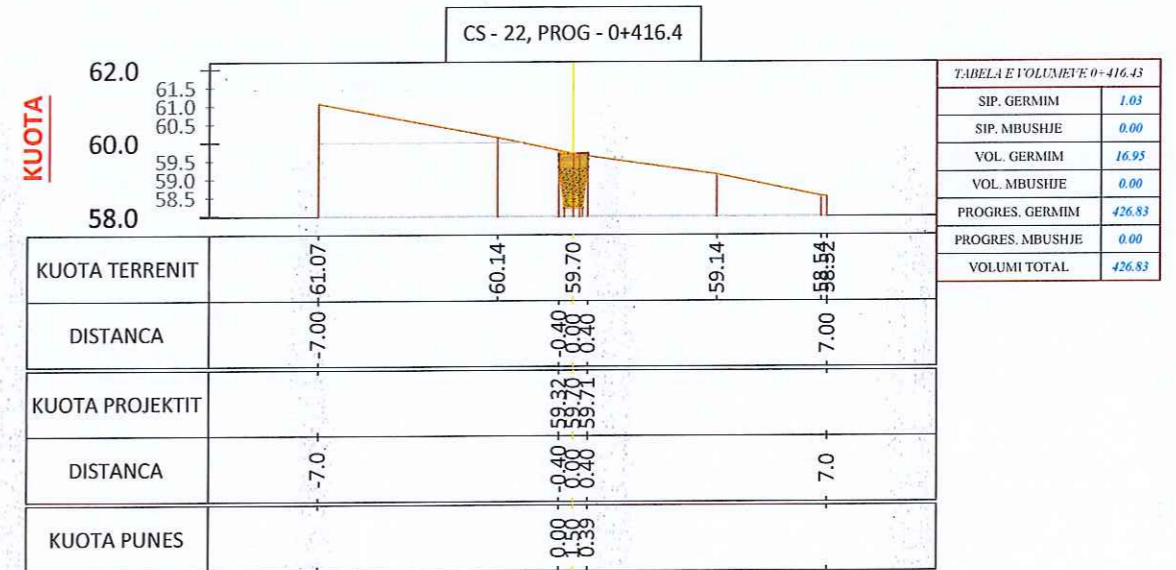
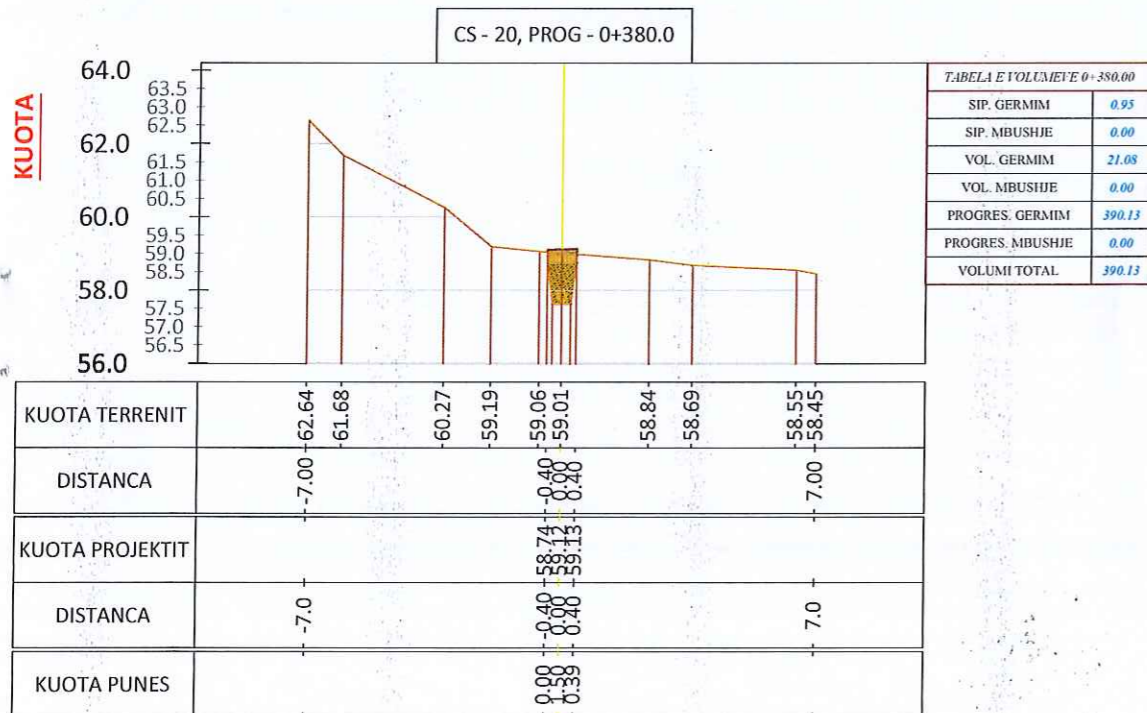
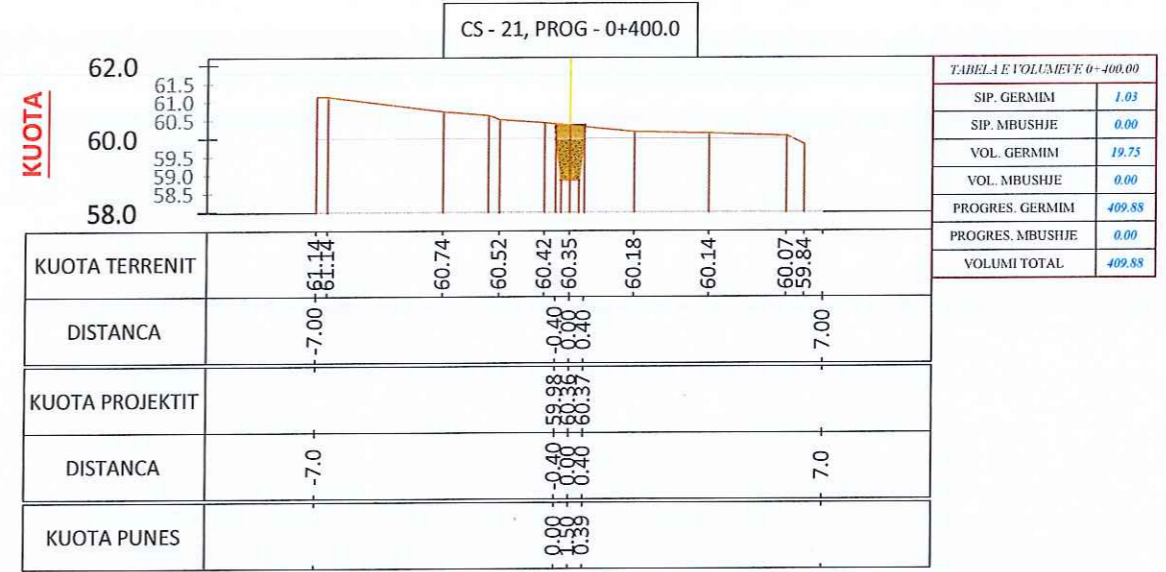
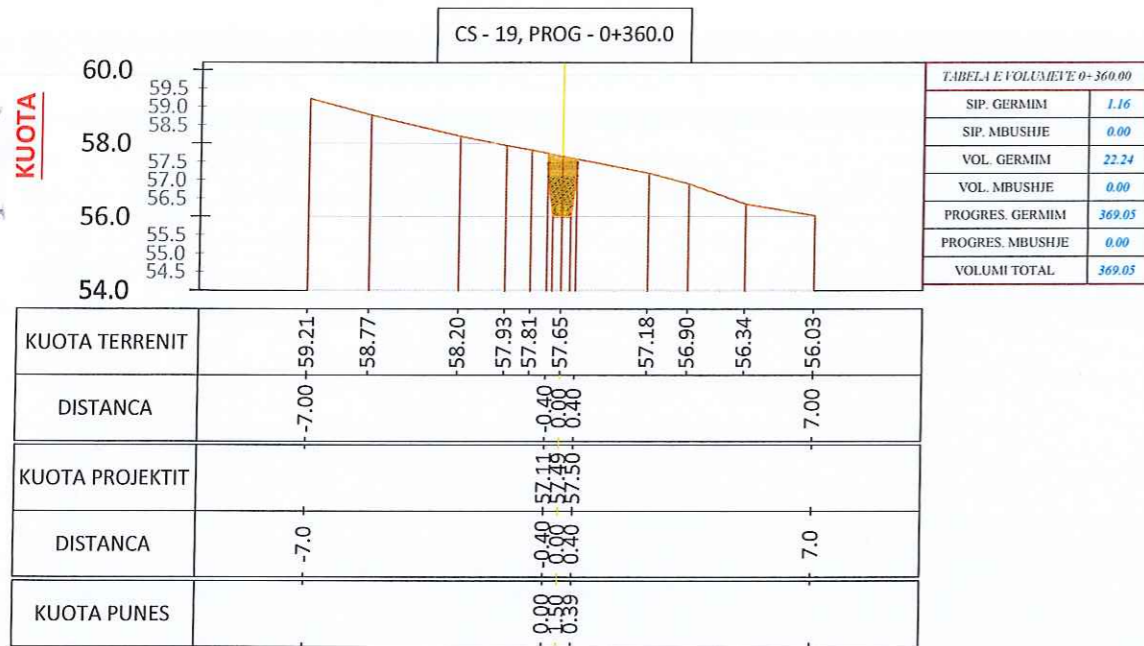

Porositi:  Bashkia Vau Dejes	Projektoi:  Administrator Ing. Nikoll Paluca Adresa: Tirane Mobile: 068 20 42 270 Email: lenj.ing@hotmail.com	Objekti: Rikonstruksion i rrugeve te lagjeve Lisen, Kinoklubi, Bishaj, Tanushi Faza: Projekt - Zbatimi Emërtimi i Fletës: PROFILAT TERTHORE LISEN Shkalla: Sh-1:200 Tiranë 2023 PT-04
---	---	--

TABELA E VOLUMEVE

TABELA VOLUMEVE							
PROGRESIVA	SIP. GERMIM	SIP. MBUSHJE	VOL. GERMIM	VOL. MBUSHJE	G. PROGRESIV	M. PROGRESIV	G-M
0+00.00	1.03	0.00	0.00	0.00	0.00	0.00	0.00
0+20.00	1.04	0.00	20.72	0.00	20.72	0.00	20.72
0+40.00	0.97	0.00	20.13	0.00	40.85	0.00	40.85
0+60.00	1.03	0.00	20.06	0.00	60.91	0.00	60.91
0+80.00	0.96	0.00	19.94	0.00	80.85	0.00	80.85
1+00.00	1.12	0.00	20.78	0.00	101.63	0.00	101.63
1+20.00	1.05	0.00	21.70	0.00	123.34	0.00	123.34
1+40.00	0.91	0.00	19.59	0.00	142.93	0.00	142.93
1+60.00	0.89	0.00	17.96	0.00	160.88	0.00	160.88
1+80.00	0.96	0.00	18.47	0.00	179.36	0.00	179.36
2+00.00	1.04	0.00	19.99	0.00	199.34	0.00	199.34
2+20.00	0.93	0.00	19.70	0.00	219.04	0.00	219.04
2+40.00	1.03	0.00	19.63	0.00	238.67	0.00	238.67
2+60.00	1.14	0.00	21.73	0.00	260.40	0.00	260.40
2+80.00	1.25	0.00	23.87	0.00	284.28	0.00	284.28
3+00.00	0.95	0.00	22.00	0.00	306.28	0.00	306.28
3+20.00	1.02	0.00	19.70	0.00	325.98	0.00	325.98
3+40.00	1.06	0.00	20.83	0.00	346.81	0.00	346.81
3+60.00	1.16	0.00	22.24	0.00	369.05	0.00	369.05
3+80.00	0.95	0.00	21.08	0.00	390.13	0.00	390.13
4+00.00	1.03	0.00	19.75	0.00	409.88	0.00	409.88
4+16.43	1.03	0.00	16.95	0.00	426.83	0.00	426.83

Porositi:

 Bashkia Vau Dejes

Projektoi:

 "LENI-ING" sh.p.k
 Administrator Ing. Nikoll Paluca
 Adresa: Tirane
 Mobile: 068 20 42 270
 Email: leni.ing@hotmail.com
 NUIS: JS8730334W

Objekti: Rikonstruksion i rrugeve te lagjeve Lisen, Kinoklubi, Bishaj, Tanushi
 Faza: **Projekt - Zbatimi**
 Emërtimi i Fletës: TABELA E VOLUMEVE LISEN
 Shkalla:
 Tiranë 2021
 TB-01

PROFILI GJATESORE

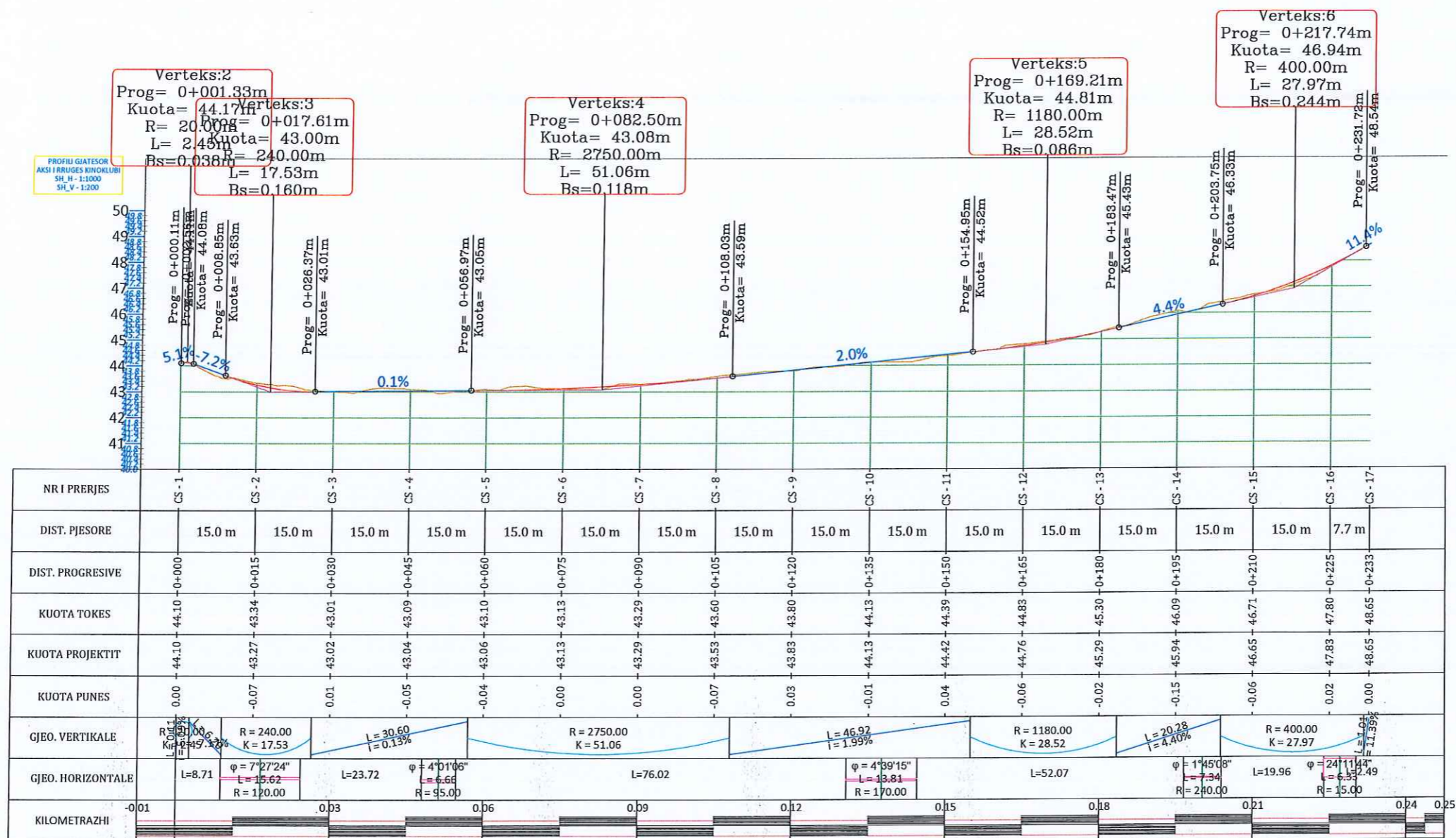

Porositi:  Bashkia Vau Dejës	Projektoi:  Administrator Ing. Nikoll Paluca Adresa: Tiranë Mobile: 068 20 42 270 Email: leni.ing@hotmail.com	Objekti: Rikonstruksion i rrugëve të lagjeve Lisen, Kinoklubi, Bishaj, Tanushi Faza: Projekt - Zbatimi Emërtimi i Fletës: PROFILI GJATESORE KINOKLUBI Shkalla: ShH-1:1000 ShV-1:200 Tiranë 2022 PGJ-04
---	---	--

PROFILAT TERTHORE

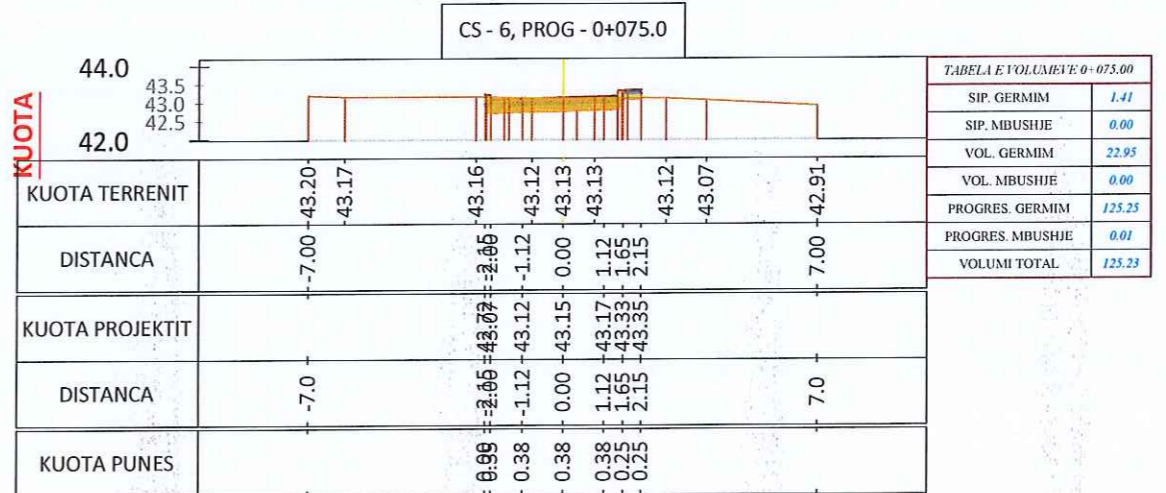
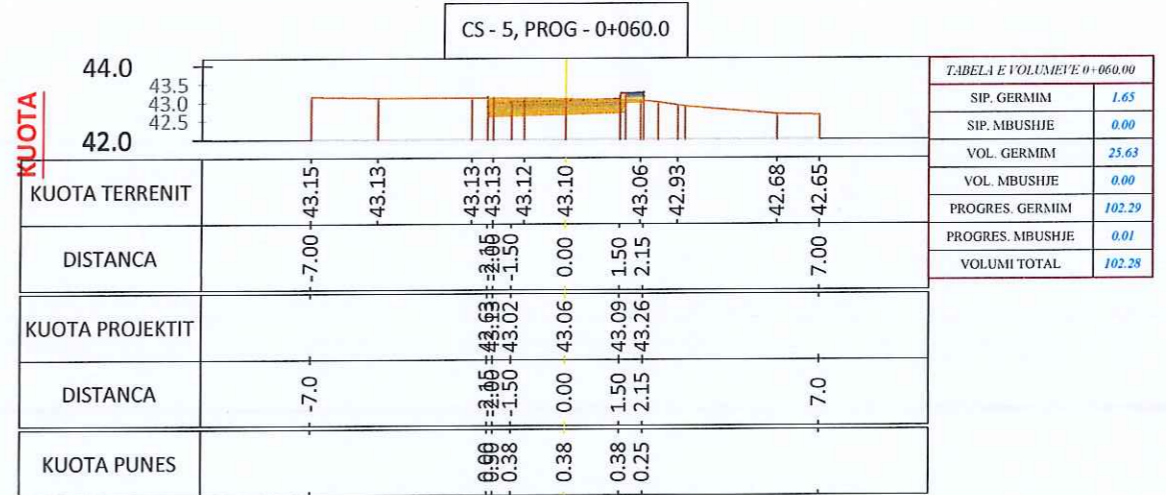
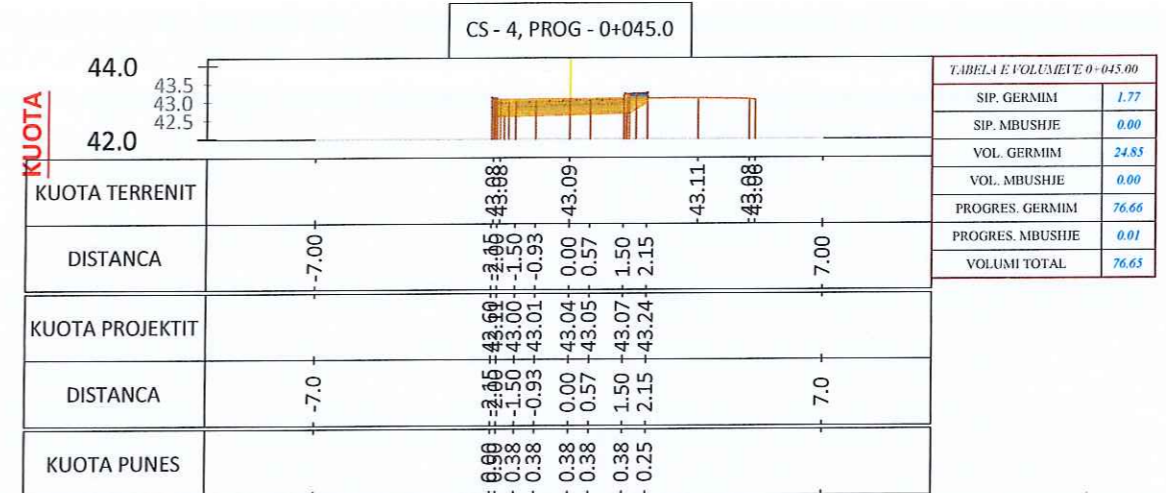
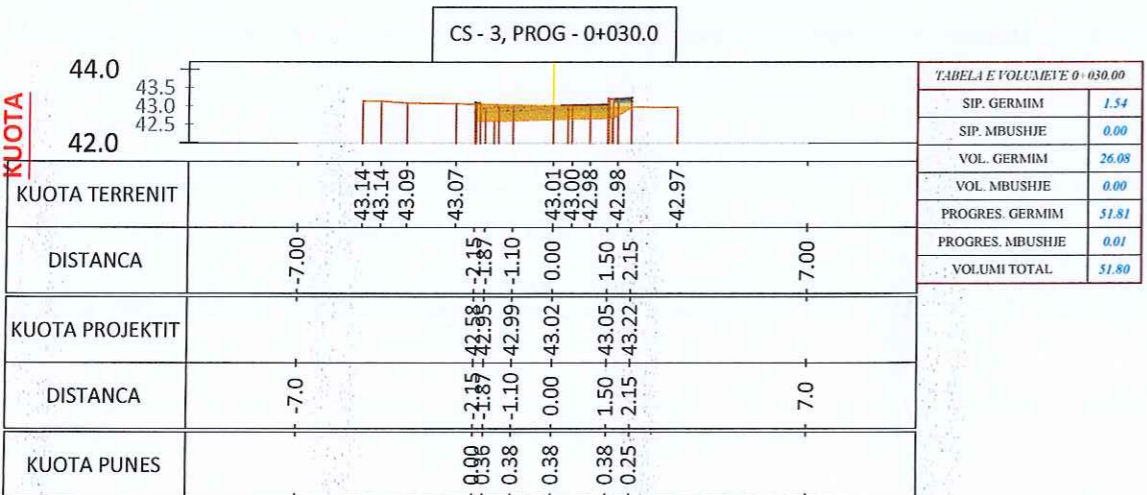
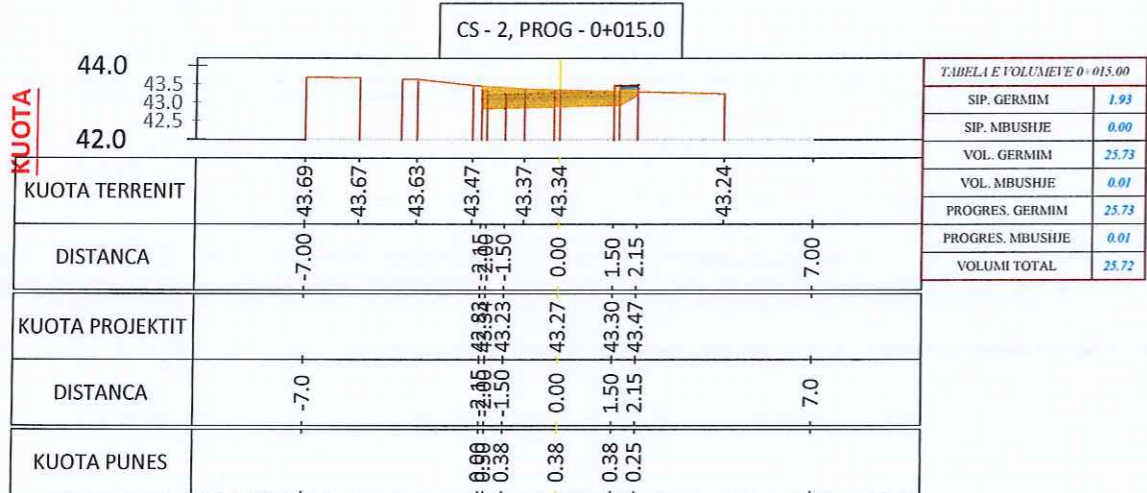
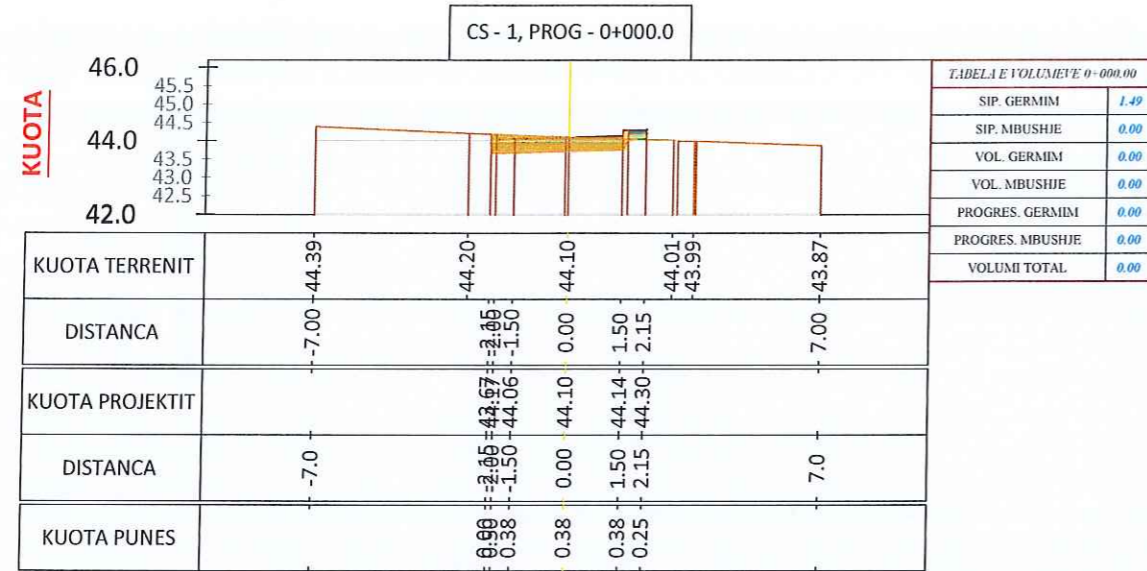

Porositi:  Bashkia Vau Dejës	Projektoi:  Administrator Ing. Nikoll Paluca Adresa: Tirane Mobile: 068 20 42 270 Email: len.ing@hotmail.com	Objekti: Rikonstruksion i rrugeve te lagjeve Lisen, Kinoklubi, Bishaj, Tanushi Faza: Projekt - Zbatimi Emërtimi i Fletës: PROFILAT TERTHORE KINOKLUBI Shkalla: Sh-1:200 Tiranë 2021 PT-05
---	--	---

PROFILAT TERTHORE

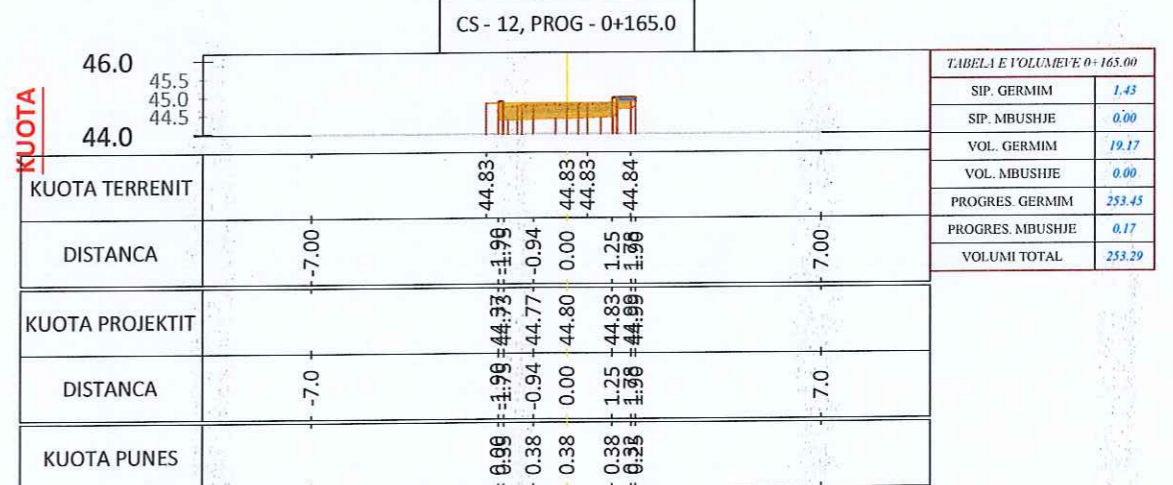
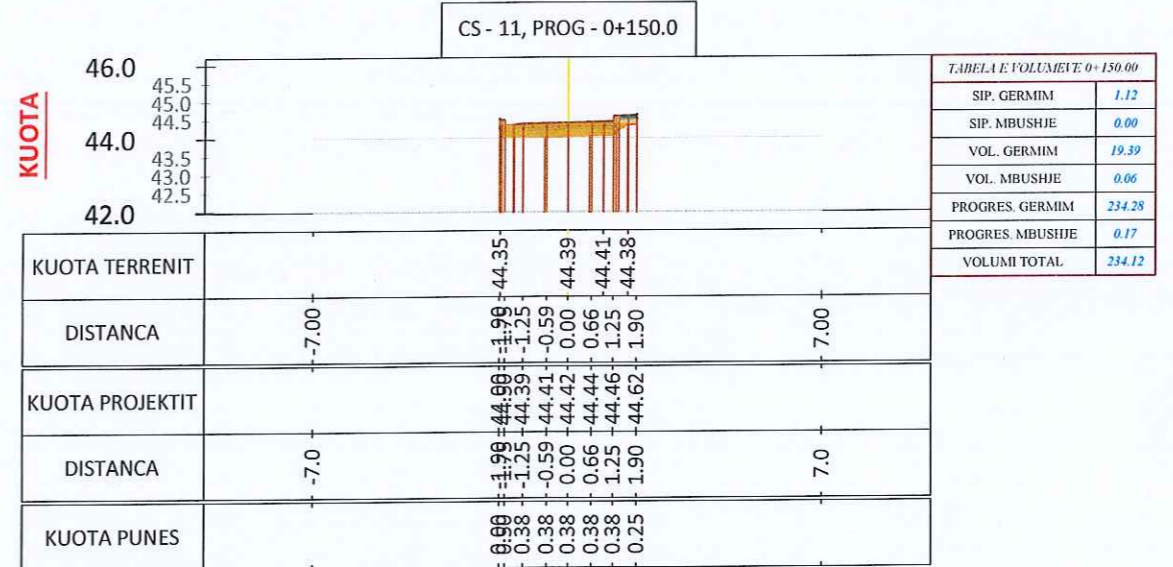
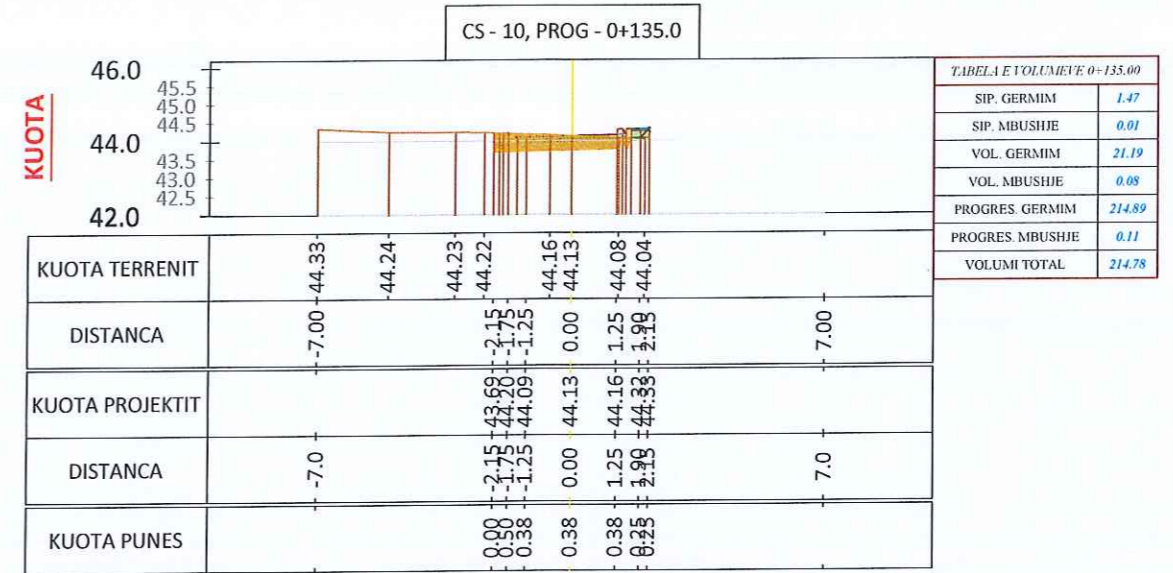
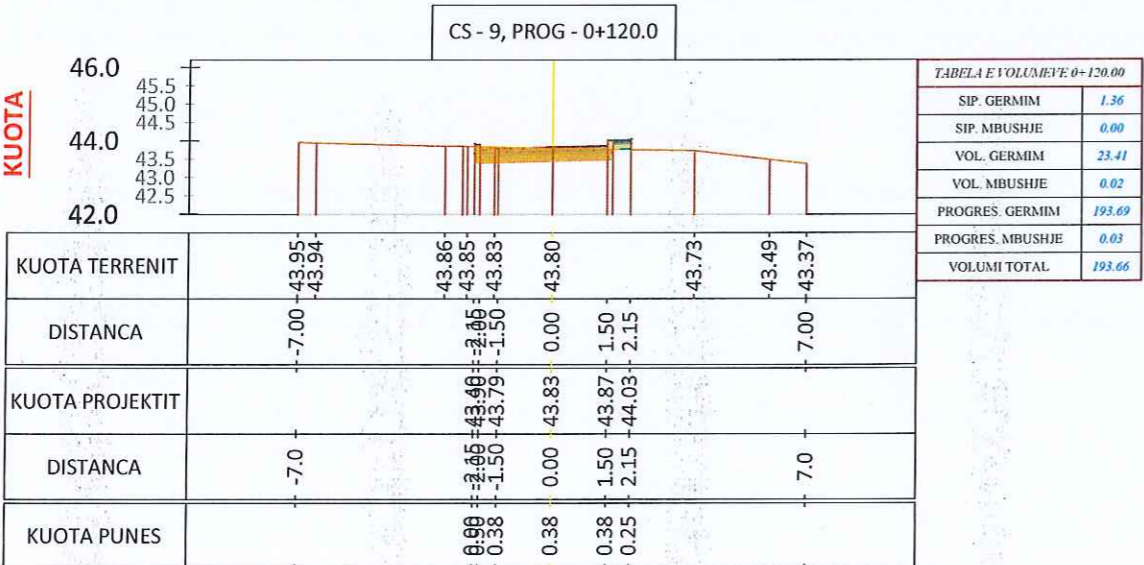
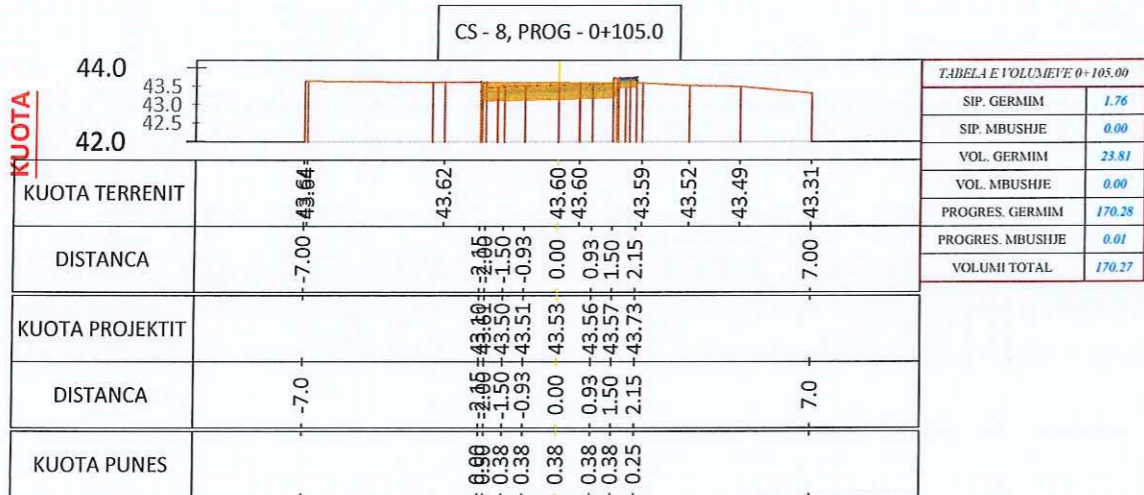
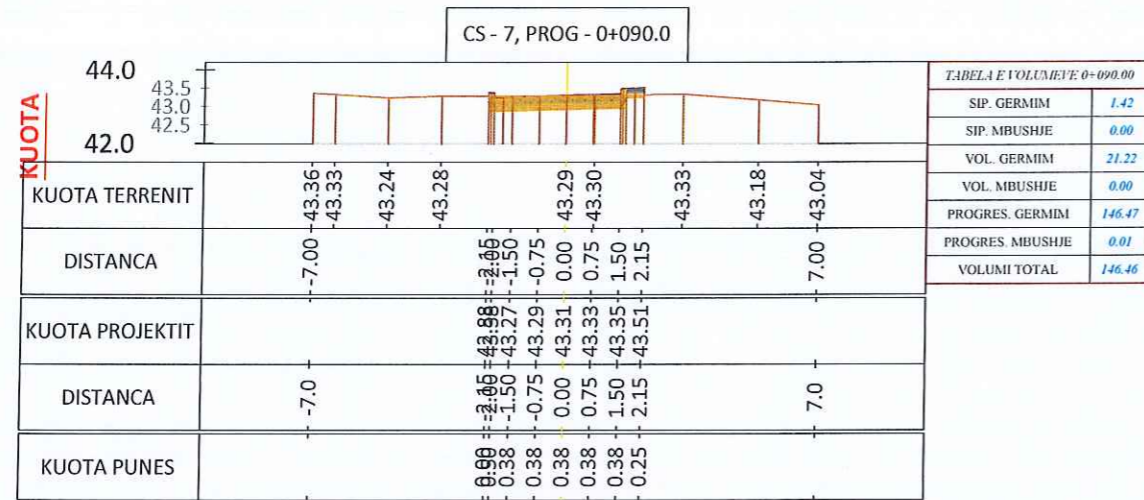

Porositi:	Projektoi:	Objekti: Rikonstrukcion i rrugëve të lagjeve Lisen, Kinoklubi, Bishaj, Tanushi	
 Bashkia Vau Dejes	"LENDING" sh.p.k Administrator Ing. Nikoll Paluca Adresa: Tirane Mobile: 068 20 42 270 Email: lenj.ing@hotmail.com	Faza:	Projekt - Zbatimi
		Emërtimi i Fletës:	Shkalla:
PROFILAT TERTHORE KINOKLUBI		Sh-1:200	PT-06

PROFILAT TERTHORE

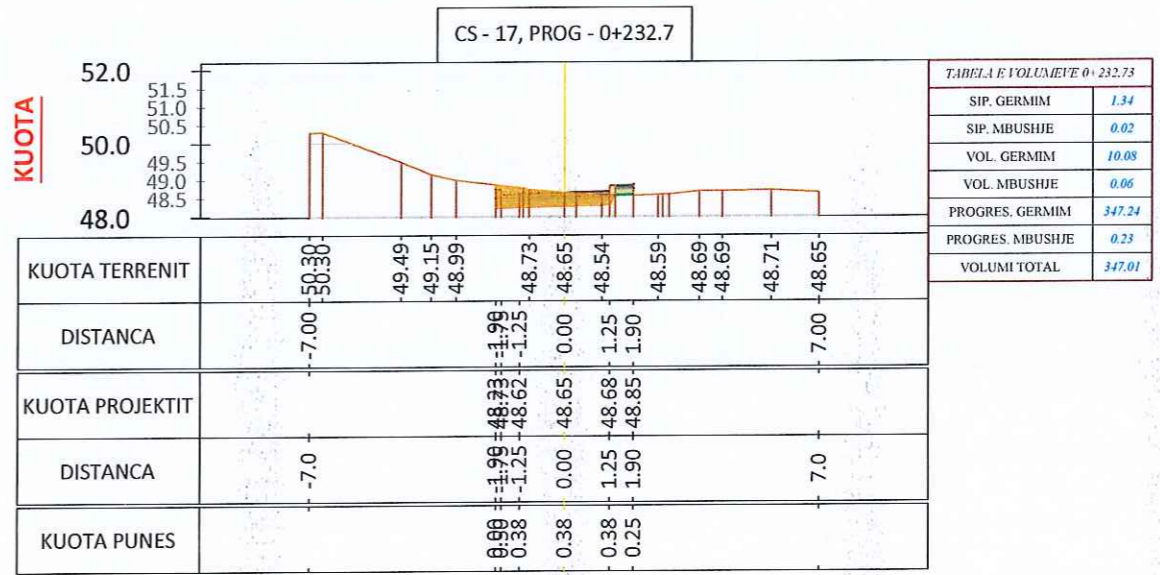
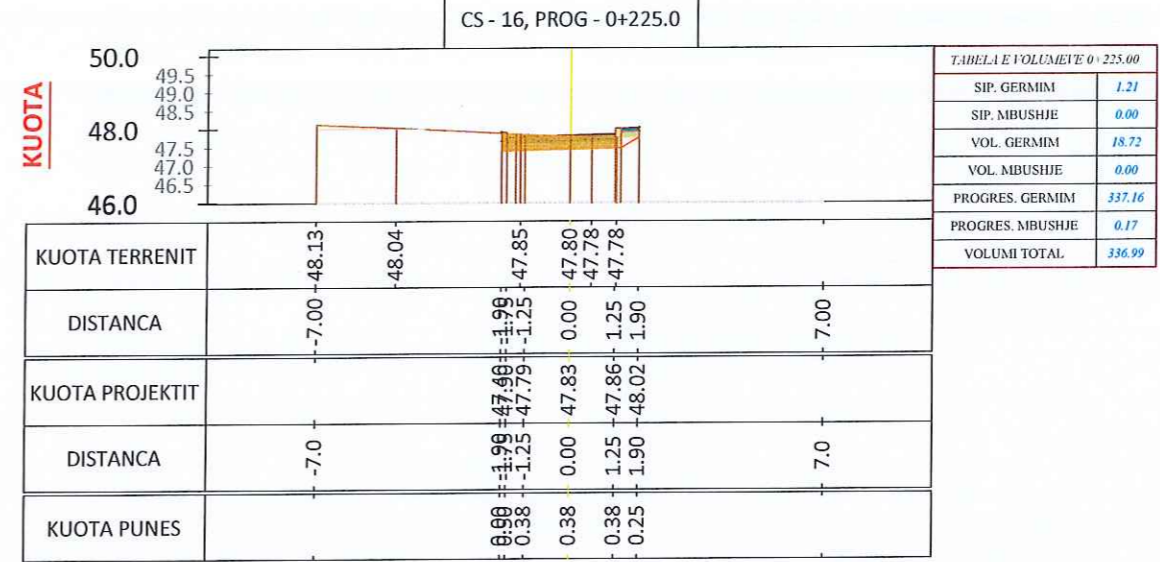
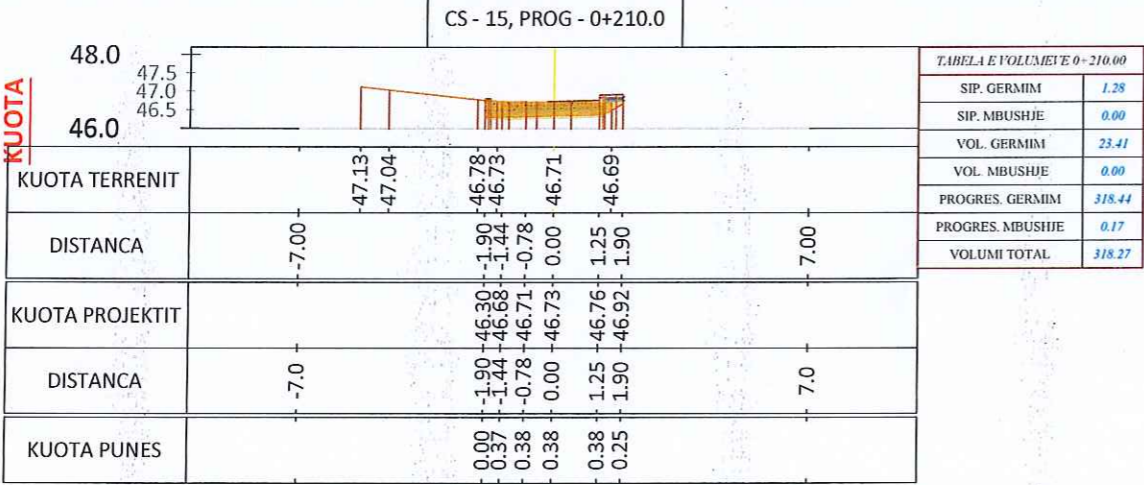
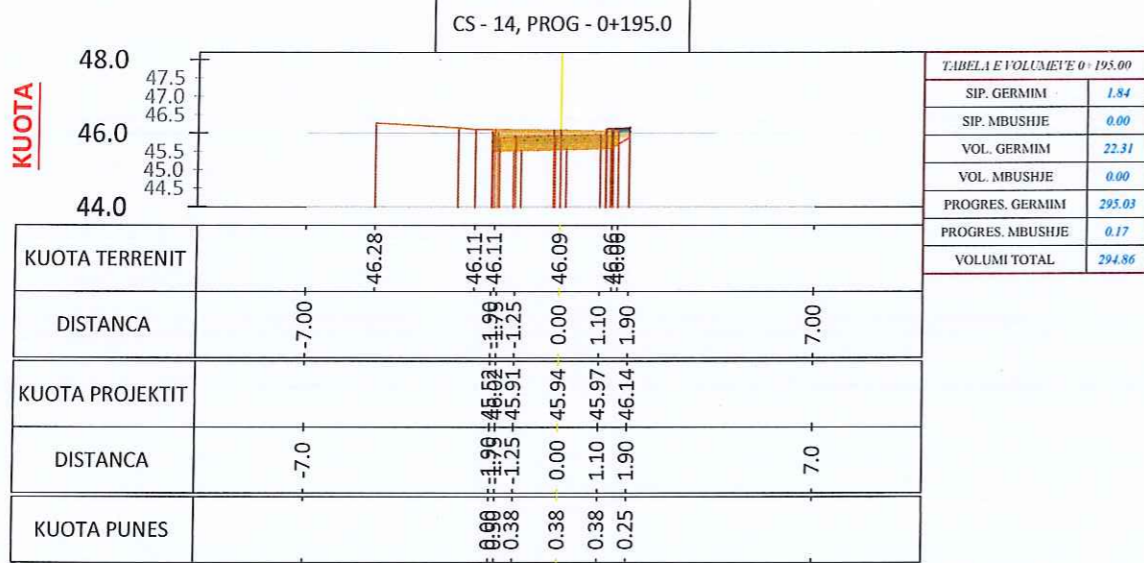
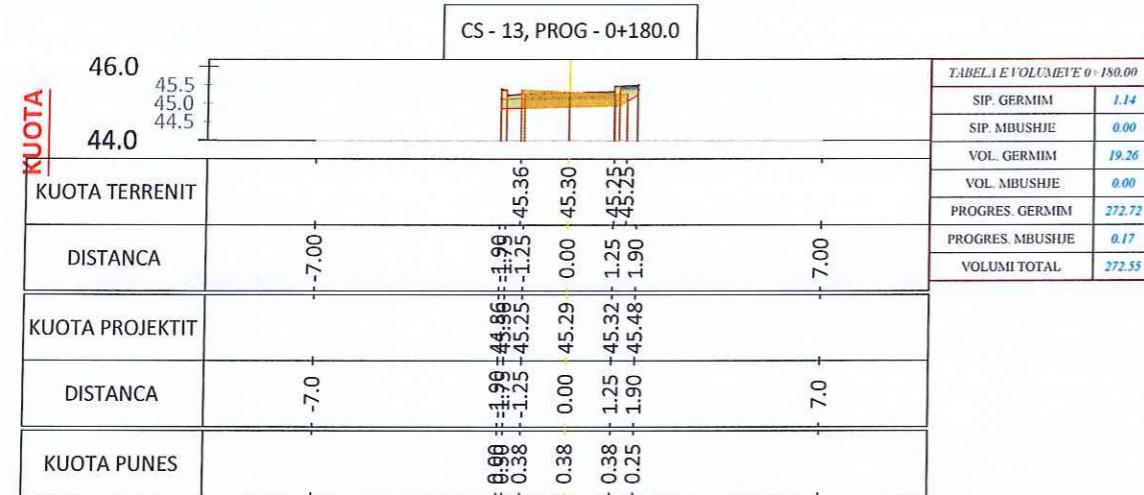

Porositi:  Bashkia Vau Dejës	Projektoi:  Administrator Ing. Nikoll Paluca Adresa: Tirane Mobile: 068 20 42 270 Email: leni.ing@hotmail.com NUIS: 188730334W	Objekti: Rikonstruksion i rrugeve te lagjeve Lisen, Kinoklubi, Bishaj, Tanushi Faza: Projekt - Zbatimi Emërtimi i Fletës: PROFILAT TERTHORE KINOKLUBI Shkalla: Sh-1:200 Tiranë 2023 PT-07
---	---	---

TABELA E VOLUMEVE

TABELA VOLUMEVE							
PROGRESIVA	SIP. GERMIM	SIP. MBUSHJE	VOL. GERMIM	VOL. MBUSHJE	G. PROGRESIV	M. PROGRESIV	G-M
0+00.00	1.60	0.00	0.00	0.00	0.00	0.00	0.00
0+15.00	1.60	0.00	24.04	0.00	24.04	0.00	24.04
0+30.00	1.60	0.00	24.06	0.00	48.11	0.00	48.11
0+45.00	1.60	0.00	24.04	0.00	72.15	0.00	72.15
0+60.00	1.60	0.00	24.05	0.00	96.19	0.00	96.19
0+75.00	1.60	0.00	24.04	0.00	120.23	0.00	120.23
0+90.00	1.60	0.00	24.04	0.00	144.27	0.00	144.27
1+05.00	1.60	0.00	24.04	0.00	168.31	0.00	168.31
1+20.00	1.60	0.00	24.04	0.00	192.35	0.00	192.35
1+35.00	1.60	0.00	24.04	0.00	216.39	0.00	216.39
1+37.12	1.60	0.00	3.40	0.00	219.79	0.00	219.79

Porositi:  Bashkia Vau Dejes	Projektoi:  Administrator Ing. Nikoll Paluca Adresa: Tirane Mobile: 068 20 42 270 Email: leni.ing@hotmail.com	Objekti: Rikonstruksion i rrugeve te lagjeve Lisen, Kinoklubi, Bishaj, Tanushi Faza: Projekt - Zbatimi Emërtimi i Fletës: TABELA E VOLUMEVE KINOKLUBI Shkalla: Tiranë 2021 TB-02
---	---	---

PROFILI GJATESORE

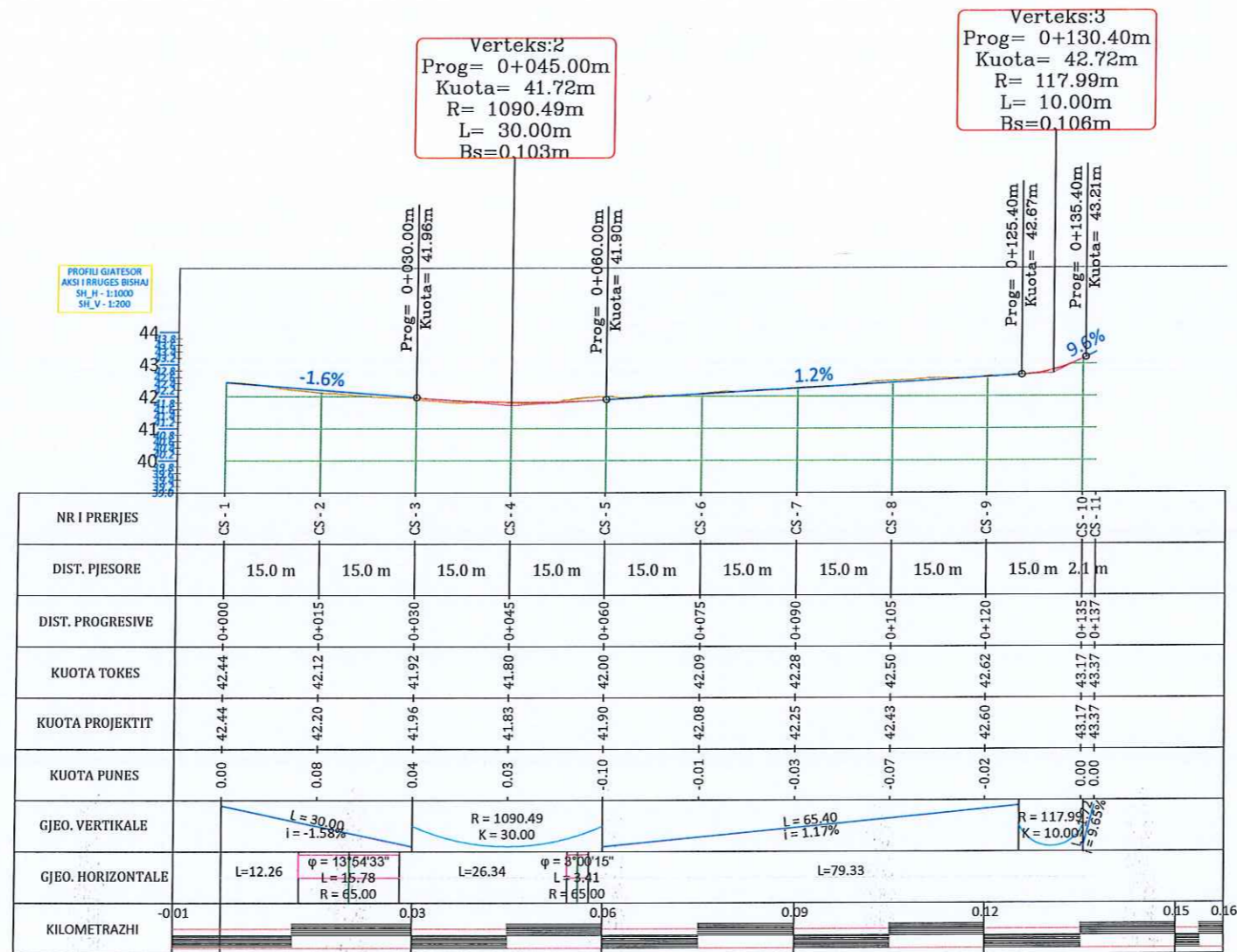

Porositi:  Bashkia Vau Dejës	Projektor:  Administrator Ing. Nikoll Paluca Adresa: Tirane Mobile: 068-20-42 270 Email: lent.ing@hotmail.com NUIS: J6873033AW	Objekti: Rikonstrukcion i rrugëve te lagjeve Lisen, Kinoklubi, Bishaj, Tanushi Faza: Projekt - Zbatimi Emërtimi i Fletës: PROFILI GJATESORE BISHAJ Shkalla: ShH-1:1000 ShV-1:200 Tiranë 2023 PGJ-05
---	---	---

PROFILAT TERTHORE

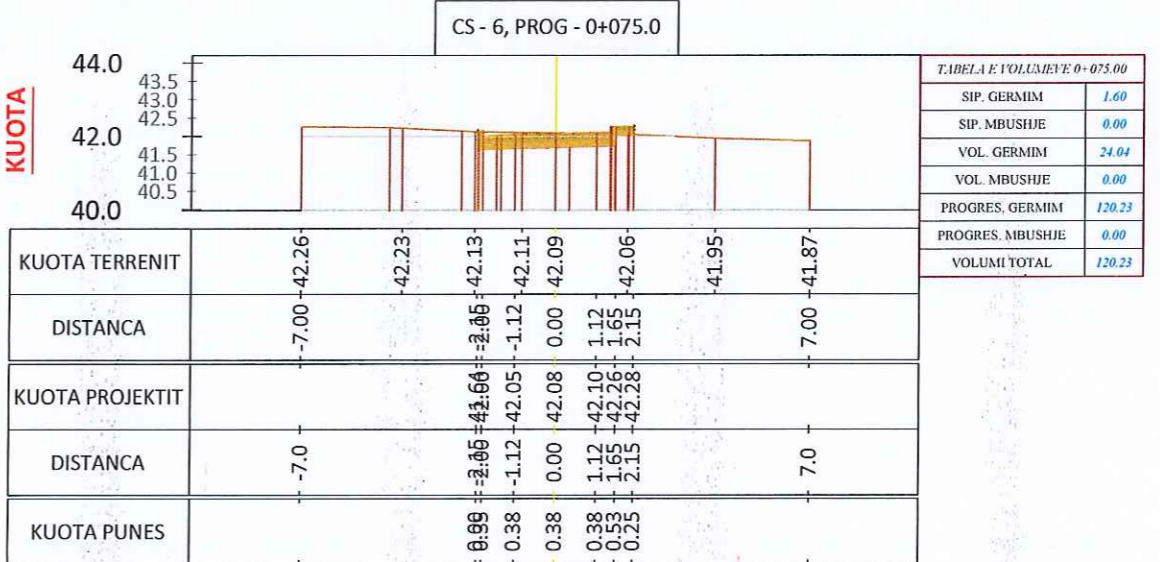
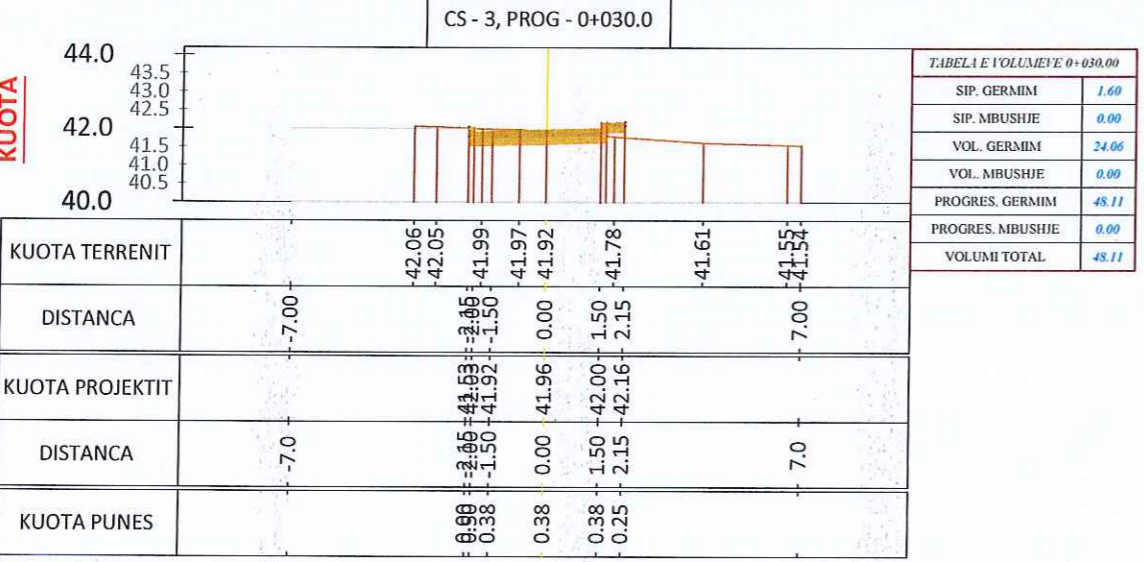
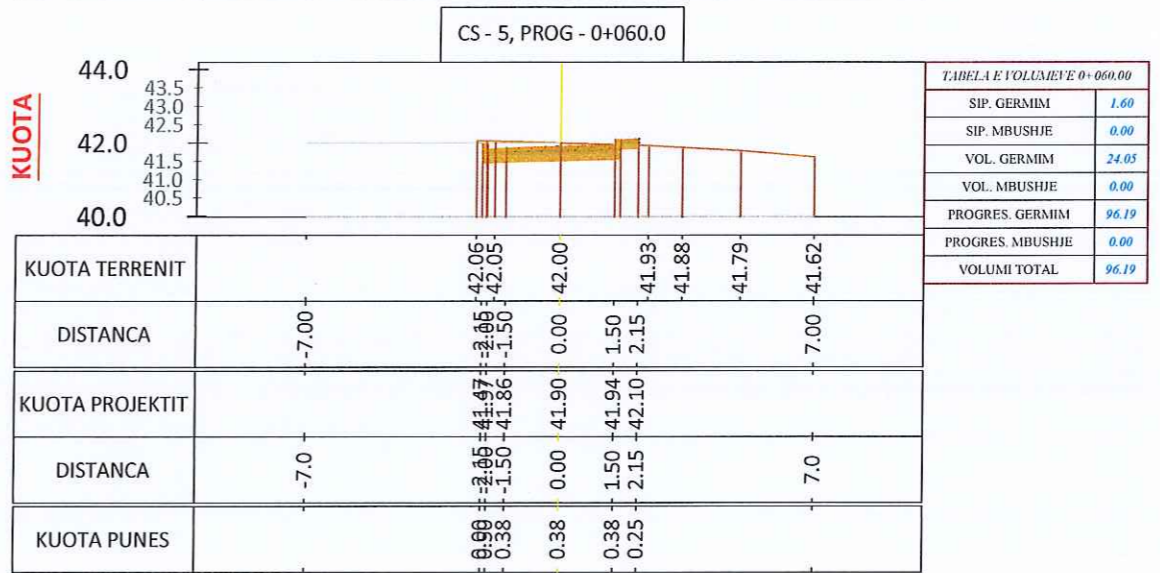
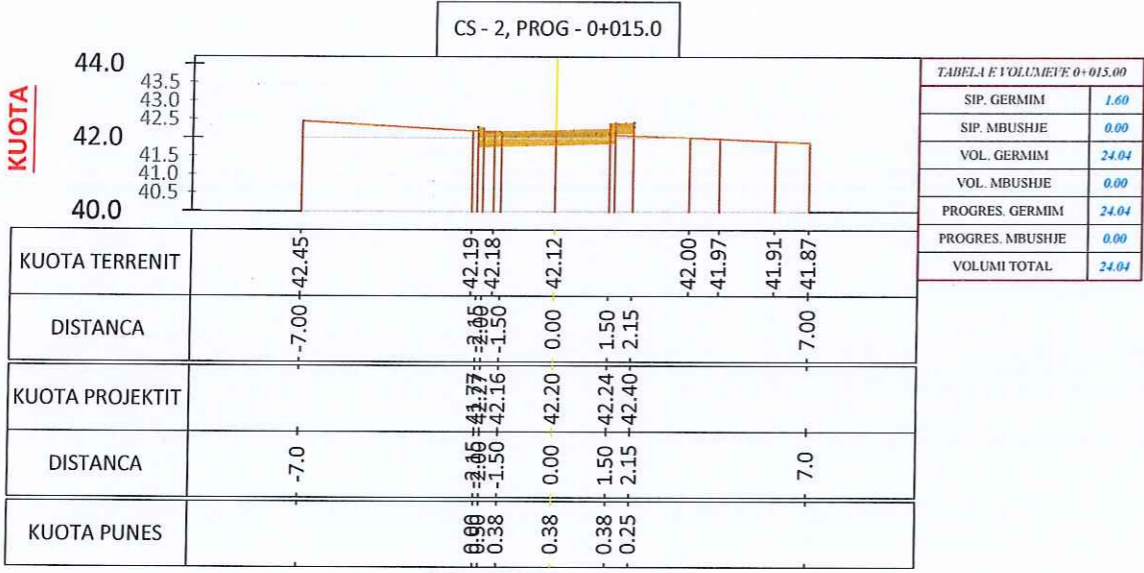
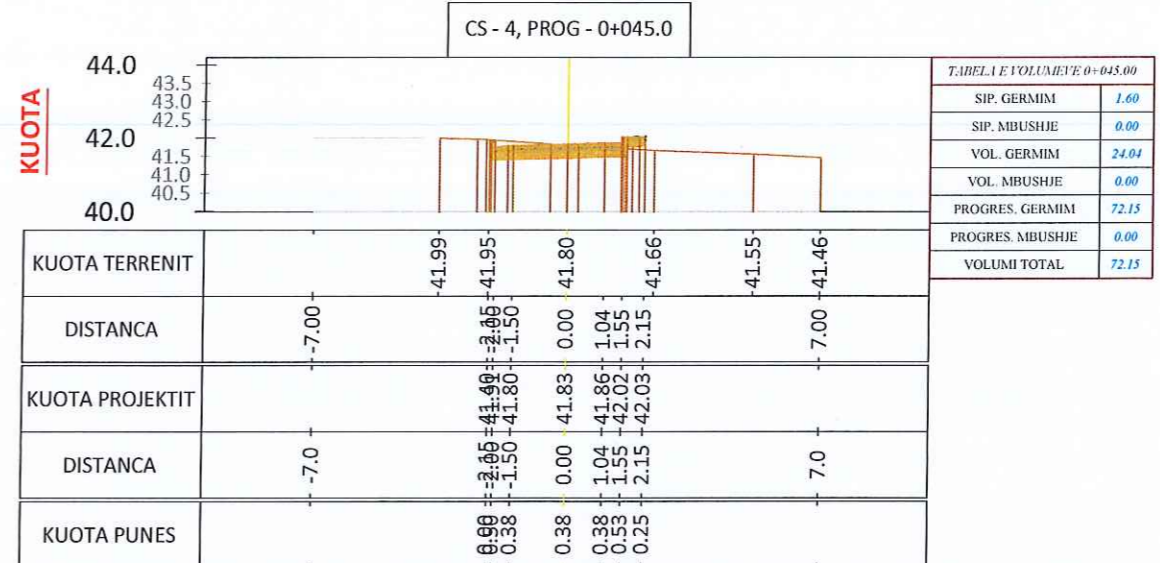
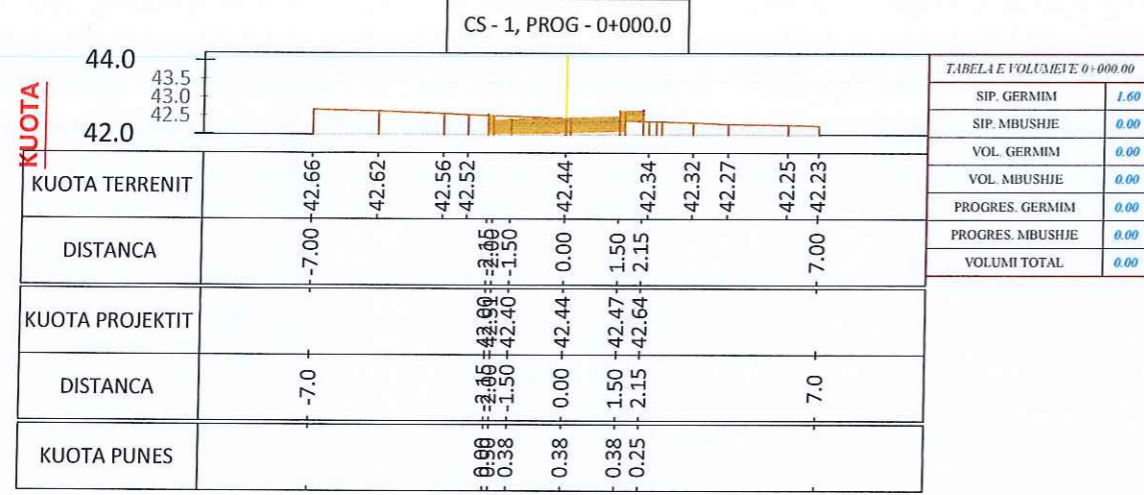

Porositi:	Projektoi:	Objekti:
	PROJEKTIM LENI-ING sh.p.k	Sistemim, Asfaltim Për Lagjat Lisen, Kinoklubi, Bishaj, Tanushi
Bashkia Vau Dejës	Administrator Ing. Nikoll Paluca	Faza: Projekt - Zbatimi
	Adresa: Tirane Mobile: 068 20 42 270 Email: leni.ing@hotmail.com	Emërtimi i Fletës: Shkalla: Tiranë 2023
		PROFILAT TERTHORE BISHAJ Sh-1:200 PT-08

PROFILAT TERTHORE

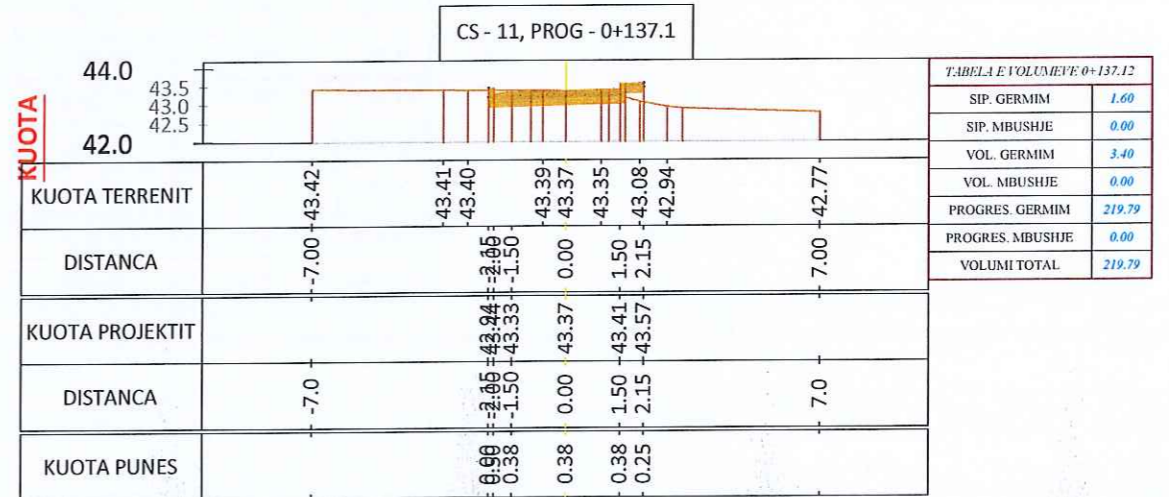
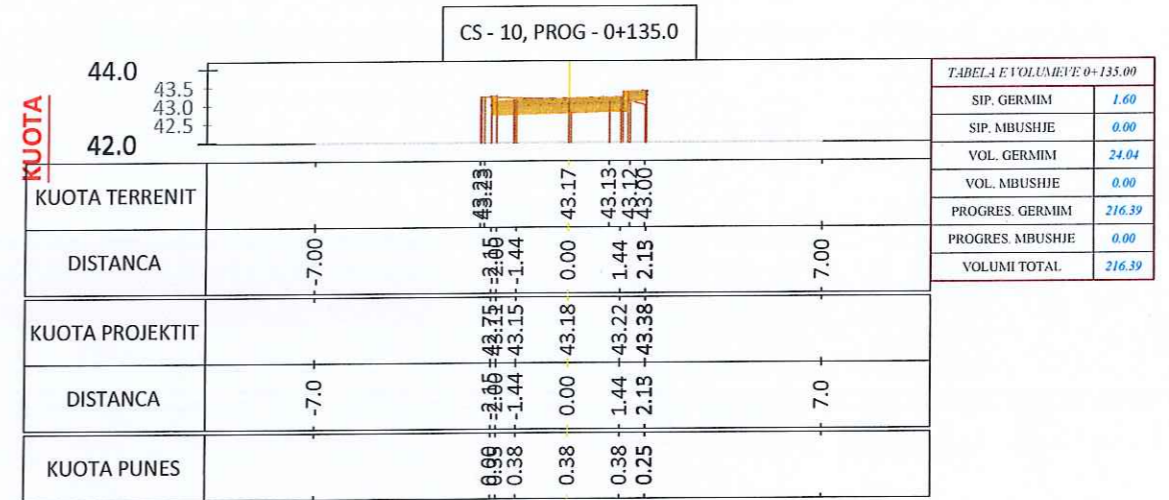
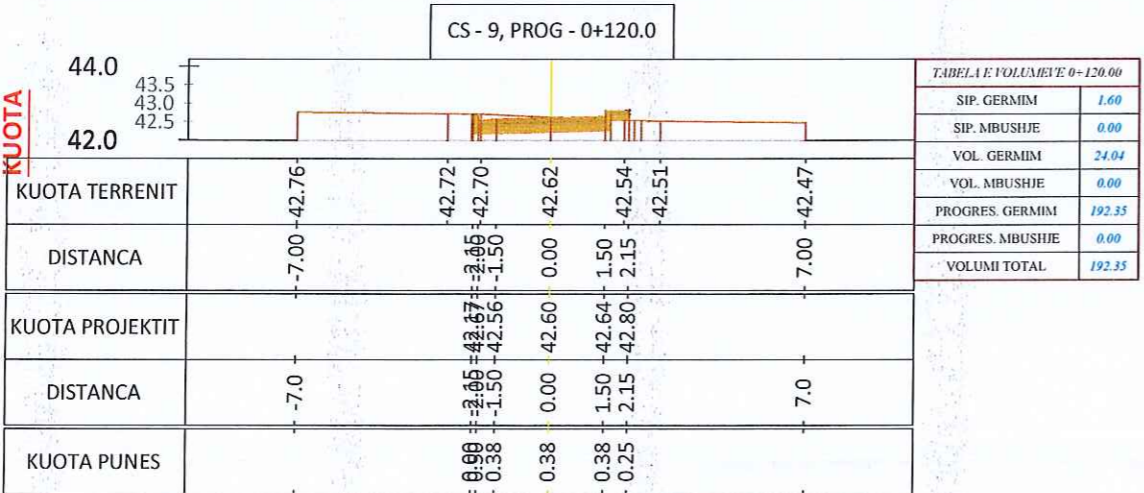
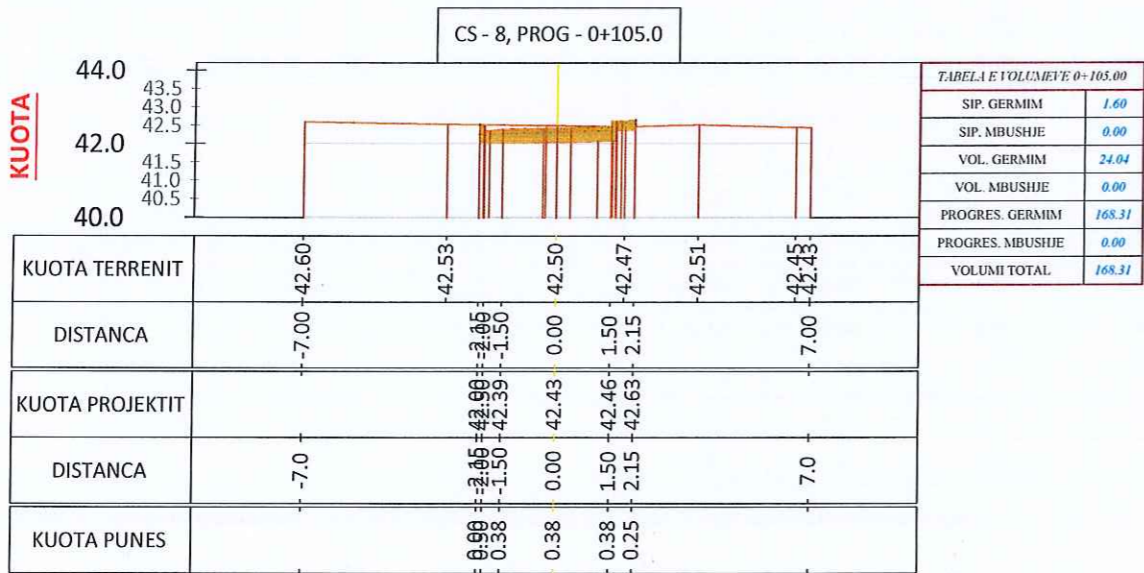
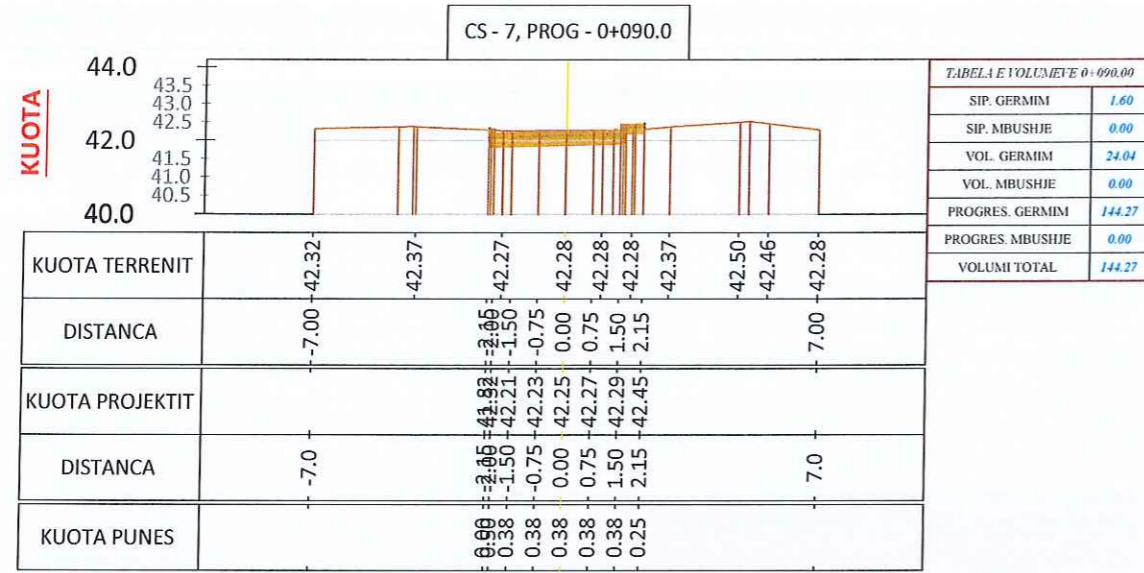

Porositi:



Bashkia Vau Dejës

Projektori:

"LENI-ING" sh.p.k

Administrator Ing. Nikoll Paluca

Adresa: Tirane
Mobile: 068 20 42 270
Email: leni.ing@hotmail.com

Objekti: Sistemim, Asfaltim Për Lagjat Lisen, Kinoklubi, Bishaj, Tanushi

Faza: **Projekt - Zbatimi**

Emërtimi i Fletës: PROFILAT TERTHORE BISHAJ

Shkalla: Sh-1:200

Tiranë 2021

PT-09

PROFILI GJATESORE

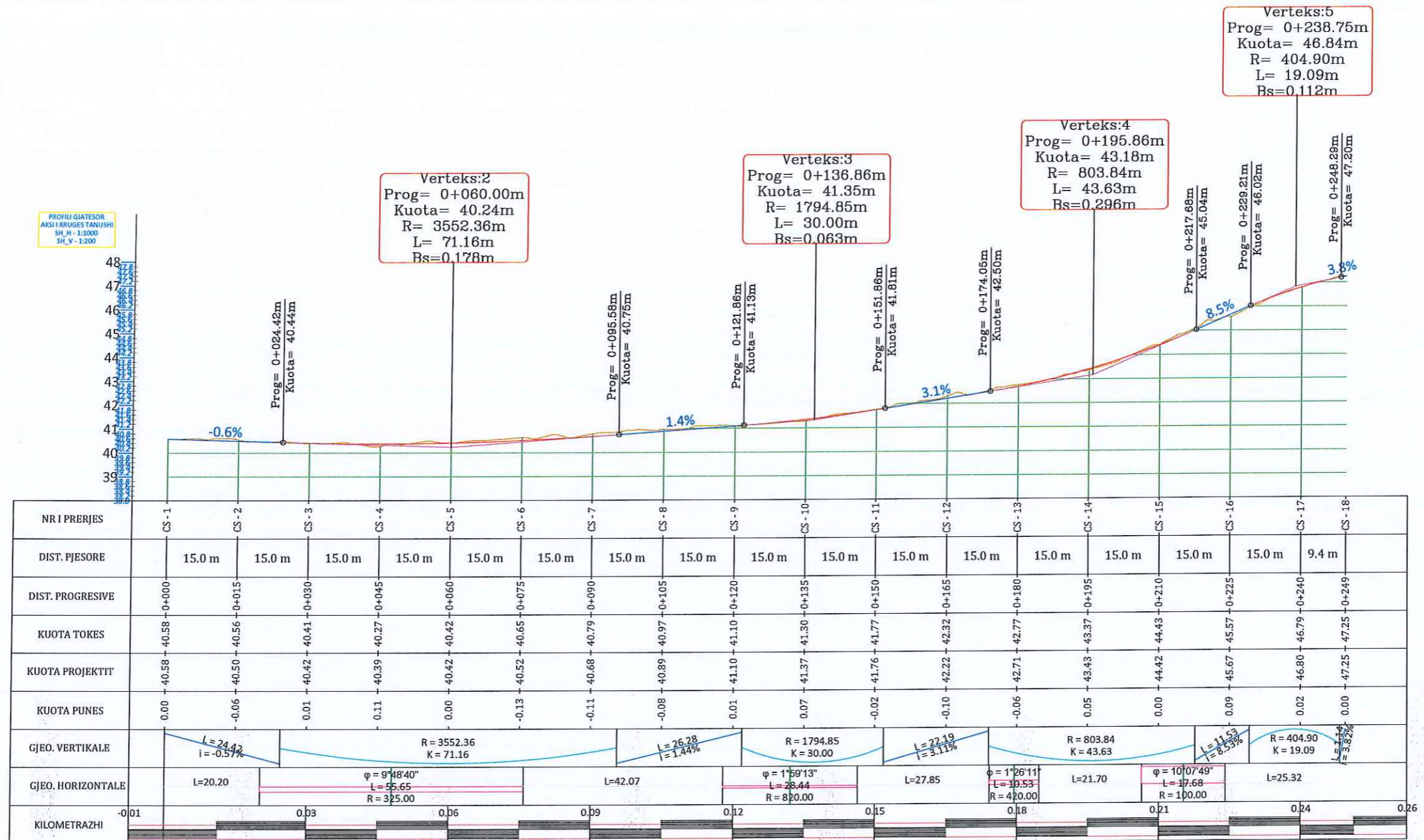

Porositi:  Bashkia Vau Dejës	Projektoi: PROJEKTIM "LENI-ING" sh.p.k Administrator Ing. Nikoll Paluca Adresa: Tiranë Mobile: 068 20 42 270 Email: leni.ing@hotmail.com	Objekti: Sistemim, Asfaltim Për Lagjat Lisen, Kinoklubi, Bishaj, Tanushi Faza: Projekt - Zbatimi Emërtimi i Fletës: PROFILI GJATESORE TANUSHI Shkalla: ShH-1:1000 ShV-1:200	Tiranë 2023 PGJ-06
---	--	--	-----------------------

PROFILAT TERTHORE

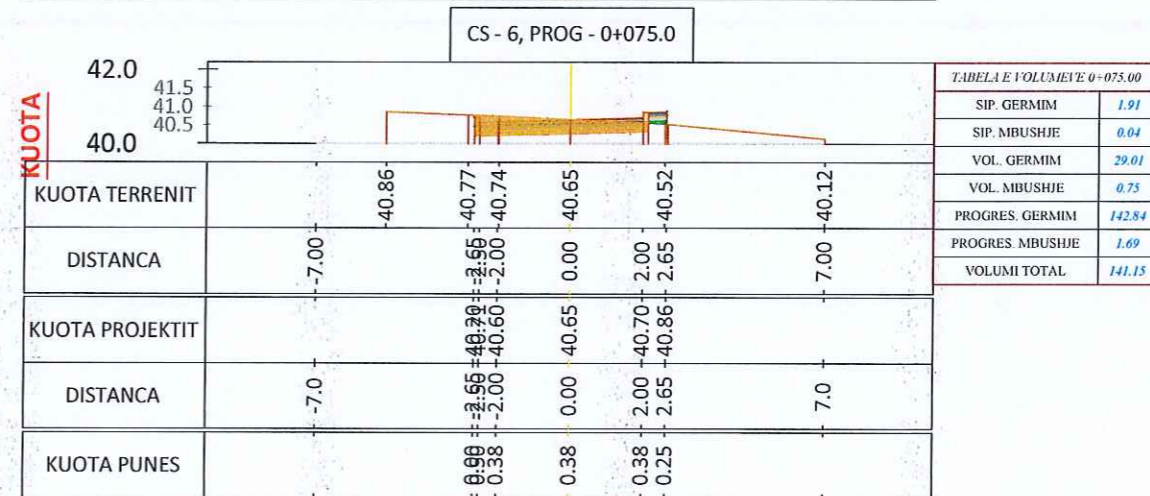
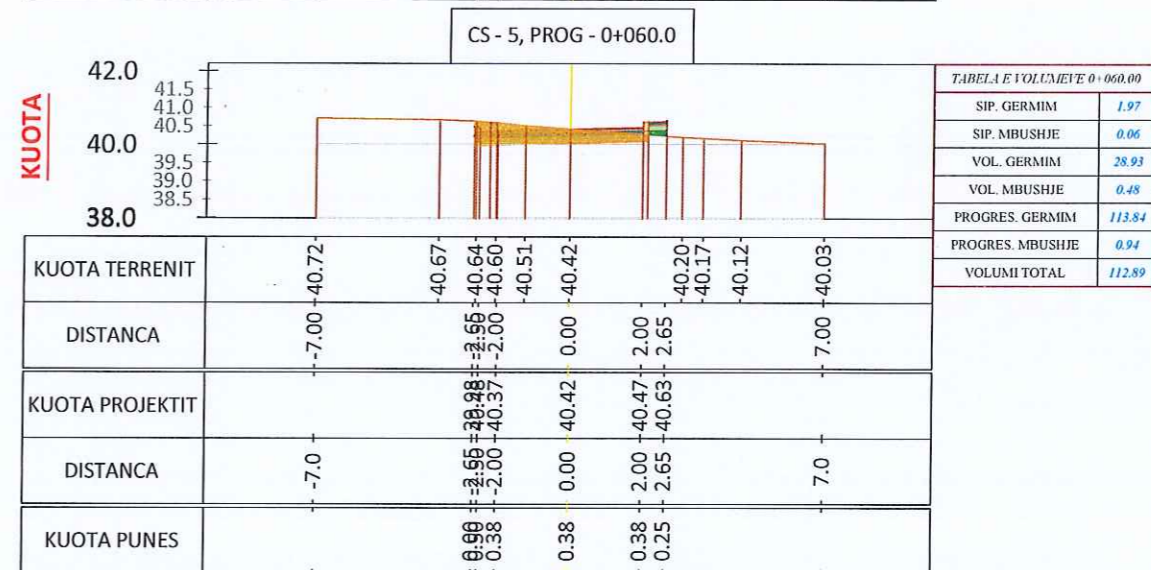
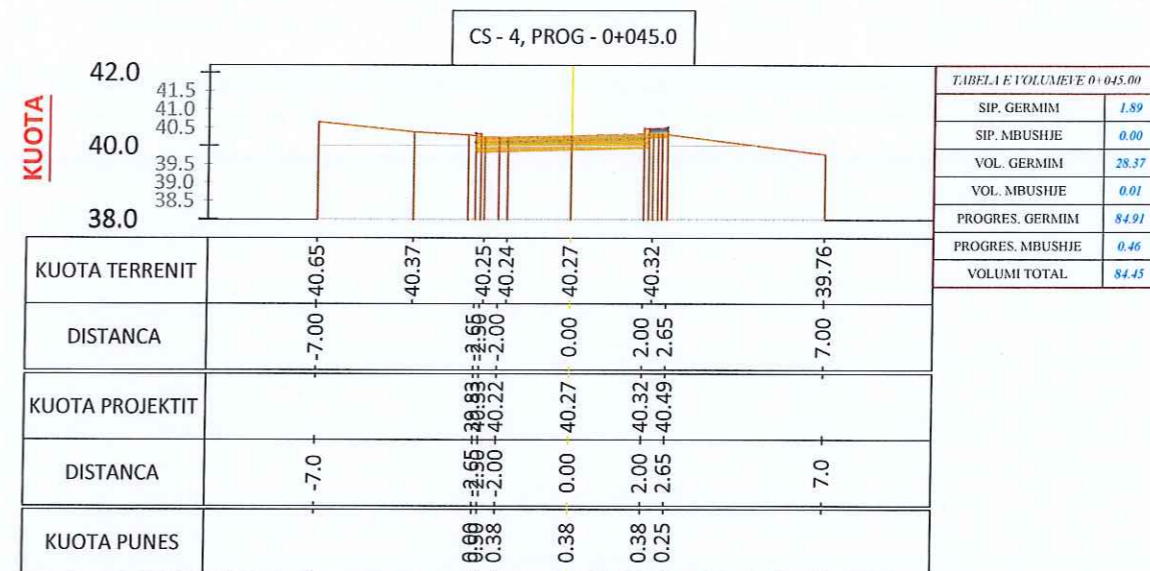
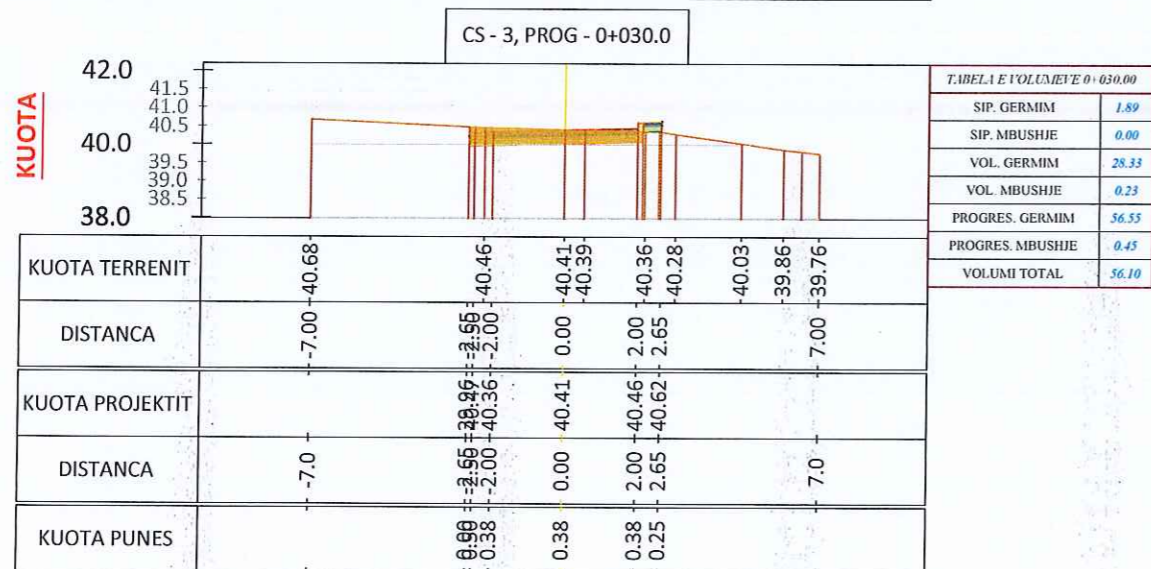
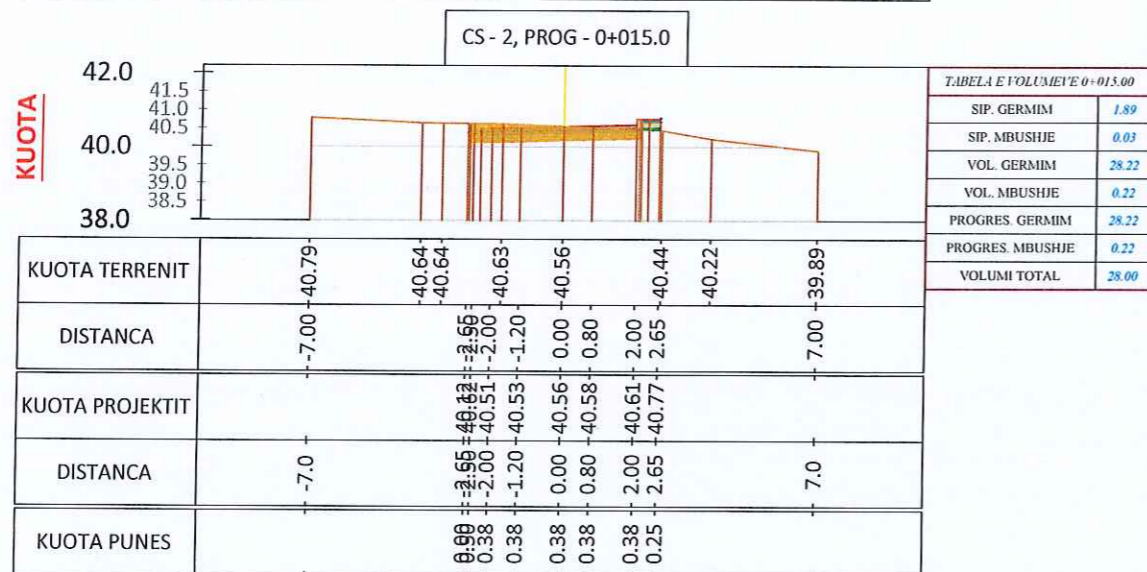
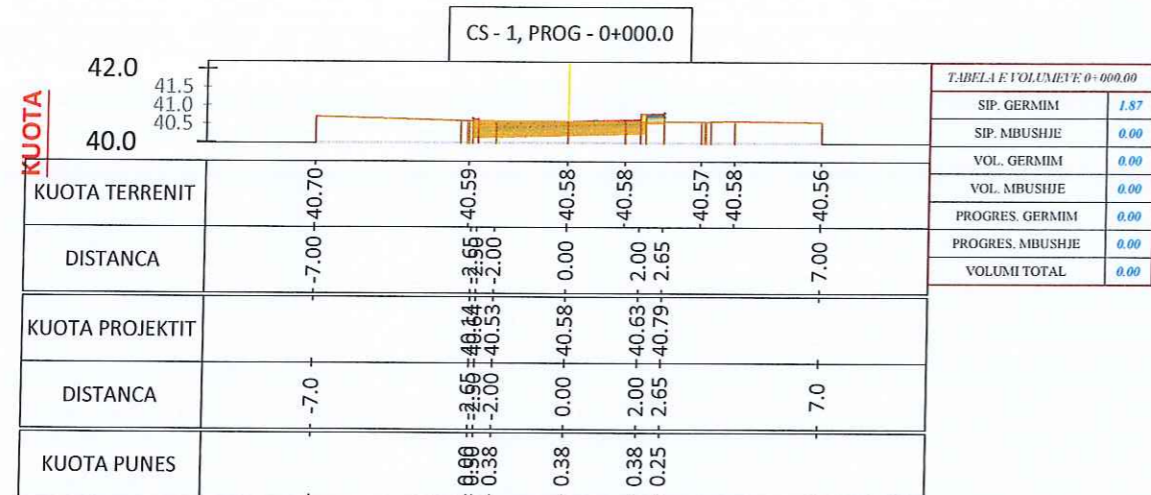

Porositi:	Projektoi:	Objekti:
	"LENI-ING" sh.p.k	Rikonstruksion i rrugeve te lagjeve Lisen, Kinoklubi, Bishaj, Tanushi
Bashkia Vau Dejës	Administrator Ing. Nikoll Paluca	Faza: Projekt - Zbatimi
	Adresa: Tirane	Emërtimi i Fletës:
	Mobile: 068 20 42 270	Shkalla:
	Email: leni.ing@hotmail.com	Tiranë 2022
		PROFILAT TERTHORE TANUSHI
		Sh-1:200
		PT-10

PROFILAT TERTHORE

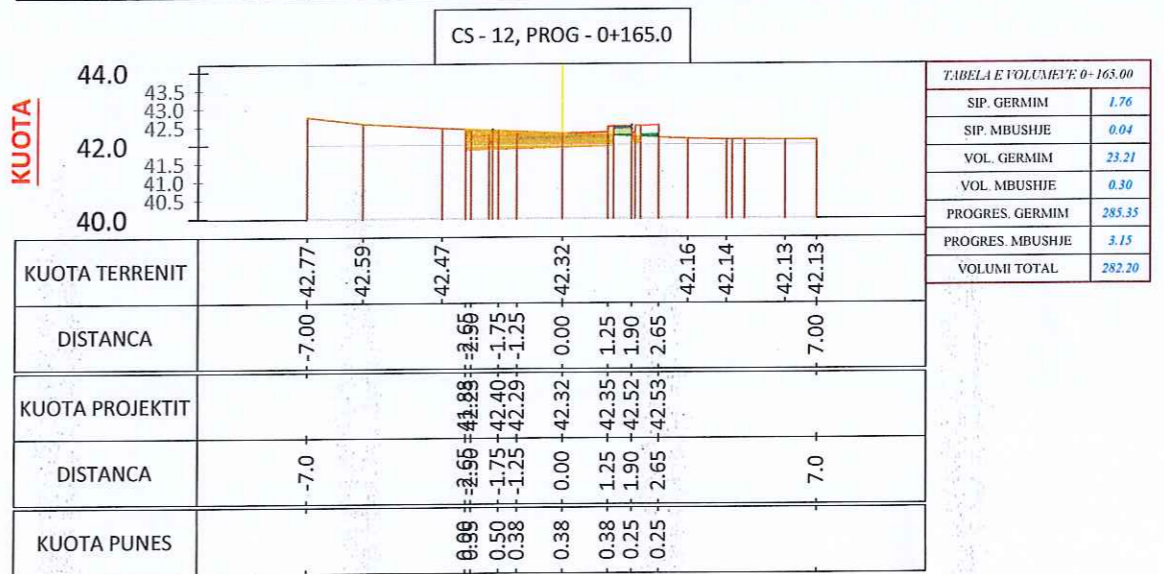
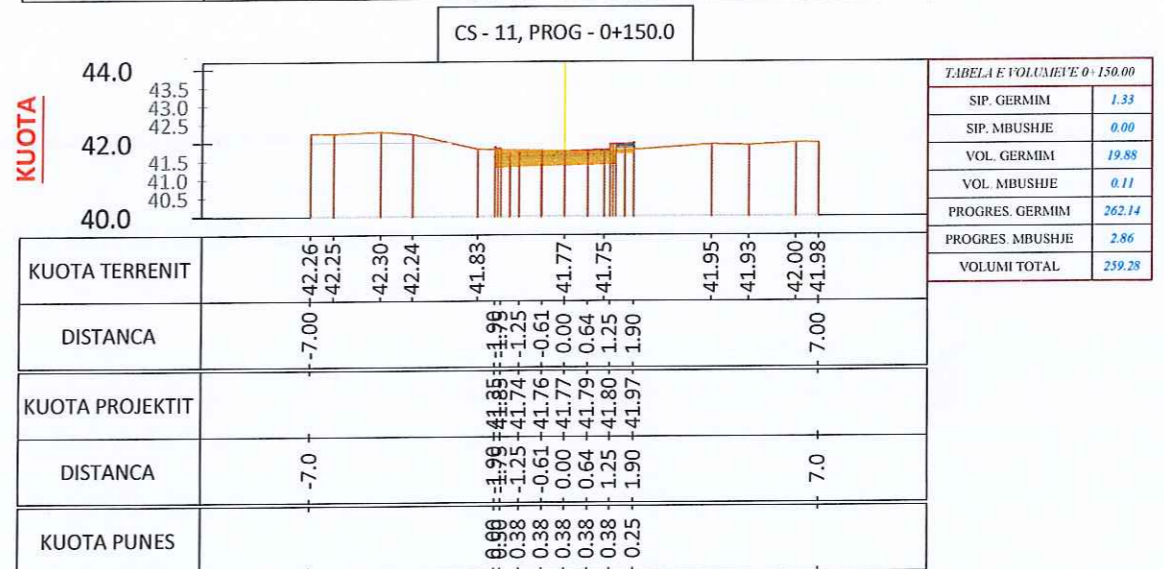
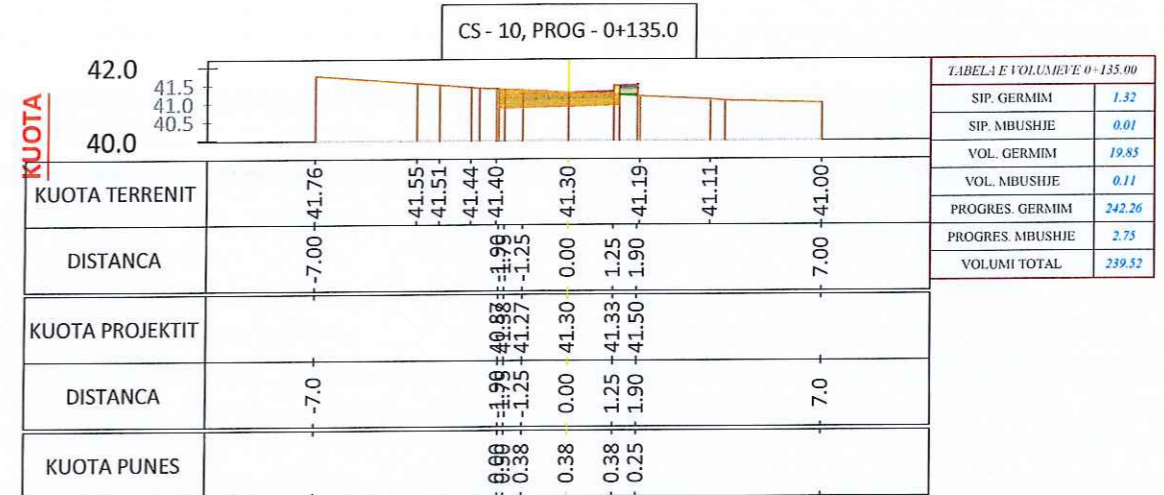
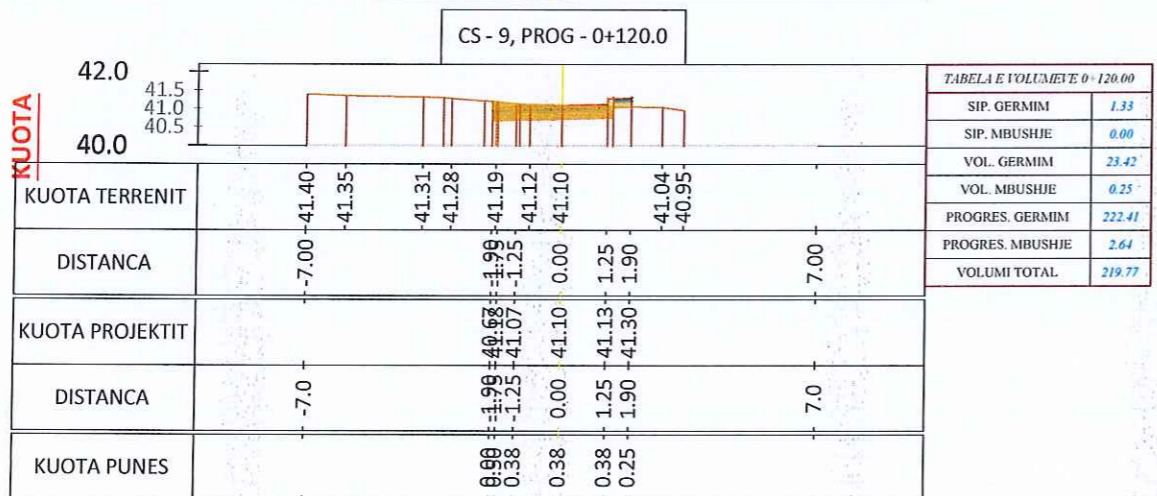
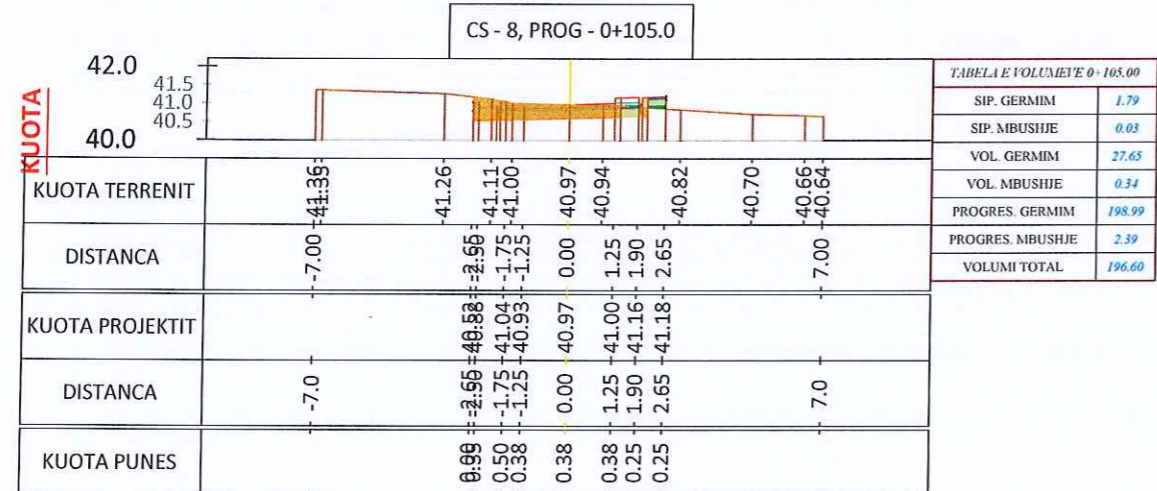
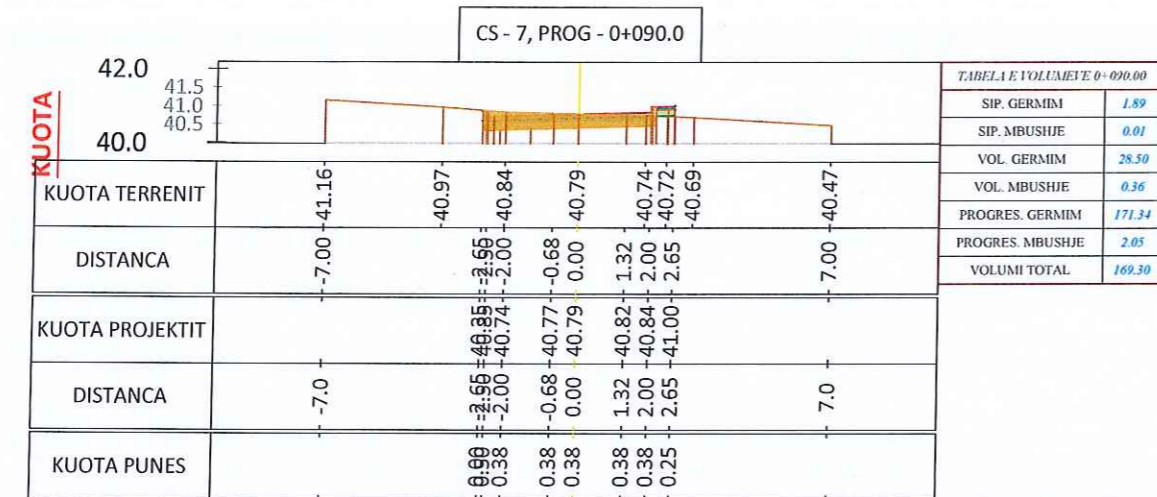

Porositi:  Bashkia Vau Dejës	Projektoi: "LENI-ING" sh.p.k Administrator Ing. Nikoll Paluca Adresa: Tirane Mobile: 068 20 42 270 Email: leni.ing@hotmail.com 	Objekti: Rikonstruksion i rrugeve te lagjeve Lisen, Kinoklubi, Bishaj, Tanushi Faza: Projekt - Zbatimi Emërtimi i Fletës: Shkalla: Tiranë 2023 PROFILAT TERTHORE TANUSHI Sh-1:200 PT-11
---	---	---

PROFILAT TERTHORE

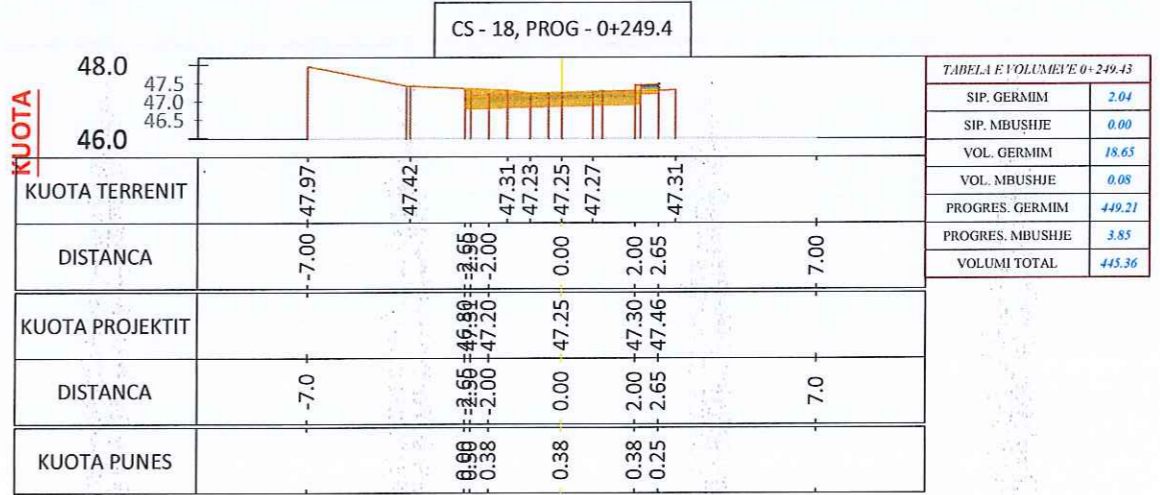
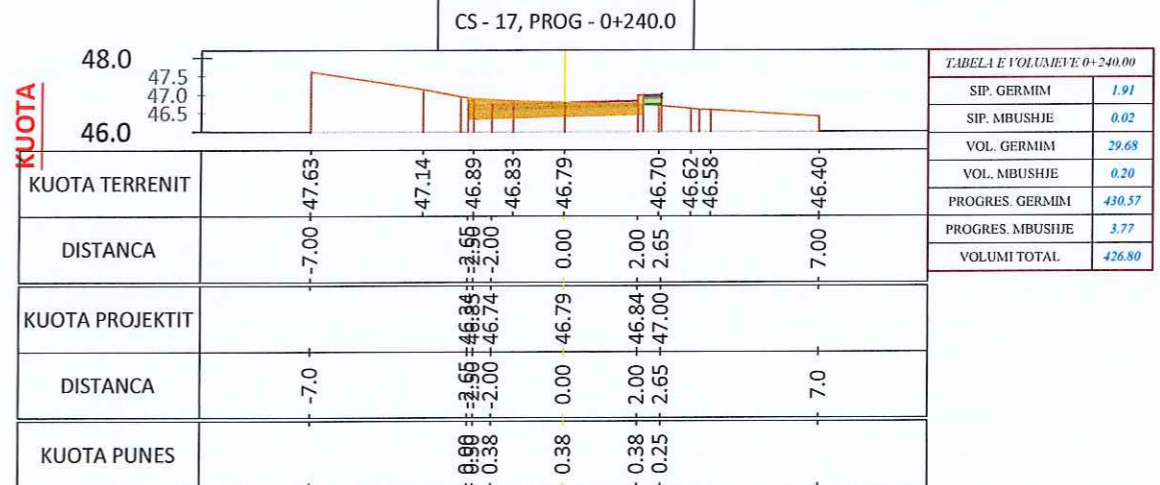
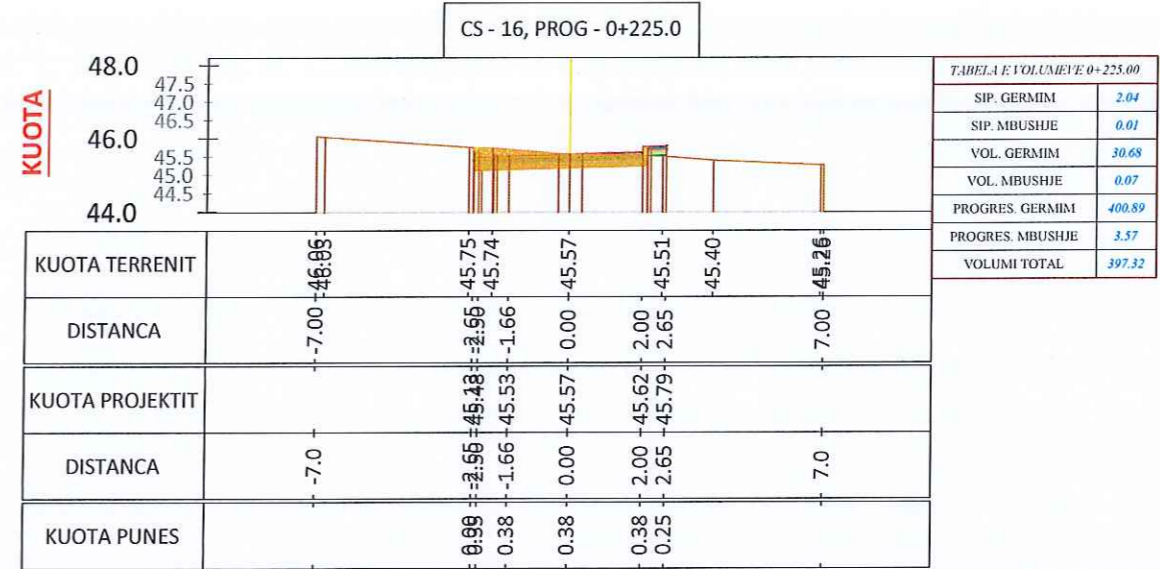
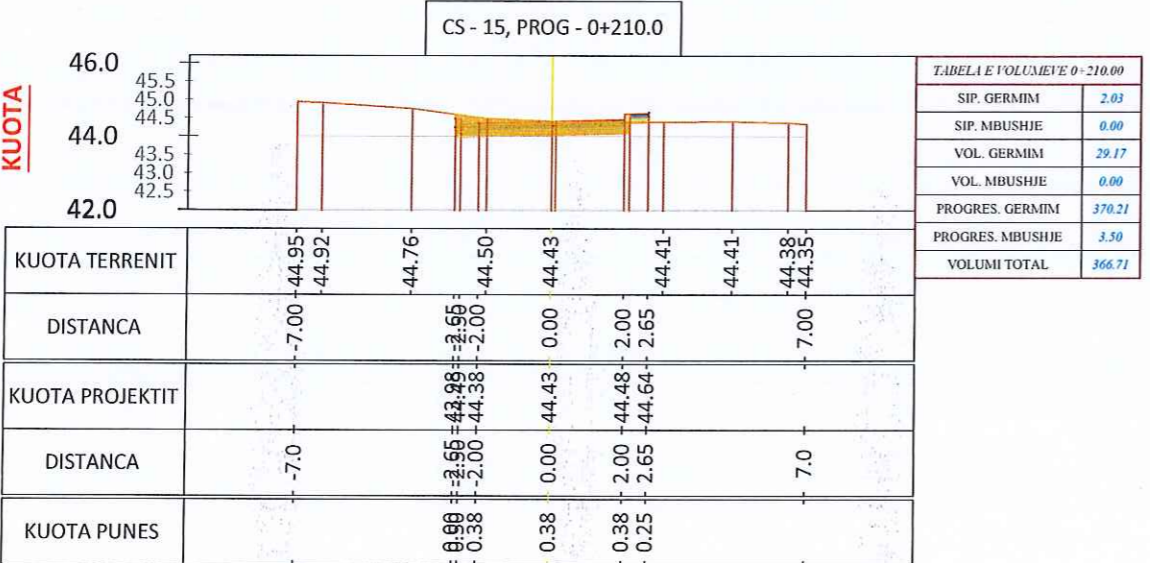
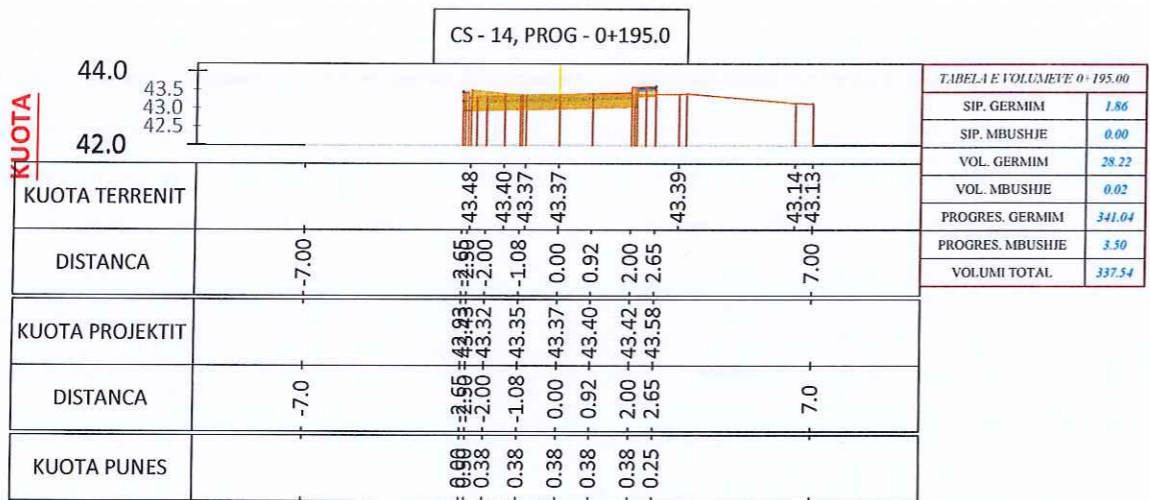
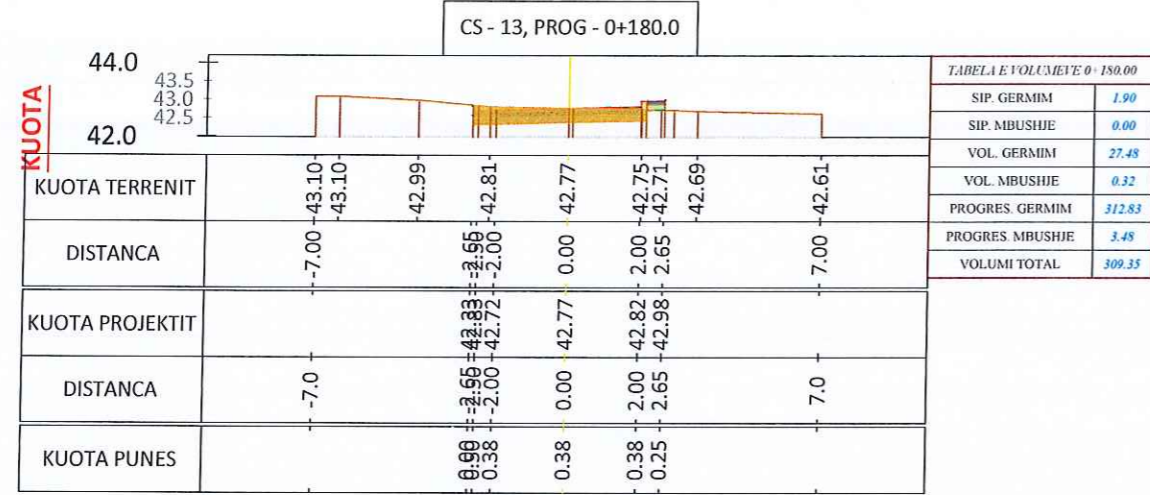

Porositi:



Bashkia Vau Dejës

Projekttoi:

"LENI-ING" sh.p.k

Administrator Ing. Nikoll Paluca

Adresa: Tirane
Mobile: 068 20 42 270
Email: leni.ing@hotmail.com

KONTROLIM
NUIS: J88730334W

Objekti: Rikonstruktion i rrugëve të lagjeve Lisen, Kinoklubi, Bishaj, Tanushi

Faza: **Projekt - Zbatimi**

Emërtimi i Fletës:	Shkalla:	Tiranë 2023
PROFILAT TERTHORE TANUSHI	Sh-1:200	PT-12

TABELA E VOLUMEVE

TABELA VOLUMEVE							
PROGRESIVA	SIP. GERMIM	SIP. MBUSHJE	VOL. GERMIM	VOL. MBUSHJE	G. PROGRESIV	M. PROGRESIV	G-M
0+00.00	1.60	0.00	0.00	0.00	0.00	0.00	0.00
0+15.00	1.60	0.00	24.04	0.00	24.04	0.00	24.04
0+30.00	1.60	0.00	24.06	0.00	48.11	0.00	48.11
0+45.00	1.60	0.00	24.04	0.00	72.15	0.00	72.15
0+60.00	1.60	0.00	24.05	0.00	96.19	0.00	96.19
0+75.00	1.60	0.00	24.04	0.00	120.23	0.00	120.23
0+90.00	1.60	0.00	24.04	0.00	144.27	0.00	144.27
1+05.00	1.60	0.00	24.04	0.00	168.31	0.00	168.31
1+20.00	1.60	0.00	24.04	0.00	192.35	0.00	192.35
1+35.00	1.60	0.00	24.04	0.00	216.39	0.00	216.39
1+37.12	1.60	0.00	3.40	0.00	219.79	0.00	219.79

Porositi:  Bashkia Vau Dejes	Projektoi: "LENI NG" sh.p.k Administrator Ing. Nikoll Paluda Adresa: Tirane Mobile: 068 20 42 270 Email: leni.ng@hotmail.com	Objekti: Rikonstruksion i rrugeve te lagjeve Lisen, Kinoklubi, Bishaj, Tanushi Faza: Projekt - Zbatimi Emërtimi i Fletës: TABELA E VOLUMEVE TANUSHI Shkalla: Tiranë 2021 TB-04
---	---	--

PROFILI TERTHORE TIP

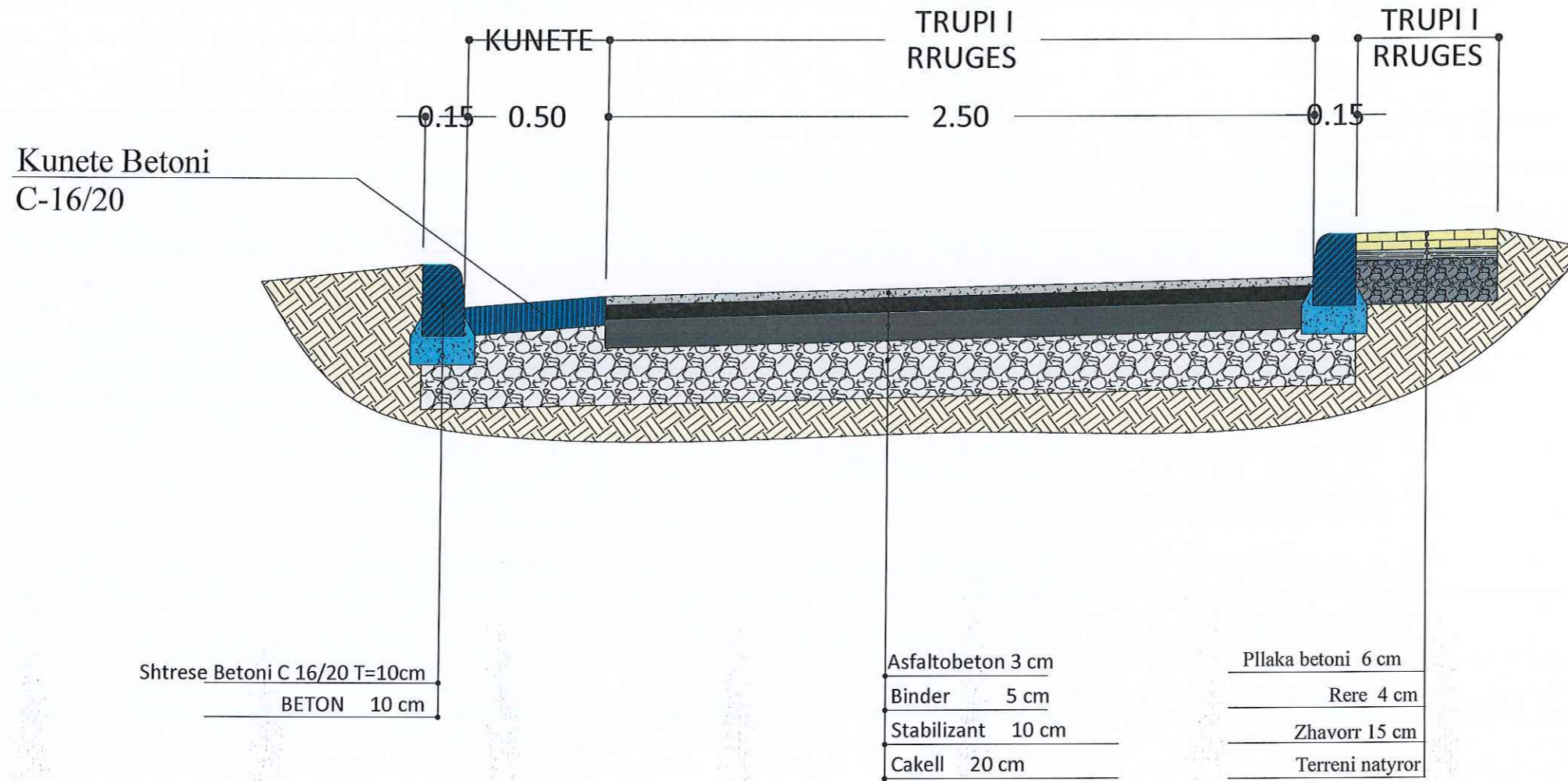

Porositi:

 Bashkia Vau Dejes

Projekttoi:

 Administrator Ing. Nikoll Paluca
 Adresa: Tirane
 Mobile: 068 20 42 270
 Email: leni.tng@hotmail.com

Objekti: Rikonstruksion i rrugeve te lagjeve Lisen, Kinoklubi, Bishaj, Tanushi

Faza: **Projekt - Zbatimi**

Emërtimi i Fletës: PROFILI TERTHORE TIP	Shkalla: Sh - 1:20	Tiranë 2023 T - 01
--	-----------------------	-----------------------

PROFILI TERTHORE TIP

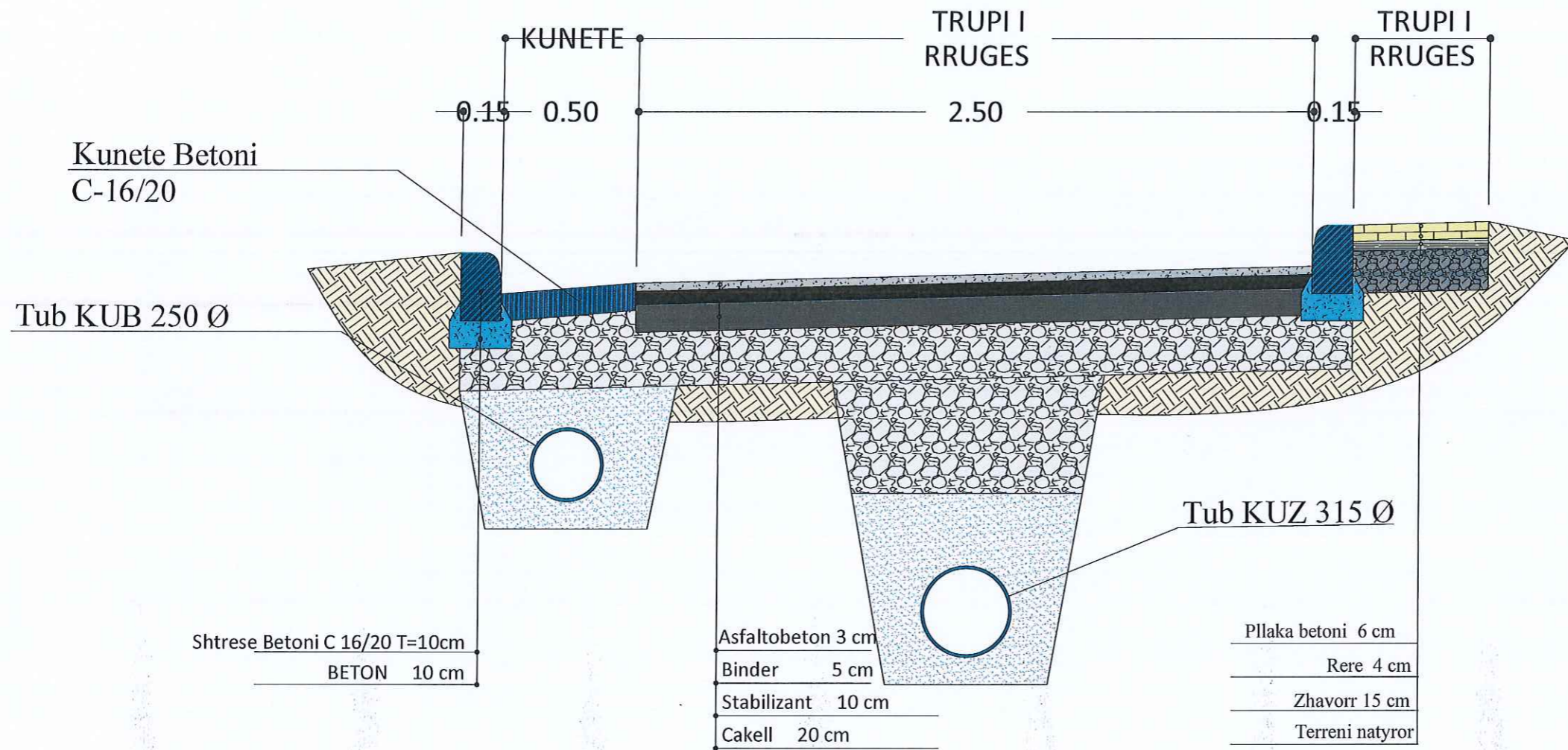

Porositi:  Bashkia Vau Dejës	Projektori: "DENI-ING" sh.p.k. Administrator Ing. Nikoll Paluca Adresa: Tirane Mobile: 068 20 42 270 Email: deni.ing@hotmail.com 	Objekti: Rikonstruksion i rrugeve te lagjeve Lisen, Kinoklubi, Bishaj, Tanushi Faza: Projekt - Zbatimi Emërtimi i Fletës: PROFILI TERTHORE TIP Shkalla: Sh - 1:20 Tiranë 2023 T - 02
---	--	--

PROFILI TERTHORE TIP

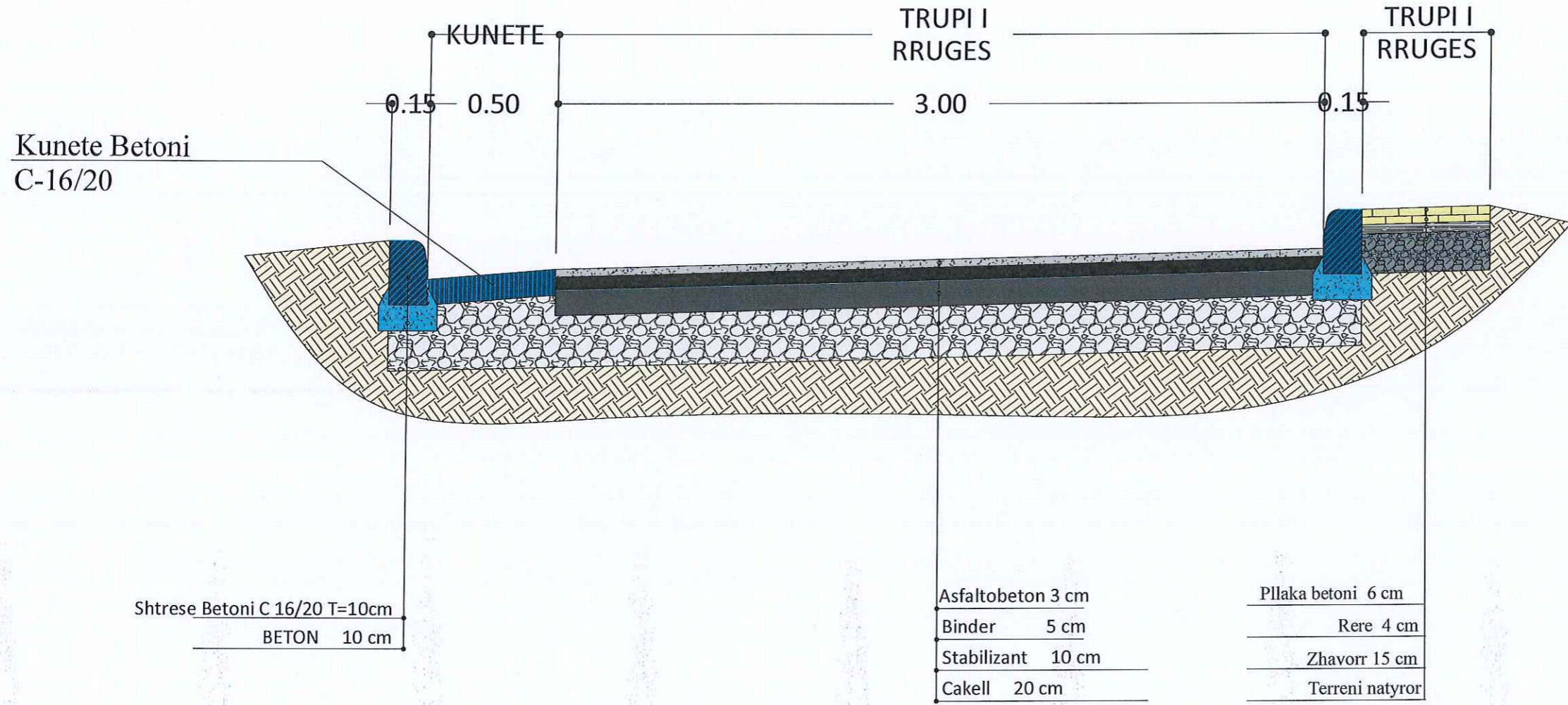

<p>Porositi:</p>  <p>Bashkia Vau Dejës</p>	<p>Projektori:</p> <p>"LENI-ING" sh.p.k</p> <p>Administrator Ing. Nikoll Paluca</p> <p>Adresa: Tirane</p> <p>Mobile: 068 20 42 270</p> <p>Email: leni.ing@hotmail.com</p> <p>NUIS: J88730334W</p>	<p>Objekti: Rikonstrukcion i rrugeve te lagjeve Lisen, Kinoklubi, Bishaj, Tanushi</p> <p>Faza: Projekt - Zbatimi</p> <table border="1" style="width: 100%; border-collapse: collapse;"> <tr> <td style="width: 33%;">Emërtimi i Fletës:</td> <td style="width: 33%;">Shkalla:</td> <td style="width: 33%;">Tiranë 2024</td> </tr> <tr> <td>PROFILI TERTHORE TIP</td> <td>Sh - 1:20</td> <td>T - 03</td> </tr> </table>	Emërtimi i Fletës:	Shkalla:	Tiranë 2024	PROFILI TERTHORE TIP	Sh - 1:20	T - 03
Emërtimi i Fletës:	Shkalla:	Tiranë 2024						
PROFILI TERTHORE TIP	Sh - 1:20	T - 03						

PROFILI TERTHORE TIP

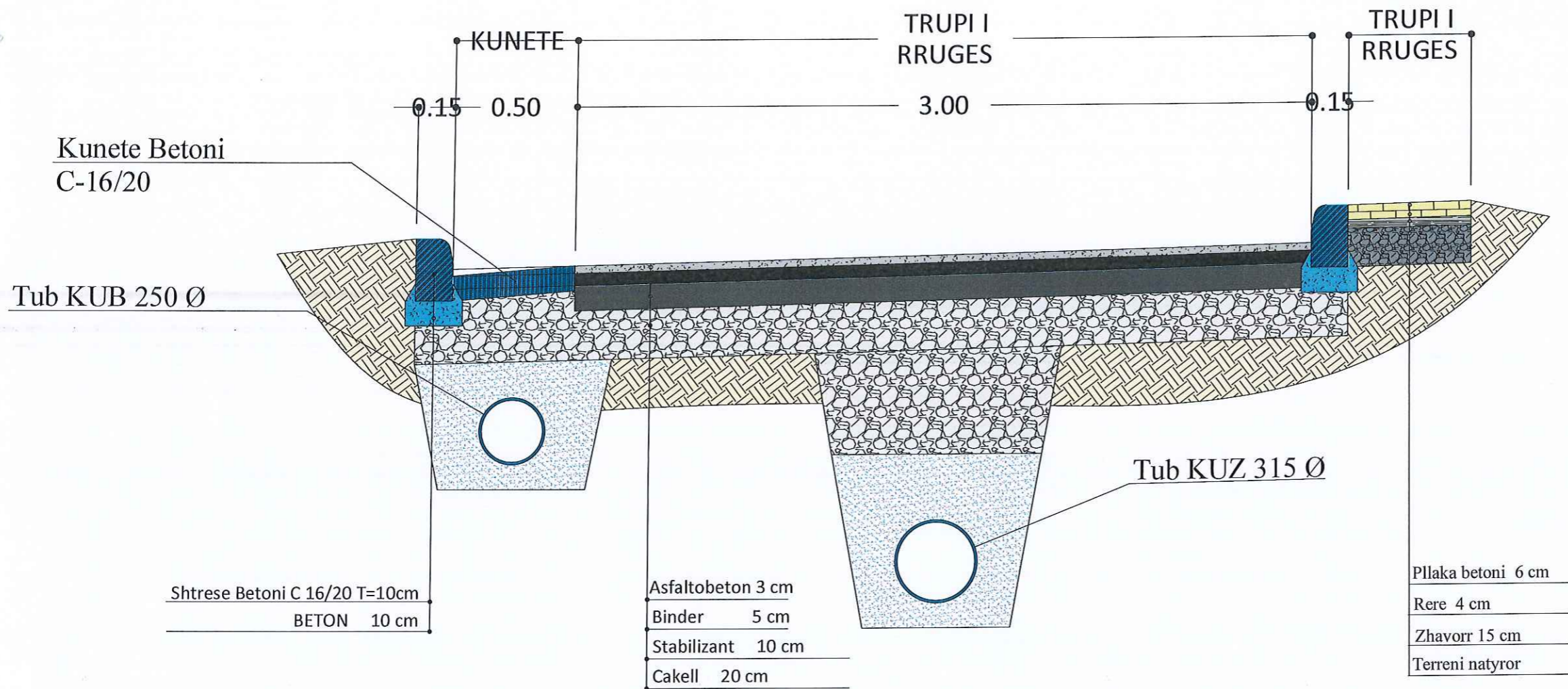

<p>Porositi:</p>  <p>Bashkia Vau Dejës</p>	<p>Projektoi:</p> <p>"LENI-ING" sh.p.k</p> <p>Administrator Ing. Nikoll Paluca</p> <p>Adresa: Tirane</p> <p>Mobile: 068 20 42 270</p> <p>Email: leni.ing@hotmail.com</p> <p style="color: red; font-weight: bold;">PROJEKTIM SHTETLISHT "LENI-ING" KLAUDIM NUI: J88730334W</p>	<p>Objekti: Rikonstrukcion i rrugeve te lagjeve Lisen, Kinoklubi, Bishaj, Tanushi</p> <p>Faza: Projekt - Zbatimi</p> <table border="1" style="width: 100%; border-collapse: collapse;"> <tr> <td style="width: 33%;">Emërtimi i Fletës:</td> <td style="width: 33%;">Shkalla:</td> <td style="width: 33%;">Tiranë 2021</td> </tr> <tr> <td>PROFILI TERTHORE TIP</td> <td>Sh - 1:20</td> <td>T - 04</td> </tr> </table>	Emërtimi i Fletës:	Shkalla:	Tiranë 2021	PROFILI TERTHORE TIP	Sh - 1:20	T - 04
Emërtimi i Fletës:	Shkalla:	Tiranë 2021						
PROFILI TERTHORE TIP	Sh - 1:20	T - 04						

PROFILI TERTHORE TIP

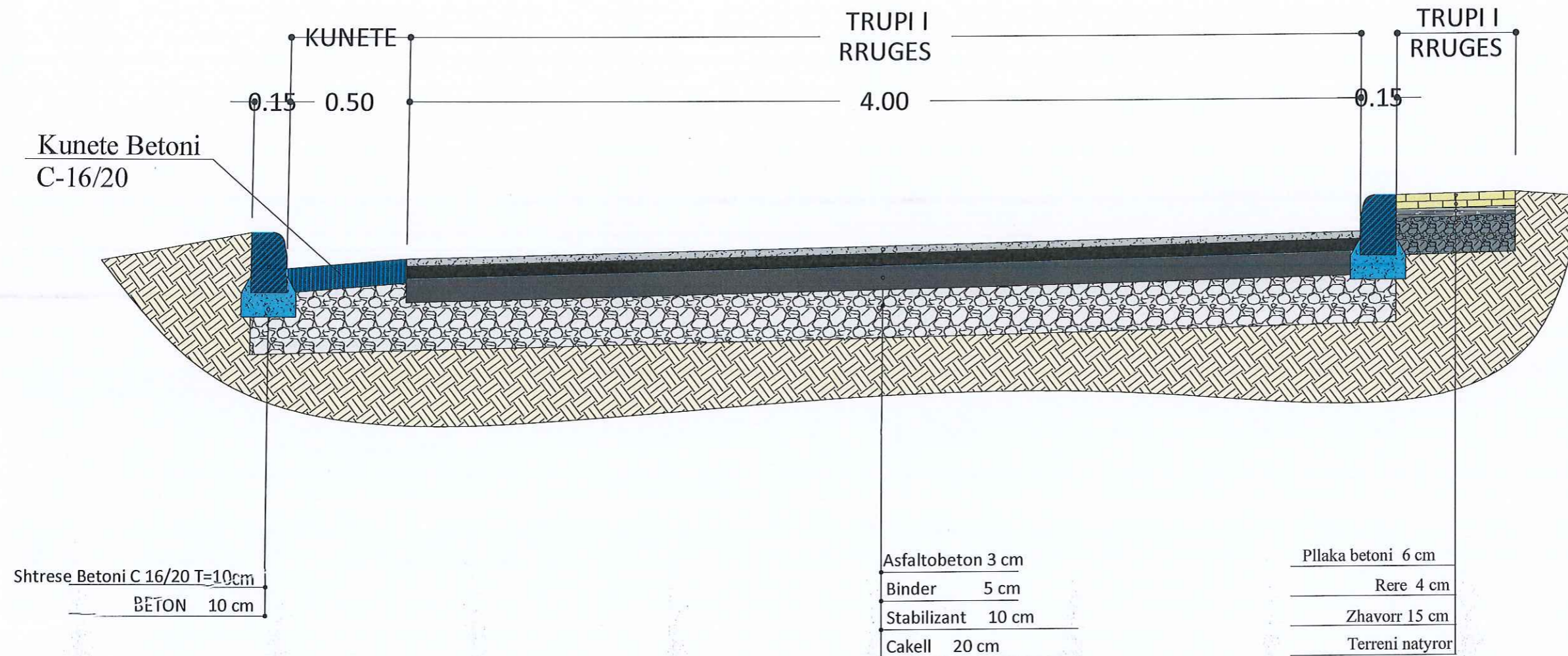

<p>Porositi:</p>  <p>Bashkia Vau Dejes</p>	<p>Projektori:</p> <p style="text-align: center;">"LENI-ING" sh.p.k</p> <p>Administrator Ing. Nikoll Paluca</p> <p>Adresa: Tirane</p> <p>Mobile: 068 20 42 270</p> <p>Email: leni.ing@hotmail.com</p> <p style="text-align: center; color: red; font-weight: bold;">PROJEKTIMI "LENI-ING" CLAUDIM NUS: J88730334W</p>	<p>Objekti: Rikonstrukcion i rrugeve te lagjeve Lisen, Kinoklubi, Bishaj, Tanushi</p> <p>Faza: Projekt - Zbatimi</p> <table style="width: 100%; border-collapse: collapse;"> <tr> <td style="width: 33%;">Emërtimi i Fletës:</td> <td style="width: 33%;">Shkalla:</td> <td style="width: 33%;">Tiranë 2021</td> </tr> <tr> <td>PROFILI TERTHORE TIP</td> <td>Sh - 1:20</td> <td>T - 05</td> </tr> </table>	Emërtimi i Fletës:	Shkalla:	Tiranë 2021	PROFILI TERTHORE TIP	Sh - 1:20	T - 05
Emërtimi i Fletës:	Shkalla:	Tiranë 2021						
PROFILI TERTHORE TIP	Sh - 1:20	T - 05						

PROFILI TERTHORE TIP

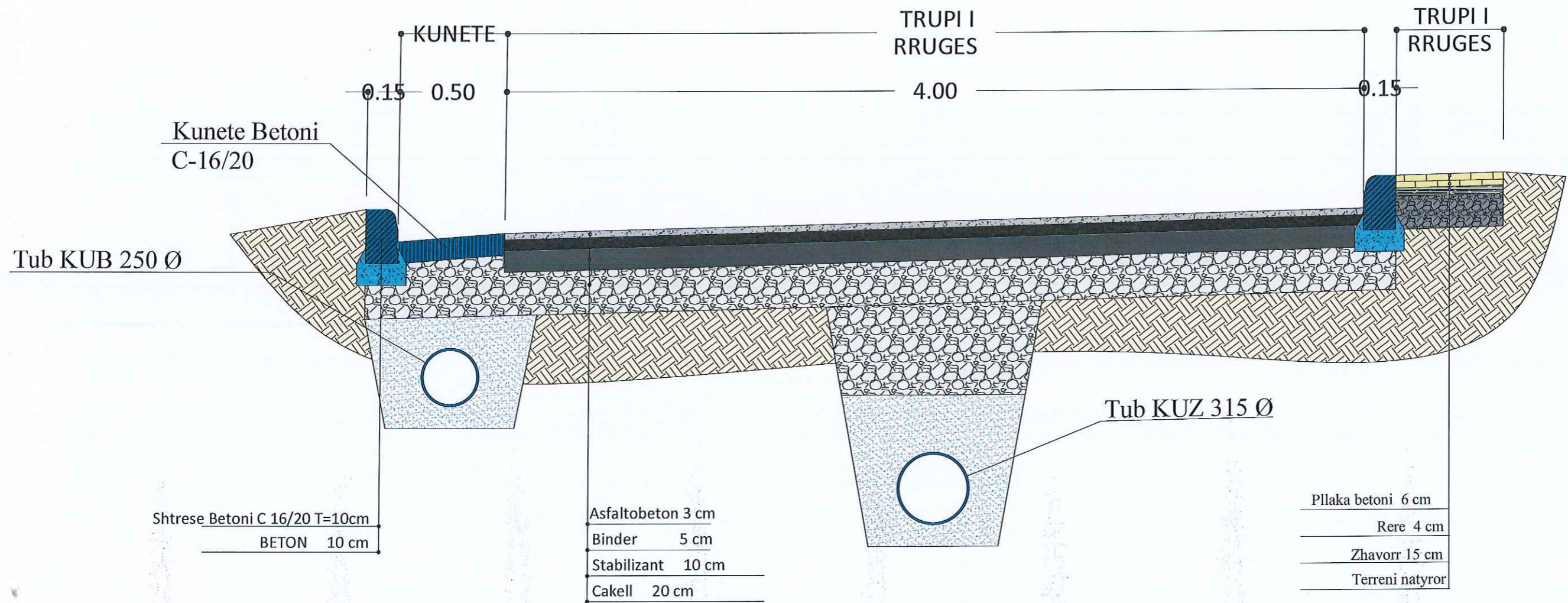

Shtrese Betoni C 16/20 T=10cm
BETON 10 cm



Asfaltobeton 3 cm
Binder 5 cm
Stabilizant 10 cm
Cakell 20 cm

Pllaka betoni 6 cm
Rere 4 cm
Zhavorr 15 cm
Terreni natyror

<p>Porositi:</p>  <p>Bashkia Vau Dejës</p>	<p>Projektori:</p> <p style="color: red; font-weight: bold;">"LENI-ING" sh.p.k</p> <p>Administrator Ing. Nikoll Paluca</p> <p>Adresa: Tirane</p> <p>Mobile: 068 20 42 270</p> <p>Email: leni.ing@hotmail.com</p> <p style="color: red; font-weight: bold;">PROJEKTIM LENI-ING AUDITIM NIS: J88730334W</p>	<p>Objekti: Rikonstrukcion i rrugeve te lagjeve Lisen, Kinoklubi, Bishaj, Tanushi</p> <p>Faza: Projekt - Zbatimi</p> <table style="width: 100%; border-collapse: collapse;"> <tr> <td style="width: 33%;">Emërtimi i Fletës:</td> <td style="width: 33%;">Shkalla:</td> <td style="width: 33%;">Tiranë 2021</td> </tr> <tr> <td>PROFILI TERTHORE TIP</td> <td>Sh - 1:20</td> <td>T - 06</td> </tr> </table>	Emërtimi i Fletës:	Shkalla:	Tiranë 2021	PROFILI TERTHORE TIP	Sh - 1:20	T - 06
Emërtimi i Fletës:	Shkalla:	Tiranë 2021						
PROFILI TERTHORE TIP	Sh - 1:20	T - 06						

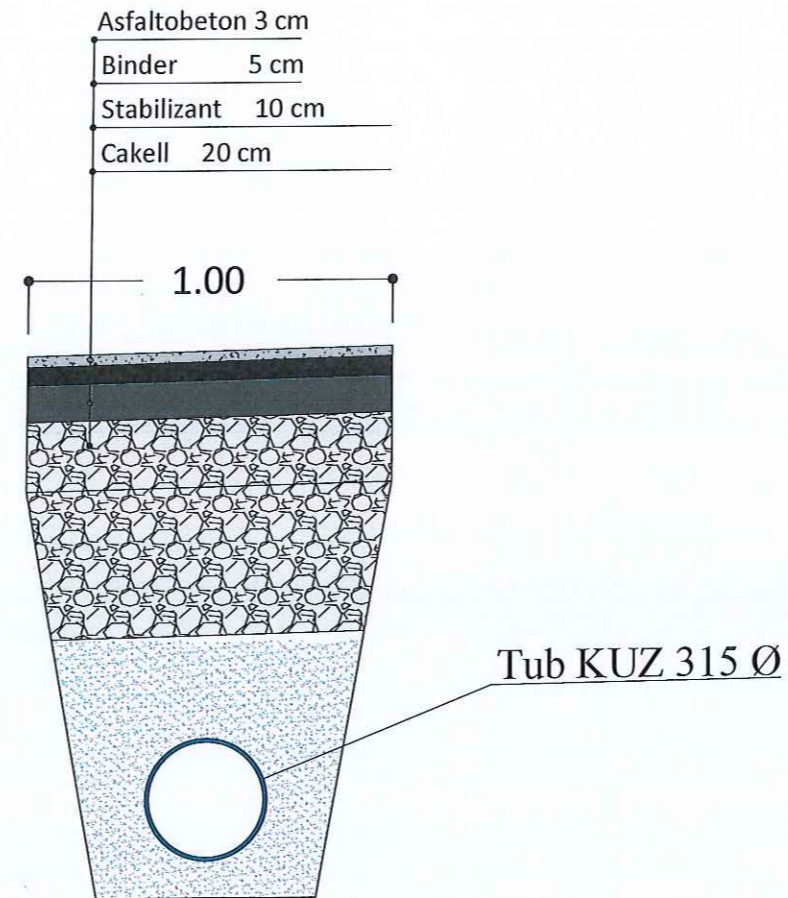
PROFILI TERTHORE TIP



Porositi:  Bashkia Vau Dejes	Projektoi: "LENI-ING" sh.p.k Administrator Ing. Nikoll Paluca Adresa: Tirane Mobile: 068 20 42 270 Email: leni.ing@hotmail.com 	Objekti: Rikonstrukcion i rrugeve te lagjeve Lisen, Kinoklubi, Bishaj, Tanushi Faza: Projekt - Zbatimi Emërtimi i Fletës: PROFILI TERTHORE TIP Shkalla: Sh - 1:20 Tiranë 2021 T - 07
---	--	--

PROFILI TERTHORE TIP

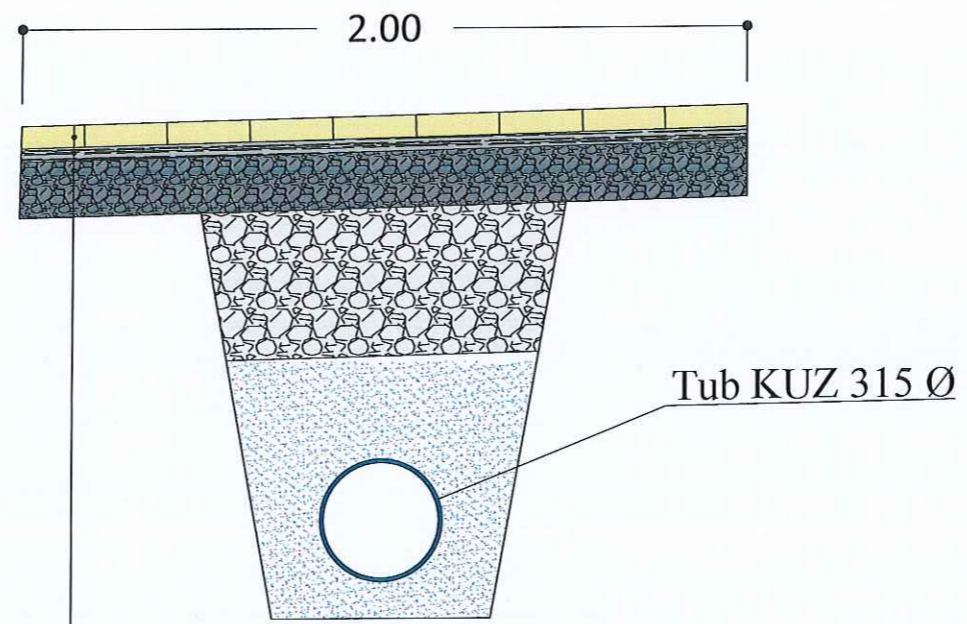

- Pllaka betoni 6 cm
- Rere 4 cm
- Zhavorr 15 cm
- Terreni natyror

Porositi:



Bashkia Vau Dejes

Projektçi:

PROJEKTIM
"LENI-ING" sh.p.k
 Administrator Ing. Nikoll Paluca
 Adresa: Tirane
 Mobile: 068 20 42 270
 Email: leni.ing@hotmail.com
KLAUDIM
NUIS: J88730334W

Objekti: Rikonstruksion i rrugeve te lagjeve Lisen, Kinoklubi, Bishaj, Tanushi

Faza: **Projekt - Zbatimi**

Emërtimi i Fletës: PROFILI TERTHORE TIP	Shkalla: Sh - 1:20	Tiranë 2023 T - 08
---	-----------------------	-----------------------