



# TEATRI "ALEKSANDËR MOISIU", DURRËS PROJEKTI HIDROTEKNIK

PRONËSIA PR										
INVESTITOR  BASHKIA DURRES										
PROJEKTIIMI ARKITEKTONIK MICHELE CRO ARCH. ASA ARCHITECTS BRINGING SPACE TO LIFE										
SHËNIME										
<table border="1"><thead><tr><th>NO</th><th>DATA</th><th>REDAKTORE</th><th>REVIZORE</th><th>APROVATORE</th></tr></thead><tbody><tr><td> </td><td> </td><td> </td><td> </td><td> </td></tr></tbody></table>	NO	DATA	REDAKTORE	REVIZORE	APROVATORE					
NO	DATA	REDAKTORE	REVIZORE	APROVATORE						
PLAN REFERENCE 										
SHËNIMI PALLATI KILLIURIS "ALEKSANDER MOISIU" PROJEKTI ARKITEKTONIK PROJEKTI HIDROTEKNIK LINDORJA E SHËNIMIT SHËNIMI: 1/100 SKALA: 1/100 DATA:										



# PLANIMETRIA E PËRGJITHSHME E NDËRTESES (SISTEMI I FURNIZIMIT ME UJË TË PIJSHËM)

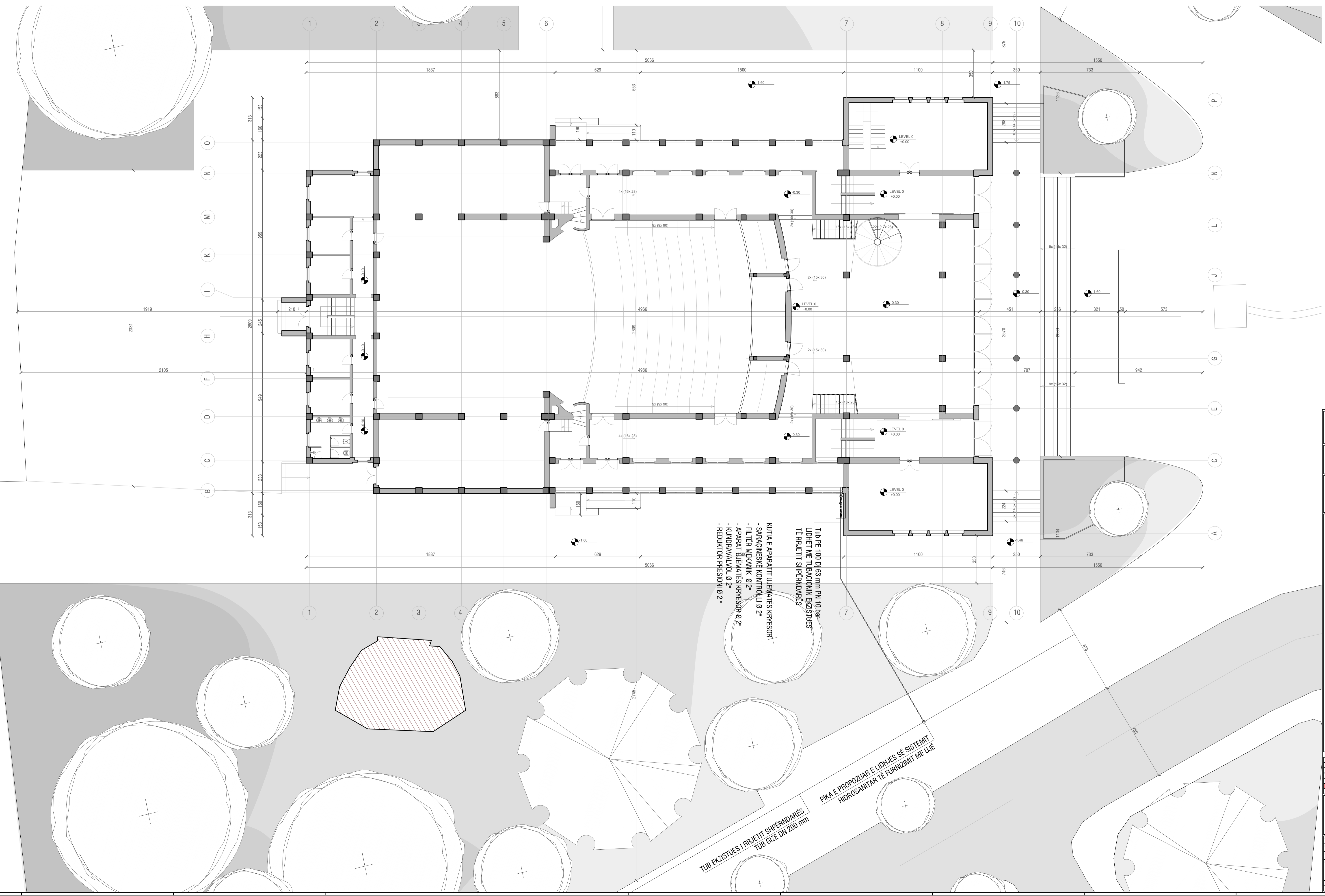

PRONËSIA  
PR

INVESTITOR  

 BASHKIA E DURRËS

PROJEKTI ARKITEKTONIK  
 MICHELE CRO ARCH.  
 ASA ARCHITECTS  
 BRINDING SPACE TO LIFE

SHËNIME

NO.	SHËNIMET

**PLAN REFERENCE**

SH. 001  
 SH. 002  
 SH. 003  
 SH. 004  
 SH. 005  
 SH. 006  
 SH. 007  
 SH. 008  
 SH. 009  
 SH. 010

# PLANIMETRIA E KATIT NIV -2.55 TË NDËRTESES (SISTEMI I FURNIZIMIT ME UJË TË PIJSHËM)

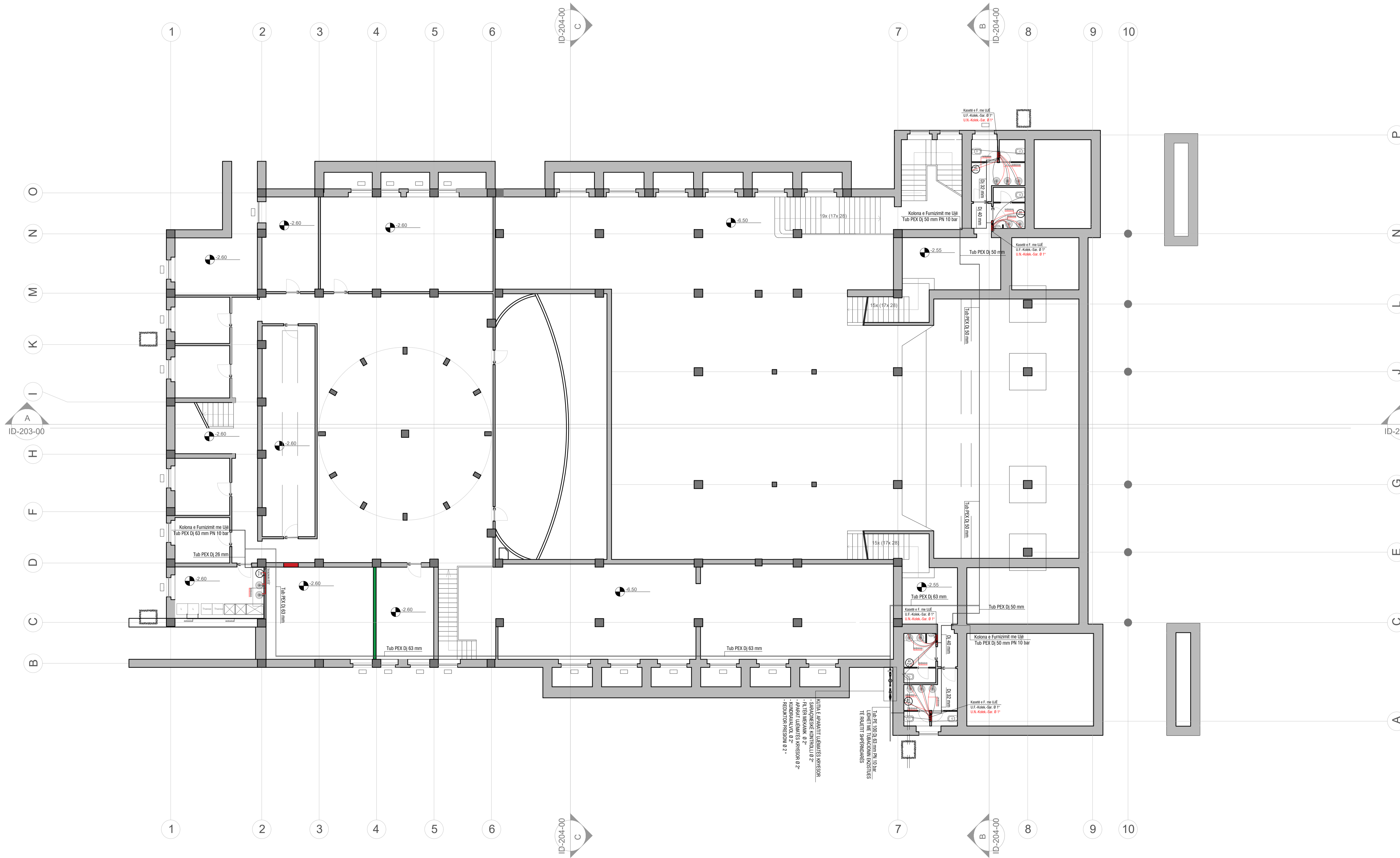

KUTIA E APARATIT LULETAKES SHPRESONOR  
 - SHPRESONOR KOMBINUES  
 - APARAT LULETAKES SHPRESONOR 0.2"  
 - KUNDRIKALLORE 0.2"  
 - REDUKTORI PRESIONI 0.2"

LOKETI ME TUBORIN EKSPONUES  
 TE FURNIZIMIT ME UJE  
 TE FURNIZIMIT ME UJE

PRONESIA PR	INVESTITOR BANKA QIBES																																												
PROJEKTI ARKITEKTONIK MICHELE CRO ARCH. ASA ARCHITECTS BRINGING SPACE TO LIFE	SHENIME																																												
<table border="1"> <thead> <tr> <th>NO</th> <th>REKUIZITET</th> <th>STATUSI</th> <th>DATA</th> </tr> </thead> <tbody> <tr> <td>1</td> <td></td> <td></td> <td></td> </tr> <tr> <td>2</td> <td></td> <td></td> <td></td> </tr> <tr> <td>3</td> <td></td> <td></td> <td></td> </tr> <tr> <td>4</td> <td></td> <td></td> <td></td> </tr> <tr> <td>5</td> <td></td> <td></td> <td></td> </tr> <tr> <td>6</td> <td></td> <td></td> <td></td> </tr> <tr> <td>7</td> <td></td> <td></td> <td></td> </tr> <tr> <td>8</td> <td></td> <td></td> <td></td> </tr> <tr> <td>9</td> <td></td> <td></td> <td></td> </tr> <tr> <td>10</td> <td></td> <td></td> <td></td> </tr> </tbody> </table>		NO	REKUIZITET	STATUSI	DATA	1				2				3				4				5				6				7				8				9				10			
NO	REKUIZITET	STATUSI	DATA																																										
1																																													
2																																													
3																																													
4																																													
5																																													
6																																													
7																																													
8																																													
9																																													
10																																													
PLAN REFERENCE	<p>PLAN REFERENCE</p> <p>Titulli i KATIT: "ALEXANDER MOJTI"          Nr. i projektit: 02          Autori i projektit: MICHELE CRO ARCH.          Data e miratimit: 15.05.2024          Përshkrimi i kësaj referencë: 2.55 m Shtetësi i Furnizimit me Uje</p>																																												

PLANIMETRIA E KATIT NIV ±0.00 TË NDËRTESËS  
(SISTEMI I FURNIZIMIT ME UJË TË PIJSHËM)

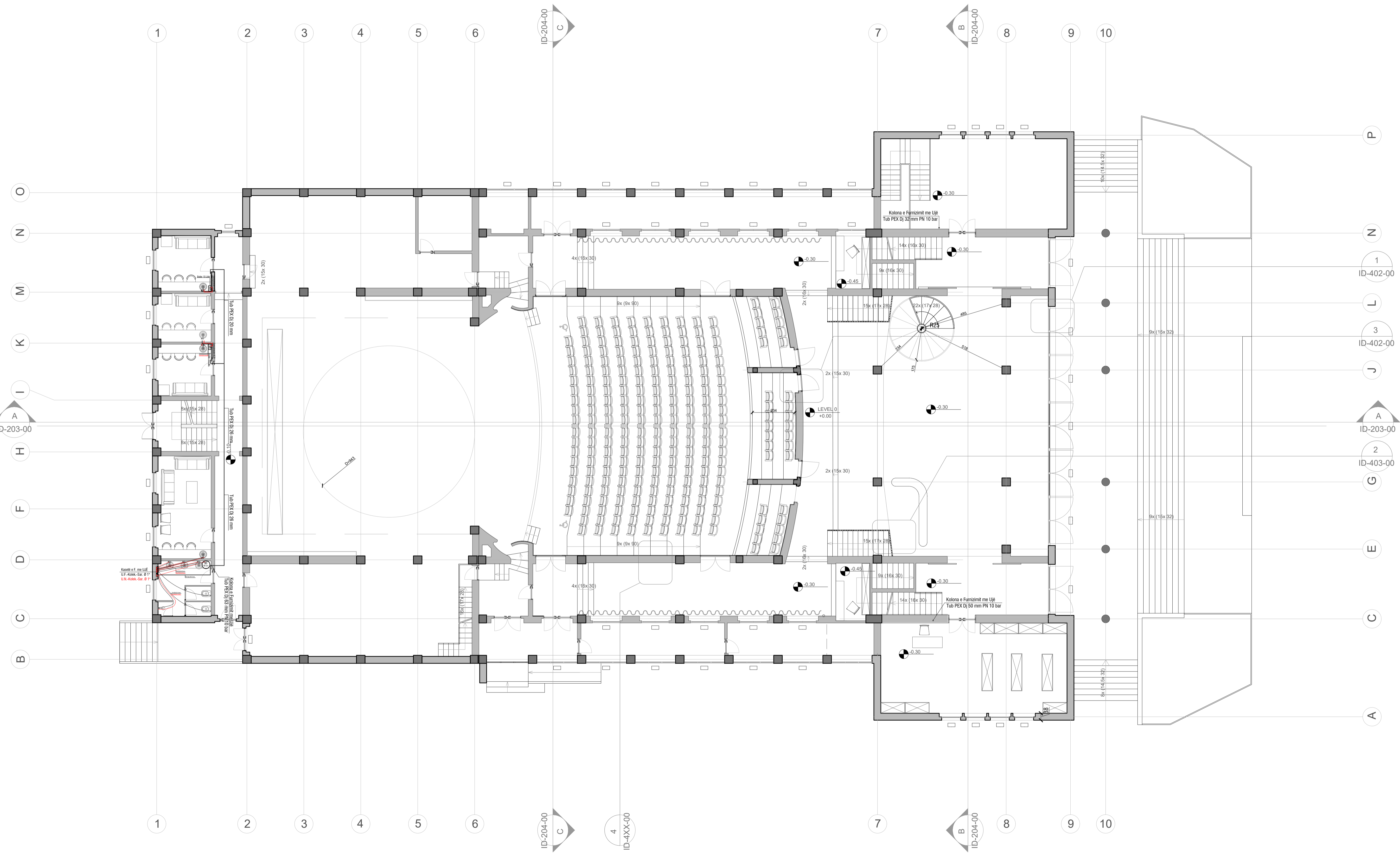

PRONËSIA  
PR

INVESTITOR  
Bashkia e Durrës  
BASHKIA E DURRËS

PROJEKTI ARKITEKTONIK  
MICHELE CRO ARCH.  
ASA ARCHITECTS  
BRINGING SPACE TO LIFE

SHËNIME

№	Titulli	Forma	Skala	Detaj

PLAN REFERENCE

Projekti: "PALLATI-KULTURE "ALEXANDER MOISIU"  
Pjesë e projektit: "PROJEKTI ZBATIM"  
Forma e shprehjes: 2D  
Mbledhja e parashprehjes: 03  
Përshprehja e saj parashprehjes: 14/15  
Përshprehja e saj parashprehjes përfundimtare: 03  
Shënim: 1:1/2020/03/04



PLANIMETRIA E KATIT NIV +7.36 TË NDËRTESËS  
(SISTEMI I FURNIZIMIT ME UJË TË PIJSHËM)

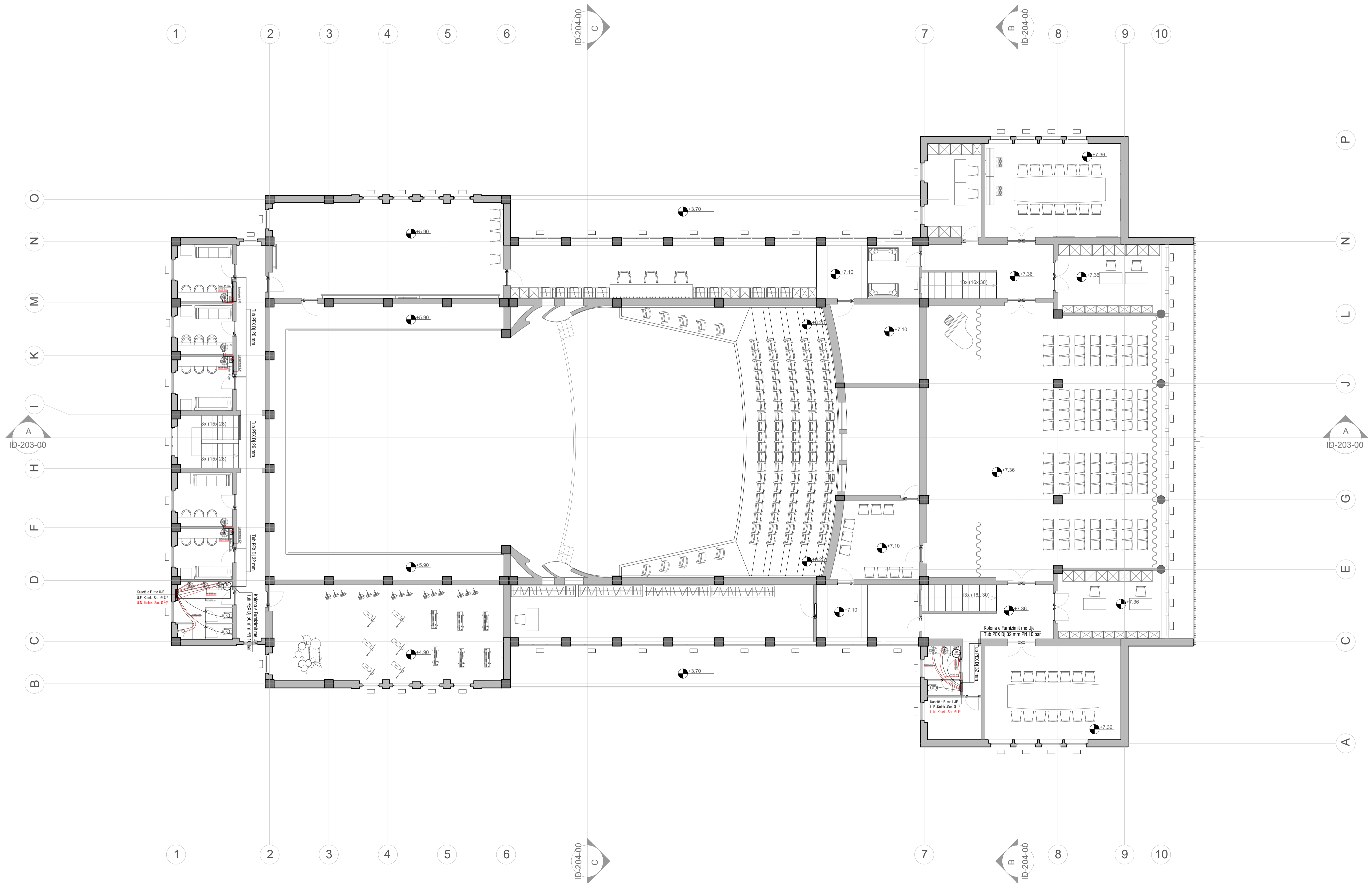

**PRONËSIA**  
PR

**INVESTITOR**  
BANKA QUBES

**PROJEKTI ARKITEKTONIK**  
MICHELE CRO ARCH.  
ASA ARCHITECTS  
BRINGING SPACE TO LIFE

**SHENIME**

NO	SHENIMET	DATA

**PLAN REFERENCE**

PLAN: "PALLATI KULTURES 'ALEKSANDER MOJTI'"  
 Nr. i projektit: "PROJEKTI 2020/01"  
 Titulli i dokumentit: "SISTEMI I FURNIZIMIT ME UJE"  
 Niveli i dokumentit: "01"  
 Përshkrimi i kësaj të qelbi: "+7.36. Sistemi i furnizimit me ujë"  
 Nr. i dokumentit: "01"  
 Titulli: "01/01"

PLANIMETRIA E PËRGJITHSHME E NDËRTESES  
(SISTEMI I KANALIZIMIT TË UJËRAVE TË NDOTURA)

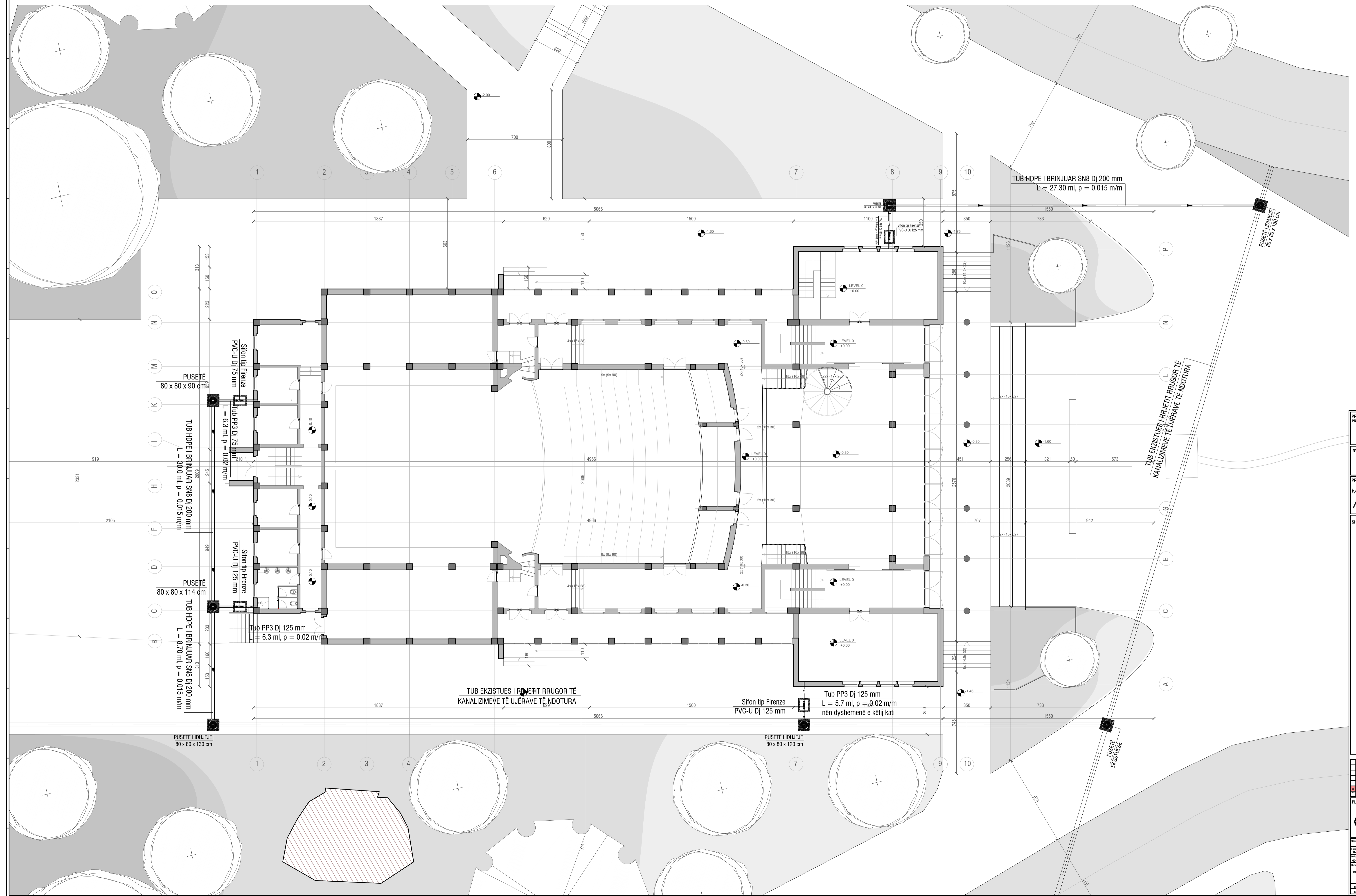

PRONËSIA	PA								
INVESTITOR	BASHKIA QUBES								
PROJEKTIMI ARKITEKTONIK	MICHELE CRO ARCH.								
	ASA ARCHITECTS BRIDGING SPACE TO LIFE								
SHENIME									
<table border="1"> <tr> <th>NO</th> <th>REKORDE</th> <th>DATE</th> <th>REVIZIONE</th> </tr> <tr> <td> </td> <td> </td> <td> </td> <td> </td> </tr> </table>		NO	REKORDE	DATE	REVIZIONE				
NO	REKORDE	DATE	REVIZIONE						
PLAN REFERENCE									
<small>                 SHENJE: 1. 2. 3. 4. 5. 6. 7. 8. 9. 10. 11. 12. 13. 14. 15. 16. 17. 18. 19. 20. 21. 22. 23. 24. 25. 26. 27. 28. 29. 30. 31. 32. 33. 34. 35. 36. 37. 38. 39. 40. 41. 42. 43. 44. 45. 46. 47. 48. 49. 50. 51. 52. 53. 54. 55. 56. 57. 58. 59. 60. 61. 62. 63. 64. 65. 66. 67. 68. 69. 70. 71. 72. 73. 74. 75. 76. 77. 78. 79. 80. 81. 82. 83. 84. 85. 86. 87. 88. 89. 90. 91. 92. 93. 94. 95. 96. 97. 98. 99. 100. 101. 102. 103. 104. 105. 106. 107. 108. 109. 110. 111. 112. 113. 114. 115. 116. 117. 118. 119. 120. 121. 122. 123. 124. 125. 126. 127. 128. 129. 130. 131. 132. 133. 134. 135. 136. 137. 138. 139. 140. 141. 142. 143. 144. 145. 146. 147. 148. 149. 150. 151. 152. 153. 154. 155. 156. 157. 158. 159. 160. 161. 162. 163. 164. 165. 166. 167. 168. 169. 170. 171. 172. 173. 174. 175. 176. 177. 178. 179. 180. 181. 182. 183. 184. 185. 186. 187. 188. 189. 190. 191. 192. 193. 194. 195. 196. 197. 198. 199. 200. 201. 202. 203. 204. 205. 206. 207. 208. 209. 210. 211. 212. 213. 214. 215. 216. 217. 218. 219. 220. 221. 222. 223. 224. 225. 226. 227. 228. 229. 230. 231. 232. 233. 234. 235. 236. 237. 238. 239. 240. 241. 242. 243. 244. 245. 246. 247. 248. 249. 250. 251. 252. 253. 254. 255. 256. 257. 258. 259. 260. 261. 262. 263. 264. 265. 266. 267. 268. 269. 270. 271. 272. 273. 274. 275. 276. 277. 278. 279. 280. 281. 282. 283. 284. 285. 286. 287. 288. 289. 290. 291. 292. 293. 294. 295. 296. 297. 298. 299. 300. 301. 302. 303. 304. 305. 306. 307. 308. 309. 310. 311. 312. 313. 314. 315. 316. 317. 318. 319. 320. 321. 322. 323. 324. 325. 326. 327. 328. 329. 330. 331. 332. 333. 334. 335. 336. 337. 338. 339. 340. 341. 342. 343. 344. 345. 346. 347. 348. 349. 350. 351. 352. 353. 354. 355. 356. 357. 358. 359. 360. 361. 362. 363. 364. 365. 366. 367. 368. 369. 370. 371. 372. 373. 374. 375. 376. 377. 378. 379. 380. 381. 382. 383. 384. 385. 386. 387. 388. 389. 390. 391. 392. 393. 394. 395. 396. 397. 398. 399. 400. 401. 402. 403. 404. 405. 406. 407. 408. 409. 410. 411. 412. 413. 414. 415. 416. 417. 418. 419. 420. 421. 422. 423. 424. 425. 426. 427. 428. 429. 430. 431. 432. 433. 434. 435. 436. 437. 438. 439. 440. 441. 442. 443. 444. 445. 446. 447. 448. 449. 450. 451. 452. 453. 454. 455. 456. 457. 458. 459. 460. 461. 462. 463. 464. 465. 466. 467. 468. 469. 470. 471. 472. 473. 474. 475. 476. 477. 478. 479. 480. 481. 482. 483. 484. 485. 486. 487. 488. 489. 490. 491. 492. 493. 494. 495. 496. 497. 498. 499. 500. 501. 502. 503. 504. 505. 506. 507. 508. 509. 510. 511. 512. 513. 514. 515. 516. 517. 518. 519. 520. 521. 522. 523. 524. 525. 526. 527. 528. 529. 530. 531. 532. 533. 534. 535. 536. 537. 538. 539. 540. 541. 542. 543. 544. 545. 546. 547. 548. 549. 550. 551. 552. 553. 554. 555. 556. 557. 558. 559. 560. 561. 562. 563. 564. 565. 566. 567. 568. 569. 570. 571. 572. 573. 574. 575. 576. 577. 578. 579. 580. 581. 582. 583. 584. 585. 586. 587. 588. 589. 590. 591. 592. 593. 594. 595. 596. 597. 598. 599. 600. 601. 602. 603. 604. 605. 606. 607. 608. 609. 610. 611. 612. 613. 614. 615. 616. 617. 618. 619. 620. 621. 622. 623. 624. 625. 626. 627. 628. 629. 630. 631. 632. 633. 634. 635. 636. 637. 638. 639. 640. 641. 642. 643. 644. 645. 646. 647. 648. 649. 650. 651. 652. 653. 654. 655. 656. 657. 658. 659. 660. 661. 662. 663. 664. 665. 666. 667. 668. 669. 670. 671. 672. 673. 674. 675. 676. 677. 678. 679. 680. 681. 682. 683. 684. 685. 686. 687. 688. 689. 690. 691. 692. 693. 694. 695. 696. 697. 698. 699. 700. 701. 702. 703. 704. 705. 706. 707. 708. 709. 710. 711. 712. 713. 714. 715. 716. 717. 718. 719. 720. 721. 722. 723. 724. 725. 726. 727. 728. 729. 730. 731. 732. 733. 734. 735. 736. 737. 738. 739. 740. 741. 742. 743. 744. 745. 746. 747. 748. 749. 750. 751. 752. 753. 754. 755. 756. 757. 758. 759. 760. 761. 762. 763. 764. 765. 766. 767. 768. 769. 770. 771. 772. 773. 774. 775. 776. 777. 778. 779. 780. 781. 782. 783. 784. 785. 786. 787. 788. 789. 790. 791. 792. 793. 794. 795. 796. 797. 798. 799. 800. 801. 802. 803. 804. 805. 806. 807. 808. 809. 810. 811. 812. 813. 814. 815. 816. 817. 818. 819. 820. 821. 822. 823. 824. 825. 826. 827. 828. 829. 830. 831. 832. 833. 834. 835. 836. 837. 838. 839. 840. 841. 842. 843. 844. 845. 846. 847. 848. 849. 850. 851. 852. 853. 854. 855. 856. 857. 858. 859. 860. 861. 862. 863. 864. 865. 866. 867. 868. 869. 870. 871. 872. 873. 874. 875. 876. 877. 878. 879. 880. 881. 882. 883. 884. 885. 886. 887. 888. 889. 890. 891. 892. 893. 894. 895. 896. 897. 898. 899. 900. 901. 902. 903. 904. 905. 906. 907. 908. 909. 910. 911. 912. 913. 914. 915. 916. 917. 918. 919. 920. 921. 922. 923. 924. 925. 926. 927. 928. 929. 930. 931. 932. 933. 934. 935. 936. 937. 938. 939. 940. 941. 942. 943. 944. 945. 946. 947. 948. 949. 950. 951. 952. 953. 954. 955. 956. 957. 958. 959. 960. 961. 962. 963. 964. 965. 966. 967. 968. 969. 970. 971. 972. 973. 974. 975. 976. 977. 978. 979. 980. 981. 982. 983. 984. 985. 986. 987. 988. 989. 990. 991. 992. 993. 994. 995. 996. 997. 998. 999. 1000.             </small>									





PLANIMETRIA E KATIT PËRDHE ±0.00 TË NDËRTESËS  
(SISTEMI I KANALIZIMIT TË UJËRAVE TË NDOTURA)

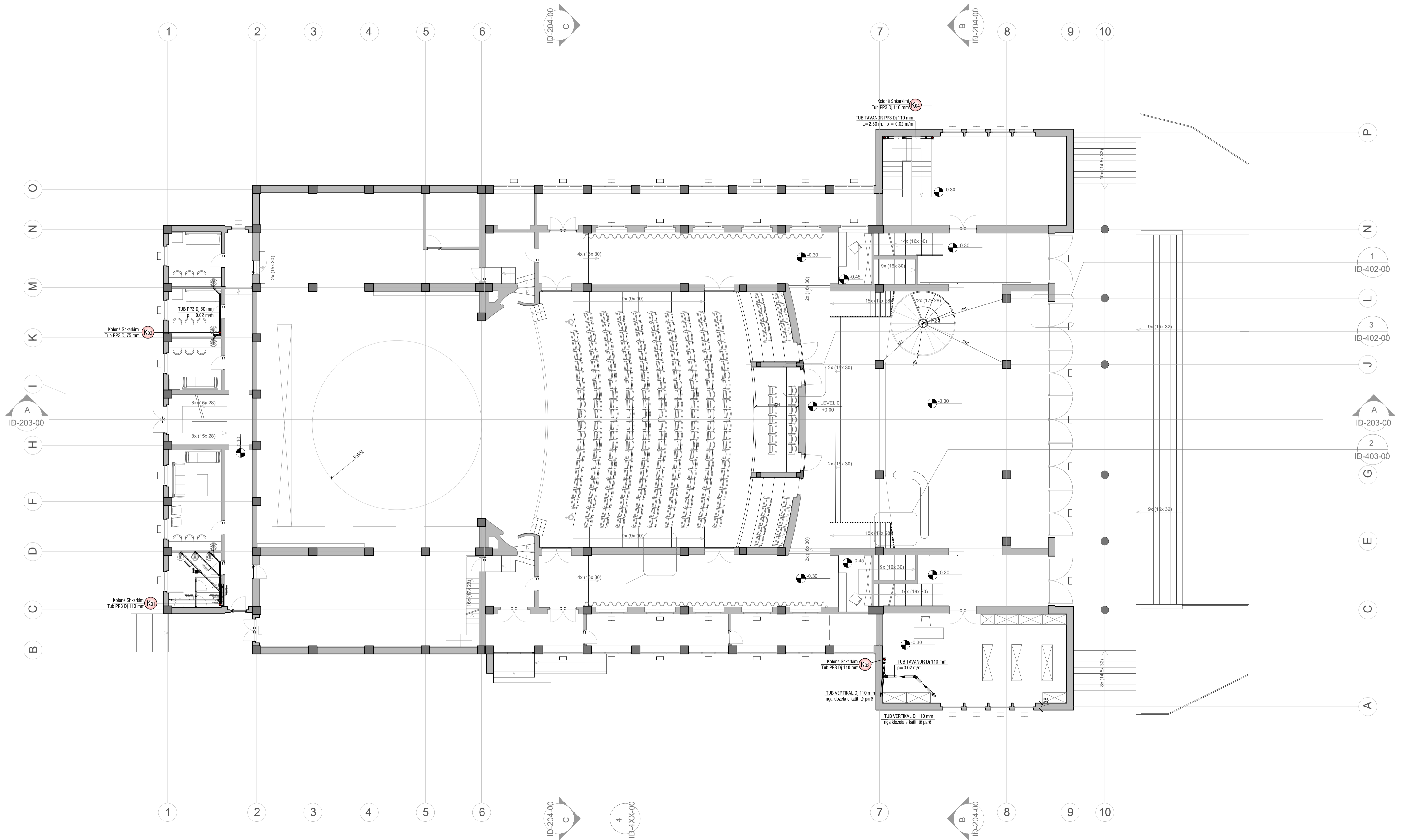

PRONËSIA  
PR

INVESTITOR  
BASHKIA DUISË

PROJEKTI ARKITEKTONIK  
MICHELE CRO ARCH.  
ASA ARCHITECTS  
BRINGING SPACE TO LIFE

SHËNIME

NO.	REMARKS

PLAN REFERENCE

Titulli i punës: "PALLATI I KULTURISË 'ALEKSANDER MOJËVI'"  
 Niveli i punës: PROJEKT 2-BASHKIM  
 Projektuesi: MICHELE CRO ARCH. ASA ARCHITECTS  
 Data e punës: 2024  
 Parashikimi i këtij plani është i bashkuar me sistemin e kanalizimit të ujërave të ndotura.

Shprehësi: M. CRO  
 Titulli: SHprehësi

PLANIMETRIA E KATIT NIV +3.62 TË NDËRTESES  
(SISTEMI I KANALIZIMIT TË UJËRAVE TË NDOTURA)

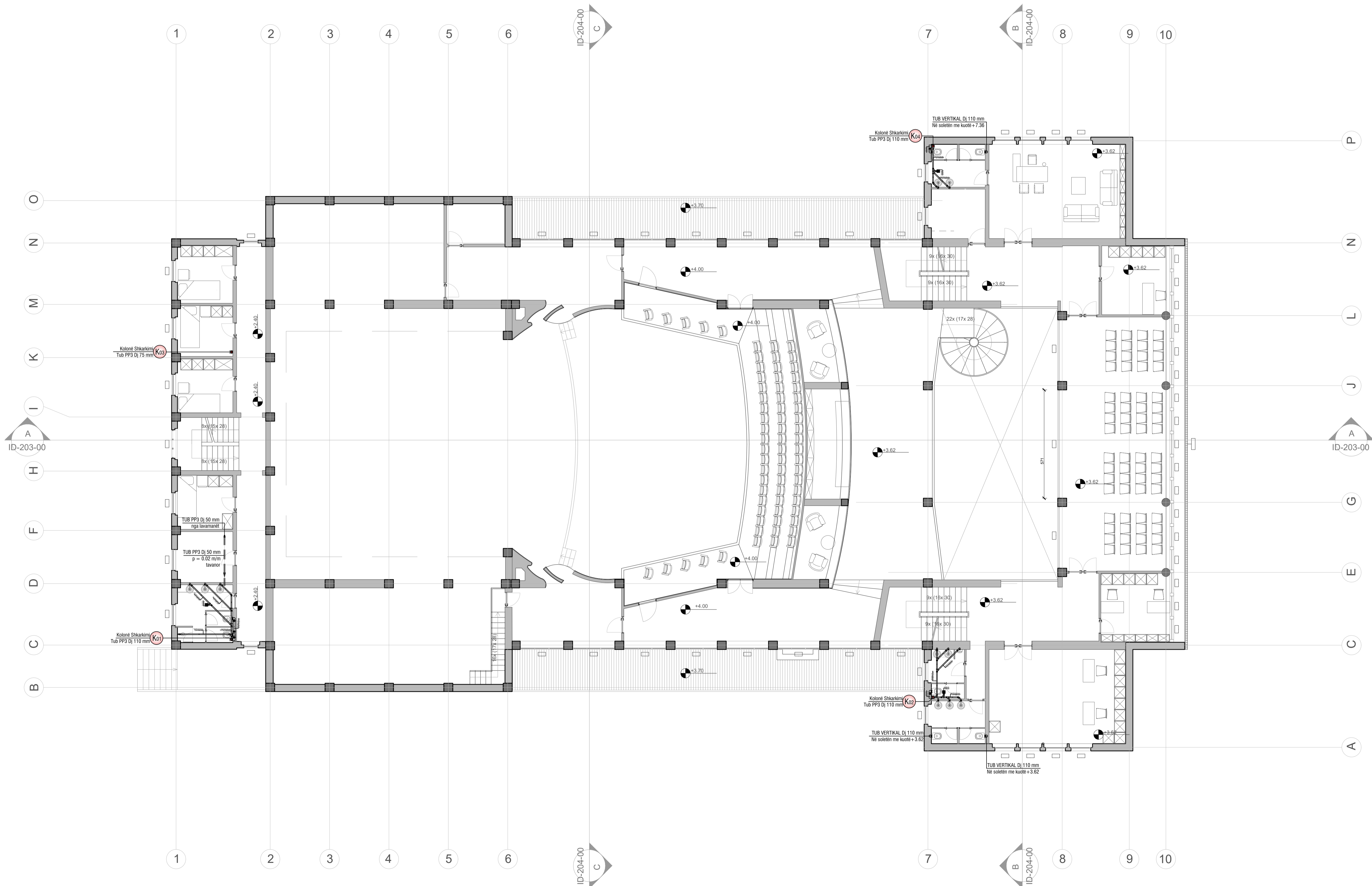

**PRONESIA**  
PR

**INVESTITOR**  
BASHKIA QUBES

**PROJEKTI ARKITEKTONIK**  
MICHELE CRO ARCH.  
ASA ARCHITECTS  
BRIDGING SPACE TO LIFE

**SHENIME**

NO	SHENIMET	DATA	STATUS

**PLAN REFERENCE**

Titulli: "PALLATI I KULTURES 'ALEKSANDER MOJTI"  
 Projekti: "PROJEKTI ZEMTAR"  
 Projektuesi: ASA ARCHITECTS  
 Niveli dhe shtesa: 01  
 Planimetria e katit Niv +3.62: Sistemi i kanalizimit te DN

PLANIMETRIA E KATIT NIV +7.36 TË NDËRTESES  
(SISTEMI I KANALIZIMIT TË UJËRAVE TË NDOTURA)

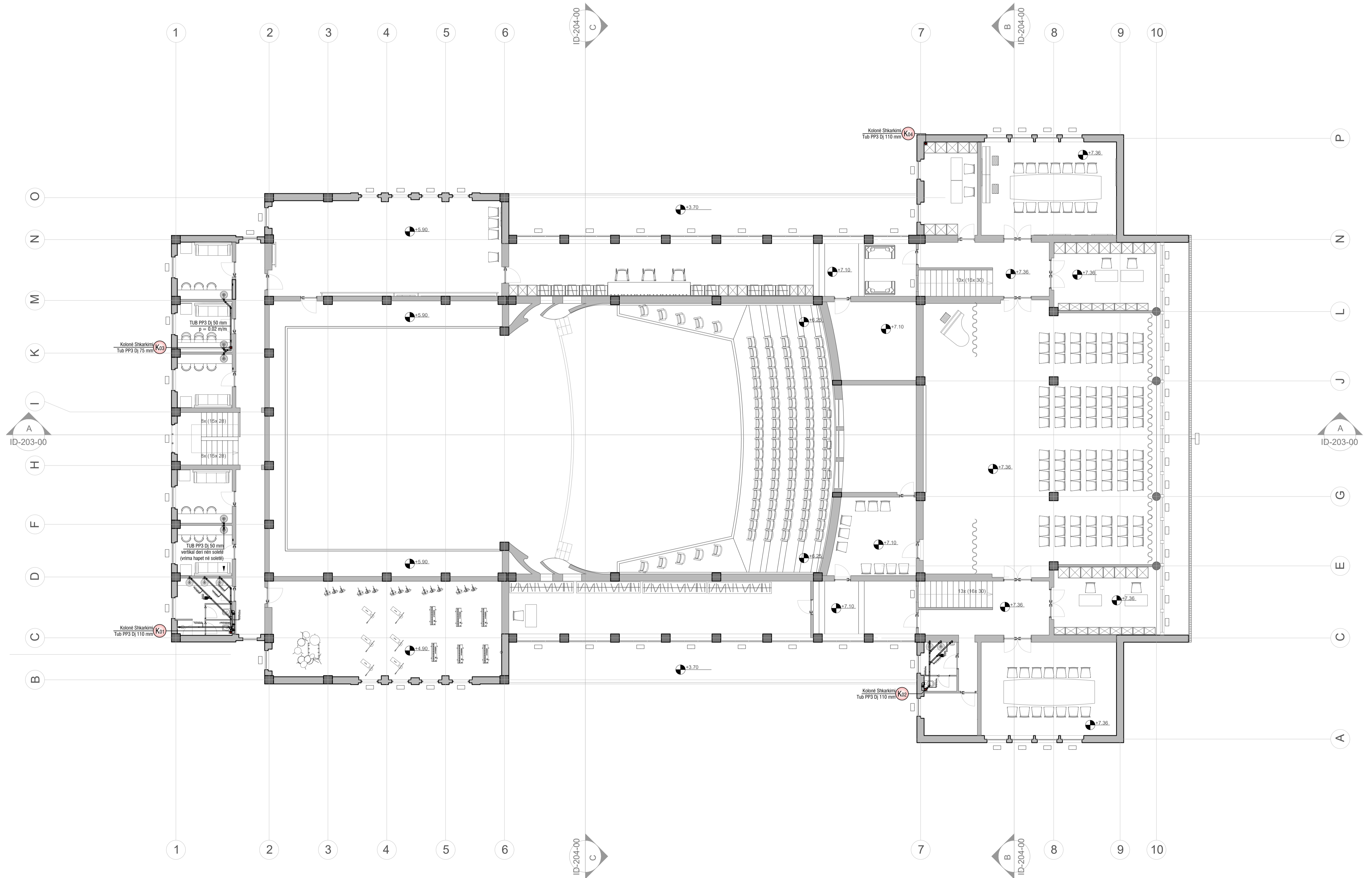

PRONËSIA PR																					
INVESTITOR BANKIA QUBES																					
PROJEKTI ARKITEKTONIK MICHELE CRO ARCH. ASA ARCHITECTS BRINGING SPACE TO LIFE																					
SHËNIME																					
<table border="1"> <thead> <tr> <th>NO.</th> <th>DESKRIMET</th> <th>DATA</th> <th>STATUSI</th> </tr> </thead> <tbody> <tr> <td> </td> <td> </td> <td> </td> <td> </td> </tr> <tr> <td> </td> <td> </td> <td> </td> <td> </td> </tr> <tr> <td> </td> <td> </td> <td> </td> <td> </td> </tr> <tr> <td> </td> <td> </td> <td> </td> <td> </td> </tr> </tbody> </table>		NO.	DESKRIMET	DATA	STATUSI																
NO.	DESKRIMET	DATA	STATUSI																		
PLAN REFERENCE																					
<p>Shënime:</p> <p>1. Niveli i kësaj planimetrije është +7.36 m. Shikoni i saktësisht të tërë shënime të tjera të kësaj planimetrije.</p> <p>2. Niveli i kësaj planimetrije është +7.36 m. Shikoni i saktësisht të tërë shënime të tjera të kësaj planimetrije.</p>																					

SISTEMET HIDROSANITARE TË BANJAVE TË NDËRTESESË

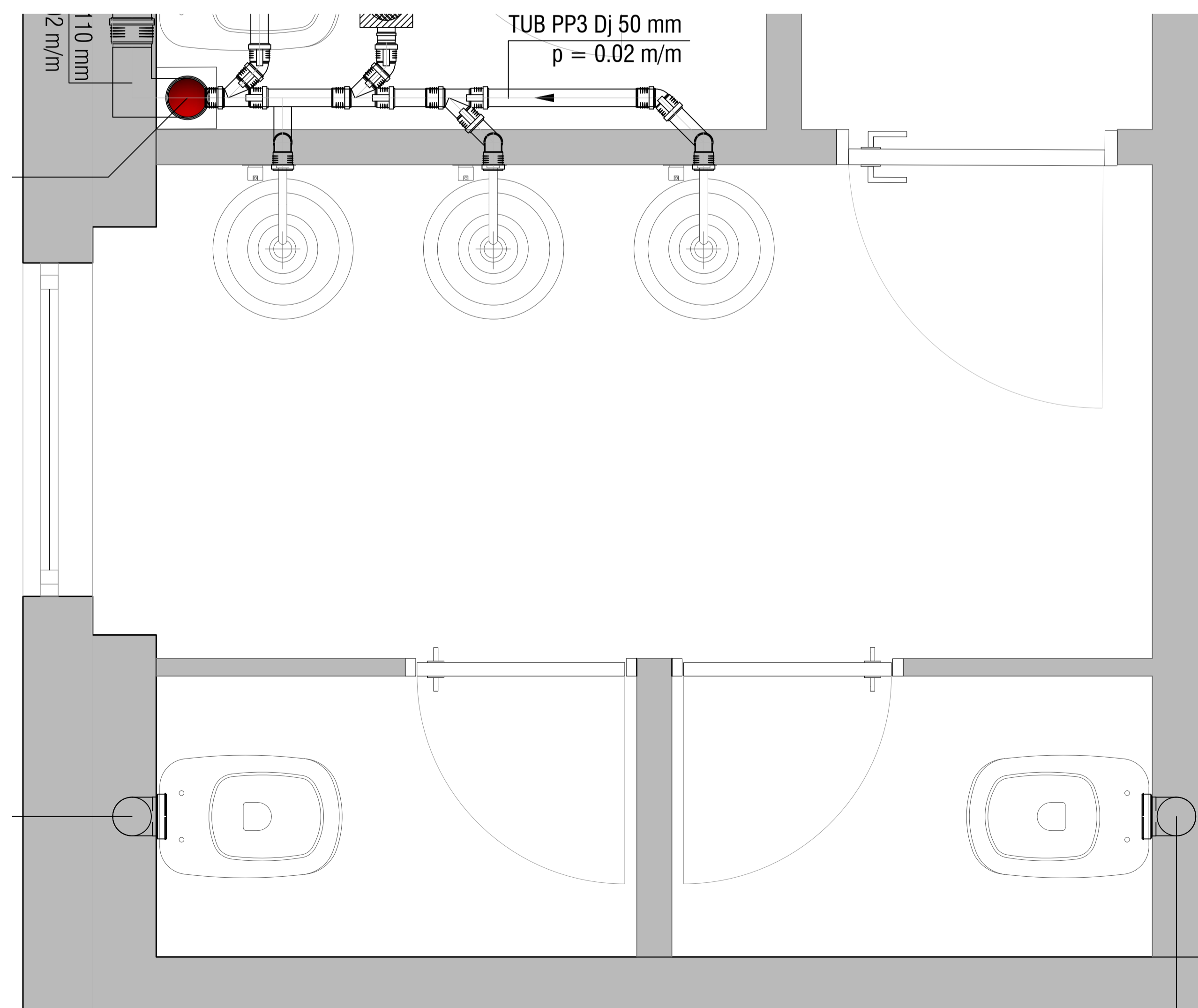
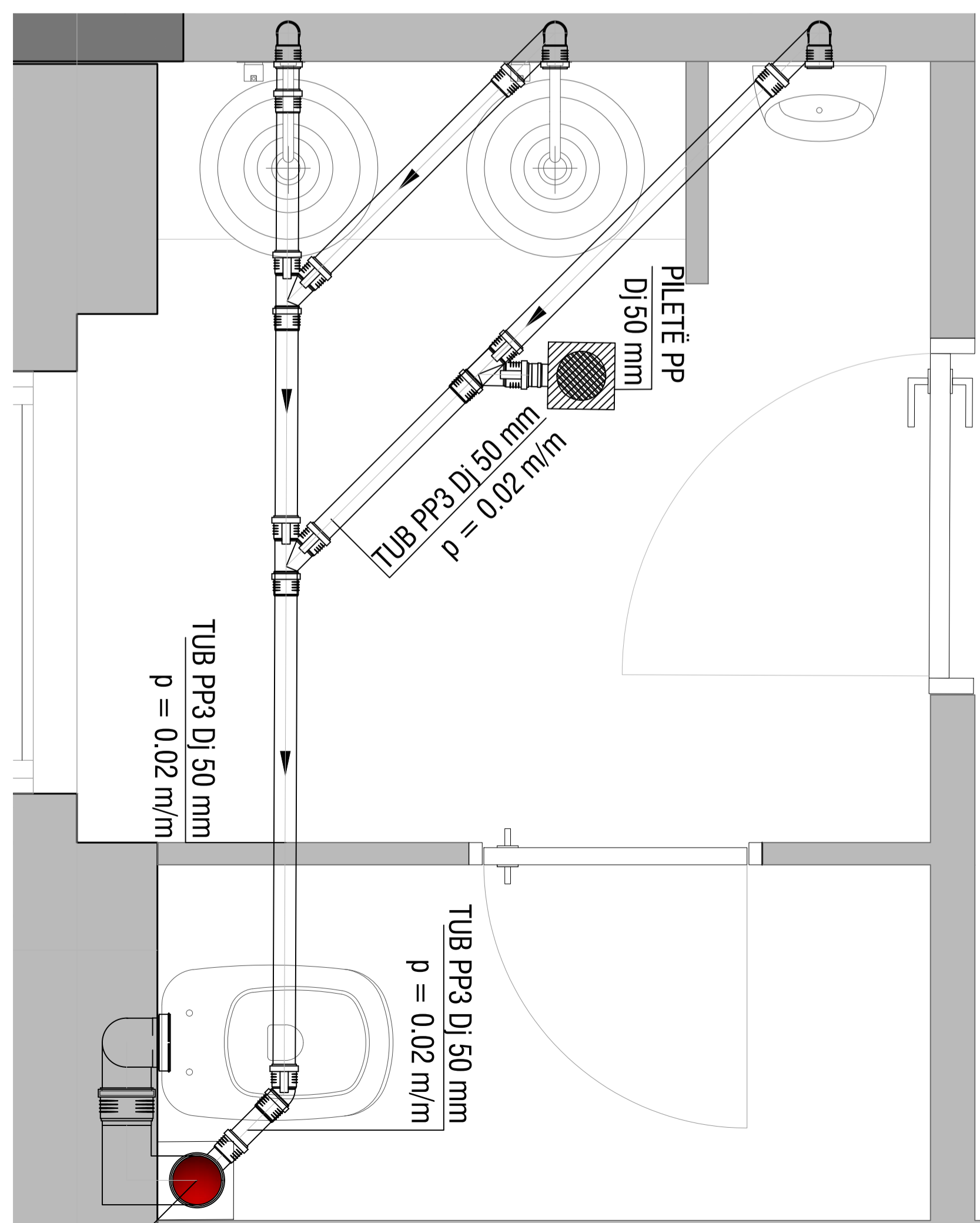
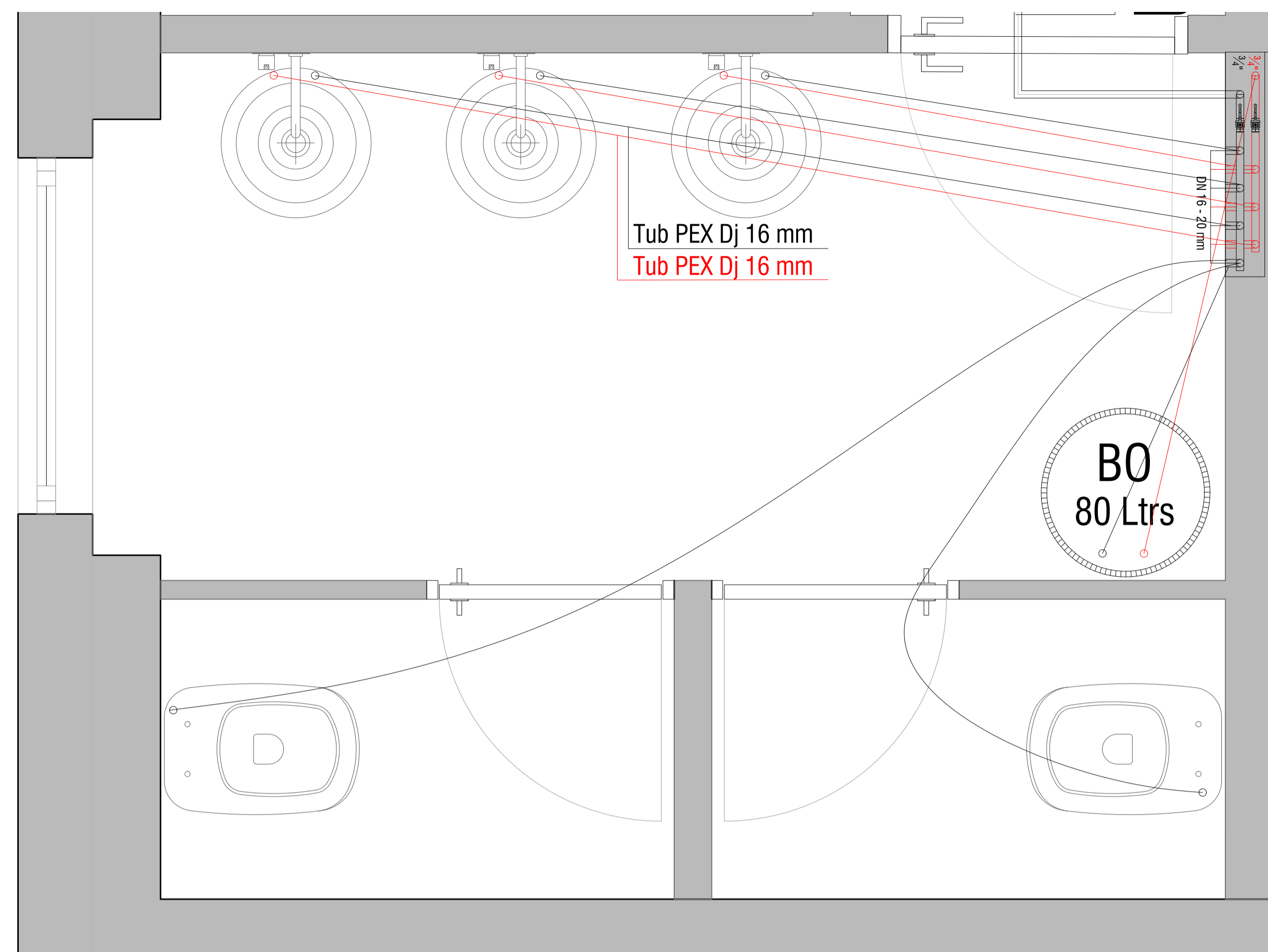
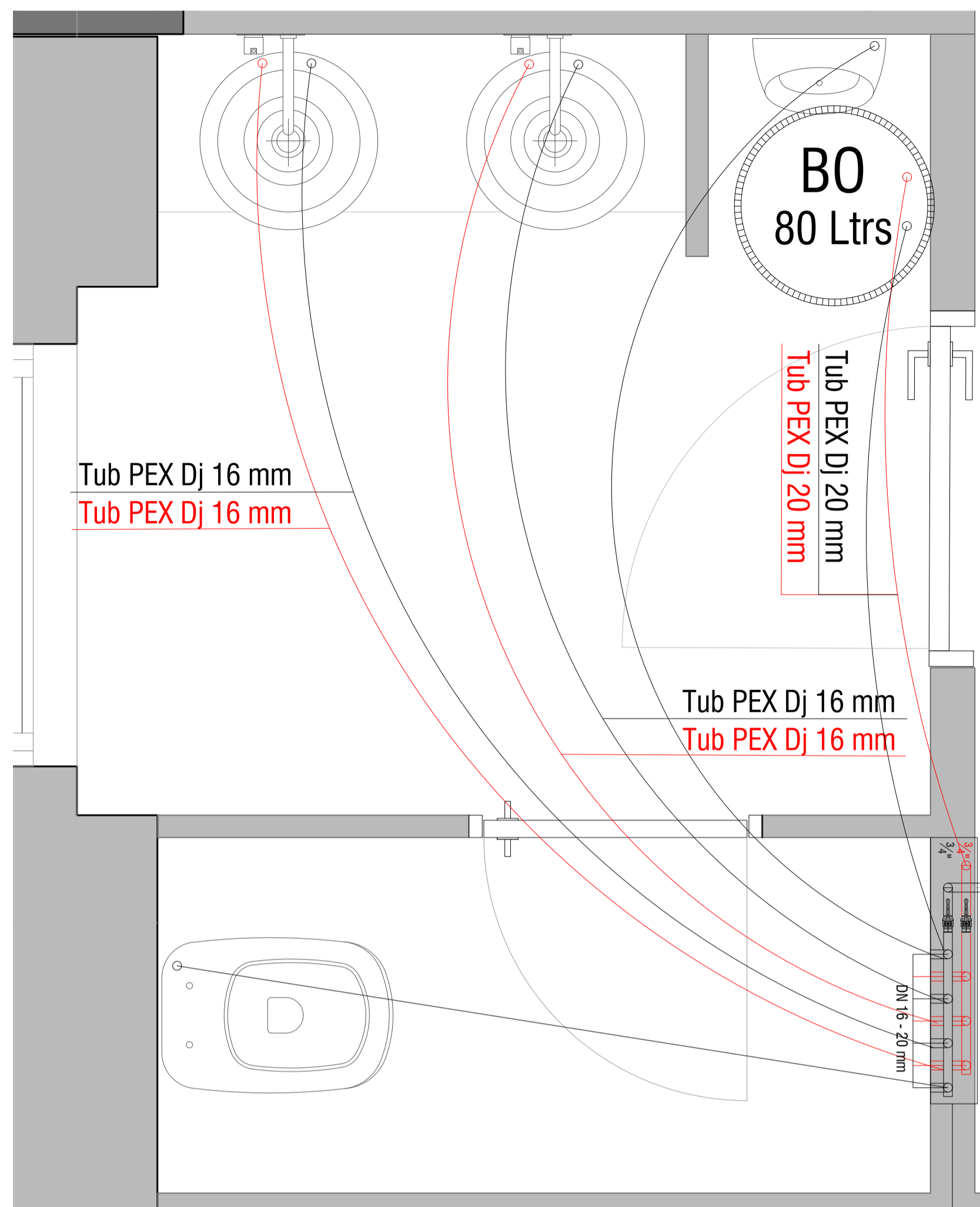

PRONËSIA  
PR

INVESTITOR  
BARRIA OUBES

PROJEKTI ARKITEKTONIK  
MICHELE CRO ARCH.  
ASA ARCHITECTS  
BRINGING SPACE TO LIFE

SHËNIME

NO	SHËNIMET
1	
2	
3	
4	
5	
6	
7	
8	
9	
10	

PLAN REFERENCE

PRONËSIA: BARRIA OUBES  
PROJEKTI ARKITEKTONIK: MICHELE CRO ARCH.  
ASA ARCHITECTS  
BRINGING SPACE TO LIFE  
SHËNIME: SHËNIME  
NO: NO  
SHËNIMET: SHËNIMET

SISTEMET HIDROSANITARE TË BANJAVE TË NDËRTESESË

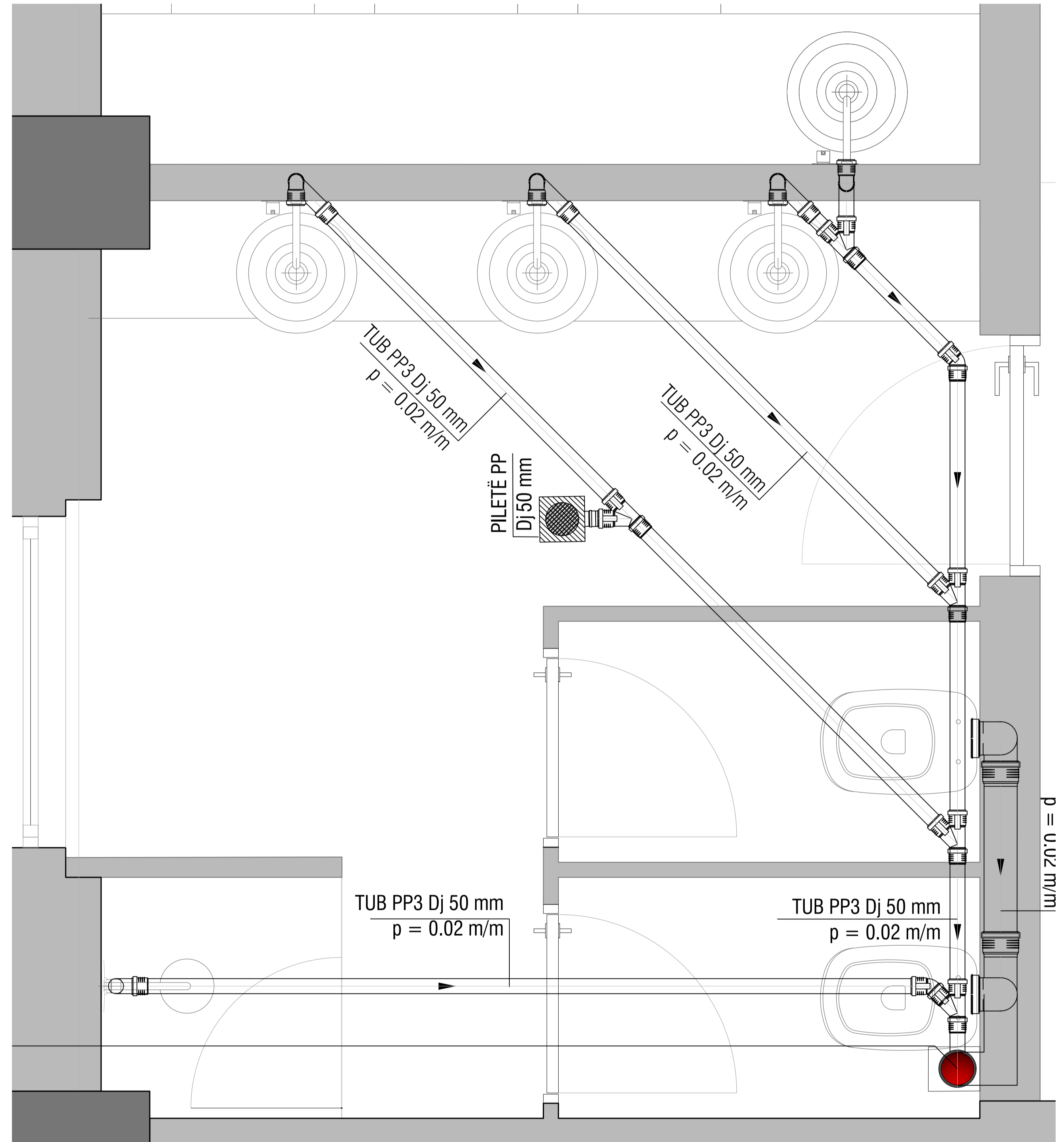
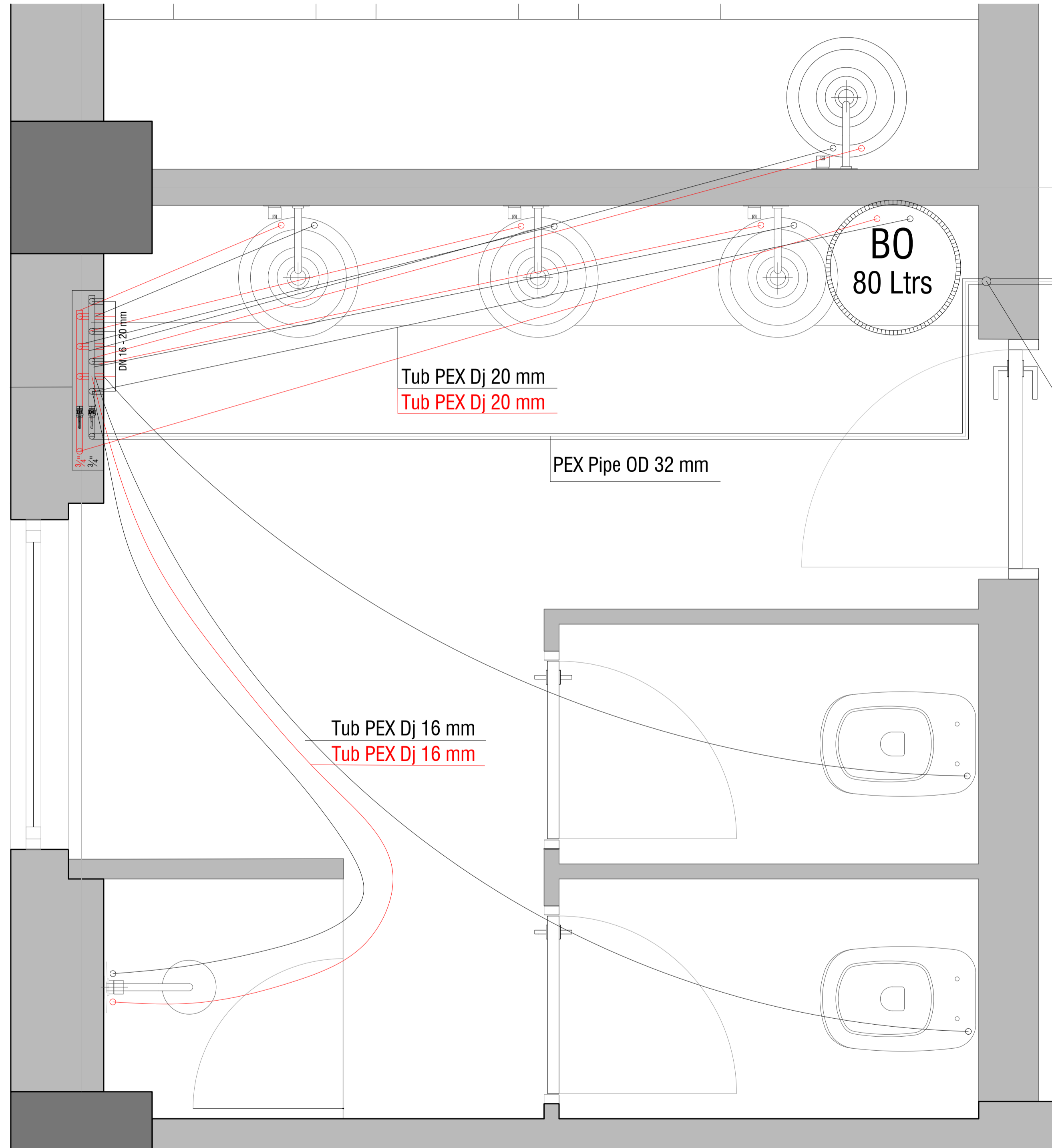

PRONËSIA  
PR

INVESTITOR  
BARRIA QUBES

PROJEKTI ARKITEKTONIK  
MICHELE CRO ARCH.  
ASA ARCHITECTS  
BRINGING SPACE TO LIFE

SHENIME

PLAN REFERENCE

PLAN REFERENCE

PLAN REFERENCE

SISTEMET HIDROSANITARE TË BANJAVE TË NDËRTESESË

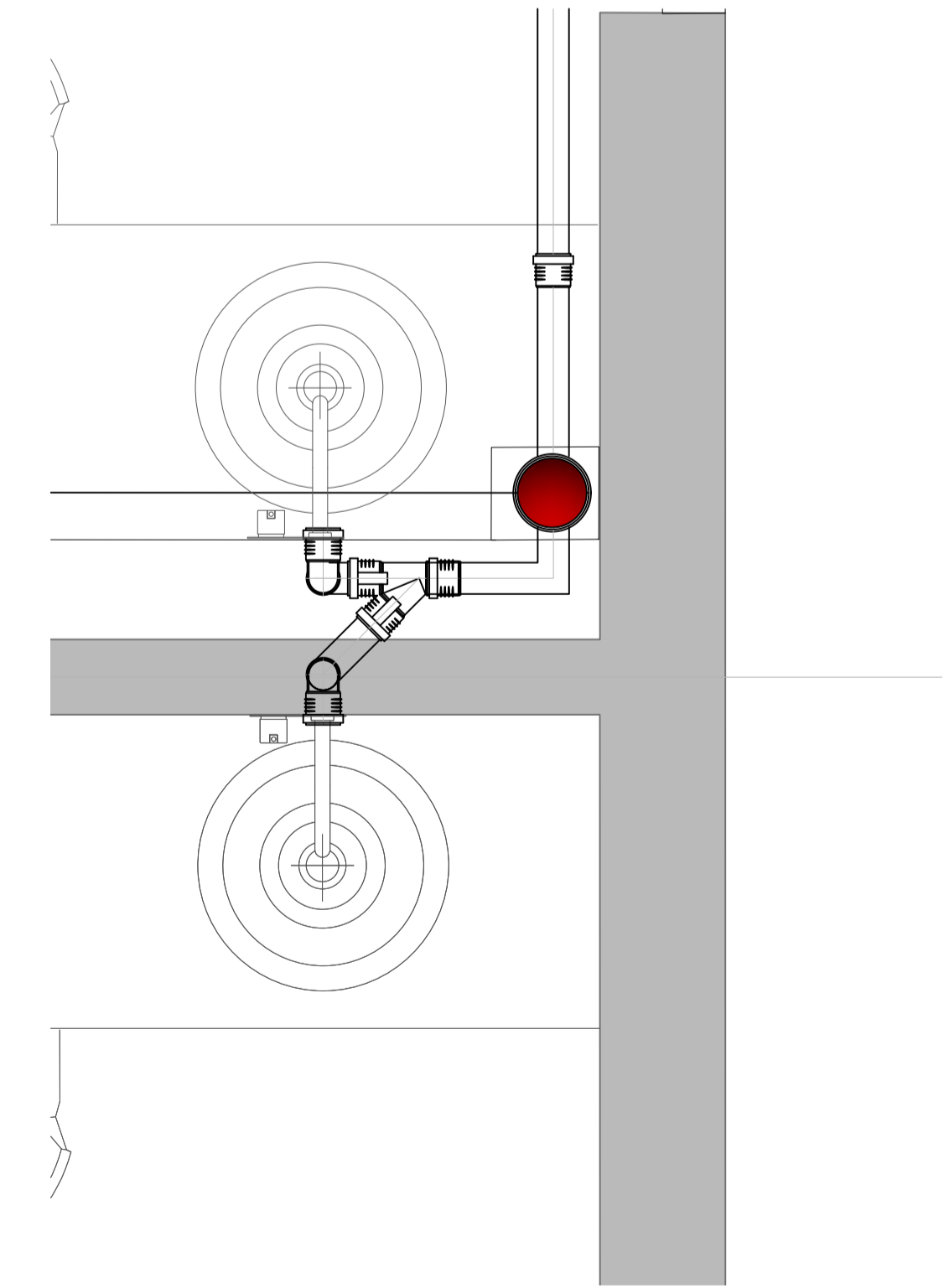
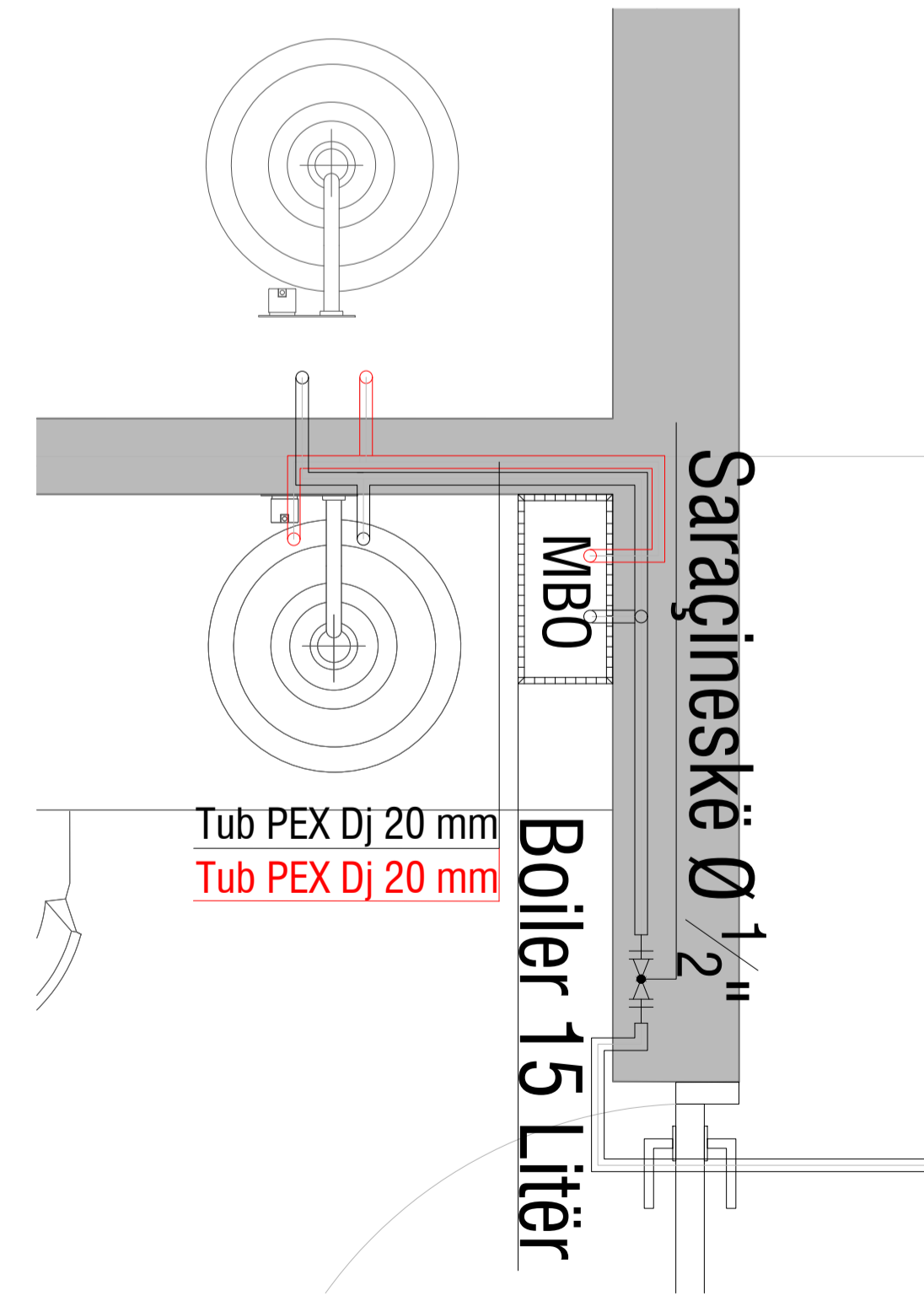
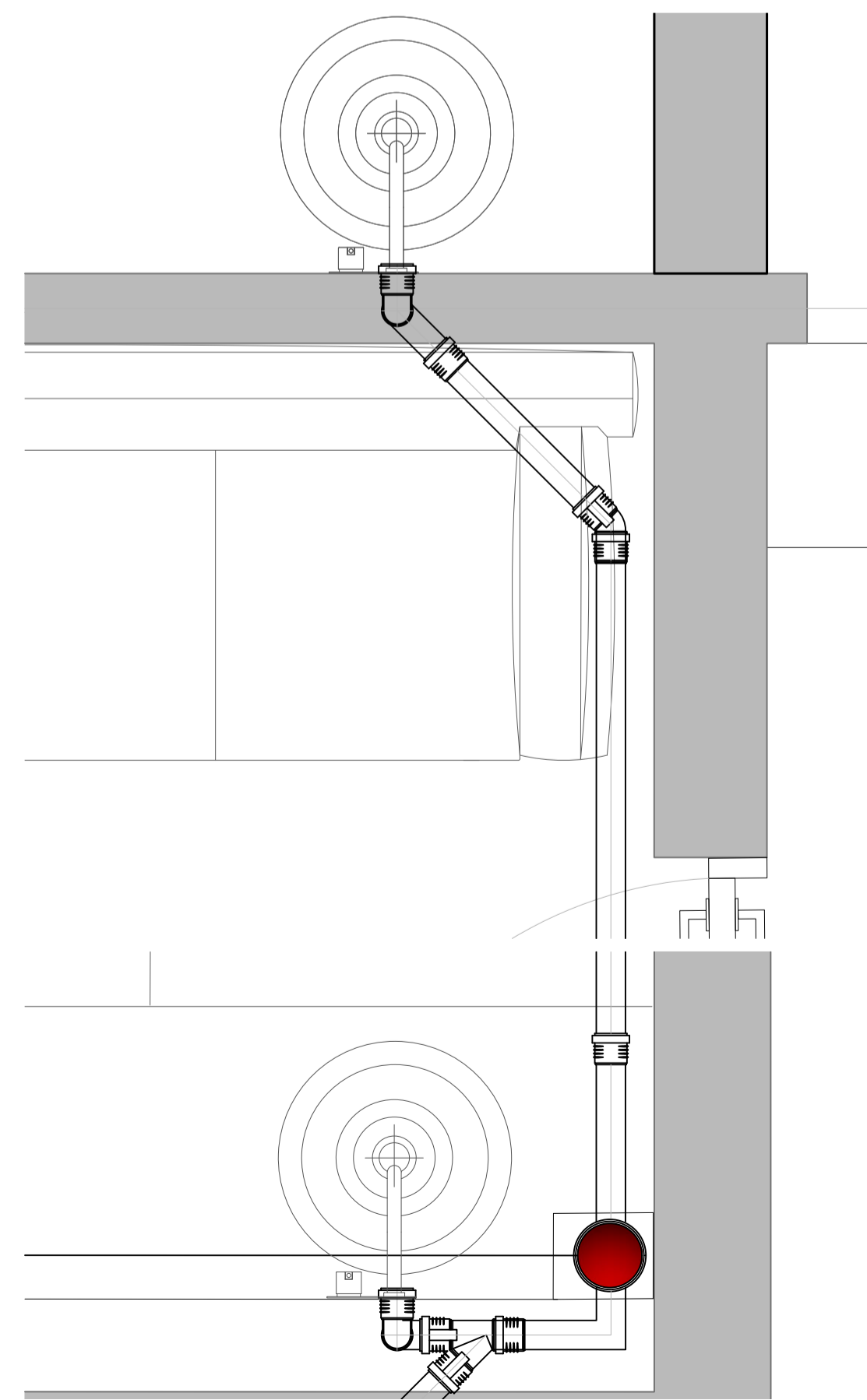
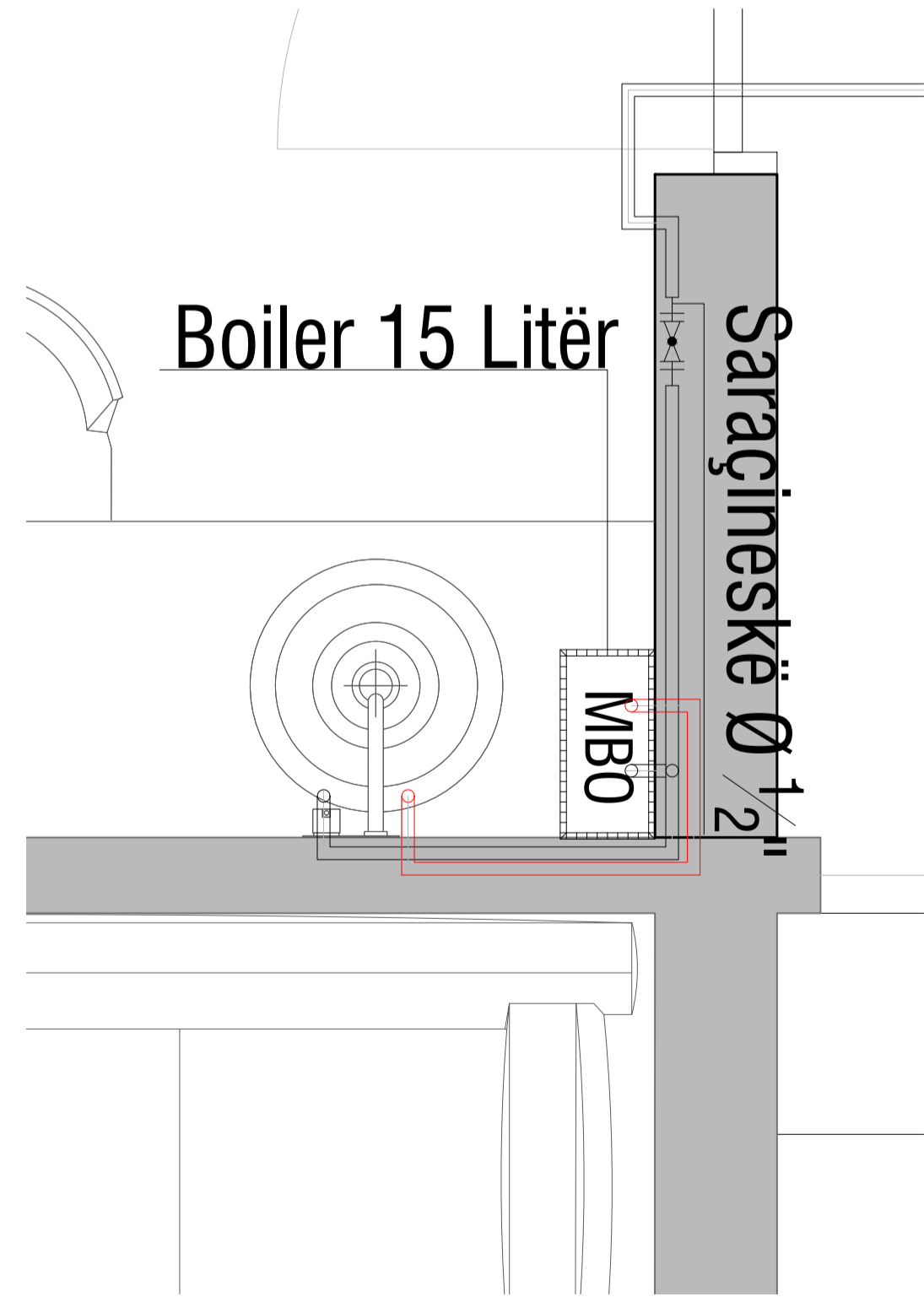
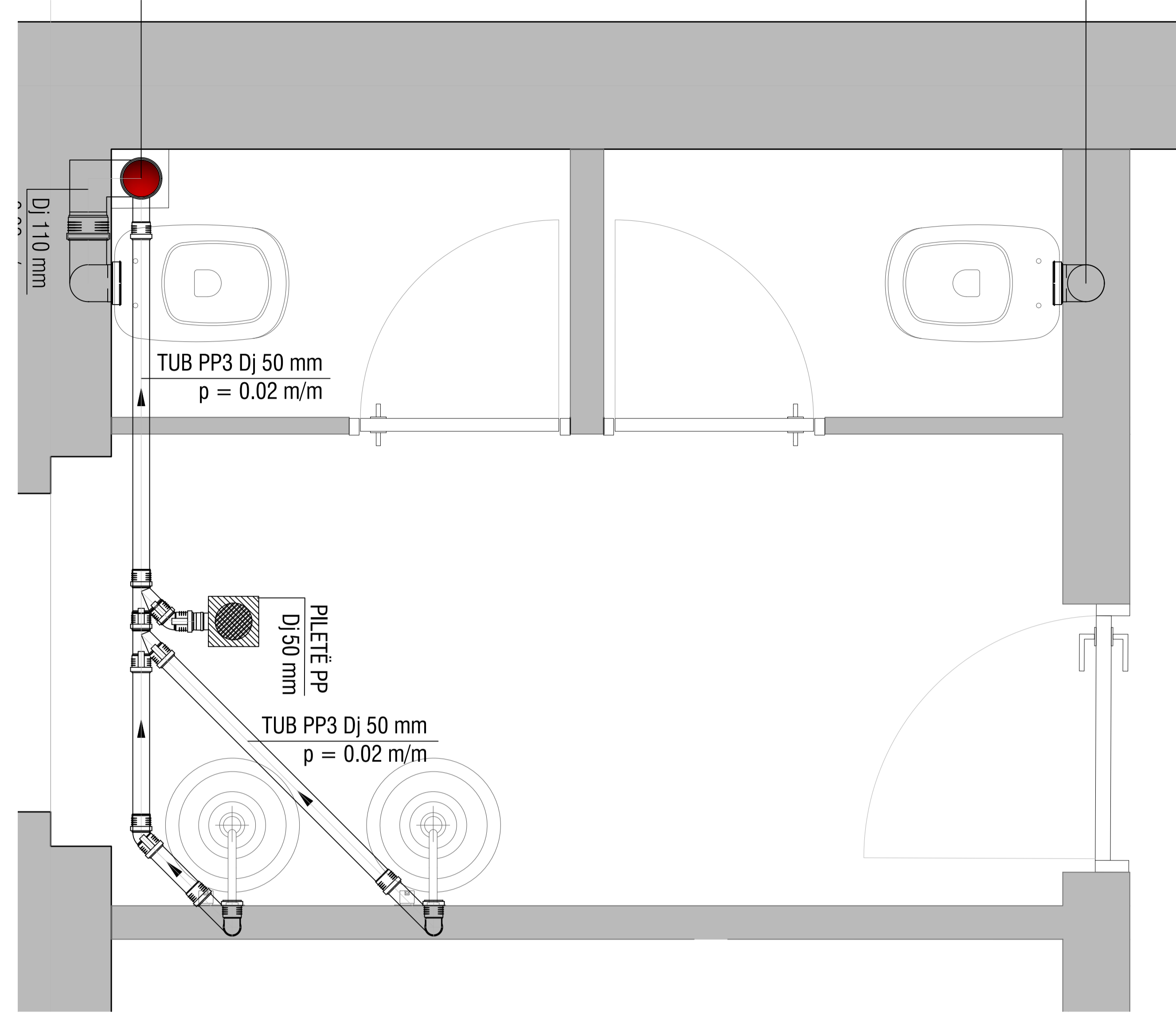
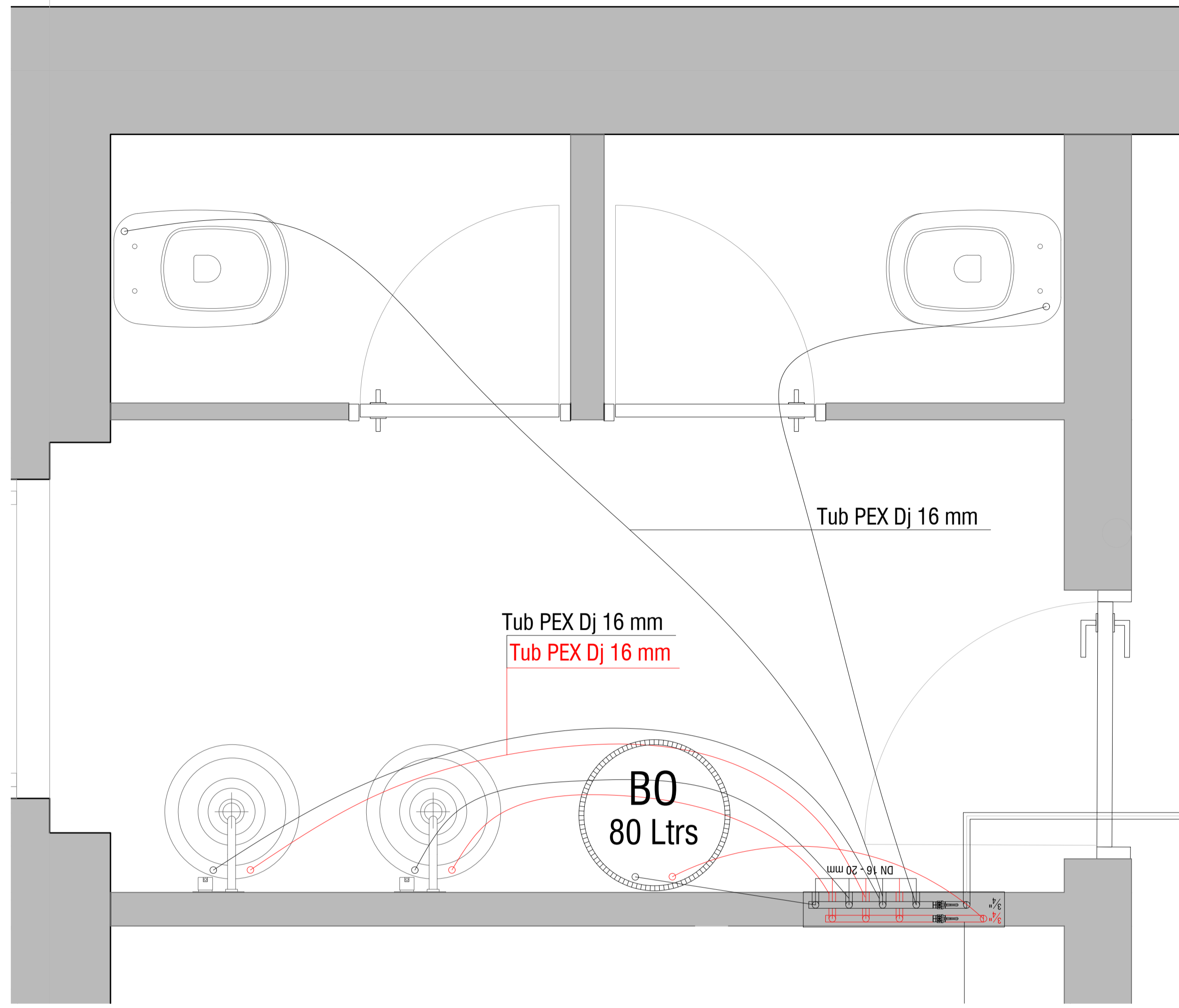

PRONËSIA PR																				
INVESTITOR 																				
PROJËTIMI ARKITEKTONIK MICHELE CRO ARCH. 																				
SHËNIMË																				
<table border="1"><tr><td></td><td></td><td></td><td></td><td></td><td></td><td></td><td></td><td></td><td></td></tr><tr><td></td><td></td><td></td><td></td><td></td><td></td><td></td><td></td><td></td><td></td></tr></table>																				
PLAN REFERENCE 																				
Titulli: "PALLATI HULI TONIS 'ALEXANDER MOJISI'"																				
Faza e punës: "PROJËKT 2-BATJË"																				
PROJEKTI: "HIDROSANITARE"																				
Skala: "1:100"																				
Shefi i 4-të të licencuarit në Shqipëri, Licensa Hidrosanitare																				
© 2020																				
Titulli: "Hidrosanitare"																				

# HOLLËSI DHE SKEMA PRINCIPALE

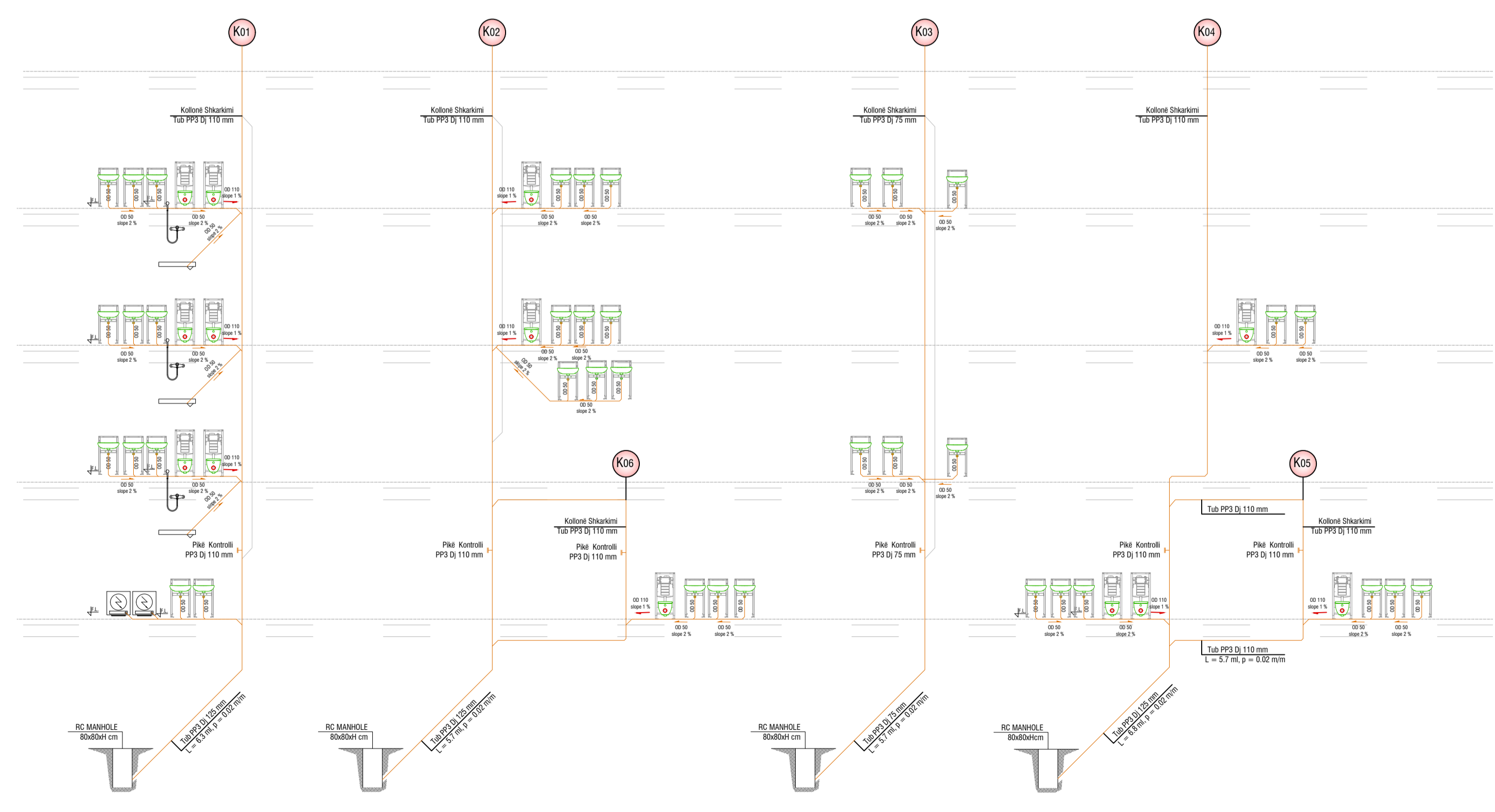
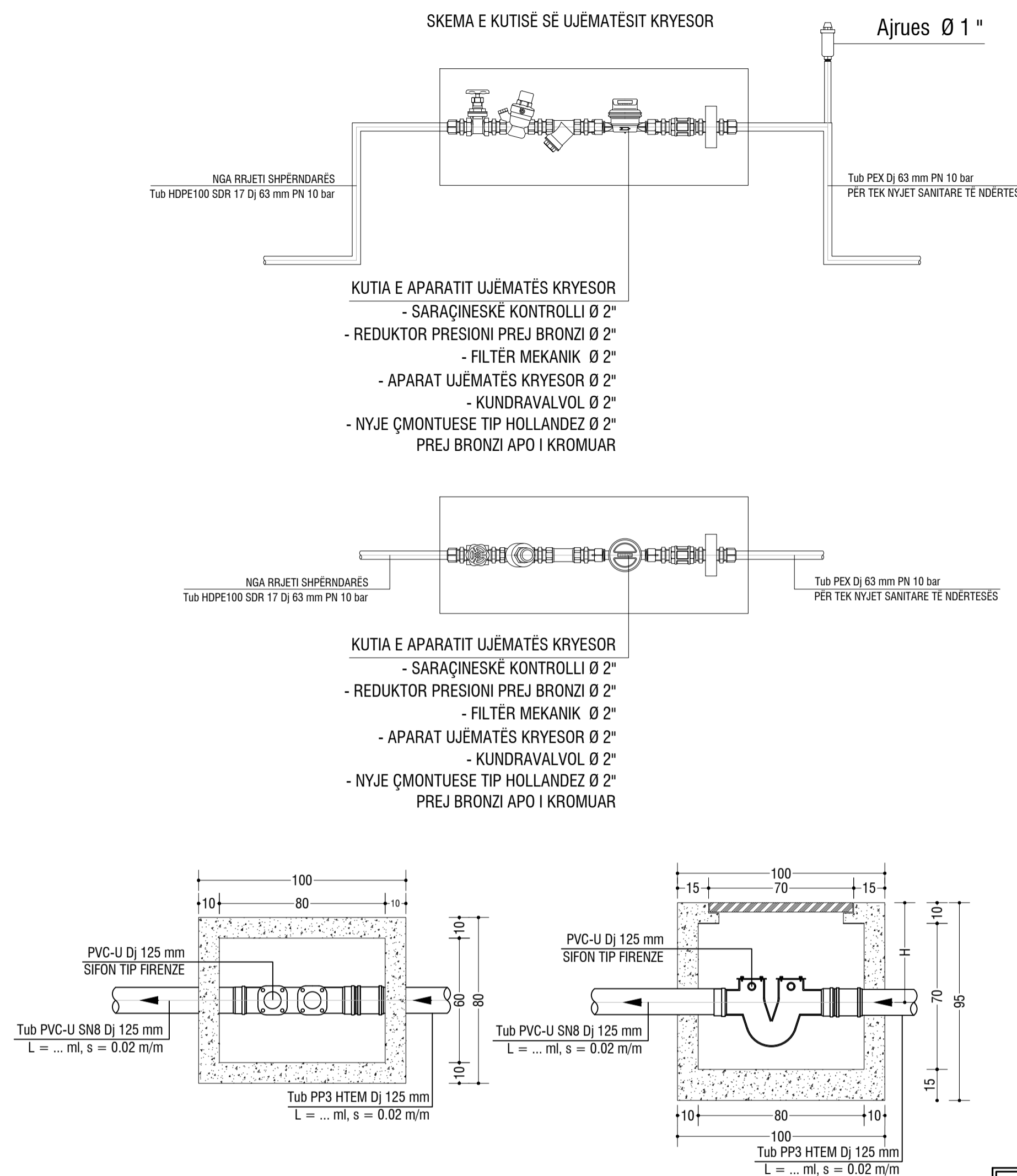
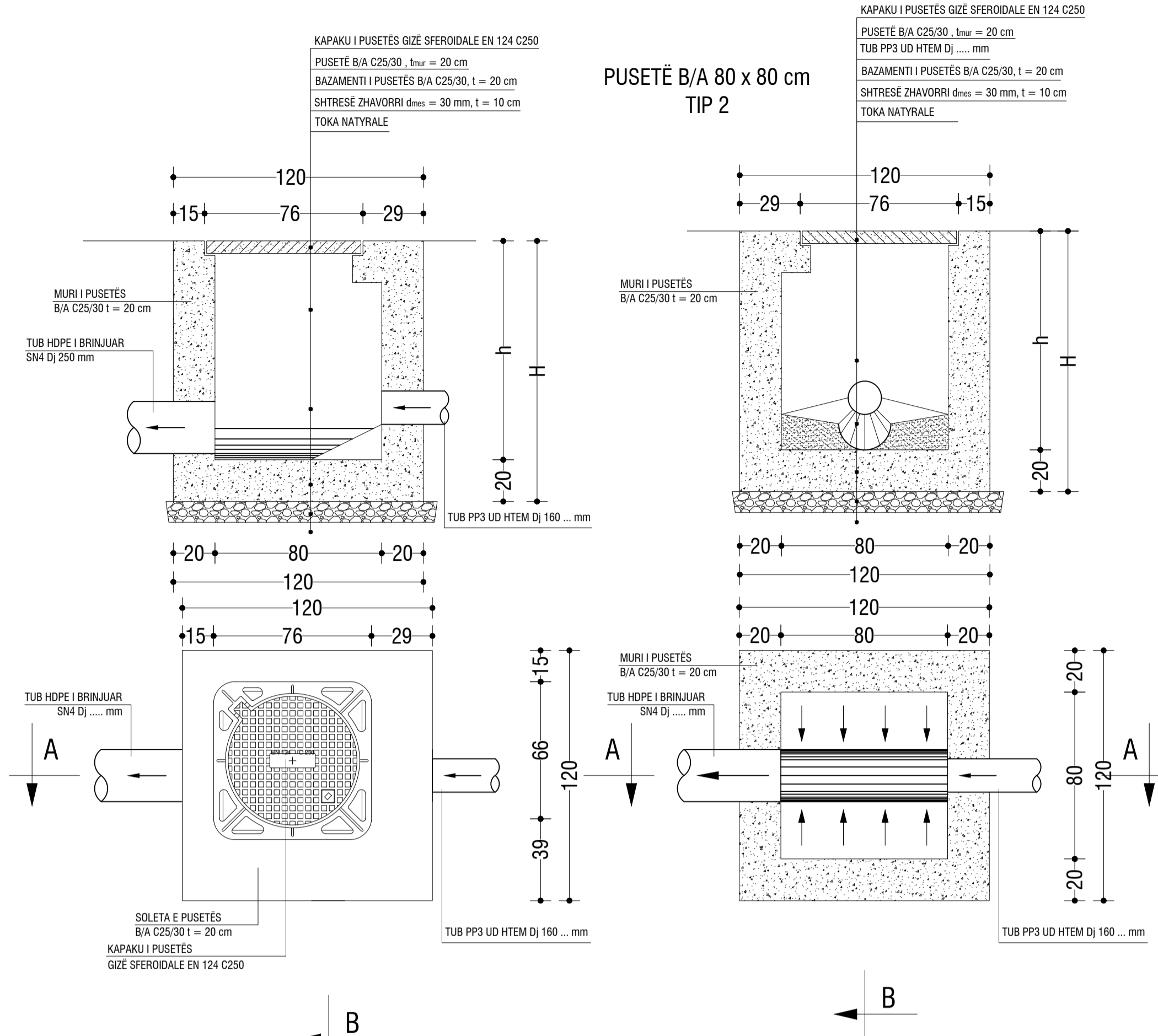
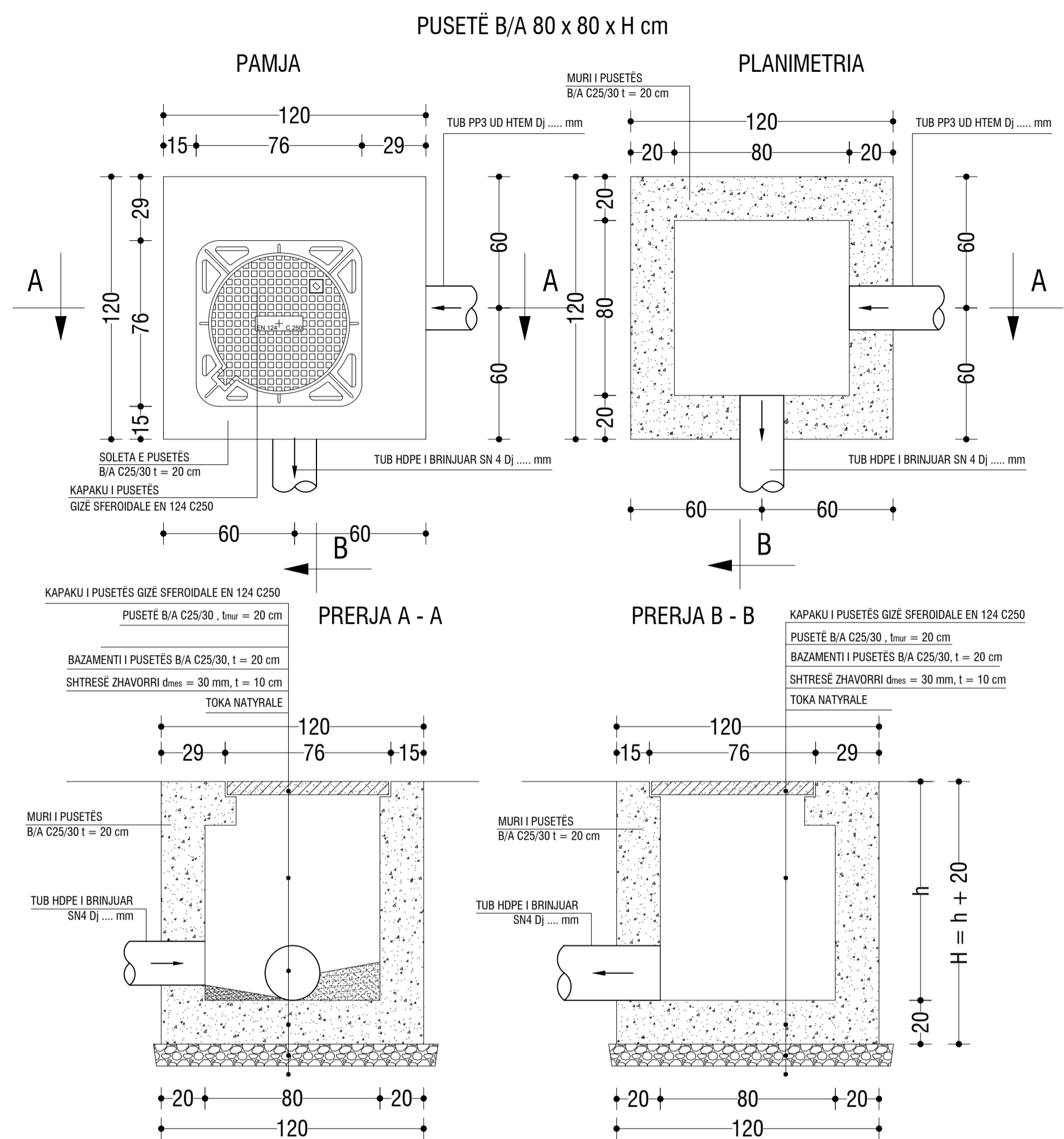

**PRONËSIA**

PR

**INVESTITOR**

BASHKIA QUBËRE

**PROJEKTI ARKITEKTONIK**

MICHELE CRO ARCH.

ASA ARCHITECTS

**SHËNIMË**

NO	DATA	STATUSI

**PLAN REFERENCE**