

Investitor / Kontraktor:  
**BASHKIA KLOS**  
KLOS MUNICIPALITY

Adresa:  
Rruga "Rexhap Pashe Mati",  
Klos - Albania

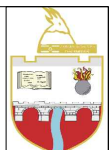

Objekti: **NDERTIM KANAL UJITES**  
**FULLQET KLOS**

Numri i projektit: **AL\_KL\_K-Full\_5-21**  
Vendodhja e projektit: **FULLQET-KLOS**



Grupi teknik i projektimit:  
"HMK-Consulting" shpk Nr.lic. N- 6724/1  
"ERALD-G" shpk Nr.lic. N- 5304/6  
"HP-STUDIO" shpk Nr.lic. N- 6992/2

Emërtimi i fletës:  
**PROFILAT TERTHORE**

Drejtor Teknik:  
**Hekuran HOXHALLI** Lic. K-0632/6  
Inxhinier Hidroteknik:  
**Ferdinand SHAHINLLARI** Lic. K- 1376/1  
Inxhinier Topograf:  
**Mustafa HOXHAJ** Lic. T-1059/1  
Inxhinier Mekanik:  
**Ervin MINAROLLI** Lic. M-1131/1

Inxhinier Infrastruktura:  
**Gezim ISLAMI** Lic. K-1196/3  
Inxhinier Gjeolog:  
**Panajot ALICKOLLI** Lic. GJ-0566/1  
Inxhinier Mjedisi:  
**Dhionis KOTMILO** Lic. M-1147  
Inxhinier Ndertimi:  
**Gezim PAJO**

Faza e projektit:  
**Projekt Zbatimi**  
Shkalla: **A3 / 1:100**  
Data:  
**Shtator/2016**  
Nr i fletes: **5\_ 21**

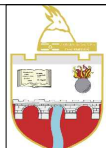
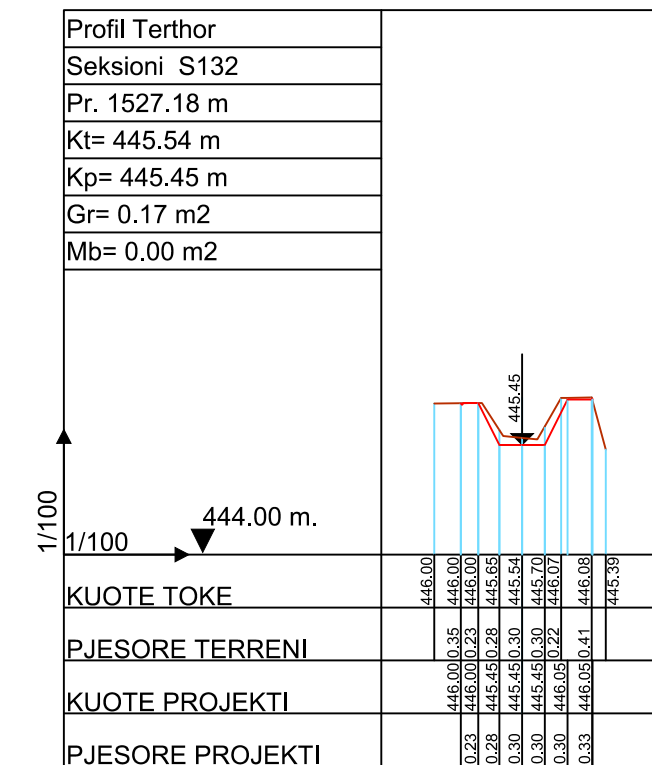
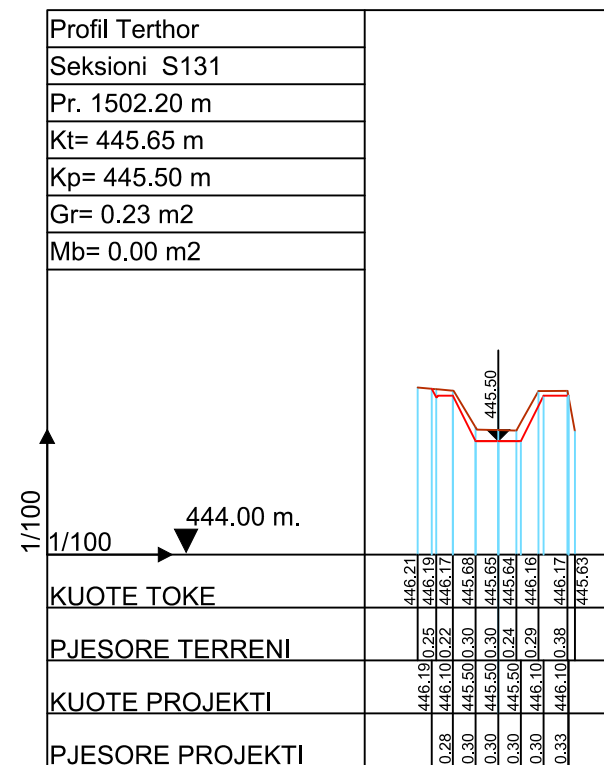
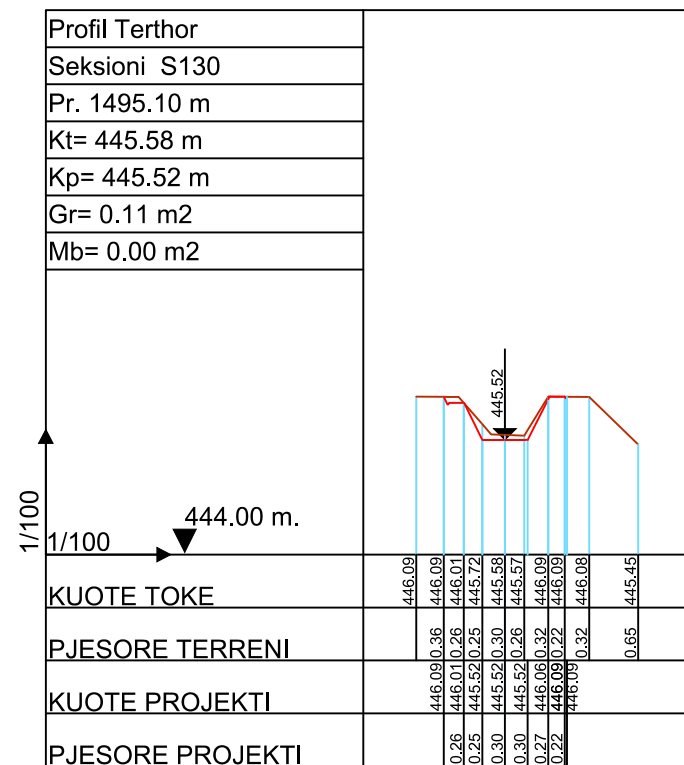
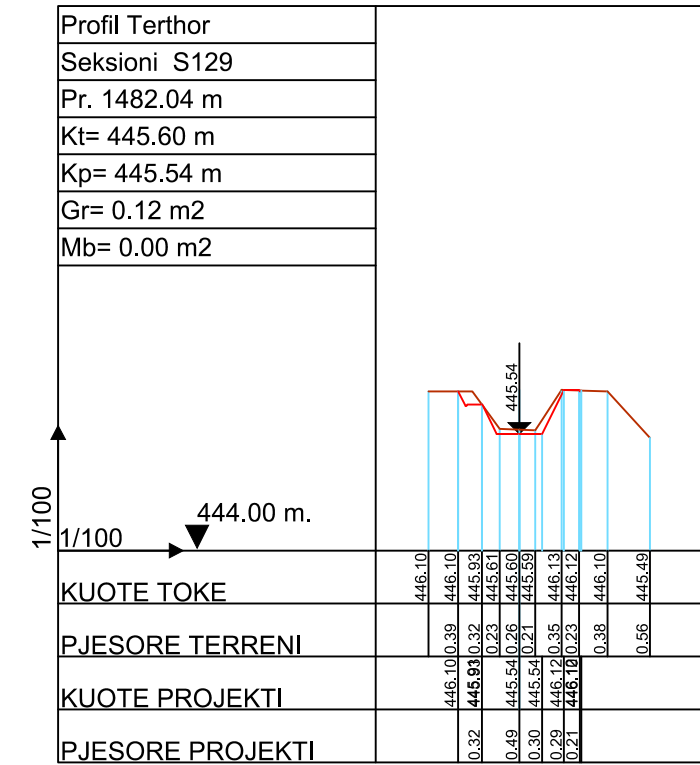
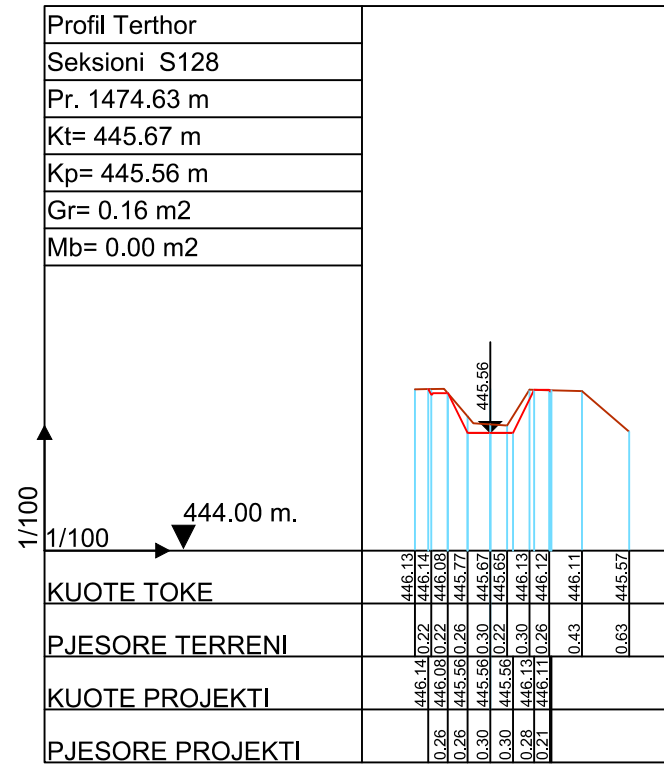
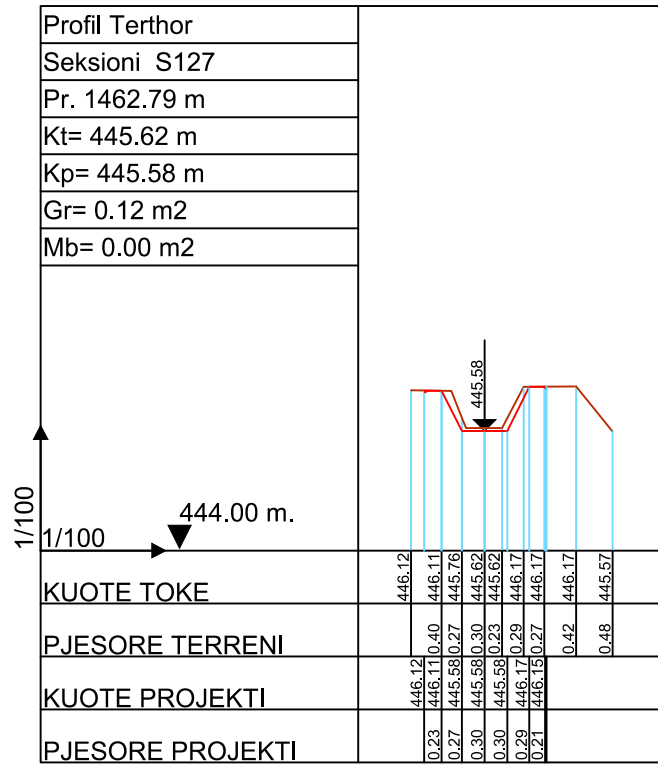

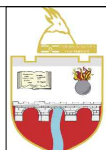
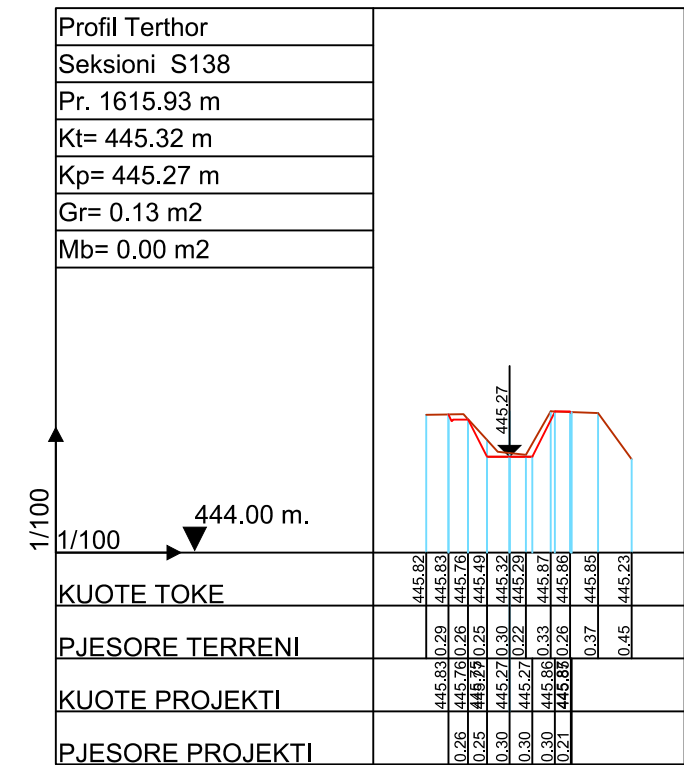
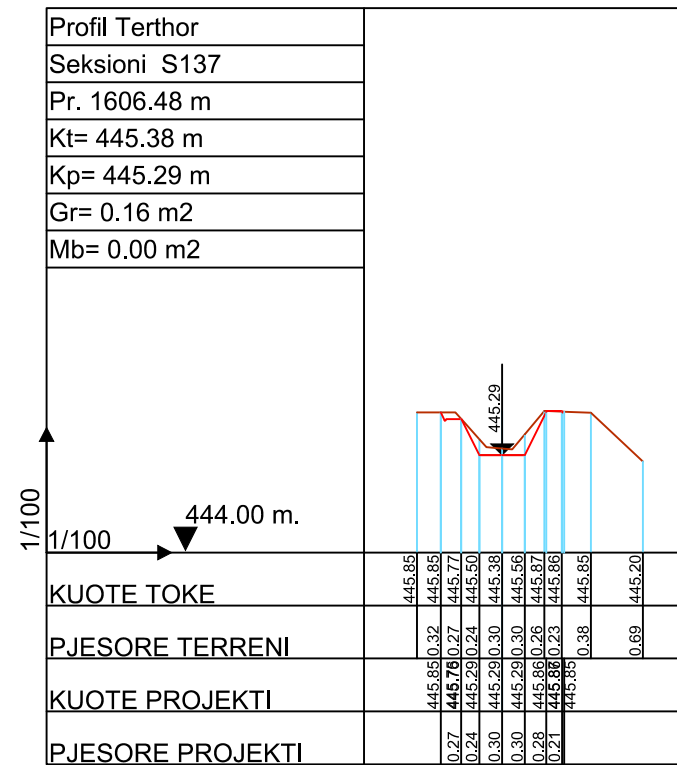
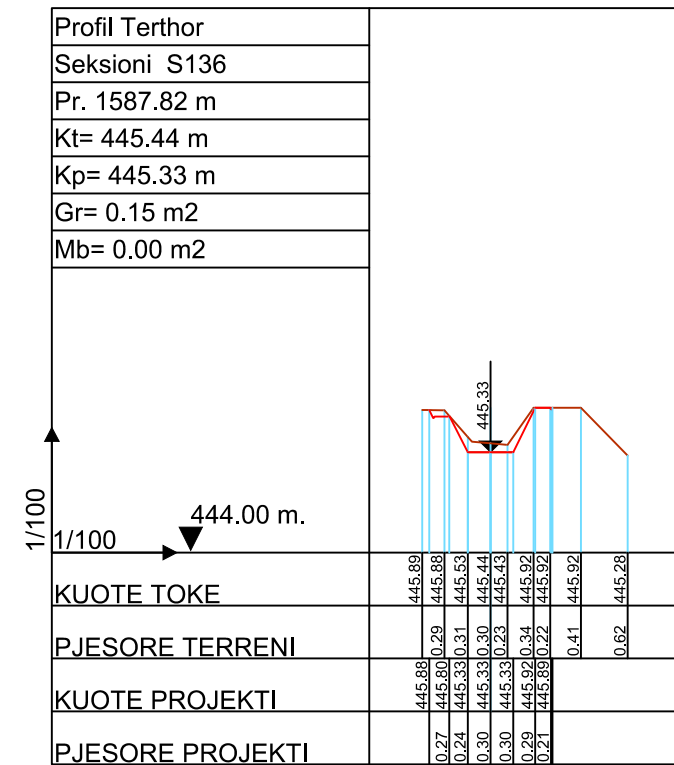
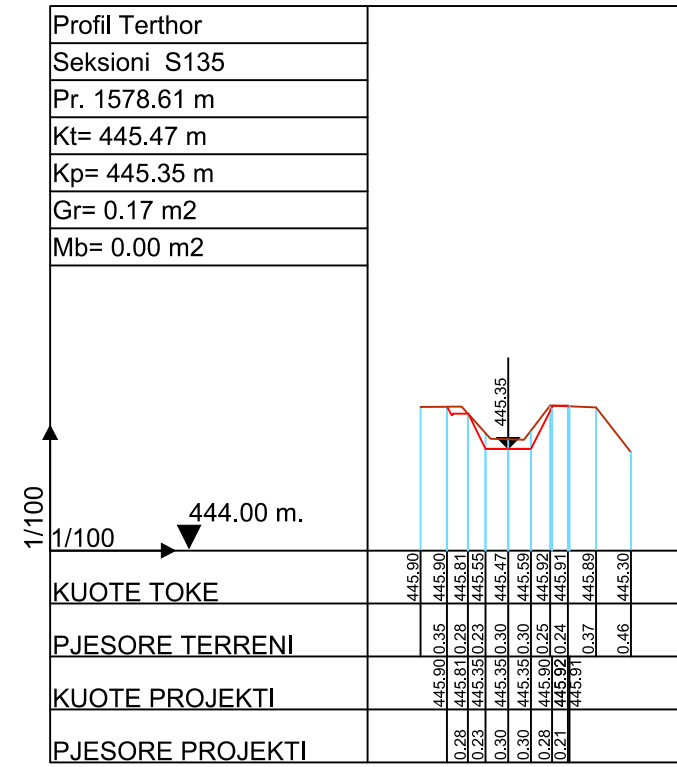
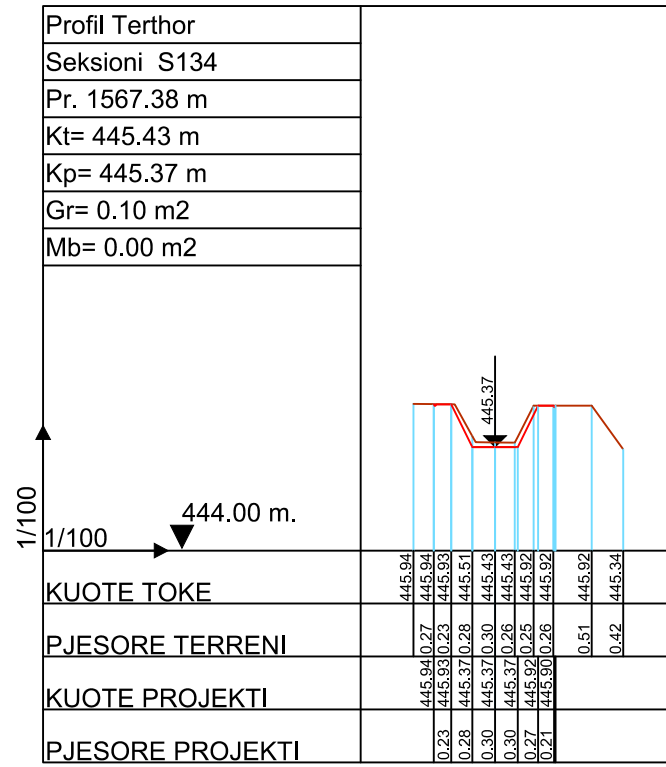
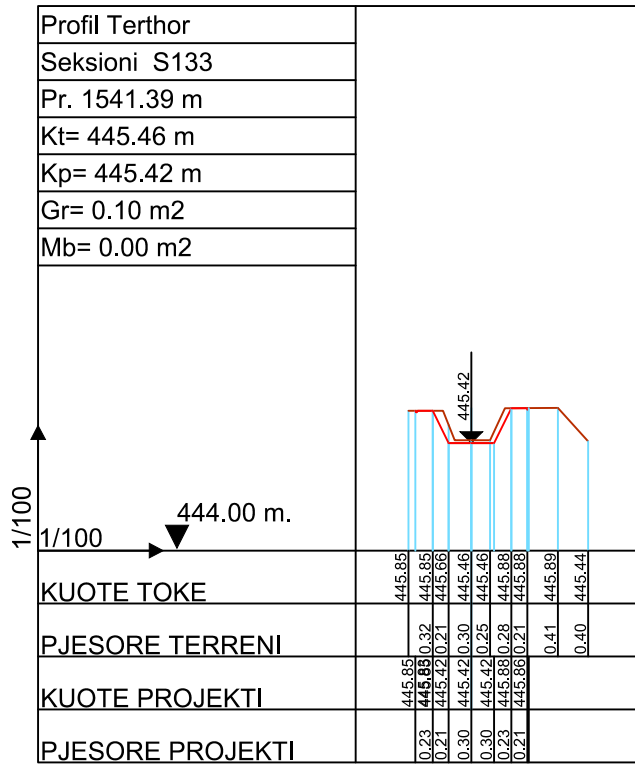



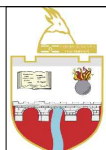
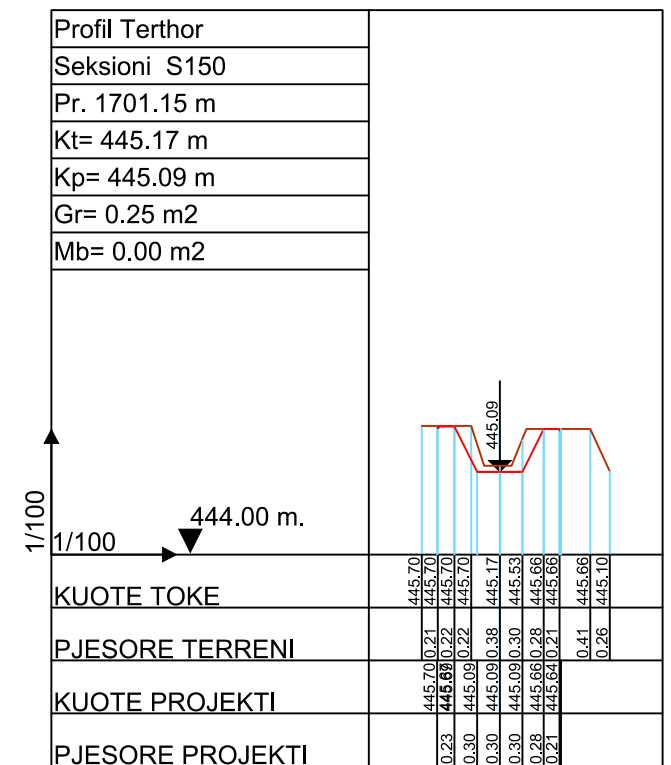
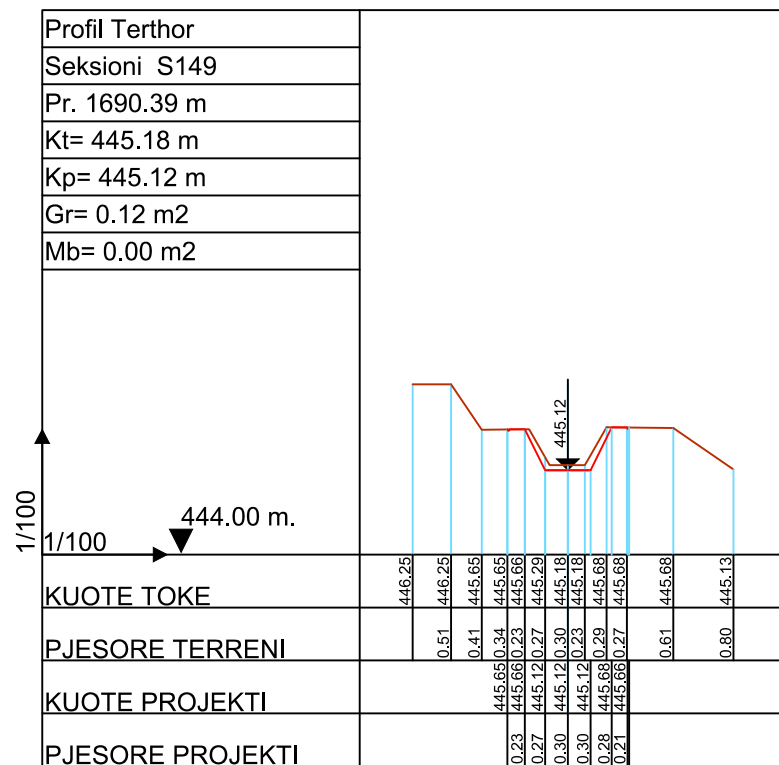
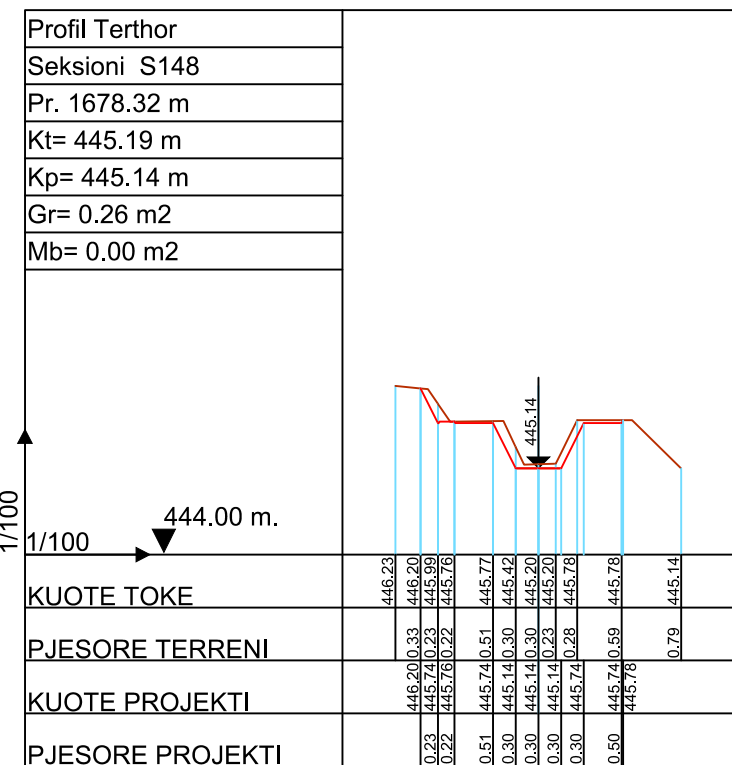
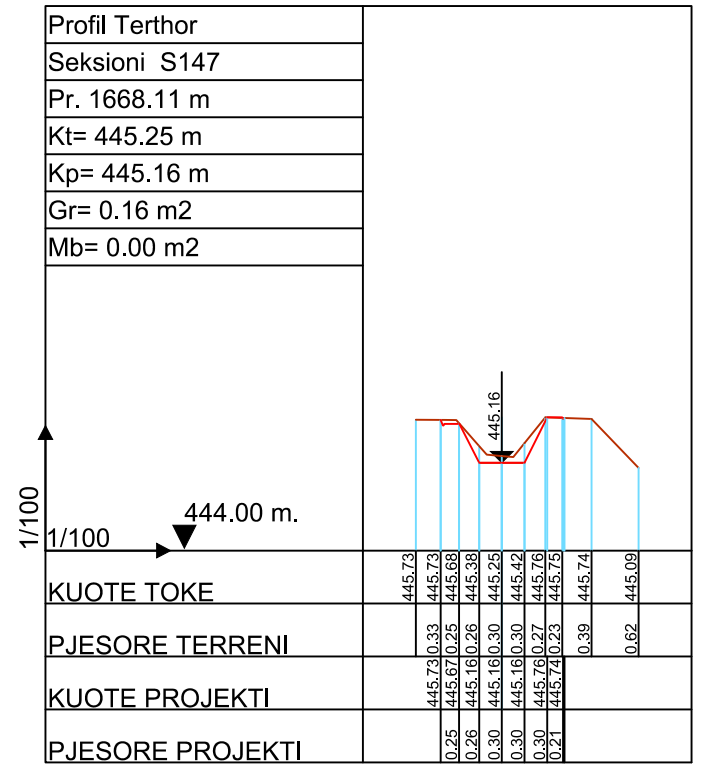
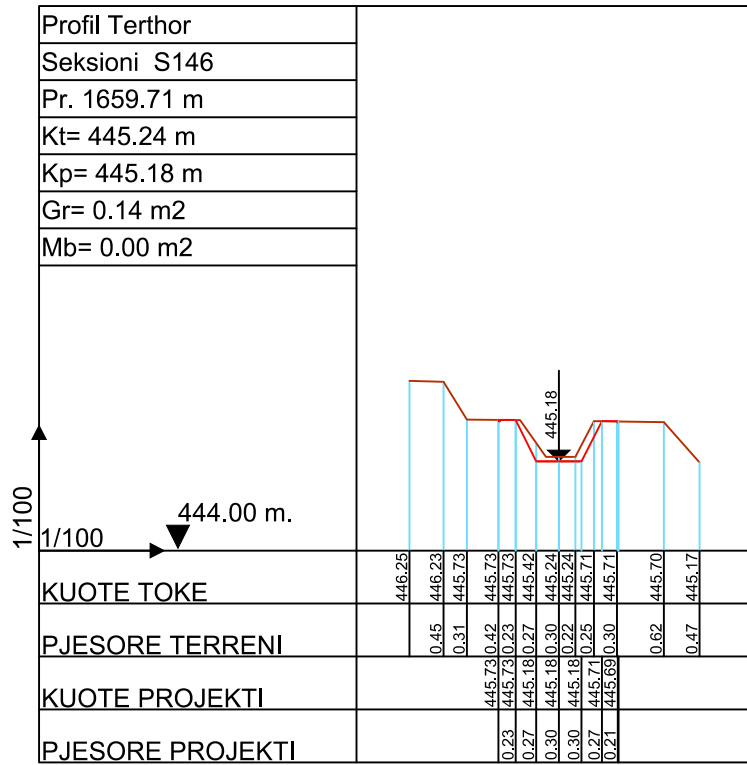
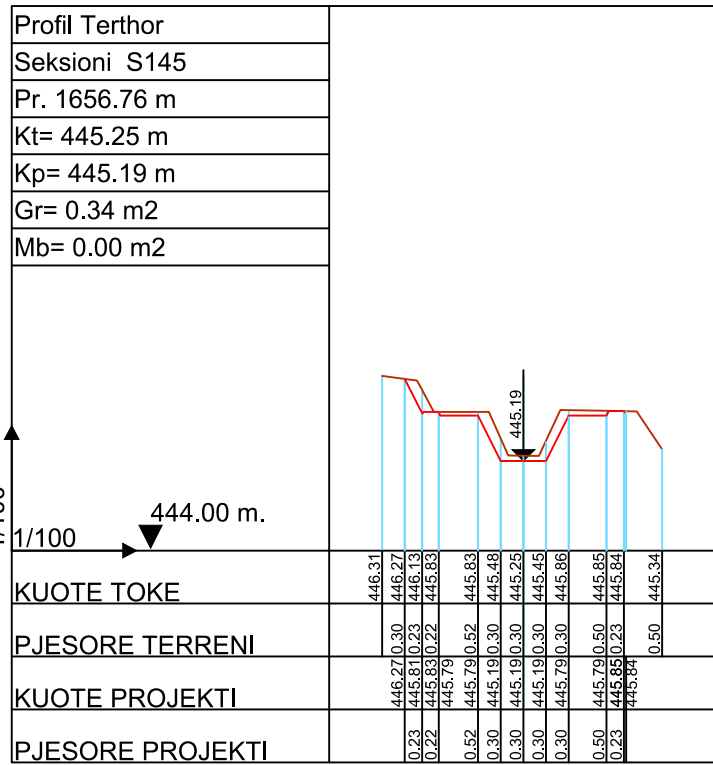

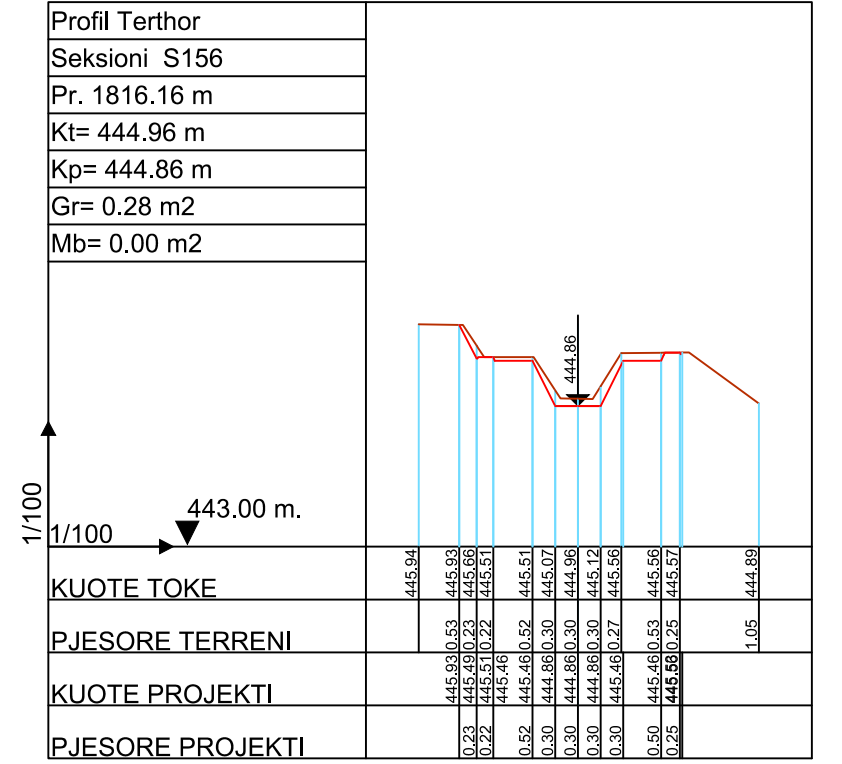
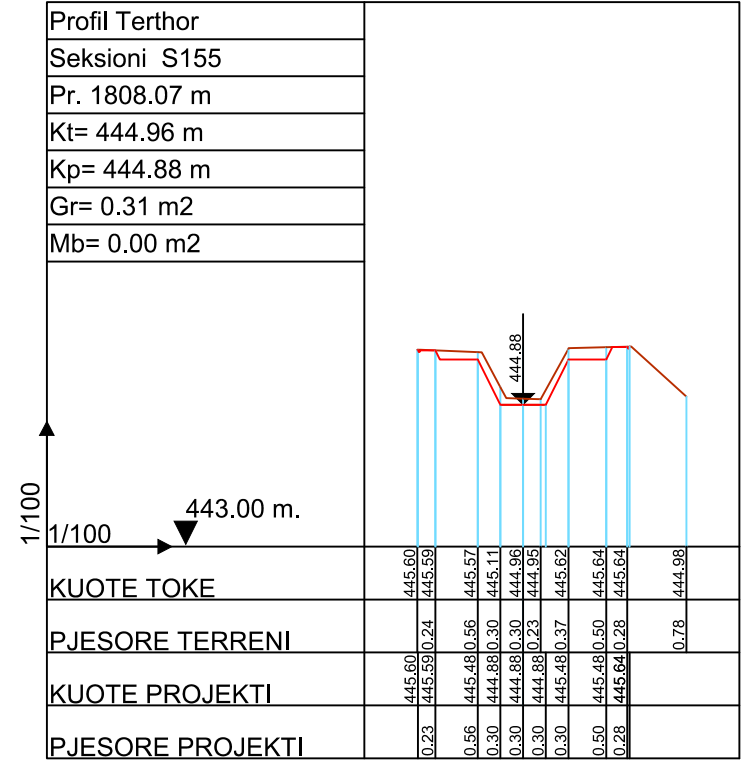
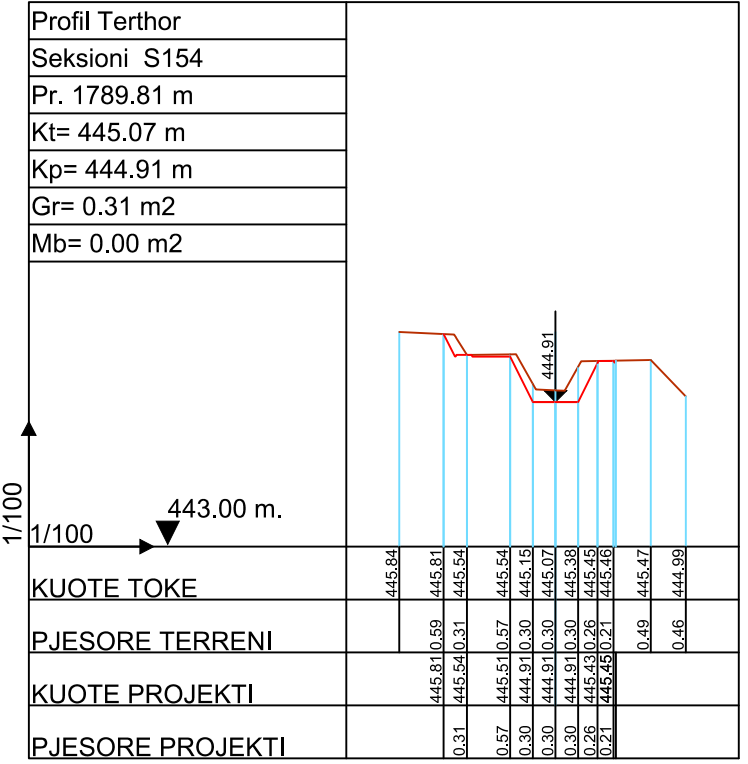
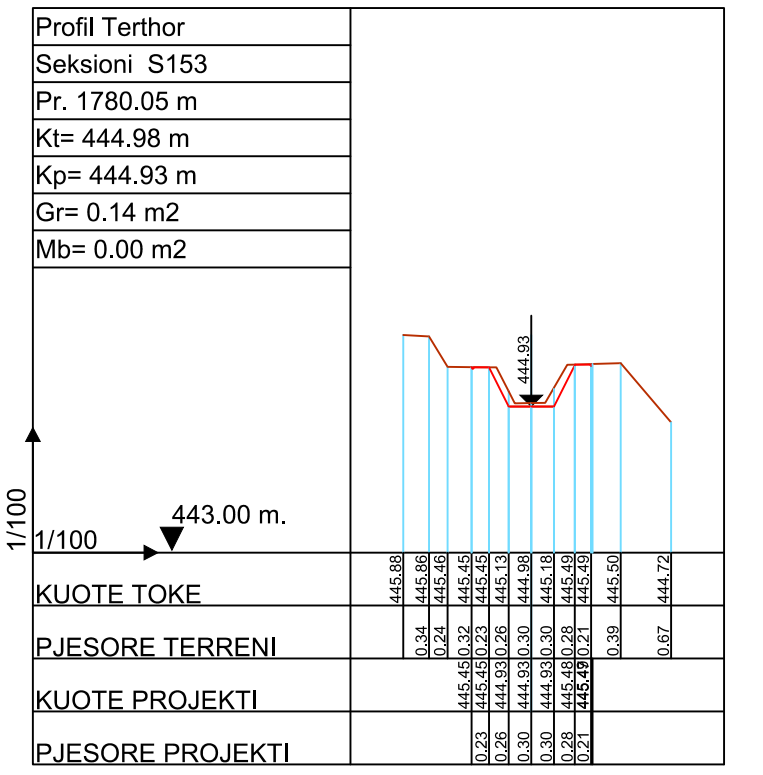
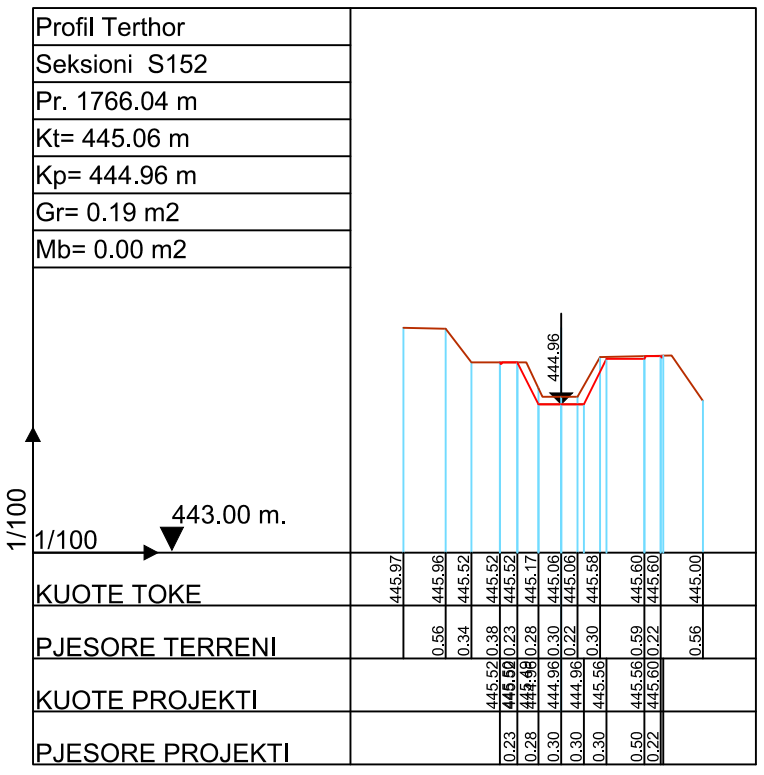
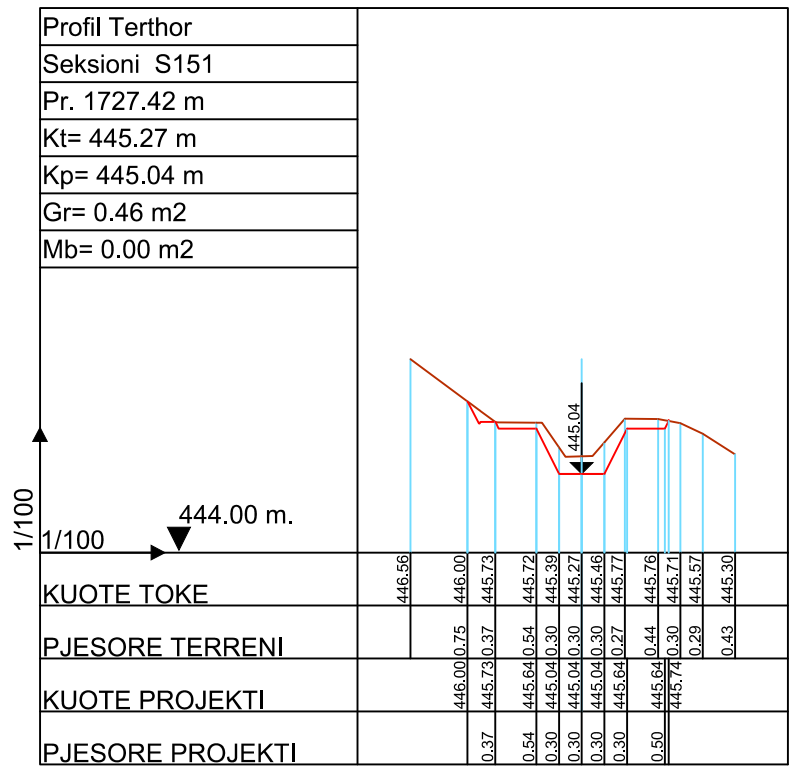

Investitor / Kontraktor:  
**BASHKIA KLOS**  
KLOS MUNICIPALITY

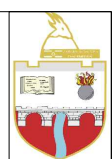

Objekti: **NDERTIM KANAL UJITES FULLQET KLOS**

Numri i projektit: **AL\_KL\_K-Full\_5-26**

Vendodhja e projektit: **FULLQET-KLOS**

HMK CONSULTING SH.P.K.  
A Ad-Rruga "Superstrada Devoll"  
E hmkconsulting2015@gmail.com  
C +355 689080130



Grupi teknik i projektimit:  
"HMK-Consulting" shpk Nr.lic. N- 6724/1  
"ERALD-G" shpk Nr.lic. N- 5304/6  
"HP-STUDIO" shpk Nr.lic. N- 6992/2

Emërtimi i fletës:  
**PROFILAT TERTHORE**

Drejtor Teknik:  
**Hekuran HOXHALLI** Lic. K-0632/6  
Inxhinier Hidroteknik:  
**Ferdinand SHAHINLLARI** Lic. K- 1376/1  
Inxhinier Topograf:  
**Mustafa HOXHAJ** Lic. T-1059/1  
Inxhinier Mekanik:  
**Ervin MINAROLLI** Lic. M-1131/1

Inxhinier Infrastrukturate:  
**Gezim ISLAMI** Lic. K-1196/3  
Inxhinier Gjeolog  
**Panajot ALICKOLLI** Lic. GJ-0566/1  
Inxhinier Mjedisi:  
**Dhionis KOTMILO** Lic. M-1147  
Inxhinier Ndertimi:  
**Gezim PAJO**

Faza e projektit:  
**Projekt Zbatimi**

Shkalla: **A3 / 1:100**

Data:  
**Shtator/2016**

Nr i fletes: **5\_26**

