

REHABILITIM

I REZERVUAREVE

OBJEKTI

**NDËRTIM I RRJETIT KRYESOR FURNIZIMI ME UJE I FSHATRAVE TE
NJESISE ADMINISTRATIVE MAQELLARE, FAZA II**

**AUTORITETI
KONTRAKTOR**

SHOQËRIA RAJONALE UJËSJELLËS KANALIZIME DIBËR SH.A

KONSULENTI

"ERALD-G" sh.p.k

2024

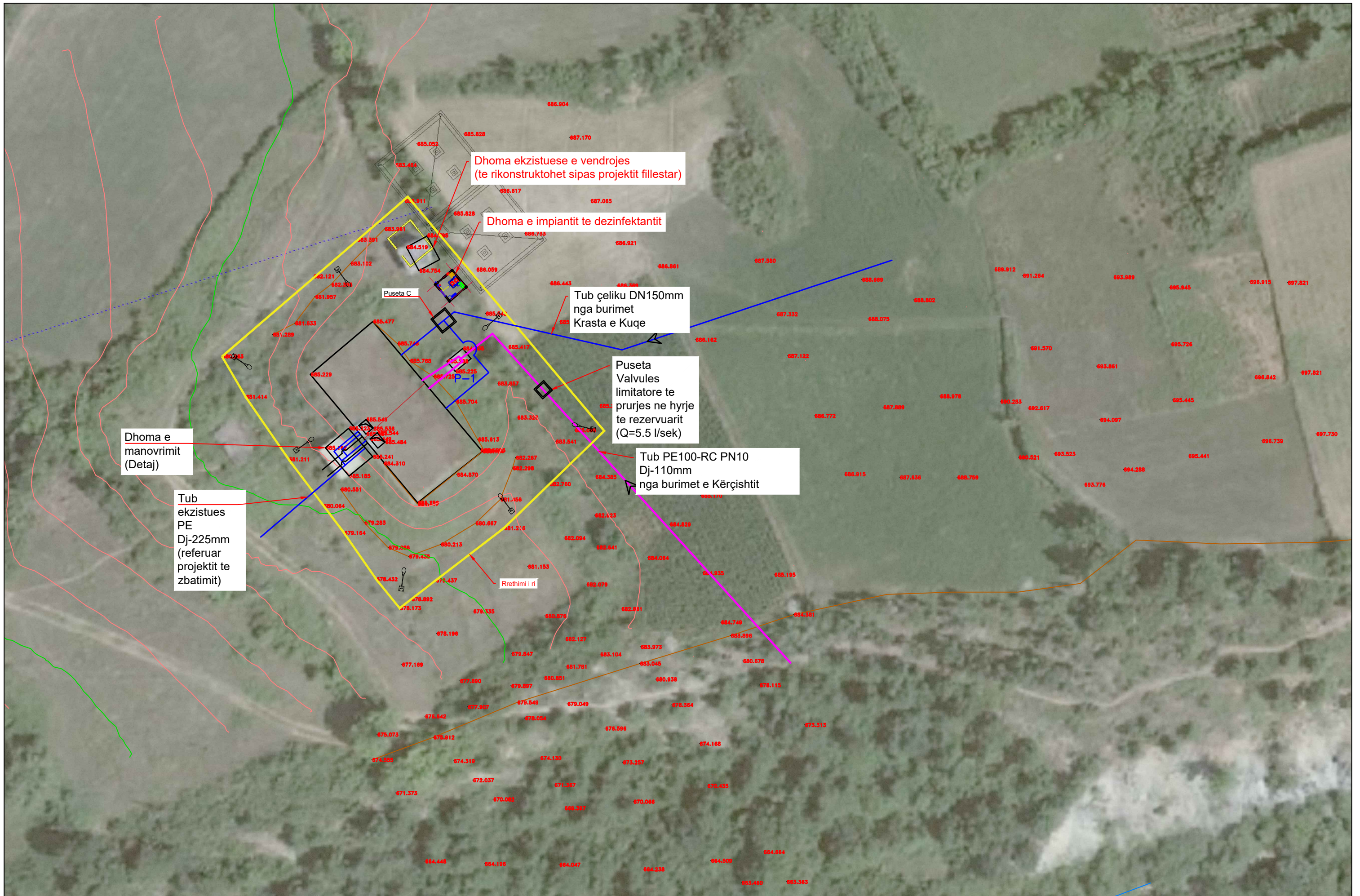

POROSITES:	SHOQERIA RAJONALE UJESJELLES KANALIZIME DIBER SH.A	"ERALD - G" SH.P.K	EMERTIMI	DREJTUES I PROJEKTIT	PROJEKTUES	SHKALLA	NR. I FLETES
OBJEKTI:	"NDERTIM I RRJETIT KRYESOR FURNIZIMI ME UJE I FSHATRAVE TE NJESISE ADMINISTRATIVE MAQELLARE, FAZA 2"	 RRUGA KONGRESI I LUSHNYES TIRANE.	REHABILITIM I REZERVUARIT MAQELLARE V=1000m³	INXH. GEZIM ISLAMI	INXH. GEZIM ISLAMI TOP. KUJTIM CANAMETI HIDR. ANISA ZAKA	INXH. ENDRI PIERO	6-01 FORMAT A3
						1:500 2024	

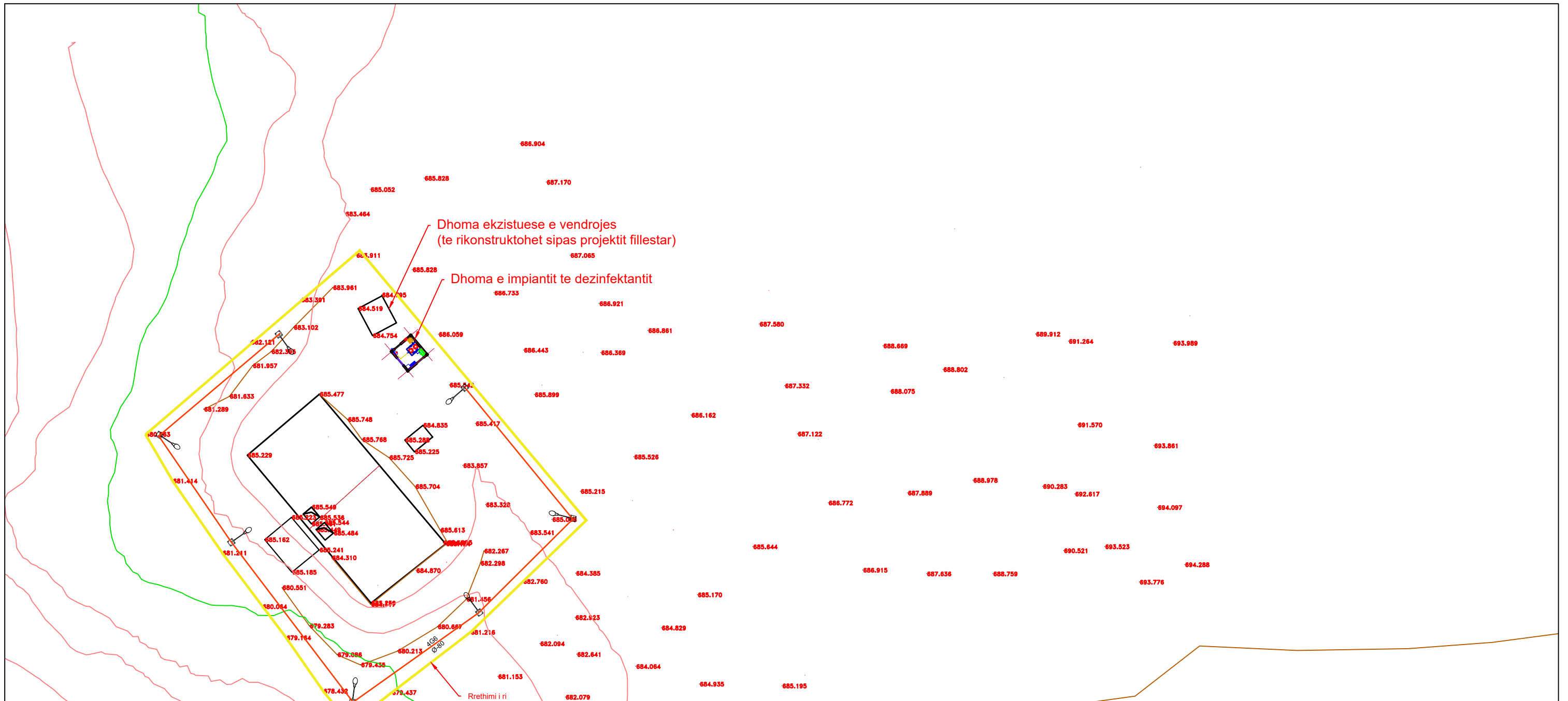

SKEMA E NDRICIMIT

VENDOJA E KABLLIT TE FURNIZIMIT NEN TOKE

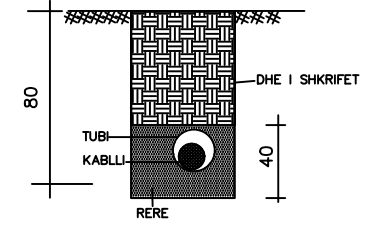

SHENIME :KABLLI DO VENDOSET NENTOKE NE TUB KAVIDOTO TE GOMUAR MBULUAR ME NJE SHITRESE 40CM ME RERE DHE PJESA TJETER ME DHE TE SHKRIFET,ME NJE THELLESI TOTALE 80CM.

SHENIME
 Ndriculesit rrugor do jene me shtylla konike te zinkuara me l-9ml me koke ndricuesi led me drite natyrale me fuqi 250-300W.
 Per sistemimin e komandimit te ndricuesave do perdoret kuader komandimi kompletuar me automate dhe fotoelement drite.

POROSITES:	SHOQERIA RAJONALE UJESJELLES KANALIZIME DIBER SH.A	"ERALD - G" SH.P.K	EMERTIMI	DREJTUES I PROJEKTIT	PROJEKTUES	SHKALLA	NR. I FLETES
OBJEKTI:	"NDERTIM I RRJETIT KRYESOR FURNIZIMI ME UJE I FSHATRAVE TE NJESISE ADMINISTRATIVE MAQELLARE, FAZA 2"	 RRUGA KONGRESI I LUSHNJES TIRANE.	REHABILITIM I REZERVUARIT MAQELLARE V=1000m ³	INXH. GEZIM ISLAMI	INXH. GEZIM ISLAMI TOP. KUJTIM CANAMETI HIDR. ANISA ZAKA	INXH. ENDRI PIERO	6-02 FORMAT A3
						1:500 2024	

DETAJ I MBULIMIT TE KAPAKEVE PER CDO SEKSION TE REZERVUARIT

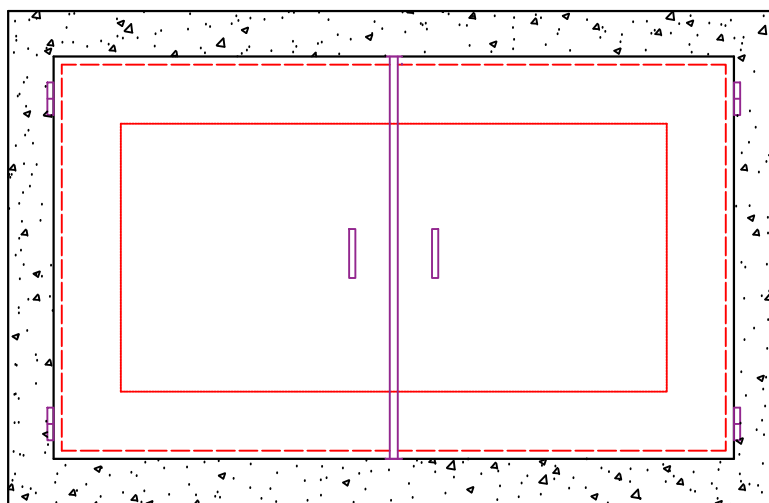
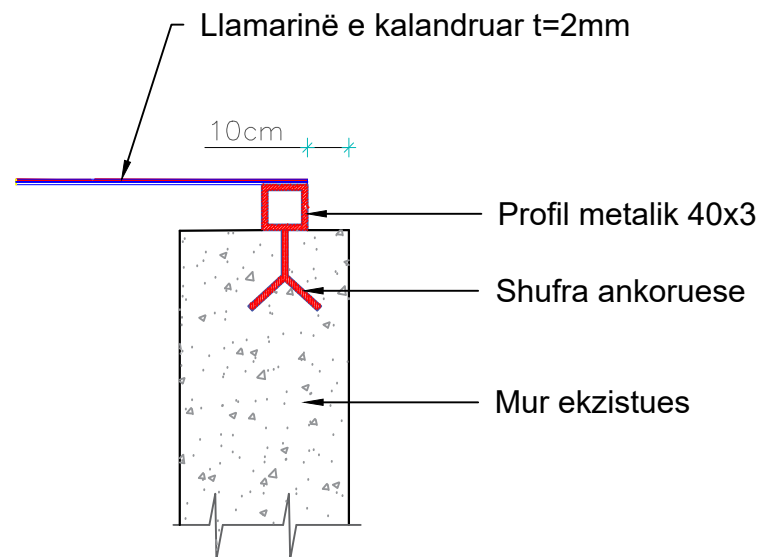

POROSITES:	SHOQERIA RAJONALE UJESJELLES KANALIZIME DIBER SH.A	"ERALD - G" SH.P.K	EMERTIMI	DREJTUES I PROJEKTIT	PROJEKTUES	SHKALLA	NR. I FLETES
OBJEKTI:	"NDERTIM I RRJETIT KRYESOR FURNIZIMI ME UJE I FSHATRAVE TE NJESISE ADMINISTRATIVE MAQELLARE, FAZA 2"	 RRUGA KONGRESI I LUSHNJES TIRANE.	REHABILITIM I REZERVUARIT MAQELLARE V=1000m ³	INXH. GEZIM ISLAMI	INXH. GEZIM ISLAMI TOP. KUJTIM CANAMETI HIDR. ANISA ZAKA	INXH. ENDRI PIERO	6-04
						1:40	FORMAT A3
						2024	

PLANIMETRIA E VALVULES LIMITATORE TE PRURJES

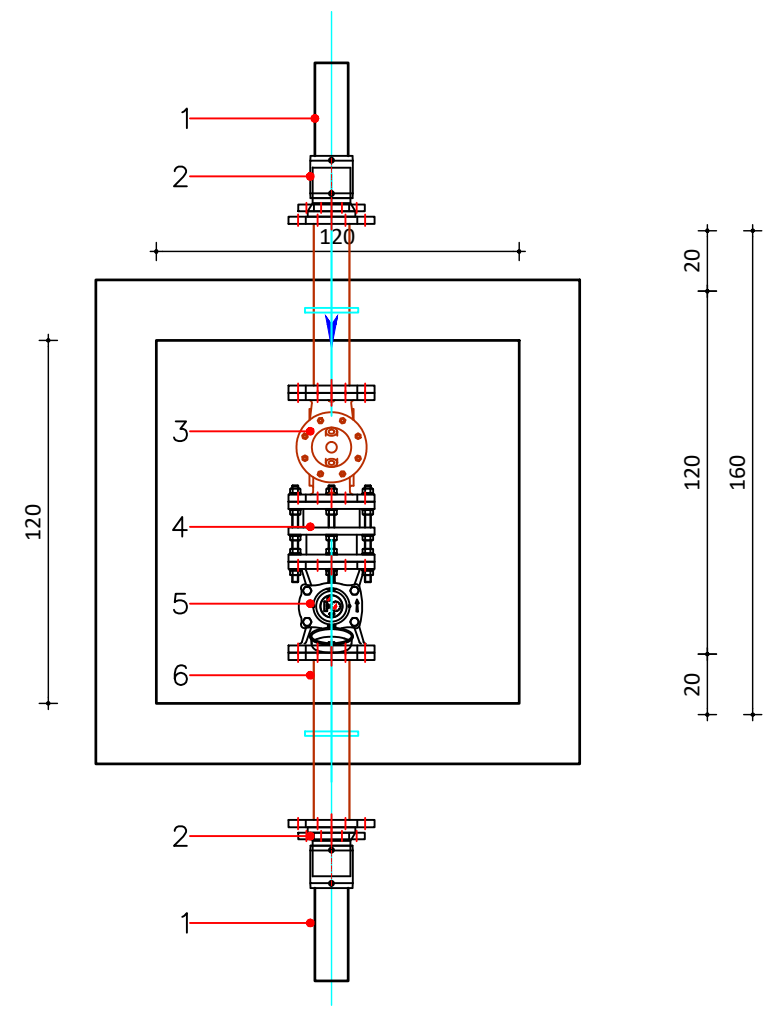

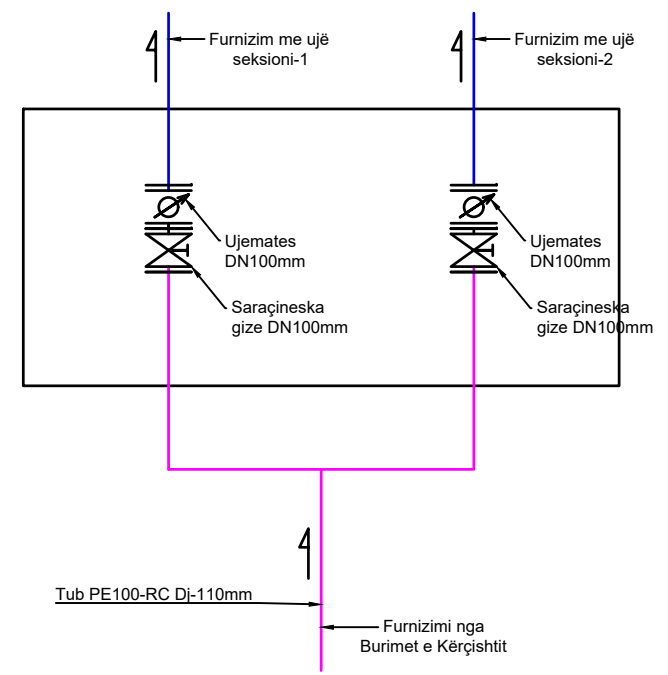

Baza Materiale		
Kodi	Emertimi	Sasia (copë)
1	Tub ekz.PE100-RC Dj-110mm	n/a
2	Adaptor Dj-110mm,Flanxhe adaptori Dj-110mm,Manikote E.F.Dj-110mm	1
3	Valvul "Globe" limitator prurje e taruar ne fabrike per Q=5.5 l/sek	1
4	Xhunto zmontimi DN100mm PN16	1
5	Ujmates me flanxha DN100mm PN16	1
6	Tub celiku DN100mm s=3.2mm	1ml
7	Pusete 1.2x1.2x1.5m	1

DETAJ PUSETA P1



Shenim Teknik: Sipas azhornimit ne puseten ekzistuese P-1 mungojne rakorderite e nevojshme per shfrytezimin e ujesjellesit.Projekti parashikon instalimin e saracineskave dhe ujmatesave sipas diametrave te tubacioneve.

POROSITES:	SHOQERIA RAJONALE UJESJELLES KANALIZIME DIBER SH.A	"ERALD - G" SH.P.K	EMERTIMI	DREJTUES I PROJEKTIT	PROJEKTUES	SHKALLA	NR. I FLETES
OBJEKTI:	"NDERTIM I RRJETIT KRYESOR FURNIZIMI ME UJE I FSHATRAVE TE NJESISE ADMINISTRATIVE MAQELLARE, FAZA 2"	 RRUGA KONGRESI I LUSHNYES TIRANE.	REHABILITIM I REZERVUARIT MAQELLARE V=1000m³	INXH. GEZIM ISLAMI	INXH. ENDRI PIERO 	1:25	6-05
				TOP. KUJTIM CANAMETI 		2024	FORMAT A3
				HIDR. ANISA ZAKA 			

DETAJ Pusetat "A"

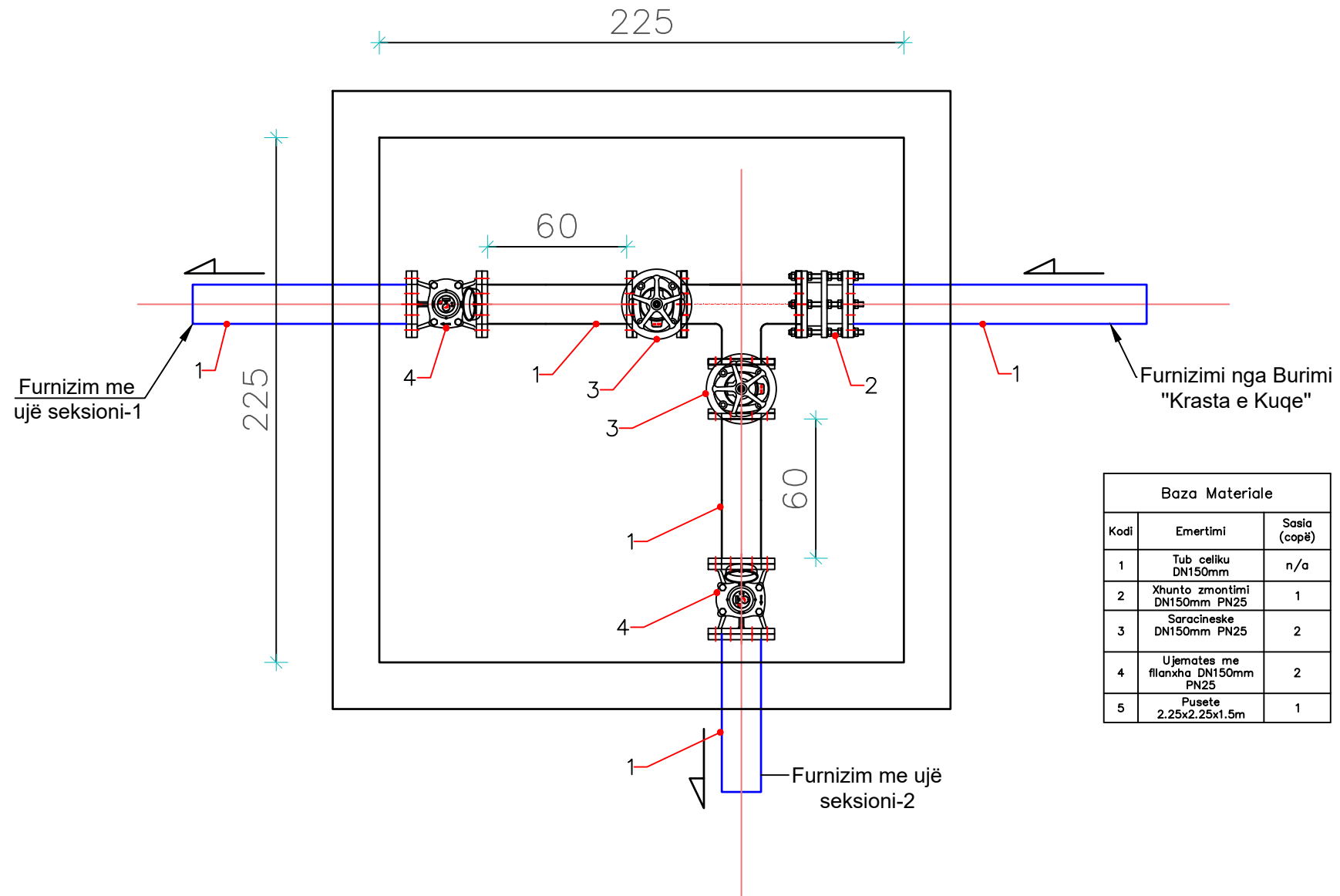

Baza Materiale		
Kodi	Emertimi	Sasia (copë)
1	Tub celiku DN150mm	n/a
2	Xhunto zmontimi DN150mm PN25	1
3	Saracineske DN150mm PN25	2
4	Ujemates me flanaxha DN150mm PN25	2
5	Pusetete 2.25x2.25x1.5m	1

POROSITES:	SHOQERIA RAJONALE UJESJELLES KANALIZIME DIBER SH.A	"ERALD - G" SH.P.K	EMERTIMI	DREJTUES I PROJEKTIT	PROJEKTUES	SHKALLA	NR. I FLETES
OBJEKTI:	"NDERTIM I RRJETIT KRYESOR FURNIZIMI ME UJE I FSHATRAVE TE NJESISE ADMINISTRATIVE MAQELLARE, FAZA 2"	 RRUGA KONGRESI I LUSHNYES TIRANE.	REHABILITIM I REZERVUARIT MAQELLARE V=1000m ³	INXH. GEZIM ISLAMI	INXH. GEZIM ISLAMI TOP. KUJTIM CANAMETI HIDR. ANISA ZAKA	INXH. ENDRI PIERO	1:25 2024 6-06 FORMAT A3

**DETAJ DHOMES SE MANOVRIMIT
REZERVARI V=1000M3 MAQELLARE**

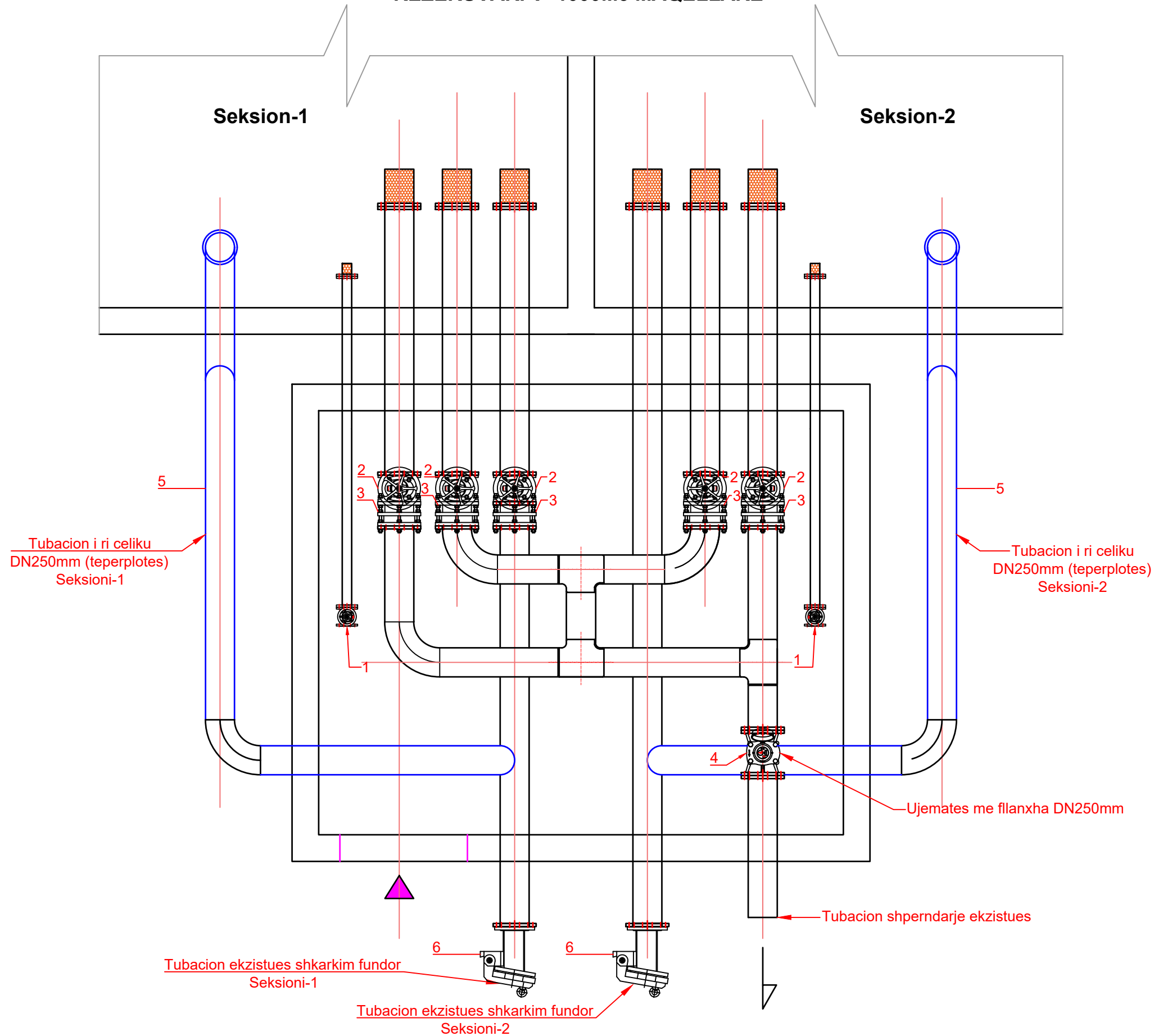

Baza Materiale		
Kodi	Emertimi	Sasia (copë)
1	Saracineske DN80mm	2
2	Saracineskë DN250mm	5
3	Xhunto zmontimi DN250mm	5
4	Ujemates me flanaxha DN250mm PN16	5
5	Tub teperplotes DN250mm per cdo seksion te rezervuarit	26ml
6	Valvul moskthimi DN250mm instaluar ne shkarkuesin fundor	2

Shenim Teknik: Projekti parashikon zevendesimin e te gjitha saracineskave ekzistuese ne dhomen e manovrimit (te cilat jane te demtuara), si dhe rehabilitimin e tubacioneve teperplotes te dy seksioneve te rezervuarit. Ne projekt eshte parashikuar gjithashtu edhe rehabilitimi strukturor i dhomes se manovrimit.

POROSITES:	SHOQERIA RAJONALE UJESJELLES KANALIZIME DIBER SH.A	"ERALD - G" SH.P.K	EMERTIMI	DREJTUES I PROJEKTI	PROJEKTUES	SHKALLA	NR. I FLETES
OBJEKTI:	"NDERTIM I RRJETIT KRYESOR FURNIZIMI ME UJE I FSHATRAVE TE NJESISE ADMINISTRATIVE MAQELLARE, FAZA 2"	 RRUGA KONGRESI I LUSHNYES TIRANE.	REHABILITIM I REZERVUARIT MAQELLARE V=1000m³	INXH. GEZIM ISLAMI	INXH. GEZIM ISLAMI TOP. KUJTIM CANAMETI HIDR. ANISA ZAKA	INXH. ENDRI PIERO	1:40 2024 6-07 FORMAT A3

**DETAJ INSTALIMIT TE TEPERPLOTESAVE
NE DY SEKSIONET E REZERVUARIT**

Sh.1:50

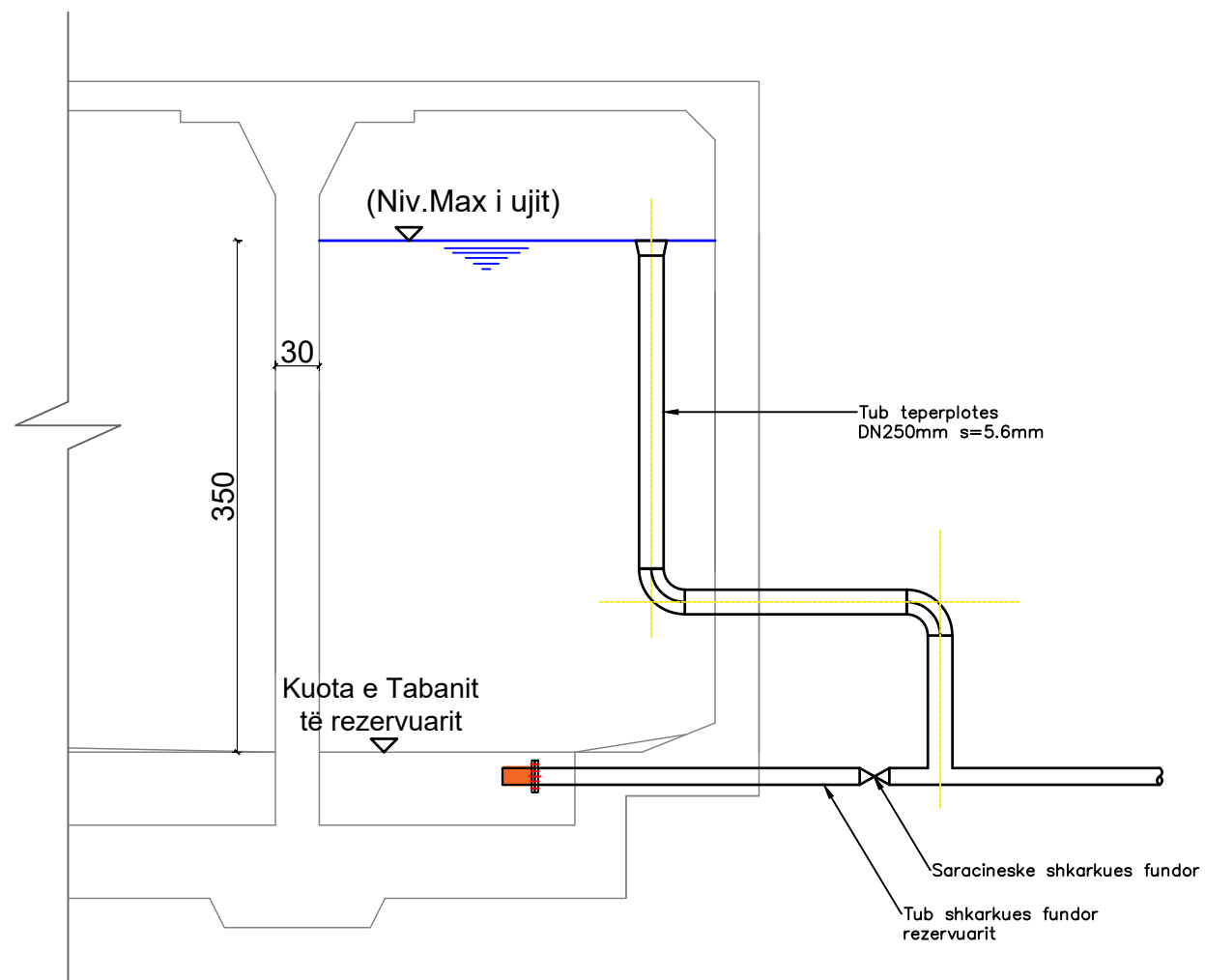

Shenime Teknike:

Ndertimi i Teperplotesave DN-250mm kanë per qellim shmangien e tejmbushjes se rezervuarit. Teperplotesit te lidhen me shkarkuesit fundor te çdo seksioni.

POROSITES:	SHOQERIA RAJONALE UJESJELLES KANALIZIME DIBER SH.A	"ERALD - G" SH.P.K	EMERTIMI	DREJTUES I PROJEKTIT	PROJEKTUES	SHKALLA	NR. I FLETES
OBJEKTI:	"NDERTIM I RRJETIT KRYESOR FURNIZIMI ME UJE I FSHATRAVE TE NJESISE ADMINISTRATIVE MAQELLARE, FAZA 2"	 RRUGA KONGRESI I LUSHNYES TIRANE.	REHABILITIM I REZERVUARIT MAQELLARE V=1000m ³	INXH. GEZIM ISLAMI	INXH. GEZIM ISLAMI TOP. KUJTIM CANAMETI HIDR. ANISA ZAKA	INXH. ENDRI PIERO	6-08
						1:50	FORMAT A3
						2024	

SKEMA HIDRAULIKE PODGORC



POROSITES:	SHOQERIA RAJONALE UJESJELLES KANALIZIME DIBER SH.A	"ERALD - G" SH.P.K	EMERTIMI	DREJTUES I PROJEKTIT	PROJEKTUES	SHKALLA	NR. I FLETES
OBJEKTI:	"NDERTIM I RRJETIT KRYESOR FURNIZIMI ME UJE I FSHATRAVE TE NJESISE ADMINISTRATIVE MAQELLARE, FAZA 2"	 RRUGA KONGRESI I LUSHNJES TIRANE.	REHABILITIM I REZERVUARIT PODGORCE	INXH. GEZIM ISLAMI	INXH. GEZIM ISLAMI TOP. KUJTIM CANAMETI HIDR. ANISA ZAKA	INXH. ENDRI PIERO	6-09 FORMAT A3
						1:250 2024	

SKEMA E NDRICIMIT

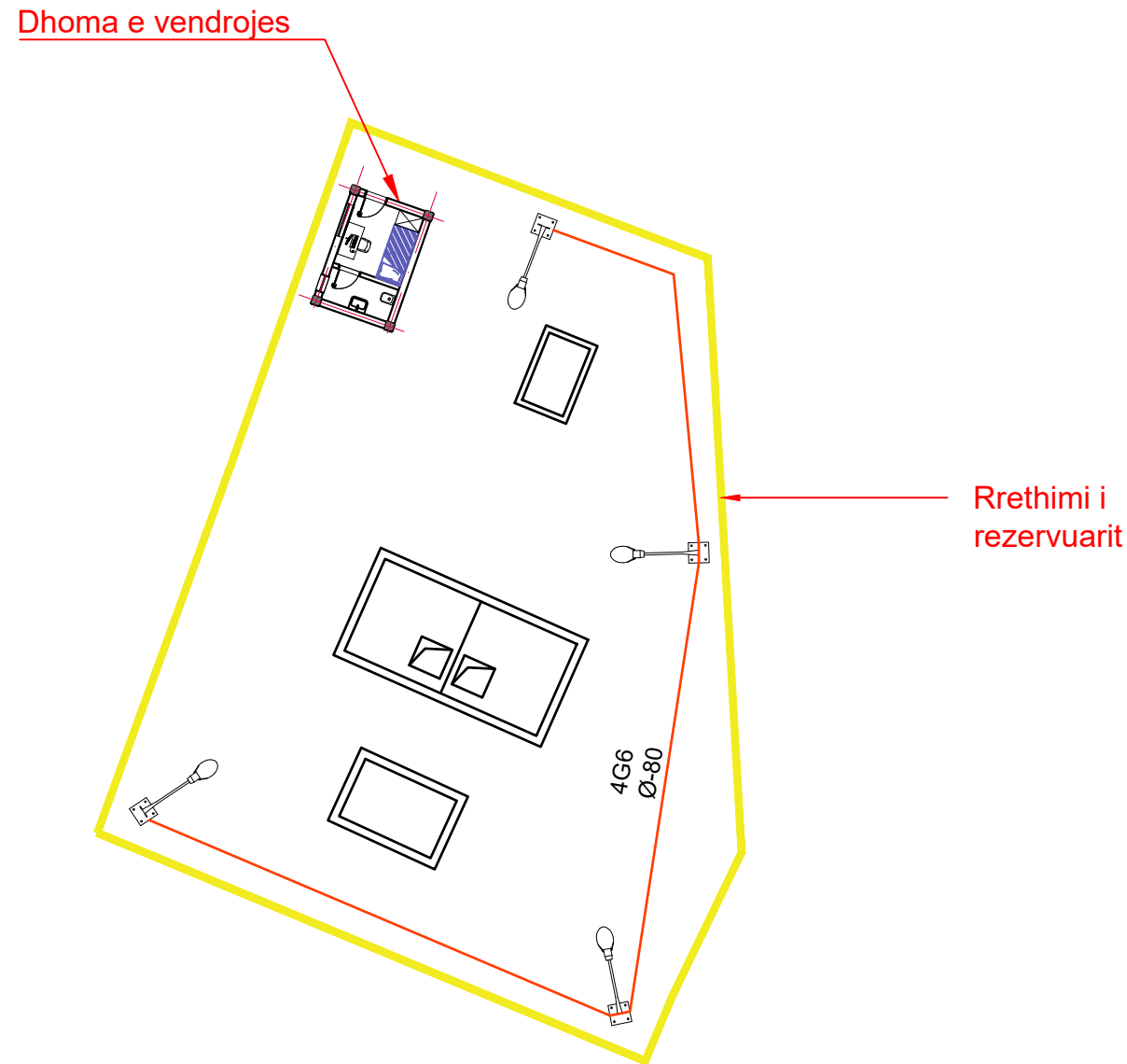

VENDOJA E KABLLIT TE FURNIZIMIT NEN TOKE

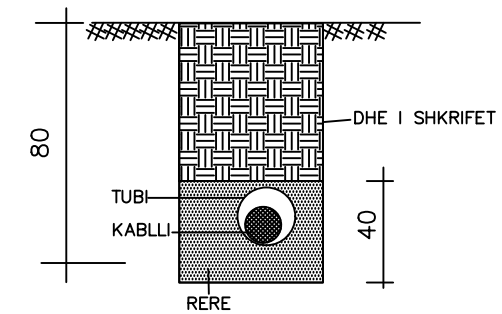

SHENIME .KABLLI DO VENDOSSET NENTOKE NE TUB KAVIDOTO TE GOMUAR MBULUAR ME NJE SHITRESE 40CM ME RERE DHE PJESA TJETER ME DHE TE SHKRIFET,ME NJE THELLESI TOTALE 80CM.

SHENIME

Ndricuesit rrugor do jene me shtylla konike te zinkuara me l-9ml me koke ndricuesi led me drite natyrale me fuqi 250-300W.

Per sistemimin e komandimit te ndricuesave do perdoret kuader komandimi kompletuar me automate dhe fotoelement drite.

POROSITES:	SHOQERIA RAJONALE UJESJELLES KANALIZIME DIBER SH.A	"ERALD - G" SH.P.K	EMERTIMI	DREJTUES I PROJEKTIT	PROJEKTUES	SHKALLA	NR. I FLETES
OBJEKTI:	"NDERTIM I RRJETIT KRYESOR FURNIZIMI ME UJE I FSHATRAVE TE NJESISE ADMINISTRATIVE MAQELLARE, FAZA 2"	 RRUGA KONGRESI I LUSHNYES TIRANE.	REHABILITIM I REZERVUARIT PODGORCE	INXH. GEZIM ISLAMI	INXH. GEZIM ISLAMI	1:250	6-10
					INXH. ENDRI PIERO <i>EP</i>	2024	FORMAT A3
					TOP. KUJTIM CANAMETI <i>KC</i>		
					HIDR. ANISA ZAKA <i>AZ</i>		

**DETAJ INSTALIMIT TE TEPERPLOTESAVE
NE DY SEKSIONET E REZERVUARIT**

Sh.1:50

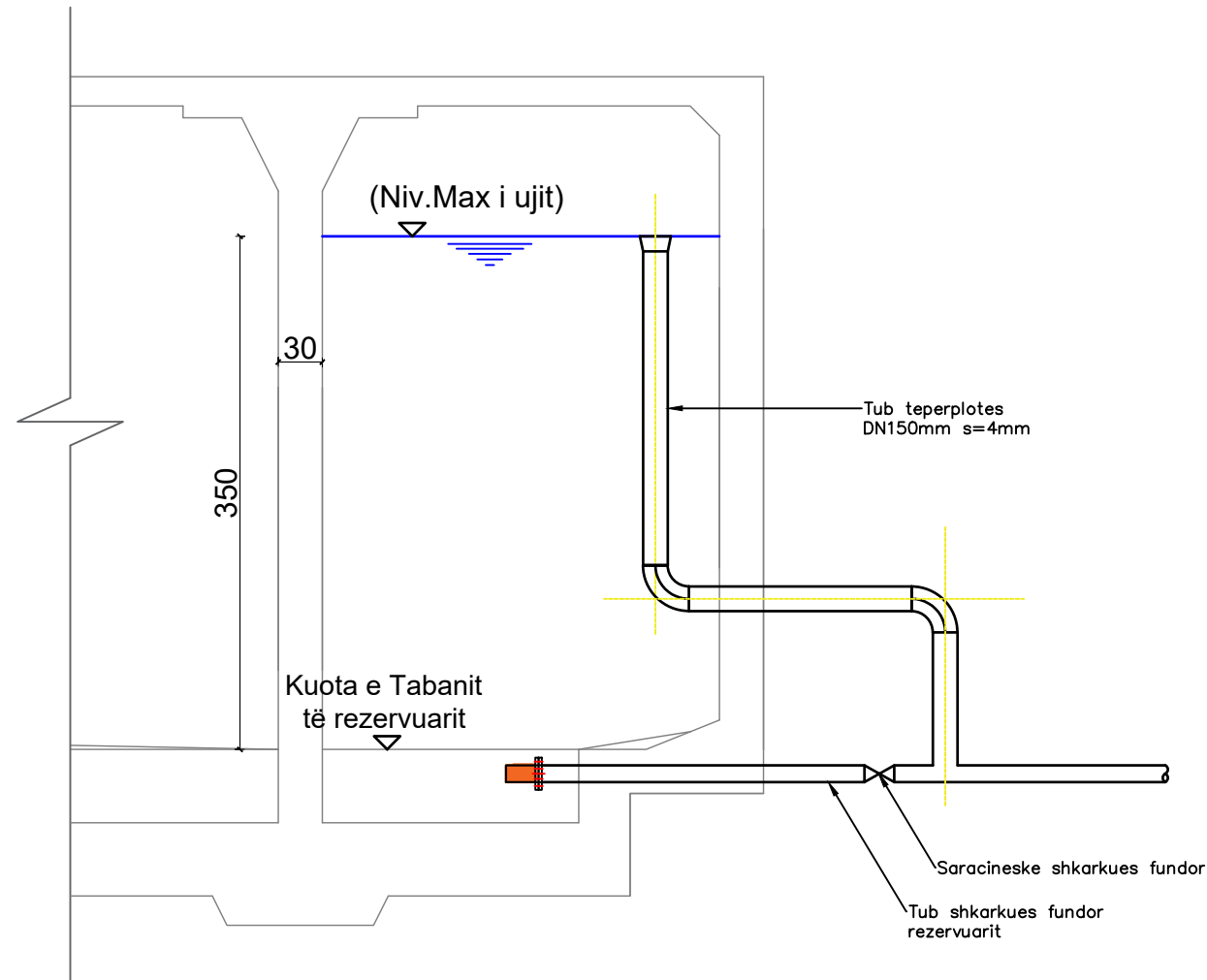



Shenime Teknike:

Ndertimi i Teperplotesave DN-150mm kanë per qellim shmangien e tejmbushjes se rezervuarit. Teperplotesit te ndertohen per te 3 rezervuaret, dhe te lidhen me shkarkuesit fundor te çdo seksioni.

POROSITES:	SHOQERIA RAJONALE UJESJELLES KANALIZIME DIBER SH.A	"ERALD - G" SH.P.K	EMERTIMI	DREJTUES I PROJEKTIT	PROJEKTUES	SHKALLA	NR. I FLETES
OBJEKTI:	"NDERTIM I RRJETIT KRYESOR FURNIZIMI ME UJE I FSHATRAVE TE NJESISE ADMINISTRATIVE MAQELLARE, FAZA 2"	 RRUGA KONGRESI I LUSHNYES TIRANE.	REHABILITIM I REZERVUARIT PODGORCE	INXH. GEZIM ISLAMI	INXH. GEZIM ISLAMI TOP. KUJTIM CANAMETI HIDR. ANISA ZAKA	INXH. ENDRI PIERO	6-11
						1:50	FORMAT A3
						2024	

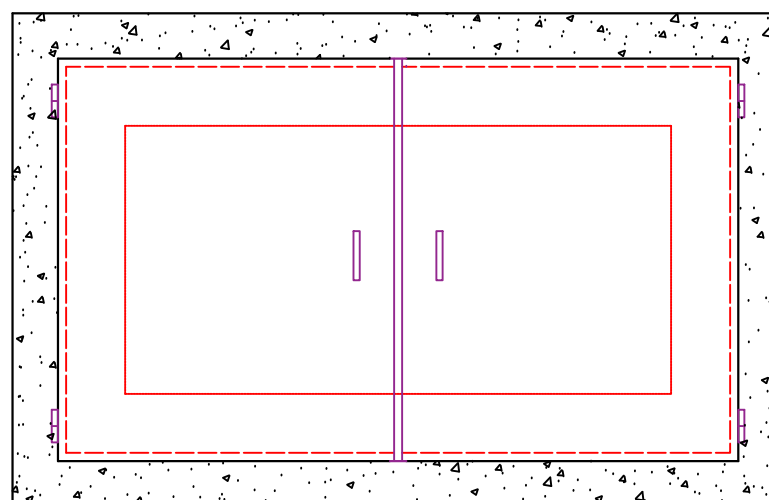
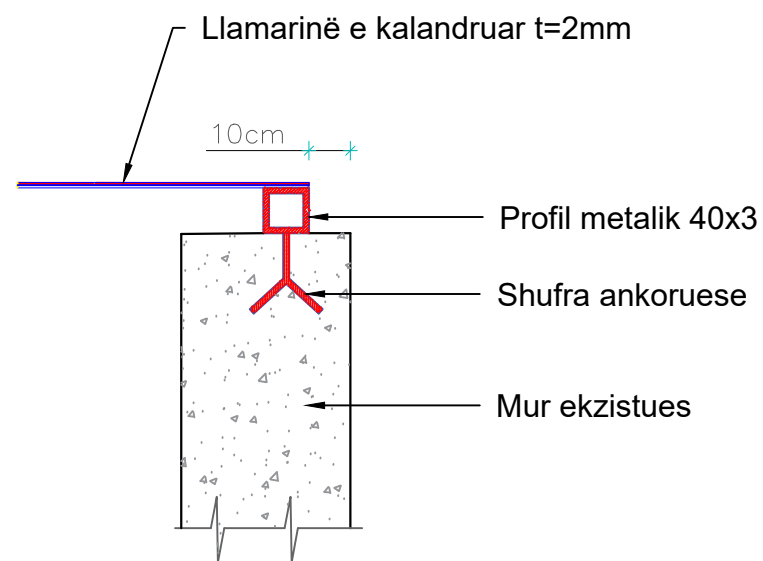
DETAJ I MBULIMIT TE KAPAKEVE PER CDO SEKSION TE REZERVUARIT



POROSITES:	SHOQERIA RAJONALE UJESJELLES KANALIZIME DIBER SH.A	"ERALD - G" SH.P.K	EMERTIMI	DREJTUES I PROJEKTIT	PROJEKTUES	SHKALLA	NR. I FLETES
OBJEKTI:	"NDERTIM I RRJETIT KRYESOR FURNIZIMI ME UJE I FSHATRAVE TE NJESISE ADMINISTRATIVE MAQELLARE, FAZA 2"	 <small>RRUGA KONGRESI I LUSHNYES TIRANE.</small>	REHABILITIM I REZERVUARIT PODGORCE	<small>INXH. GEZIM ISLAMI</small> <small>INXH. GEZIM ISLAMI</small> <small>TOP. KUJTIM CANAMETI</small> <small>HIDR. ANISA ZAKA</small>	<small>INXH. ENDRI PIERO</small>	1:40 2024	6-12 FORMAT A3

DETAJ INSTALIMIT TE GALEXHANTEVE NE DY SEKSIONET E REZERVUARIT

Sh.1:50

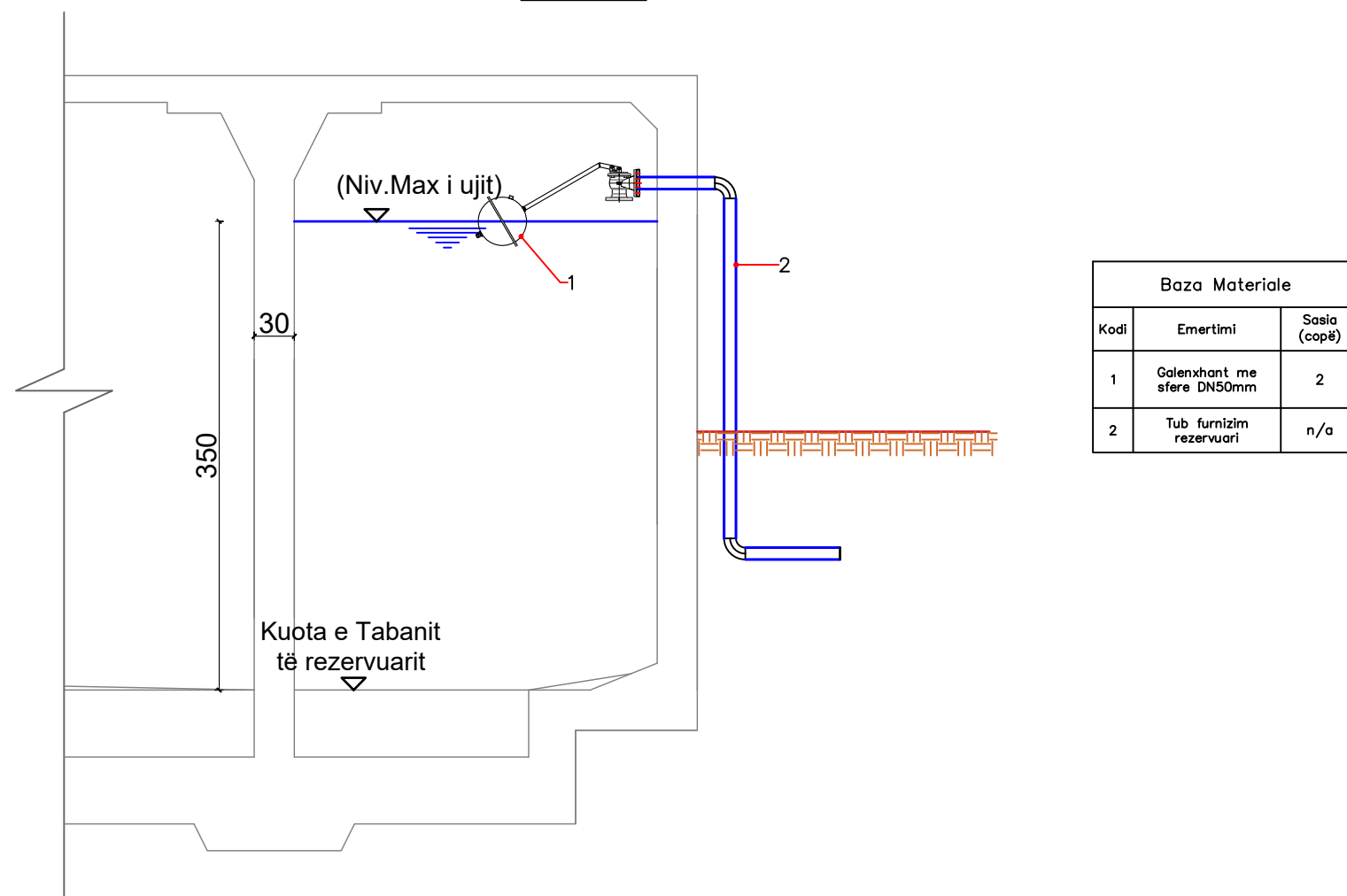

Shenime Teknike:

Projekti parashikon instalimin e galenxhanteve per cdo seksion te rezervuarit.
Diametri i projektuar per galenxhantin eshte specifikuar ne varesi te prurjes ne hyrje te rezervuarit

POROSITES:	SHOQERIA RAJONALE UJESJELLES KANALIZIME DIBER SH.A	"ERALD - G" SH.P.K	EMERTIMI	DREJTUES I PROJEKTIT	PROJEKTUES	SHKALLA	NR. I FLETES
OBJEKTI:	"NDERTIM I RRJETIT KRYESOR FURNIZIMI ME UJE I FSHATRAVE TE NJESISE ADMINISTRATIVE MAQELLARE, FAZA 2"	RRUGA KONGRESI I LUSHNJES TIRANE.	REHABILITIM I REZERVUARIT PODGORCE	INXH. GEZIM ISLAMI	INXH. GEZIM ISLAMI TOP. KUJTIM CANAMETI HIDR. ANISA ZAKA	INXH. ENDRI PIERO	6-13
						1:50	FORMAT A3
						2024	

DETAJ PUSETA "B"

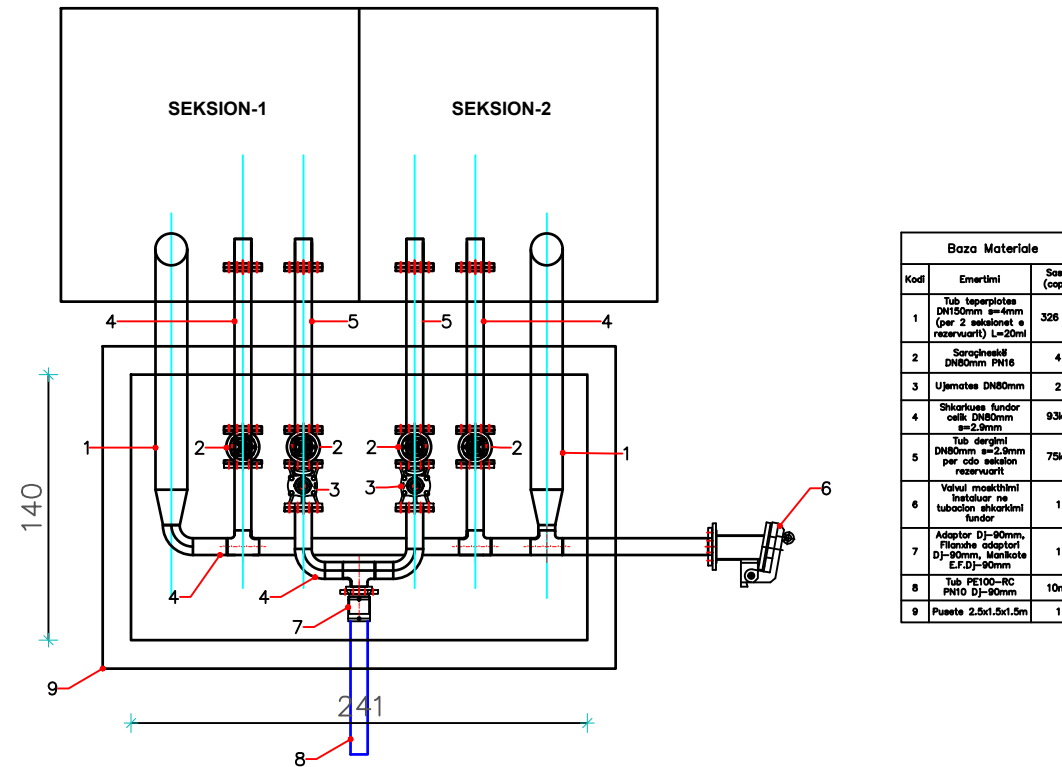

Shenime Teknike:

Nga verifikimet ne vend, rezultojne te paplota elementet teknik te rezervuarit.

- 1.Projekti parashikon instalimin e pusetes se manovrimit, sebashku me te gjitha rakorderite e nevojshme.
- 2.Gjate zbatimit te punimeve te verifikohen ne brendesi te rezervuarit gjendja e shkarkuesit fundor si dhe tubacioneve te dergimit. Ne rast se rezultojne te demtuara, te zbatohet detaji. Tubacioni i shkarkimit fundor te pajiset me valvul moskthimi (flap valve)
- 3.Tubacioni i dergimit i paraqitur ne vizatim te lidhet me tubacionin ekzistues, i cili duhet te verifikohet.
- 4.Per cdo paqartesi te kontaktohet me grupin e projektimit

POROSITES:	SHOQERIA RAJONALE UJESJELLES KANALIZIME DIBER SH.A	"ERALD - G" SH.P.K	EMERTIMI	DREJTUES I PROJEKTTIT	PROJEKTUES	SHKALLA	NR. I FLETES
OBJEKTI:	"NDERTIM I RRJETIT KRYESOR FURNIZIMI ME UJE I FSHATRAVE TE NJESISE ADMINISTRATIVE MAQELLARE, FAZA 2"	 RRUGA KONGRESI I LUSHNYES TIRANE.	REHABILITIM I REZERVUARIT PODGORCE	INXH. GEZIM ISLAMI	INXH. GEZIM ISLAMI TOP. KUJTIM CANAMETI HIDR. ANISA ZAKA	INXH. ENDRI PIERO	1:40 2024 6-14 FORMAT A3

SKEMAT E PUSITES EKZISTUESE P2
(PUSETE FURNIZIM REZERVUARIT)
SIPAS VERIFIKIMIT NE VEND

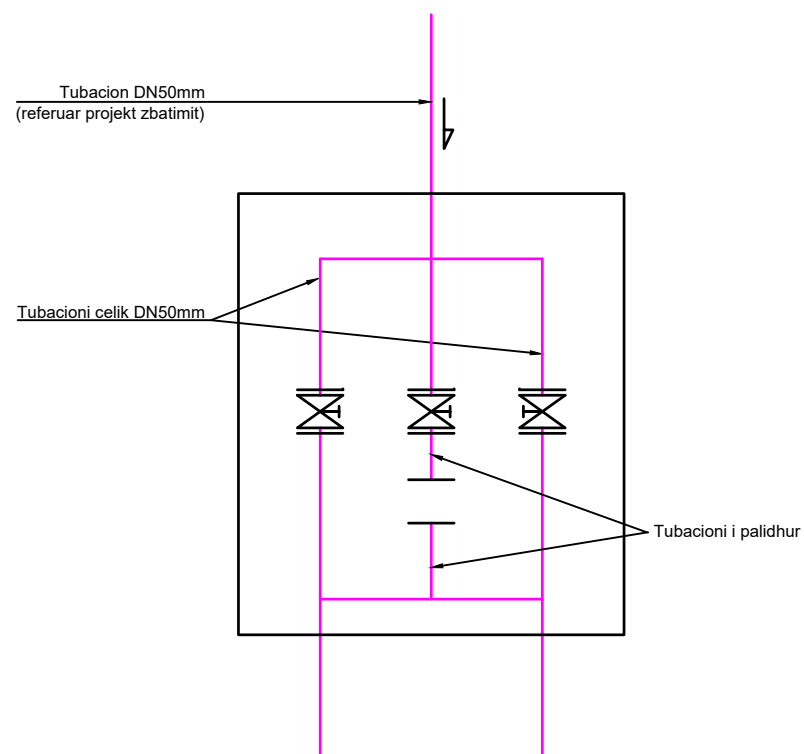

SKEMAT E PUSITES EKZISTUESE P2
(E PERFUNDUAR)

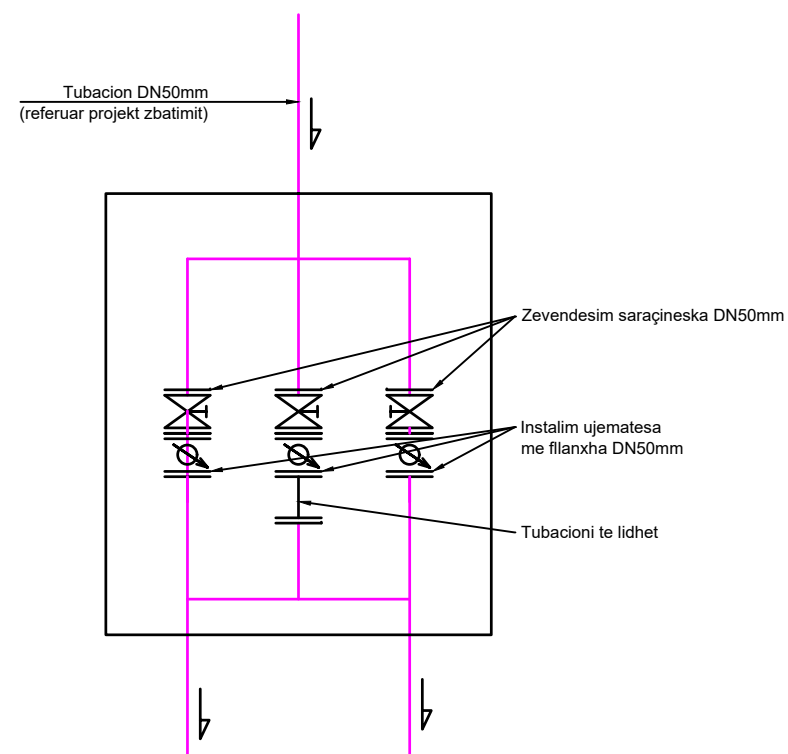

Shenim Teknik: Nderhyrjet e parashikuara puseta P2:
 - Instalim saraçineskave DN50mm
 - Instalim ujematesave me flanaxha
 - Vendorsje kapakut te pusetes

Simbole Hidraulike

- Tubacion çeliku me flanaxhë
- Saraçineskë instaluar ne tubacion çeliku
- Ujemates me flanaxha

POROSITES:	SHOQERIA RAJONALE UJESJELLES KANALIZIME DIBER SH.A	"ERALD - G" SH.P.K	EMERTIMI	DREJTUES I PROJEKTIT	PROJEKTUES	SHKALLA	NR. I FLETES
OBJEKTI:	"NDERTIM I RRJETIT KRYESOR FURNIZIMI ME UJE I FSHATRAVE TE NJESISE ADMINISTRATIVE MAQELLARE, FAZA 2"	RRUGA KONGRESI I LUSHNYES TIRANE.	REHABILITIM I REZERVUARIT PODGORCE	INXH. GEZIM ISLAMI	INXH. GEZIM ISLAMI TOP. KUJTIM ÇANAMETI HIDR. ANISA ZAKA	INXH. ENDRI PIERO	6-15
						1:25	FORMAT A3
						2024	

SKEMA HIDRAULIKE VOJNIK

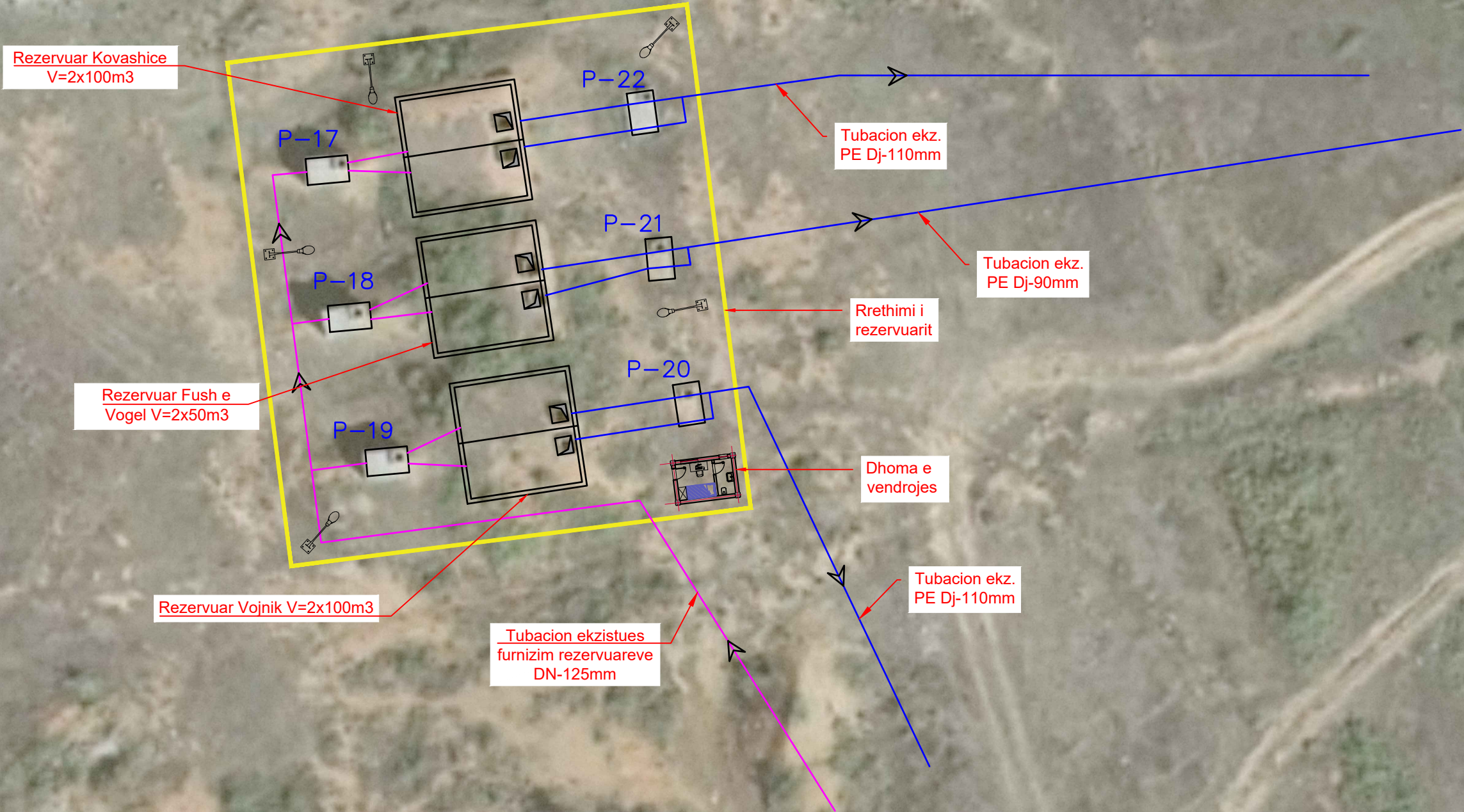

POROSITES:	SHOQERIA RAJONALE UJESJELLES KANALIZIME DIBER SH.A	"ERALD - G" SH.P.K	EMERTIMI	DREJTUES I PROJEKTIT	PROJEKTUES	SHKALLA	NR. I FLETES
OBJEKTI:	"NDERTIM I RRJETIT KRYESOR FURNIZIMI ME UJE I FSHATRAVE TE NJESISE ADMINISTRATIVE MAQELLARE, FAZA 2"	 RRUGA KONGRESI I LUSHNJES TIRANE.	REHABILITIM I REZERVUARIT VOJNIK	INXH. GEZIM ISLAMI	INXH. GEZIM ISLAMI TOP. KUJTIM CANAMETI HIDR. ANISA ZAKA	INXH. ENDRI PIERO	6-16 FORMAT A3
						1:250 2024	

SKEMA E NDRICIMIT

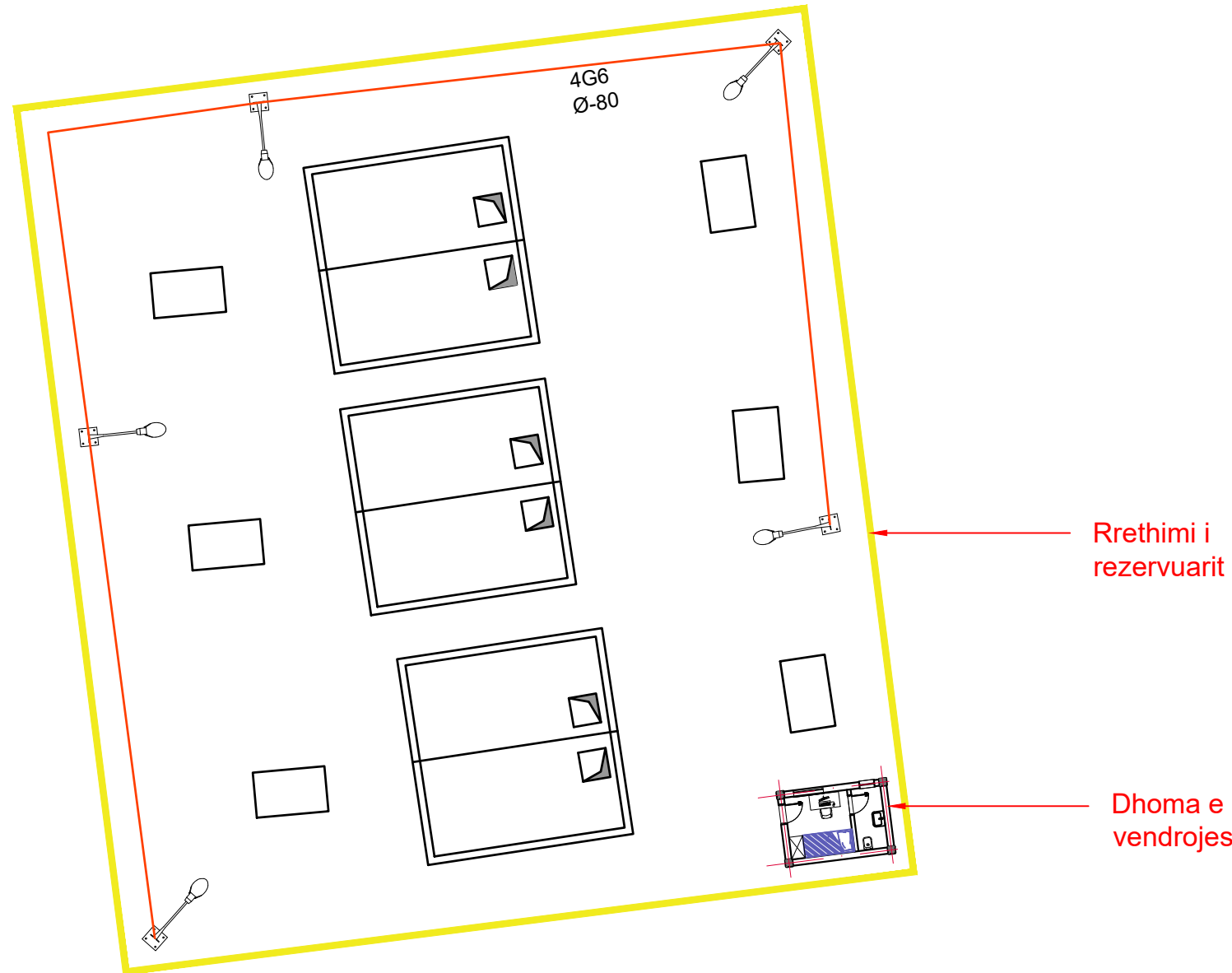

VENDOJA E KABLLIT TE FURNIZIMIT NEN TOKE

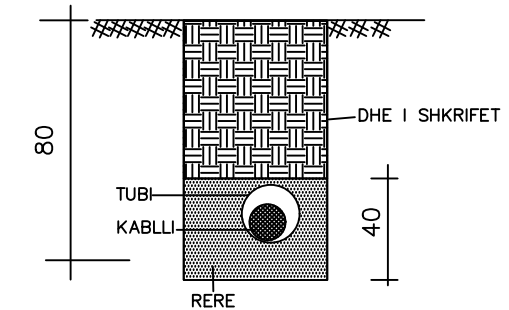

SHENIME .KABLLI DO VENDOSSET NENTOKE NE TUB KAVIDOTO TE GOMUAR MBULUAR ME NJE SHITRESE 40CM ME RERE DHE PJESA TJETER ME DHE TE SHKRIFET,ME NJE THELLESI TOTALE 80CM.

SHENIME

Ndricesit rrugor do jene me shtylla konike te zinkuara me l-9ml me koke ndricuesi led me drite natyrale me fuqi 250-300W.
Per sistemimin e komandimit te ndricuesave do perdoret kuader komandimi kompletuar me automate dhe fotoelement drite.

POROSITES:	SHOQERIA RAJONALE UJESJELLES KANALIZIME DIBER SH.A	"ERALD - G" SH.P.K	EMERTIMI	DREJTUES I PROJEKTIT	PROJEKTUES	SHKALLA	NR. I FLETES
OBJEKTI:	"NDERTIM I RRJETIT KRYESOR FURNIZIMI ME UJE I FSHATRAVE TE NJESISE ADMINISTRATIVE MAQELLARE, FAZA 2"	 RRUGA KONGRESI I LUSHNYES TIRANE.	REHABILITIM I REZERVUARIT VOJNIK	INXH. GEZIM ISLAMI	INXH. ENDRI PIERO 	1:250	6-17
				TOP. KUJTIM CANAMETI 		2024	FORMAT A3
				HIDR. ANISA ZAKA 			

**DETAJ INSTALIMIT TE TEPERPLOTESAVE
NE DY SEKSIONET E REZERVUARIT**

Sh.1:50

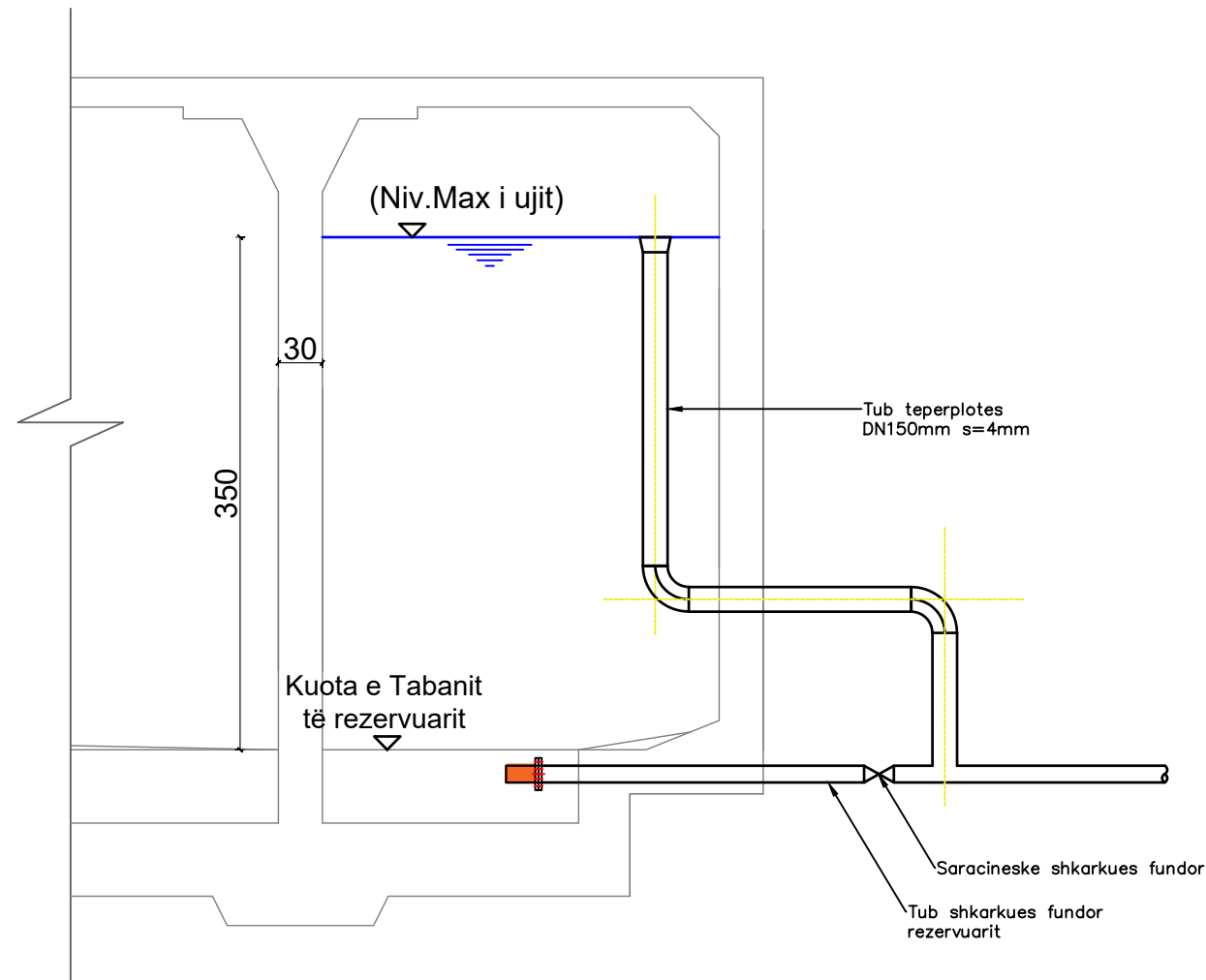

Shenime Teknike:

Ndertimi i Teperplotesave DN-150mm kanë për qëllim shmangien e tejmbushjes së rezervuarit. Teperplotesit të ndertohen për të 3 rezervuaret, dhe të lidhen me shkarkuesit fundor të çdo seksioni.

POROSITES:	SHOQERIA RAJONALE UJESJELLES KANALIZIME DIBER SH.A	"ERALD - G" SH.P.K	EMERTIMI	DREJTUES I PROJEKTIT	PROJEKTUES	SHKALLA	NR. I FLETES
OBJEKTI:	"NDERTIM I RRJETIT KRYESOR FURNIZIMI ME UJE I FSHATRAVE TE NJESISE ADMINISTRATIVE MAQELLARE, FAZA 2"	 RRUGA KONGRESI I LUSHNYES TIRANE.	REHABILITIM I REZERVUARIT VOJNIK	INXH. GEZIM ISLAMI	INXH. GEZIM ISLAMI TOP. KUJTIM CANAMETI HIDR. ANISA ZAKA	INXH. ENDRI PIERO	6-18
						1:50	FORMAT A3
						2024	

DETAJ I MBULIMIT TE KAPAKEVE PER CDO SEKSION TE REZERVUARIT

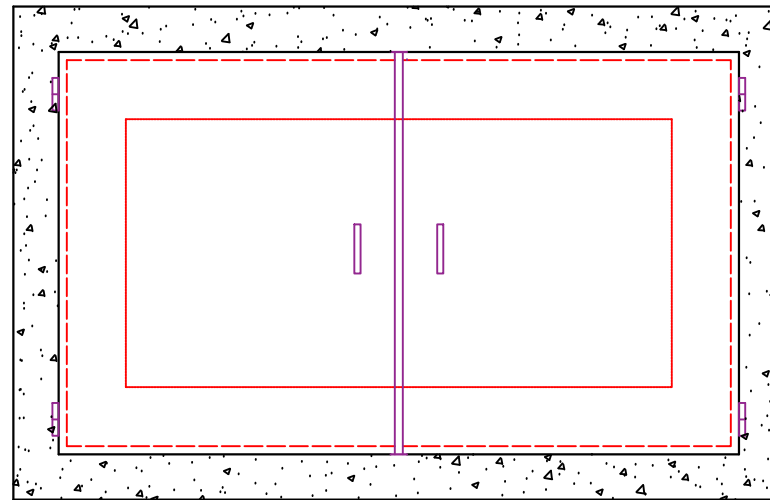
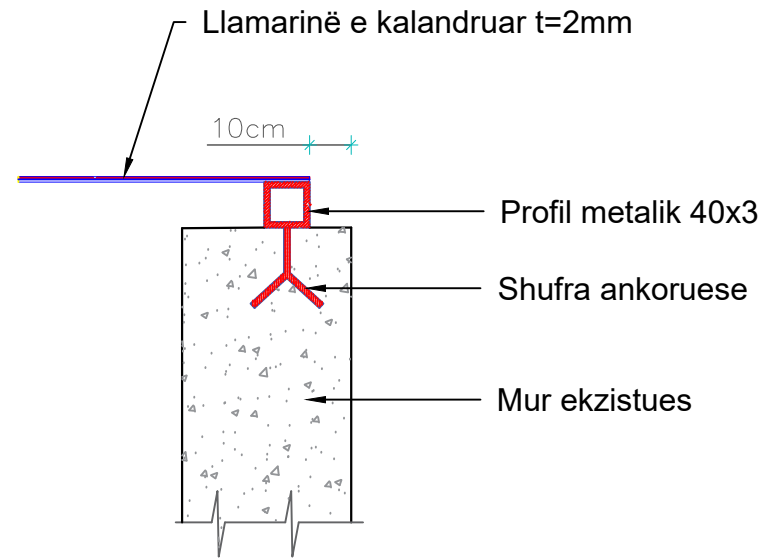

POROSITES:	SHOQERIA RAJONALE UJESJELLES KANALIZIME DIBER SH.A	"ERALD - G" SH.P.K	EMERTIMI	DREJTUES I PROJEKTIT	PROJEKTUES	SHKALLA	NR. I FLETES
OBJEKTI:	"NDERTIM I RRJETIT KRYESOR FURNIZIMI ME UJE I FSHATRAVE TE NJESISE ADMINISTRATIVE MAQELLARE, FAZA 2"	 RRUGA KONGRESI I LUSHNJES TIRANE.	REHABILITIM I REZERVUARIT VOJNIK	INXH. GEZIM ISLAMI	INXH. GEZIM ISLAMI TOP. KUJTIM CANAMETI HIDR. ANISA ZAKA	INXH. ENDRI PIERO	6-19
						1:40	FORMAT A3
						2024	

**DETAJ INSTALIMIT TE GALEXHANTEVE
NE DY SEKSIONET E REZERVUARIT
Sh.1:50**

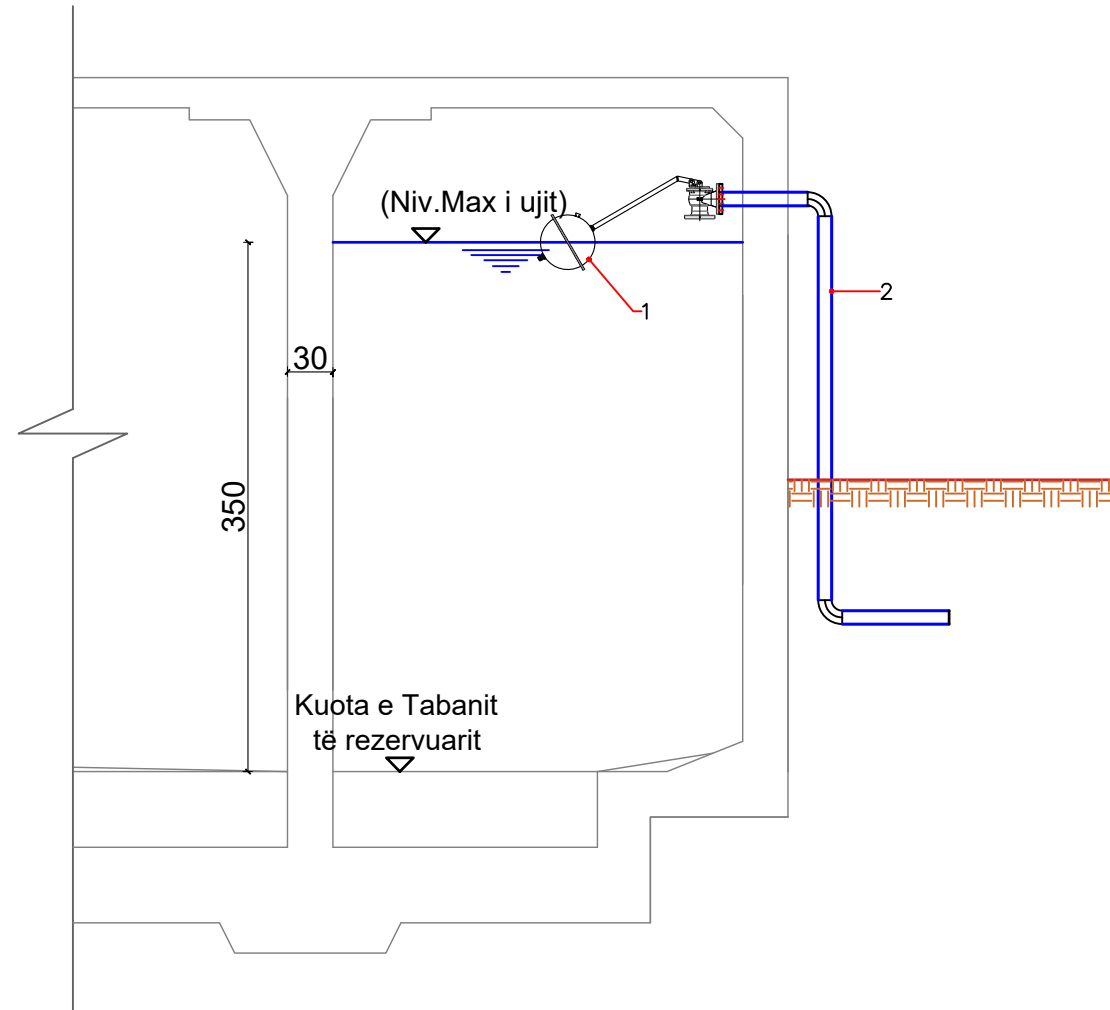

Baza Materiale		
Kodi	Emertimi	Sasia (copë)
1	Galenxhant me sferë DN80mm	6
2	Tub furnizim rezervuarit	n/a

Shenime Teknike:

Projekti parashikon instalimin e galexhanteve per cdo seksion te rezervuarit.
Diametri i projektuar per galenxhantin eshte specifikuar ne varesi te prurjes ne hyrje te rezervuarit

POROSITES:	SHOQERIA RAJONALE UJESJELLES KANALIZIME DIBER SH.A	"ERALD - G" SH.P.K	EMERTIMI	DREJTUES I PROJEKTIT	PROJEKTUES	SHKALLA	NR. I FLETES
OBJEKTI:	"NDERTIM I RRJETIT KRYESOR FURNIZIMI ME UJE I FSHATRAVE TE NJESISE ADMINISTRATIVE MAQELLARE, FAZA 2"	 RRUGA KONGRESI I LUSHNYES TIRANE.	REHABILITIM I REZERVUARIT VOJNIK	INXH. GEZIM ISLAMI	INXH. GEZIM ISLAMI TOP. KUJTIM CANAMETI HIDR. ANISA ZAKA	INXH. ENDRI PIERO	1:40 2024 6-20 FORMAT A3

SKEMAT E PUSITES EKZISTUESE P20,P21,P22
PAS NDERHYRJES

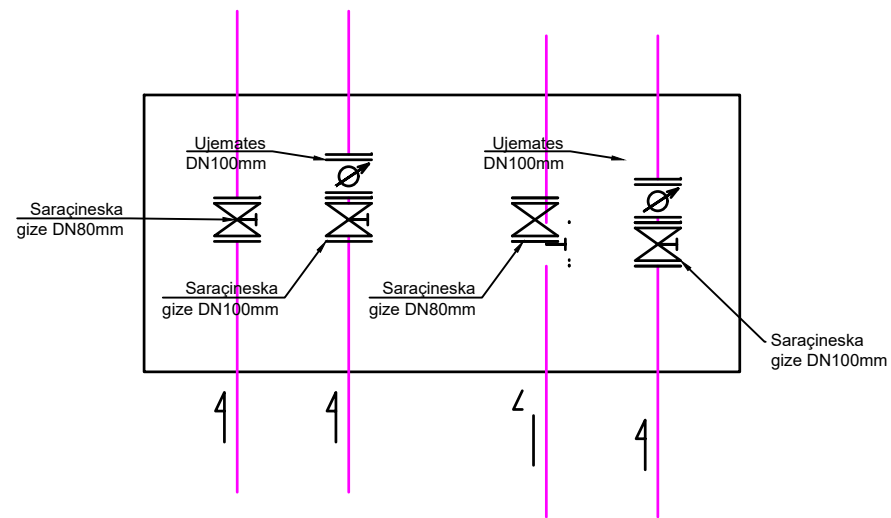

Shenim Teknik:Nderhyrjet e parashikuara puseta P13:
- Instalim saracineskave DN80mm, DN100mm
-Instalim ujematesave me flanaxha
-Vendosje kapakut te pusetes

SKEMAT E PUSITES EKZISTUESE P17,P18,19
(PUSETE FURNIZIM REZERVUARIT)
SIPAS VERIFIKIMIT NE VEND

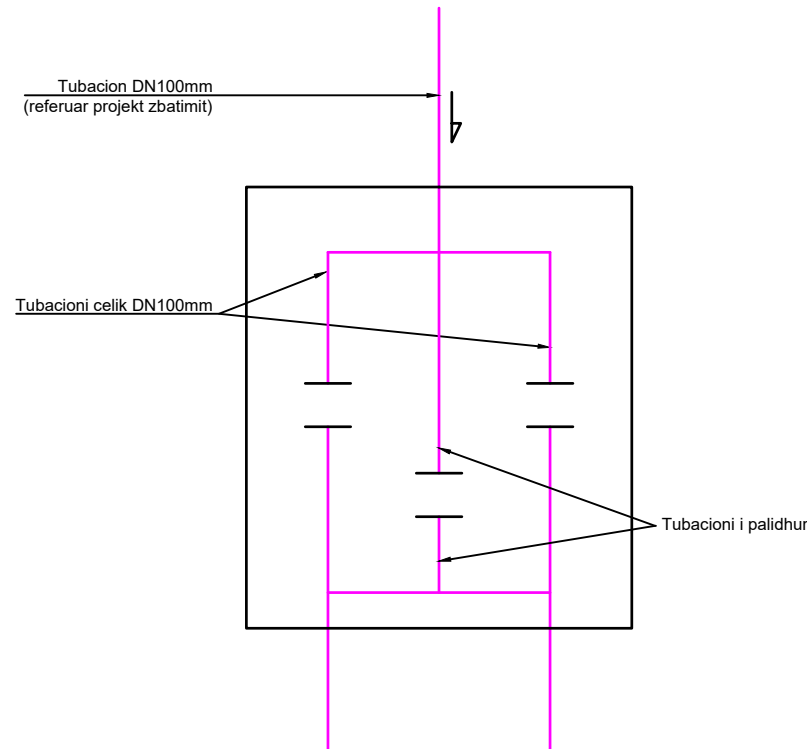

Shenim Teknik:Nderhyrjet e parashikuara puseta P2:
- Instalim saracineskave DN100mm
-Instalim ujematesave me flanaxha
-Vendosje kapakut te pusetes

SKEMAT E PUSITES EKZISTUESE P17,P18,19
(E PERFUNDUAR)

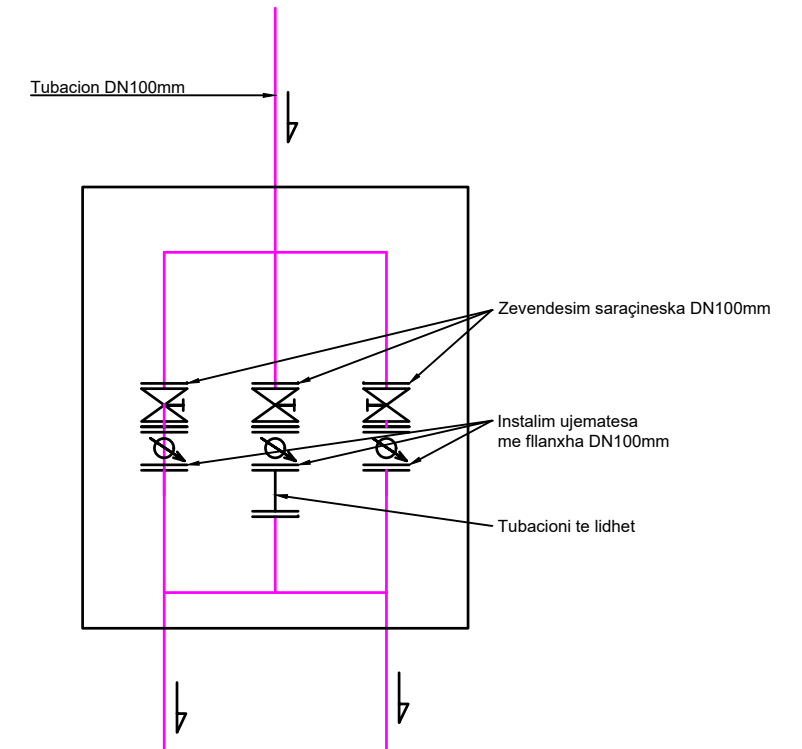



Simbole Hidraulike

- Tubacion çeliku me flanaxhë
- Saraçineskë instaluar ne tubacion çeliku
- Ujemates me flanaxha

POROSITES:	SHOQERIA RAJONALE UJESJELLES KANALIZIME DIBER SH.A	"ERALD - G" SH.P.K	EMERTIMI	DREJTUES I PROJEKTIT	PROJEKTUES	SHKALLA	NR. I FLETES
OBJEKTI:	"NDERTIM I RRJETIT KRYESOR FURNIZIMI ME UJE I FSHATRAVE TE NJESISE ADMINISTRATIVE MAQELLARE, FAZA 2"	RRUGA KONGRESI I LUSHNYES TIRANE.	REHABILITIM I REZERVUARIT VOJNIK	INXH. GEZIM ISLAMI	INXH. GEZIM ISLAMI TOP. KUJTIM CANAMETI HIDR. ANISA ZAKA	INXH. ENDRI PIERO	6-21
						1:25	FORMAT A3
						2024	

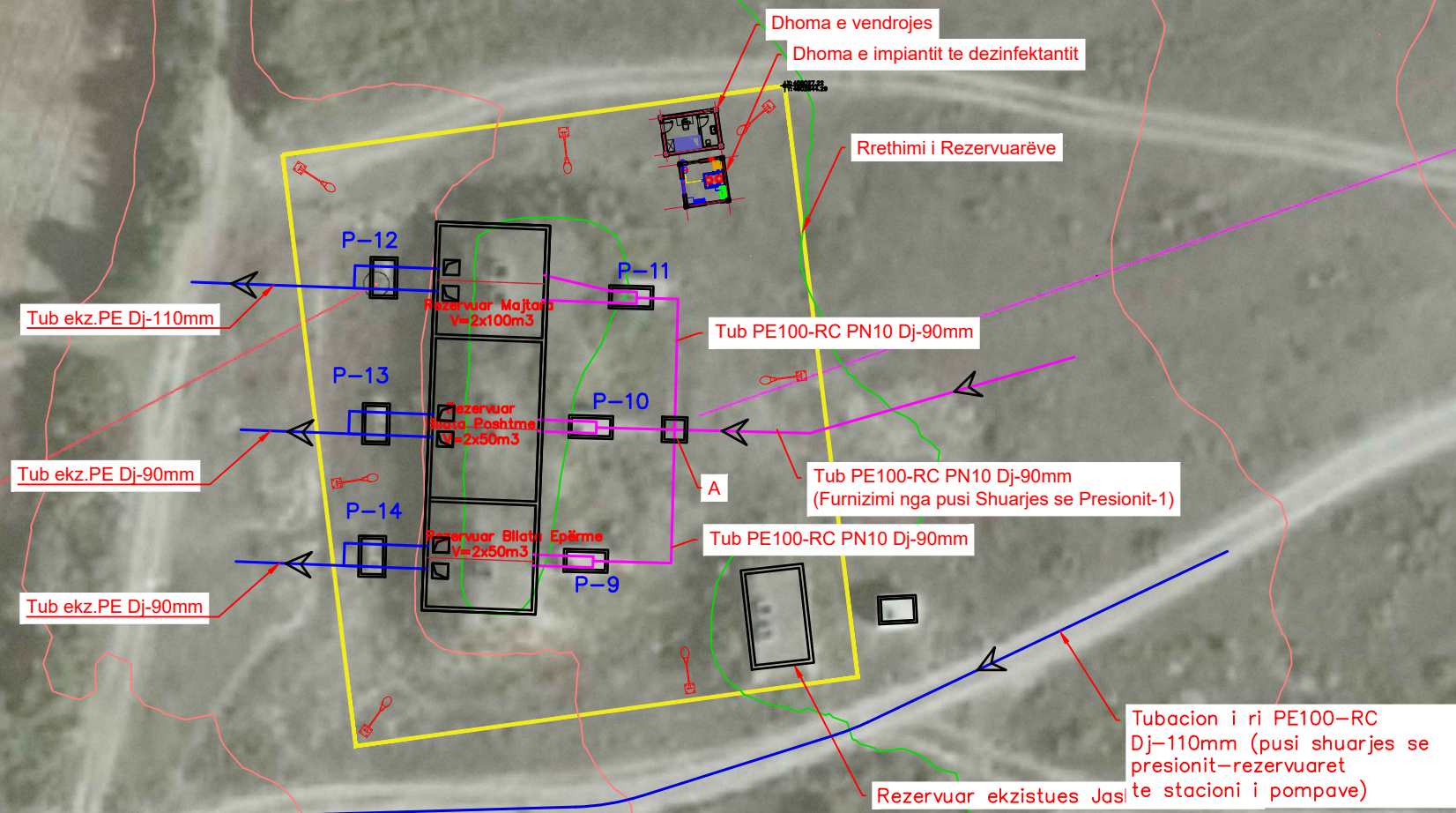
SKEMA HIDRAULIKE NE REZERVUARE



POROSITES:	SHOQERIA RAJONALE UJESJELLES KANALIZIME DIBER SH.A	"ERALD - G" SH.P.K	EMERTIMI	DREJTUES I PROJEKTIT	PROJEKTUES	SHKALLA	NR. I FLETES
OBJEKTI:	"NDERTIM I RRJETIT KRYESOR FURNIZIMI ME UJE I FSHATRAVE TE NJESISE ADMINISTRATIVE MAQELLARE, FAZA 2"	 RRUGA KONGRESI I LUSHNYES TIRANE.	REHABILITIM I REZERVUAREVE BLLATE & MAJTARE	INXH. GEZIM ISLAMI	INXH. GEZIM ISLAMI TOP. KUJTIM CANAMETI HIDR. ANISA ZAKA	INXH. ENDRI PIERO	6-22 FORMAT A3
						1:500 2024	

SKEMA E NDRICIMIT

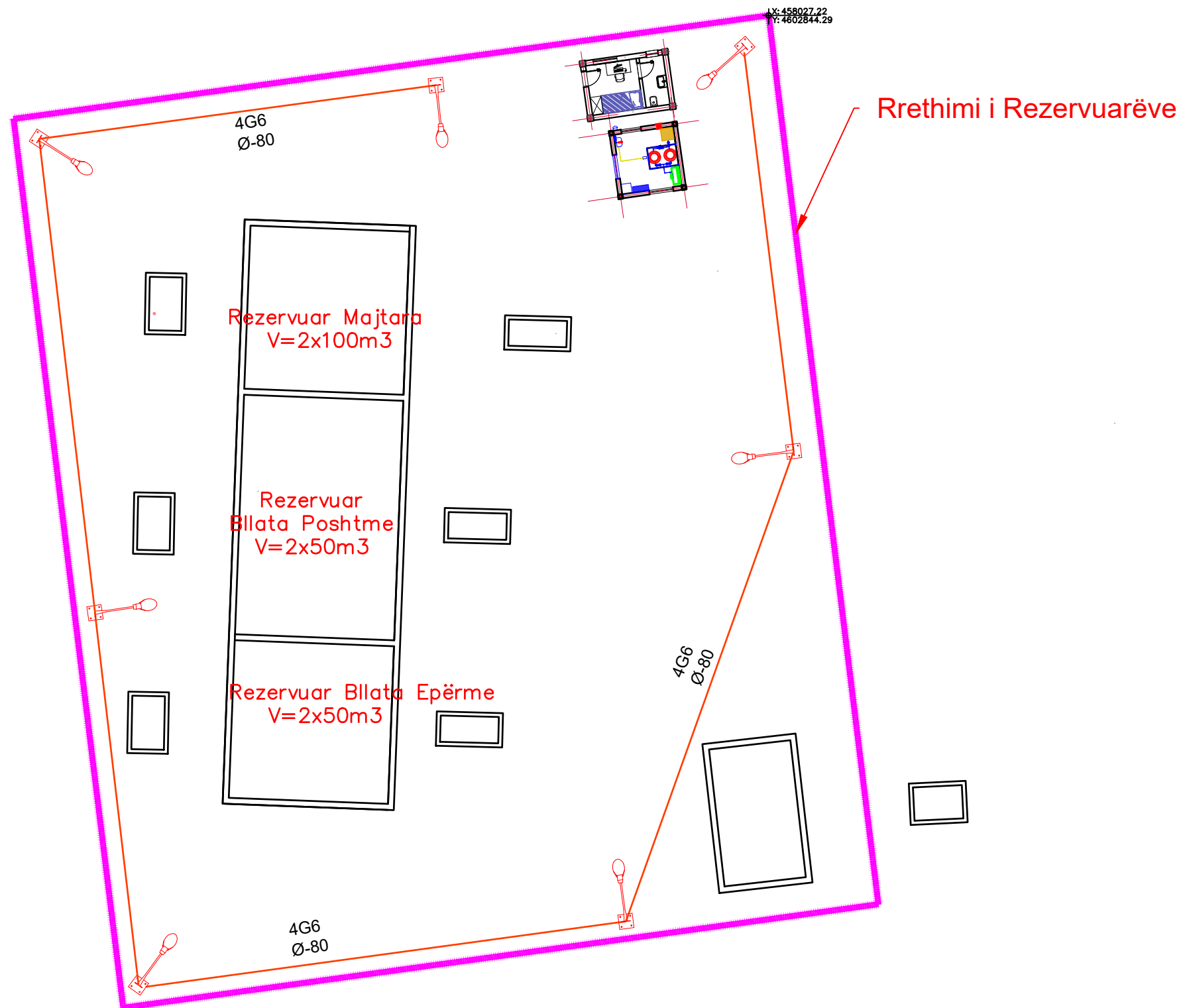

VENDOJA E KABLLIT TE FURNIZIMIT NEN TOKE

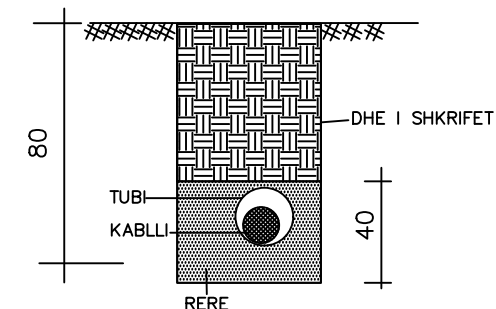

SHENIME .KABLLI DO VENDOSSET NENTOKE NE TUB KAVIDOTO TE GOMUAR MBULUAR ME NJE SHITRESE 40CM ME RERE DHE PJESA TJETER ME DHE TE SHKRIFET,ME NJE THELLESI TOTALE 80CM.

SHENIME

Ndricuesit rrugor do jene me shtylla konike te zinkuara me l-9ml me koke ndricuesi led me drite natyrale me fuqi 250-300W.
Per sistemimin e komandimit te ndricuesave do perdoret kuader komandimi kompletuar me automate dhe fotoelement drite.

POROSITES:	SHOQERIA RAJONALE UJESJELLES KANALIZIME DIBER SH.A	"ERALD - G" SH.P.K	EMERTIMI	DREJTUES I PROJEKTIT	PROJEKTUES	SHKALLA	NR. I FLETES
OBJEKTI:	"NDERTIM I RRJETIT KRYESOR FURNIZIMI ME UJE I FSHATRAVE TE NJESISE ADMINISTRATIVE MAQELLARE, FAZA 2"	 RRUGA KONGRESI I LUSHNYES TIRANE.	REHABILITIM I REZERVUAREVE BLLATE & MAJTARE	INXH. GEZIM ISLAMI	INXH. GEZIM ISLAMI TOP. KUJTIM CANAMETI HIDR. ANISA ZAKA	INXH. ENDRI PIERO	6-23 FORMAT A3
						1:250 2024	

SKEMA E IMPIANTIT TE KLORINIMIT

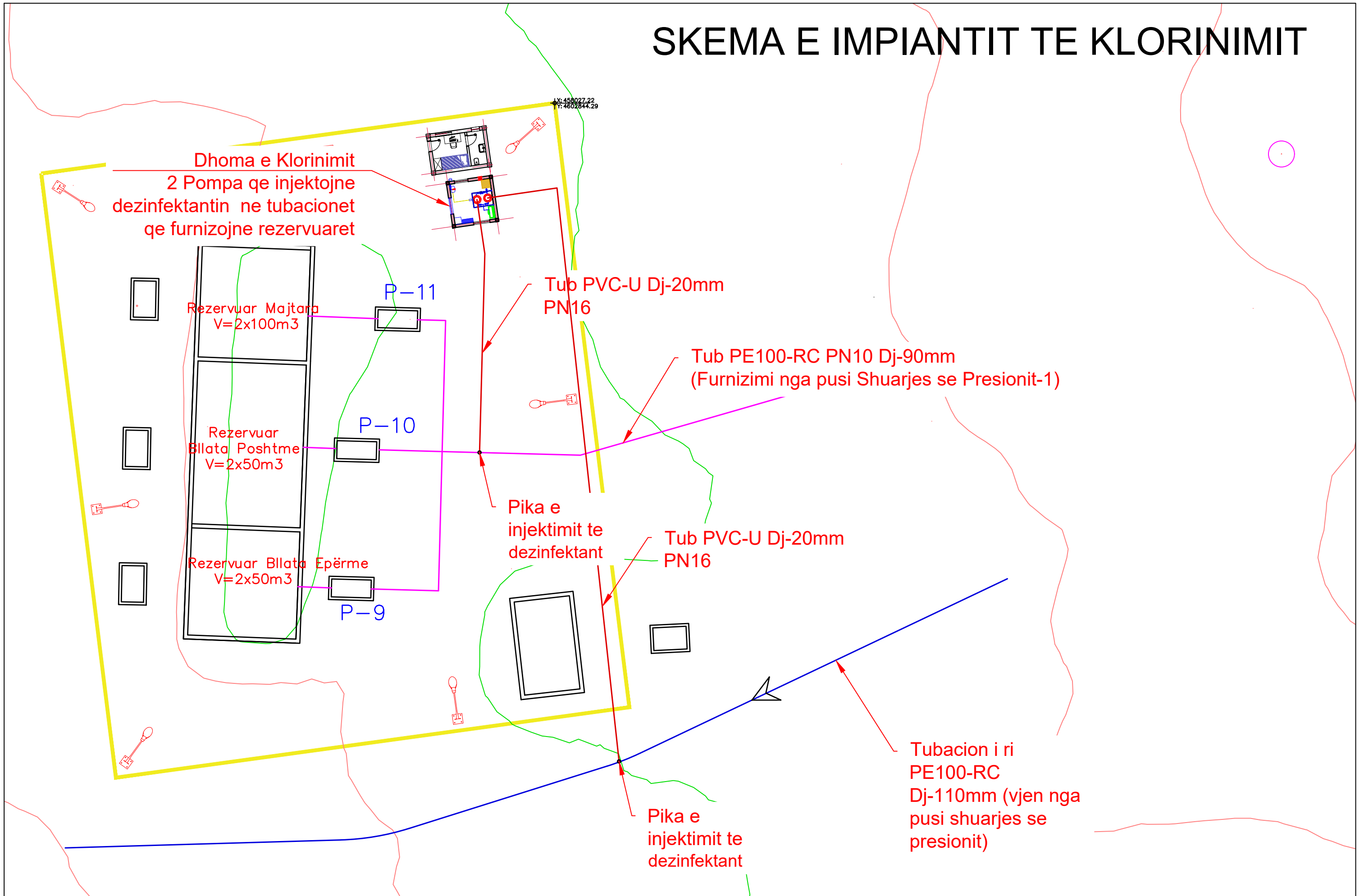

POROSITES:	SHOQERIA RAJONALE UJESJELLES KANALIZIME DIBER SH.A	"ERALD - G" SH.P.K	EMERTIMI	DREJTUES I PROJEKTIT	PROJEKTUES	SHKALLA	NR. I FLETES
OBJEKTI:	"NDERTIM I RRJETIT KRYESOR FURNIZIMI ME UJE I FSHATRAVE TE NJESISE ADMINISTRATIVE MAQELLARE, FAZA 2"	 RRUGA KONGRESI I LUSHNYES TIRANE.	REHABILITIM I REZERVUAREVE BLLATE & MAJTARE	INXH. GEZIM ISLAMI	INXH. GEZIM ISLAMI TOP. KUJTIM CANAMETI HIDR. ANISA ZAKA	INXH. ENDRI PIERO	6-24 FORMAT A3
						1:250 2024	

Seksioni Terthor

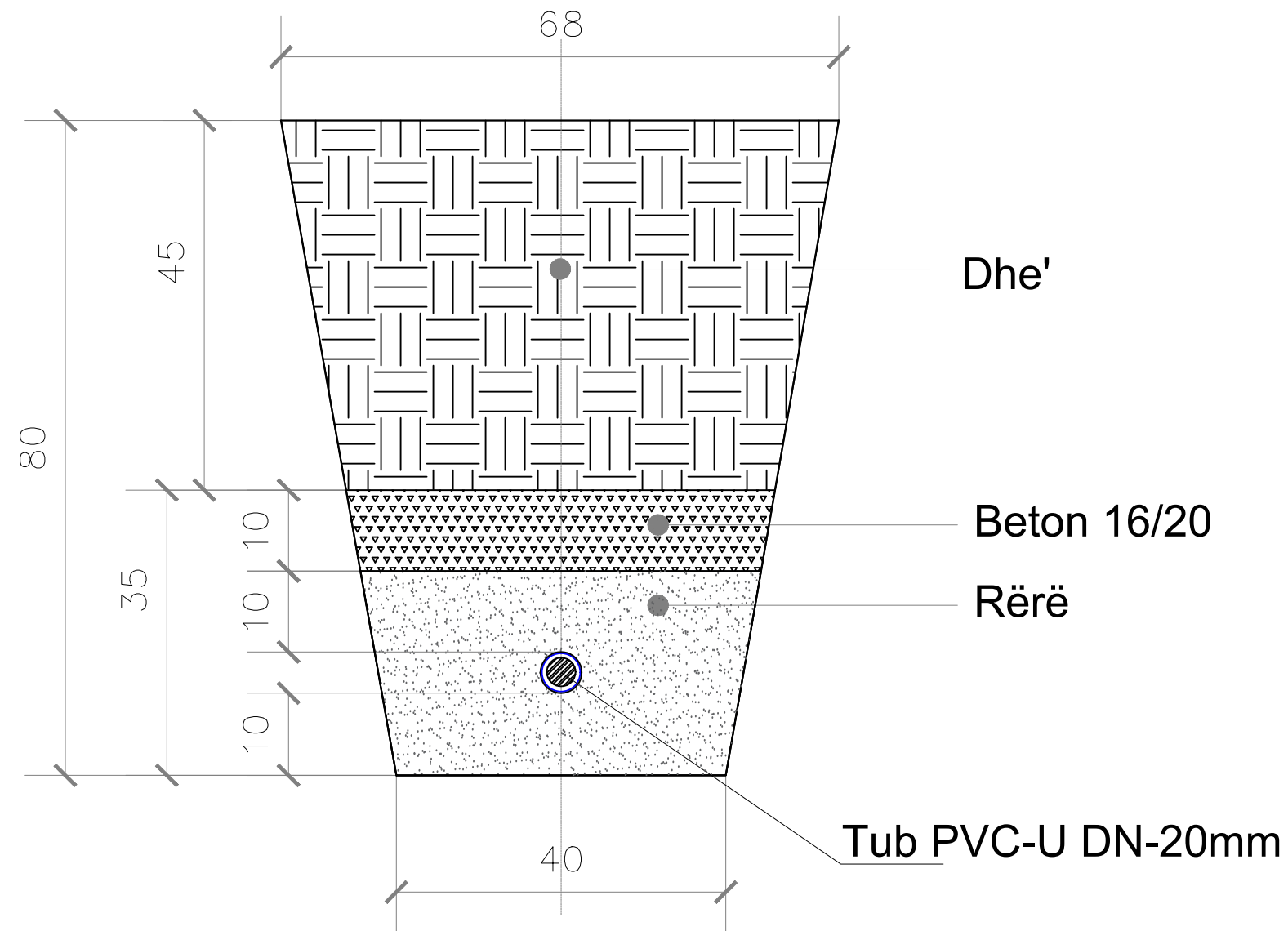

SHENIME: TUBI PVC-U DO VENDOSET NENTOKE MBULUAR ME NJE SHITRESE ME RERE DHE 10CM BETON DHE PJESA TJETER ME DHE' TE SHKRIFET. THELLESIA E VENDOSJES DO JETE -80CM

POROSITES:	SHOQERIA RAJONALE UJESJELLES KANALIZIME DIBER SH.A	"ERALD - G" SH.P.K	EMERTIMI	DREJTUES I PROJEKTIT	PROJEKTUES	SHKALLA	NR. I FLETES
OBJEKTI:	"NDERTIM I RRJETIT KRYESOR FURNIZIMI ME UJE I FSHATRAVE TE NJESISE ADMINISTRATIVE MAQELLARE, FAZA 2"	 RRUGA KONGRESI I LUSHNYES TIRANE.	REHABILITIM I REZERVUAREVE BLLATE & MAJTARE	INXH. GEZIM ISLAMI	INXH. GEZIM ISLAMI TOP. KUJTIM CANAMETI HIDR. ANISA ZAKA	INXH. ENDRI PIERO	6-25 FORMAT A3
						1:750 2024	

SKEMAT E PUSITES EKZISTUESE P12
(PUSETE SHPERNDARJE)

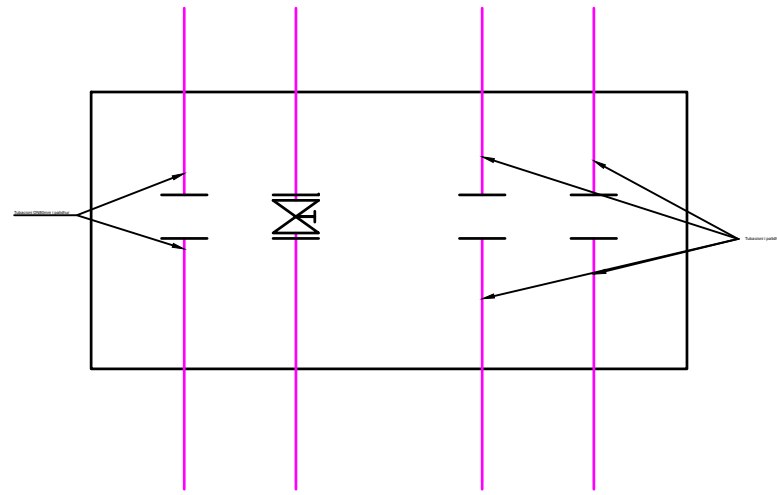

SKEMAT E PUSITES EKZISTUESE P12
PAS NDERHYRJES

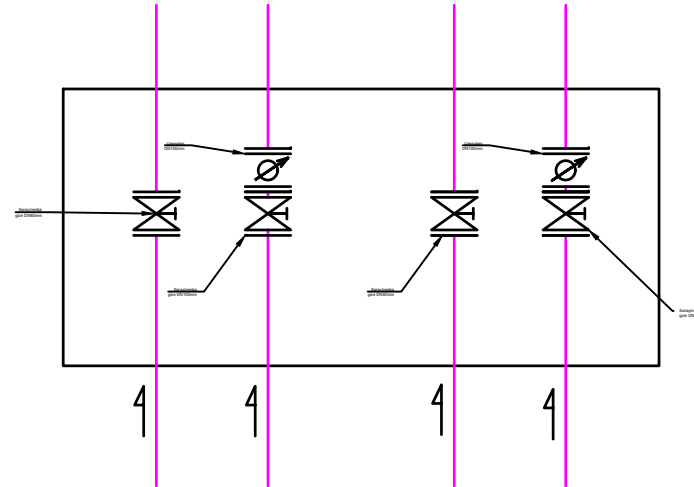

DETAJ PUSITAT P9-P10-P11

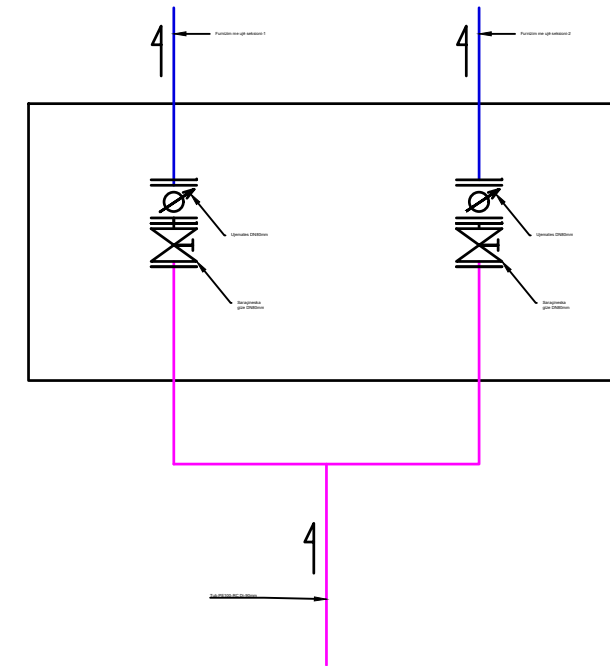

Shenim Teknik:Nderhyrjet e parashikuara puseta P12:

- Instalim saracineskave DN80mm, DN100mm
- Instalim ujematesave me flanaxha
- Vendosje kapakut te pusetes

Shenim Teknik: Sipas azhornit ne secilen prej pusetave mungojne rakorderite e nevojshme per shfrytezimin e ujesjellesit.Projekti parashikon instalimin e saracineskave dhe ujematesave sipas diametrave te tubacioneve.

Simbole Hidraulike

- Tubacion çeliku me flanaxhë
- Saraçineskë instaluar ne tubacion çeliku
- Ujemates me flanaxha

POROSITES:	SHOQERIA RAJONALE UJESJELLES KANALIZIME DIBER SH.A	"ERALD - G" SH.P.K	EMERTIMI	DREJTUES I PROJEKTIT	PROJEKTUES	SHKALLA	NR. I FLETES
OBJEKTI:	"NDERTIM I RRJETIT KRYESOR FURNIZIMI ME UJE I FSHATRAVE TE NJESISE ADMINISTRATIVE MAQELLARE, FAZA 2"	RRUGA KONGRESI I LUSHNYES TIRANE.	REHABILITIM I REZERVUAREVE BLLATE & MAJTARE	INXH. GEZIM ISLAMI	INXH. GEZIM ISLAMI TOP. KUJTIM CANAMETI HIDR. ANISA ZAKA	INXH. ENDRI PIERO	6-26
						1:25 2024	FORMAT A3

SKEMAT E PUSITES EKZISTUESE P13
(PUSETE SHPERNDARJE)

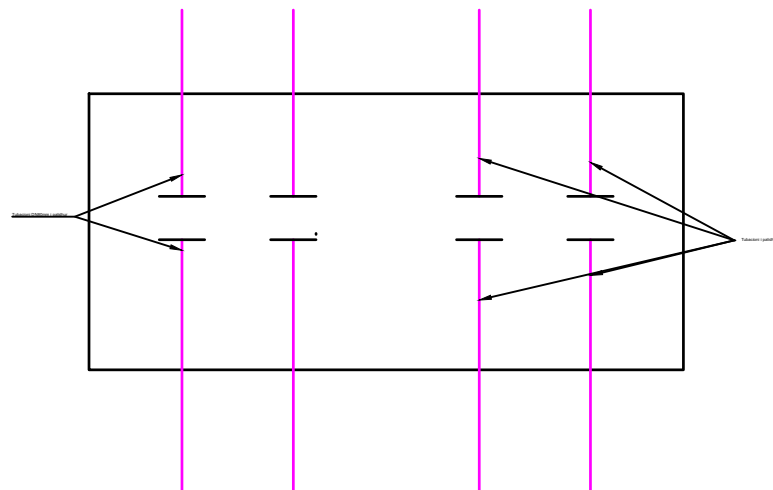



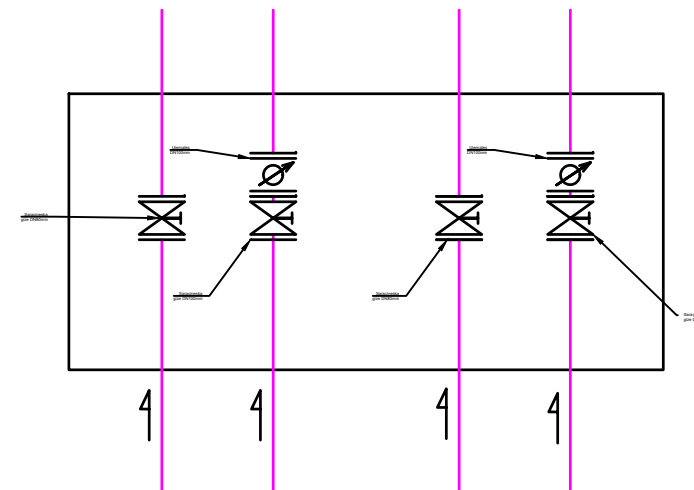

SKEMAT E PUSITES EKZISTUESE P13
PAS NDERHYRJES



Shenim Teknik:Nderhyrjet e parashikuara puseta P13:
 - Instalim saracineskave DN80mm, DN100mm
 -Instalim ujematesave me flanaxha
 -Vendosje kapakut te pusetes

Simbole Hidraulike

-  Tubacion çeliku me flanaxhë
-  Saraçineskë instaluar ne tubacion çeliku
-  Ujemates me flanaxha

POROSITES:	SHOQERIA RAJONALE UJESJELLES KANALIZIME DIBER SH.A	"ERALD - G" SH.P.K	EMERTIMI	DREJTUES I PROJEKTIT	PROJEKTUES	SHKALLA	NR. I FLETES
OBJEKTI:	"NDERTIM I RRJETIT KRYESOR FURNIZIMI ME UJE I FSHATRAVE TE NJESISE ADMINISTRATIVE MAQELLARE, FAZA 2"	 RRUGA KONGRESI I LUSHNYES TIRANE.	REHABILITIM I REZERVUAREVE BLLATE & MAJTARE	INXH. GEZIM ISLAMI	INXH. GEZIM ISLAMI TOP. KUJTIM CANAMETI HIDR. ANISA ZAKA	INXH. ENDRI PIERO	6-27
						1:25	FORMAT A3
						2024	

DETAJ PUSSETAT "A"

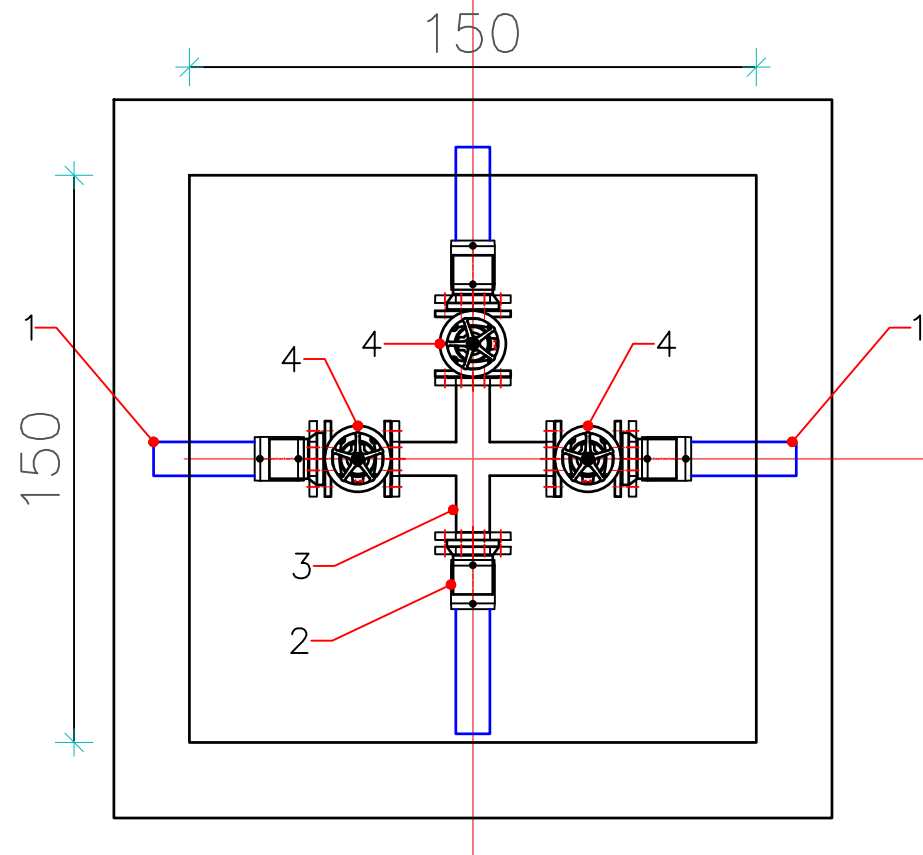

Baza Materiale		
Kodi	Emertimi	Sasia (copë)
1	Tub PE100-RC Dj-90mm	n/a
2	Adaptor Dj-90mm, Flanxhe adaptori Dj-90mm, Manikote E.F.Dj-90mm	4
3	Kryq çeliku DN80x80x80x80mm, s=2.9mm	4kg
4	Saraçineskë DN80mm PN16	3
5	Pusete 1.5x1.5x1.5m	1

POROSITES:	SHOQERIA RAJONALE UJESJELLES KANALIZIME DIBER SH.A	"ERALD - G" SH.P.K	EMERTIMI	DREJTUES I PROJEKTIT	PROJEKTUES	SHKALLA	NR. I FLETES
OBJEKTI:	"NDERTIM I RRJETIT KRYESOR FURNIZIMI ME UJE I FSHATRAVE TE NJESISE ADMINISTRATIVE MAQELLARE, FAZA 2"	 RRUGA KONGRESI I LUSHNYES TIRANE.	REHABILITIM I REZERVUAREVE BLLATE & MAJTARE	INXH. GEZIM ISLAMI	INXH. GEZIM ISLAMI TOP. KUJTIM CANAMETI HIDR. ANISA ZAKA	INXH. ENDRI PIERO	1:20 2024 6-28 FORMAT A3

SKEMAT E PUSITES EKZISTUESE P14
(PUSETE SHPERNDARJE)

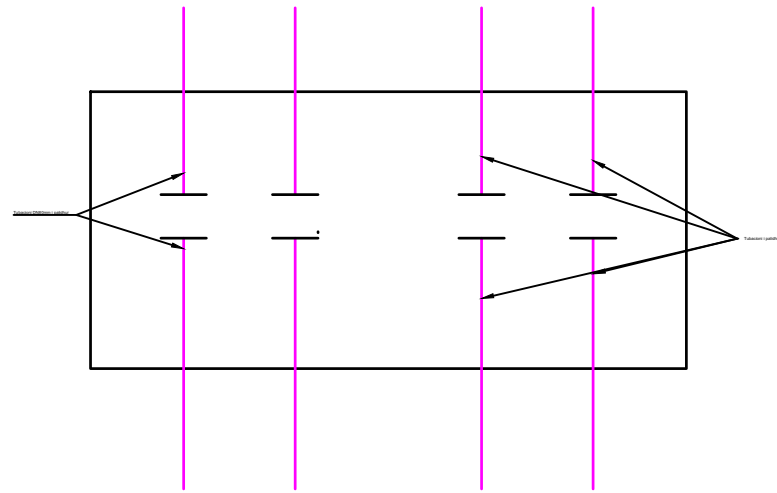



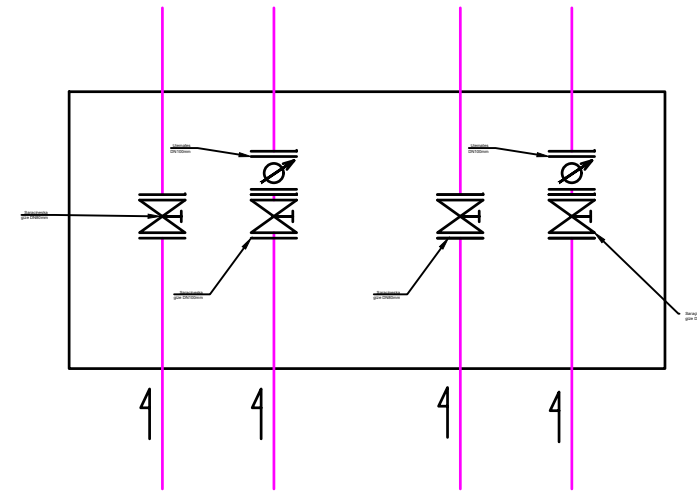

SKEMAT E PUSITES EKZISTUESE P14
PAS NDERHYRJES



Shenim Teknik: Nderhyrjet e parashikuara puseta P14:
 - Instalim saracineskave DN80mm, DN100mm
 - Instalim ujematesave me flanaxha
 - Vendosje kapakut te pusetes

Simbole Hidraulike

-  Tubacion çeliku me flanaxhë
-  Saraçineskë instaluar ne tubacion çeliku
-  Ujemates me flanaxha

POROSITES:	SHOQERIA RAJONALE UJESJELLES KANALIZIME DIBER SH.A	"ERALD - G" SH.P.K	EMERTIMI	DREJTUES I PROJEKTIT	PROJEKTUES	SHKALLA	NR. I FLETES
OBJEKTI:	"NDERTIM I RRJETIT KRYESOR FURNIZIMI ME UJE I FSHATRAVE TE NJESISE ADMINISTRATIVE MAQELLARE, FAZA 2"	 RRUGA KONGRESI I LUSHNYES TIRANE.	REHABILITIM I REZERVUAREVE BLLATE & MAJTARE	INXH. GEZIM ISLAMI	INXH. GEZIM ISLAMI TOP. KUJTIM CANAMETI HIDR. ANISA ZAKA	INXH. ENDRI PIERO	6-29
						1:25 2024	FORMAT A3

DETAIL INJEKTIMIT TE NaOCI

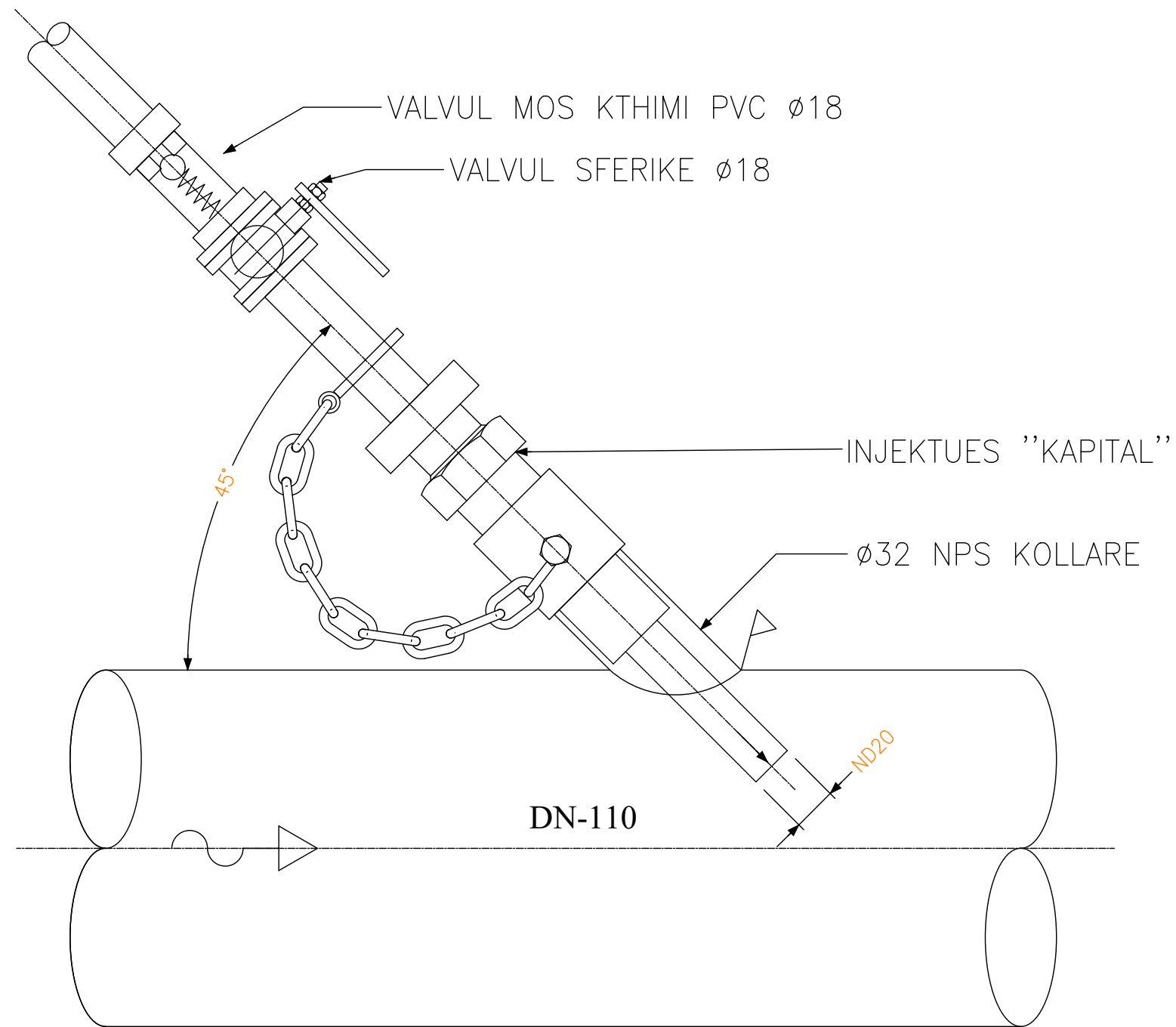

POROSITES:	SHOQERIA RAJONALE UJESJELLES KANALIZIME DIBER SH.A	"ERALD - G" SH.P.K	EMERTIMI	DREJTUES I PROJEKTIT	PROJEKTUES	SHKALLA	NR. I FLETES
OBJEKTI:	"NDERTIM I RRJETIT KRYESOR FURNIZIMI ME UJE I FSHATRAVE TE NJESISE ADMINISTRATIVE MAQELLARE, FAZA 2"	 RRUGA KONGRESI I LUSHNYES TIRANE.	REHABILITIM I REZERVUAREVE BLLATE & MAJTARE	INXH. GEZIM ISLAMI	INXH. GEZIM ISLAMI TOP. KUJTIM CANAMETI HIDR. ANISA ZAKA	INXH. ENDRI PIERO	6-30
						1:10 2024	FORMAT A3

**DETAJ INSTALIMIT TE TEPERPLOTESAVE
NE DY SEKSIONET E REZERVUARIT
Sh.1:50**

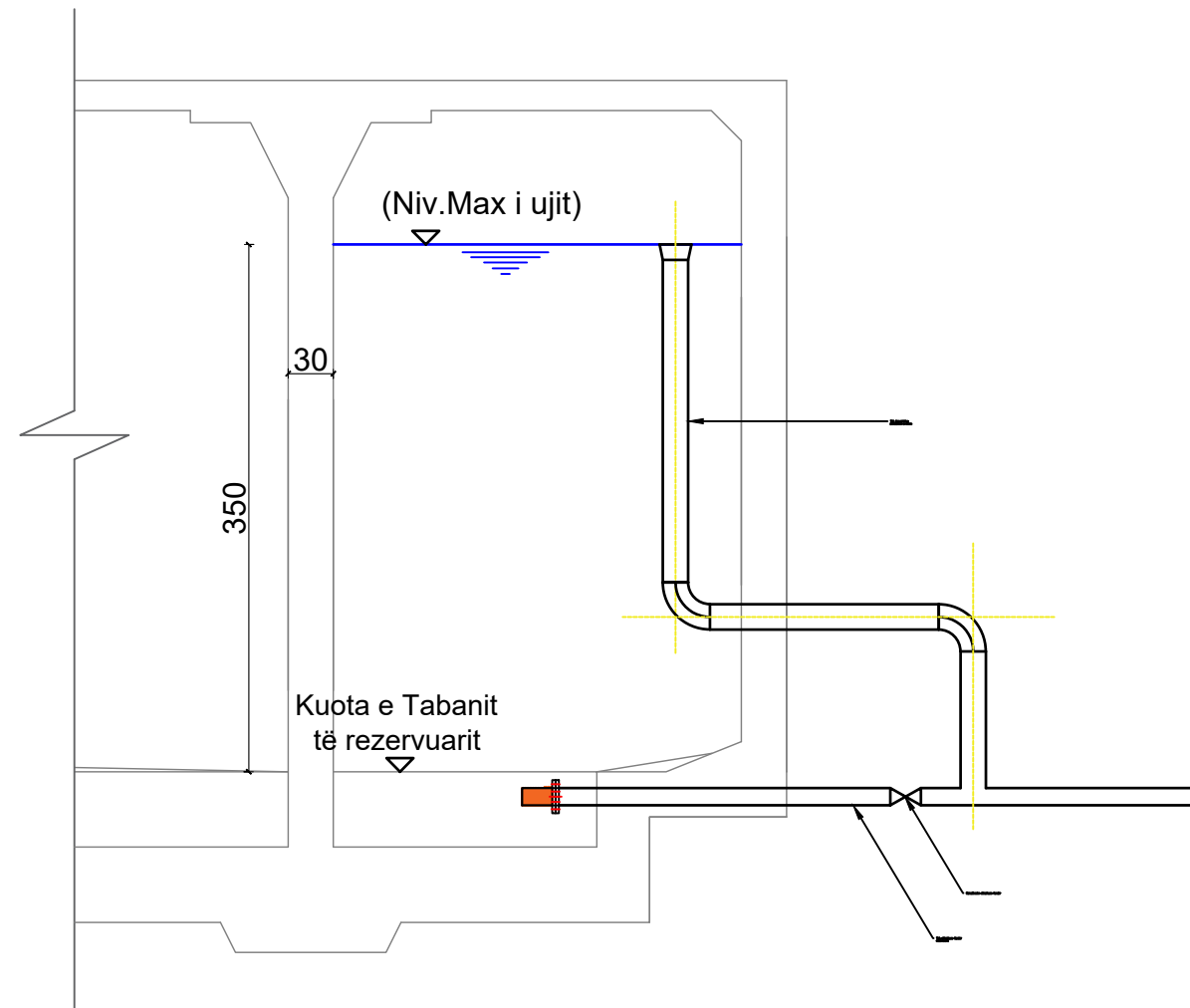



Shenime Teknike:

Ndertimi i Teperplotesave DN-100mm kanë per qellim shmangien e tejmbushjes se rezervuarit. Teperplotesit te ndertohen per te 3 rezervuaret, dhe te lidhen me shkarkuesit fundor te çdo seksioni.

POROSITES:	SHOQERIA RAJONALE UJESJELLES KANALIZIME DIBER SH.A	"ERALD - G" SH.P.K	EMERTIMI	DREJTUES I PROJEKTIT	PROJEKTUES	SHKALLA	NR. I FLETES
OBJEKTI:	"NDERTIM I RRJETIT KRYESOR FURNIZIMI ME UJE I FSHATRAVE TE NJESISE ADMINISTRATIVE MAQELLARE, FAZA 2"	 RRUGA KONGRESI I LUSHNYES TIRANE.	REHABILITIM I REZERVUAREVE BLLATE & MAJTARE	INXH. GEZIM ISLAMI	INXH. GEZIM ISLAMI TOP. KUJTIM CANAMETI HIDR. ANISA ZAKA	INXH. ENDRI PIERO	6-31
						1:50	FORMAT A3
						2024	

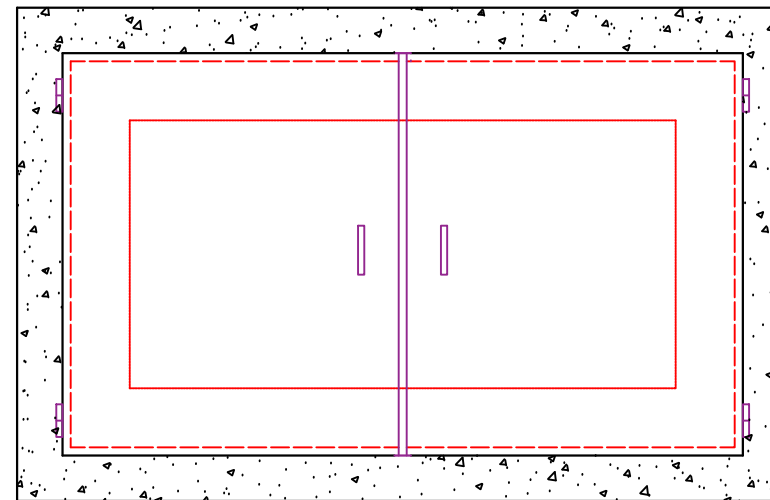
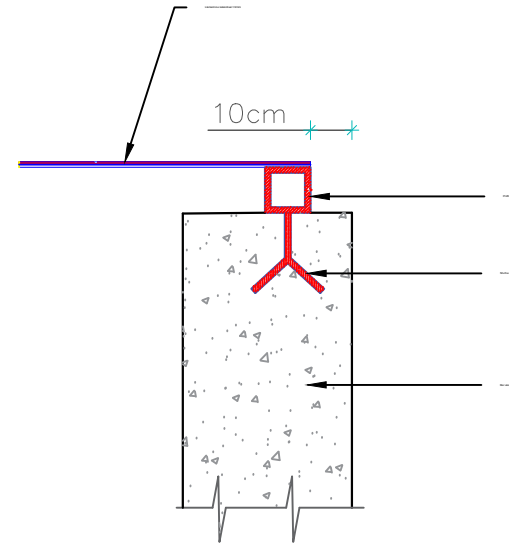
DETAJ I MBULIMIT TE KAPAKEVE PER CDO SEKSION TE REZERVUARIT



POROSITES:	SHOQERIA RAJONALE UJESJELLES KANALIZIME DIBER SH.A	"ERALD - G" SH.P.K	EMERTIMI	DREJTUES I PROJEKTTIT	PROJEKTUES	SHKALLA	NR. I FLETES	
OBJEKTI:	"NDERTIM I RRJETIT KRYESOR FURNIZIMI ME UJE I FSHATRAVE TE NJESISE ADMINISTRATIVE MAQELLARE, FAZA 2"	 <small>RRUGA KONGRESI I LUSHNYES TIRANE.</small>	REHABILITIM I REZERVUAREVE BLLATE & MAJTARE	INXH. GEZIM ISLAMI	INXH. GEZIM ISLAMI TOP. KUJTIM CANAMETI HIDR. ANISA ZAKA	INXH. ENDRI PIERO	1:40 2024	6-32 FORMAT A3

**DETAJ INSTALIMIT TE GALEXHANTEVE
NE DY SEKSIONET E REZERVUARIT**

Sh.1:50

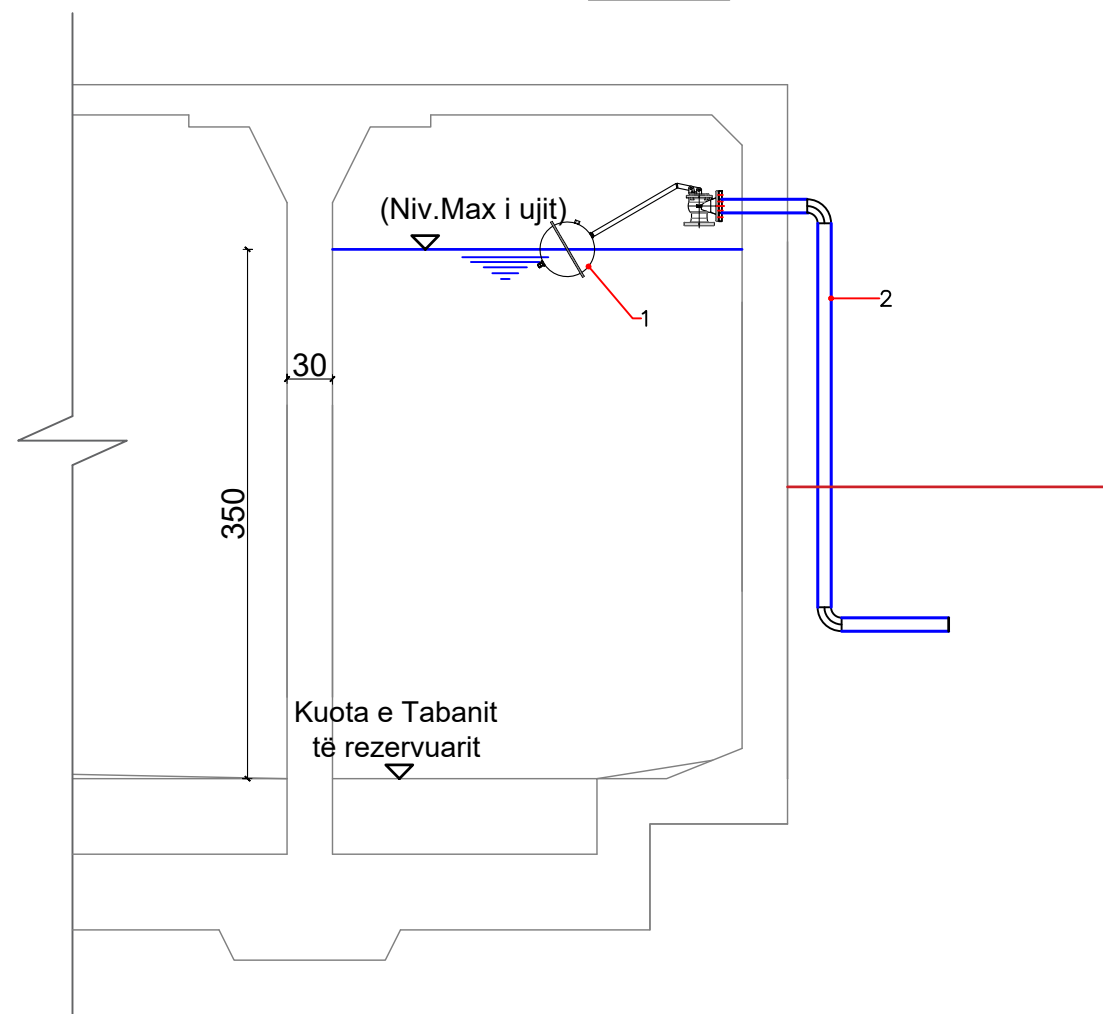



Baza Materiale		
Kodi	Emertimi	Sasia (copë)
1	Galenxhant me sferë DN80mm	6
2	Tub furnizim rezervuarit	n/a

Shenime Teknike:

Projekti parashikon instalimin e galexhanteve per cdo seksion te rezervuarit.
Diametri i projektuar per galenxhantin eshte specifikuar ne varesi te prurjes ne hyrje te rezervuarit

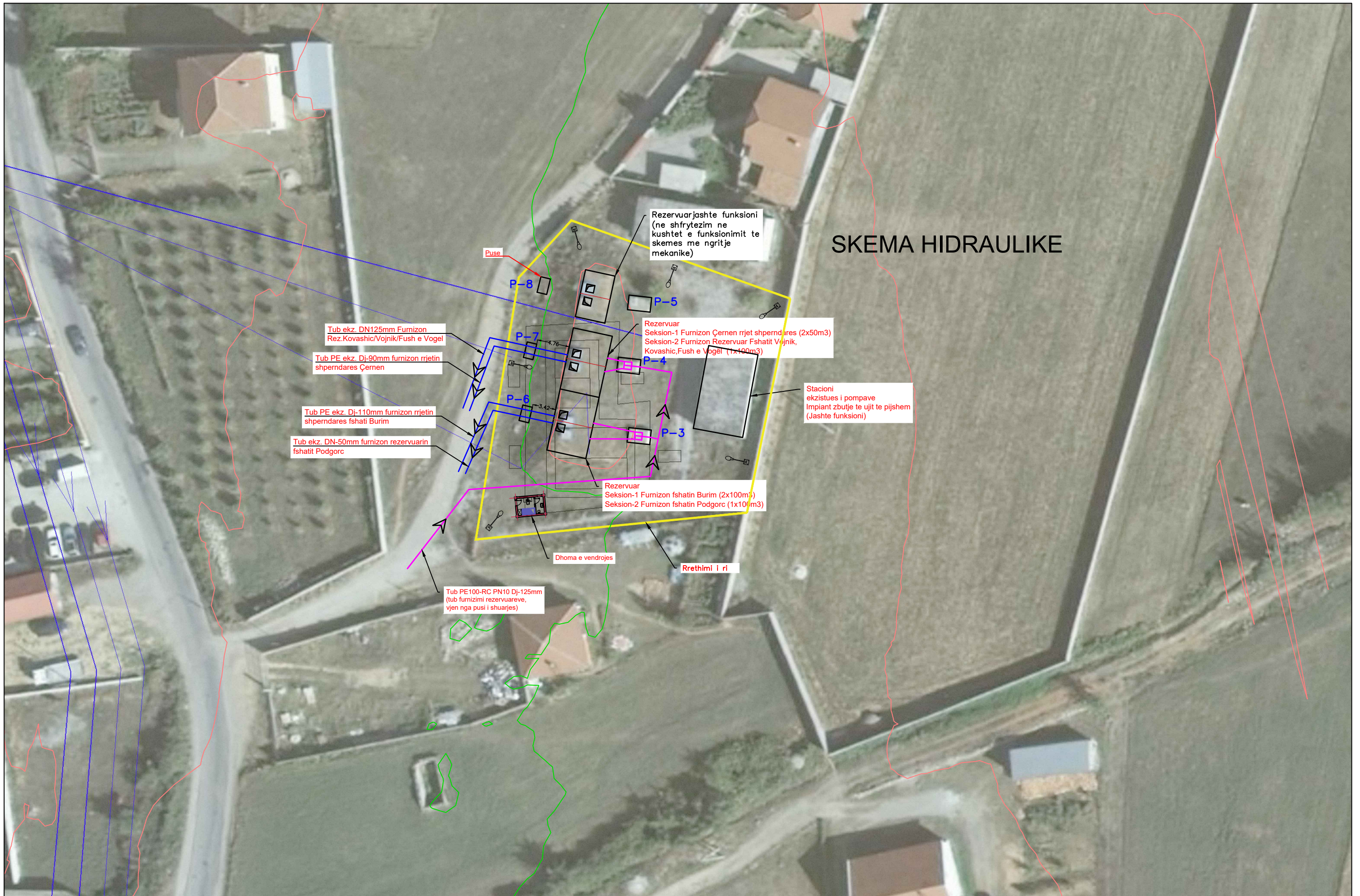
POROSITES:	SHOQERIA RAJONALE UJESJELLES KANALIZIME DIBER SH.A	"ERALD - G" SH.P.K	EMERTIMI	DREJTUES I PROJEKTIT	PROJEKTUES	SHKALLA	NR. I FLETES
OBJEKTI:	"NDERTIM I RRJETIT KRYESOR FURNIZIMI ME UJE I FSHATRAVE TE NJESISE ADMINISTRATIVE MAQELLARE, FAZA 2"	 RRUGA KONGRESI I LUSHNYES TIRANE.	REHABILITIM I REZERVUAREVE BLLATE & MAJTARE	INXH. GEZIM ISLAMI	INXH. GEZIM ISLAMI TOP. KUJTIM CANAMETI HIDR. ANISA ZAKA	INXH. ENDRI PIERO	1:50 2024 6-33 FORMAT A3



POROSITES:	SHOQERIA RAJONALE UJESJELLES KANALIZIME DIBER SH.A	"ERALD - G" SH.P.K	EMERTIMI	DREJTUES I PROJEKTIT	PROJEKTUES	SHKALLA	NR. I FLETES
OBJEKTI:	"NDERTIM I RRJETIT KRYESOR FURNIZIMI ME UJE I FSHATRAVE TE NJESISE ADMINISTRATIVE MAQELLARE, FAZA 2"	 RRUGA KONGRESI I LUSHNYES TIRANE.	REHABILITIM I REZERVUAREVE TE STACIONI I POMPAVE	INXH. GEZIM ISLAMI	INXH. GEZIM ISLAMI TOP. KUJTIM CANAMETI HIDR. ANISA ZAKA	INXH. ENDRI PIERO 1:500 2024	6-34 FORMAT A3

SKEMA E NDRICIMIT

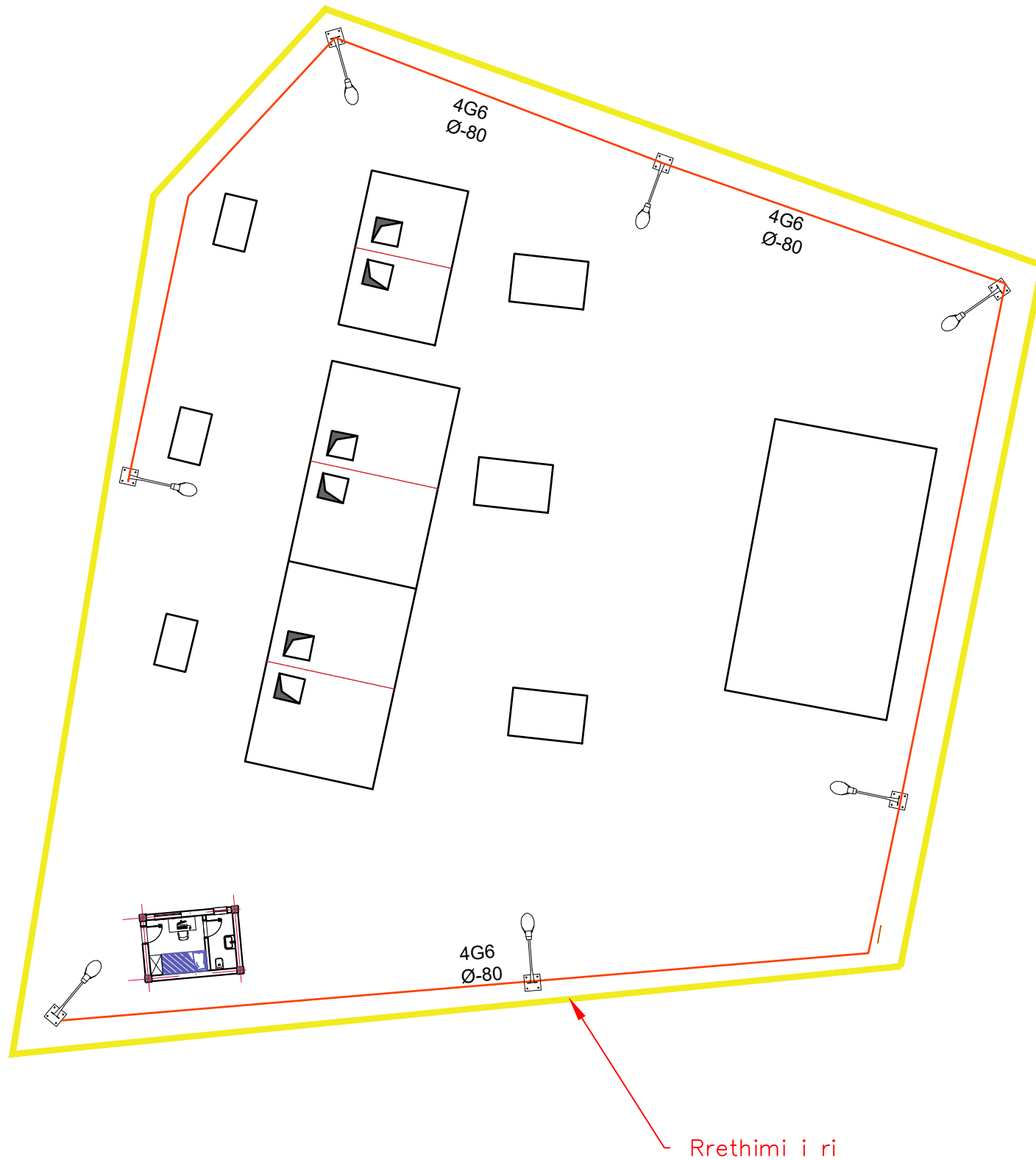

VENDOJA E KABLLIT TE FURNIZIMIT NEN TOKE

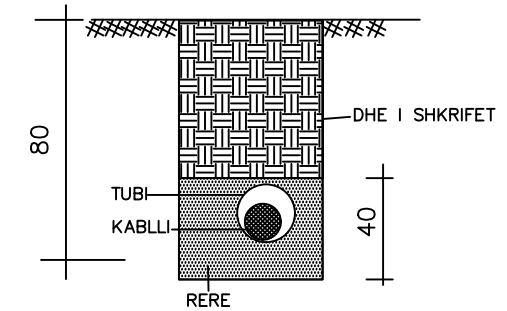

SHENIME .KABLLI DO VENDOSSET NENTOKE NE TUB KAVIDOTO TE GOMUAR MBULUAR ME NJE SHITRESE 40CM ME RERE DHE PJESA TJETER ME DHE TE SHKRIFET,ME NJE THELLESI TOTALE 80CM.

SHENIME

Ndricuesit rrugor do jene me shtylla konike te zinkuara me l-9ml me koke ndricuesi led me drite natyrale me fuqi 250-300W.
Per sistemimin e komandimit te ndricuesave do perdoret kuader komandimi kompletuar me automate dhe fotoelement drite.

POROSITES:	SHOQERIA RAJONALE UJESJELLES KANALIZIME DIBER SH.A	"ERALD - G" SH.P.K	EMERTIMI	DREJTUES I PROJEKTIT	PROJEKTUES	SHKALLA	NR. I FLETES
OBJEKTI:	"NDERTIM I RRJETIT KRYESOR FURNIZIMI ME UJE I FSHATRAVE TE NJESISE ADMINISTRATIVE MAQELLARE, FAZA 2"	 RRUGA KONGRESI I LUSHNYES TIRANE.	REHABILITIM I REZERVUAREVE TE STACIONI I POMPAVE	INXH. GEZIM ISLAMI	INXH. GEZIM ISLAMI TOP. KUJTIM CANAMETI HIDR. ANISA ZAKA	INXH. ENDRI PIERO	6-35
						1:250	FORMAT A3
						2024	

DETAJ I MBULIMIT TE KAPAKEVE PER CDO SEKSION TE REZERVUARIT

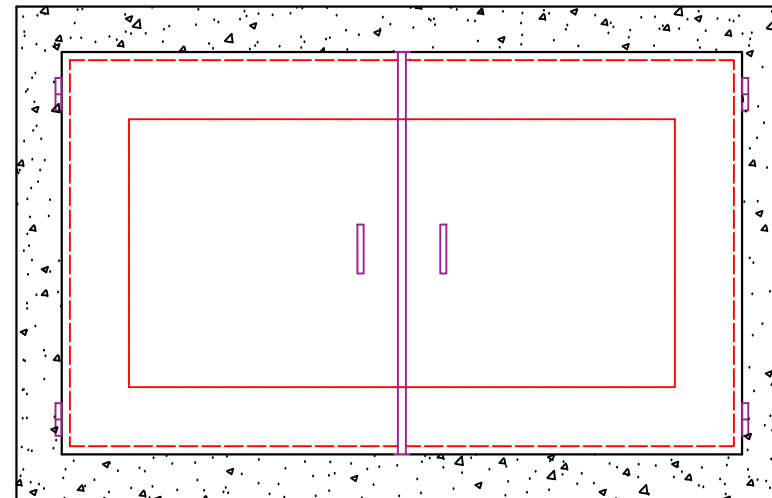
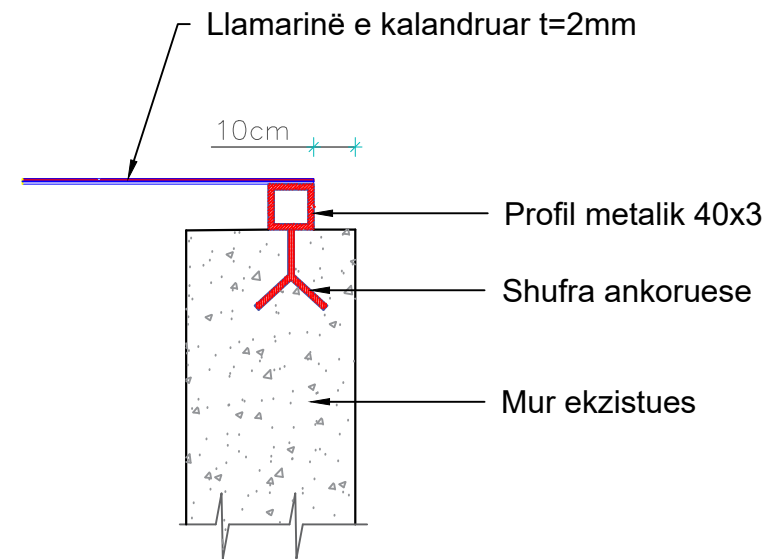

POROSITES:	SHOQERIA RAJONALE UJESJELLES KANALIZIME DIBER SH.A	"ERALD - G" SH.P.K	EMERTIMI	DREJTUES I PROJEKTIT	PROJEKTUES	SHKALLA	NR. I FLETES
OBJEKTI:	"NDERTIM I RRJETIT KRYESOR FURNIZIMI ME UJE I FSHATRAVE TE NJESISE ADMINISTRATIVE MAQELLARE, FAZA 2"	 RRUGA KONGRESI I LUSHNJES TIRANE.	REHABILITIM I REZERVUAREVE TE STACIONI I POMPAVE	INXH. GEZIM ISLAMI	INXH. GEZIM ISLAMI TOP. KUJTIM CANAMETI HIDR. ANISA ZAKA	INXH. ENDRI PIERO	6-36
						1:40	FORMAT A3
						2024	

**DETAJ INSTALIMIT TE TEPERPLOTESAVE
NE DY SEKSIONET E REZERVUARIT**

Sh.1:50

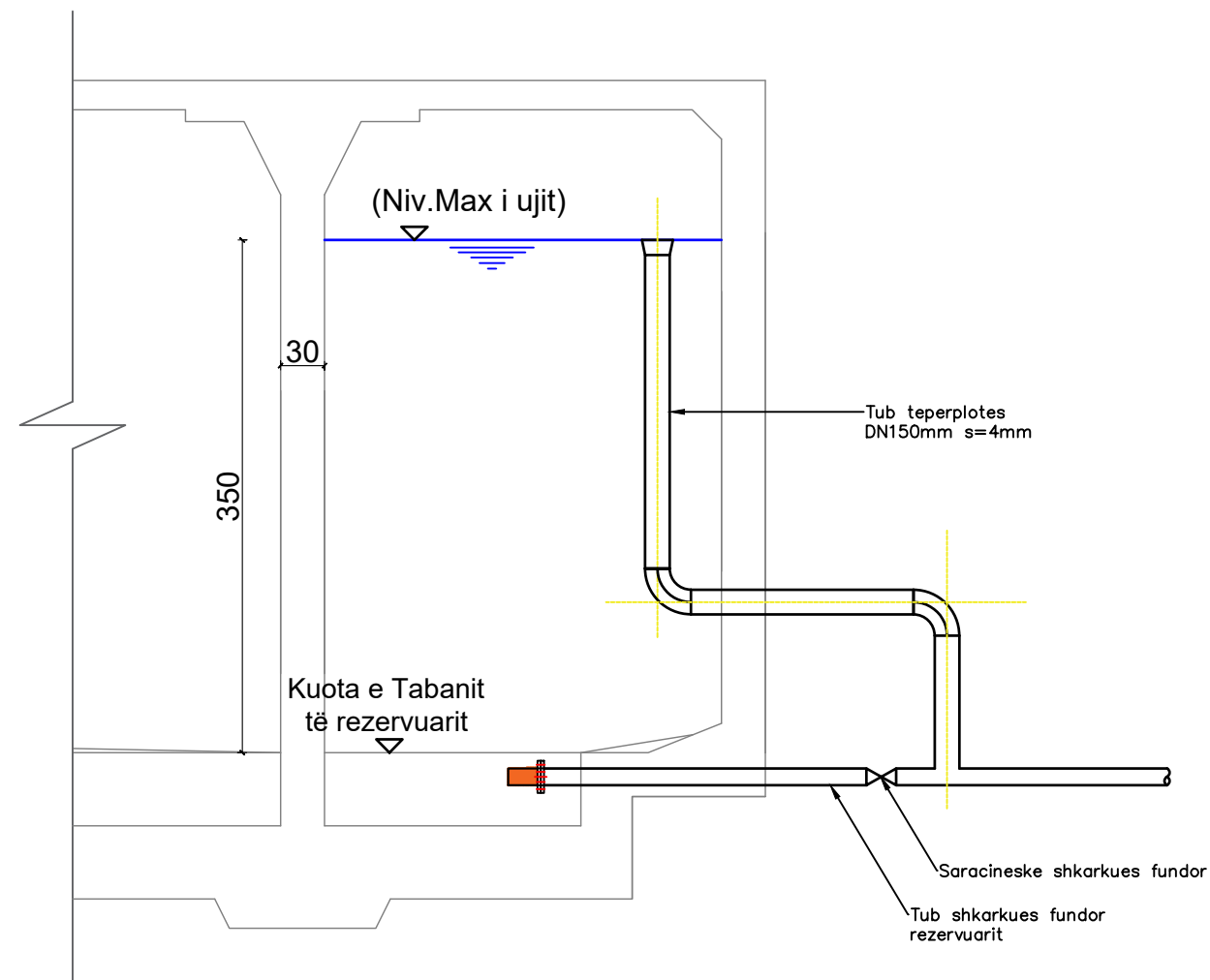

Shenime Teknike:

Ndertimi i Teperplotesave DN-150mm kanë për qëllim shmangien e tejmbushjes së rezervuarit. Teperplotesit të ndërtohen për të 2 rezervualet, dhe të lidhen me shkarkuesit fundor të çdo seksioni.

POROSITES:	SHOQERIA RAJONALE UJESJELLES KANALIZIME DIBER SH.A	"ERALD - G" SH.P.K	EMERTIMI	DREJTUES I PROJEKTIT	PROJEKTUES	SHKALLA	NR. I FLETES
OBJEKTI:	"NDERTIM I RRJETIT KRYESOR FURNIZIMI ME UJE I FSHATRAVE TE NJESISE ADMINISTRATIVE MAQELLARE, FAZA 2"	 RRUGA KONGRESI I LUSHNYES TIRANE.	REHABILITIM I REZERVUAREVE TE STACIONI I POMPAVE	INXH. GEZIM ISLAMI	INXH. GEZIM ISLAMI TOP. KUJTIM CANAMETI HIDR. ANISA ZAKA	INXH. ENDRI PIERO	6-37
						1:50	FORMAT A3
						2024	

**DETAJ INSTALIMIT TE GALEXHANTEVE
NE DY SEKSIONET E REZERVUARIT
Sh.1:50**

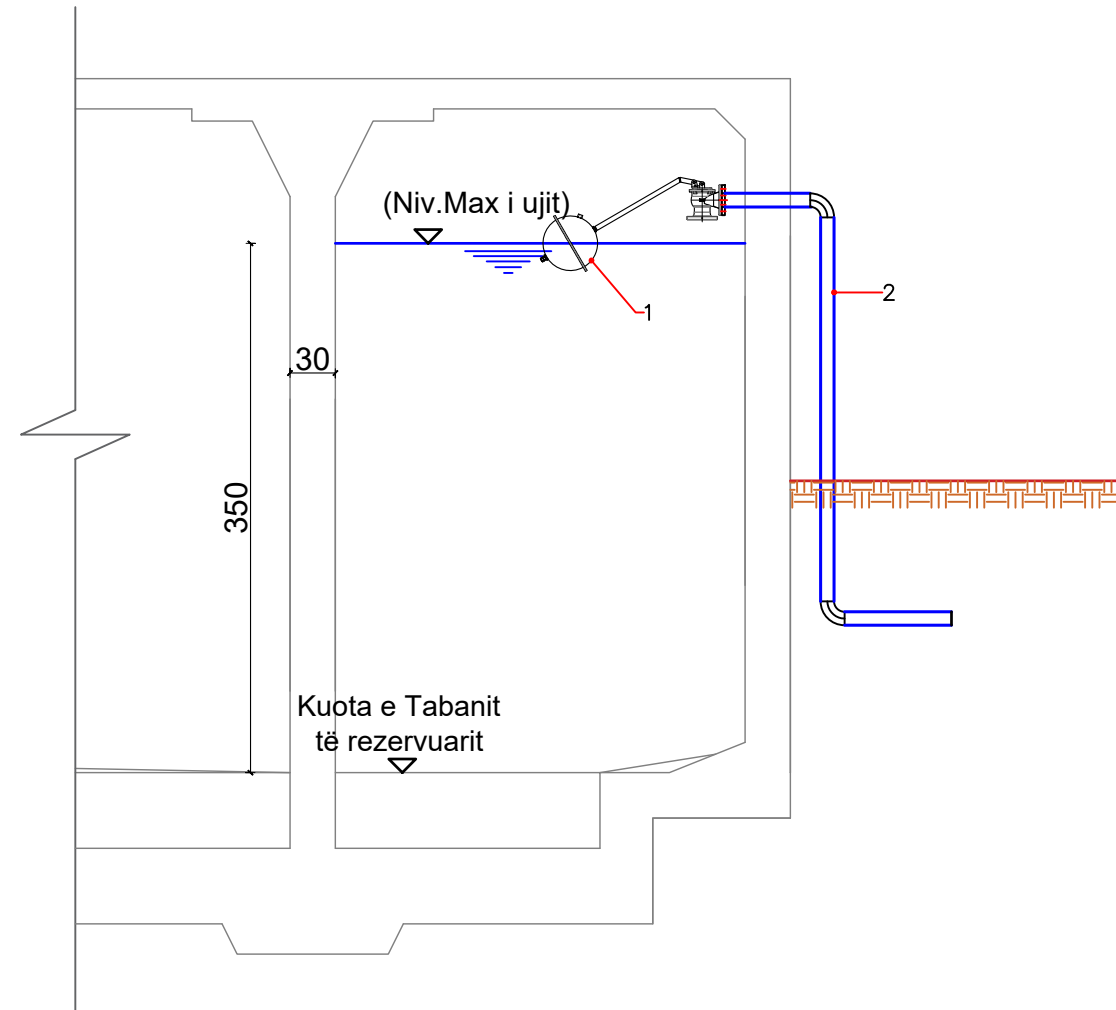

Baza Materiale		
Kodi	Emertimi	Sasia (copë)
1	Galenxhant me sferë DN80mm	4
2	Tub furnizim rezervuari	n/a

Shenime Teknike:

Projekti parashikon instalimin e galexhanteve per cdo seksion te rezervuarit. Diametri i projektuar per galenxhantin eshte specifikuar ne varesi te prurjes ne hyrje te rezervuarit

POROSITES:	SHOQERIA RAJONALE UJESJELLES KANALIZIME DIBER SH.A	"ERALD - G" SH.P.K	EMERTIMI	DREJTUES I PROJEKTIT	PROJEKTUES	SHKALLA	NR. I FLETES
OBJEKTI:	"NDERTIM I RRJETIT KRYESOR FURNIZIMI ME UJE I FSHATRAVE TE NJESISE ADMINISTRATIVE MAQELLARE, FAZA 2"	 RRUGA KONGRESI I LUSHNYES TIRANE.	REHABILITIM I REZERVUAREVE TE STACIONI I POMPAVE	INXH. GEZIM ISLAMI	INXH. GEZIM ISLAMI TOP. KUJTIM CANAMETI HIDR. ANISA ZAKA	INXH. ENDRI PIERO	6-38
						1:50 2024	FORMAT A3

SKEMA E PUSITES EKZISTUESE P3,P4
(E PERFUNDUAR)

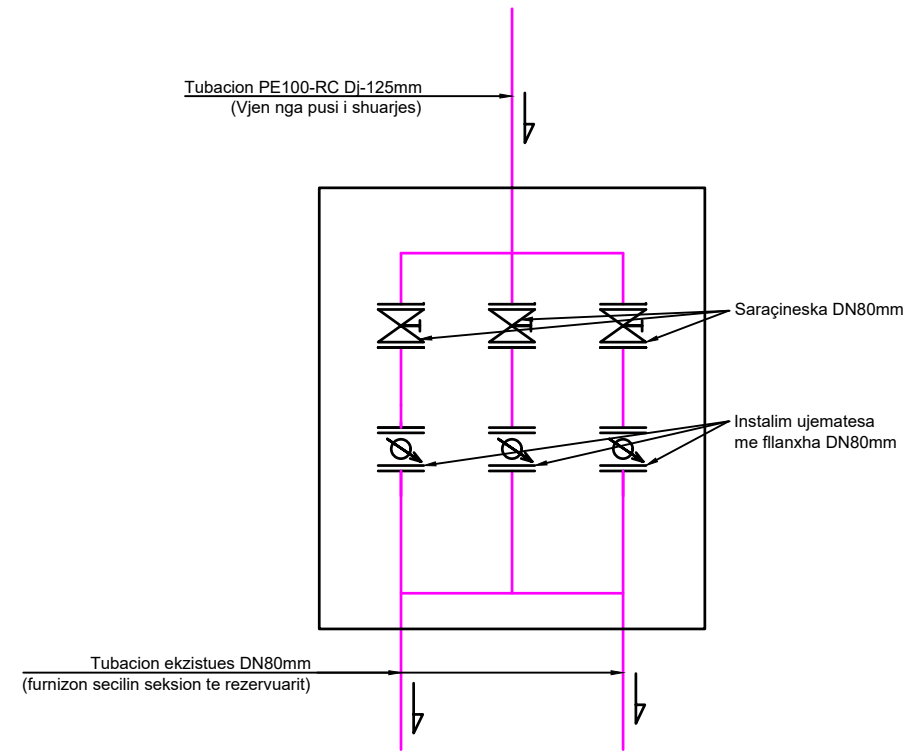

Simbole Hidraulike

- Tubacion çeliku me flanaxhë
- Saraçineskë instaluar ne tubacion çeliku
- Ujemates me flanaxha

Shenim Teknik:Nderhyrjet e parashikuara puseta P3,P4:

- Instalim saracineskave DN80mm
- Instalim ujematesave me flanaxha DN80mm
- Vendosje kapakut te pusetes

SKEMAT E PUSITES EKZISTUESE P6,P7
PAS NDERHYRJES

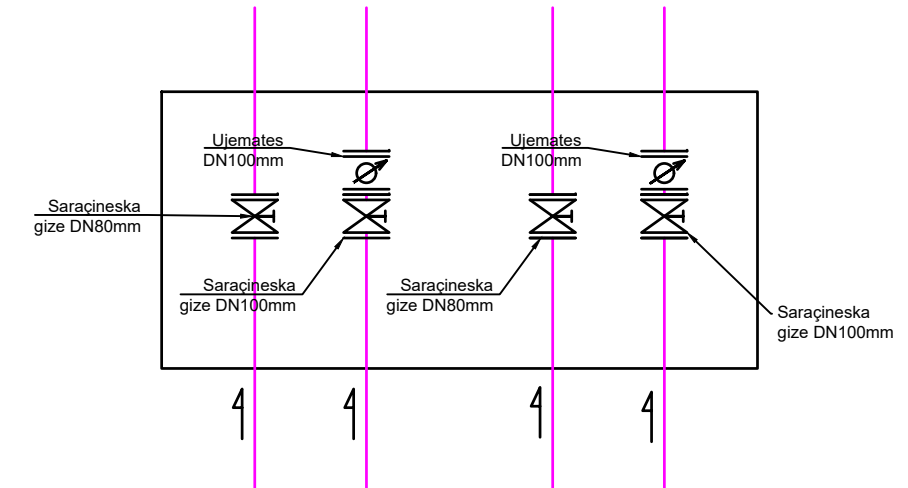

Shenim Teknik:Nderhyrjet e parashikuara puseta P13:

- Instalim saracineskave DN80mm, DN100mm
- Instalim ujematesave me flanaxha
- Vendosje kapakut te pusetes

Simbole Hidraulike

- Tubacion çeliku me flanaxhë
- Saraçineskë instaluar ne tubacion çeliku
- Ujemates me flanaxha

POROSITES:	SHOQERIA RAJONALE UJESJELLES KANALIZIME DIBER SH.A	"ERALD - G" SH.P.K	EMERTIMI	DREJTUES I PROJEKTIT	PROJEKTUES	SHKALLA	NR. I FLETES
OBJEKTI:	"NDERTIM I RRJETIT KRYESOR FURNIZIMI ME UJE I FSHATRAVE TE NJESISE ADMINISTRATIVE MAQELLARE, FAZA 2"	RRUGA KONGRESI I LUSHNYES TIRANE.	REHABILITIM I REZERVUAREVE TE STACIONI I POMPAVE	INXH. GEZIM ISLAMI	INXH. GEZIM ISLAMI TOP. KUJTIM CANAMETI HIDR. ANISA ZAKA	INXH. ENDRI PIERO	6-39
						1:25	FORMAT A3
						2024	