

"RIKONSTRUKSION I UJËSJELLËSIT FSHATI KAFARAJ,ÇERVEN,ADE",
Sha.UJËSJELLËS KANALIZIME FIER

7-PROJEKTI I KONSTRUKSIONIT TË PUSSETAVE 1x1x1.5m

Vepra:"Rikonstruksion i ujësjellësit Fshati Kafaraj, Çerven, Ade" , Qarku Fier - Rivlerësim	Projektues "Rean 95" shpk Tiranë Nr.Liçencës 1865/17 dt.27.04.2023		Projekt Zbatim
	Grupi Projektimit		Firma
Emërtimi: Projekti i Konstruksionit të Pusetave 1x1x1.5m	Projektues Projektues Perpunues Topograf	Ing.Razlje NAIPI Ing.Naim BAÇI Ing.Teuta DAXHA Ing.Elsa MONKA	
Porositësi:Sh.a Ujësjetllës Kanalizime Fier	Shkurt 2024	Gjithsej flete 2	Flete 1-2

"RIKONSTRUKSION I UJESJELLESIT FSHATI KAFARAJ, ÇERVEN, ADE", QARKU FIER
PANIMETRI E PRERJE TE PUSITES 1x1x1.5m

Planimetria shk 1:20

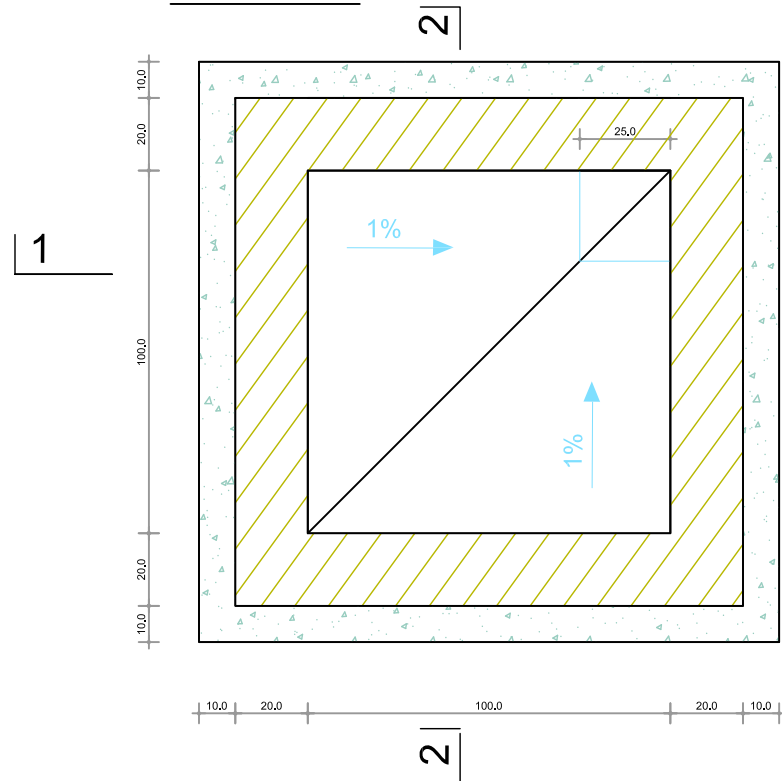

Planimetria shk 1:20
Pamja nga Lart

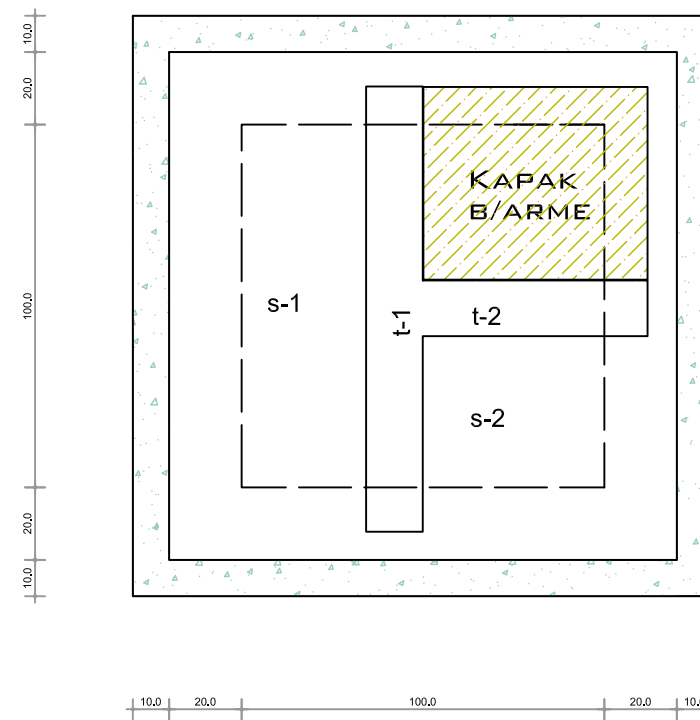

Kapak gize

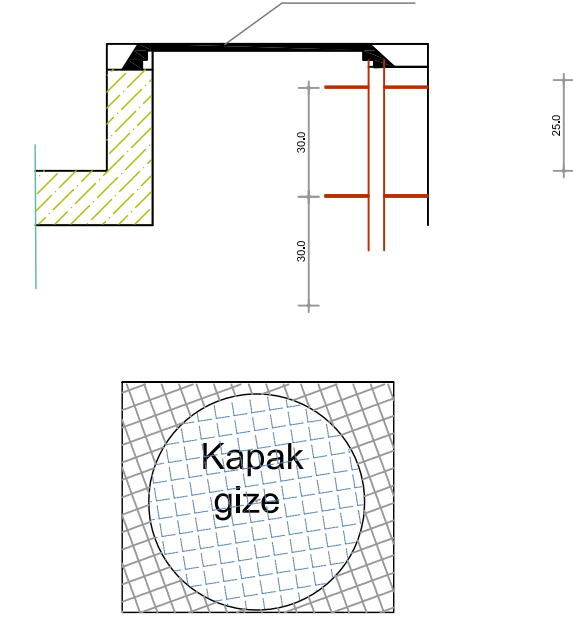

Prerja 1-1 shk 1:20

Kapak b/a

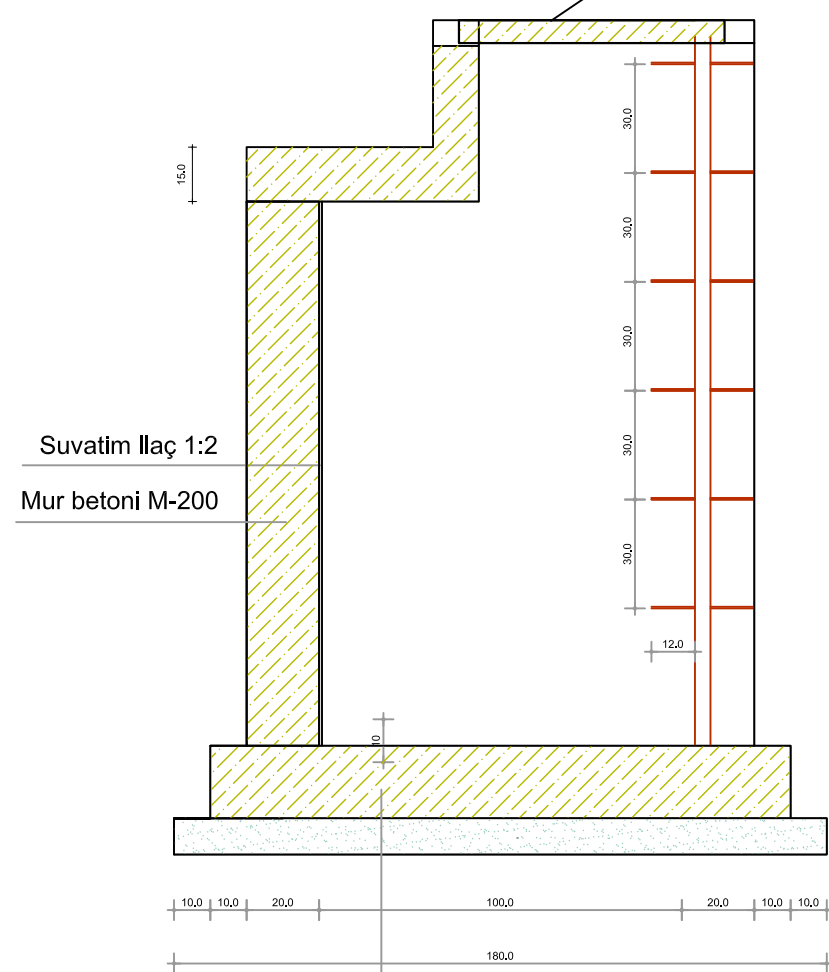

Prerja 2-2 shk 1:20

Kapak b/arme

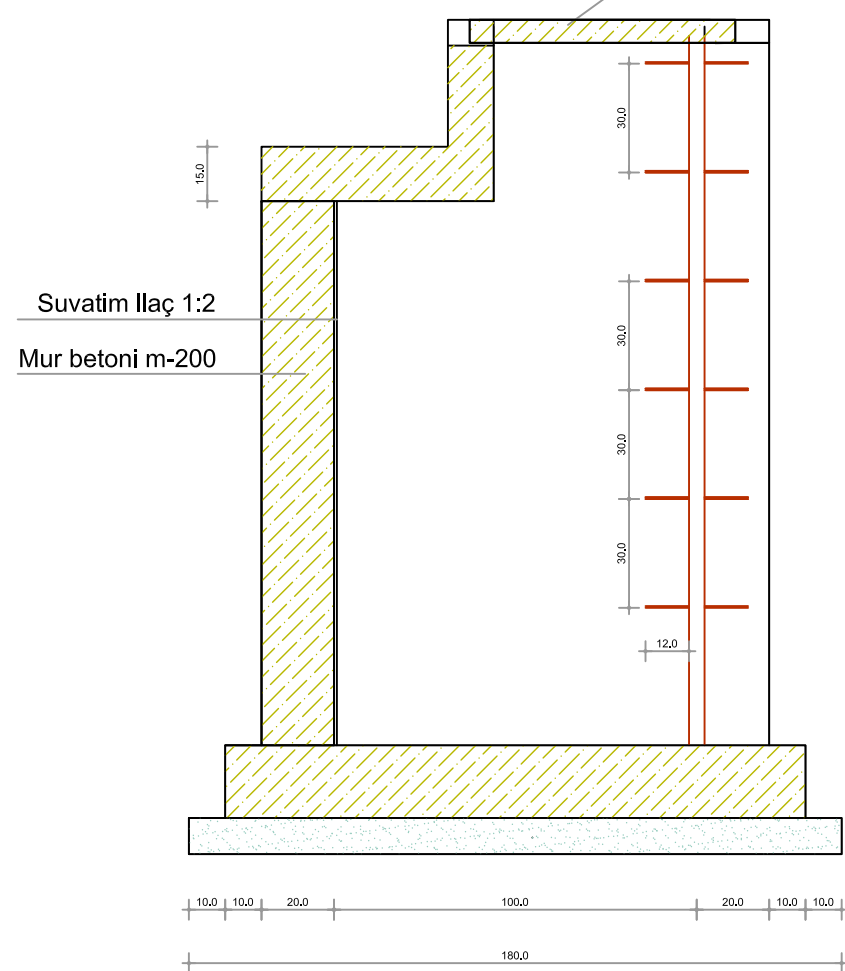

Kapak betoni

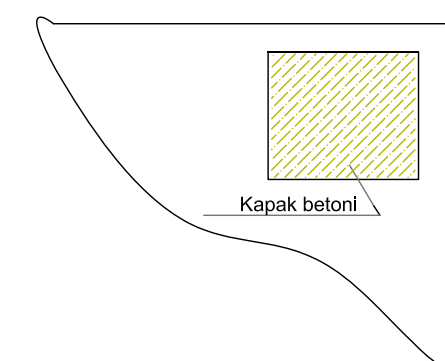

Ganxhe ne beton

Kapak gize

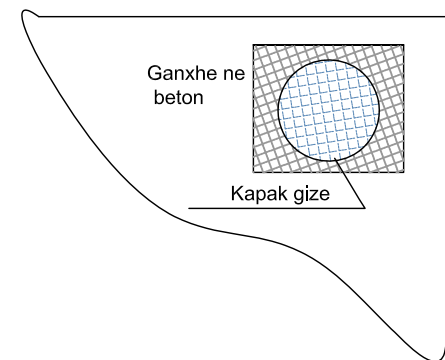

Beton M-200 20cm
Shtrese zhavorri 10 cm

"RIKONSTRUKSION I UJESJELLESIT FSHATI KAFARAJ, ÇERVEN, ADE", QARKU FIER
ARMIMI I PUSITES TE MANOVRIMIT 1 x 1 x 1.5m

Trau t-1

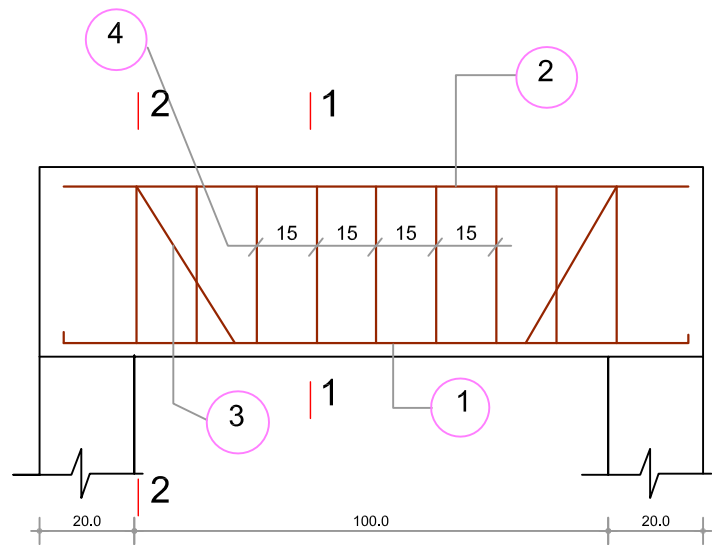

Trau t-2

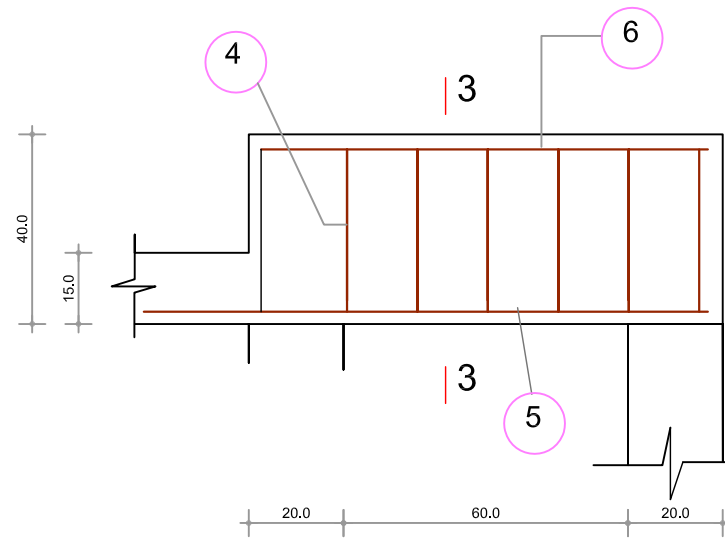

Soleta s-1

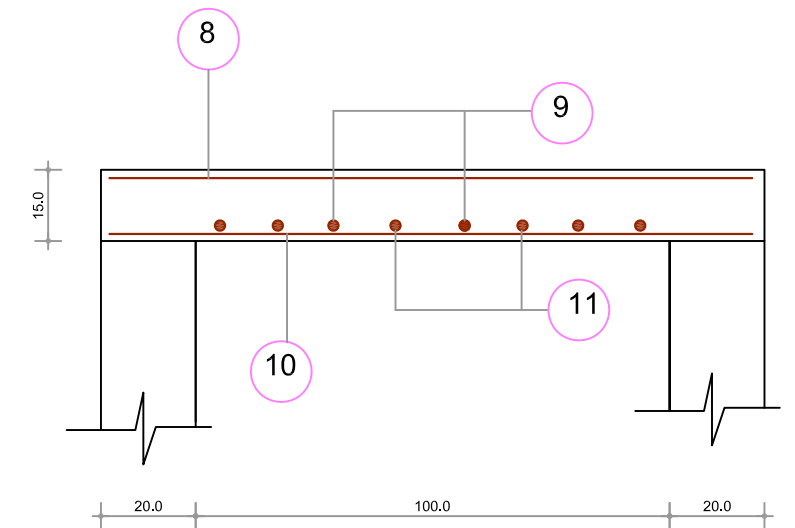

Prerja 1-1

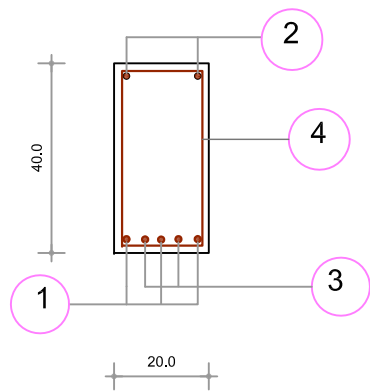

Prerja 2-2

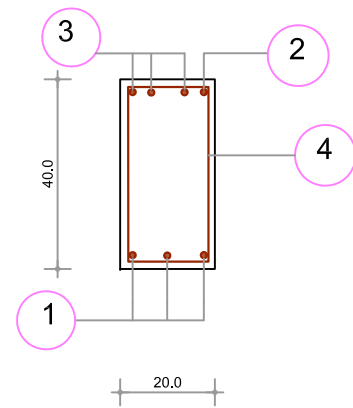

Prerja 3-3

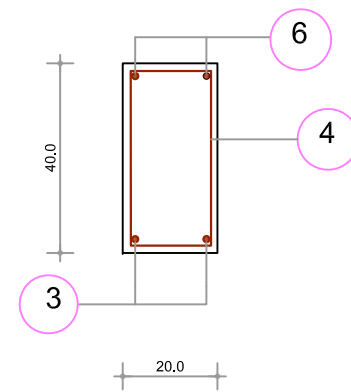

Soleta s-2

