

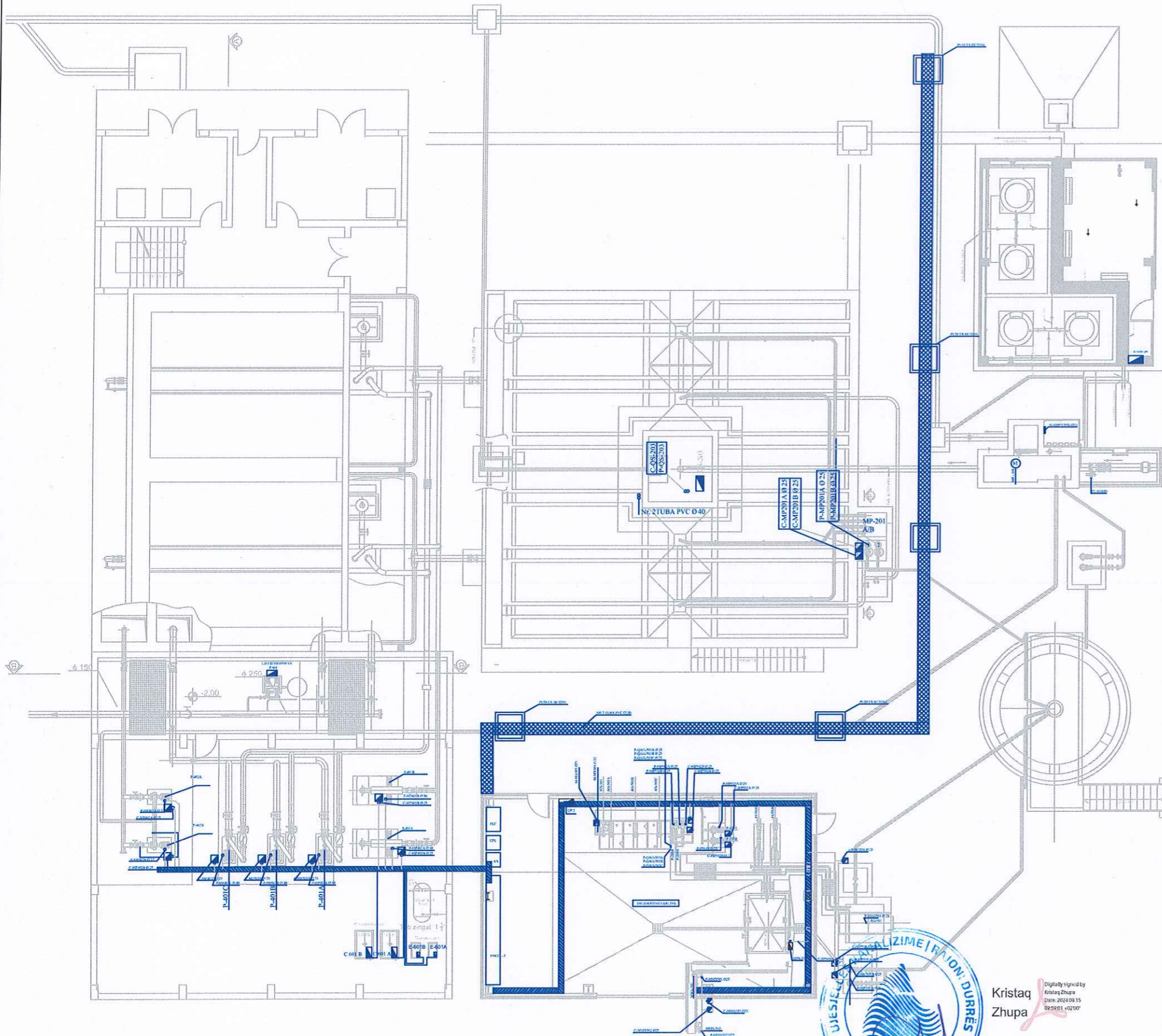

INSTALIMI ELEKTRIK

LEGJENDA

-  KUADER TENSIONI TE ULET
-  PULSATOR KOMANDIMI
-  PASARELE E KABULLIT ELEKTRIK
-  KABINA E ANALIZAVE
-  ANALIZATOR
-  TREGUES NIVELI
-  KASETA E LIDHJEVE
-  KABULLAT NEN TOKESORE
-  Puset BETONI PER ELEKTRIKE















Kristaq Zhupa
Digitally signed by Kristaq Zhupa
Date: 2024.08.15 09:59:01 +02'00'

 REPUBLIKA E SHQIPERISE	
POROSITESI: UJESJELLES - KANALIZIME SH.A. KAVAJE	
OBJEKTI: STUDIM , PROJEKTIM RIKONSTRUKSIONI I IMPIANTIT MASKURI	
EMERTESA E FLETES: INSTALIMET ELEKTRIKE TE MAKINERIVE NE IMPIANT	<i>Nr.fletes</i>
PROJEKTOI STUDIO "ZENIT-06" sh.p.k GRUPI PROJEKTIMIT	<i>SH : 1:100</i>
Ark.Rajmonda DAJA Ing.Ndert.Rexhep TARBA Ing.Elek.Spiro PLEQI Ing.Gjeo:Lulzim VRAPI	Ing.Mek.Gaqo APOSTOLI Ing.Gjeol.Dritan FEZGA Ing.Mjed.Kristaq GJOKA Ing.Hidro.Gani SHEHAJ
Rruga:Myrteza Topi (Nr 18.zip.code.1007) E-Mail: zenit06@live.com TIRANE -ALBANIA	
Mobile phone: +35569209965	
 "ZENIT-06"sh.p.k	

dt.11.01.2016

PROJEKTI I NDRICIMIT DHE PRIZAVE NE KUOTEN +16.55

LEGJENDA

-  NDRICUES FLOROSHENT 2X36W
-  NDRICUES FLOROSHENT 1X36W
-  NDRICUES EMERGJENCE 1X18
-  NDRICUES TIP PROZHEKTORI ME AVUJ NATRIUMI 70W
-  NDRICUES ME KRAHE NE SHTYLLE H 2M .2'
-  NDRICUES LED 44W (60X60)
-  KUADER ELEKTRIK
-  PRIZE E THEJESHT 1P+N+T 220 16A
-  PRIZE TREFAZORE ME BLOKIM 380 V 25A
-  PRIZE TREFAZORE PA BLOKIM 380 V 16A
-  CELES DEVIJAT I POLAR 10A
-  CELES I THJESHT I POLAR 10A
-  NDRICUES I MONTUAR NE MURE

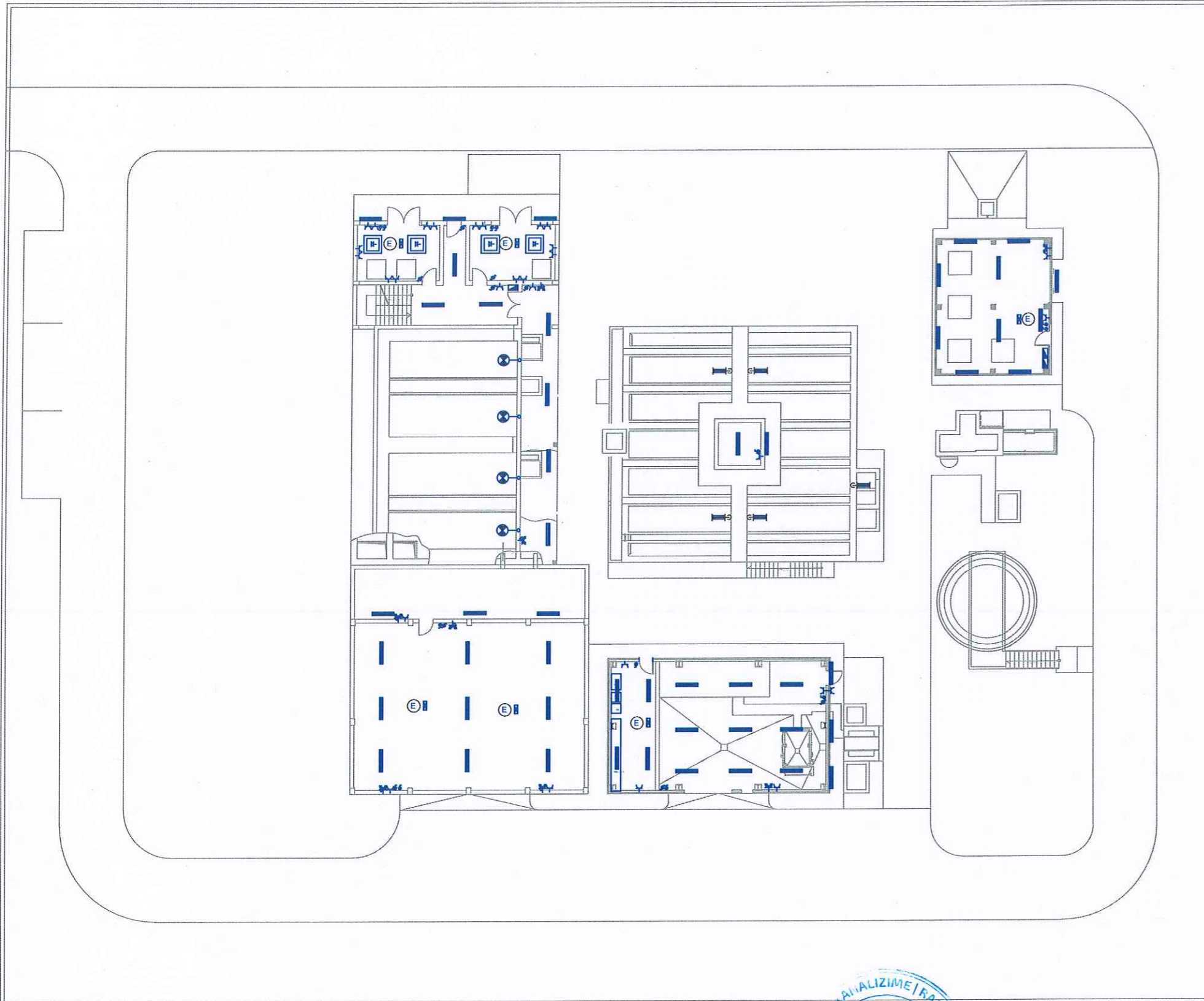

REPUBLIKA E SHQIPERISE

POROSITESI: UJESJELLES - KANALIZIME SH.A.
KAVAJE

OBJEKTI: STUDIM , PROJEKTIM RIKONSTRUKSIONI I
IMPIANTIT MASKURI

EMERTESA E FLETES:PROJEKTI I NDRICIMIT
DHE PRIZAVE NE KUOTEN +16.55

Nr.fletes

SH : 1:1000

dt.11.01.2016

PROJEKTOI STUDIO "ZENIT-06" sh.p.k

GRUPI PROJEKTIMIT

Ark.Rajmonda DAJA
Ing: Ndert.Rexhep TARBA
Ing:Elek.Spiro PLEQI
Ing Gjeo:Lulzim VRAPI

Ing.Mek.Gaqo APOSTOLI
Ing.Gjeol.Dritan FEZGA
Ing.Mjed.Kristaq GJOKA
Ing.Hidro.Gani SHEHAJ

Rruga:Myrteza Topi (Nr 18.zip.code.1007)

E-Mail: zenit06@live.com
TIRANE -ALBANIA

Mobile phone:
+35569209965

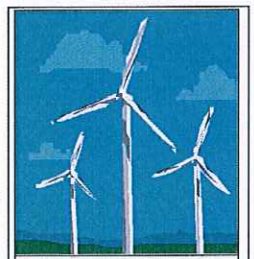

"ZENIT-06"sh.p.k



Kristaq
Zhupa

Digitally signed by
Kristaq Zhupa
Date: 2023.01.15
09:59:01 +0200

PROJEKTI I NDRICIMIT DHE PRIZAVE NE KUOTEN +19.95

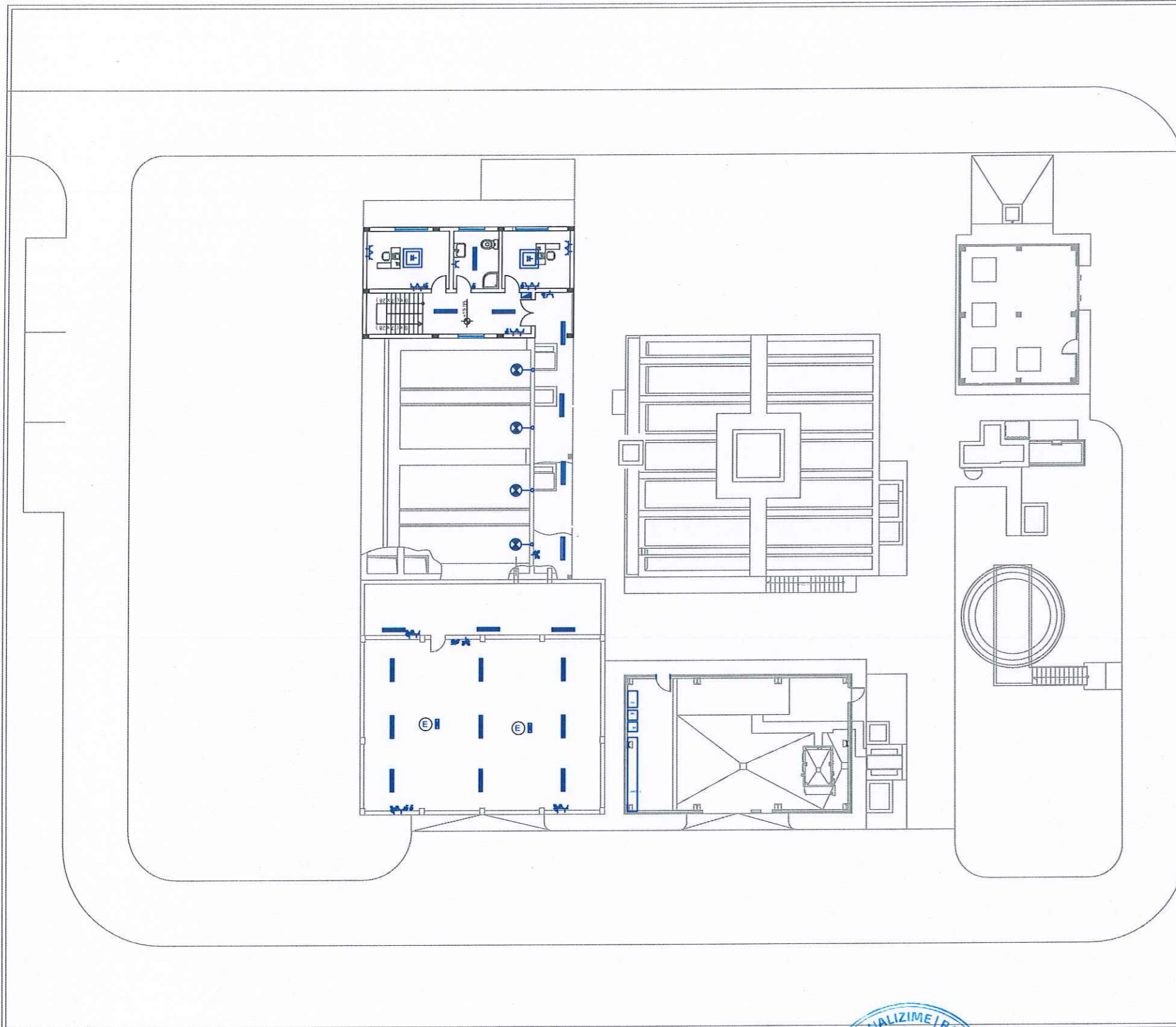

LEGJENDA

-  NDRICUES FLOROSHENT 2X36W
-  NDRICUES FLOROSHENT 1X36W
-  NDRICUES EMERGJENCE 1X18
-  NDRICUES TIP PROZHEKTORI ME AVUJ NATRIUMI 70W
-  NDRICUES ME KRAHE NE SHTYLLE H 2M, 2'
-  NDRICUES LED 44W (60X60)
-  KUADER ELEKTRIK
-  PRIZE E THEJESHT 1P+N+T 220.16A
-  PRIZE TREFAZORE ME BLOKIM 380 V 25A
-  PRIZE TREFAZORE PA BLOKIM 380 V 16A
-  CELES DEVIJAT I POLAR 10A
-  CELES I THJESHT I POLAR 10A
-  NDRICUES I MONTUAR NE MURE



REPUBLIKA E SHQIPERISE

POROSITESI: UJESJELLES - KANALIZIME SH.A.
KAVAJE

OBJEKTI: STUDIM , PROJEKTIM RIKONSTRUKSIONI I
IMPIANTIT MASKURI

EMERTESA E FLETES: PROJEKTI I NDRICIMIT
DHE PRIZAVE NE KUOTEN +19.95

Nr.fletes

SH :1:100

dt.11.01.2016

PROJEKTOI STUDIO "ZENIT-06" sh.p.k

GRUPI PROJEKTIMIT

Ark.Rajmonda DAJA
Ing: Ndert.Rexhep TARBA
Ing: Elek.Spiro PLEQI
Ing Gjeo:Lulzim VRAPI

Ing.Mek.Gaqo APOSTOLI
Ing.Gjeol.Dritan FEZGA
Ing.Mjed.Kristaq GJOKA
Ing.Hidro.Gani SHEHAJ

Rruga: Myrteza Topi (Nr 18.zip.code.1007)

E-Mail: zenit06@live.com
TIRANE -ALBANIA

Mobile phone:
+35569209965

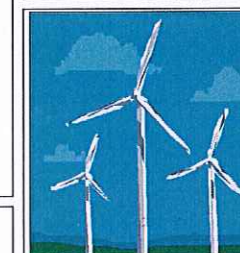

"ZENIT-06"sh.p.k





Kristaq
Zhupa

Digitally signed by
Kristaq Zhupa
Date: 2024.08.15
09:59:01 +0200

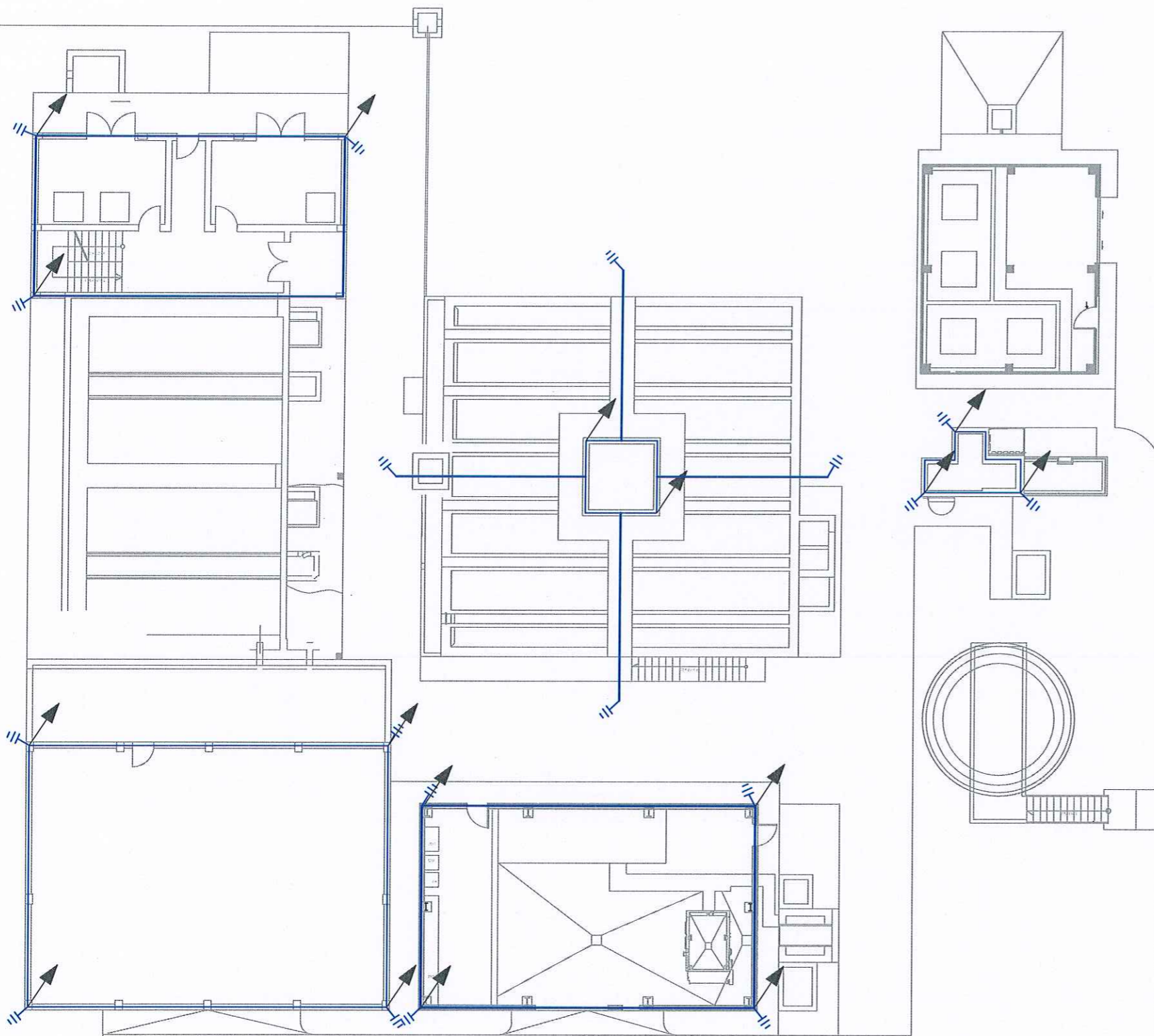
PLANI I POZICIONIMIT TE RRUFEPRITESAVE



LEGJENDA

-  ELEKTRODE TOKEZIMI RRUFEPRITESI 150X150X3 L = 1.5m
-  SHITZE RRUFEPRITESI L= 1m
-  SHIRIT CELIKU I ZINKUAR 30X3mm



REPUBLIKA E SHQIPERISE

POROSITESI: UJESJELLES - KANALIZIME SH.A.
KAVAJE

OBJEKTI: STUDIM , PROJEKTIM RIKONSTRUKSIONI I
IMPIANTIT MASKURI

EMERTESA E FLETES:PLANI I POZICIONIMIT
TE RRUFEPRITESAVE

Nr.fletes

SH :1:100

PROJEKTOI STUDIO "ZENIT-06" sh.p.k

GRUPI PROJEKTIMIT

dt.11.01.2016

Ark.Rajmonda DAJA
Ing: Ndert.Rexhep TARBA
Ing:Elek.Spiro PLEQI
Ing Gjeo:Lulzim VRAPI

Ing.Mek.Gaqo APOSTOLI
Ing.Gjeol.Dritan FEZGA
Ing.Mjed.Kristaq GJOKA
Ing.Hidro.Gani SHEHAJ



Kristaq
Zhupa

Rruga:Myrteza Topi (Nr 18.zip.code.1007)

E-Mail: zenit06@live.com
TIRANE -ALBANIA

Mobile phone:
+35569209965

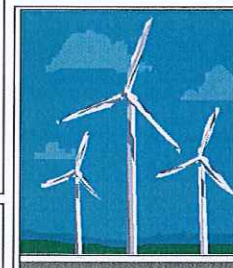

"ZENIT-06"sh.p.k

SKEMA E PAJISJEVE ELEKTRONIKE

LEGJENDA

-  KUADER KONTROLLI
-  KASETA E LIDHJEVE
-  PASARELE KABULLI ELEKTIRKE
-  KABIAN E ANALIZAVE
-  ANALIZATOR
-  TREGUES NIVELI
-  MATES US
-  MATES PRESIONI

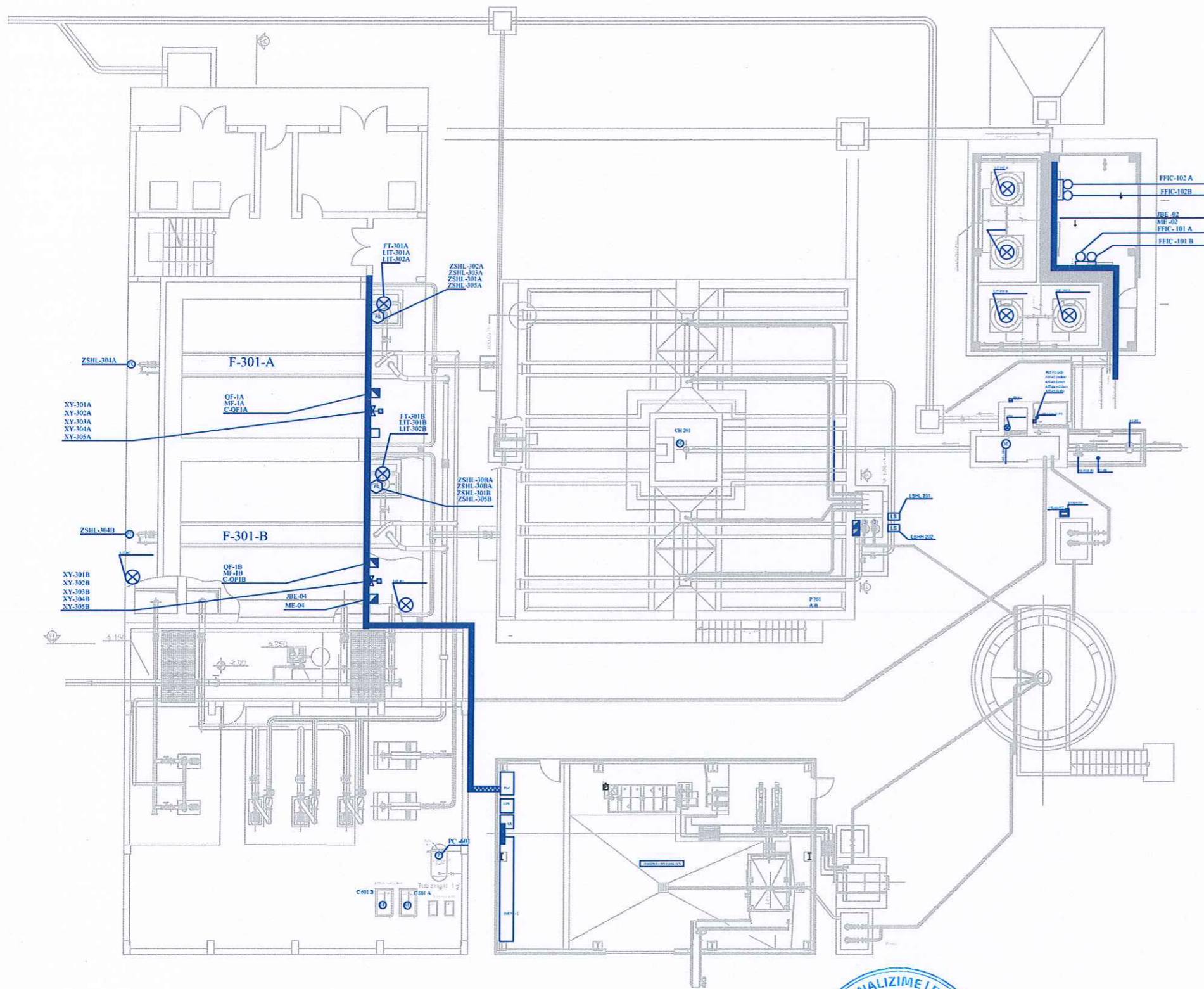

Kristaq Zhupa
Digitally signed by Kristaq Zhupa
Date: 2024.08.15 06:59:02 +0200

 REPUBLIKA E SHQIPERISE	
POROSITESI: UJESJELLES - KANALIZIME SH.A. KAVAJE	
OBJEKTI: STUDIM , PROJEKTIM RIKONSTRUKSIONI I IMPIANTIT MASKURI	
EMERTESA E FLETES: SKEMA E PAJISJEVE ELEKTRONIKE	<i>Nr.fletes</i>
	<u>SH : 1:100</u>
	<i>dt.11.01.2016</i>
PROJEKTOI STUDIO "ZENIT-06" sh.p.k GRUPI PROJEKTIMIT	
Ark.Rajmonda DAJA Ing. Ndert.Rexhep TARBA Ing.Elek.Spiro PLEQI Ing Gjeo:Lulzim VRAPI	Ing.Mek.Gaqo APOSTOLI Ing.Gjeol.Dritan FEZGA Ing.Mjed.Kristaq GJOKA Ing.Hidro.Gani SHEHAJ
Rruga:Myrteza Topi (Nr 18.zip.code.1007) E-Mail: zenit06@live.com TIRANE -ALBANIA	
Mobile phone: +35569209965	
 "ZENIT-06"sh.p.k	

SKEMA E PRODIMIT DHE FURNIZIMIT ME AJER INSTRUMENTAL DHE PER SHERBIME

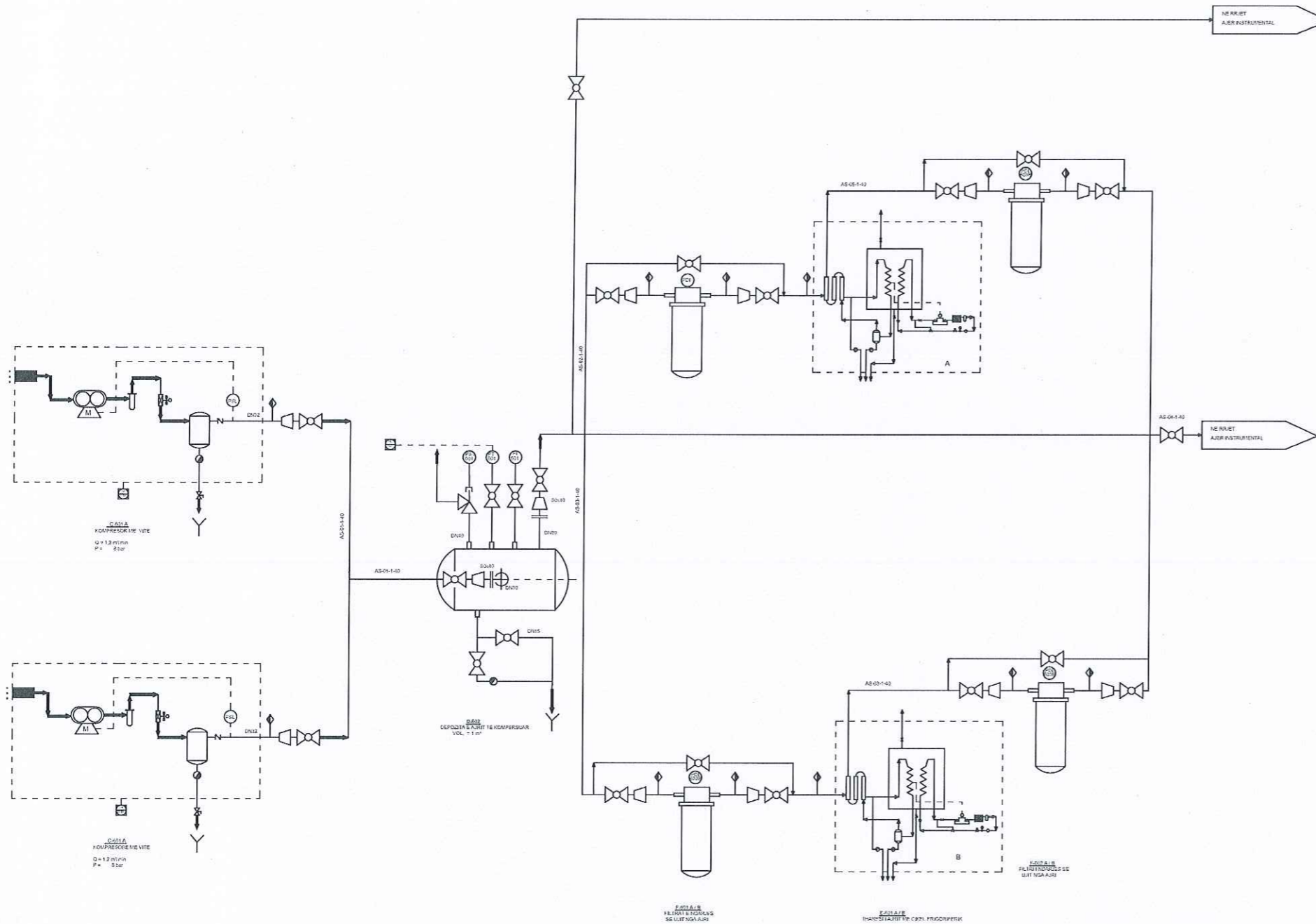

REPUBLIKA E SHQIPERISE

POROSITESI: UJESJELLES - KANALIZIME SH.A.

KAVAJE

OBJEKTI: STUDIM , PROJEKTIM RIKONSTRUKSIONI I IMPIANTIT MASKURI

EMERTESA E FLETES: SKEMA E PRODIMIT DHE FURNIZIMIT ME AJER INSTRUMENTAL DHE PER SHERBIME

Nr.fletes

SH :

dt.11.01.2016

PROJEKTOI STUDIO "ZENIT-06" sh.p.k

GRUPI PROJEKTIMIT

Ark.Rajmonda DAJA
Ing: Ndert.Rexhep TARBA
Ing:Elek.Spiro PLEQI
Ing Gjeo:Lulzim VRAPI

Ing.Mek.Gaqo APOSTOLI
Ing.Gjeol.Dritan FEZGA
Ing.Mjed.Kristaq GJOKA
Ing.Hidro.Gani SHEHAJ

Rruga:Myrteza Topi (Nr 18.zip.code.1007)

E-Mail: zenit06@live.com
TIRANE -ALBANIA

Mobile phone:
+35569209965



Kristaq Zhupa
Digitally signed by Kristaq Zhupa
Date: 2024.06.15 09:39:01 +0200

IMPIANTI TOKEZIMIT

LEGJENDA

-  NDRICUES RRUGOR SMART VP CL1 M-S
250W 230V
-  PUSETE PVC 30X30X40CM
-  PUSETE TOKEZIMI
-  PERCJELLES TOKEZIMI
-  PUSETE BETONI

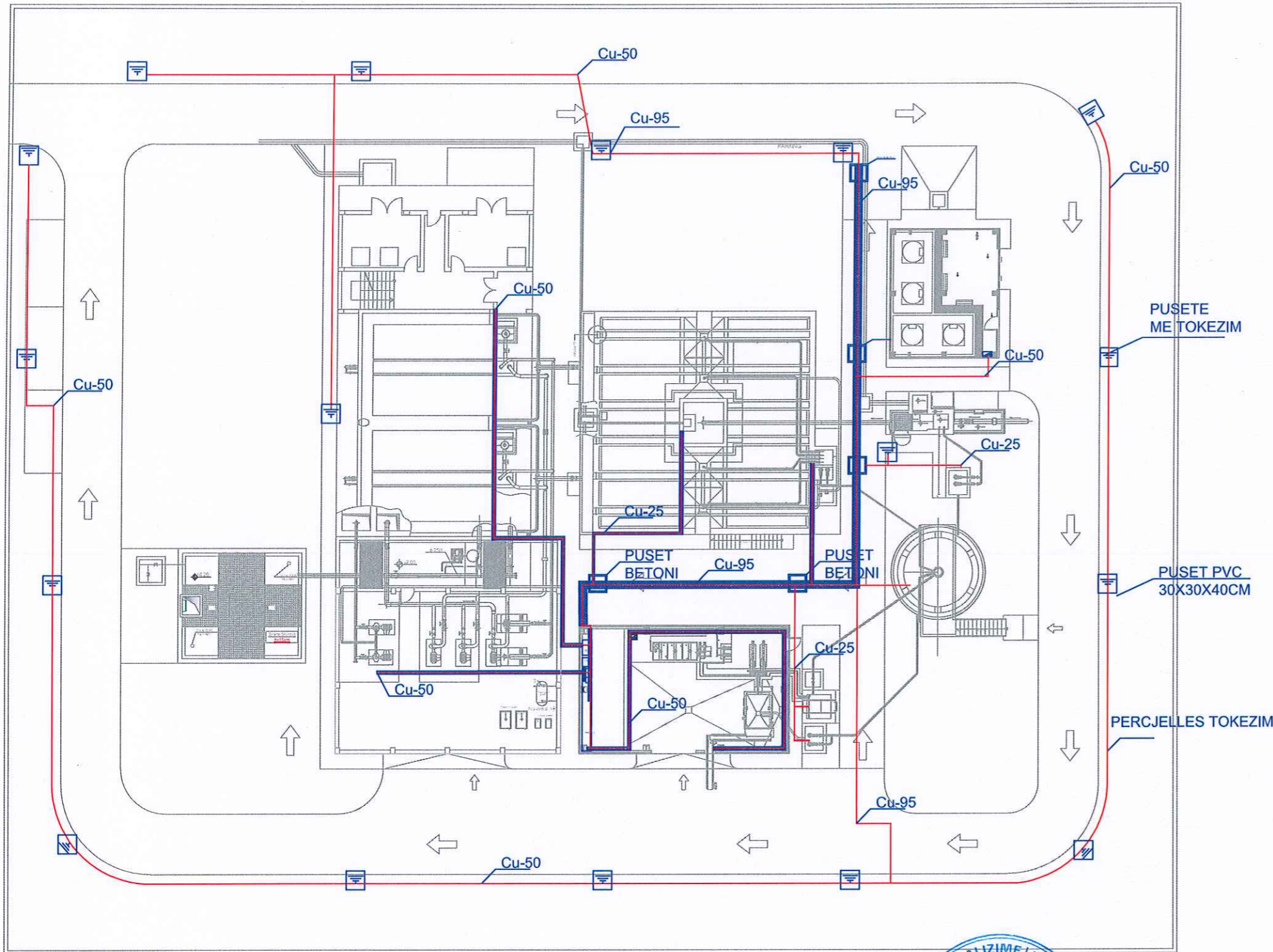

 REPUBLIKA E SHQIPERISE	
POROSITESI: UJESJELLES - KANALIZIME SH.A. KAVAJE	
OBJEKTI: STUDIM, PROJEKTIM RIKONSTRUKSIONI I IMPIANTIT MASKURI	
EMERTESA E FLETES: SKEMA E TOKEZIMIT RRUGORE	<i>Nr.fletes</i>
PROJEKTOI STUDIO "ZENIT-06" sh.p.k GRUPI PROJEKTIMIT	
Ark.Rajmonda DAJA Ing: Ndert.Rexhep TARBA Ing: Elek.Spiro PLEQI Ing Gjeo:Lulzim VRAPI	Ing.Mek.Gaqo APOSTOLI Ing.Gjeol.Dritan FEZGA Ing.Mjed.Kristaq GJOKA Ing.Hidro.Gani SHEHAJ
Rruga: Myrteza Topi (Nr 18.zip.code.1007) E-Mail: zenit06@live.com TIRANE -ALBANIA	
Mobile phone: +35569209965	
	
Kristaq Zhupa	
	

Nr.fletes

SH : 1:100

dt.11.01.2016

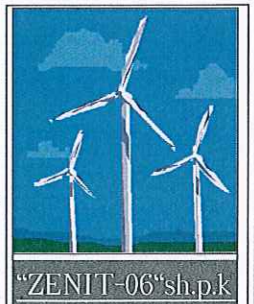

SISTEMI TELEKONTROLLIT (KUADRI QA)

PAMJA KRYESORE E KUADRIT QA

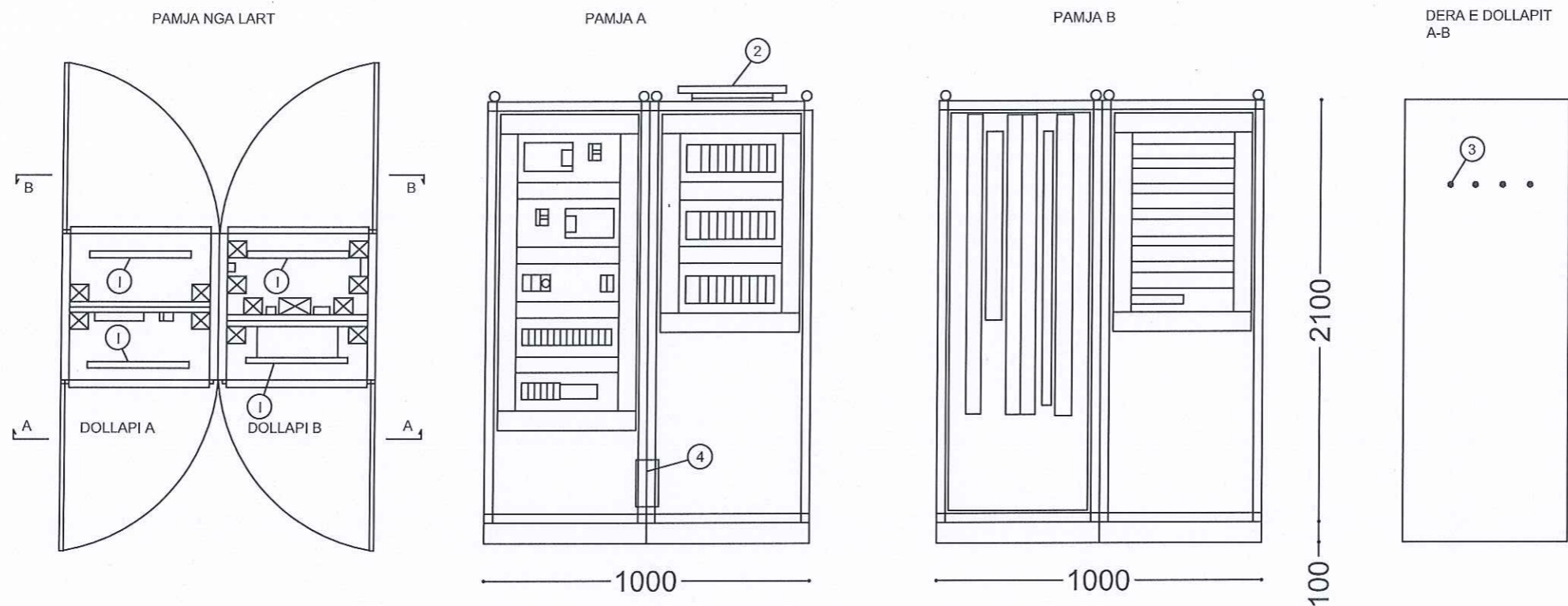

- ① LLAMPA
- ② OXHAK AJRIMI
- ③ LLAMPA SINJALIZUSE - ?22
- ④ REZISTENCA ANTIKONDESIM

Kristaq Zhupa



 REPUBLIKA E SHQIPERISE	EMERTESA OBJEKTIT: STUDIM PROJEKTIM I OBJEKTIT RIKONSTRUKSION I IMPIANTIT MASKURI	Nr. fletes E-1
	EMERTESA FLETES: SISTEMI TELEKONTROLLIT (KUADRI QA)	SH : : .
ZENIT 06 	POROSITESI: UJESJELLES - KANALIZIME KAVAJE	GRUPI PROJEKTIMIT (ZENIT 06) Ark. Rajmonda DAJA Ing. Mek. Gaqo APOSTOLI Ing. Hidro. Rexhep TARBA Ing. Gjeol. Dritan FEZGA Ing. Elek. Spiro PLEQI Ing. Kristaq GJOKA Ing. Gjeol. Lulzim VRAPI Ing. Gani SHEHAJ
	Kruga: Myrteza Topi (Nr 18.zip.code.1007) E-Mail: zenit06@live.com TIRANE - ALBANIA	Mobile phone 069 20 99 065

SISTEMI TELEKONTROLLIT (KUADRI QA)

PAMJA NGA LART

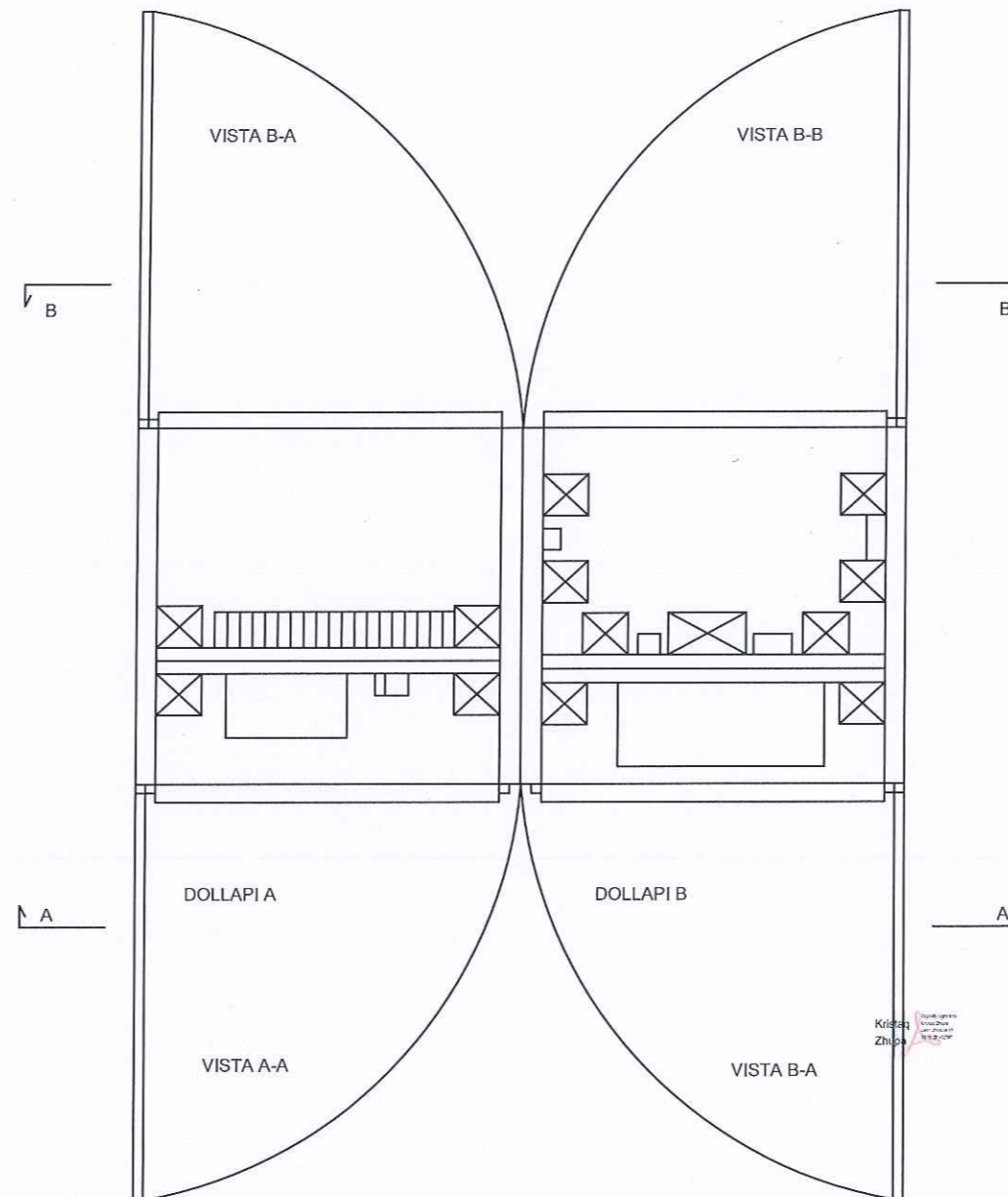

 REPUBLIKA E SHQIPERISE	EMERTESA OBJEKTIT: STUDIM PROJEKTIM I OBJEKTIT RIKONSTRUKSION I IMPIANTIT MASKURI	Nr. fletes E-3	
	EMERTESA FLETES: SISTEMI TELEKONTROLLIT (KUADRI QA)	SH : : _	
 ZENIT 06	POROSITESI: UJESJELLES - KANALIZIME KAVAJE	GRUPI PROJEKTIMIT (ZENIT 06)	
	Kruga: Myrteza Topi (Nr. 18, z.jp. code. 1007) E-Mail: zenit06@live.com TIRANE - ALBANIA	Mobile phone 069 20 99 065	Ark. Rajmonda DAJA Ing. Hidro. Rexhep TARBA Ing. Elk. Spiro PLEQI Ing. Gjeo: Lulzim VRAPI
		Ing. Mek. Gaqo APOSTOLI Ing. Gjeol. Dritan FEZGA Ing. Kristaq GJOKA Ing. Gani SHEHAJ	
		dt. __. __. 2016	

SISTEMI TELEKONTROLLIT (KUADRI QA)

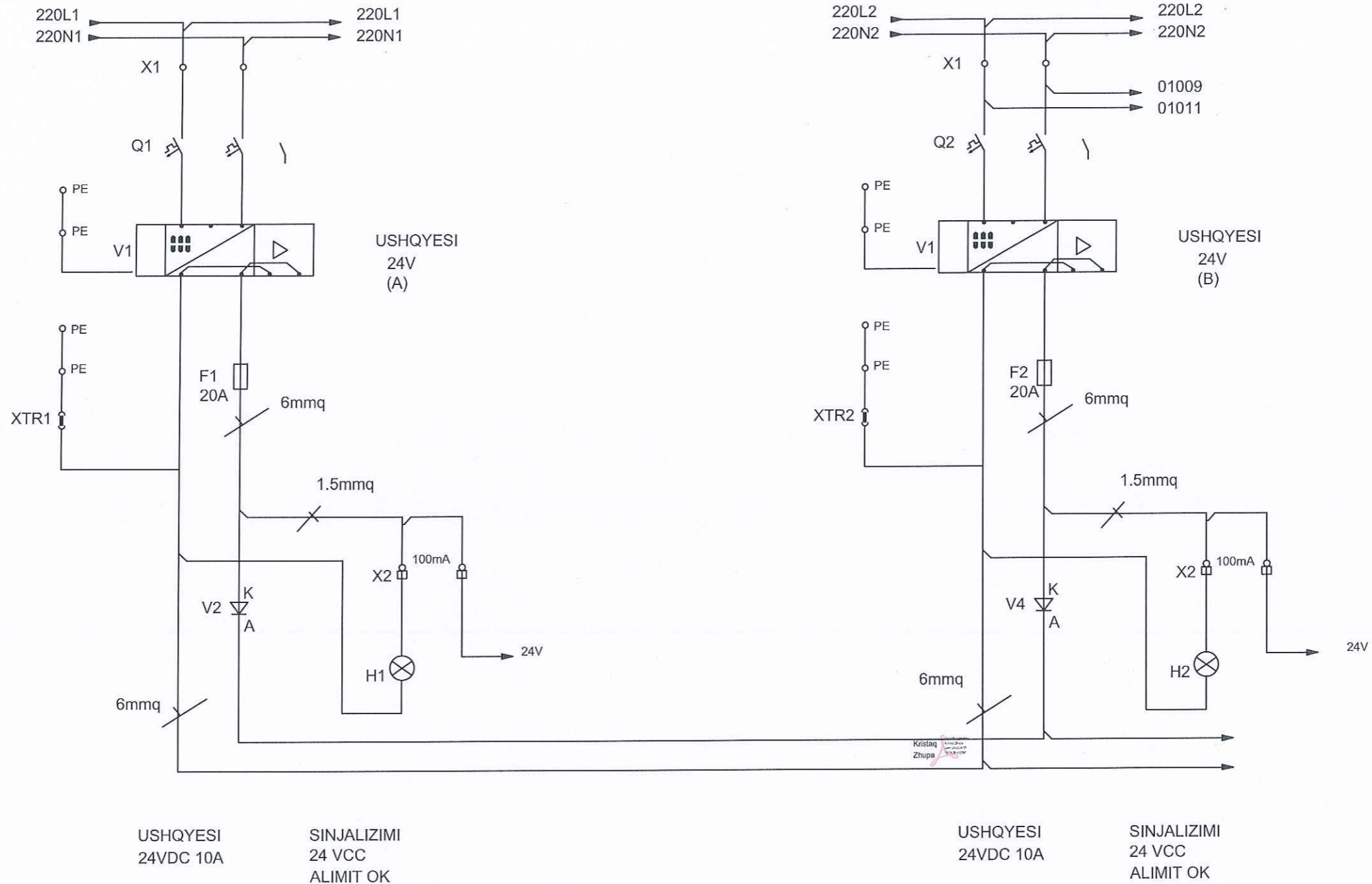

 REPUBLIKA E SHQIPERISE	EMERTESA OBJEKTIT: STUDIM PROJEKTIM I OBJEKTIT RIKONSTRUKSION I IMPIANTIT MASKURI		Nr. fletes E-4
	EMERTESA FLETES: SISTEMI TELEKONTROLLIT (KUADRI QA)		SH : : _
 ZENIT 06	POROSITESI: UJESJELLES - KANALIZIME KAVAJE		dt. __. __. 2016
	Rruga: Myrteza Topi (Nr 18 zip.codi: 1007) E-Mail: zenit06@live.com TIRANE - ALBANIA		GRUPI PROJEKTIMIT (ZENIT 06) Ark. Rajmonda DAJA Ing. Mek. Gaqo APOSTOL Ing. Hidro. Rexhep TARBA Ing. Gjeol. Dritan FEZGA Ing. Elck. Spiro PLEQI Ing. Kristaq GJOKA Ing. Gjeo. Lulzim VRAPI Ing. Gani SHEHAJ
		Mobile phone 069 20 99 065	

SISTEMI TELEKONTROLLIT (KUADRI QA)

SISTEMI KONFIGURACIONIT

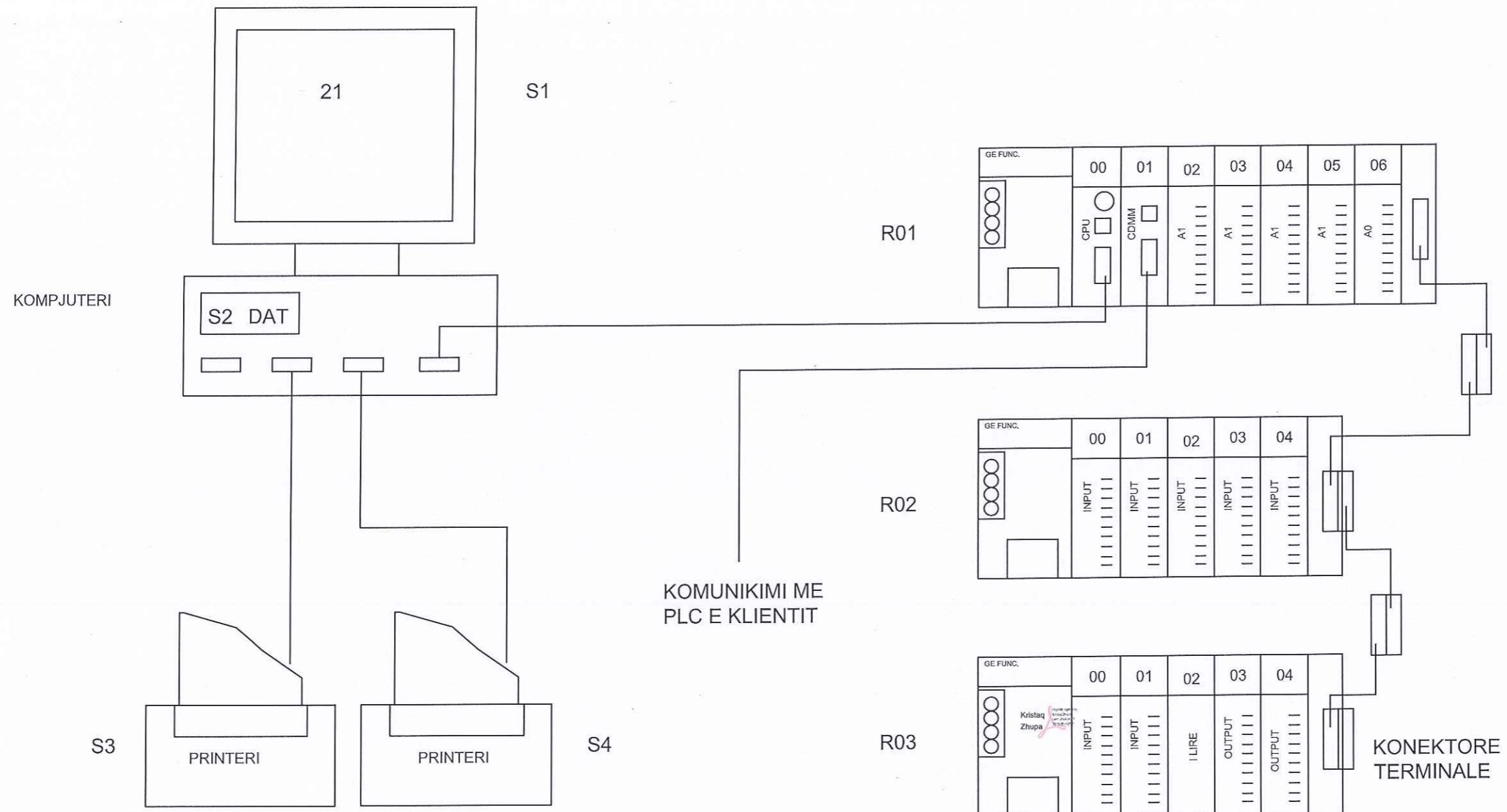

 REPUBLIKA E SHQIPERISE ZENIT 06 	EMERTESA OBJEKTIT: STUDIM PROJEKTIM I OBJEKTIT RIKONSTRUKSION I IMPIANTIT MASKURI	Nr. fletes E-5
	EMERTESA FLETES: SISTEMI TELEKONTROLLIT (KUADRI QA)	SH: :_
POROSITESI: UJESJELLES - KANALIZIME KAVAJE	GRUPI PROJEKTIMIT (ZENIT 06) Ark. Rajmonda DAJA Ing. Mck. Gaqo APOSTOLJ Ing. Hidro. Rexhep TARBA Ing. Gjeol. Dritan FEZGA Ing. Elck. Spiro PLEQI Ing. Kristaq GJOKA Ing. Gjeol. Luzim VRAPI Ing. Gani SHEHAJ	dt. __, __, 2016
Rruga: Myrteza Topi (Nr 18 zip code 1007) E-Mail: zenit06@live.com TIRANE - ALBANIA	Mobile phone 069 20 99 065	

SISTEMI TELEKONTROLLIT (KUADRI QA)

PLC RACK R01

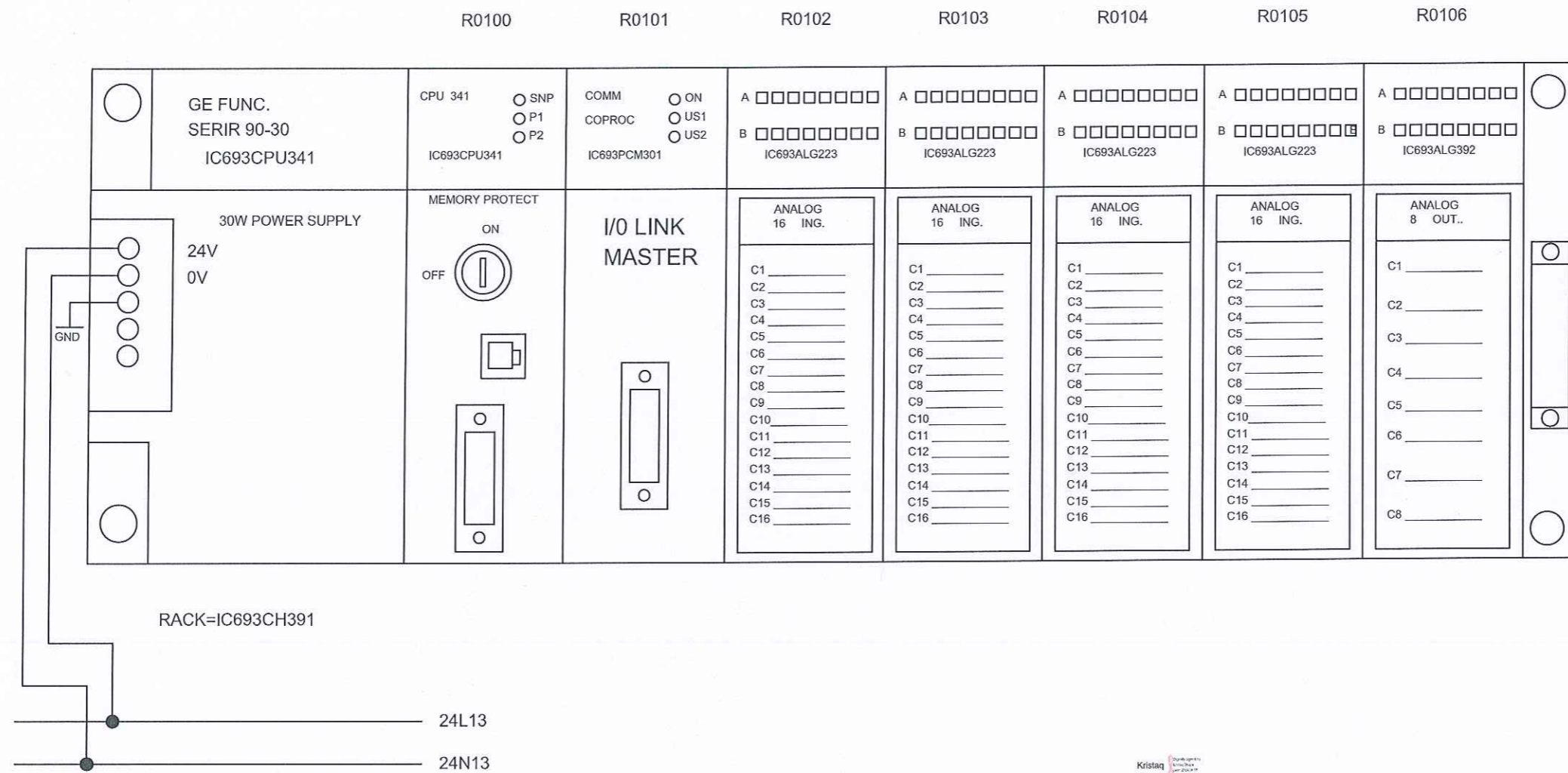

Kristaq Zhupa



	EMERTESA OBJEKTIT: STUDIM PROJEKTIM I OBJEKTIT RIKONSTRUKSION I IMPIANTIT MASKURI	Nr. fletes E-6
	EMERTESA FLETES: SISTEMI TELEKONTROLLIT (KUADRI QA)	SH: :_
POROSITESI: UJESJELLES - KANALIZIME KAVAJE	GRUPI PROJEKTIMIT (ZENIT 06) Ark. Rajmonda DAJA Ing. Mek. Gaqo APOSTOLI Ing. Hidro. Rexhep TARBA Ing. Gjeol. Dritan FEZGA Ing. Elek. Spiro PLEQI Ing. Kristaq GJOKA Ing. Gjeol. Lulzim VRAPI Ing. Gani SHEHAJ	dt. __. __. 2016
Kruga: Myrteza Topi (Nr 18.zip.cudc.1007) E-Mail: zenit06@live.com TIRANE - ALBANIA	Mobile phone 069 20 99 065	

SISTEMI TELEKONTROLLIT (KUADRI QA)

PLC RACK R02

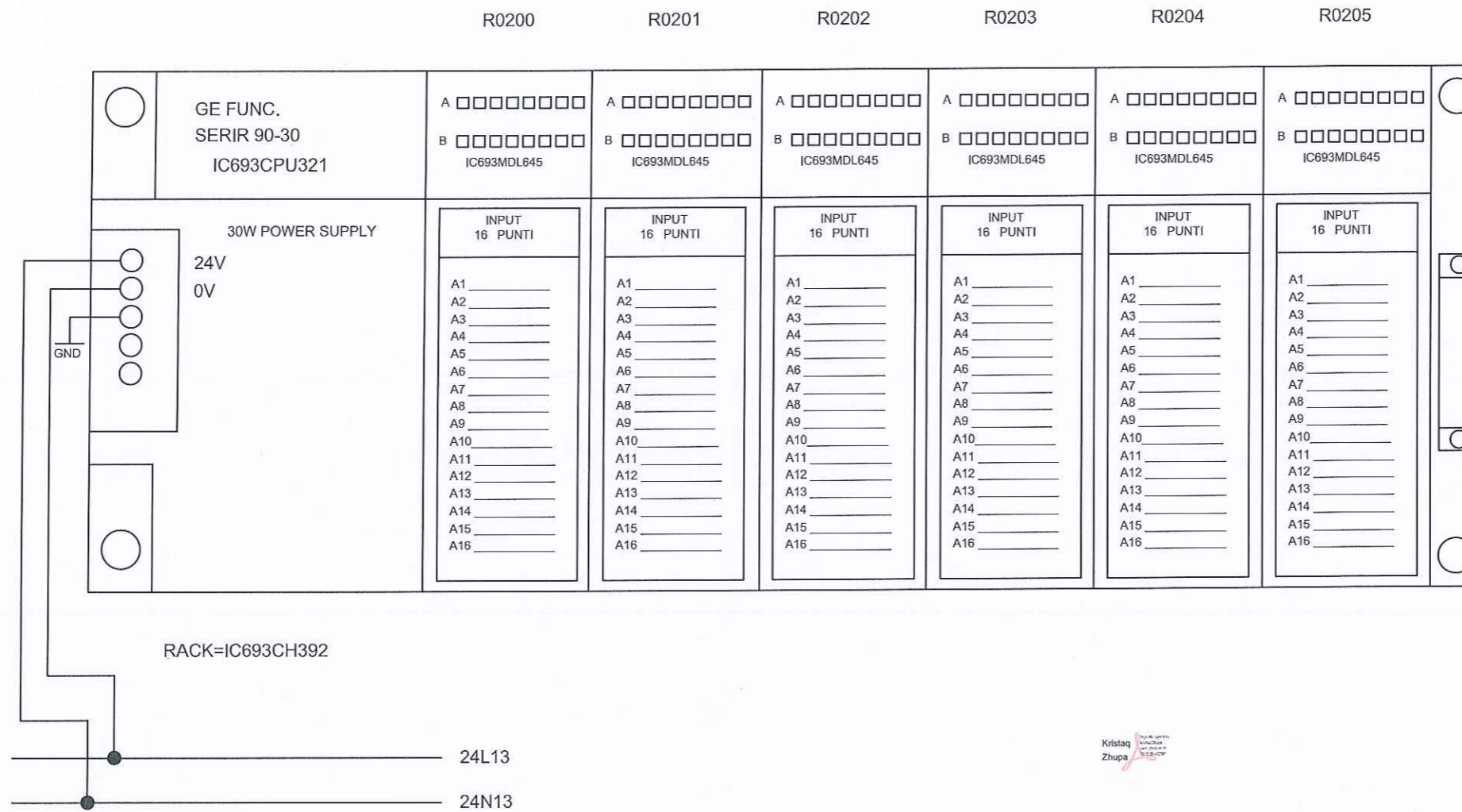

Kristaq Zhupa



	EMERTESA OBJEKTIT: STUDIM PROJEKTIM I OBJEKTIT RIKONSTRUKSION I IMPIANTIT MASKURI	Nr. fletes E-7
	EMERTESA FLETES: SISTEMI TELEKONTROLLIT (KUADRI QA)	SH: :_
POROSITESI: UJESJELLES - KANALIZIME KAVAJE	GRUPI PROJEKTIMIT (ZENIT 06) Ark. Rajmonda DAJA Ing. Mek. Gaqo APOSTOLI Ing. Hidro. Rexhep TARBA Ing. Gjeol. Dritan FEZGA Ing. Elek. Spiro PLEQI Ing. Kristaq GJOKA Ing. Gjeol. Lulzim VRAPI Ing. Gani SHEHAJ	dt. __. __. 2016
Rruga: Myrteza Topi (Nr 18 zjp.code.1007) E-Mail: zenit06@live.com TIRANE - ALBANIA	Mobile phone 069 20 99 065	

SISTEMI TELEKONTROLLIT (KUADRI QA)

PLC RACK R03

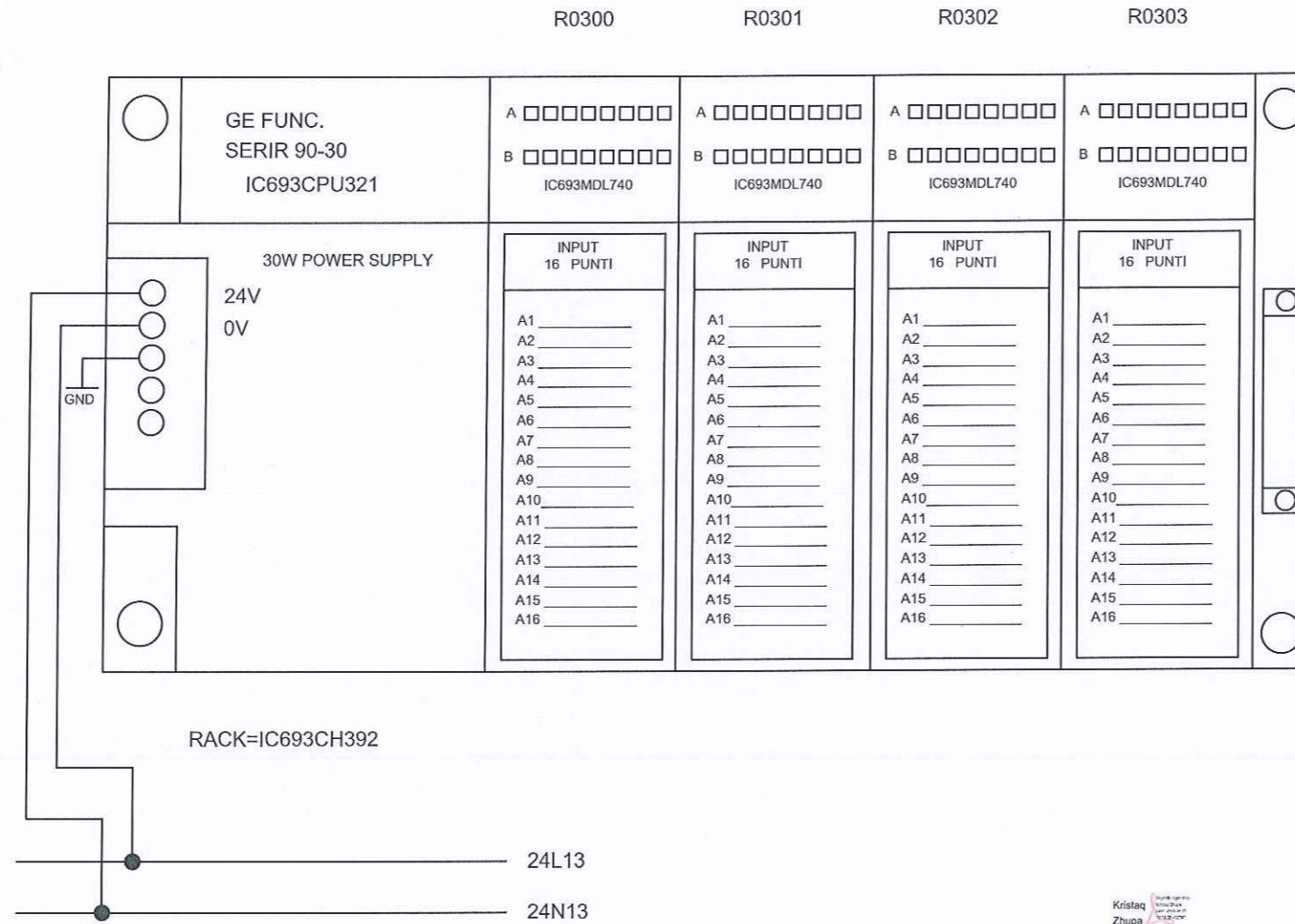

Kristaq Zhupa



	EMERTESA OBJEKTIT: STUDIM PROJEKTIM I OBJEKTIT RIKONSTRUKSION I IMPIANTIT MASKURI	Nr. fletes E-8
	EMERTESA FLETES: SISTEMI TELEKONTROLLIT (KUADRI QA)	SH : : _
	POROSITESI: UJESJELLES - KANALIZIME KAVAJE	dt. __. __. 2016
	GRUPI PROJEKTIMIT (ZENIT 06) Ark. Rajmonda DAJA Ing. Mek. Gaqo APOSTOLI Ing. Hidro. Rexhep TARBA Ing. Gjeol. Dritan FEZGA Ing. Elek. Spiro PLEQI Ing. Kristaq GJOKA Ing. Gjeol. Lulzim VRAPI Ing. Gani SHEHAJ	Mobile phone 069 20 99 065
E-Mail: zenit06@live.com TIRANE - ALBANIA		

SISTEMI TELEKONTROLLIT (KUADRI QA)

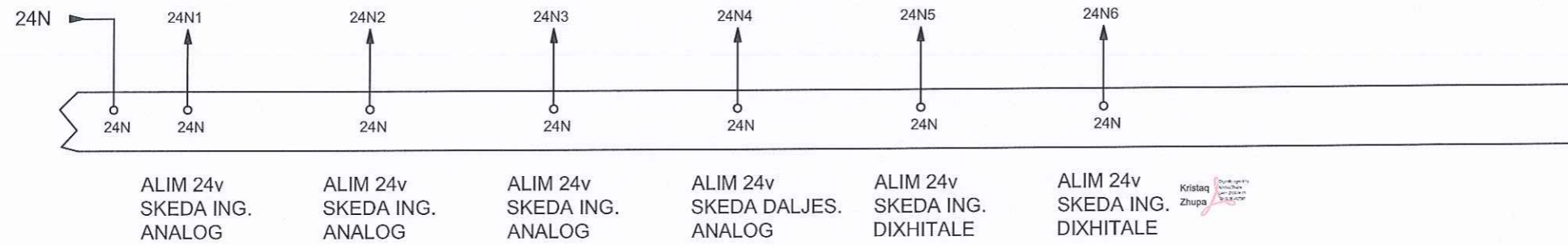
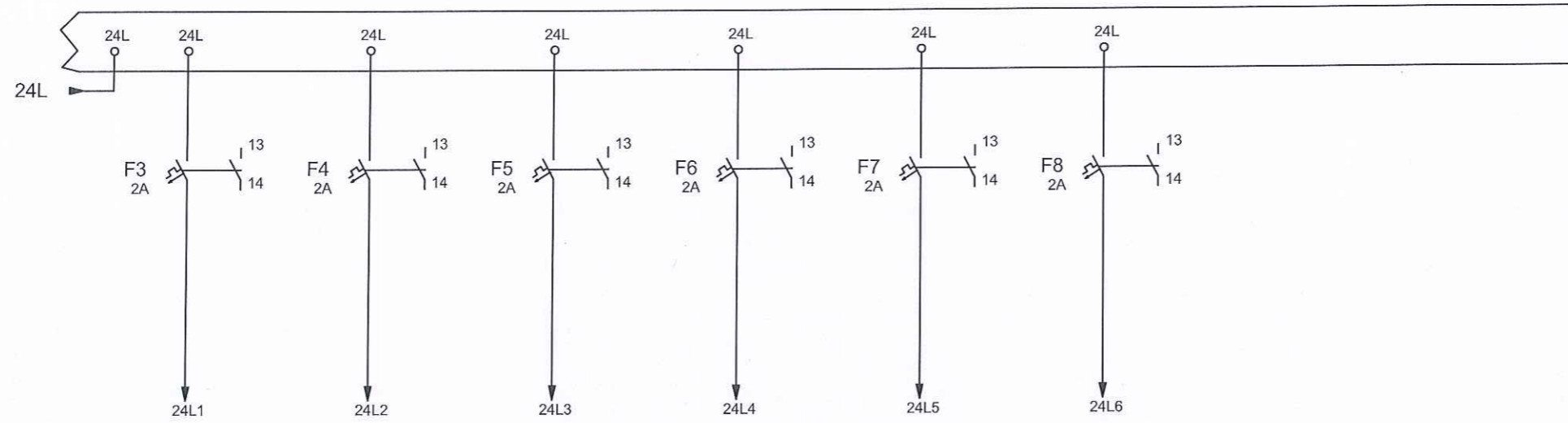

	EMERTESA OBJEKTIT: STUDIM PROJEKTIM I OBJEKTIT RIKONSTRUKSION I IMPIANTIT MASKURI	Nr. fletes E-9
	EMERTESA FLETES: SISTEMI TELEKONTROLLIT (KUADRI QA)	SH: :_
POROSITESI: UJESJELLES - KANALIZIME KAVAJE	GRUPI PROJEKTIMIT (ZENIT 06) Ark. Rajmonda DAJA Ing. Mek. Gaqo APOSTOLI Ing. Hidro. Rexhep TARBA Ing. Gjeol. Dritan FEZGA Ing. Elek. Spiro PLEQI Ing. Kristaq GJOKA Ing. Gjeol. Lulzim VRAPI Ing. Gani SHEHAJ	dt. ____ 2016
Rruga: Myrteza Topi (Nr 18, zip code: 1007) E-Mail: zenit06@live.com TIRANE - ALBANIA	Mobile phone 069 20 99 065	

SISTEMI TELEKONTROLLIT (KUADRI QA)

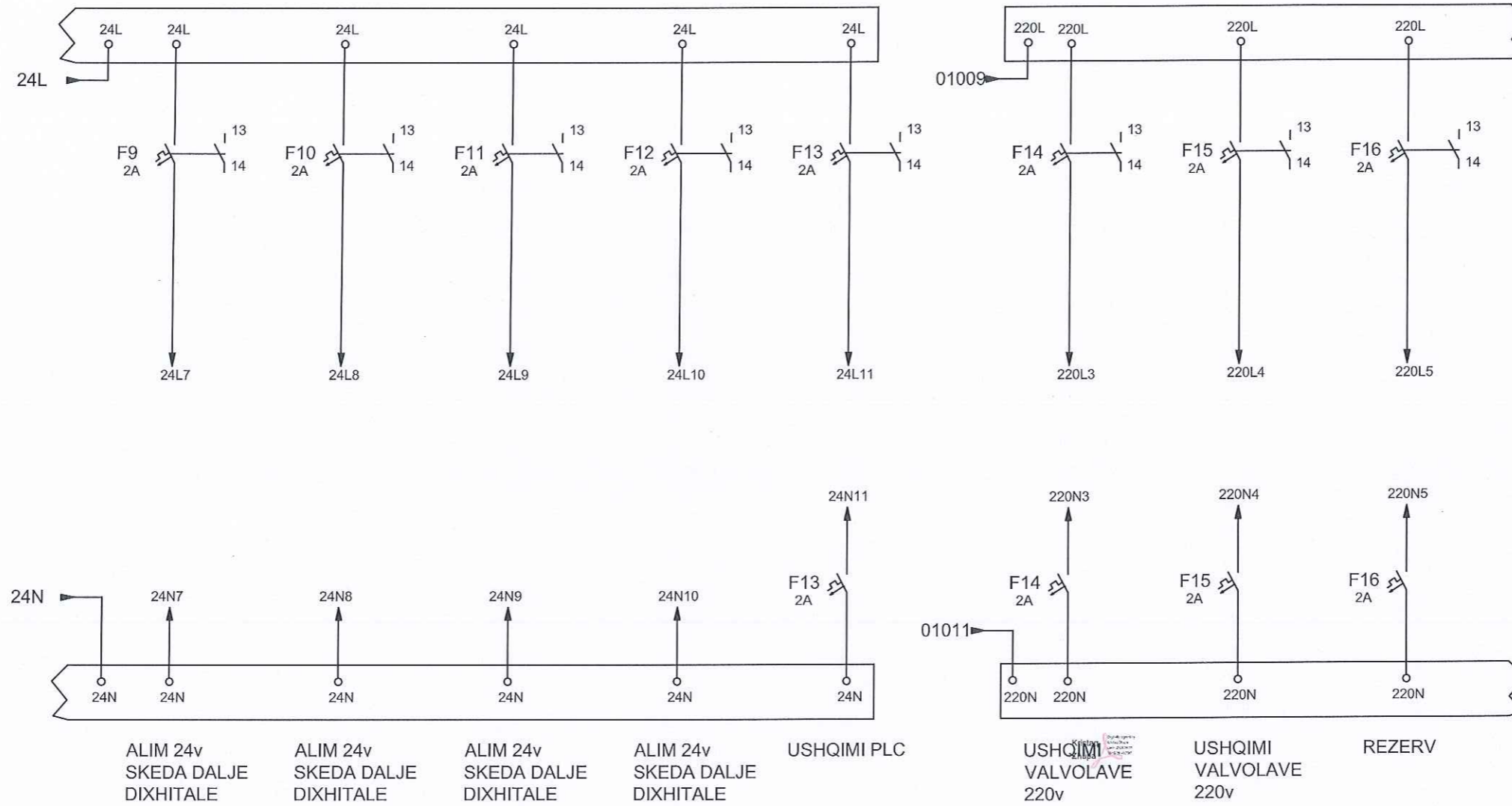

 REPUBLIKA E SHQIPERISE	EMERTESA OBJEKTIT: STUDIM PROJEKTIM I OBJEKTIT RIKONSTRUKSION I IMPIANTIT MASKURI	Nr. fletes 10
	EMERTESA FLETES: SISTEMI TELEKONTROLLIT (KUADRI QA)	SH : : :
 ZENIT 06	POROSITESI: UJESJELLES - KANALIZIME KAVAJE	dt. __. __. 2016
	GRUPI PROJEKTIMIT (ZENIT 06) Ark. Rajmonda DAJA Ing. Mek. Gaqo APOSTOLI Ing. Hidro. Rexhep TARBA Ing. Gjeol. Dritan FEZGA Ing. Elek. Spiro PLEQI Ing. Kristaq GJOKA Ing. Gjeo. Lulzim VRAPI Ing. Gani SHEHAJ	Mobile phone 069 20 99 065
Rruga: Myrteza Topi (Nr 18.zip.code.1007) E-Mail: zenit06@live.com TIRANE - ALBANIA		

SISTEMI TELEKONTROLLIT (KUADRI QA)

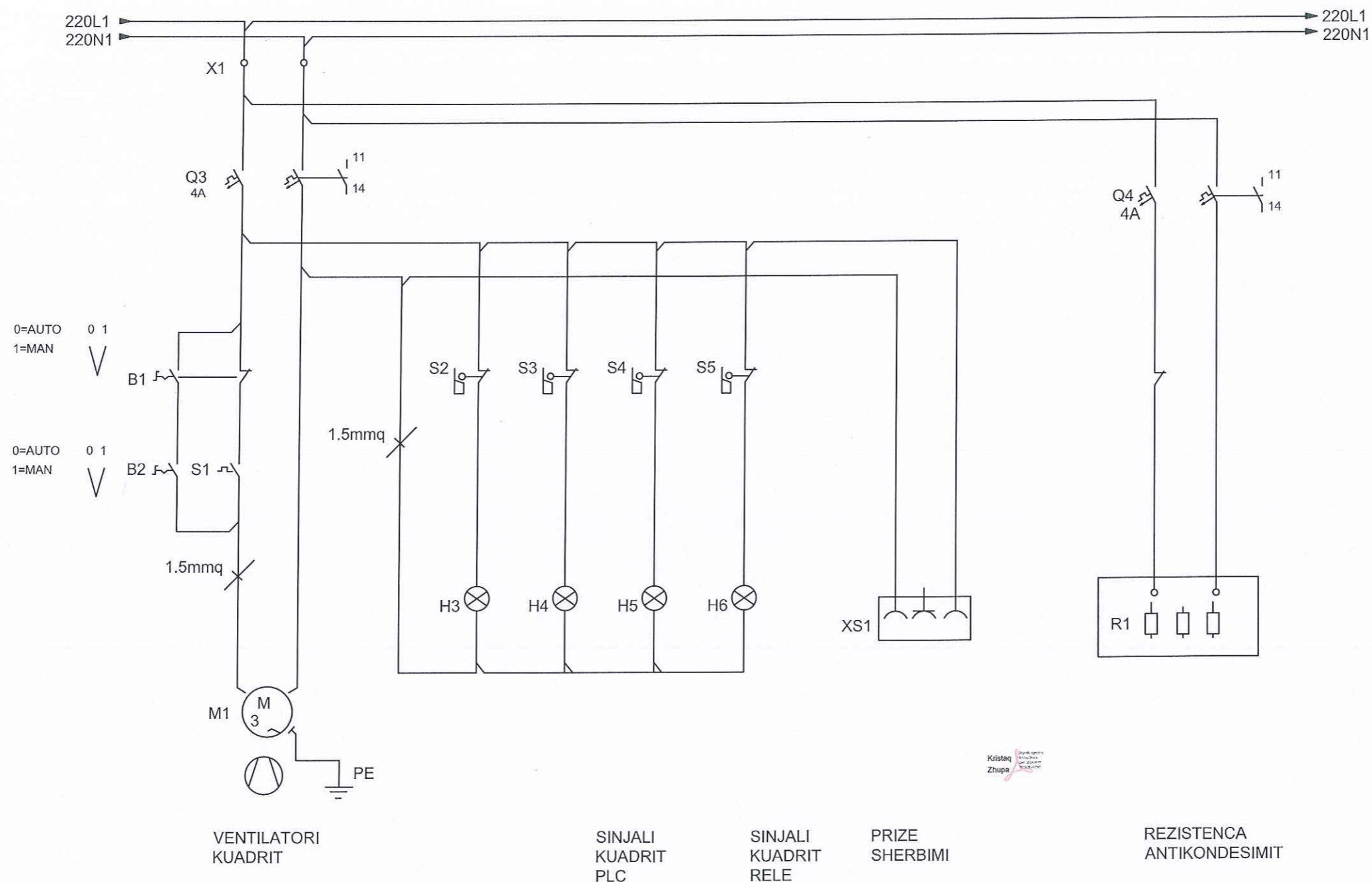

 REPUBLIKA E SHQIPERISE	EMERTESA OBJEKTIT: STUDIM PROJEKTIM I OBJEKTIT RIKONSTRUKSION I IMPIANTIT MASKURI		Nr. fletes E-11
	EMERTESA FLETES: SISTEMI TELEKONTROLLIT (KUADRI QA)		SH: :_
 ZENIT 06	POROSITESI: UJESJELLES - KANALIZIME KAVAJE		dt. __. __. 2016
	KRUGA: Myrteza Topi (Nr 18.zip.code.1007) E-Mail: zenit06@live.com TIRANE -ALBANIA		Mobile phone 069 20 99 065
		GRUPI PROJEKTIMIT (ZENIT 06) Ark.Rajmonda DAJA Ing.Mek.Gaqo APOSTOLI Ing. Hidro.Rexhep TARBA Ing.Gjeol.Dritan FEZGA Ing.Elek.Spiro PLEQI Ing.Kristaq GJOKA Ing.Gjeol.Lulzim VRAPI Ing.Gani SHEHAJ	

SISTEMI TELEKONTROLLIT (KUADRI QA)

PLC HYRJA ANALOGE SKEDA R0102 1/2

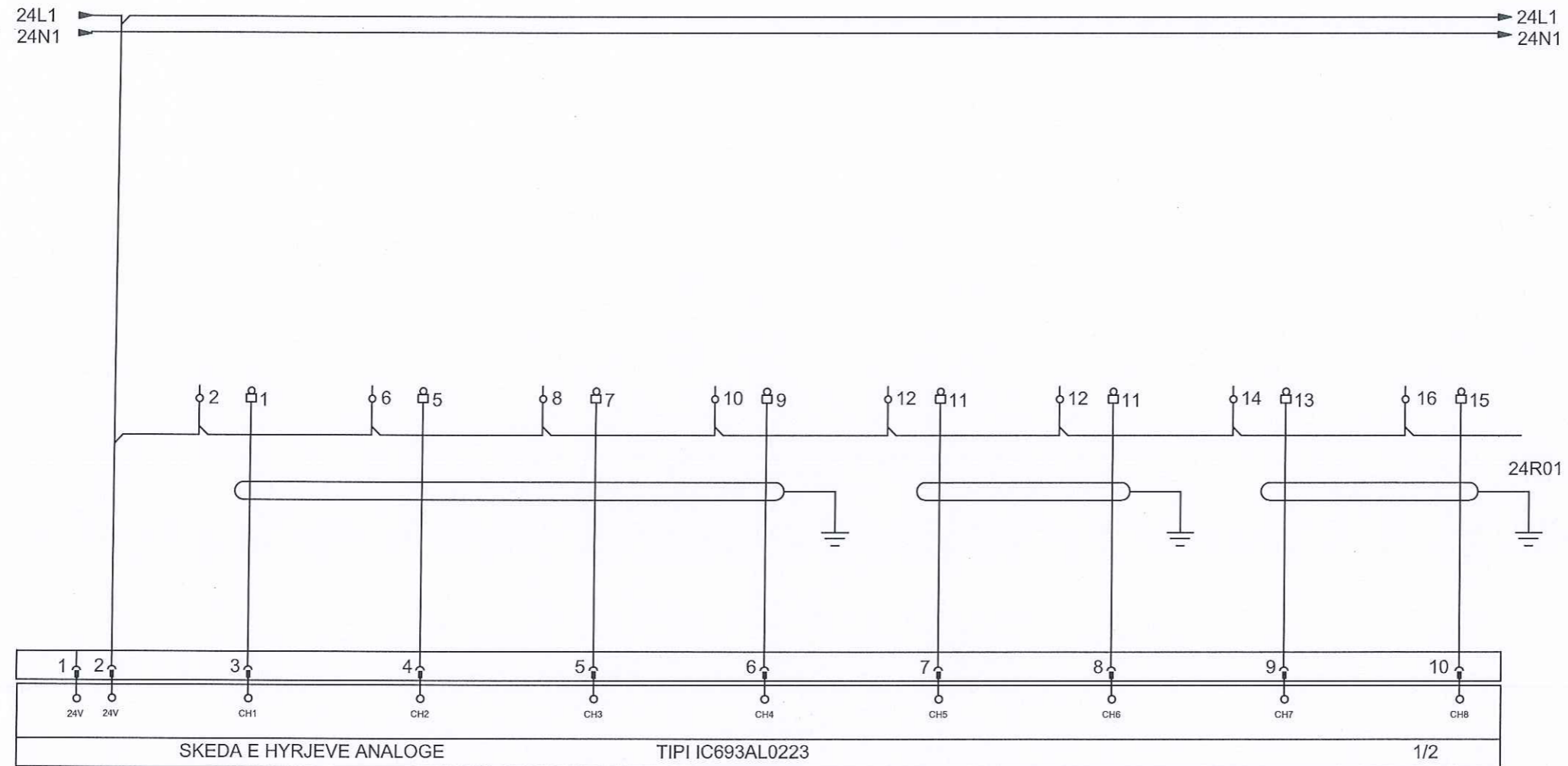

FIC-01
ARDHJA
E UJIT

LI-01
NIVELI
UJIT TE
HYRJES

TRI-01
TEMP.
UJI
I HYRJES

LI-102A
DEPOZITA
POLIKLOUR
ALUMINIT
D-102A

LI-102B
DEPOZITA
POLIKLOUR
ALUMINIT
D-102B

FEEDBACK
VALVE
FUZO

LI-101A
DEPOZITA
IPOKLORITI
D-101A

LI-101B
DEPOZITA
IPOKLORITIT
D-101B



 REPUBLIKA E SHQIPERISE	EMERTESA OBJEKTIT: STUDIM PROJEKTIM I OBJEKTIT RIKONSTRUKSION I IMPIANTIT MASKURI	Nr. fletes E-12
	EMERTESA FLETES: SISTEMI TELEKONTROLLIT (KUADRI QA)	SH : _
 ZENIT 06	POROSITESI: UJESJELLES - KANALIZIME KAVAJE	dt. _ _ 2016
	Rruga: Myrteza Topi (Nr 18, zip.codic.1007) E-Mail: zenit06@live.com TIRANE - ALBANIA	GRUPI PROJEKTIMIT (ZENIT 06) Ark. Rajmonda DAJA Ing. Mek. Gaço APOSTOL Ing. Hidro. Rexhep TARBA Ing. Gjeol. Dritan FEZGA Ing. Elek. Spiro PLEQI Ing. Kristaq GJOKA Ing. Gjeol. Lutzim VRAPI Ing. Gani SHEHAJ
	Mobile phone 069 20 99 065	