

PROFILAT TERTHORE
SHENIME

Seksioni Nr. 178 Progresiva 4+075		
Emri	Siperfaqja (m ²)	Volumi (m ³)
Germim	4.59	117.41
Mbushje	0.23	3.58

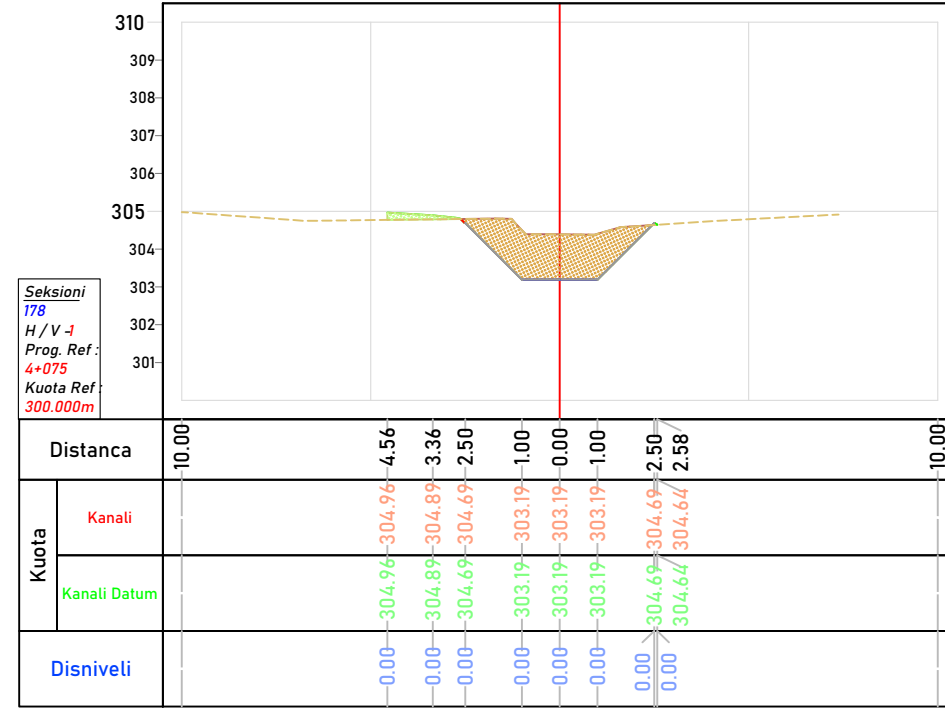

Seksioni Nr. 177 Progresiva 4+050		
Emri	Siperfaqja (m ²)	Volumi (m ³)
Germim	4.80	124.39
Mbushje	0.06	0.77

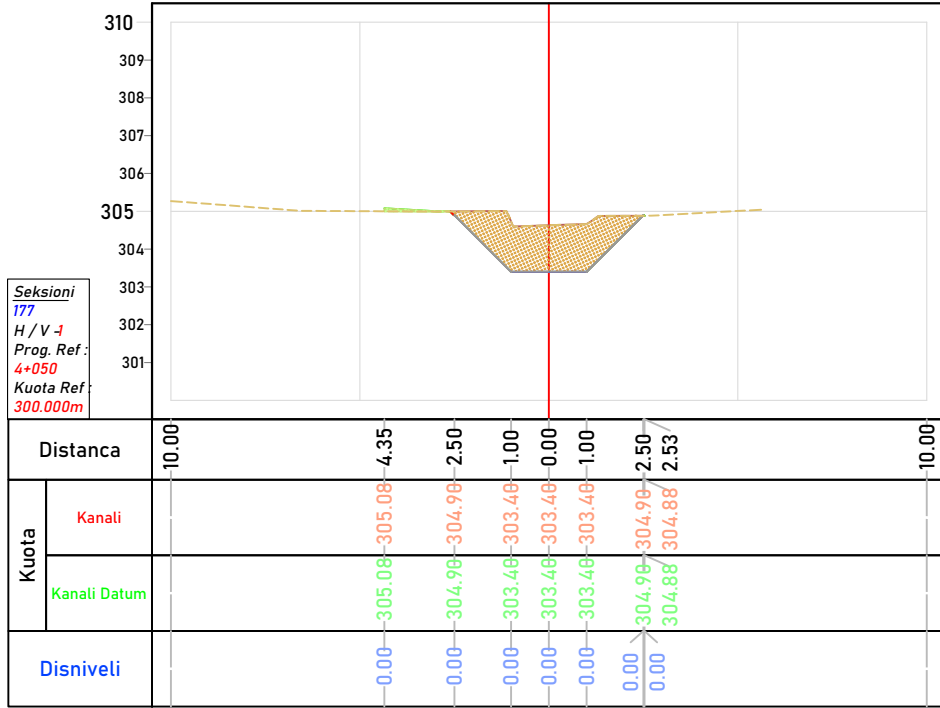

Seksioni Nr. 180 Progresiva 4+125		
Emri	Siperfaqja (m ²)	Volumi (m ³)
Germim	5.35	128.12
Mbushje	0.03	0.38

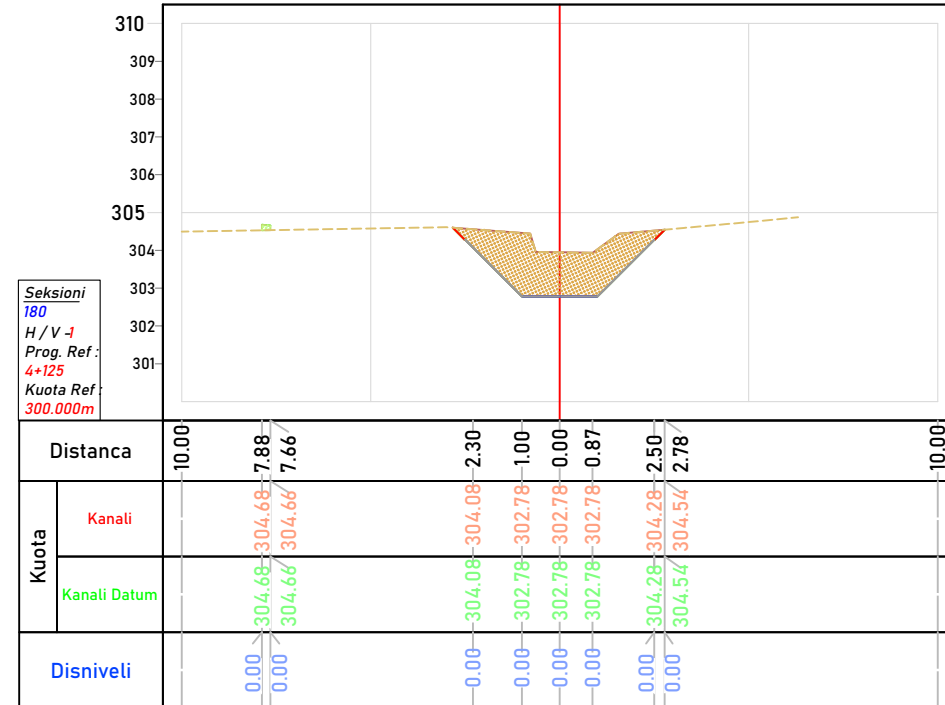

Seksioni Nr. 179 Progresiva 4+100		
Emri	Siperfaqja (m ²)	Volumi (m ³)
Germim	4.90	118.67
Mbushje	0.00	2.79

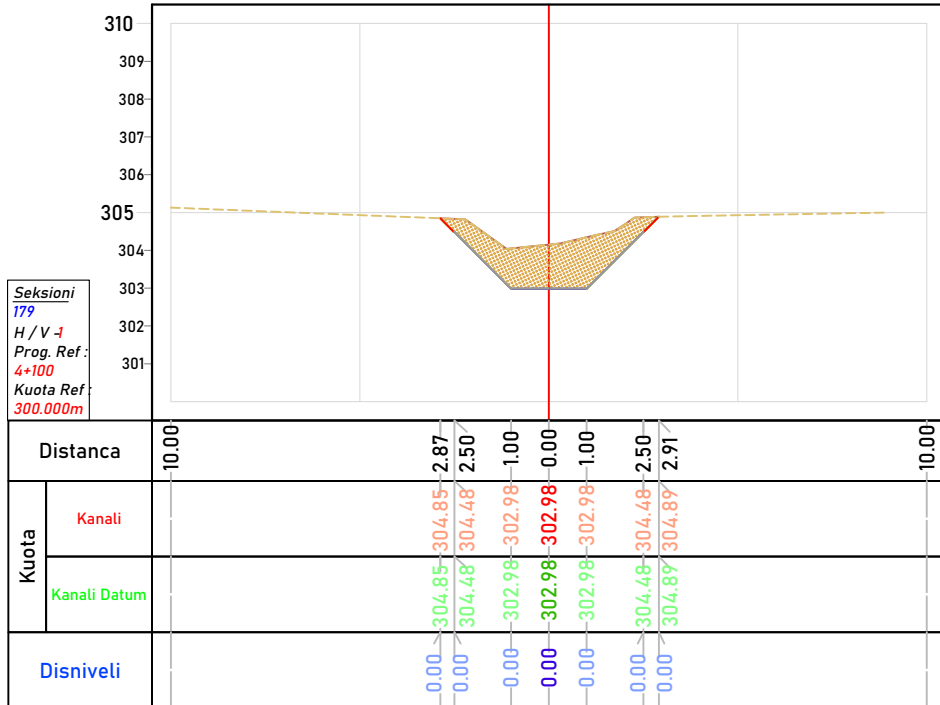

LEGJENDA

INVESTITOR



Bashkia
Kukës
Kryetar
z. Safet GJICI

PROJEKTUES

"MCE" SHPK
Nr.Licence N.6835/7



GRUPI I PROJEKTIMIT

Inxh. Hidroteknik	Nr. Liçensës
Petrit MUJA	K.0907/4
Inxh. Ndërtimi	Nr. Liçensës
Hekuran XHINA	K.0794/5
Inxh. Gjeodet	Nr. Liçensës
Fatos PELIVANI	T.1079/2
Inxh. Gjeolog	Nr. Liçensës
Hasan KULICI	GJ.0403/1
Inxh. Elektrik	Nr. Liçensës
Arben GABRAJ	E.1408/1
Inxh. Mjedisi	Nr. Liçensës
Aida BLIDO	M.1420/1
Inxh. Mekanik	Nr. Liçensës
Petro DONE	M.1419/1

Shkalla 1:200
Formati A3L Fleta Nr. 89
Data Maj / 2022 Tiranë

PROFILAT TERTHORE
SHENIME

Seksioni Nr. 182 Progressiva 4+129		
Emri	Siperfaqja (m ²)	Volumi (m ³)
Germim	5.34	0.00
Mbushje	0.02	0.00

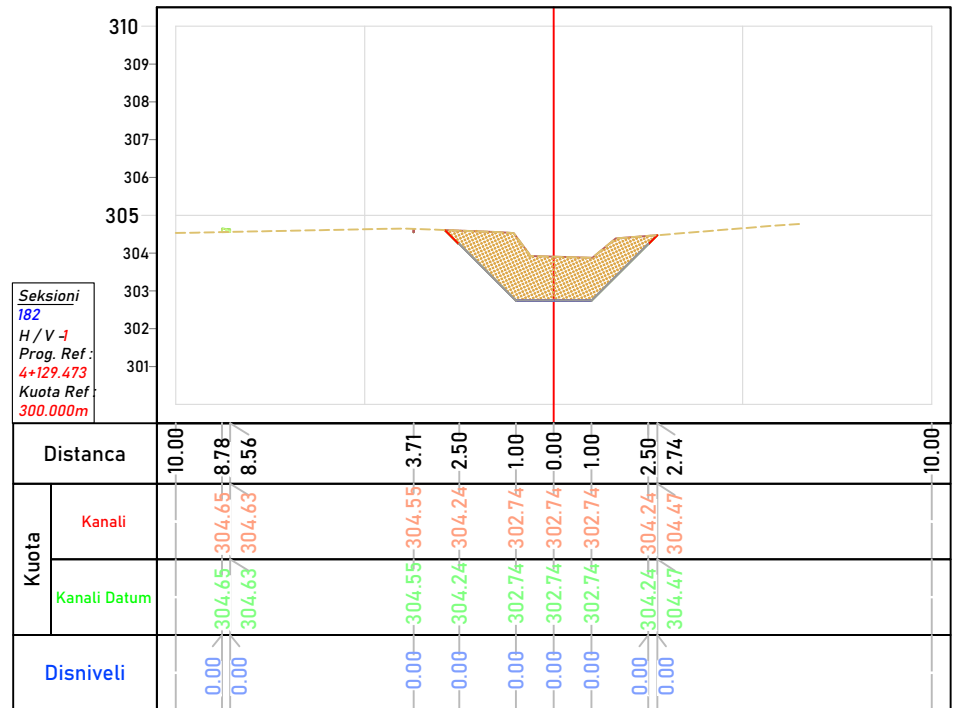

Seksioni Nr. 182 Progressiva 4+129		
Distanca	Kuota	Disniveli
10.00		
8.78	Kanali	0.00
8.56	Kanali	0.00
	Kanali Datum	
3.71		
2.50		
1.00		
0.00		
1.00		
2.50		
2.74		
10.00		

Seksioni Nr. 181 Progressiva 4+126		
Emri	Siperfaqja (m ²)	Volumi (m ³)
Germim	5.29	4.15
Mbushje	0.02	0.02

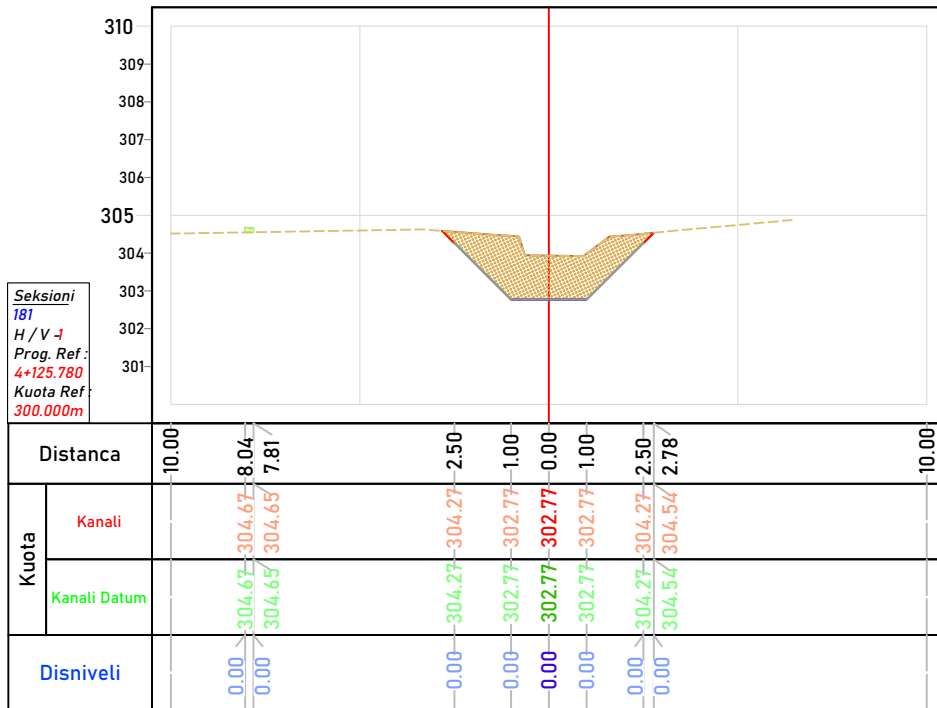

Seksioni Nr. 181 Progressiva 4+126		
Distanca	Kuota	Disniveli
10.00		
8.04	Kanali	0.00
7.81	Kanali	0.00
	Kanali Datum	
2.50		
1.00		
0.00		
1.00		
2.50		
2.78		
10.00		

Seksioni Nr. 184 Progressiva 4+175		
Emri	Siperfaqja (m ²)	Volumi (m ³)
Germim	5.21	134.51
Mbushje	0.00	0.13

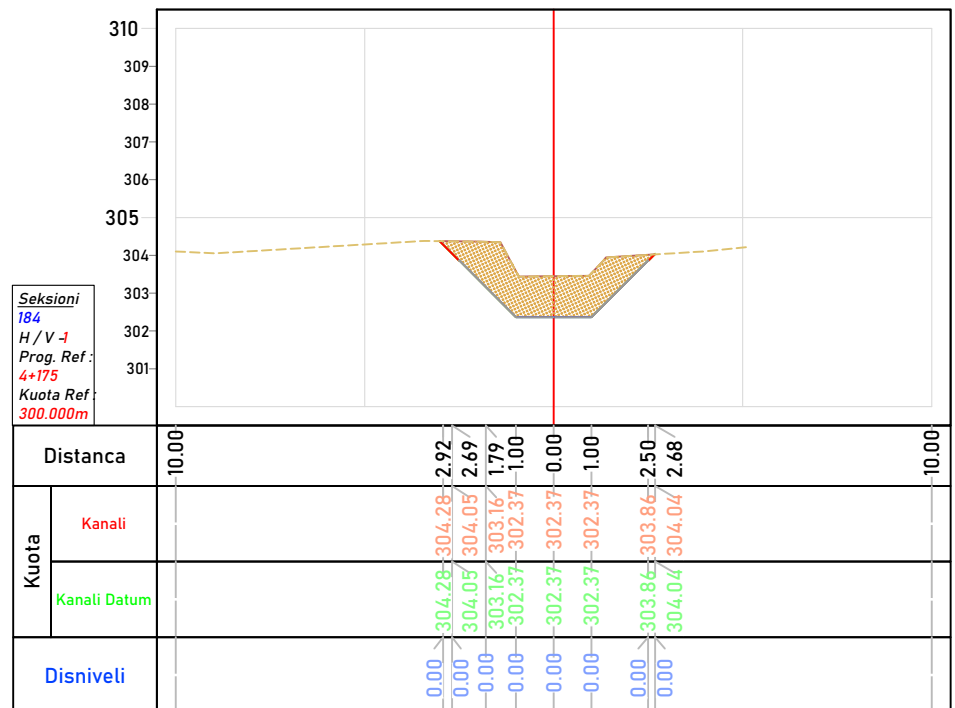

Seksioni Nr. 184 Progressiva 4+175		
Distanca	Kuota	Disniveli
10.00		
2.92	Kanali	0.00
2.69	Kanali	0.00
1.79	Kanali	0.00
1.00	Kanali	0.00
0.00	Kanali	0.00
1.00	Kanali	0.00
1.00	Kanali	0.00
2.50	Kanali	0.00
2.68	Kanali	0.00
10.00		

Seksioni Nr. 183 Progressiva 4+150		
Emri	Siperfaqja (m ²)	Volumi (m ³)
Germim	5.55	111.73
Mbushje	0.01	0.27

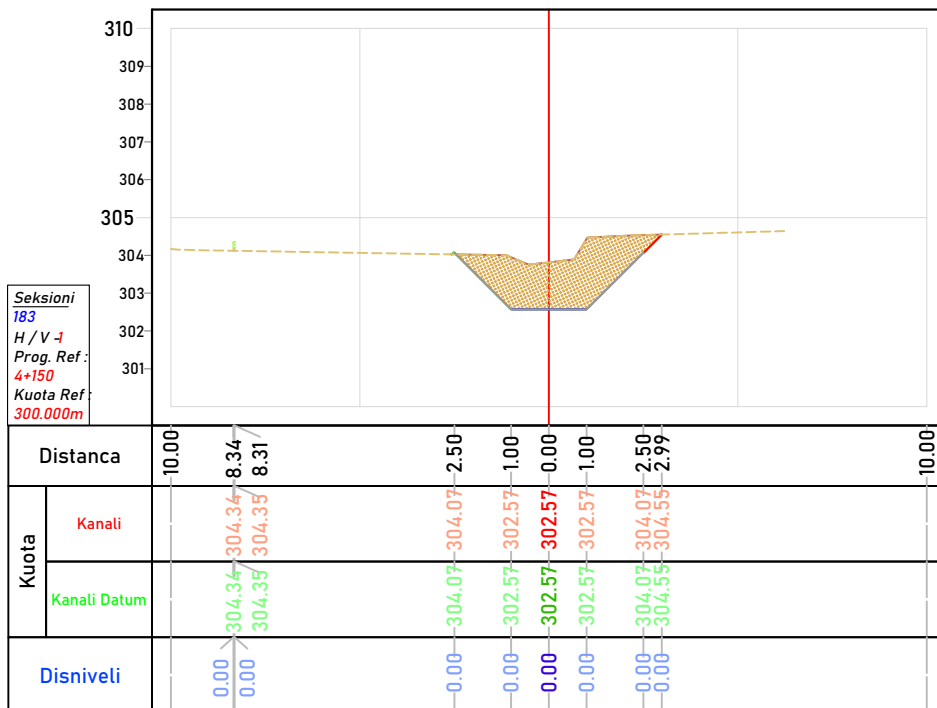

Seksioni Nr. 183 Progressiva 4+150		
Distanca	Kuota	Disniveli
10.00		
8.34	Kanali	0.00
8.31	Kanali	0.00
	Kanali Datum	
2.50		
1.00		
0.00		
1.00		
2.50		
2.99		
10.00		

LEGJENDA

INVESTITOR

Bashkia
Kukës
Kryetar
z. Safet GJICI

PROJEKTUES

"MCE" SHPK Nr.Licence N.6835/7	
-----------------------------------	--

GRUPI I PROJEKTIMIT

Inxh. Hidroteknik	Nr. Liçensës
Petrit MUJA	K.0907/4
Inxh. Ndërtimi	Nr. Liçensës
Hekuran XHINA	K.0794/5
Inxh. Gjeodet	Nr. Liçensës
Fatos PELIVANI	T.1079/2
Inxh. Gjeolog	Nr. Liçensës
Hasan KULIC	GJ.0403/1
Inxh. Elektrik	Nr. Liçensës
Arben GABRAJ	E.1408/1
Inxh. Mjedisi	Nr. Liçensës
Aida BLIDO	M.1420/1
Inxh. Mekanik	Nr. Liçensës
Petro DONE	M.1419/1
Shkalla	1:200
Formati	A3L
Data	Maj / 2022
	Tiranë

PROFILAT TERTHORE
SHENIME

LEGJENDA

INVESTITOR



Bashkia
Kukës
Kryetar
z. Safet GJICI

PROJEKTUES

"MCE" SHPK
Nr.Licence N.6835/7



GRUPI I PROJEKTIMIT

Inxh. Hidroteknik	Nr. Liçensës
Petrit MUJA	K.0907/4
Inxh. Ndërtimi	Nr. Liçensës
Hekuran XHINA	K.0794/5
Inxh. Gjeodet	Nr. Liçensës
Fatos PELIVANI	T.1079/2
Inxh. Gjeolog	Nr. Liçensës
Hasan KULICI	GJ.0403/1
Inxh. Elektrik	Nr. Liçensës
Arben GABRAJ	E.1408/1
Inxh. Mjedis	Nr. Liçensës
Aida BLIDO	M.1420/1
Inxh. Mekanik	Nr. Liçensës
Petro DONE	M.1419/1
Shkalla	1:200
Formati	A3L
Data	Maj / 2022
	Fleta Nr. 92
	Tiranë

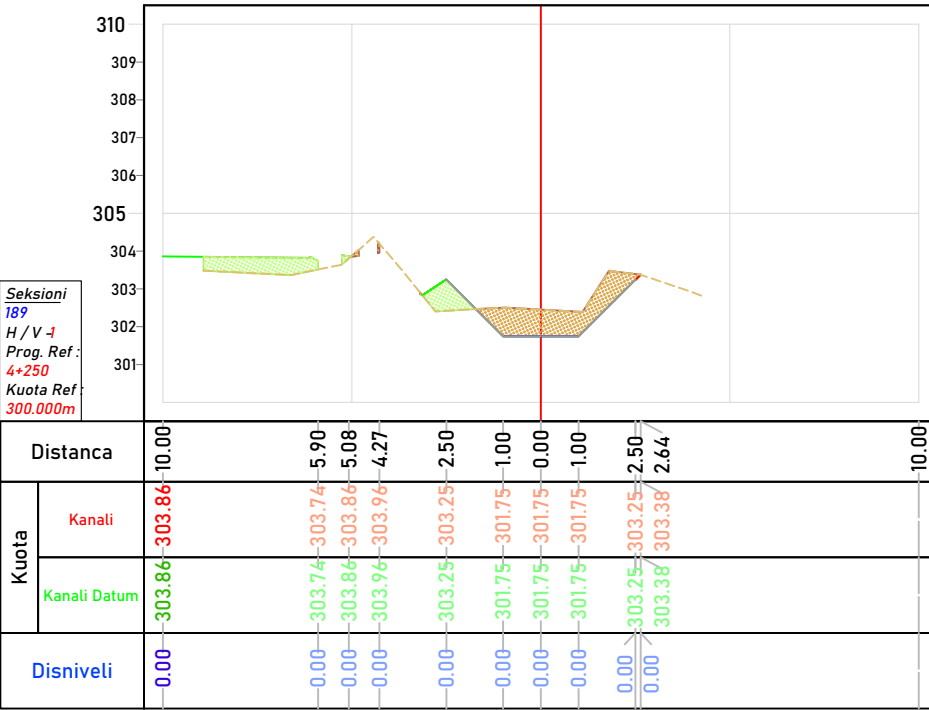

Seksioni Nr. 189 Progresiva 4+250		
Emri	Siperfaqja (m²)	Volumi (m³)
Germim	2.67	83.69
Mbushje	1.90	36.08

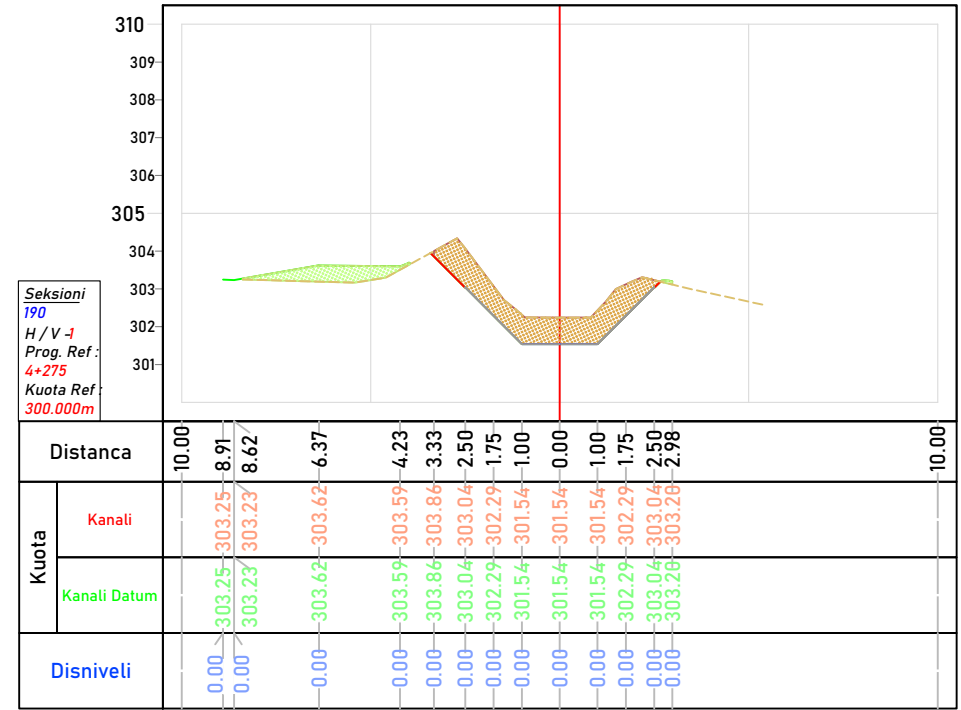

Seksioni Nr. 190 Progresiva 4+275		
Emri	Siperfaqja (m²)	Volumi (m³)
Germim	4.39	88.18
Mbushje	1.29	37.95

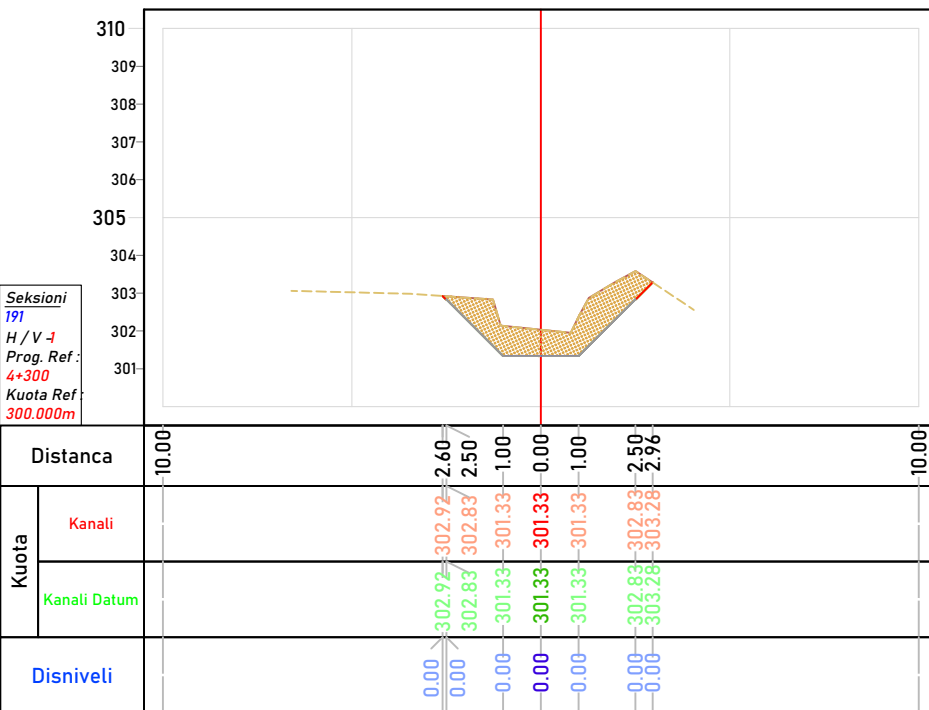

Seksioni Nr. 191 Progresiva 4+300		
Emri	Siperfaqja (m²)	Volumi (m³)
Germim	4.24	107.95
Mbushje	0.00	16.93

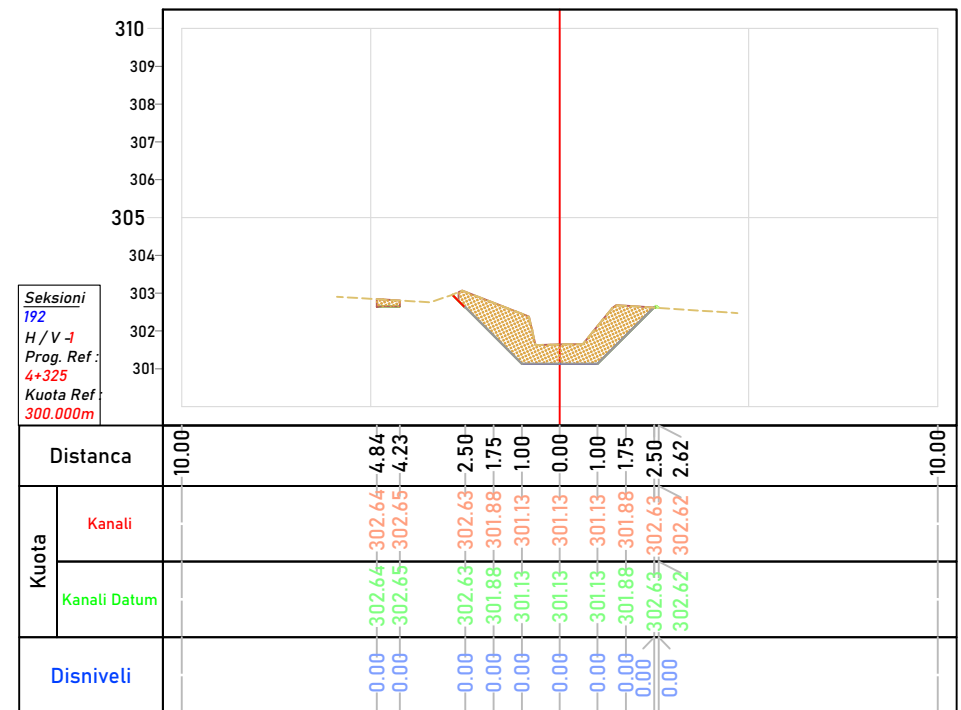

Seksioni Nr. 192 Progresiva 4+325		
Emri	Siperfaqja (m²)	Volumi (m³)
Germim	3.85	101.08
Mbushje	0.00	0.04

URE KALIMI TIP HD=2.2 M DHE PROFILAT TIP TE GERMIMIT

PROFILAT TERTHORE
SHENIME

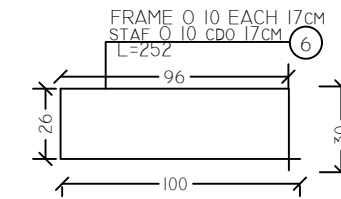
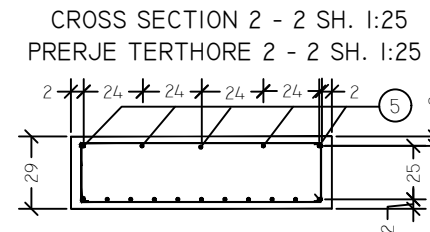
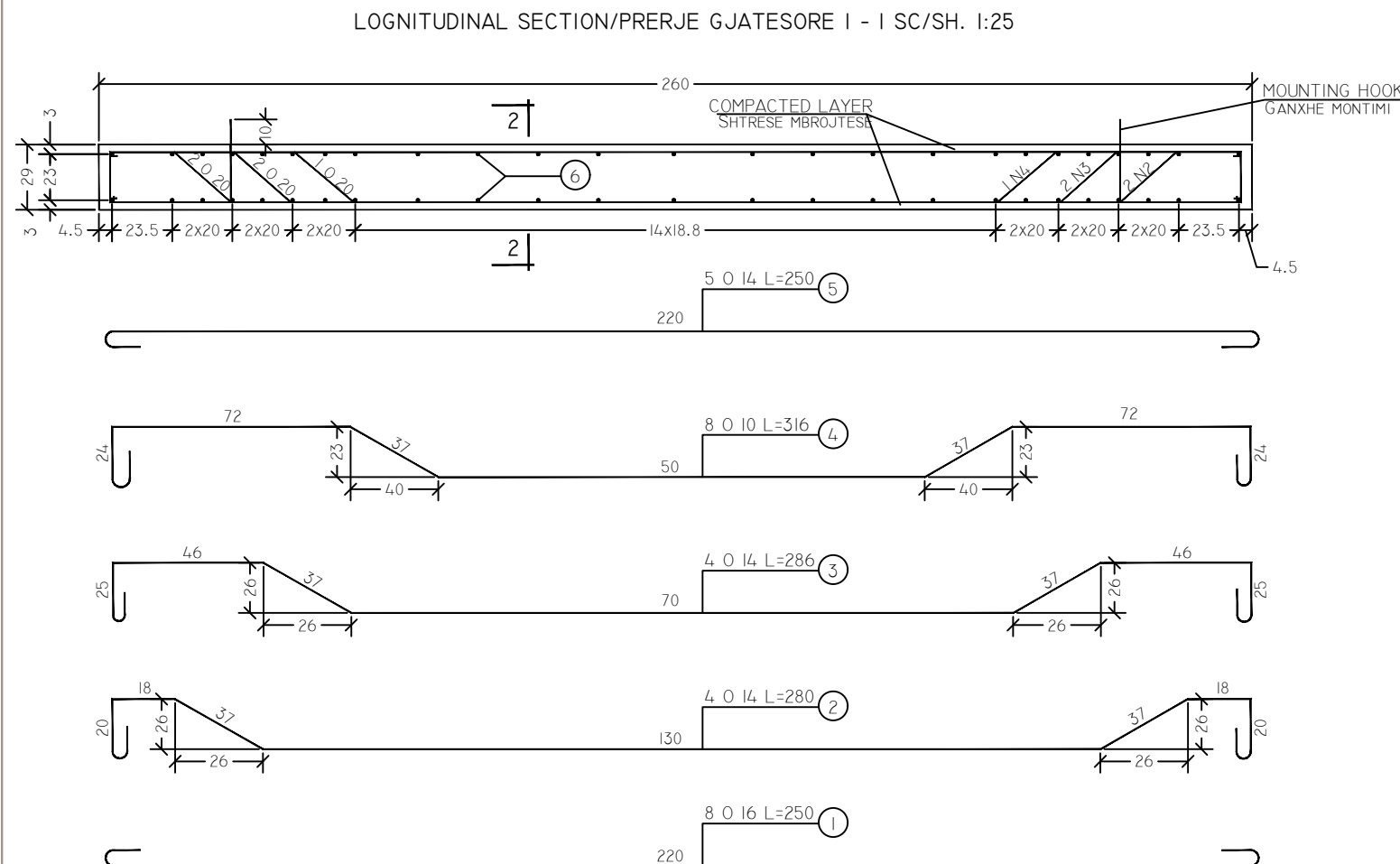
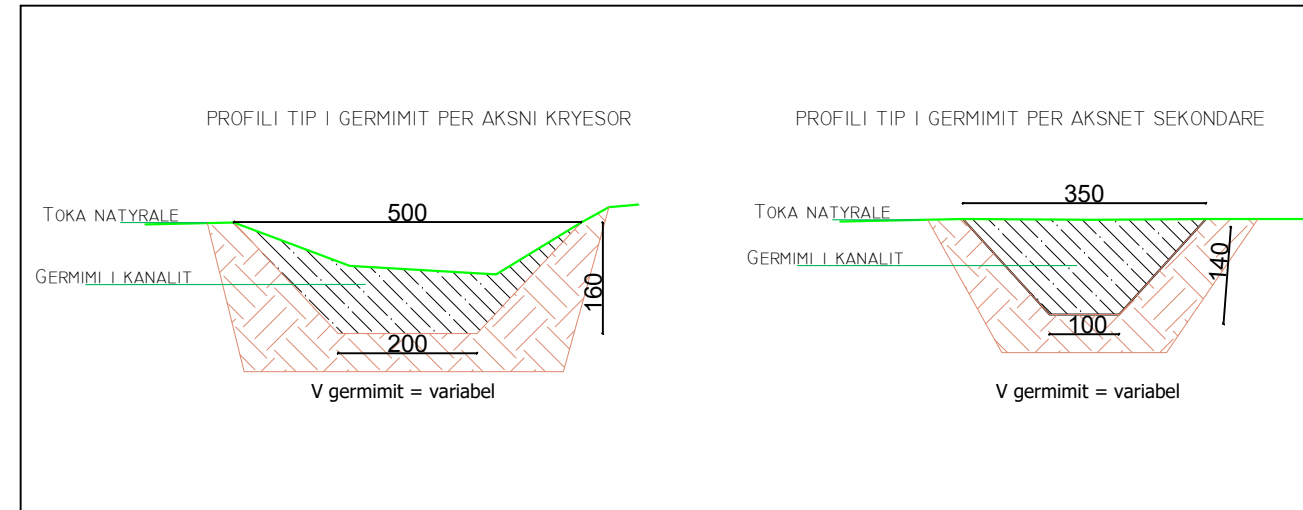
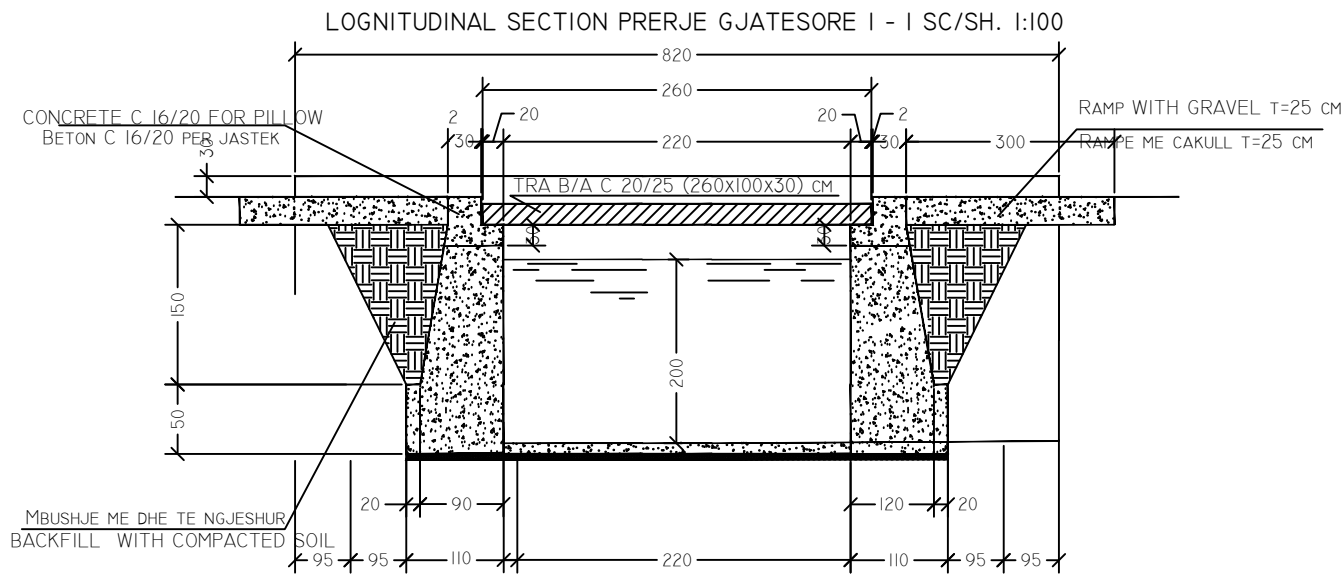

IRON TABLE FOR ONE ELEMENT
TABELA E HEKURAVE PER NJE ELEMENT

POZIC.	DIAMETRI Ø MM	GJATESIA CM	SASIA COPE	GJATESIA TOTALE(M)	PESHA KG/M	PESHA KG
1	16	250	8	20.00	1.567	31.34
2	14	280	4	11.20	1.200	13.44
3	14	286	4	11.44	1.200	13.73
4	10	316	8	25.28	0.612	15.47
5	14	250	4	10.00	1.200	12.00
6	10	252	5	12.60	0.612	7.71

TOTALI KG 93.69

N.R	An-4 NR.AN.	Ure kalimi betoni per Makina , 1 Cope HD 2.2m x 4m qjeresi	NJES	SASIA
1	3.25/b	Germim dhe tok e zakonshme	m3	40.00
2	3.47/c	Mbushje me dhe	m3	16.00
3	3.183/c	Shtrese zhavorri nen beton t = 20 cm	m3	12.00
4	3.243	Beton C 16/20 per muret	m3	17.00
5	3.244/1	Struktura te holla monolite betoni C 20/2	m3	14.00
6	3.287	F V hekur betoni i zakonshem Ø 6 ~ 10mm	ton	0.10
7	3.288	F V hekur betoni i zakonshem Ø > 12mm	ton	0.35

LEGJENDA

INVESTITOR



Bashkia
Kukës
Kryetar
z. Safet GJICI

PROJEKTUES

"MCE" SHPK
Nr.Licence N.6835/7



GRUPI I PROJEKTIMIT

Inxh. Hidroteknik	Nr. Licensës
Petrit MUJA	K.0907/4
Inxh. Ndërtimi	Nr. Licensës
Hekuran XHINA	K.0794/5
Inxh. Gjeodet	Nr. Licensës
Fatos PELIVANI	T.1079/2
Inxh. Gjeolog	Nr. Licensës
Hasan KULICI	GJ.0403/1
Inxh. Elektrik	Nr. Licensës
Arben GABRAJ	E.1408/1
Inxh. Mjedisi	Nr. Licensës
Aida BLIDO	M.1420/1
Inxh. Mekanik	Nr. Licensës
Petro DONE	M.1419/1
Shkalla	Custom
Formati	A3L
Data	Maj / 2022
Fleta Nr.	96
Tiranë	



BASHKIA KUKËS



REPUBLIKA E SHQIPËRISË

PROJEKTUES	VULA	PROFILI GJATESOR I PROJEKTIT	GRUPI I PROJEKTIMIT			
" MCE" SHPK Nr.Licence N.6835/7 			"RIKONSTRUKSIONI I KANALIT KULLUES SHTIQEN, NJ.A SHTIQEN, BASHKIA KUKES"	<i>Inxh. Hidroteknik</i>	<i>Nr. Liçensës</i>	<i>Inxh. Mjedisi</i>
			Petrit MUJA	K.0907/4	Aida BLIDO	M.1420/1
			<i>Inxh. Ndërtimi</i>	<i>Nr. Liçensës</i>	<i>Inxh. Mekanik</i>	<i>Nr. Liçensës</i>
			Hekuran XHINA	K.0794/5	Petro DONE	M.1419/1
			<i>Inxh. Gjeodet</i>	<i>Nr. Liçensës</i>		
			Fatos PELIVANI	T.1079/2		
			<i>Inxh. Gjeolog</i>	<i>Nr. Liçensës</i>		
			Hasan KULICI	GJ.0403/1		
			<i>Inxh. Elektrik</i>	<i>Nr. Liçensës</i>		
			Arben GABRAJ	E.1408/1		



BASHKIA KUKËS



REPUBLIKA E SHQIPËRISË

PROJEKTUES	VULA	PROFILAT TERTHORE TE PROJEKTIT	GRUPI I PROJEKTIMIT			
" MCE" SHPK Nr.Licence N.6835/7 			"RIKONSTRUKSIONI I KANALIT KULLUES SHTIQEN, NJ.A SHTIQEN, BASHKIA KUKES"	<i>Inxh. Hidroteknik</i>	<i>Nr. Liçensës</i>	<i>Inxh. Mjedisi</i>
			Petrit MUJA	K.0907/4	Aida BLIDO	M.1420/1
			<i>Inxh. Ndërtimi</i>	<i>Nr. Liçensës</i>	<i>Inxh. Mekanik</i>	<i>Nr. Liçensës</i>
			Hekuran XHINA	K.0794/5	Petro DONE	M.1419/1
			<i>Inxh. Gjeodet</i>	<i>Nr. Liçensës</i>		
			Fatos PELIVANI	T.1079/2		
			<i>Inxh. Gjeolog</i>	<i>Nr. Liçensës</i>		
			Hasan KULICI	GJ.0403/1		
			<i>Inxh. Elektrik</i>	<i>Nr. Liçensës</i>		
			Arben GABRAJ	E.1408/1		