

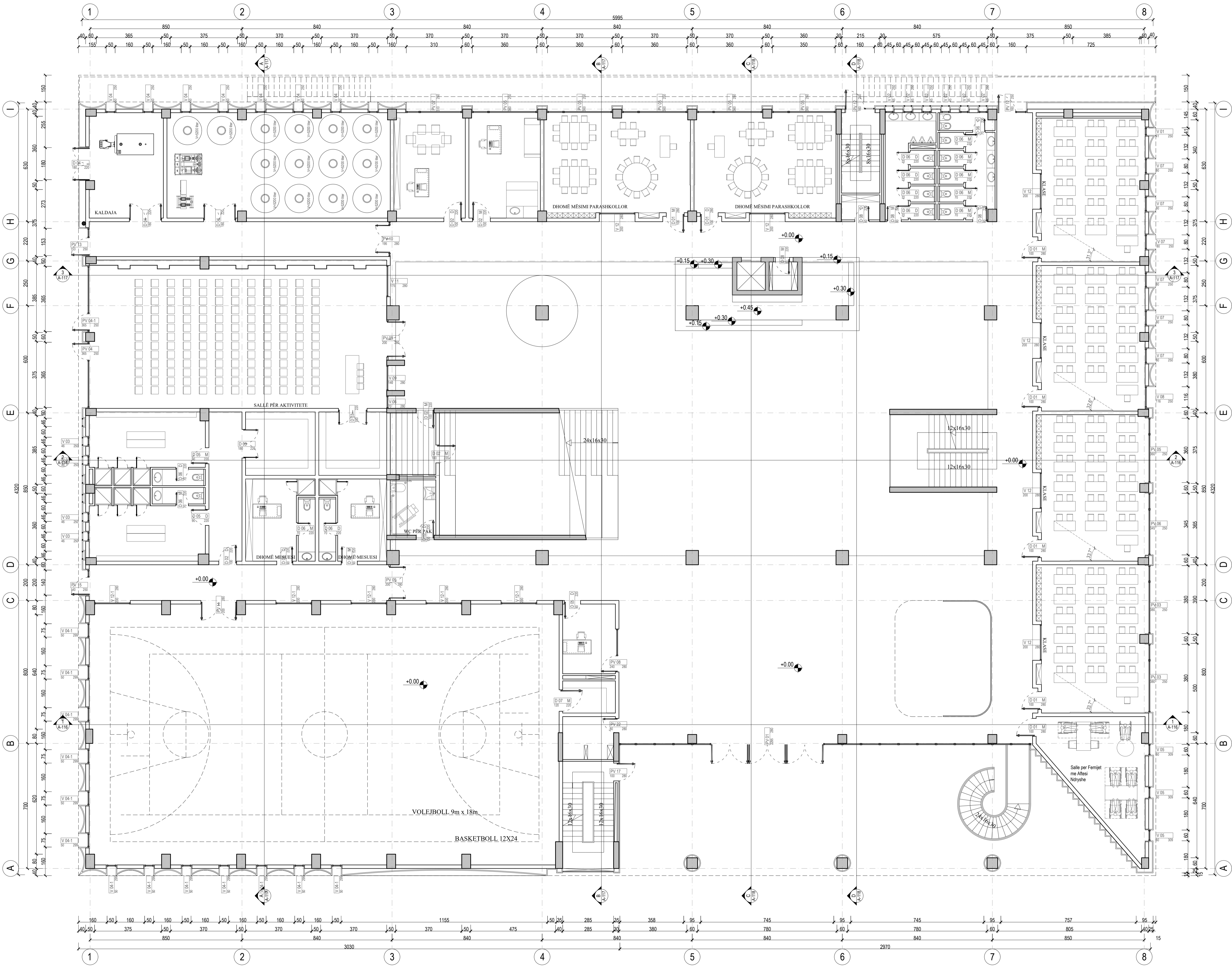

PROJEKTI ARKITEKTONIK

**NDËRTIM I SHKOLLËS 9-VJECARE NË RR. " MUHARREM CAUSHI", NJËSIA STRUKTUREORE KA/253
Tiranë - Shqipëri**

AUTOR I PROJEKTIT

"SPHAERA" sh.p.k



"SPHAERA" sh.p.k
 PROJEKTIM
 SUPERVIZION
 KOLAUDIM
 Rruga "QAZIM VATHI" nr 106 Tirane
 Mobil 00355 69 20 38 848
 e-mail: ajkidtopore@yahoo.com
 e-mail: ajkidtopore@sphaera.al



AUTORITETI KONTRAKTOR
BASHKIA TIRANË

"Ndërtim i shkollës 9 vjeçare, ne Rr. "Muharrem Caushi", Njesia Strukturore KA/253".

Sektori: _____

Titulli i vizatimit:
PLANI I KATIT PERDHE (Mobilimi)

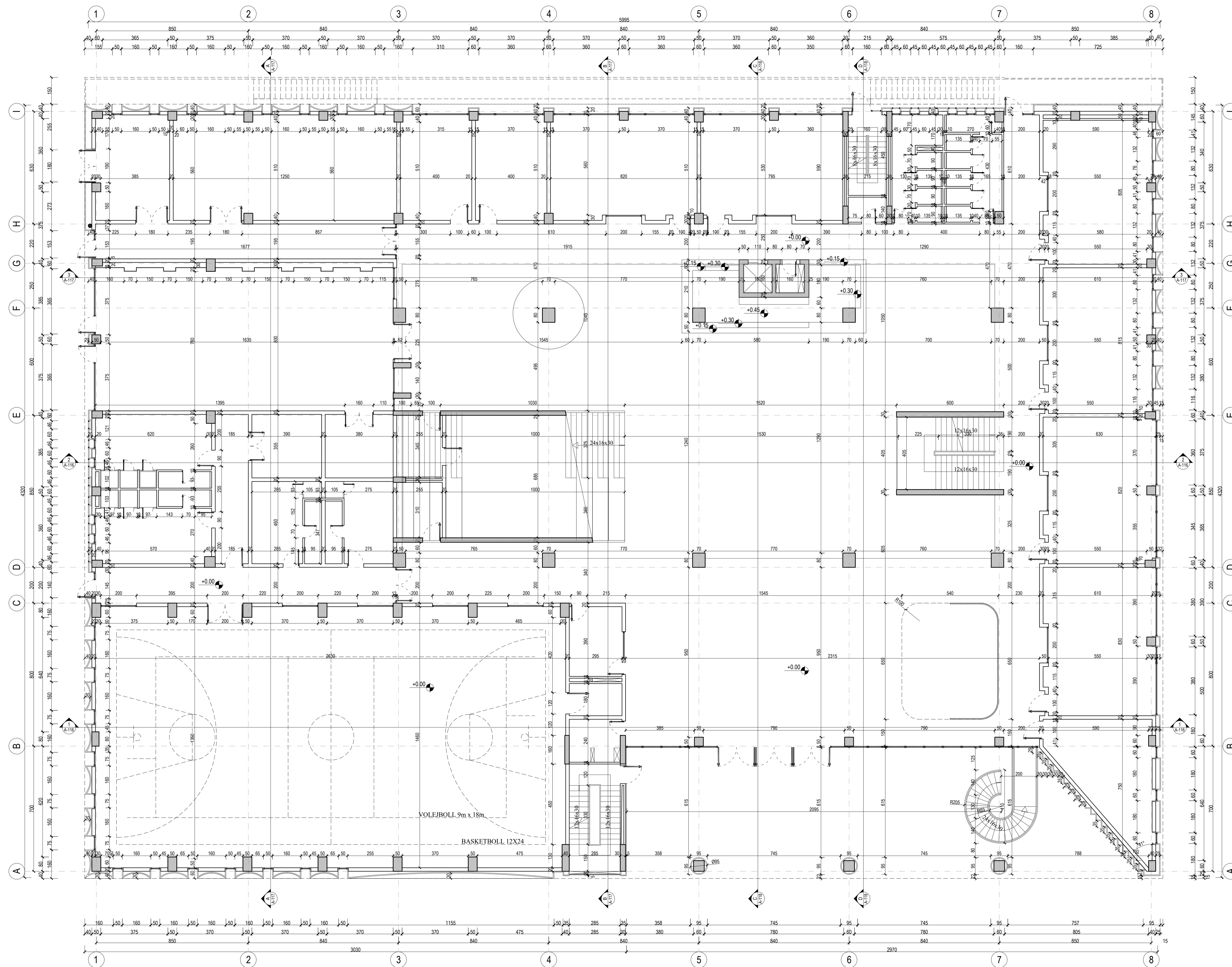
Faza e Projektit: PROJEKT ZBATIMI	Data: Prill 2023	GRUP I PROJEKTIMIT: Inzh. AJKID TOPORE Ark. KETIMA GEGA Inzh. DHIMTR PAPA Inzh. MARO FISHTA	FINAN: Inzh. NIKOLIN RISILIA Inzh. ANUR DADO	FINAN:
Nr i Vizimit: A-101	Shkala: 1:100			



Shenime:

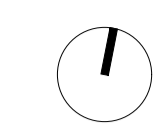

"SPHAERA" sh.p.k
 PROJEKTIM
 SUPERVIZION
 KOLAUDIM
 Rruga "QAZIM VATHI" nr 106 Tirane
 Mobil 00355 69 20 38 848
 e-mail: ajkidtopore@yahoo.com
 e-mail: ajkidtopore@sphaera.al

AUTORITETI KONTRAKTOR
BASHKIA TIRANË

"Ndërtim i shkollës 9 vjeçare, ne Rr. "Muharrem Caushi", Njesia Strukturore KA/253".

Sekcioni:

Titulli i vizatimit:

PLANI I KATIT PERDHE
(Dimensionimi)

Faza e Projektit	Data	Grupi i Projektimit	Financa	Financa
PROJEKT ZBATIMI	Prill 2023	Inzh. Ajkide TOPORE	Inzh. Nikolin RISILIA	
Nr i Vizimit	Shkalla	Ark. Kelmira GEGA	Inzh. Artur DADO	
A-102	1:100	Inzh. Dhimitër PAPA	Inzh. Mario FISHTA	

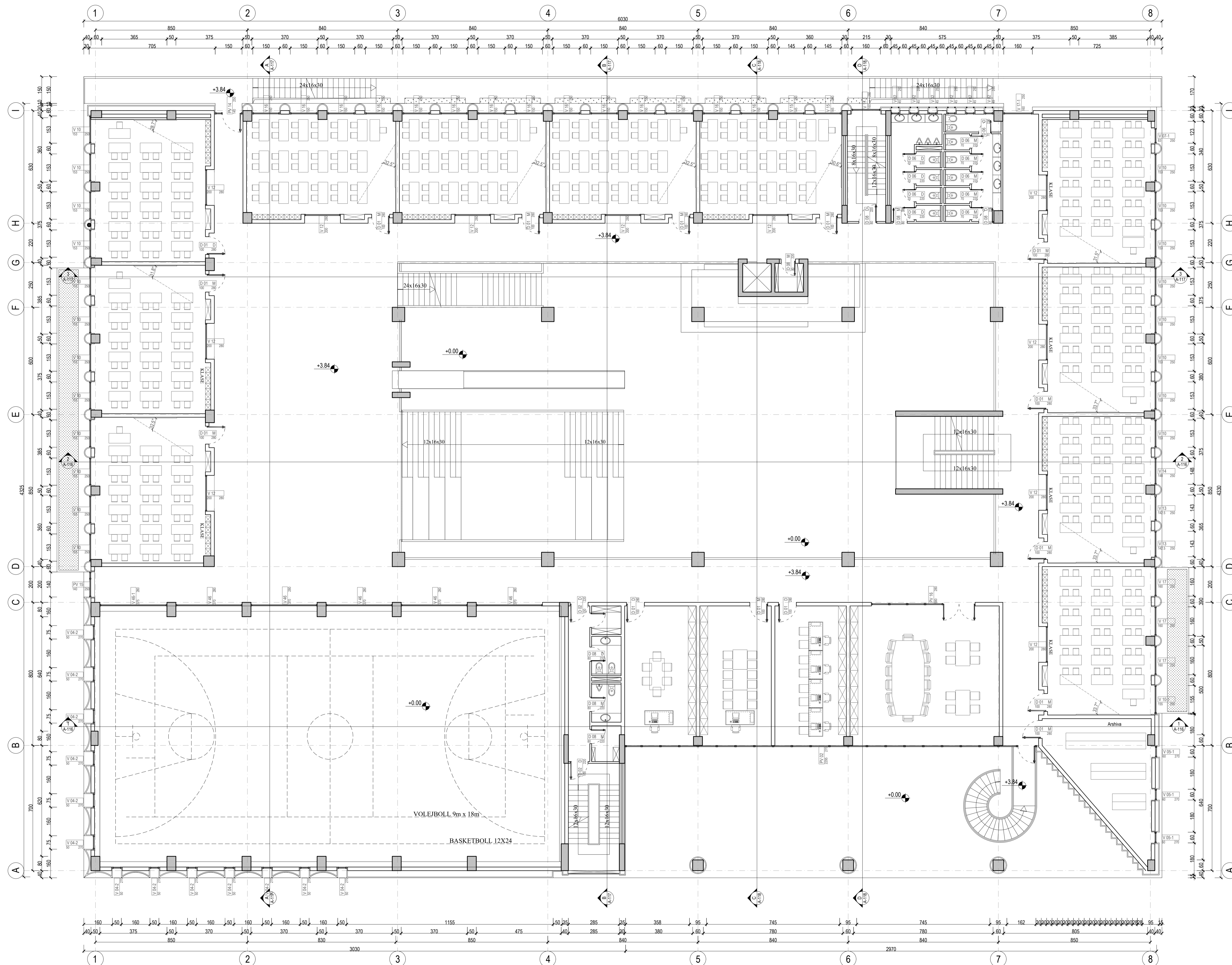
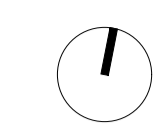

Rruga "QAZIM VATHI" nr 106 Tirane
Mobil 00355 69 20 38 848

e-mail: ajkidtopore@yahoo.com
e-mail: ajkidtopore@sphaera.al



**AUTORITETI KONTRAKTOR
BASHKIA TIRANË**

**"Ndërtim i shkollës 9 vjeçare, ne Rr. "Muharrem
Caushi", Njesia Strukturore KA/253".**

Sektori:

Titulli i vizatimit:
**PLANI I KATIT TE PARE
(Mobilimi)**

Faza e Projektit	Data	Grupi i Projektimit	Firma	Firma
PROJEKTIM ZBATIM	Prill 2023	Inzh. Ajkide TOPORE	Inzh. Nikolin RISILIA	
Nr. i Vizimit	Shkala	Inzh. Ketiha GEGA	Inzh. Artur DADO	
A-103	1:100	Inzh. Dhimitër PAPA	Inzh. Mario FISHTA	

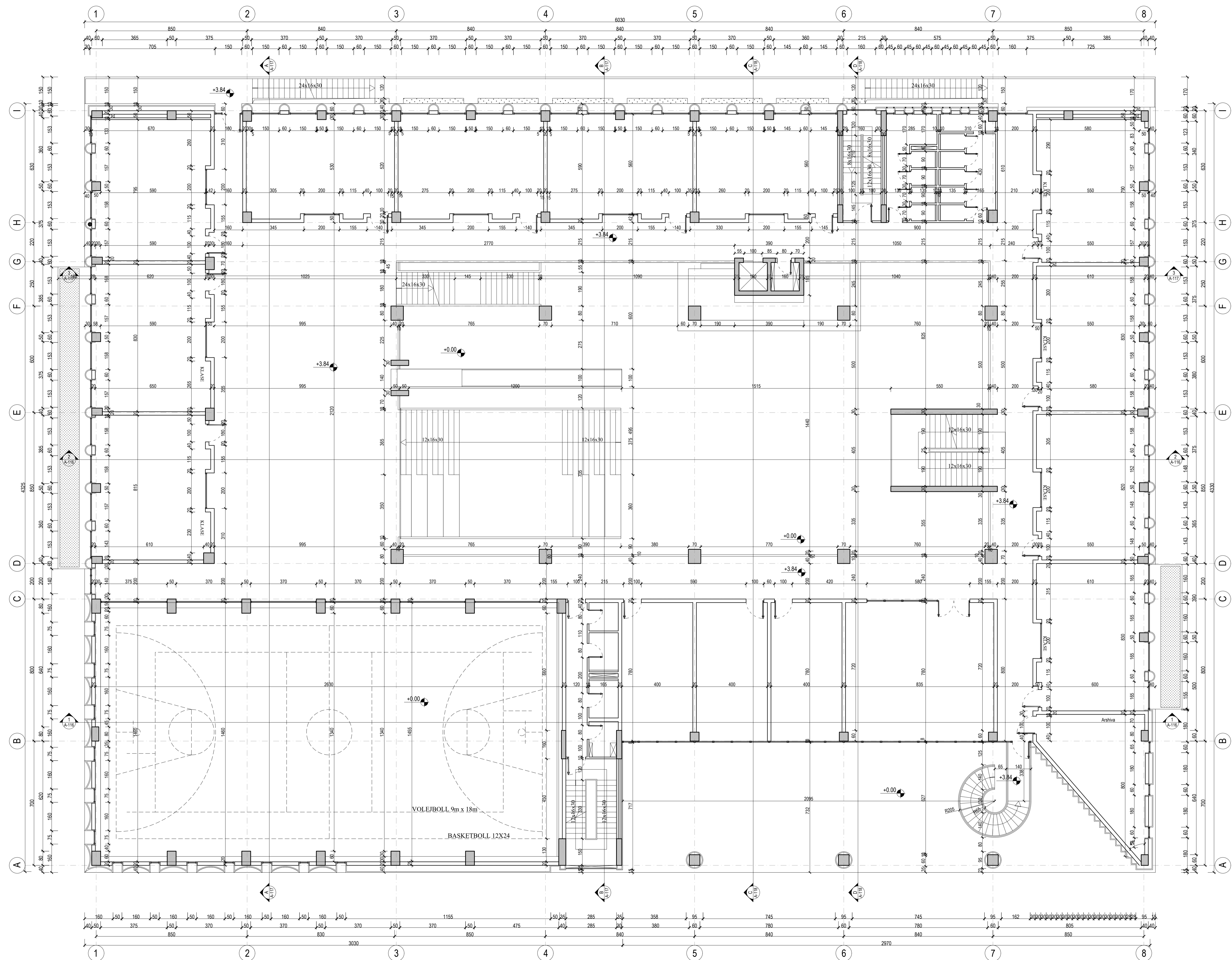
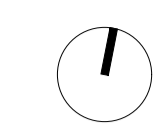

Rruga "QAZIM VATHI" nr 106 Tirane
 Mobil 00355 69 20 38 848
 e-mail: ajkidtopore@yahoo.com
 e-mail: ajkidtopore@sphaera.al



**AUTORITETI KONTRAKTOR
 BASHKIA TIRANË**

**"Ndërtim i shkollës 9 vjeçare, ne Rr. "Muharrem
 Caushi", Njesia Strukturore KA/253".**

Sektori:

Titulli i vizatimit:
**PLANI I KATIT TE PARE
 (Dimensionimi)**

Faza e Projektit	Data	Grupi i Projektimit	Firma	Firma
PROJEKT ZBATIMI	Prill 2023	Inzh. AJKID TOPORE	Inzh. NIKOLIN RISILIA	
Nr i Vizimit	Shkala	Ark. KETIMA GEGA	Inzh. ANTO DADO	
A-104	1:100	Inzh. DHIMITER PAPA	Inzh. MARIO FISHTA	

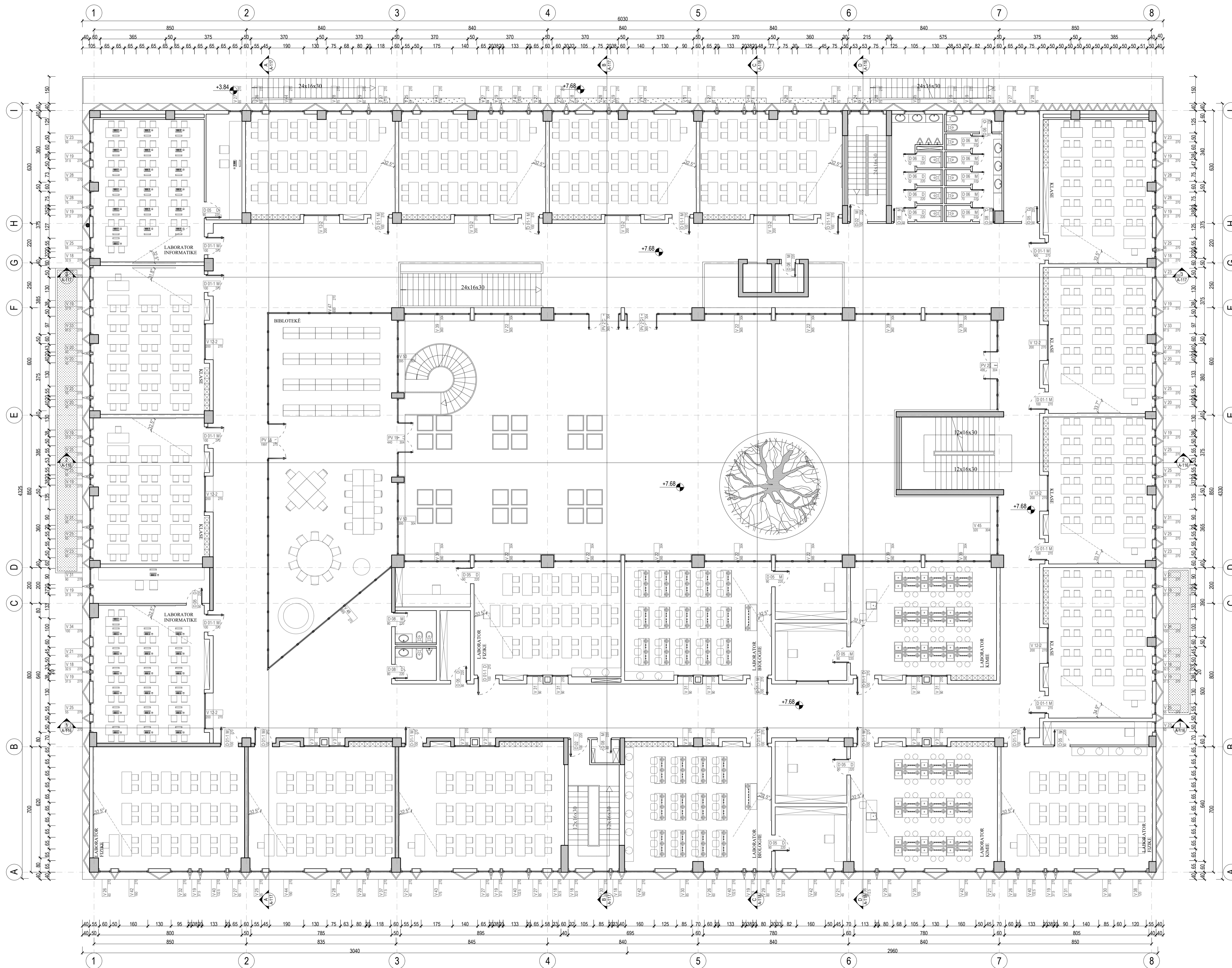
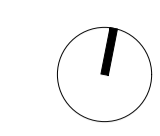

"SPHAERA" sh.p.k.
 PROJEKTIM
 SUPERVIZION
 KOLAUDIM
 Rruga "QAZIM VATHI" nr 106 Tirane
 Mobil 00355 69 20 38 848
 e-mail: ajkidtopore@yahoo.com
 e-mail: ajkidtopore@sphaera.al

AUTORITETI KONTRAKTOR
BASHKIA TIRANË

"Ndertim i shkolles 9 vjeçare, ne Rr. "Muharrem Caushi", Njesia Strukturore KA/253".

Sekcioni:

Titulli i vizatimit:

PLANI I KATIT TE DYTE
(Mobilimi)

Faza e Projektit	Data	GRUPI PROJEKTIMTAR	FIRMA	FIRMA
PROJEKT ZBATIMI	Prill 2023	Inzh. AJKID TOPORE	Inzh. NIKOLIN RISILIA	
Nr. i Vizimit	Shkala	Ark. KETIMA GEGA	Inzh. ANTUR DADO	
A-105	1:100	Inzh. DHIMITRI PAPA	Inzh. MARO FISHTA	

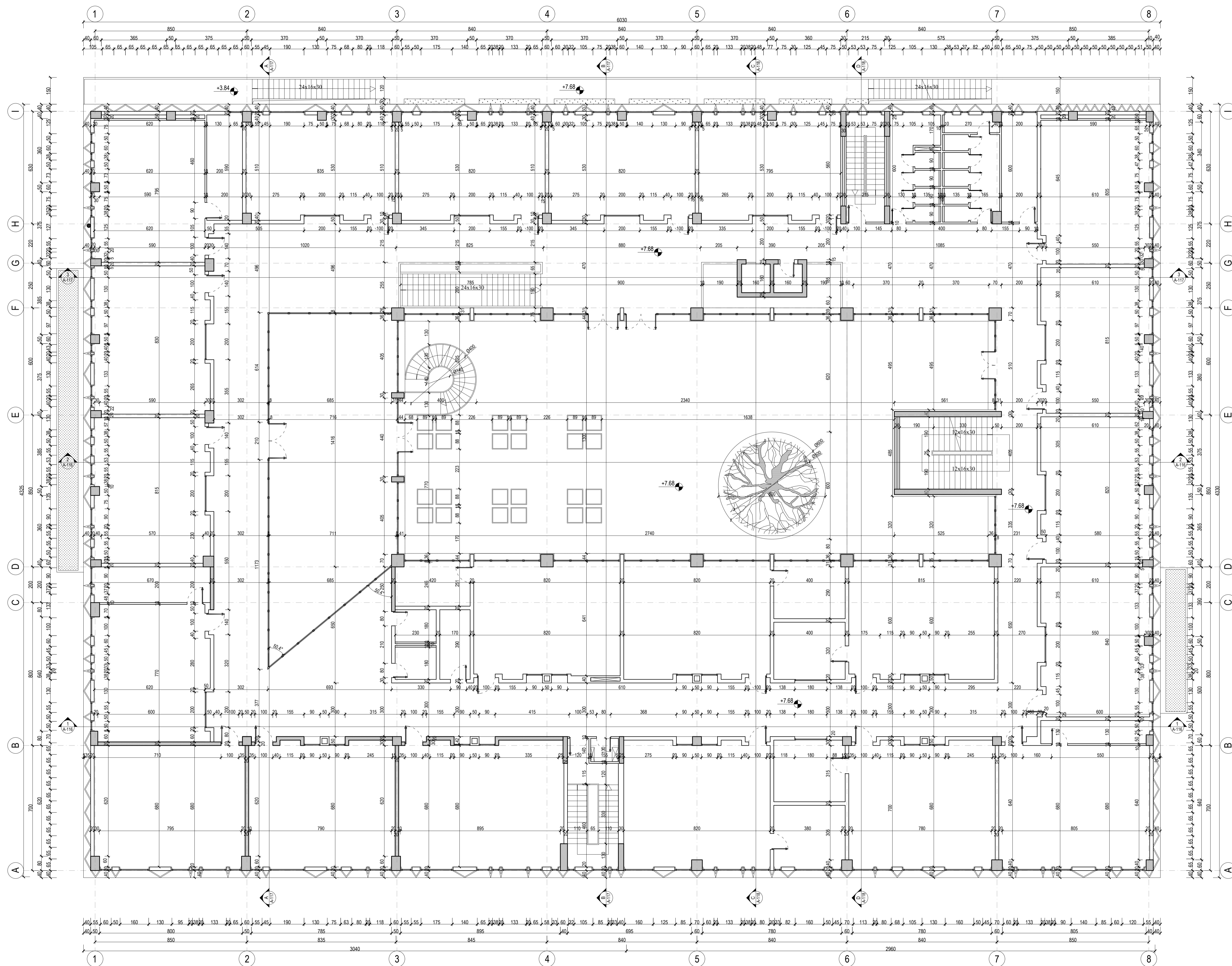
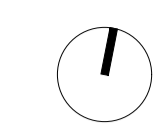

Rruga "QAZIM VATHI" nr 106 Tirane
 Mobil 00355 69 20 38 848
 e-mail: ajkidtopore@yahoo.com
 e-mail: ajkidtopore@sphaera.al

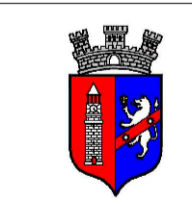

**AUTORITETI KONTRAKTOR
 BASHKIA TIRANË**

**"Ndërtim i shkollës 9 vjeçare, ne Rr. "Muharrem
 Caushi", Njesia Strukturore KA/253".**

Sekcioni:

Titulli i vizatimit:
**PLANI I KATIT TE DYTE
 (Dimensionimi)**

Faza e Projektit	Data	Shteti i Projektimit	Firma	Firma
PROJEKT ZBATIMI	Prill 2023	Inzh. Ajkide TOPORE	Inzh. Nikolin RISILIA	
Nr. i Vizatimit	Shkala	Inzh. Keltina GEGA	Inzh. Artur DADO	
A-106	1:100	Inzh. Dhimitër PAPA	Inzh. Mario FISHTA	

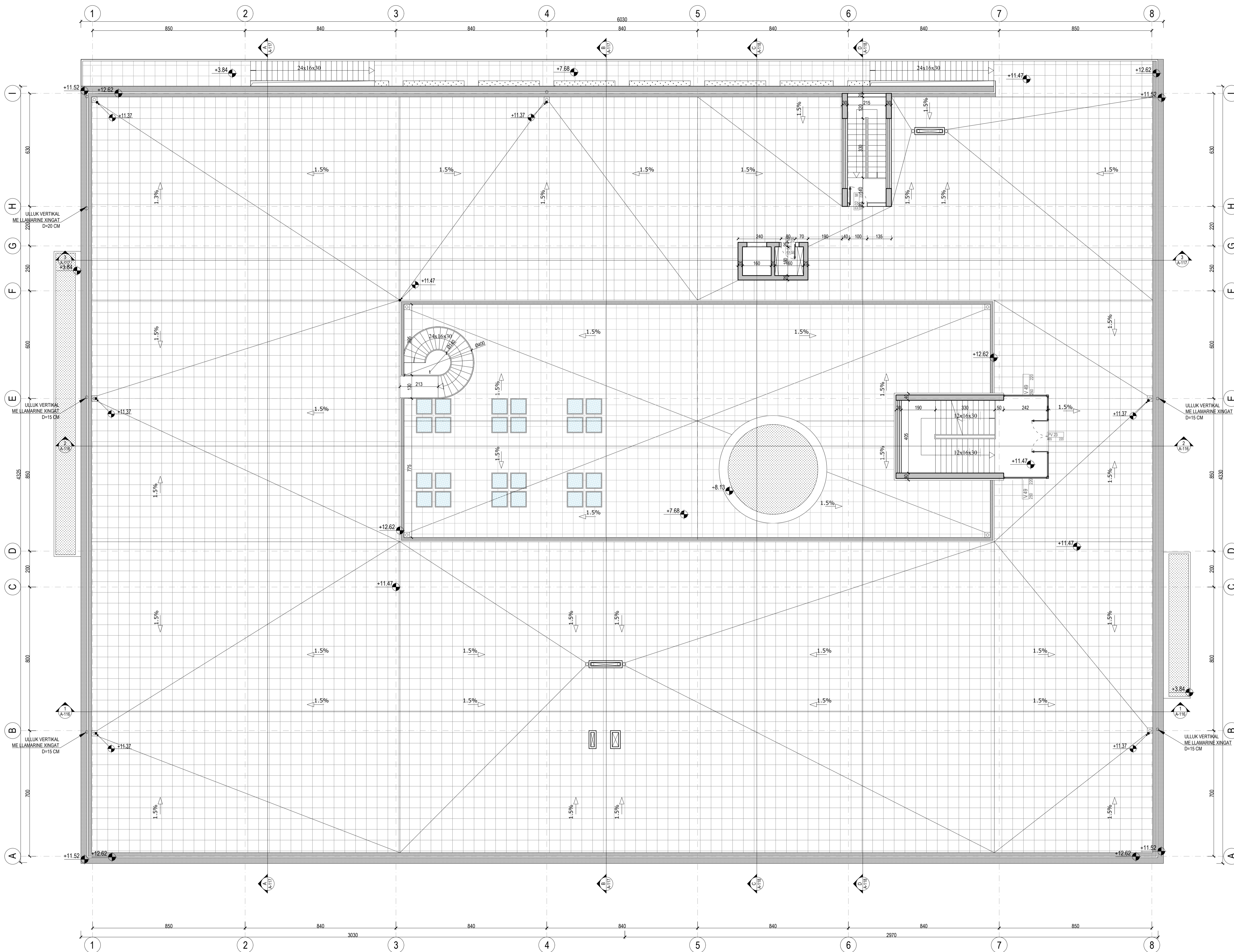

Rruga "QAZIM VATHI" nr 106 Tirane
 Mobil 00355 69 20 38 848
 e-mail: ajk@topore@yahoo.com
 e-mail: ajk@topore@sphaera.al

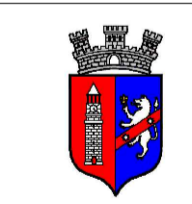

**AUTORITETI KONTRAKTOR
 BASHKIA TIRANË**

**"Nderim i shkolles 9 vjeçare, ne Rr. "Muharrem
 Caushi", Njesia Strukturore KA/253".**

Sektori:

Titulli i vizatimit:
PLANI I TERRACES

Faza e Projektit	Dati	Grupi i Projektimit	Firma	Firma
PROJEKT ZBATIMI	Prill 2023	Inzh. Ajkë TOPORE	Inzh. Nikolin RISILIA	
Nr. i Vizimit	Shkala	Inzh. Dhimitër PAPA	Inzh. Artur DADO	
A-107	1:100	Inzh. Mario FISHTA		

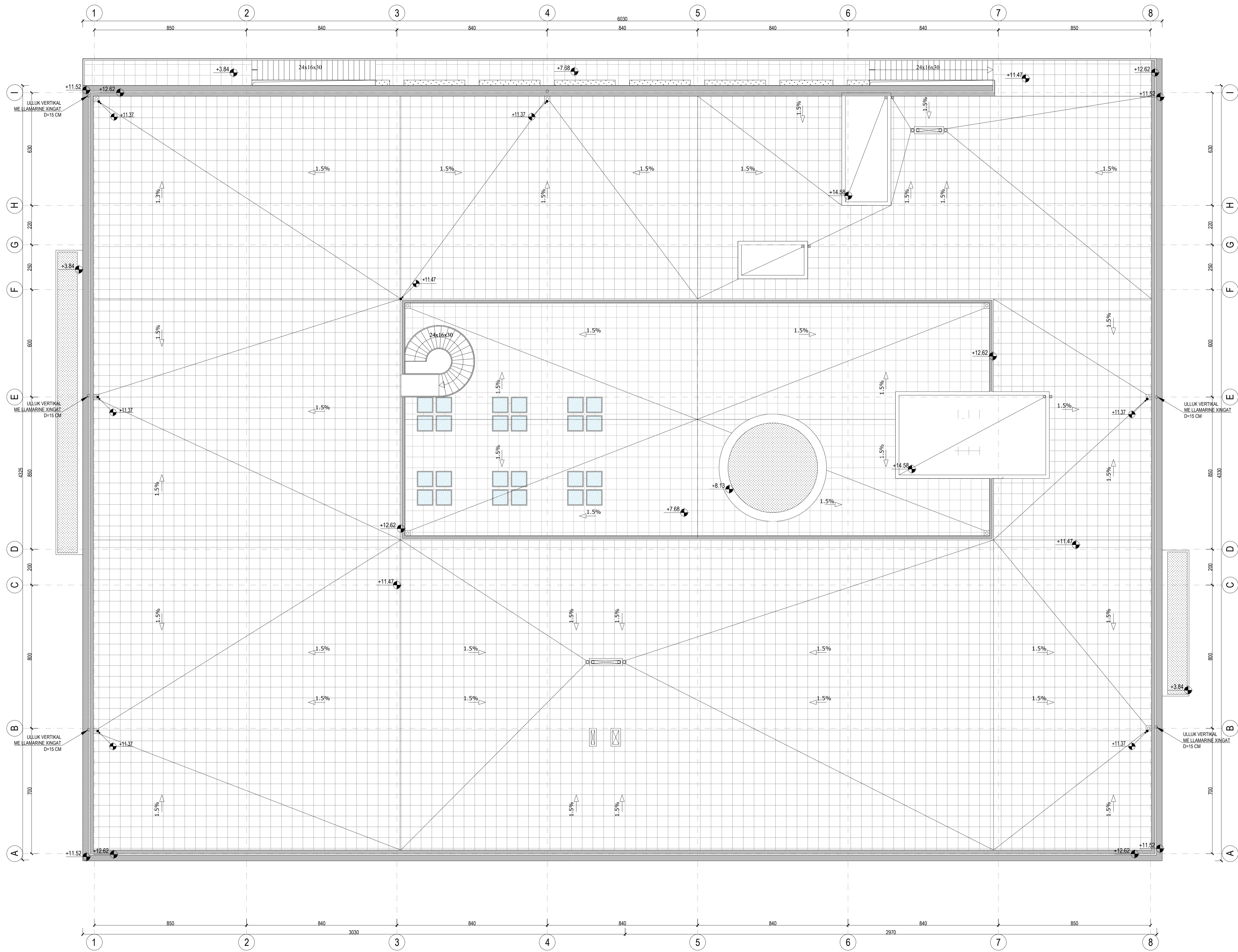

Rruga "QAZIM VATHI" nr 106 Tirane
 Mobil 00355 69 20 38 848
 e-mail: ajkiddtopore@yahoo.com
 e-mail: ajkiddtopore@sphaera.al

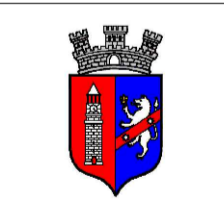

**AUTORITETI KONTRAKTOR
 BASHKIA TIRANË**

**"Ndërtim i shkollës 9 vjeçare, ne Rr. "Muharrem
 Caushi", Njesia Strukturore KA/253".**

Sektori:

Titulli i vizatimit:
PLANI I KULLIMEVE

Faza e Projektit	Data	Grupi i Projektimit	Firma	Firma
PROJEKT ZBATIMI	Prill 2023	Inzh. Ajkë TOPORE	Inzh. Nikolin RISILIA	
Nr. i vizatimit	Shkala	Ark. Kelina GEGA	Inzh. Artur DADO	
A-108	1:100	Inzh. Dhimitër PAPA	Inzh. Mario FISHTA	

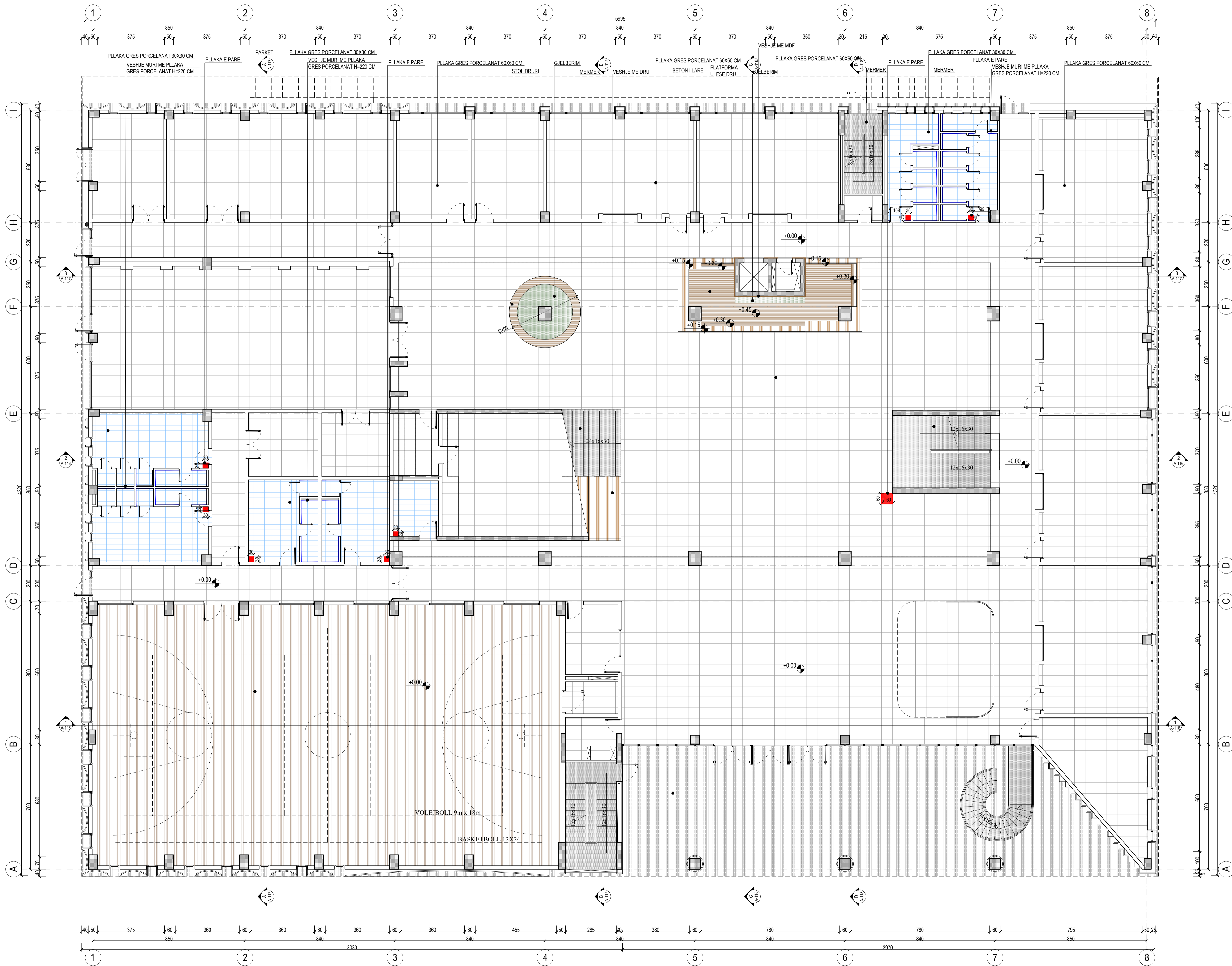
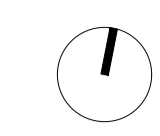

Rruga "QAZIM VATHI" nr 106 Tirane
 Mobil 00355 69 20 38 848
 e-mail: ajkiddtopore@yahoo.com
 e-mail: ajkiddtopore@sphaera.al

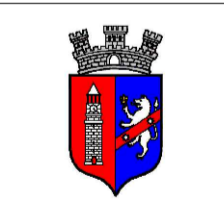

**AUTORITETI KONTRAKTOR
 BASHKIA TIRANË**

**"Ndertim i shkolles 9 vjecare, ne Rr. "Muharrem
 Caushi", Njesia Strukturore KA/253".**

Seksioni:
 Titulli i vizatimit:

**PLANI I DYSHEMESE SE
 KATIT PERDHE**

Faza e Projektit	Data	Grupi i Projektimit	Firma	Firma
PROJEKT ZBATIMI	Prill 2023	Grupi i Projektimit	Firma	Firma
Nr. i Vizatimit	Shkala	Inzh. Ajsid TOPORE	Inzh. Nikolin RISILIA	
A-109	1:100	Inzh. Kelmira GEGA	Inzh. Artur DADO	
		Inzh. Dhimitër PAPA		
		Inzh. Mario FISHTA		

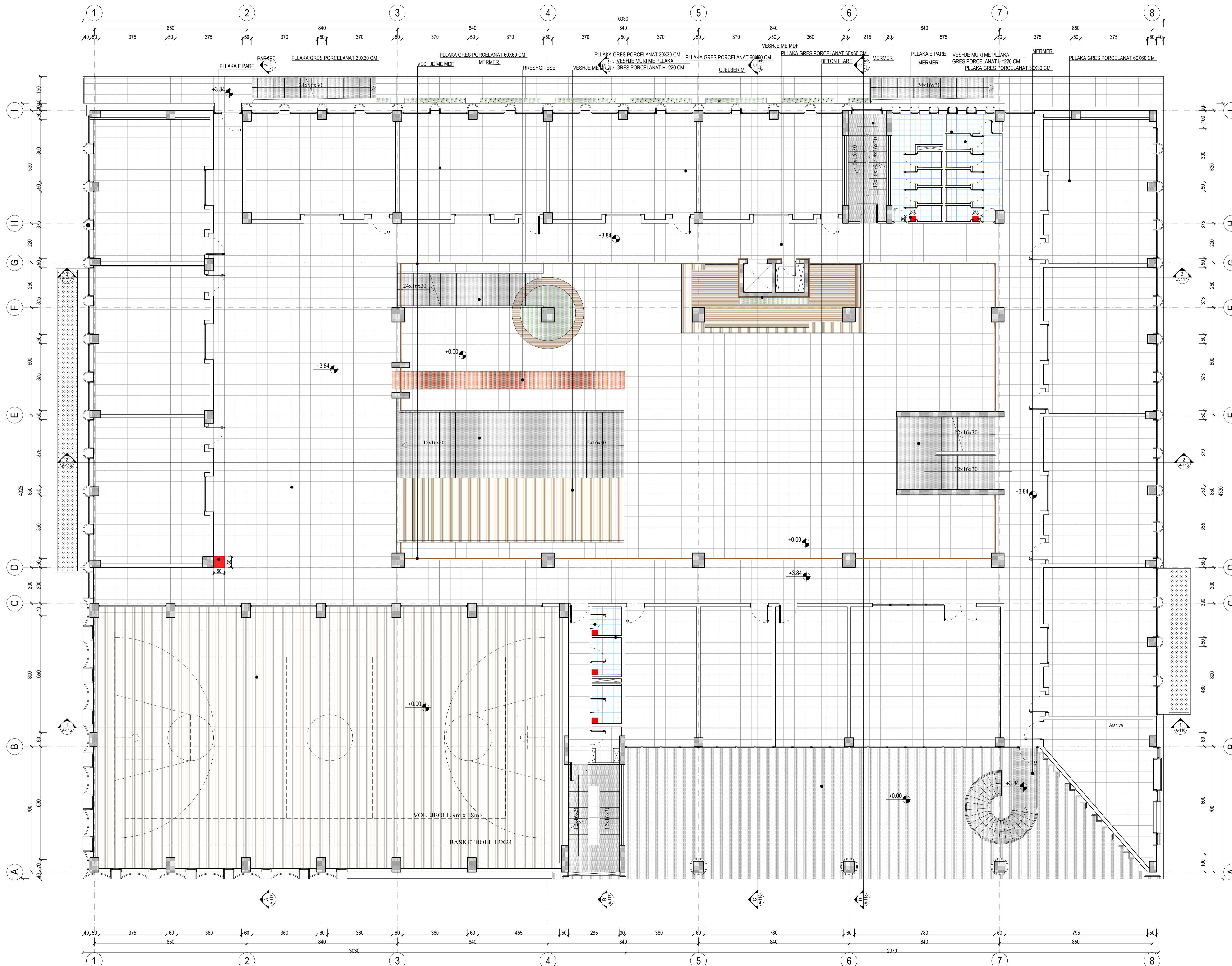

Rruga "QAZIM VATHI" nr 106 Tirane
 Mobil 00355 69 20 38 848
 e-mail: ajkiddtopore@yahoo.com
 e-mail: ajkiddtopore@sphaera.al



**AUTORITETI KONTRAKTOR
 BASHKIA TIRANË**

**"Ndertim i shkolles 9 vjeçare, ne Rr. "Muharrem
 Caushi", Njesia Strukturore KA/253".**

Sektori:
 Titulli i vizatimit:
**PLANI I DYSHEMESE SE
 KATIT TE PARE**

Faza e Projektit	Data	Grafik i Projektit	Firma	Firma
PROJEKT ZBATIMI	Prill 2023	Ark. Nikoll TOPORE	Inzh. Nikoll RISHLIA	
		Ark. Ketiha GEGA	Inzh. Artur DADO	
		Inzh. Dhimitër PAPA		
		Inzh. Mario FISHTA		

Nr i Vizimit: A-110
 Shkala: 1:100

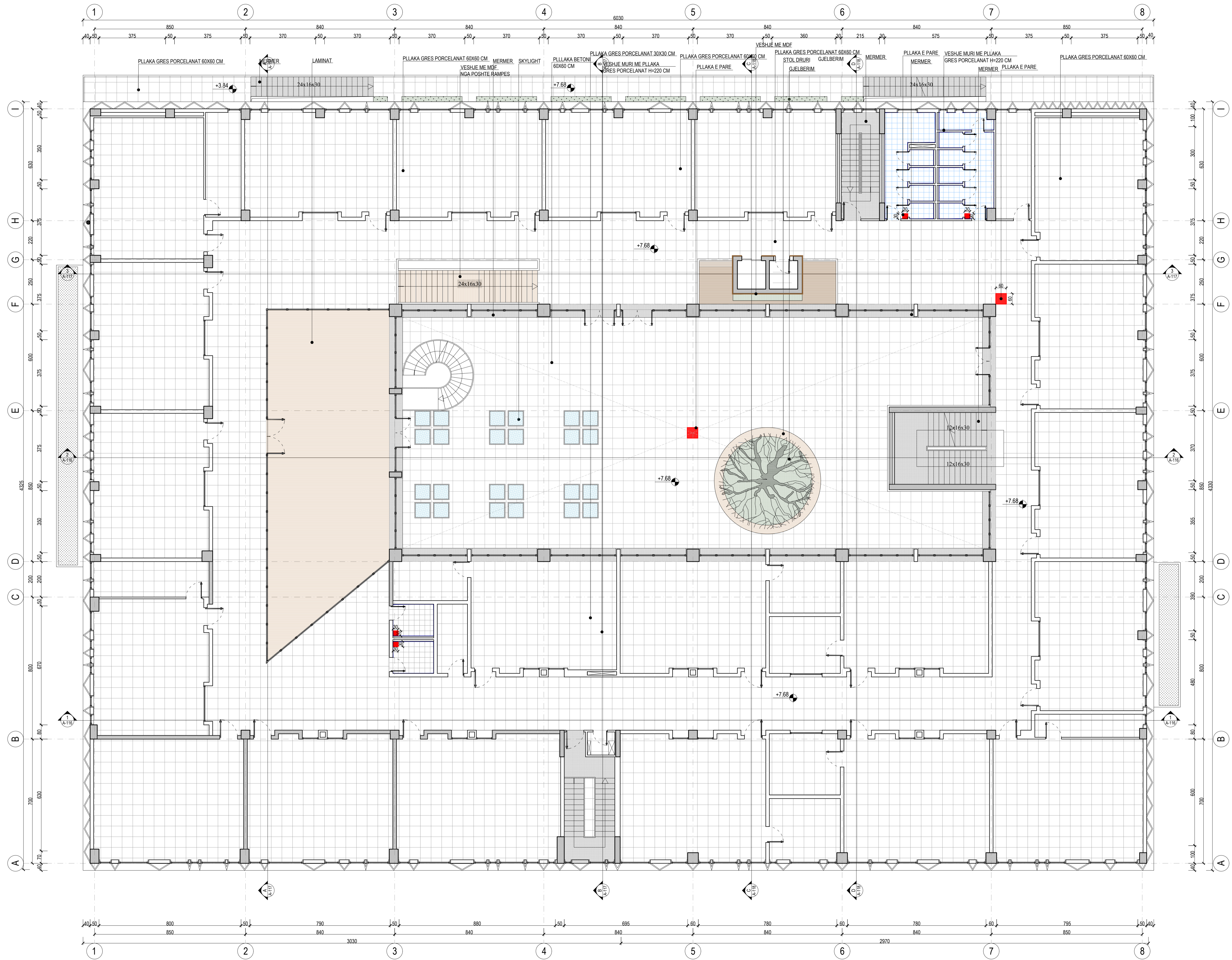
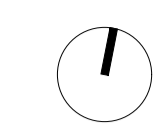

Rruga "QAZIM VATHI" nr 106 Tirane
 Mobil 00355 69 20 38 848
 e-mail: ajkidtopore@yahoo.com
 e-mail: ajkidtopore@sphaera.al



**AUTORITETI KONTRAKTOR
 BASHKIA TIRANË**

**"Ndërtim i shkollës 9 vjeçare, ne Rr. "Muharrem
 Caushi", Njesia Strukturore KA/253".**

Sektori:
 Titulli i vizatimit:

**PLANI I DYSHEMESE SE
 KATIT TE DYTE**

Faza e Projektit: PROJEKT ZBATIMI	Data: Prill 2023	GRUP I PROJEKTORE: Inzh. Ajsid TOPORE Ark. Ketiina GEGA Inzh. Dhimitër PAPA Inzh. Mario FISHTA	FIRMA: Inzh. Nikolin RISILIA Inzh. Artur DADO	FIRMA:
Nr. i Vizimit: A-111	Shkala: 1:100			

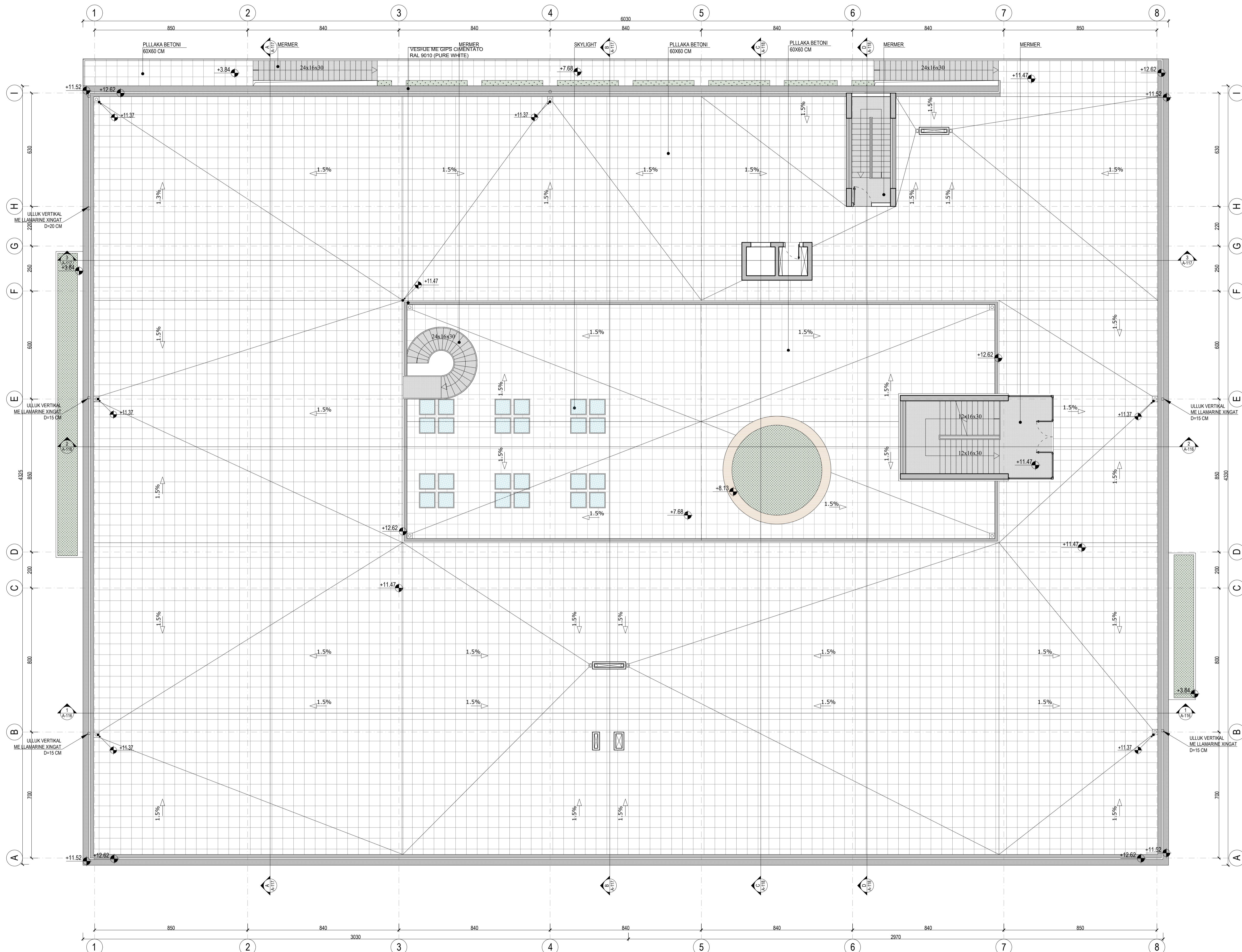

Rruga "QAZIM VATHI" nr 106 Tirane
 Mobil 00355 69 20 38 848
 e-mail: ajkidtopore@yahoo.com
 e-mail: ajkidtopore@sphaera.al

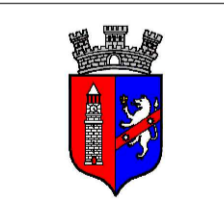

**AUTORITETI KONTRAKTOR
 BASHKIA TIRANË**

**"Nderim i shkolles 9 vjecare, ne Rr. "Muharrem
 Caushi", Njesia Strukturore KA/253".**

Sektori:
 Titulli i vizatimit:

**PLANI I DYSHEMESE SE
 TERRACES**

Faza e Projektit: PROJEKT ZBATIM	Data: Prill 2023	GRUPA I PROJEKTIMIT: Inzh. Nikolin TOPORE	FIRMA: Inzh. Nikolin RISILIA	FIRMA:
Nr i Vizimit: A-112	Shkala: 1:100	Inzh. Kellina GEGA Inzh. Dhimitër PAPA Inzh. Mario FISHTA	Inzh. Artur DADO	

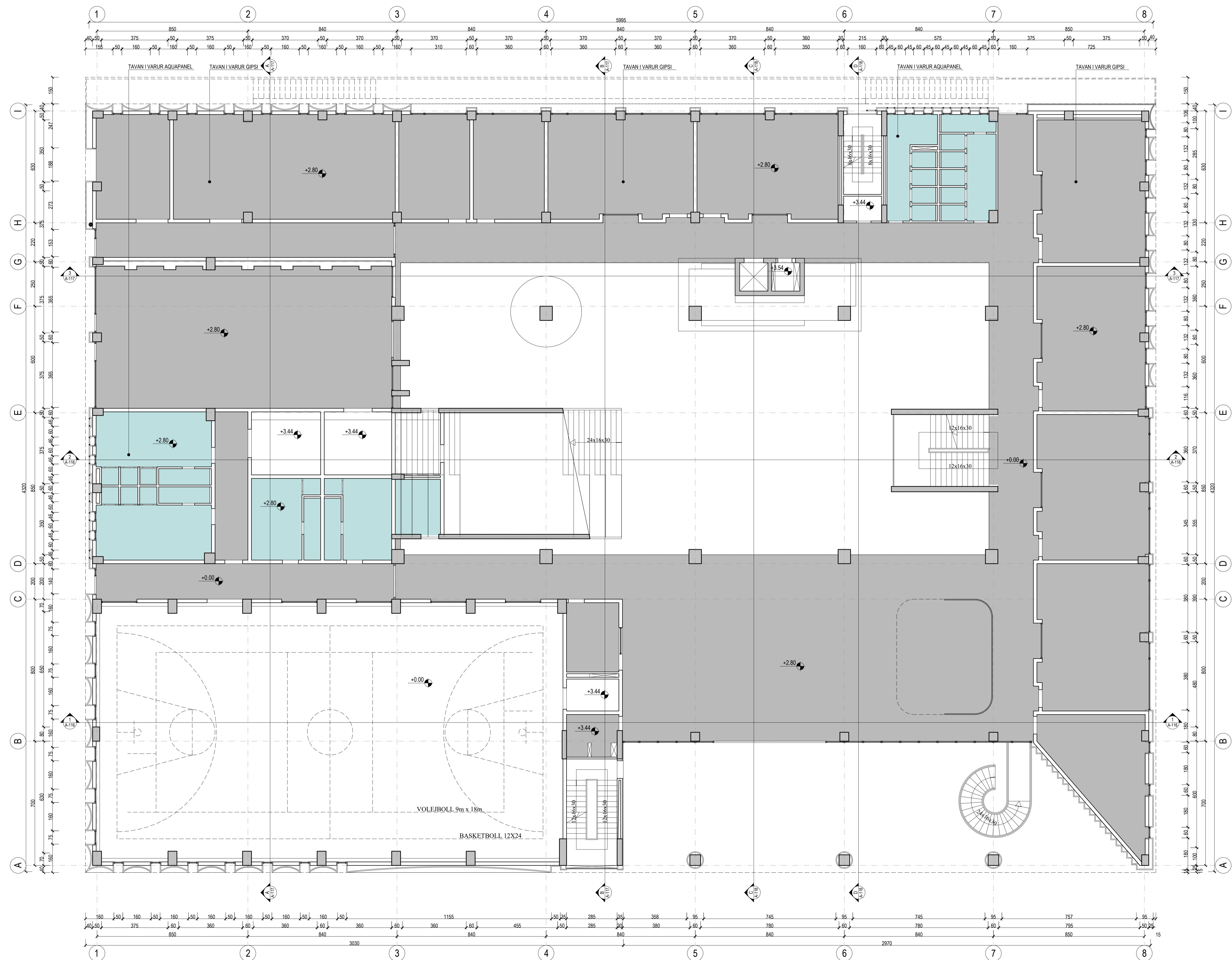
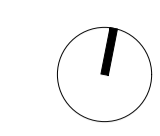

"SPHAERA" sh.p.k
 PROJEKTIM
 SUPERVIZION
 KOLAUDIM
 Rruga "QAZIM VATHI" nr 106 Tirane
 Mobil 00355 69 20 38 848
 e-mail: ajkidtopore@yahoo.com
 e-mail: ajkidtopore@sphaera.al



**AUTORITETI KONTRAKTOR
 BASHKIA TIRANË**

**"Ndertim i shkolles 9 vjecare, ne Rr. "Muharrem
 Caushi", Njesia Strukturore KA/253".**

Sektori: _____

Titulli i vizatimit: **PLANI I TAVANIT NE
 KATIT PERDHE**

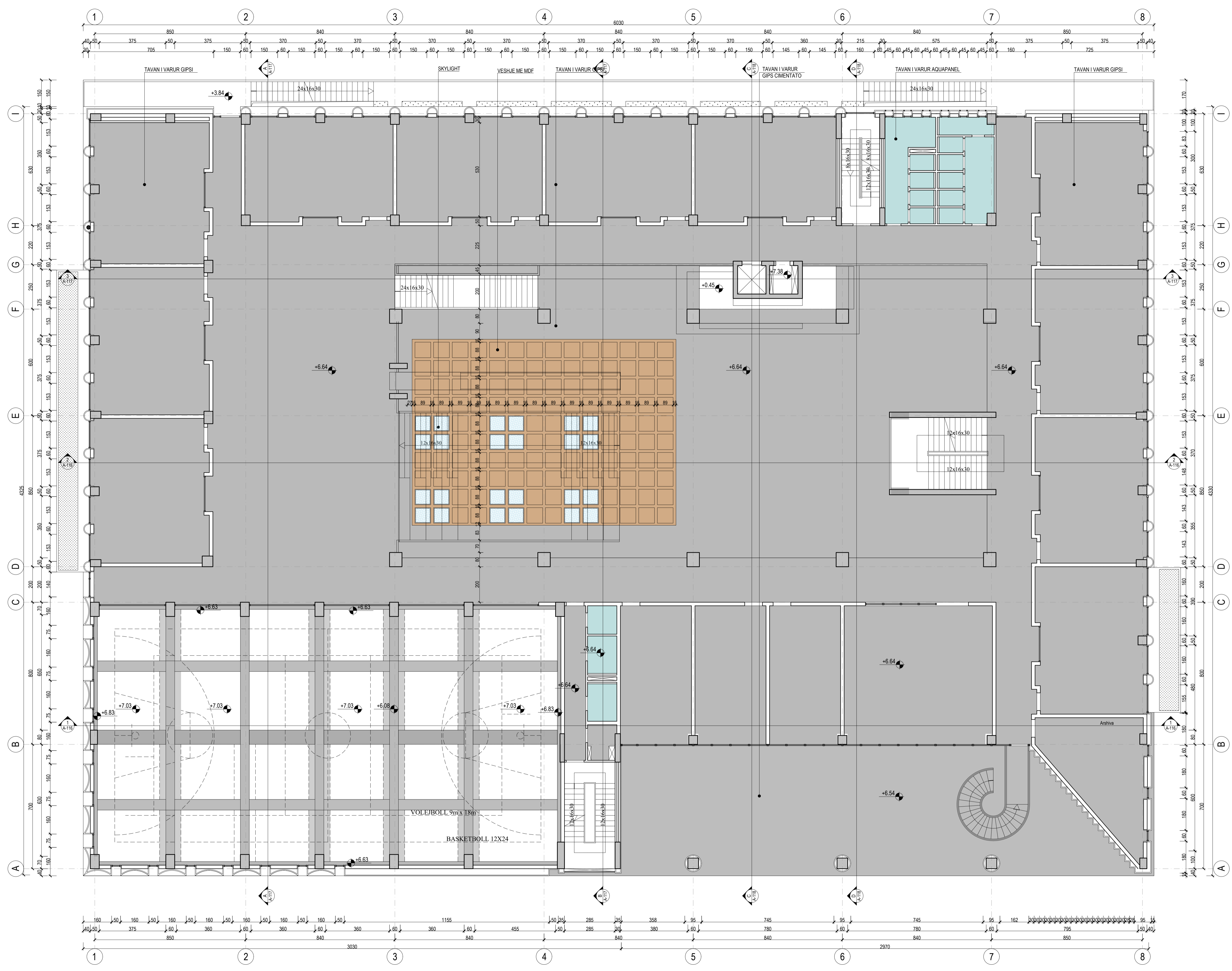
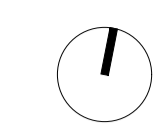
Faza e Projektit: PROJEKT ZBATIMI	Data: Prill 2023	GRUP I PROJEKTORE: Inzh. AJKID TOPORE Ark. KETIMA GEGA Inzh. DHIMTAR PAPA Inzh. MARIO FISHTA	FIRMA: Inzh. NIKOLIN RISILIA Inzh. ANUR DADO	FIRMA:
Nr. i Vizimit: A-113	Shkala: 1:100			



"SPHAERA" sh.p.k
PROJEKTIM
SUPERVIZION
KOLAUDIM

Rruga "QAZIM VATHI" nr 106 Tirane
Mobil 00355 69 20 38 848
e-mail: ajkidtopore@yahoo.com
e-mail: ajkidtopore@sphaera.al

**AUTORITETI KONTRAKTOR
BASHKIA TIRANË**

**"Ndertim i shkolles 9 vjeçare, ne Rr. "Muharrem
Caushi", Njesia Strukturore KA/253".**

Sektori:

Titulli i vizatimit:

**PLANI I TAVANIT NE
KATIT E PARE**

Faza e Projektit: PROJEKT ZBATIMI	Data: Prill 2023	GRUPI I PROJEKTIMIT: Inzh. Ajsid TOPORE Ark. Ketiha GEGA	FIRMA: Inzh. Nikolin RISILIA Inzh. Artur DADO	FIRMA:
Nr. i Vizimit: A-114	Shkala: 1:100	Inzh. Dhimitër PAPA Inzh. Mario FISHTA		

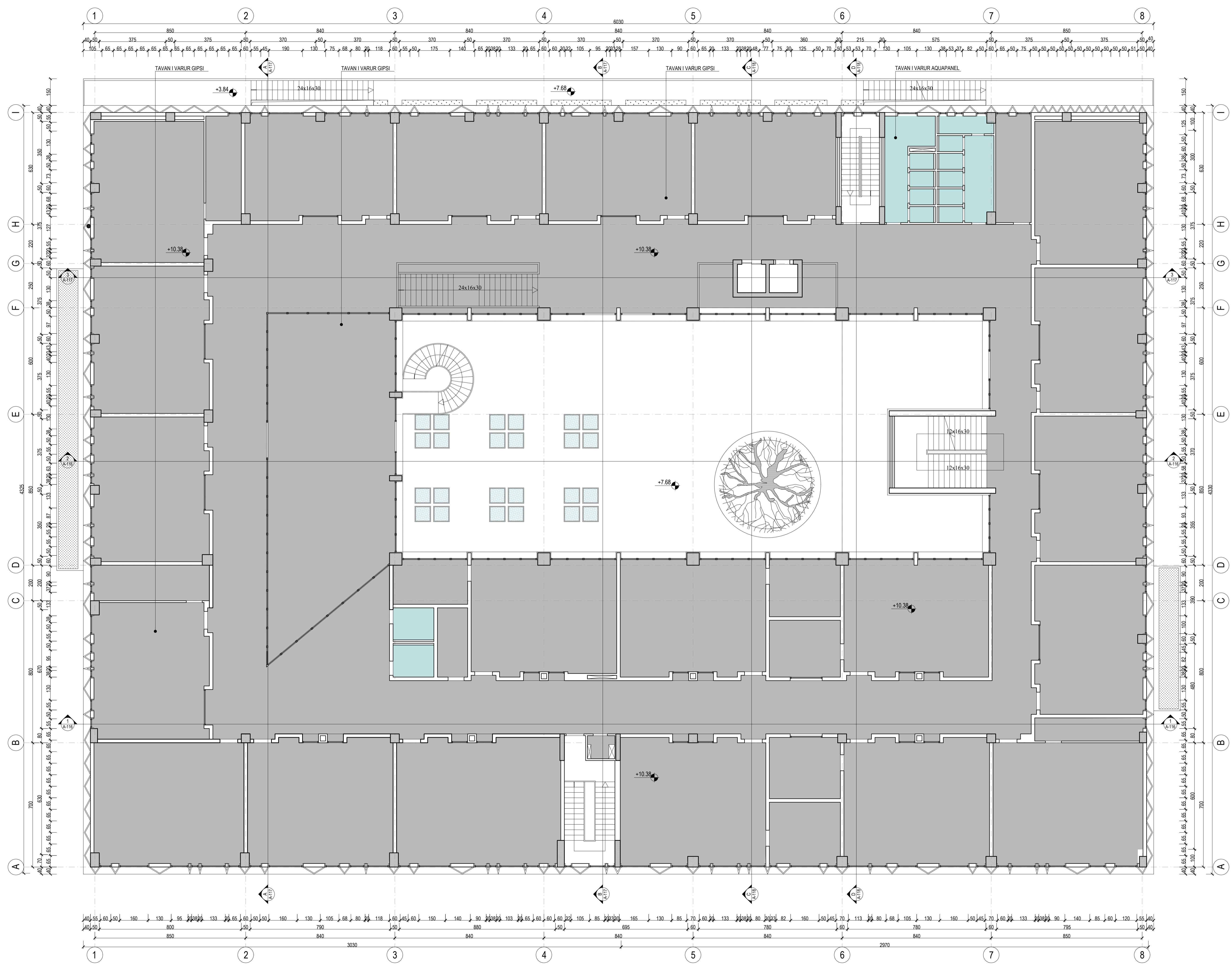
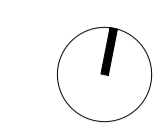

Rruga "QAZIM VATHI" nr 106 Tirane
 Mobil 00355 69 20 38 848
 e-mail: ajkidtopore@yahoo.com
 e-mail: ajkidtopore@sphaera.al

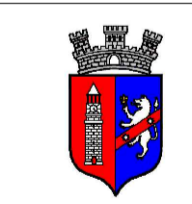

**AUTORITETI KONTRAKTOR
 BASHKIA TIRANË**

**"Ndertim i shkollës 9 vjeçare, ne Rr. "Muharrem
 Caushi", Njesia Strukturore KA/253".**

Sektori:
 Titulli i vizimit:

**PLANI I TAVANIT NE
 KATIT E DYTE**

Faza e Projektit: PROJEKT ZBATIMI	Data: Prill 2023	GRUP I PROJEKTORE: Inzh. AJKID TOPORE Ark. KETIMA GEGA Inzh. DHIMITER PAPA Inzh. MARIO FISHTA	FIRMA: Inzh. NIKOLIN RISHLIA Inzh. ANUR DADO	FIRMA:
Nr i Vizimit: A-115	Shkala: 1:100			

PRERJA 1-1 SH. 1:100

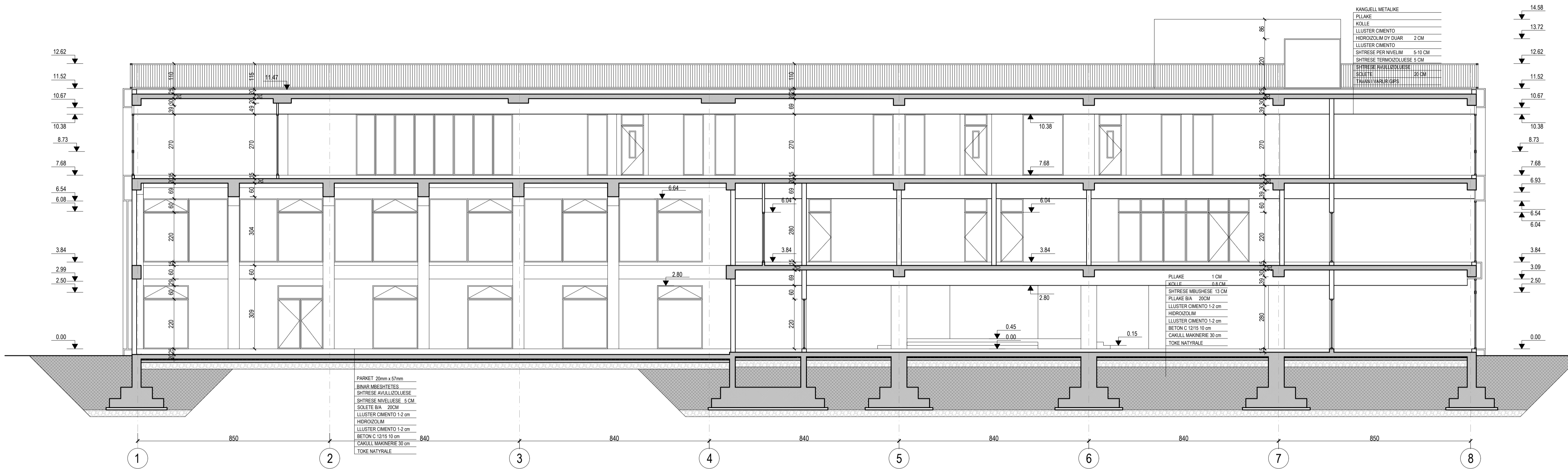

PRERJA 2-2 SH. 1:100

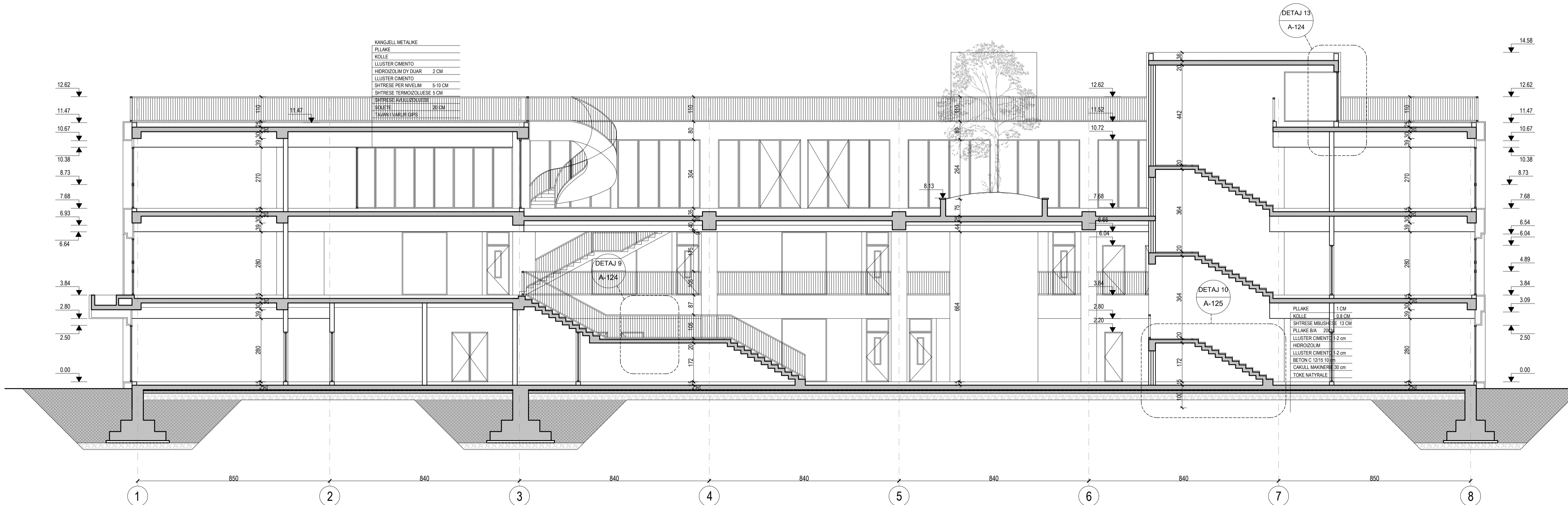

Shenime:



Rruga "QAZIM VATHI" nr 106 Tirane
Mobil 00355 69 20 38 848

e-mail: ajkidtopore@yahoo.com
e-mail: ajkidtopore@sphaera.al



**AUTORITETI KONTRAKTOR
BASHKIA TIRANË**

**"Nderim i shkolles 9 vjeçare, ne Rr. "Muharrem
Caushi", Njesia Strukturore KA/253".**

Seksioni:

Titulli i vizatimit:
PRERJA 1-1, 2-2

Faza e Projektit	Data	Shtet i Projektimit	Firma	Firma
PROJEKT ZBATIMI	Prill 2023	Inzh. Ajsid TOPORE	Inzh. Nikolin RISILIA	
Nr. i Vizimit:	Shkala:	Inzh. Kelmira GEGA	Inzh. Artur DADO	
A-116	1:100	Inzh. Dhimitër PAPA	Inzh. Mario FISHTA	

PRERJA 3-3 SH. 1:100

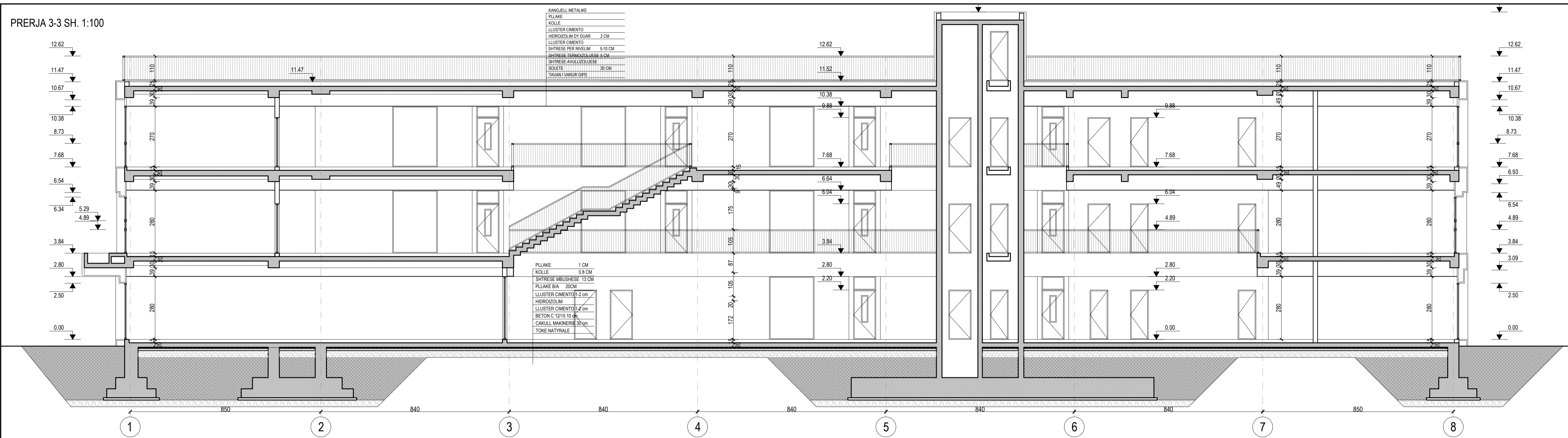

PRERJA A-A SH. 1:100

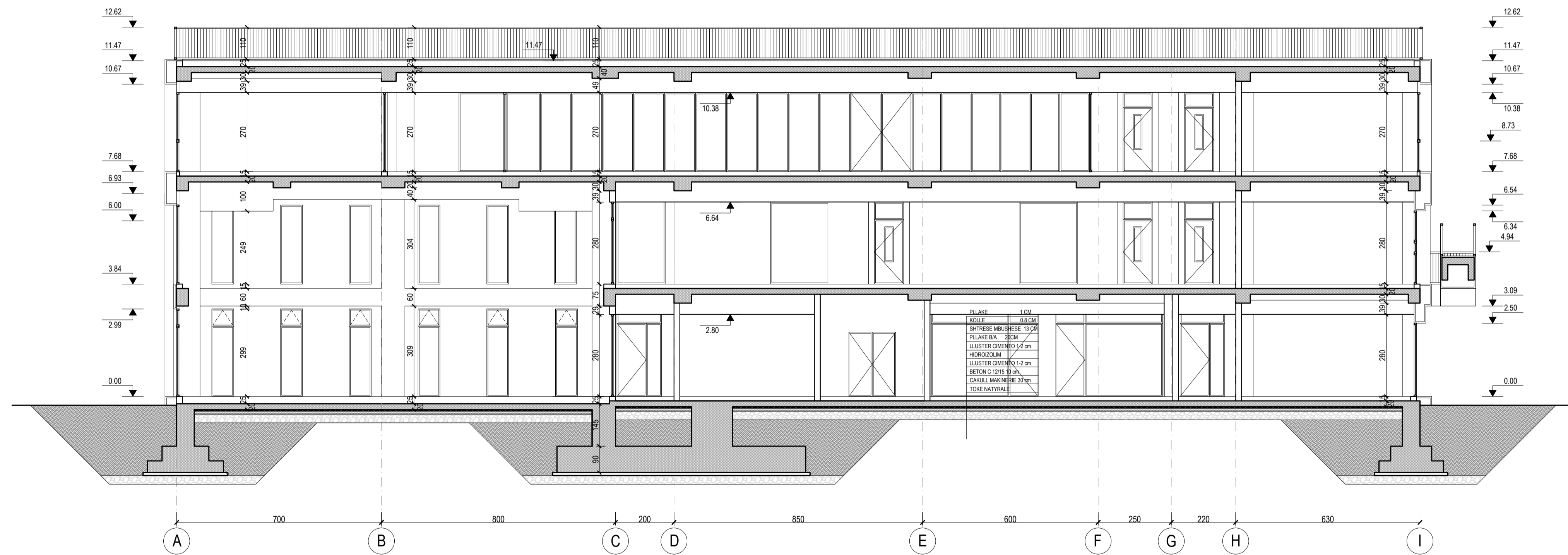

PRERJA B-B SH. 1:100

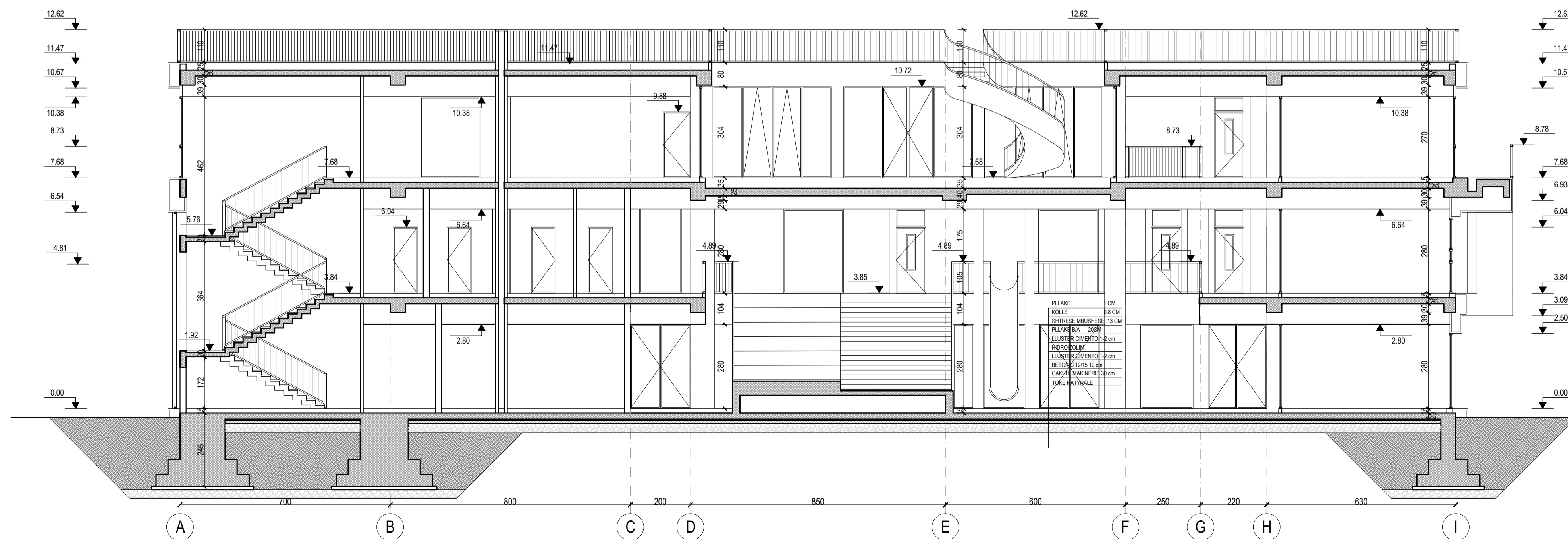

Shenime:



Rruga "QAZIM VATHI" nr 106 Tirane
Mobil 00355 69 20 38 848

e-mail: ajkidtopore@yahoo.com
e-mail: ajkidtopore@sphaera.al



**AUTORITETI KONTRAKTOR
BASHKIA TIRANË**

**"Ndertim i shkollës 9 vjeçare, ne Rr. "Muharrem
Caushi", Njesia Strukturore KA/253".**

Sektori:

Titulli i vizatimit:

PRERJA 3-3, A-A, B-B

Faza e Projektit	Data	Grupi i Projektimit	Firma	Firma
PROJEKT ZBATIMI	Prill 2023	Inzh. Ajsid TOPORE	Inzh. Nikolin RISILIA	
Nr. i Vizimit	Shkala	Inzh. Kelmë GEGA	Inzh. Artur DADO	
A-117	1:100	Inzh. Dhimitër PAPA	Inzh. Mario FISHTA	

PRERJA C-C SH. 1:100

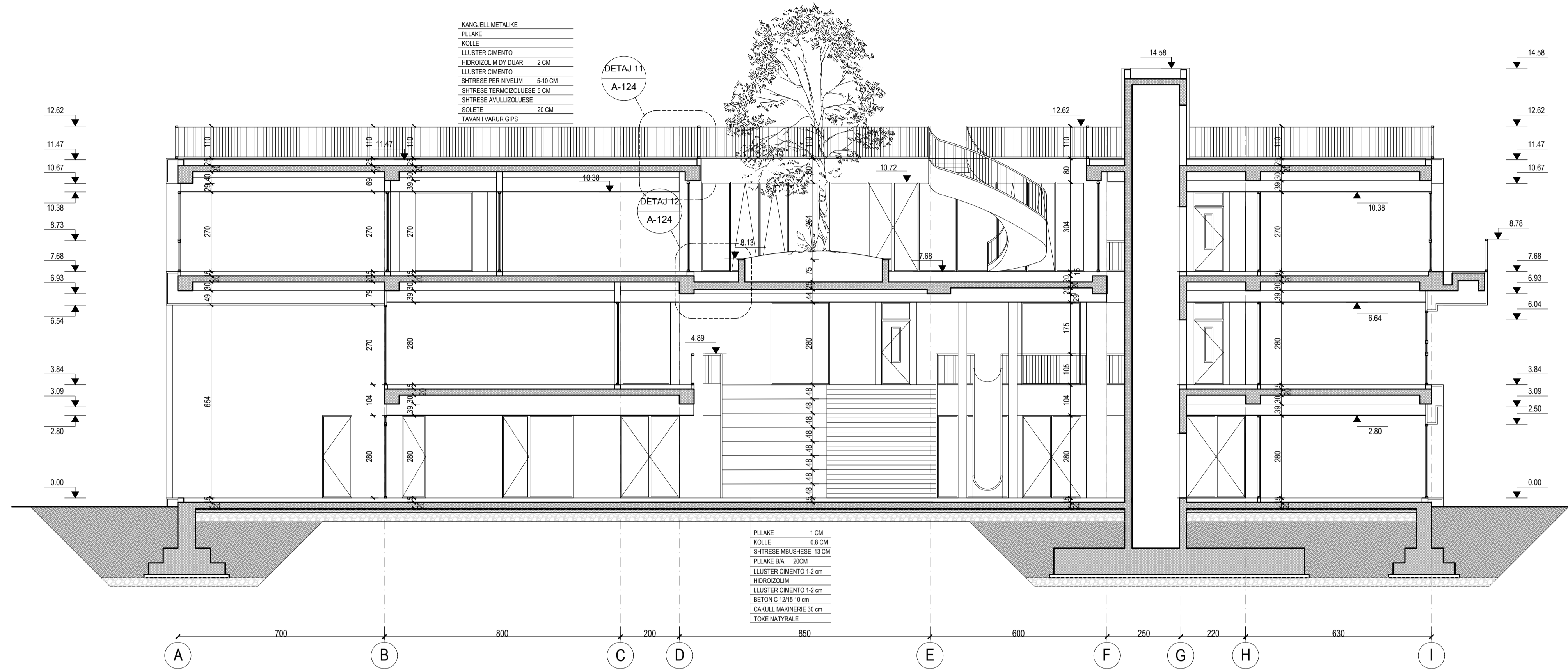

PRERJA D-D SH. 1:100

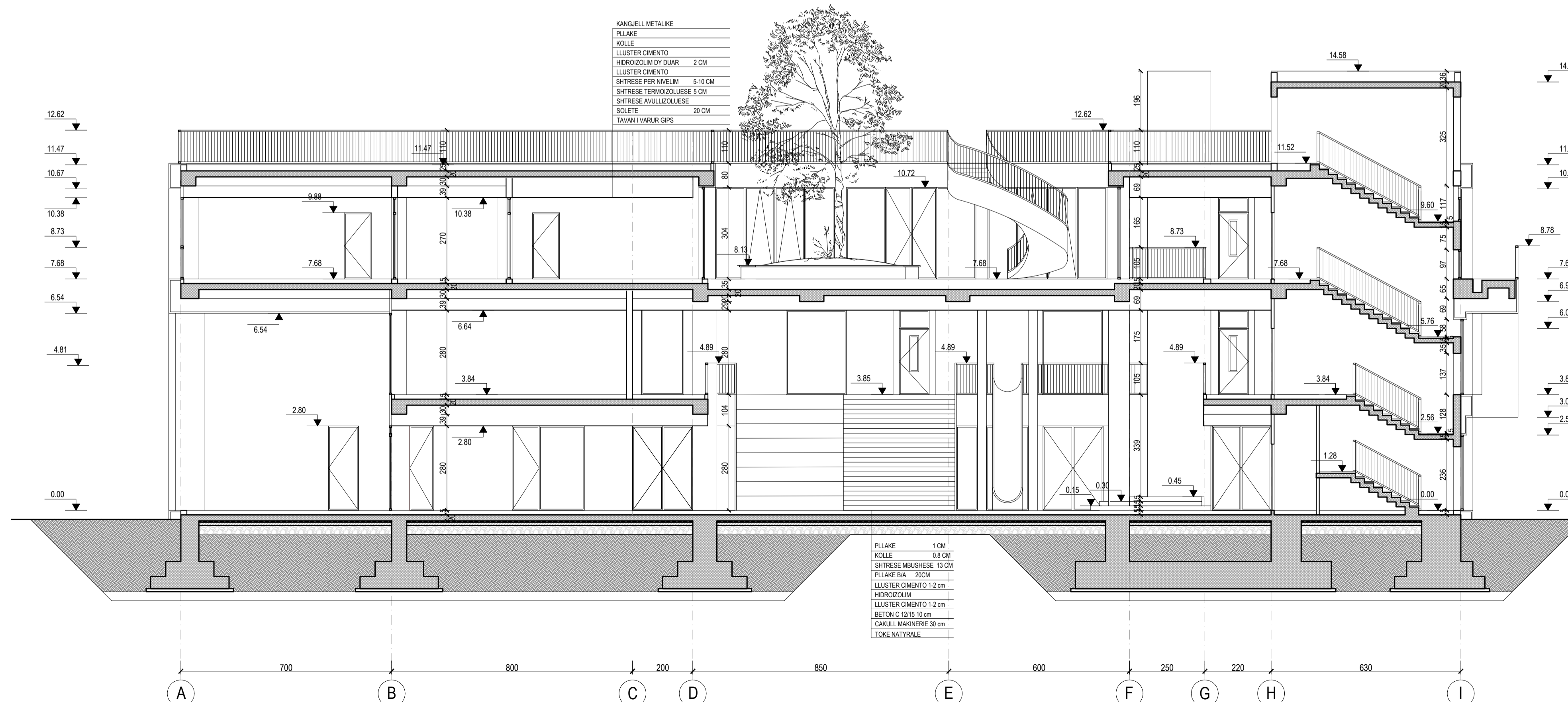

Shenime:



Rruga "QAZIM VATHI" nr 106 Tirane
 Mobil 00355 69 20 38 848
 e-mail: ajkidtopore@yahoo.com
 e-mail: ajkidtopore@sphaera.al



**AUTORITETI KONTRAKTOR
 BASHKIA TIRANË**

**"Ndërtim i shkollës 9 vjeçare, ne Rr. "Muharrem
 Caushi", Njesia Strukturore KA/253".**

Sektori:

Titulli i vizatimit:
PRERJA C-C, D-D

Faza e Projektit	Data	Grupi i Projektimit	Firma	Firma
PROJEKT ZBATIMI	Prill 2023	Inzh. Ajsid TOPORE	Inzh. Nikolin RISILIA	
Nr. i Vizimit	Shkala	Ark. Kelmë GEGA	Inzh. Artur DADO	
A-118	1:100	Inzh. Dhimitër PAPA		
		Inzh. Mario FISHTA		

PAMJE NGA JUGU SH. 1:100

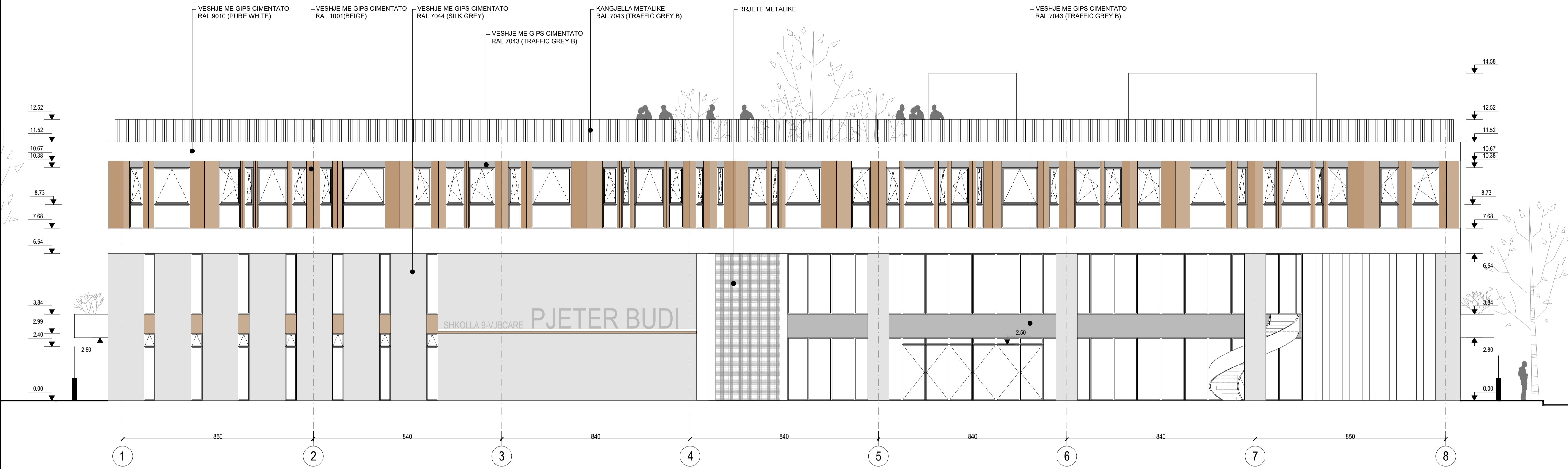

PAMJE NGA LINDJA SH. 1:100

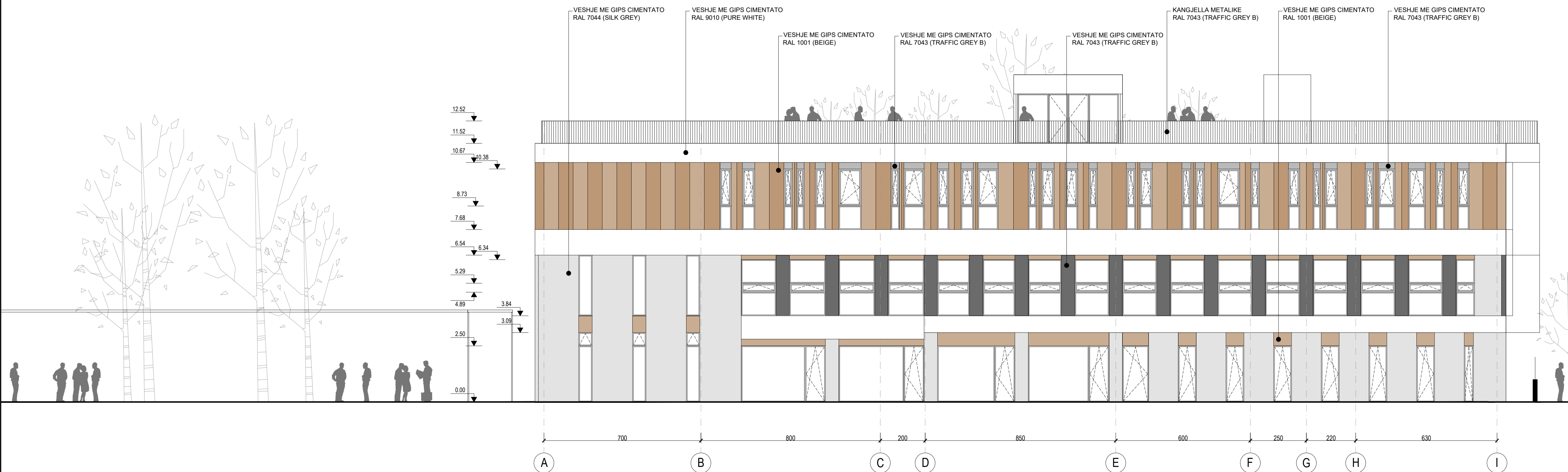

Shenime:

"SPHAERA" sh.p.k
 PROJEKTIM
 SUPERVIZION
 KOLAUDIM

Rruga "QAZIM VATHI" nr 106 Tirane
 Mobil 00355 69 20 38 848
 e-mail: ajkidtopore@yahoo.com
 e-mail: ajkidtopore@sphaera.al

**AUTORITETI KONTRAKTOR
 BASHKIA TIRANË**

"Ndërtim i shkolles 9 vjeçare, ne Rr. "Muharrem
 Caushi", Njesia Strukturore KA/253".

Sektori:

Titulli i vizatimit:
PAMJE NGA JUGU DHE LINDJA

Faza e Projektit	Data	Shtypsi i Projektit	Firma	Firma
PROJEKT ZBATIMI	Prill 2023	Inzh. Ajkë TOPORE	Inzh. Nikolin RISILIA	
Nr. i Vizimit	Shkala	Inzh. Këlmeta GEGA	Inzh. Artur DADO	
A-119	1:100	Inzh. Dhimitër PAPA	Inzh. Mario FISHTA	

PAMJE NGA VERIU SH. 1:100

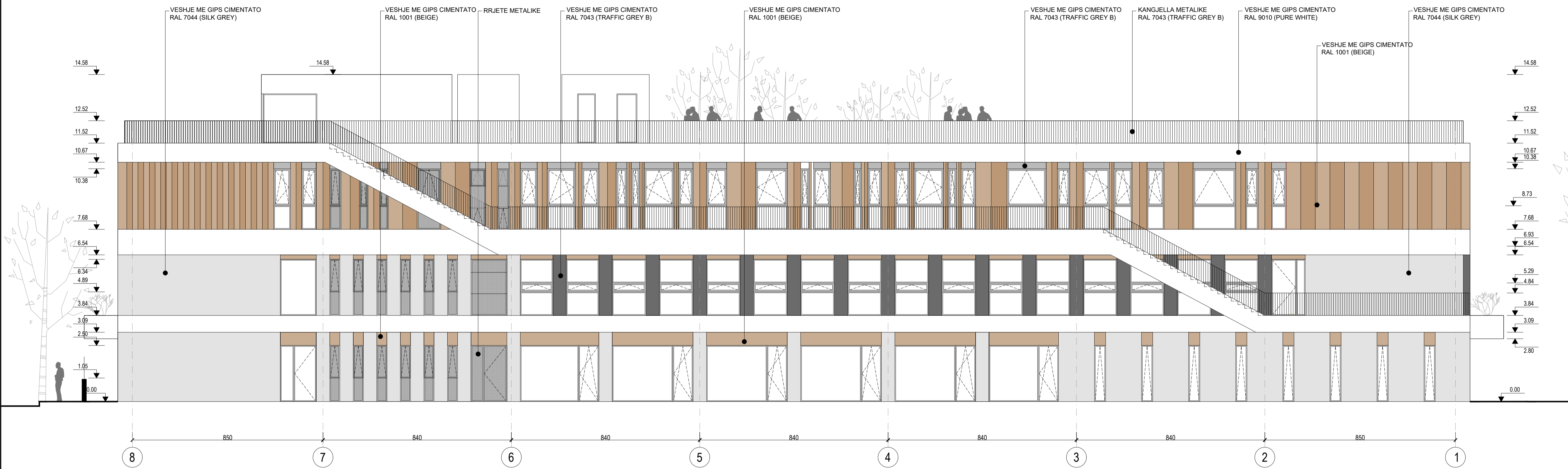

PAMJE NGA PERENDIMI SH. 1:100



Shenime:

"SPHAERA" sh.p.k
 PROJEKTIM
 SUPERVIZION
 KOLAUDIM

Rruga "QAZIM VATHI" nr 106 Tirane
 Mobil 00355 69 20 38 848
 e-mail: ajkidtopore@yahoo.com
 e-mail: ajkidtopore@sphaera.al

**AUTORITETI KONTRAKTOR
 BASHKIA TIRANË**

"Nderim i shkolles 9 vjeçare, ne Rr. "Muharrem
 Caushi", Njesia Strukturore KA/253".

Seksioni:

Titulli i vizatimit:
PAMJE NGA VERIU DHE PERENDIMI

Faza e Projektit	Data	Shtypsi i Projektit	Firma	Firma
PROJEKT ZBATIMI	Prill 2023	Inzh. Ajsid TOPORE	Inzh. Nikolin RISILIA	
Nr. i Vizimit:	Shkala:	Inzh. Ketiina GEGA	Inzh. Artur DADO	
A-120	1:100	Inzh. Dhimitër PAPA		
		Inzh. Mario FISHTA		

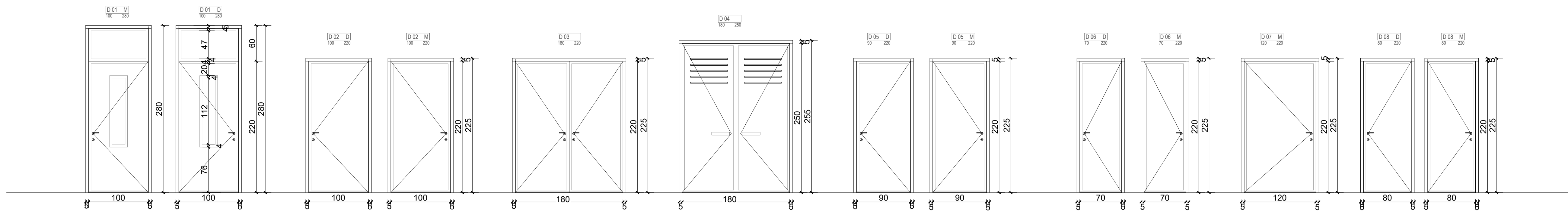

PV 01
2295 280

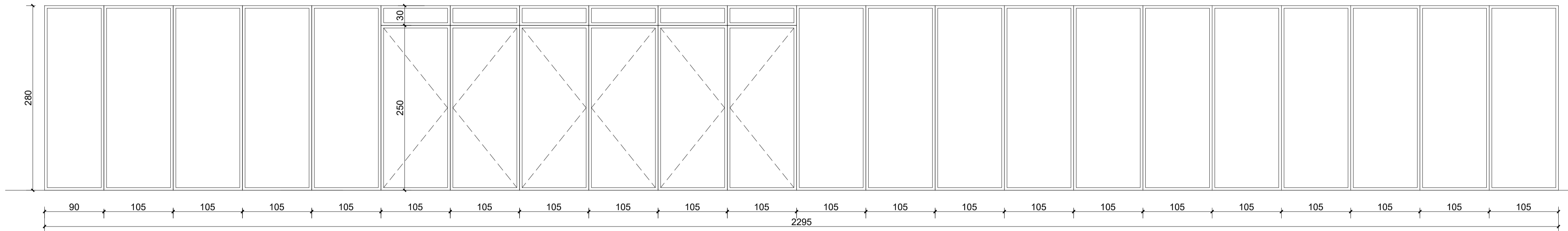

PV 02
2295 270

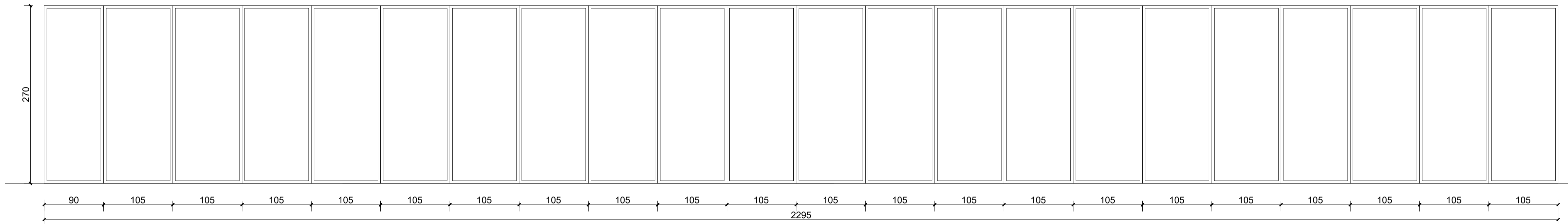

PV 03
380 250

PV 04-1
365 250

PV 04
365 250

PV 05
360 250

PV 06
345 250

PV 07
310 250

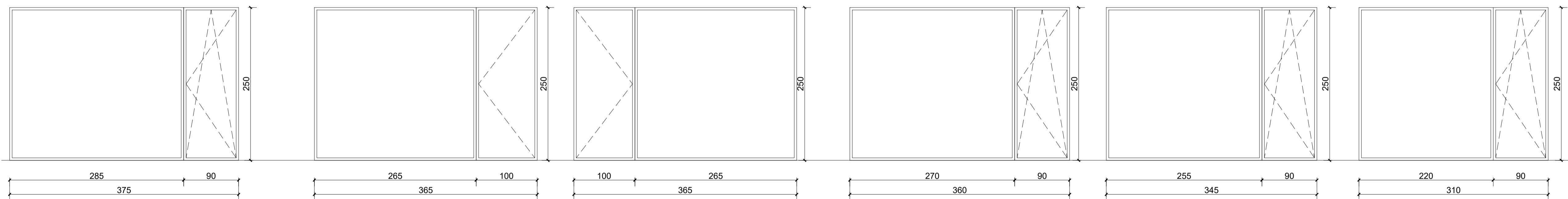

PV 08
240 280

PV 09
200 280

PV 10
195 280

PV 11
200 280

PV 12
160 250

PV 13
153 250

PV 14
140 250

PV 15
140 250

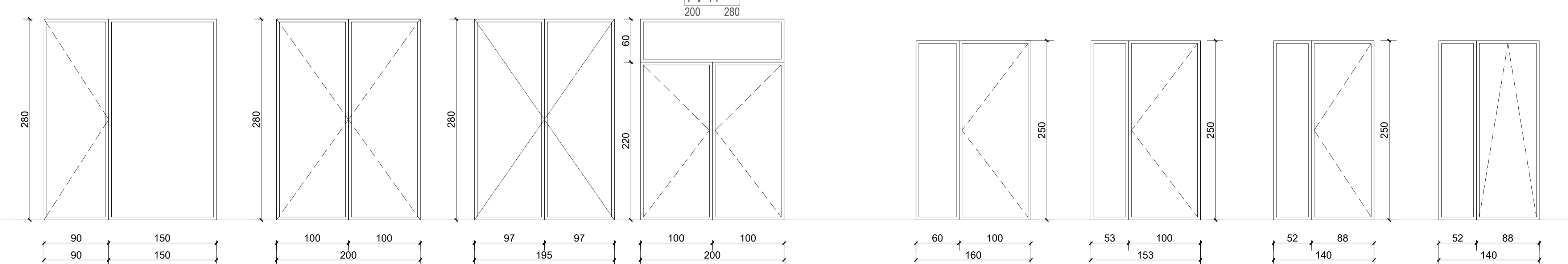

Shenime:

TABELA E DYERVE					
EMERTIMI	GJER.	LART.	ORIENT.	SPECIFIKIM	SASIA
D 01	100	280	D	DERE PER KLASAT TE PALISUR ME MEKANIZEM MEYLLLES	4
D 01-1	100	270	D	DERE PER KLASAT TE PALISUR ME MEKANIZEM MEYLLLES	4
D 01-1	100	270	M	DERE PER KLASAT TE PALISUR ME MEKANIZEM MEYLLLES	17
D 02	100	220	M	DERE E BRENDSHME TAMBURATE E RIMESUAR	5
D 02	100	220	D	DERE E BRENDSHME TAMBURATE E RIMESUAR	6
D 03	180	220	D	DERE INDUSTRIALE ME GRILE	2
D 04	180	250	D	DERE INDUSTRIALE ME GRILE	3
D 05	90	220	M		5
D 05	90	220	D		10
D 06	70	220	D		17
D 06	70	220	M		17
D 07	120	220	M		1
D 08	80	220	D		7
D 08	80	220	M		11



Rruga "QAZIM VATHI" nr 106 Tirane
 Mobil 00355 69 20 38 848
 e-mail: ajkidtopore@yahoo.com
 e-mail: ajkidtopore@sphaera.al

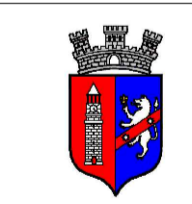

**AUTORITETI KONTRAKTOR
 BASHKIA TIRANË**

**"Ndertim i shkollës 9 vjeçare, ne Rr. "Muharrem
 Caushi", Njesia Strukturore KA/253".**

Seksioni: _____

Titulli i vizatimit:
TABELA E DYERVE DHE VETRATAVE

Faza e Projektit PROJEKT ZBATIM	Data Prill 2023	GJURIMI I PROJEKTIKUT Inzh. Ajsid TOPORE Ark. Kelmë GEGA Inzh. Dhimitër PAPA	FIRMA Inzh. Nikolin RISILIA Inzh. Artur DADO	FIRMA
Nr. i vizatimit A-121	Shkala 1:50	Inzh. Mario FISHTA		

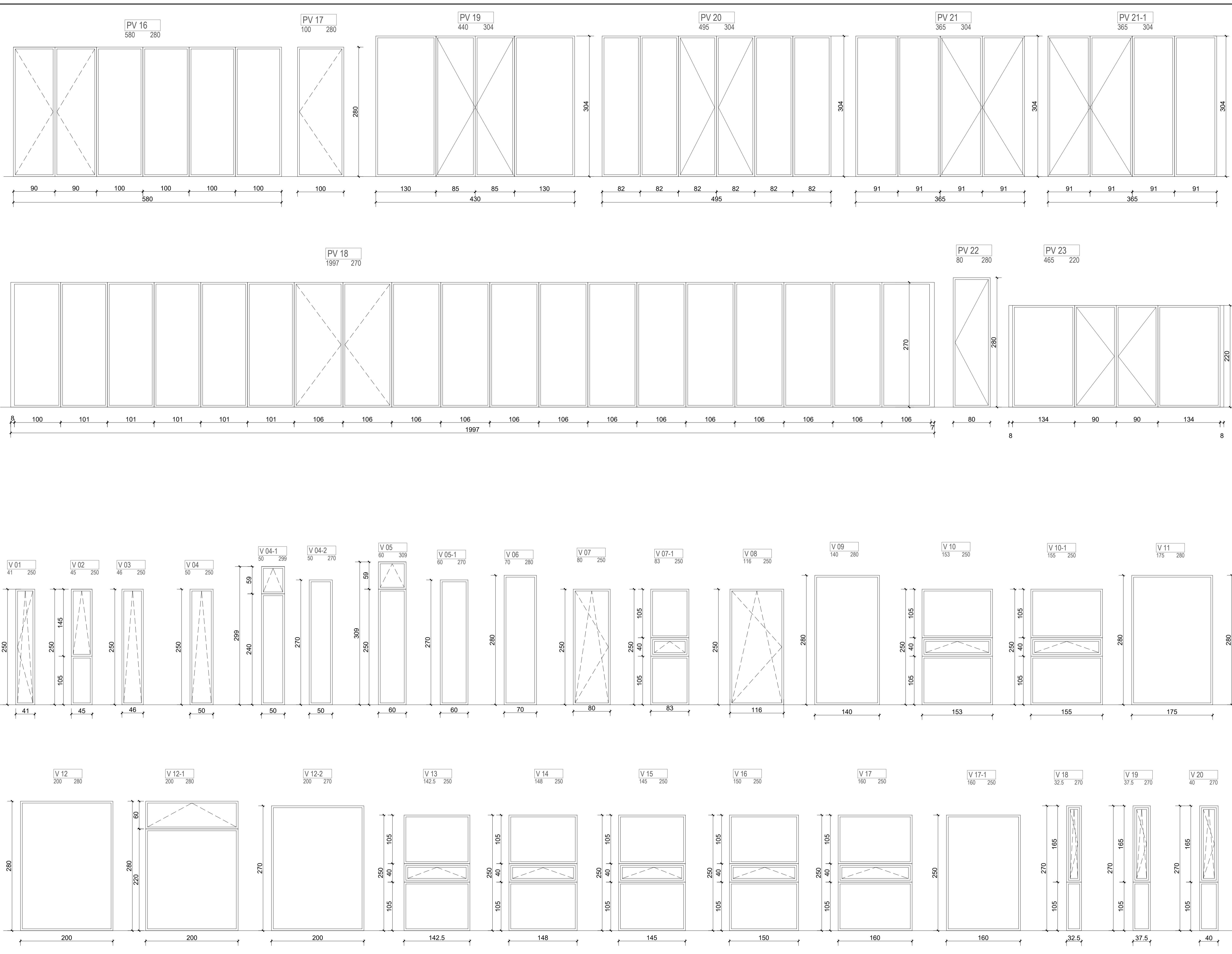

Shenime:

TABELA E VETRATAVE DHE PORTE-VETRATAVE				
E	GJER	LART	SPEC	Count
PV 01	2395	280	VESHJE FASADE ME XHAM GJYME STRUKTURAL	1
PV 02	2295	270	VESHJE FASADE ME XHAM GJYME STRUKTURAL	1
PV 03	380	250	PORTE-VESTRATE PLASTIKE ME DOPIO XHAM	2
PV 04	365	250	PORTE-VESTRATE PLASTIKE ME DOPIO XHAM	1
PV 04-1	365	250	PORTE-VESTRATE PLASTIKE ME DOPIO XHAM	1
PV 05	360	250	PORTE-VESTRATE PLASTIKE ME DOPIO XHAM	6
PV 06	345	250	PORTE-VESTRATE PLASTIKE ME DOPIO XHAM	1
PV 07	310	250	PORTE-VESTRATE PLASTIKE ME DOPIO XHAM	1
PV 08	240	280	PORTE-VESTRATE PLASTIKE ME DOPIO XHAM	1
PV 09	200	280	PORTE-VESTRATE PLASTIKE ME DOPIO XHAM	2
PV 10	195	280	PORTE-VESTRATE PLASTIKE ME DOPIO XHAM	1
PV 11	200	280	PORTE-VESTRATE PLASTIKE ME DOPIO XHAM	1
PV 12	180	250	PORTE-VESTRATE PLASTIKE ME DOPIO XHAM	2
PV 13	153	250	PORTE-VESTRATE PLASTIKE ME DOPIO XHAM	1
PV 14	140	250	PORTE-VESTRATE PLASTIKE ME DOPIO XHAM	1
PV 15	140	250	PORTE-VESTRATE PLASTIKE ME DOPIO XHAM	2
PV 16	580	280	PORTE-VESTRATE PLASTIKE ME DOPIO XHAM	1
PV 17	100	280	PORTE-VESTRATE PLASTIKE ME DOPIO XHAM	1
PV 18	1997	270	PORTE-VESTRATE PLASTIKE ME DOPIO XHAM	1
PV 19	440	304	PORTE-VESTRATE PLASTIKE ME DOPIO XHAM	1
PV 20	495	304	PORTE-VESTRATE PLASTIKE ME DOPIO XHAM	1
PV 21	365	304	PORTE-VESTRATE PLASTIKE ME DOPIO XHAM	1
PV 21-1	365	304	PORTE-VESTRATE PLASTIKE ME DOPIO XHAM	1
PV 22	80	280	PORTE-VESTRATE PLASTIKE ME DOPIO XHAM	1
PV 23	465	220	PORTE-VESTRATE PLASTIKE ME DOPIO XHAM	1
V 01	41	250	VESTRATE PLASTIKE ME DOPIO XHAM	1
V 02	45	250	VESTRATE PLASTIKE ME DOPIO XHAM	12
V 03	46	250	VESTRATE PLASTIKE ME DOPIO XHAM	4
V 04	50	250	VESTRATE PLASTIKE ME DOPIO XHAM	7
V 04-1	50	299	VESTRATE PLASTIKE ME DOPIO XHAM	13
V 04-2	50	270	VESTRATE PLASTIKE ME DOPIO XHAM	13
V 05	60	309	VESTRATE PLASTIKE ME DOPIO XHAM	3
V 05-1	60	270	VESTRATE PLASTIKE ME DOPIO XHAM	3
V 06	70	280	VESTRATE PLASTIKE ME DOPIO XHAM	1
V 07	80	250	VESTRATE PLASTIKE ME DOPIO XHAM	6
V 07-1	83	250	VESTRATE PLASTIKE ME DOPIO XHAM	1
V 08	116	250	VESTRATE PLASTIKE ME DOPIO XHAM	1
V 09	140	280	VESTRATE PLASTIKE ME DOPIO XHAM	1
V 10	153	250	VESTRATE PLASTIKE ME DOPIO XHAM	20
V 10-1	155	250	VESTRATE PLASTIKE ME DOPIO XHAM	1
V 11	175	280	VESTRATE PLASTIKE ME DOPIO XHAM	1
V 12	200	280	VESTRATE PLASTIKE ME DOPIO XHAM	17
V 12-1	200	280	VESTRATE PLASTIKE ME DOPIO XHAM	5
V 12-2	200	270	VESTRATE PLASTIKE ME DOPIO XHAM	10
V 13	142.5	250	VESTRATE PLASTIKE ME DOPIO XHAM	2
V 14	148	250	VESTRATE PLASTIKE ME DOPIO XHAM	1
V 15	145	250	VESTRATE PLASTIKE ME DOPIO XHAM	12
V 16	150	250	VESTRATE PLASTIKE ME DOPIO XHAM	4
V 17	160	250	VESTRATE PLASTIKE ME DOPIO XHAM	3
V 17-1	160	250	VESTRATE PLASTIKE ME DOPIO XHAM	2
V 18	32.5	270	VESTRATE PLASTIKE ME DOPIO XHAM	9
V 19	37.5	270	VESTRATE PLASTIKE ME DOPIO XHAM	23
V 20	40	270	VESTRATE PLASTIKE ME DOPIO XHAM	6
V 21	45	270	VESTRATE PLASTIKE ME DOPIO XHAM	5
V 22	365	304	VESTRATE PLASTIKE ME DOPIO XHAM	8
V 23	50	270	VESTRATE PLASTIKE ME DOPIO XHAM	9
V 24	52.5	270	VESTRATE PLASTIKE ME DOPIO XHAM	1
V 25	55	270	VESTRATE PLASTIKE ME DOPIO XHAM	15
V 26	60	270	VESTRATE PLASTIKE ME DOPIO XHAM	4
V 27	65	270	VESTRATE PLASTIKE ME DOPIO XHAM	8
V 28	75	270	VESTRATE PLASTIKE ME DOPIO XHAM	11
V 29	80	270	VESTRATE PLASTIKE ME DOPIO XHAM	4
V 30	85	270	VESTRATE PLASTIKE ME DOPIO XHAM	3
V 31	90	270	VESTRATE PLASTIKE ME DOPIO XHAM	20
V 32	95	270	VESTRATE PLASTIKE ME DOPIO XHAM	1
V 33	97.5	270	VESTRATE PLASTIKE ME DOPIO XHAM	2
V 34	100	270	VESTRATE PLASTIKE ME DOPIO XHAM	2
V 35	105	270	VESTRATE PLASTIKE ME DOPIO XHAM	2
V 36	112.5	270	VESTRATE PLASTIKE ME DOPIO XHAM	1
V 37	117.5	270	VESTRATE PLASTIKE ME DOPIO XHAM	2
V 38	120	270	VESTRATE PLASTIKE ME DOPIO XHAM	1
V 39	360	304	VESTRATE PLASTIKE ME DOPIO XHAM	6
V 40	132.5	270	VESTRATE PLASTIKE ME DOPIO XHAM	5
V 41	140	270	VESTRATE PLASTIKE ME DOPIO XHAM	1
V 42	160	270	VESTRATE PLASTIKE ME DOPIO XHAM	4
V 43	175	270	VESTRATE PLASTIKE ME DOPIO XHAM	2
V 44	190	270	VESTRATE PLASTIKE ME DOPIO XHAM	2
V 45	320	304	VESTRATE PLASTIKE ME DOPIO XHAM	1
V 46	360	280	VESTRATE PLASTIKE ME DOPIO XHAM	5
V 46-1	375	280	VESTRATE PLASTIKE ME DOPIO XHAM	1
V 47	693	270	VESTRATE PLASTIKE ME DOPIO XHAM	1
V 48	899	270	VESTRATE PLASTIKE ME DOPIO XHAM	1
V 49	250	220	VESTRATE PLASTIKE ME DOPIO XHAM	2
V 50	395	304	VESTRATE PLASTIKE ME DOPIO XHAM	2

"SPHAERA" sh.p.k
PROJEKTIM
SUPERVIZION
KOLAUDIM

Rruga "QAZIM VATHI" nr 106 Tirane
Mobil 00355 69 20 38 848
e-mail: ajkiddopore@yahoo.com
e-mail: ajkiddopore@sphaera.al

**AUTORITETI KONTRAKTOR
BASHKIA TIRANË**

**"Ndertim i shkollës 9 vjeçare, nr Rr. "Muharrem
Caushi", Njesia Strukturore KA/253".**

Seksioni:

Titulli i vizatimit:
TABELA E DYERVE DHE VETRATAVE

Faza e Projektit:	Data:	GJURIMI I PROJEKTIMIT:	FINJA:	FINJA:
PROJEKT ZBATIMI	Prill 2023	Inzh. AJKID TOPORE	Inzh. NIKOLIN RISILIA	
Nr i Vizatimit:	Shkala:	Inzh. KETINA GEGA	Inzh. ARTUR DADO	
A-122	1:50	Inzh. DHIMITER PAPA	Inzh. MARIO FISHTA	

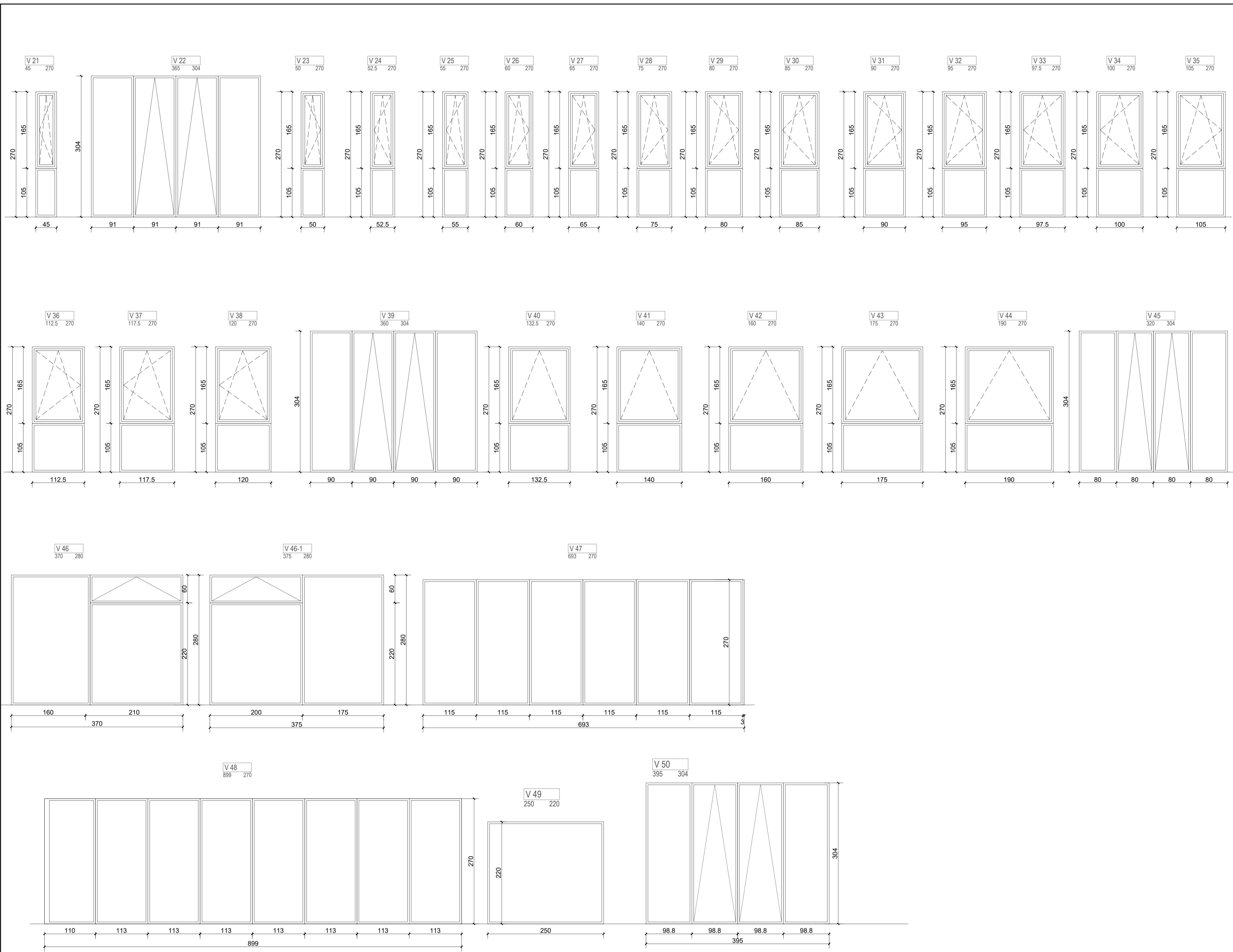

Shenime:

TABELA E VETRATAVE DHE PORTE-VETRATAVE				
E.	GJER.	LART.	SPEC	Count
PV 01	2295	280	VESHJE FASADE ME XHAMI GJYSMJE STRUKTURAL	1
PV 02	2295	270	VESHJE FASADE ME XHAMI GJYSMJE STRUKTURAL	1
PV 03	380	250	PORTE-VETRATE PLASTIKE ME DOPIO XHAM	2
PV 04	365	250	PORTE-VETRATE PLASTIKE ME DOPIO XHAM	1
PV 04-1	365	250	PORTE-VETRATE PLASTIKE ME DOPIO XHAM	1
PV 05	360	250	PORTE-VETRATE PLASTIKE ME DOPIO XHAM	6
PV 06	345	250	PORTE-VETRATE PLASTIKE ME DOPIO XHAM	1
PV 07	310	250	PORTE-VETRATE PLASTIKE ME DOPIO XHAM	1
PV 08	240	280	PORTE-VETRATE PLASTIKE ME DOPIO XHAM	1
PV 09	200	280	PORTE-VETRATE PLASTIKE ME DOPIO XHAM	2
PV 10	195	280	PORTE-VETRATE PLASTIKE ME DOPIO XHAM	1
PV 11	200	280	PORTE-VETRATE PLASTIKE ME DOPIO XHAM	1
PV 12	180	250	PORTE-VETRATE PLASTIKE ME DOPIO XHAM	2
PV 13	155	250	PORTE-VETRATE PLASTIKE ME DOPIO XHAM	1
PV 14	140	250	PORTE-VETRATE PLASTIKE ME DOPIO XHAM	1
PV 15	140	250	PORTE-VETRATE PLASTIKE ME DOPIO XHAM	2
PV 16	580	280	PORTE-VETRATE PLASTIKE ME DOPIO XHAM	1
PV 17	100	280	PORTE-VETRATE PLASTIKE ME DOPIO XHAM	1
PV 18	1997	270	PORTE-VETRATE PLASTIKE ME DOPIO XHAM	1
PV 19	440	304	PORTE-VETRATE PLASTIKE ME DOPIO XHAM	1
PV 20	495	304	PORTE-VETRATE PLASTIKE ME DOPIO XHAM	1
PV 21	365	304	PORTE-VETRATE PLASTIKE ME DOPIO XHAM	1
PV 21-1	365	304	PORTE-VETRATE PLASTIKE ME DOPIO XHAM	1
PV 22	80	280	PORTE-VETRATE PLASTIKE ME DOPIO XHAM	1
PV 23	465	220	PORTE-VETRATE PLASTIKE ME DOPIO XHAM	1
V 01	41	250	VETRATE PLASTIKE ME DOPIO XHAM	1
V 02	45	250	VETRATE PLASTIKE ME DOPIO XHAM	12
V 03	46	250	VETRATE PLASTIKE ME DOPIO XHAM	4
V 04	50	250	VETRATE PLASTIKE ME DOPIO XHAM	7
V 04-1	50	299	VETRATE PLASTIKE ME DOPIO XHAM	13
V 04-2	50	270	VETRATE PLASTIKE ME DOPIO XHAM	13
V 05	60	309	VETRATE PLASTIKE ME DOPIO XHAM	3
V 05-1	60	270	VETRATE PLASTIKE ME DOPIO XHAM	3
V 06	70	280	VETRATE PLASTIKE ME DOPIO XHAM	1
V 07	80	250	VETRATE PLASTIKE ME DOPIO XHAM	6
V 07-1	83	250	VETRATE PLASTIKE ME DOPIO XHAM	1
V 08	116	250	VETRATE PLASTIKE ME DOPIO XHAM	1
V 09	140	280	VETRATE PLASTIKE ME DOPIO XHAM	1
V 10	155	250	VETRATE PLASTIKE ME DOPIO XHAM	20
V 10-1	155	250	VETRATE PLASTIKE ME DOPIO XHAM	1
V 11	175	280	VETRATE PLASTIKE ME DOPIO XHAM	1
V 12	200	280	VETRATE PLASTIKE ME DOPIO XHAM	17
V 12-1	200	280	VETRATE PLASTIKE ME DOPIO XHAM	5
V 12-2	200	270	VETRATE PLASTIKE ME DOPIO XHAM	10
V 13	142.5	250	VETRATE PLASTIKE ME DOPIO XHAM	2
V 14	148	250	VETRATE PLASTIKE ME DOPIO XHAM	1
V 15	145	250	VETRATE PLASTIKE ME DOPIO XHAM	2
V 16	150	250	VETRATE PLASTIKE ME DOPIO XHAM	14
V 17	160	250	VETRATE PLASTIKE ME DOPIO XHAM	3
V 17-1	160	250	VETRATE PLASTIKE ME DOPIO XHAM	2
V 18	32.5	270	VETRATE PLASTIKE ME DOPIO XHAM	9
V 19	37.5	270	VETRATE PLASTIKE ME DOPIO XHAM	23
V 20	40	270	VETRATE PLASTIKE ME DOPIO XHAM	6
V 21	45	270	VETRATE PLASTIKE ME DOPIO XHAM	5
V 22	365	304	VETRATE PLASTIKE ME DOPIO XHAM	8
V 23	50	270	VETRATE PLASTIKE ME DOPIO XHAM	9
V 24	52.5	270	VETRATE PLASTIKE ME DOPIO XHAM	1
V 25	55	270	VETRATE PLASTIKE ME DOPIO XHAM	15
V 26	60	270	VETRATE PLASTIKE ME DOPIO XHAM	4
V 27	65	270	VETRATE PLASTIKE ME DOPIO XHAM	8
V 28	75	270	VETRATE PLASTIKE ME DOPIO XHAM	11
V 29	80	270	VETRATE PLASTIKE ME DOPIO XHAM	4
V 30	85	270	VETRATE PLASTIKE ME DOPIO XHAM	3
V 31	90	270	VETRATE PLASTIKE ME DOPIO XHAM	20
V 32	95	270	VETRATE PLASTIKE ME DOPIO XHAM	1
V 33	97.5	270	VETRATE PLASTIKE ME DOPIO XHAM	2
V 34	100	270	VETRATE PLASTIKE ME DOPIO XHAM	2
V 35	105	270	VETRATE PLASTIKE ME DOPIO XHAM	2
V 36	112.5	270	VETRATE PLASTIKE ME DOPIO XHAM	1
V 37	117.5	270	VETRATE PLASTIKE ME DOPIO XHAM	2
V 38	120	270	VETRATE PLASTIKE ME DOPIO XHAM	1
V 39	360	304	VETRATE PLASTIKE ME DOPIO XHAM	6
V 40	132.5	270	VETRATE PLASTIKE ME DOPIO XHAM	5
V 41	140	270	VETRATE PLASTIKE ME DOPIO XHAM	1
V 42	160	270	VETRATE PLASTIKE ME DOPIO XHAM	4
V 43	175	270	VETRATE PLASTIKE ME DOPIO XHAM	2
V 44	190	270	VETRATE PLASTIKE ME DOPIO XHAM	2
V 45	320	304	VETRATE PLASTIKE ME DOPIO XHAM	1
V 46	360	280	VETRATE PLASTIKE ME DOPIO XHAM	5
V 46-1	375	280	VETRATE PLASTIKE ME DOPIO XHAM	1
V 47	693	270	VETRATE PLASTIKE ME DOPIO XHAM	1
V 48	899	270	VETRATE PLASTIKE ME DOPIO XHAM	1
V 49	250	220	VETRATE PLASTIKE ME DOPIO XHAM	2
V 50	395	304	VETRATE PLASTIKE ME DOPIO XHAM	2

"SPHAERA" sh.p.k
 PROJEKTIM SUPERVIZION KOLAUDIM
 Rruga "QAZIM VATHI" nr 106 Tirane
 Mobil 00355 69 20 38 848
 e-mail: ajkidtopore@yahoo.com
 e-mail: ajkidtopore@sphaera.al

AUTORITETI KONTRAKTOR BASHKIA TIRANË

"Ndertim i shkolles 9 vjeçare, ne Rr. "Muharrem Caushi", Njesia Strukturore KA/253".

Sekcioni:

Titulli i vizatimit:

TABELA E DYERVE DHE VETRATAVE

Faza e Projektit	Data	GJURIMI I PROJEKTIMIT:	FINANSA	FINANSA
PROJEKT ZBATIMI	Prill 2023	Inzh. Ajkide TOPORE	Inzh. Nikolin RISILIA	
Nr. i vizatimit:	Shkala:	Inzh. Kellina GEGA	Inzh. Artur DADO	
A-123	1:50	Inzh. Dhimitër PAPA	Inzh. Mario FISHTA	

DETAJ 1 SH 1/20
SHITESAT E FUSHAVE

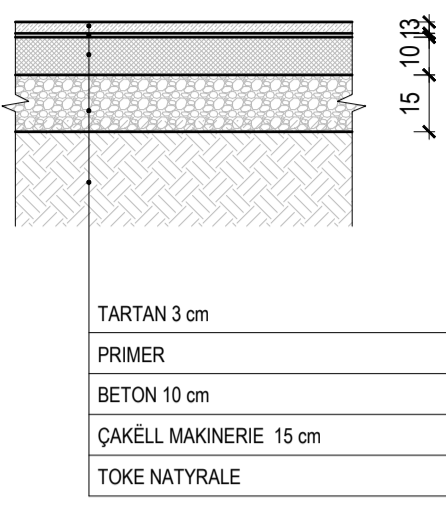

DETAJ 5 SH 1/20
SHIRMI I TROTUARAVE

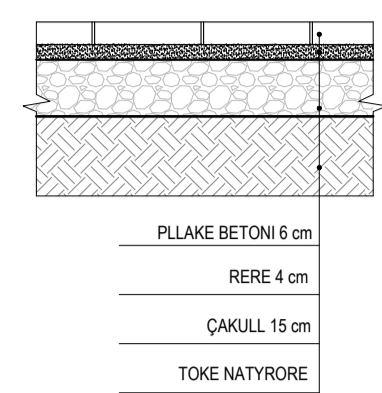

DETAJ 4 SH 1/20
SHIRMI I SHKREJTI

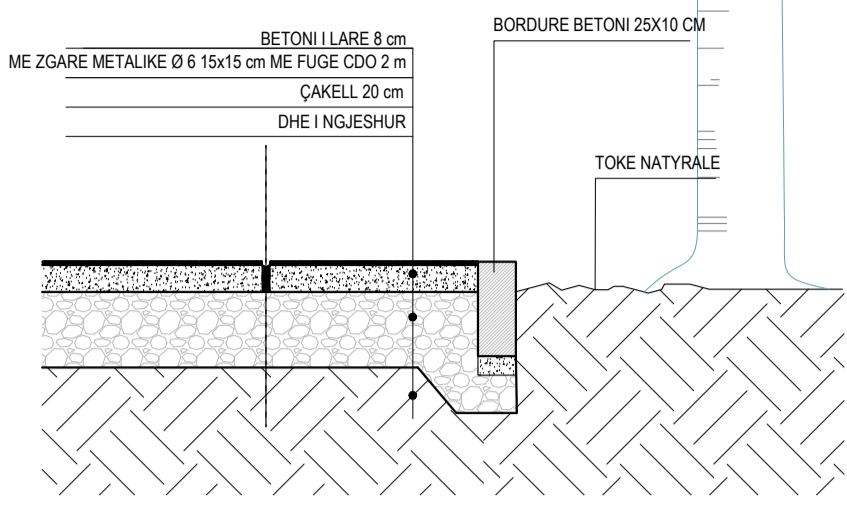

DETAJ 2
PISTA E VRAPIMIT SHK 1/25

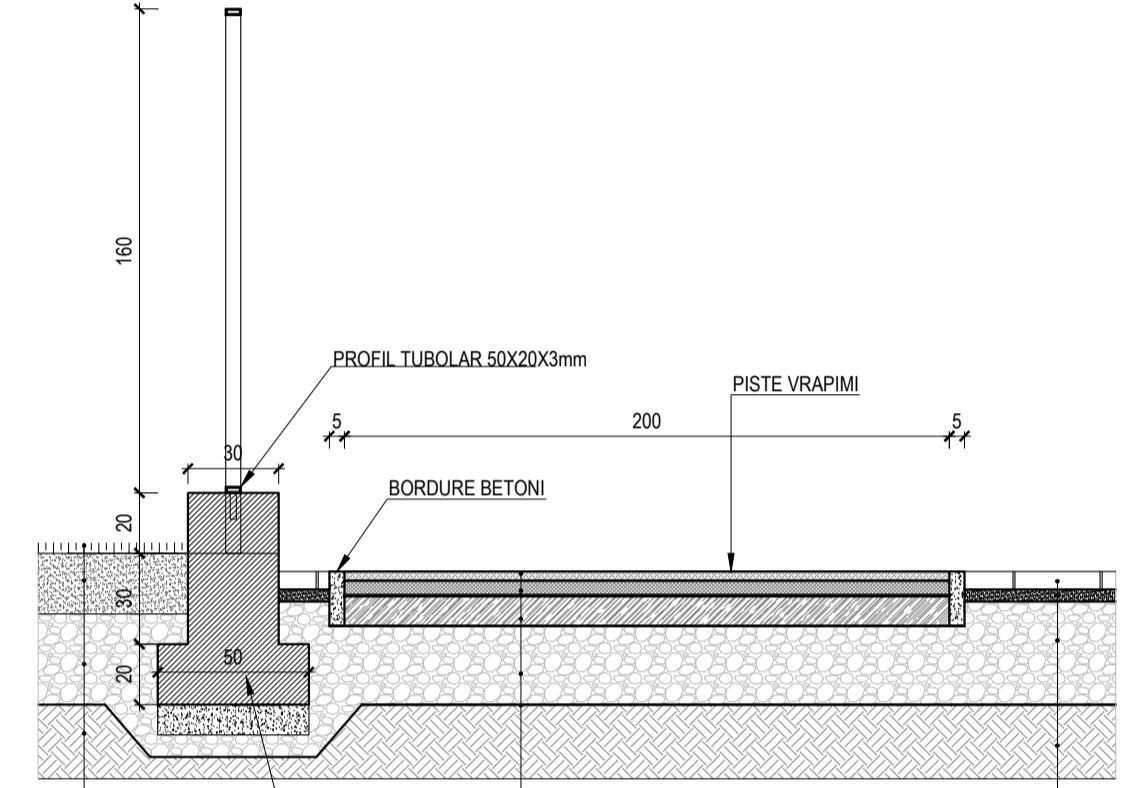
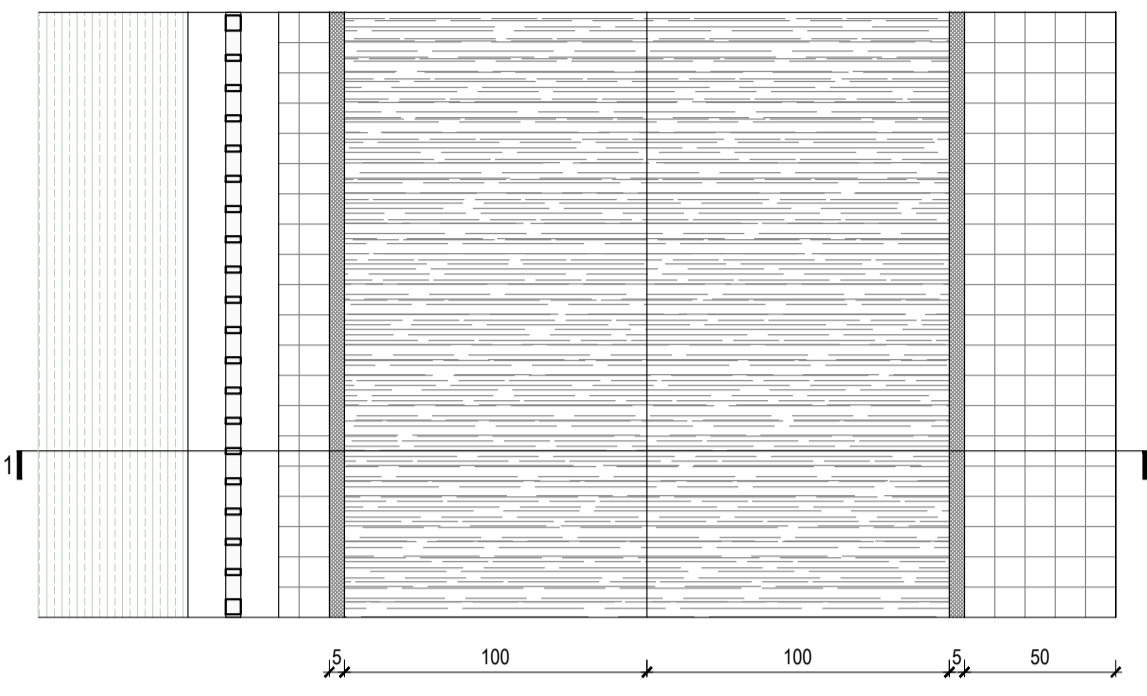

DETAJ 3
SH 1/25

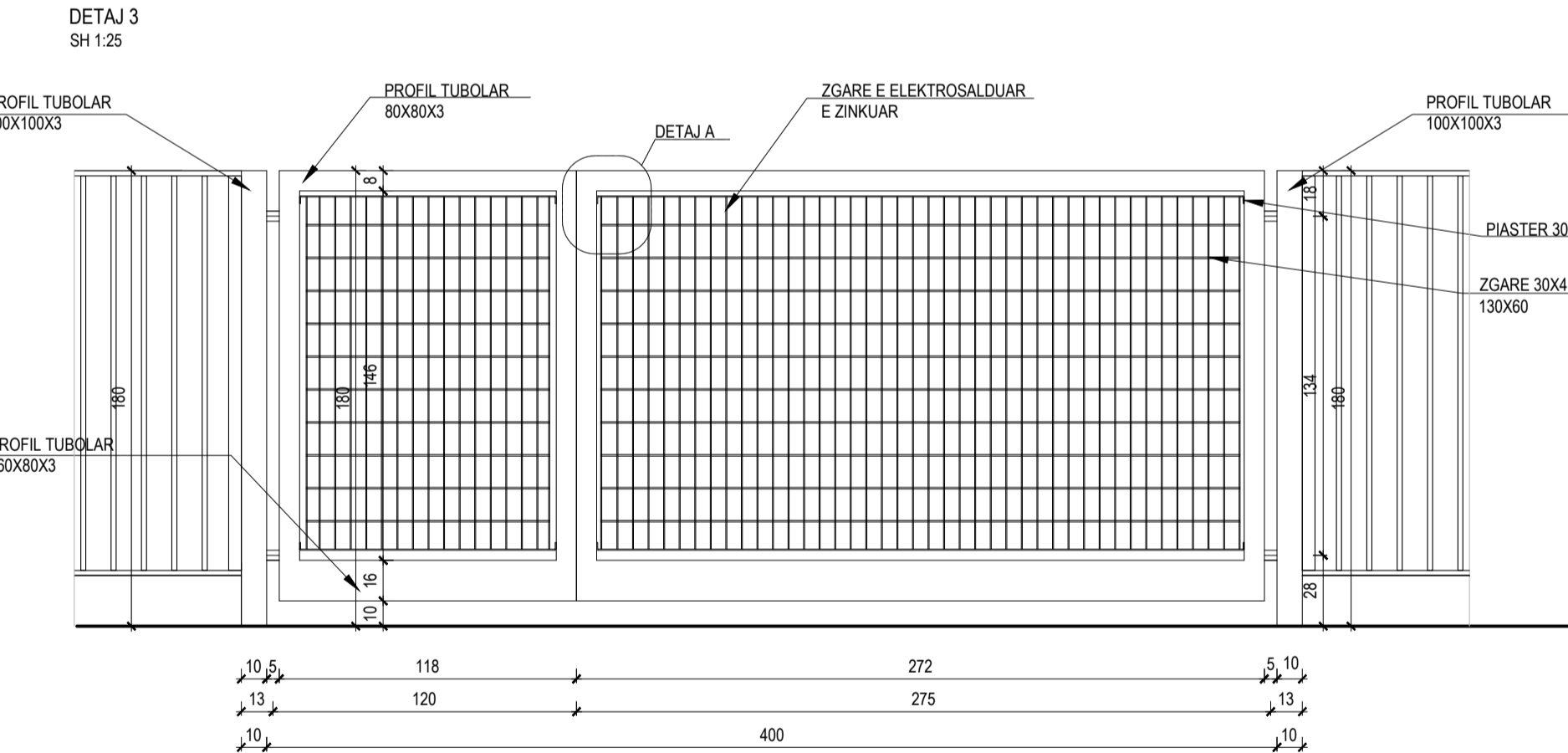

HYRJA KRYESORE

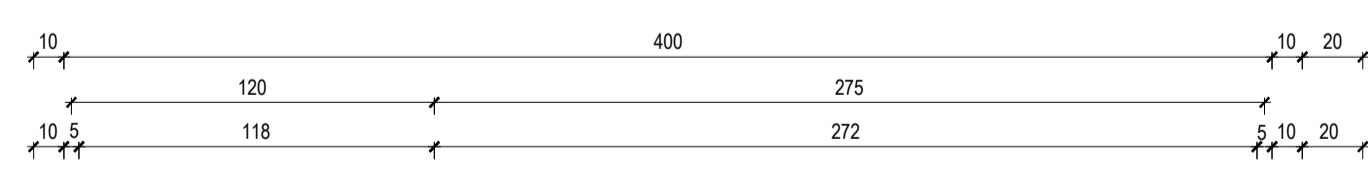

DETAJ 7 SH 1/20
SHITESAT E FUSHAVE

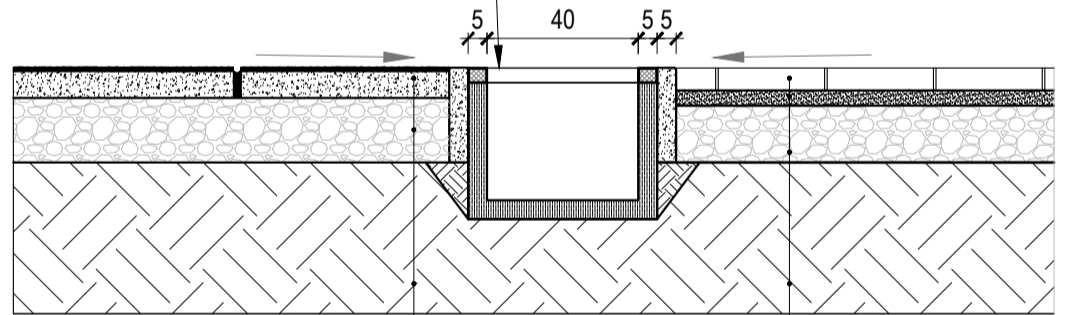

DETAJ 8
KOSH MBETURINASH SH 1/20

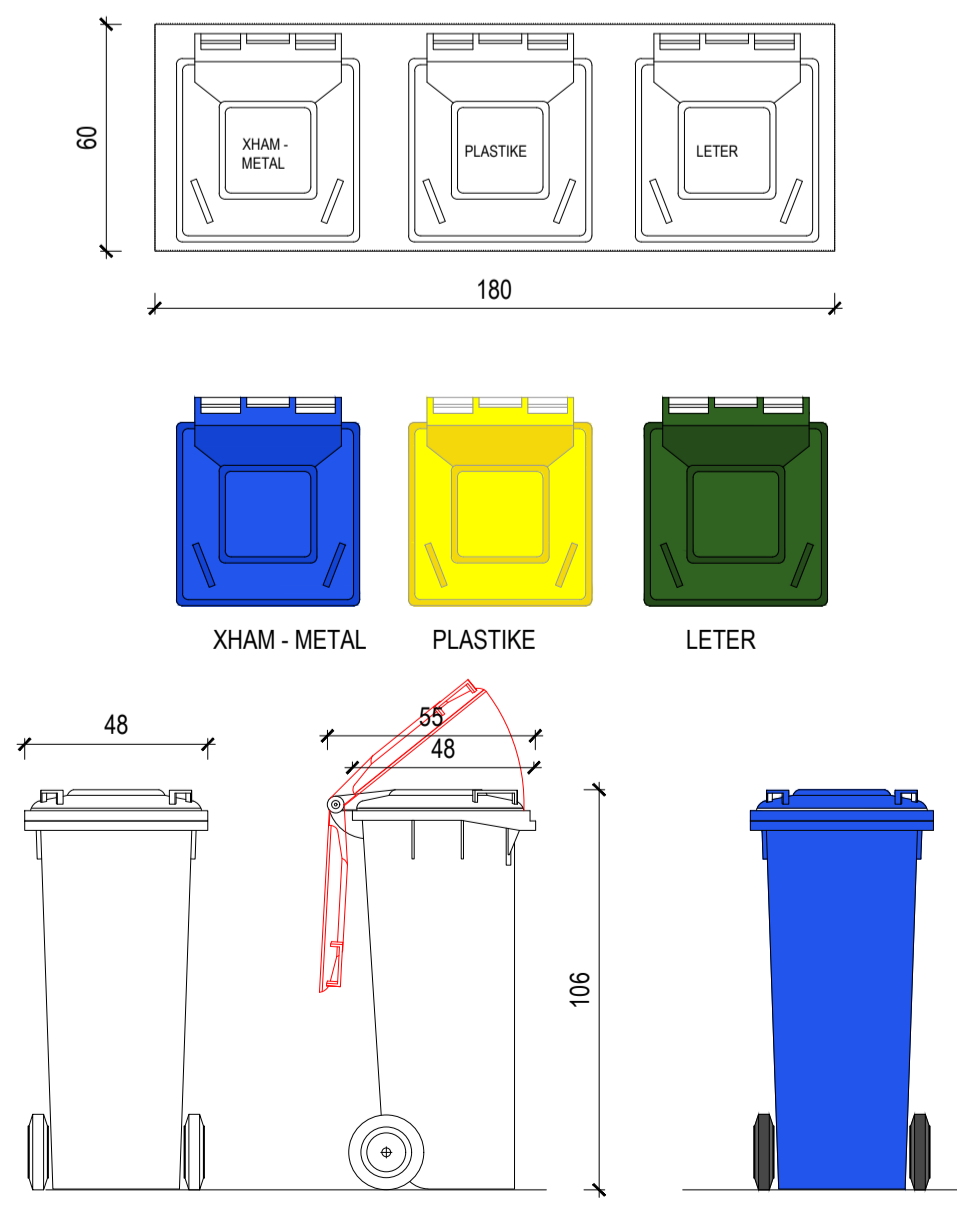

DETAJI SHKALLES
SH 1:10

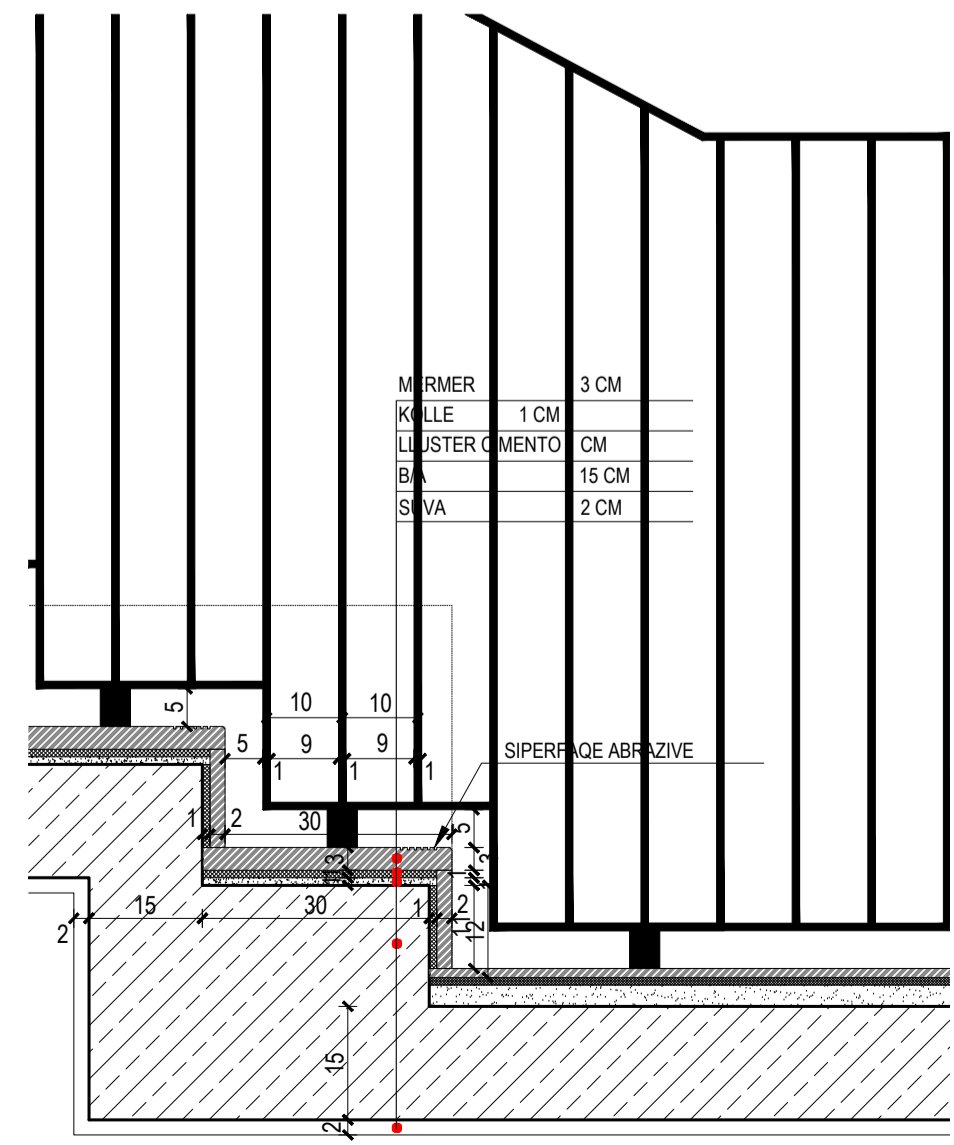

DETAJ 9
SHKALLET E HOLLIT KRRESOR SH 1/50

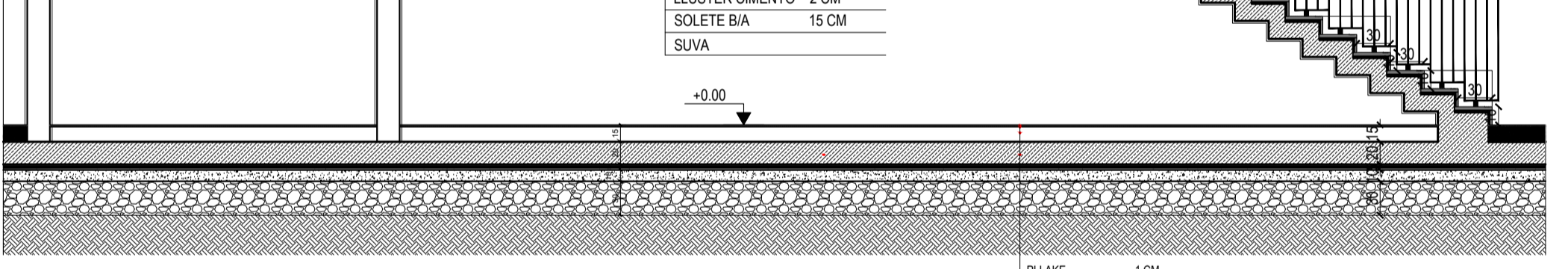

Shenime:

"SPHAERA" sh.p.k
PROJEKTIM SUPERVIZION KOLAUDIM
Rruga "QAZIM VATHI" nr 106 Tirane
Mobil 00355 69 20 38 848
e-mail: ajkidtopore@yahoo.com
e-mail: ajkidtopore@sphaera.al

AUTORITETI KONTRAKTOR BASHKIA TIRANË

"Ndërtim i shkollës 9 vjeçare, ne Rr. "Muharrem Caushi", Njesia Strukturore KA/253".

Sektori:
Titulli i vizatimit:
DETAJE

Faza e Projektit: PROJEKT ZBATIMI	Data: Prill 2023	Grupi i Projektimit: Inzh. Ajkë TOPORE Ark. Këlmeta GEGA Inzh. Dhimitër PAPA Inzh. Mario FISHTA	Firma: Inzh. Nikolin RISILIA Inzh. Artur DADO	Firma:
---	----------------------------	---	---	--------

DETAJI 10 SH 1:25

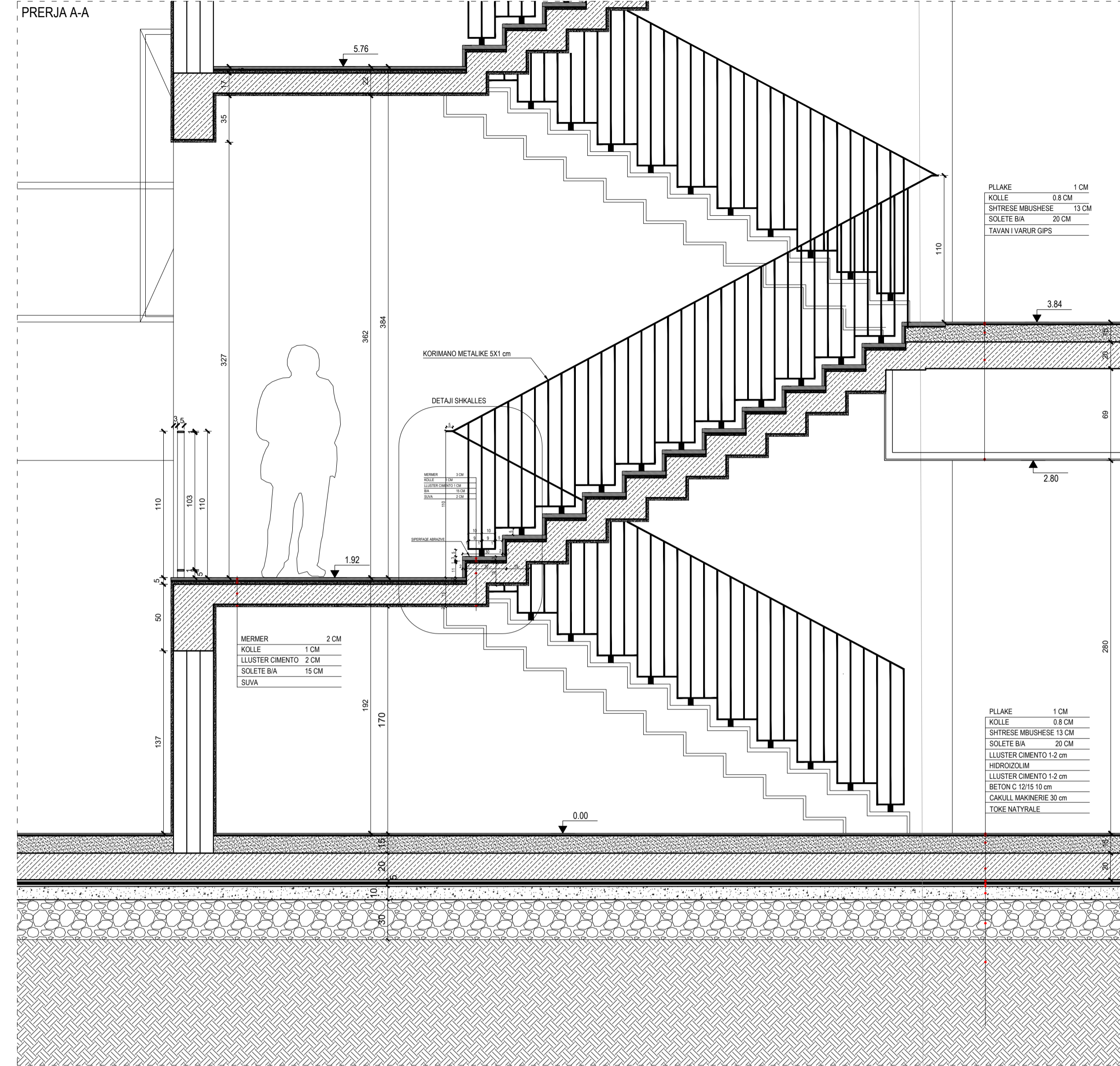

DETAJI SHKALLES SH 1:10

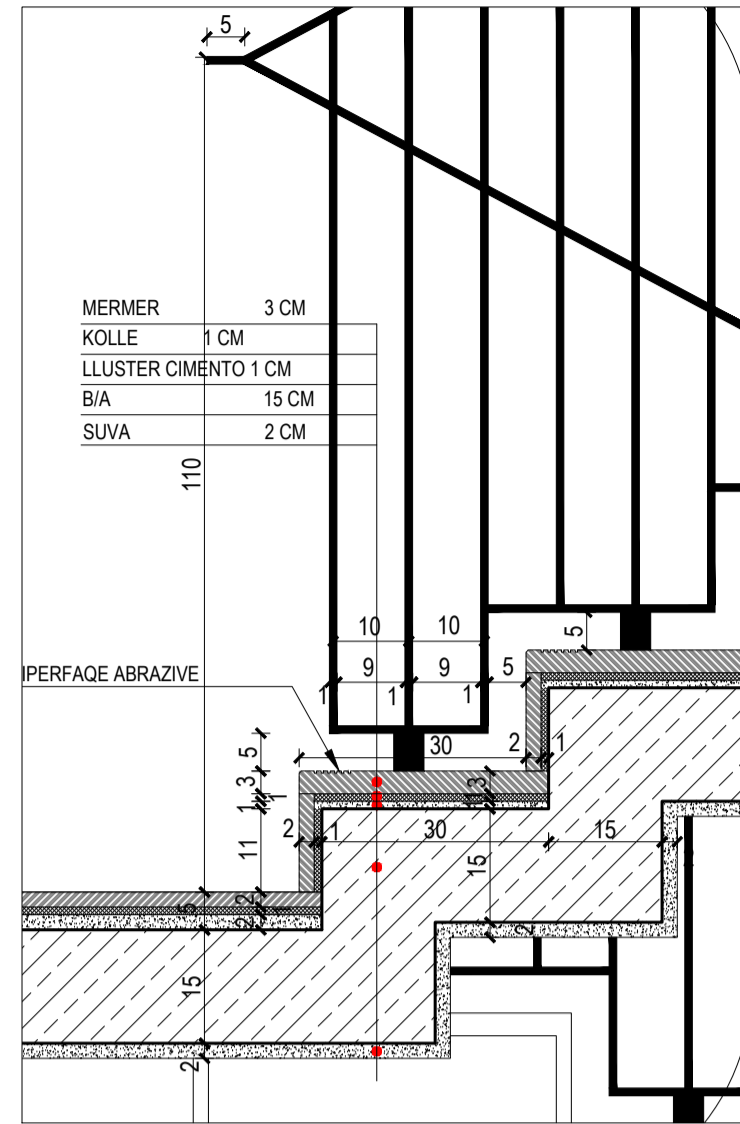

DETAJI 11 SH 1:20

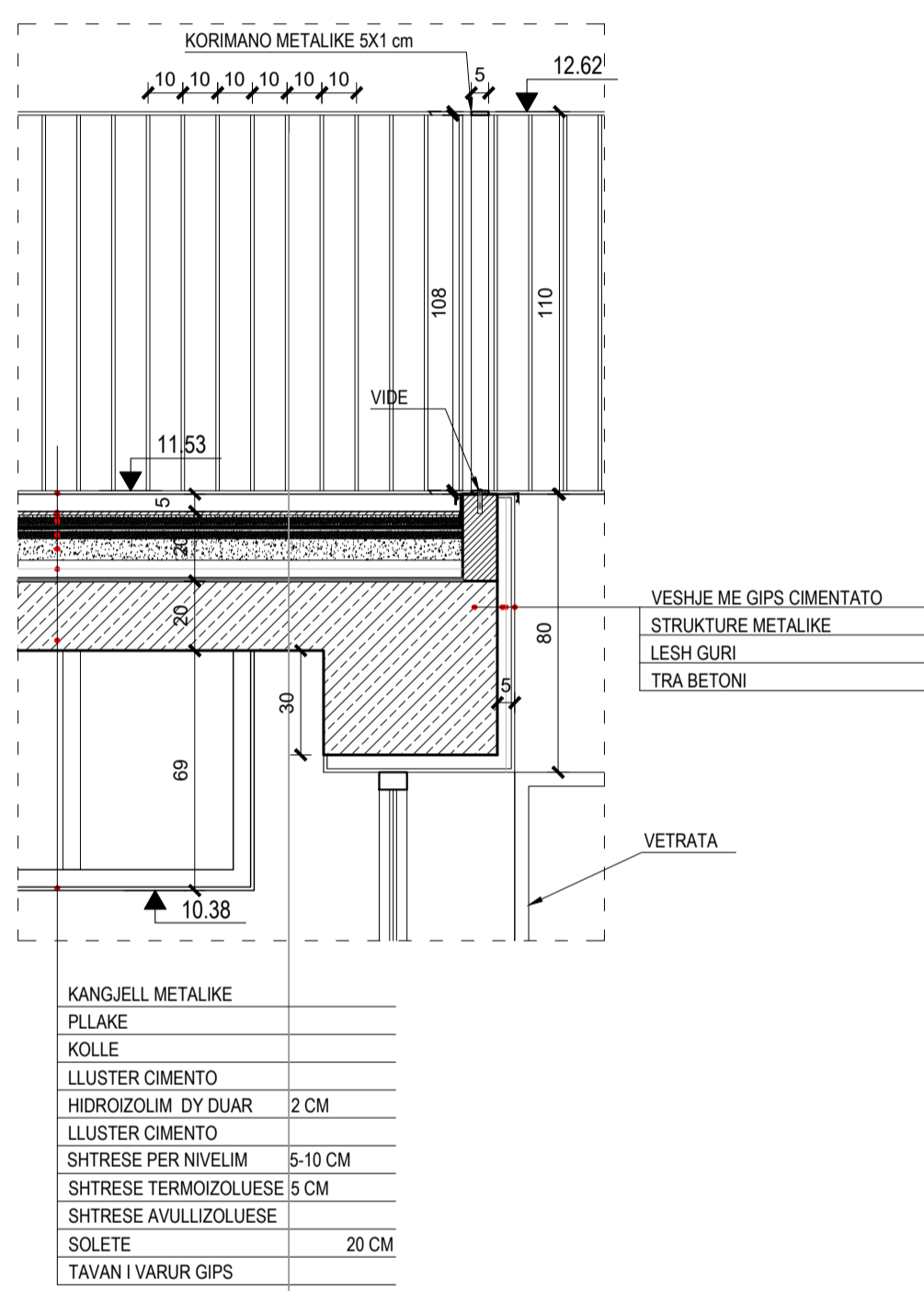

DETAJI 12 SH 1:20

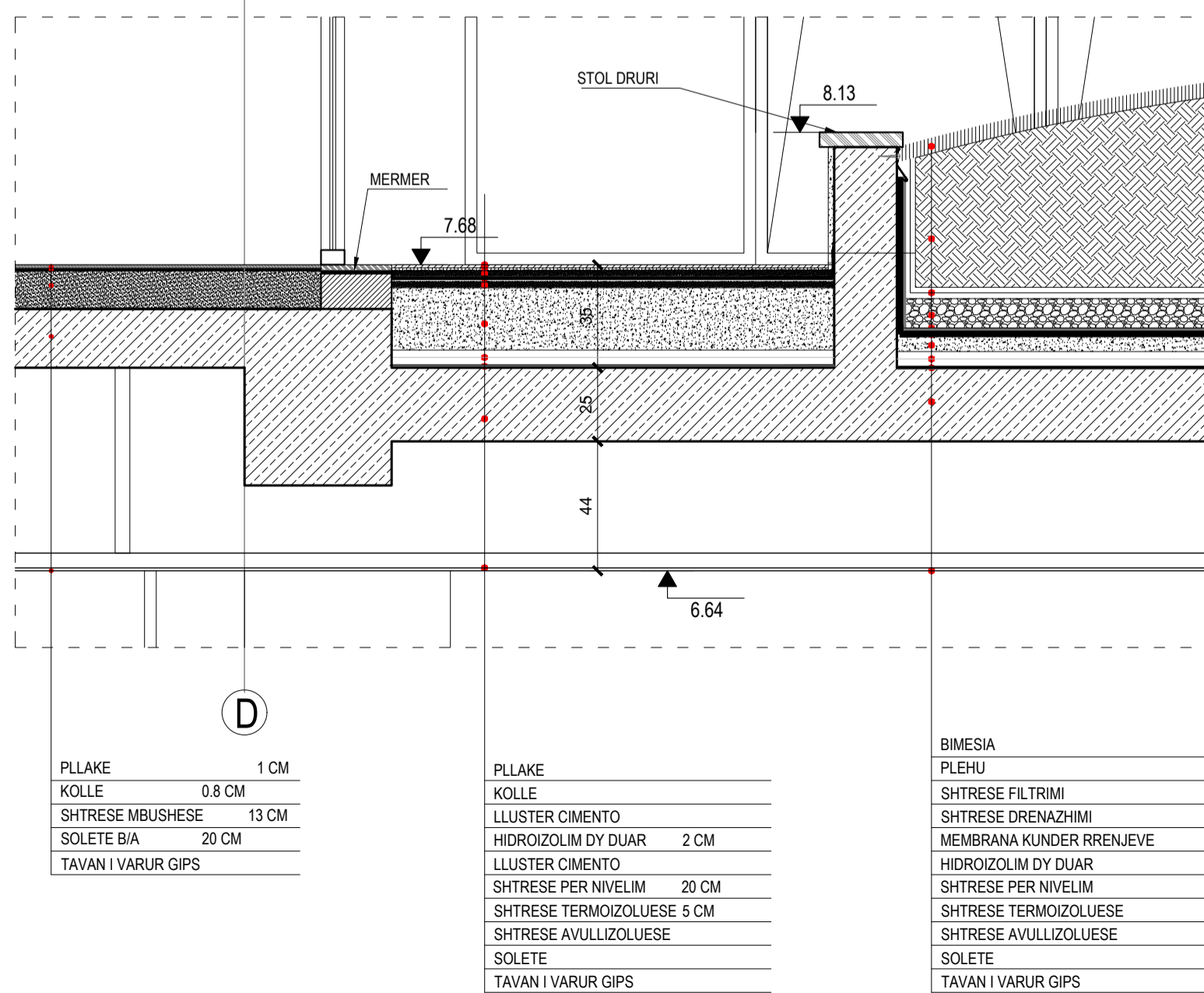

DETAJI 13 SH 1:20

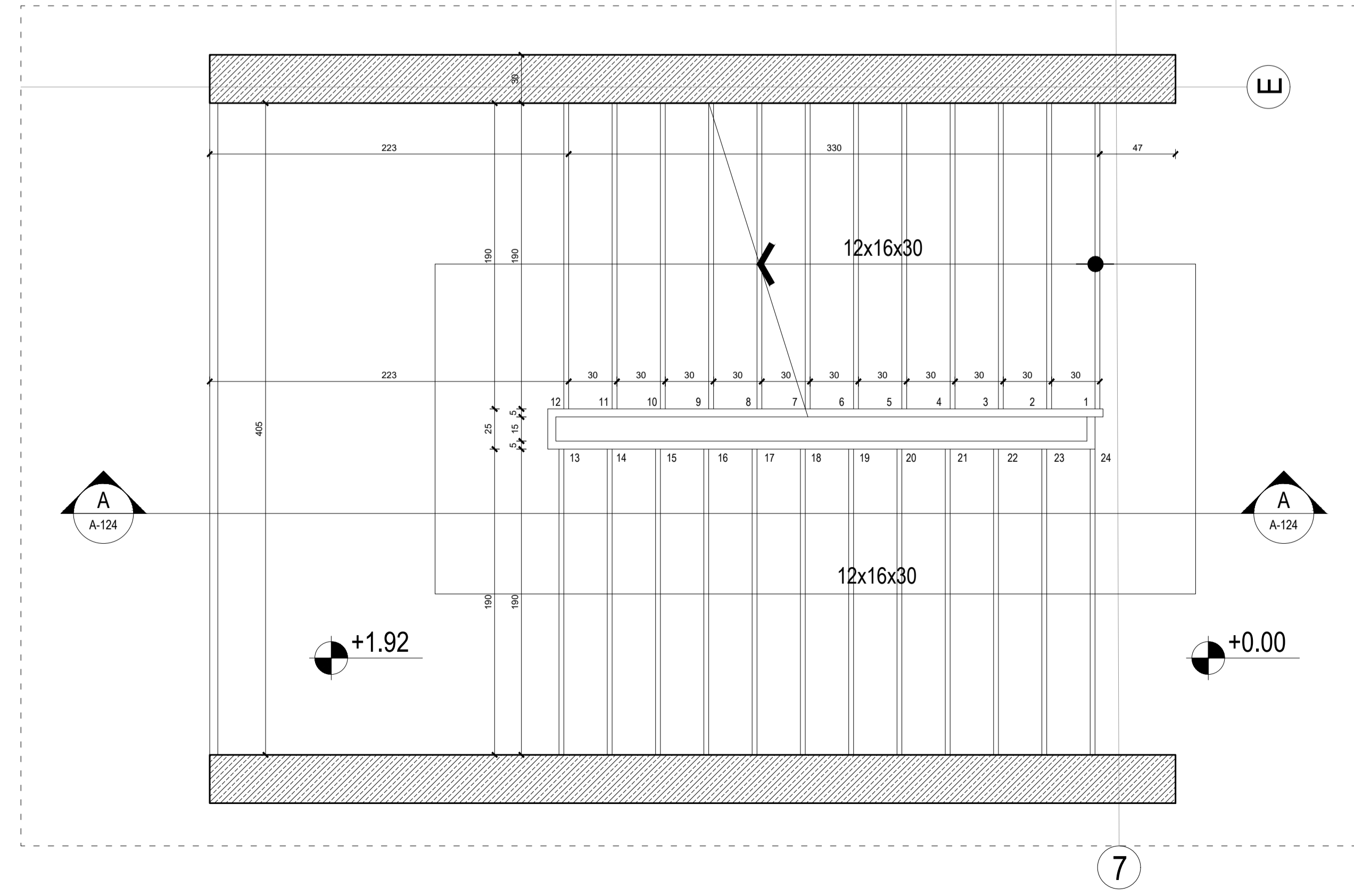
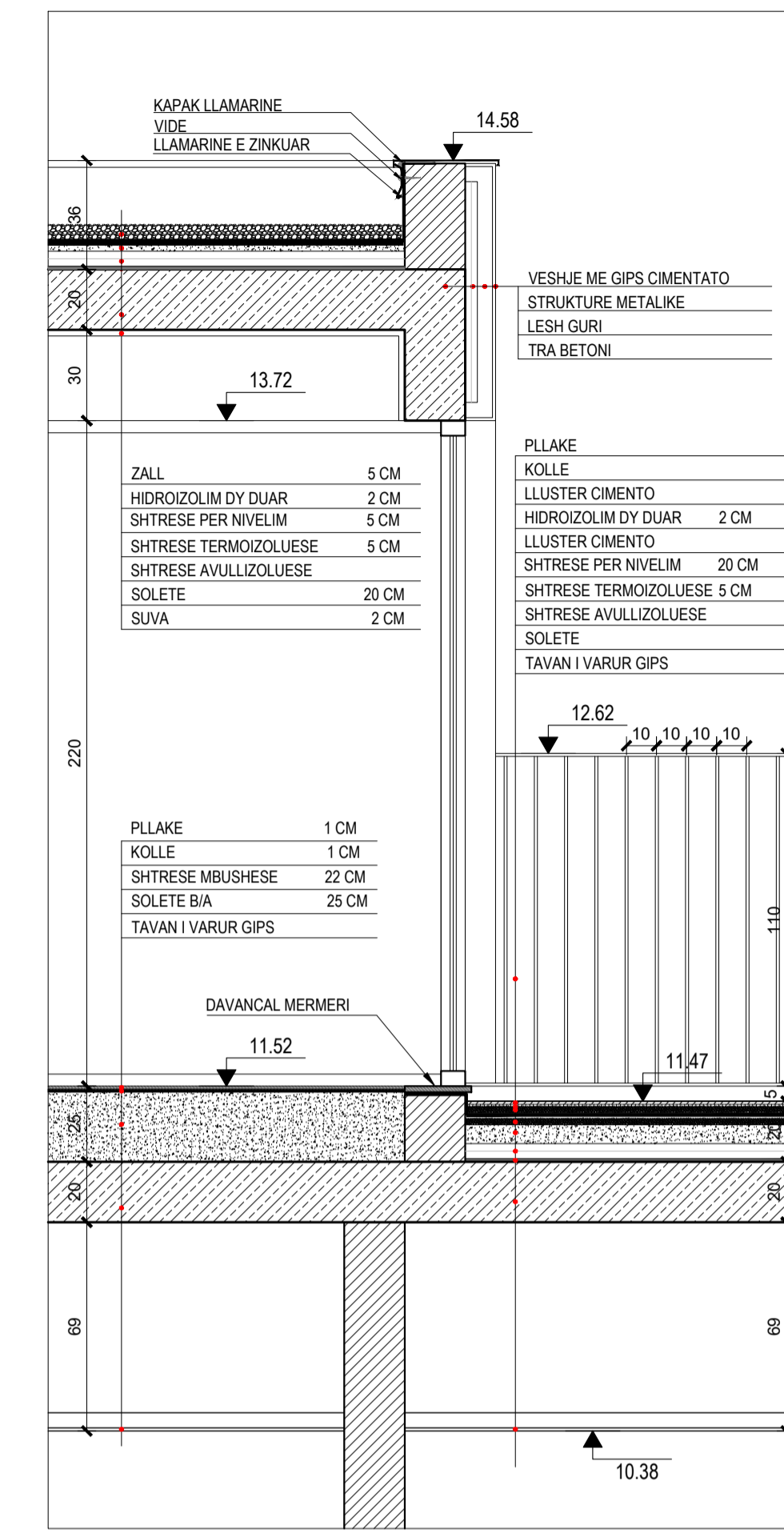

Shenime:



Rruga "QAZIM VATHI" nr 106 Tirane
Mobil 00355 69 20 38 848

e-mail: ajkidtopore@yahoo.com
e-mail: ajkidtopore@sphaera.al



**AUTORITETI KONTRAKTOR
BASHKIA TIRANË**

**"Ndërtim i shkollës 9 vjeçare, ne Rr. "Muharrem
Caushi", Njesia Strukturore KA/253".**

Sektori:

Titulli i vizatimit:

DETAJE

Faza e Projektit	DATA	GRUPI I PROJEKTIMIT	FIRMA	FIRMA
PROJEKT ZBATIMI	Prill 2023	Insh. AJKID TOPORE	Insh. NIKOLIN RISILIA	
Nr i Vizimit	Shkala	Insh. KETINA GEGA	Insh. ARTUR DADO	
A-125	1:10,20,25	Insh. DHIMITER PAPA	Insh. MARIO FISHTA	



Rruga "QAZIM VATHI" nr 106 Tirane
 Mobil 00355 69 20 38 848

e-mail: ajkiddopore@yahoo.com
 e-mail: ajkiddopore@sphaera.al



**AUTORITETI KONTRAKTOR
 BASHKIA TIRANË**

**"Ndertim i shkolles 9 vjeçare, ne Rr. "Muharrem
 Caushi", Njesia Strukturore KA/253".**

Sektori:

Titulli i vizatimit:

IMAZHE TE OBJEKTIT

Faza e Projektit	Dati	GRUPA I PROJEKTIMIT:	FIRMA	FIRMA
PROJEKT ZBATIMI	Prill 2023	Inzh. AJKID TOPORE	Inzh. NIKOLIN RISILIA	
Nr. i vizimit:	Shteta	Ark. KETINA GEGA	Inzh. ARTUR DADO	
A-128		Inzh. DHIMITER PAPA		
		Inzh. MARIO FISHTA		



Shenime:



Rruga "QAZIM VATHI" nr 106 Tirane
Mobil 00355 69 20 38 848

e-mail: ajkiddtopore@yahoo.com
e-mail: ajkiddtopore@sphaera.al



**AUTORITETI KONTRAKTOR
BASHKIA TIRANË**

**"Ndërtim i shkolles 9 vjeçare, ne Rr. "Muharrem
Caushi", Njesia Strukturore KA/253".**

Seksioni:

Titulli i vizatimit:

IMAZHE TE OBJEKTIT

Faza e Projektit	Data	Grupi i Projektimit	Firma	Firma
PROJEKT ZBATIMI	Prill 2023	Inzh. Ajsë TOPORE	Inzh. Nikolin RISILIA	
Nr. i vizatimit	Skala	Ark. Ketiha GEGA	Inzh. Artur DADO	
A-129		Inzh. Dhimitër PAPA		
		Inzh. Mario FISHTA		

Shenime:



Rruga "QAZIM VATHI" nr 106 Tirane
 Mobil 00355 69 20 38 848

e-mail: ajkidtopore@yahoo.com
 e-mail: ajkidtopore@sphaera.al



**AUTORITETI KONTRAKTOR
 BASHKIA TIRANË**

**"Ndertim i shkolles 9 vjeçare, ne Rr. "Muharrem
 Caushi", Njesia Strukturore KA/253".**

Sektori:

Titulli i vizatimit:

IMAZHE TE OBJEKTIT

Faza e Projektit	Data	Grupi i Projektimit	Firma	Firma
PROJEKT ZBATIMI	Prill 2023	Inzh. AJKID TOPORE	Inzh. Nikolin RISILIA	
Nr. i vizimit	Skala	Ark. Ketiina GEGA	Inzh. Artur DADO	
A-130		Inzh. Dhimitër PAPA		
		Inzh. Mario FISHTA		

Shenime:



Rruga "QAZIM VATHI" nr. 106 Tirane
 Mobil 00355 69 20 38 848

e-mail: ajkiddtopore@yahoo.com
 e-mail: ajkiddtopore@sphaera.al



**AUTORITETI KONTRAKTOR
 BASHKIA TIRANË**

**"Ndërtim i shkolles 9 vjeçare, ne Rr. "Muharrem
 Caushi", Njesia Strukturore KA/253".**

Sektori:

Titulli i vizatimit:

IMAZHE TE OBJEKTIT

Faza e Projektit	Data	Grupi i Projektimit	Firma	Firma
PROJEKT ZBATIMI	Prill 2023	Inzh. AJKID TOPORE	Inzh. Nikolin RISILIA	
Nr. i Vizimit:	Shteta	Inzh. Kellina GEGA	Inzh. Artur DADO	
A-131		Inzh. Dhimitër PAPA		
		Inzh. Mario FISHTA		



Shenime:



Rruga "QAZIM VATHI" nr 106 Tirane
Mobil 00355 69 20 38 848

e-mail: ajkidtopore@yahoo.com
e-mail: ajkidtopore@sphaera.al



**AUTORITETI KONTRAKTOR
BASHKIA TIRANË**

**"Ndërtim i shkollës 9 vjeçare, ne Rr. "Muharrem
Caushi", Njesia Strukturore KA/253".**

Sektori:

Titulli i vizatimit:

IMAZHE TE OBJEKTIT

Faza e Projektit	Data	Grupi i Projektimit	Firma	Firma
PROJEKT ZBATIMI	Prill 2023	Inzh. Ajsid TOPORE	Inzh. Nikolin RISILIA	
Nr. i vizimit:		Ark. Ketiina GEGA	Inzh. Artur DADO	
A-132		Inzh. Dhimitër PAPA		
		Inzh. Mario FISHTA		