

## BASHKIA KAMEZ

DREJTORIA E SHERBIMEVE PUBLIKE  
DREJTORIA E PROJEKTEVE DHE INVESTIMEVE  
DEPARTAMENTI I PROJEKTEVE

Dr. e Projekteve e Investimeve	FLORA MUCA								
STAFI TEKNIK PROJEKTUES	<table border="1" style="width: 100%; border-collapse: collapse;"> <tr><td style="width: 20%;">Ing.</td><td>ARJOLA KURTI</td></tr> <tr><td>Ing.</td><td>ERBLIN LALA</td></tr> <tr><td>Ing.</td><td>DENIS PRENCI</td></tr> <tr><td>Ing.</td><td>RAMADAN HYSA</td></tr> </table>	Ing.	ARJOLA KURTI	Ing.	ERBLIN LALA	Ing.	DENIS PRENCI	Ing.	RAMADAN HYSA
Ing.	ARJOLA KURTI								
Ing.	ERBLIN LALA								
Ing.	DENIS PRENCI								
Ing.	RAMADAN HYSA								
Titulli i Projektit	Faza e Projektit								
NDERTIM RRUGET "PJESHKORE, VELIPOJE, + RRUGICAT, BALLSHI, VALIAS PINGUL ME HEKURAN DEDEN LAKNAS"	PROJEKT ZBATIMI								
Emertimi i Fletes	Data e Implementimit :								
PROFLET TERTHORE	Shkalla e Vizimit <b>1:200</b>								
	Fleta Nr. <b>18</b>								

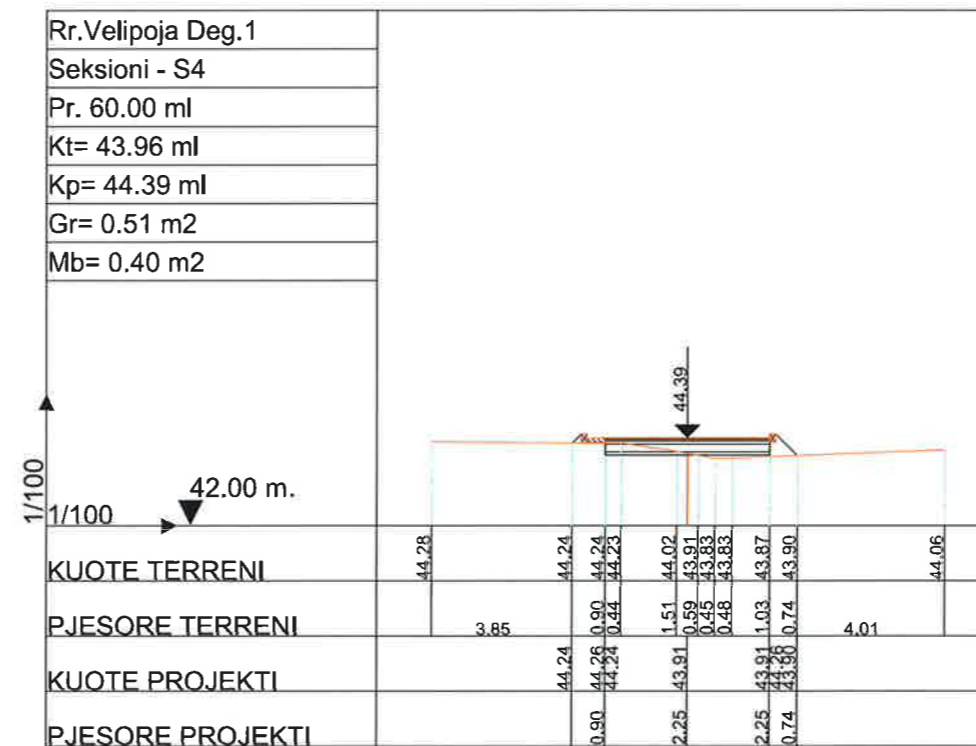
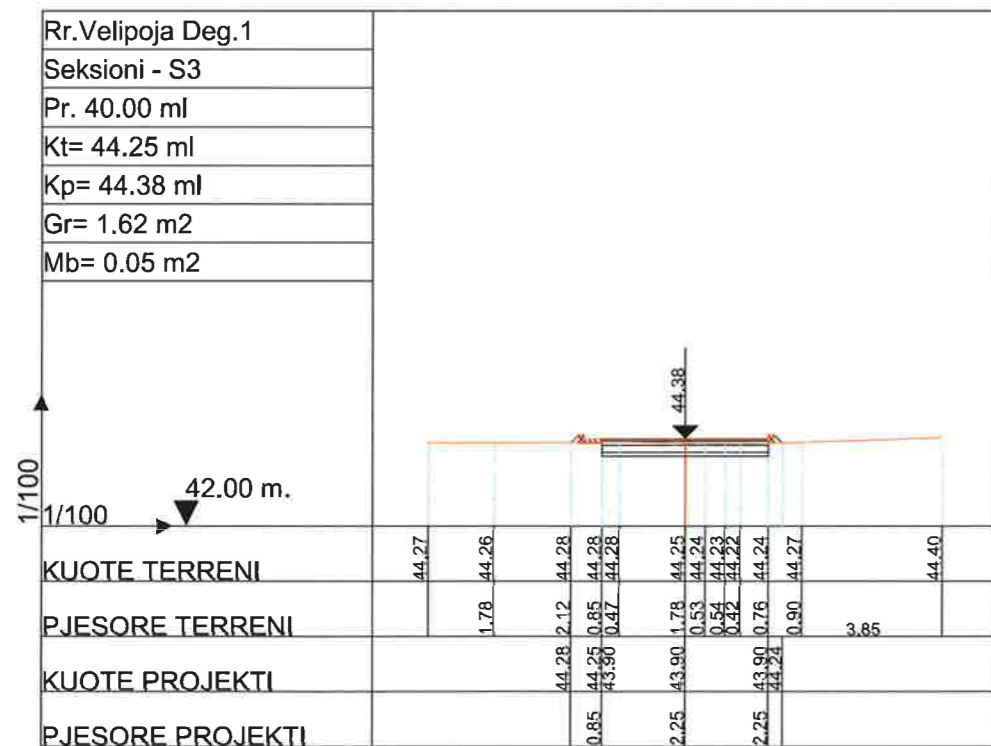
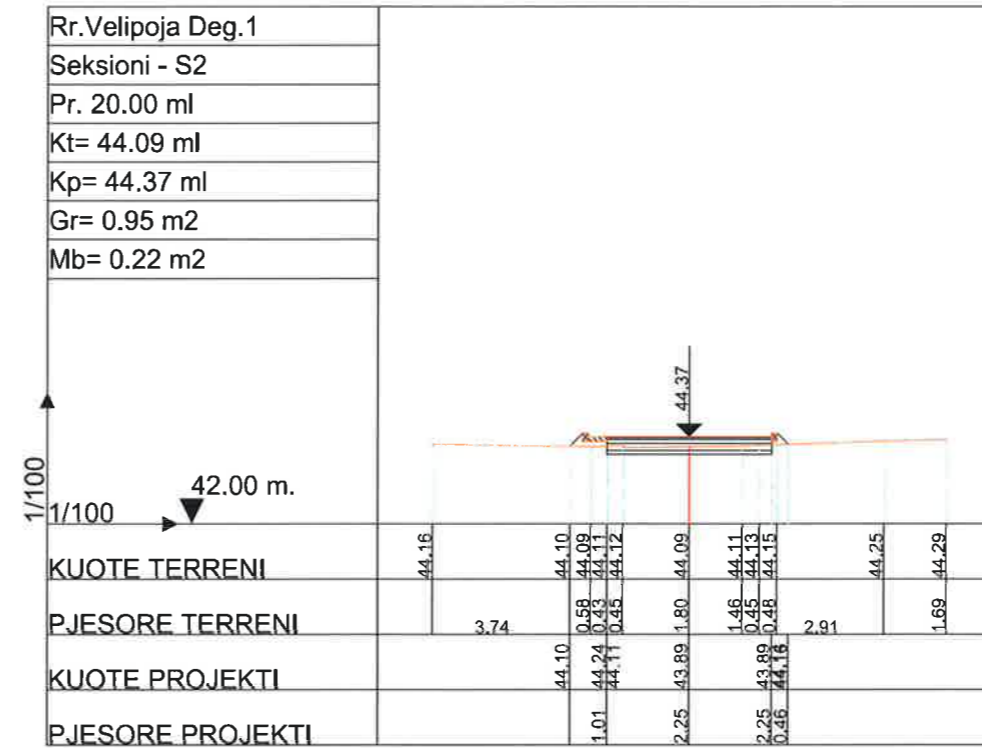
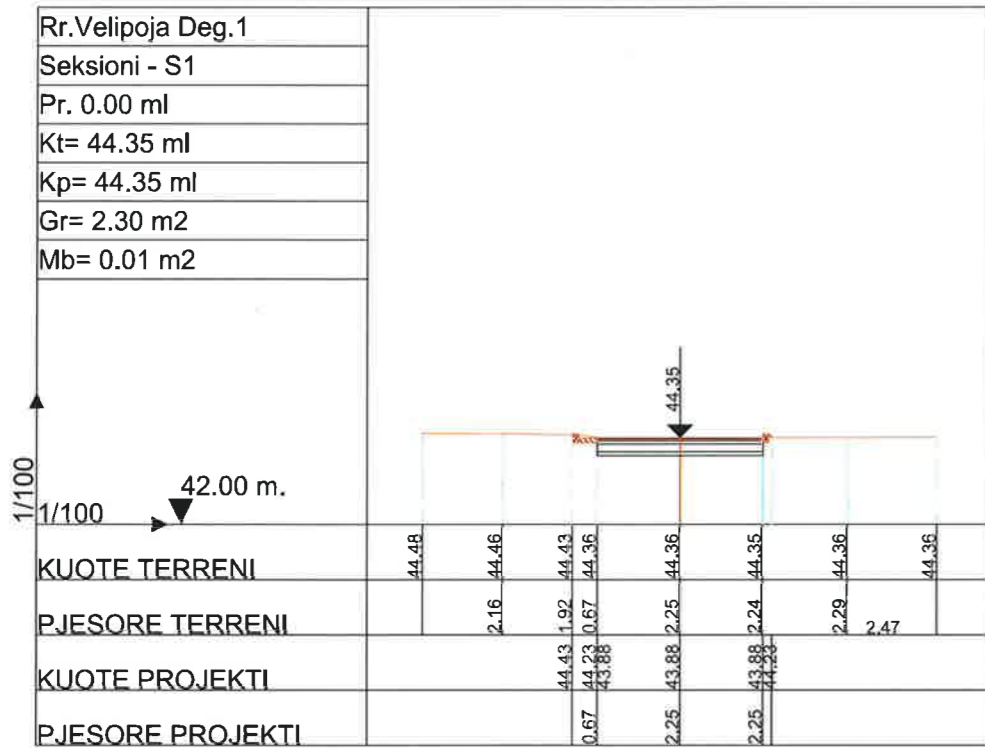

## BASHKIA KAMEZ

DREJTORIA E SHERBIMEVE PUBLIKE  
DREJTORIA E PROJEKTEVE DHE INVESTIMEVE  
DEPARTAMENTI I PROJEKTEVE

Dr. e Projekteve e Investimeve	FLORA MUCA	
STAFI TEKNIK PROJEKTES	Ing. ARJOLA KURTI	
	Ing. ERBLIN LALA	
	Ing. DENIS PRENCI	
	Ing. RAMADAN HYSA	
Titulli i Projektit		Faza e Projektit
NDERTIM RRUGET		PROJEKTI ZBATIMI
*PJESHKORE, VELIPOJE, + RRUGICAT, BALLSHI, VALIAS		Data e Implementimit :
PINGUL ME HEKURAN DEKEN LAKNAS*		Shkalla e Vizatimit :
Emerimi i Fletes		1:200
PROFILET TERTHORE		Fleta Nr.
		19

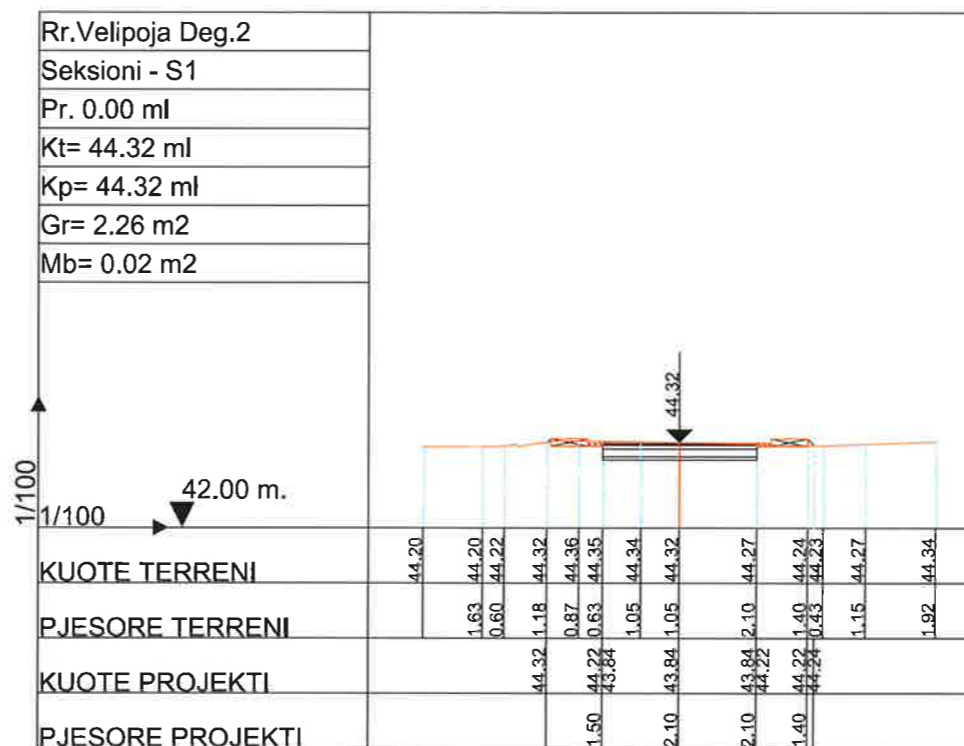
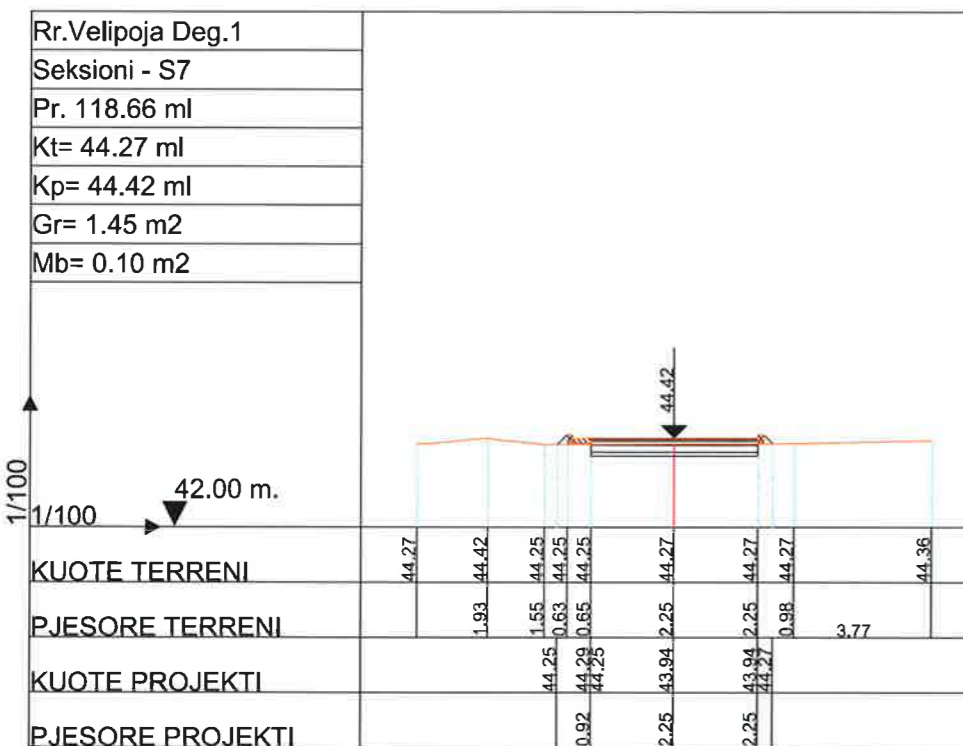
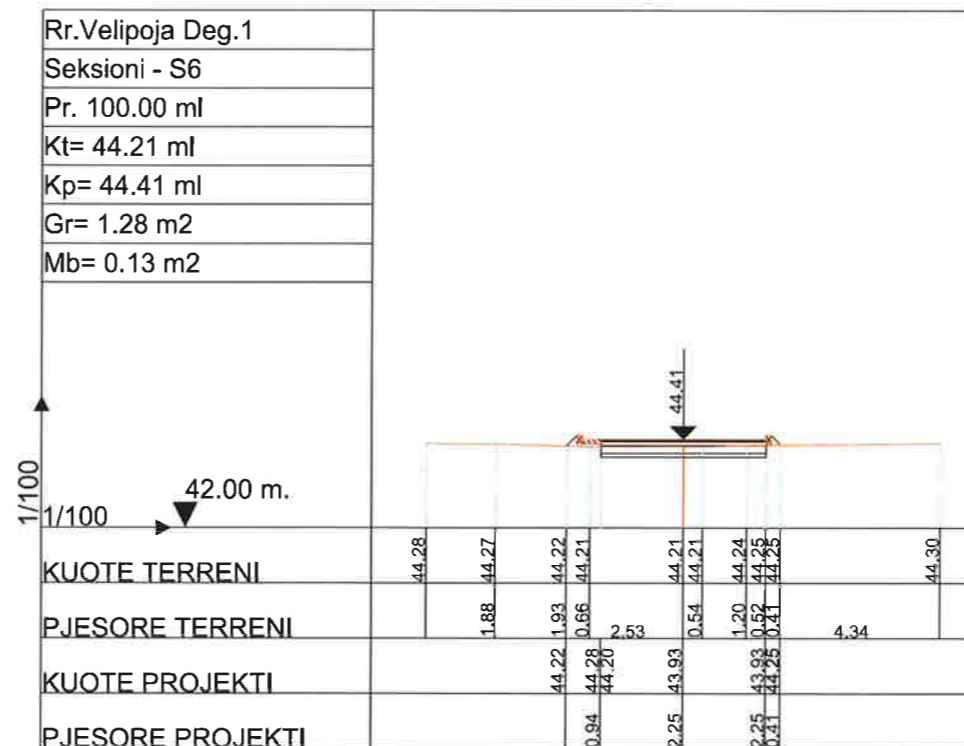
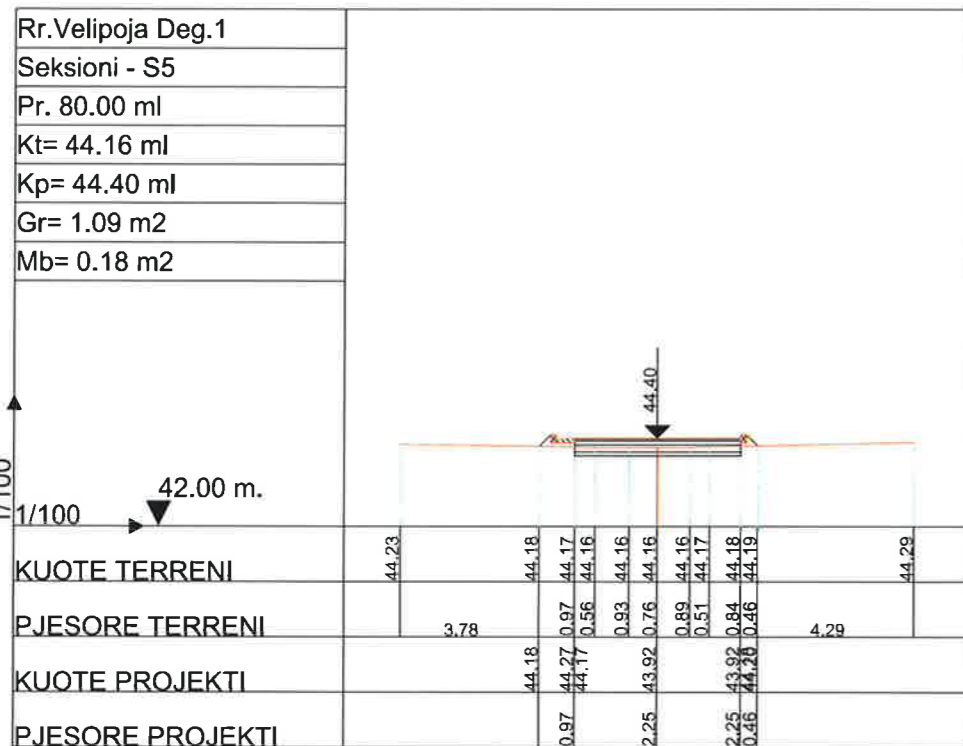

## BASHKIA KAMEZ

DREJTORIA E SHERBIMEVE PUBLIKE  
DREJTORIA E PROJEKTEVE DHE INVESTIMEVE  
DEPARTAMENTI I PROJEKTEVE

Dr. e Projekteve e Investimeve	FLORA MUCA	
STAFI TEKNIK PROJEKTUES	Ing. ARJOLA KURTI	
	Ing. ERBLIN LALA	
	Ing. DENIS PRENCI	
	Ing. RAMADAN HYSA	

Titulli i Projektit <b>NDERTIM RRUGET          "PJESHKORE, VELIPOJE, + RRUGICAT, BALLSHI,          VALIAS          PINGUL ME HEKURAN DEDEN LAKNAS"</b>	Faza e Projektit <b>PROJEKT ZBATIMI</b>
Emeritimi i Fietes <b>PROFILET TERTHORE</b>	Shkalla e Vizatimit <b>1:200</b>
	Fleta Nr. <b>20</b>



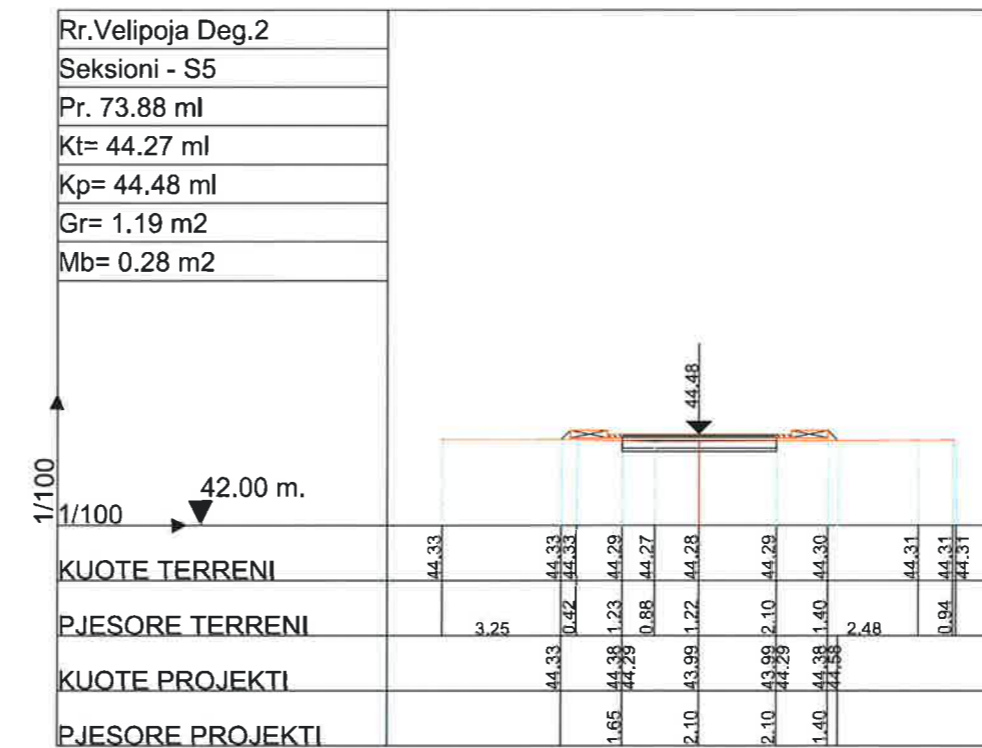
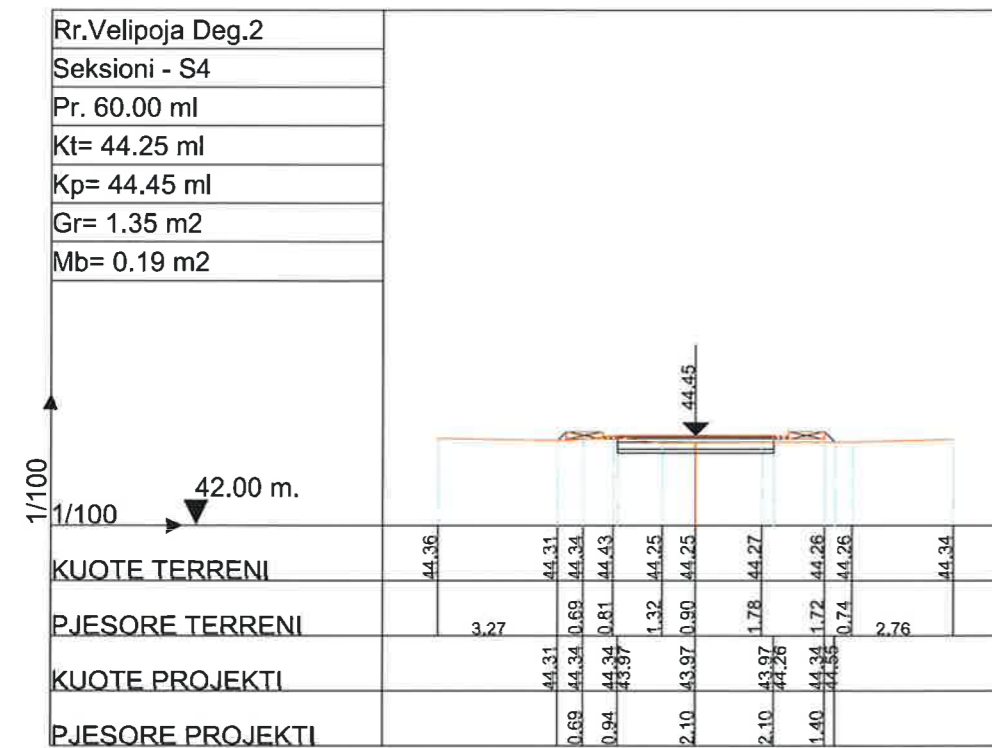
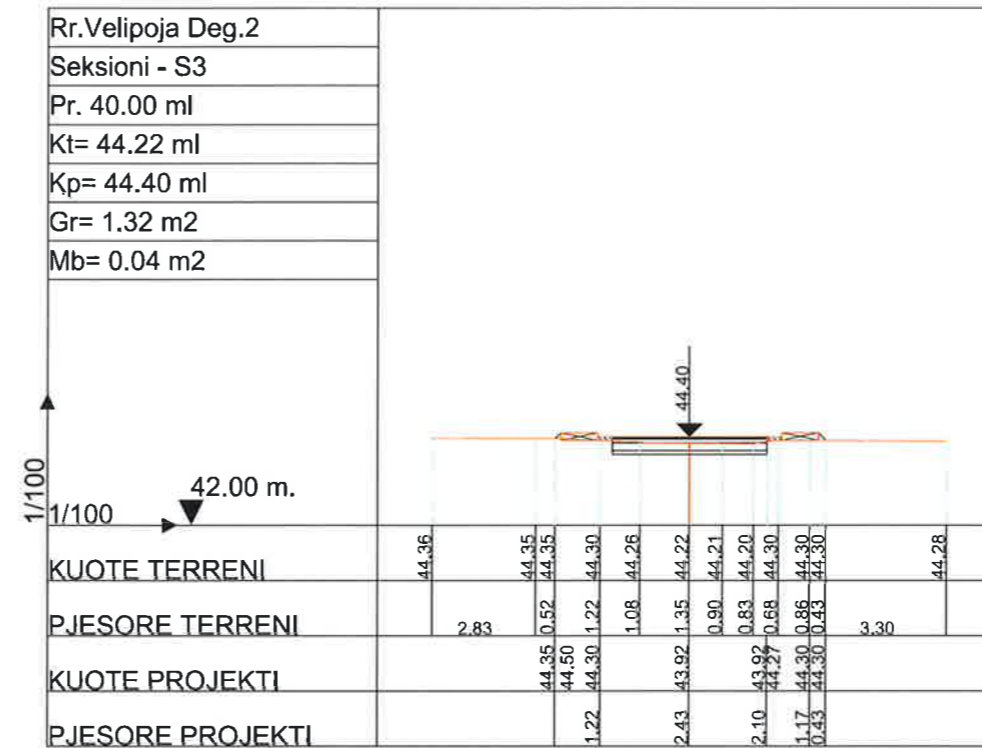
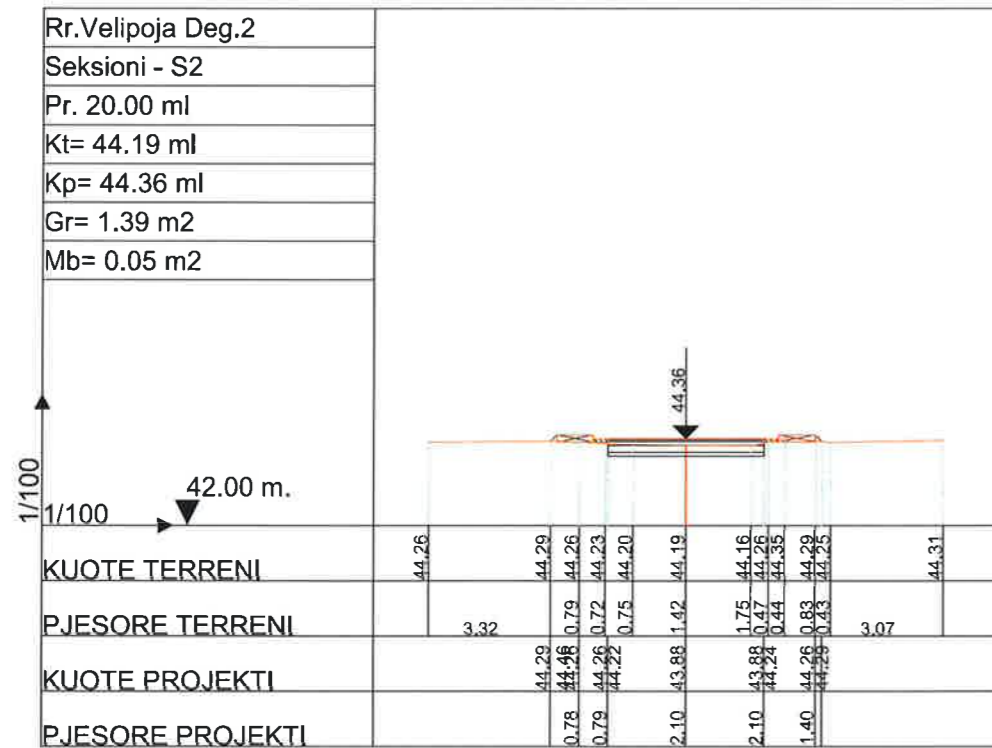



## BASHKIA KAMEZ

DREJTORIA E SHERBIMEVE PUBLIKE  
DREJTORIA E PROJEKTEVE DHE INVESTIMEVEVE  
DEPARTAMENTI I PROJEKTEVE

Dr. e Projekteve e Investimeve		FLORA MUCA
STAFI TEKNIK PROJEKTES	Ing.	ARJOLA KURTI
	Ing.	ERBLIN LALA
	Ing.	DENIS PRENCI
	Ing.	RAMADAN HYSA
Titulli i Projektit		Faza e Projektit
NDERTIM RRUGET "PJESHKORE, VELIPOJE, + RRUIGCAT, BALLSHI, VALIAS PINGUL ME HEKURAN DEDEN LAKNAS"		PROJEKT ZBATIMI
Emeritimi i Filitus		Data e Implementimit:
PROFILLET TERTHORE		Shkalle e Vizalimit
		1:200
		Fleta Nr.
		21

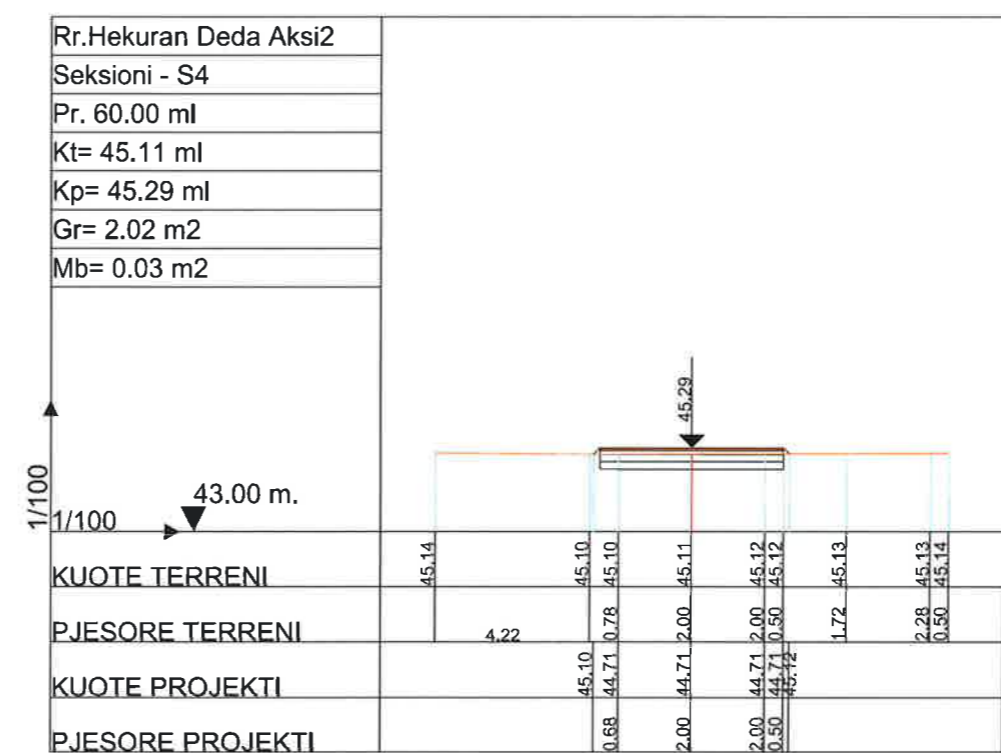
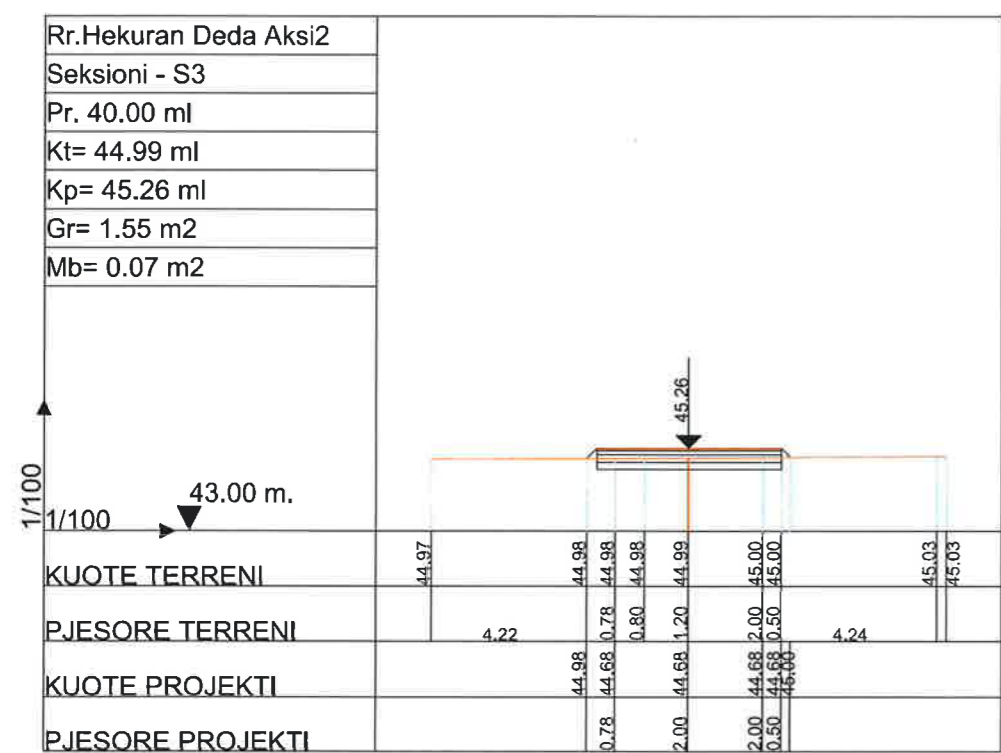
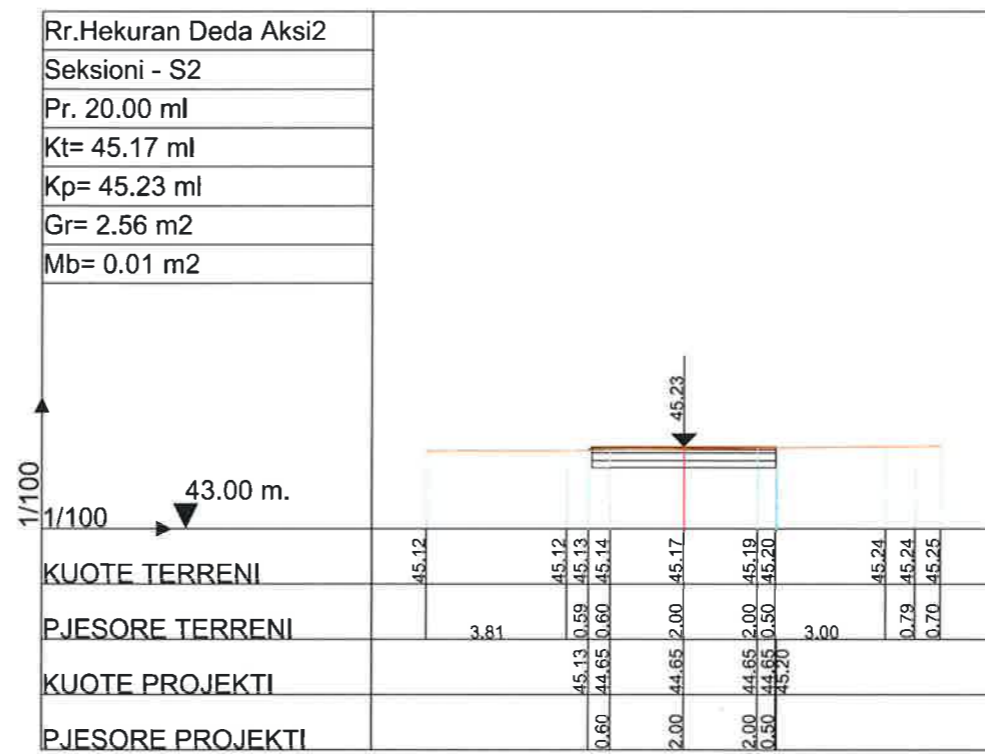
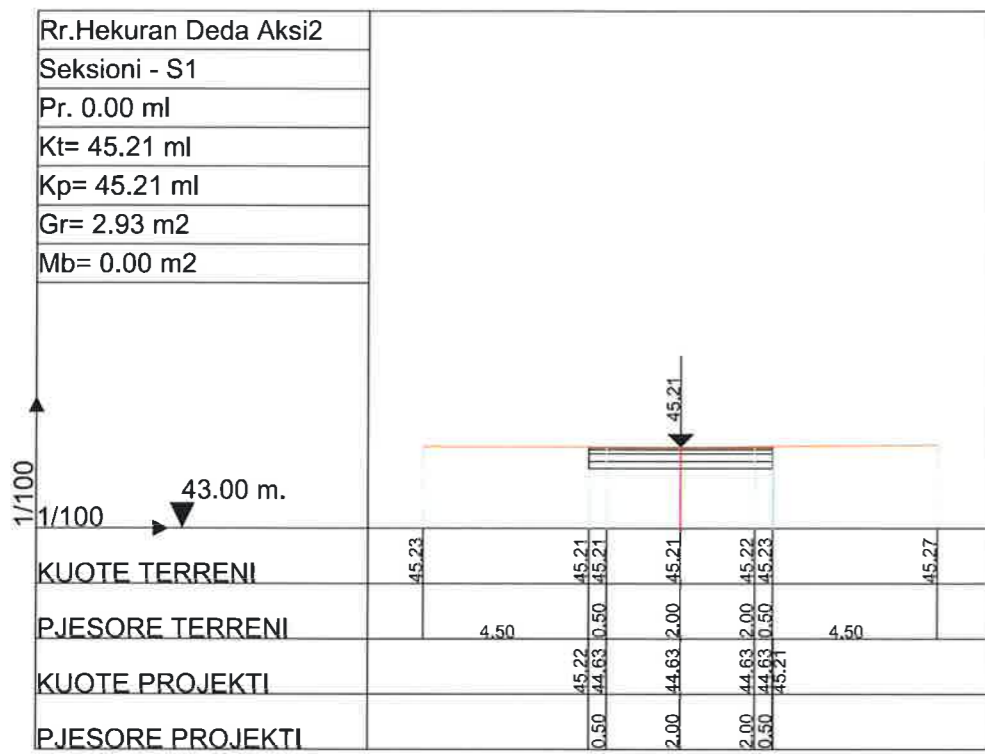

## BASHKIA KAMEZ

DREJTORIA E SHERBIMEVE PUBLIKE  
DREJTORIA E PROJEKTEVE DHE INVESTIMEVE  
DEPARTAMENTI I PROJEKTEVE

Dr. e Projekteve e Investimeve	FLORA MUCA	
STAFI TEKNIK	Ing. ARJOLA KURTI	
PROJEKTUES	Ing. ERBLIN LALA	
	Ing. DENIS PRENCI	
	Ing. RAMADAN HYSA	
Titulli i Projektit		Faza e Projektit
NDERTIM RRUGET		PROJEKT ZBATIMI
"PJESHKORE, VELIPOJE, + RRUGICAT, BALLSHI, VALIAS		Data e Implementimit:
PINGUL ME HEKURAN DEDEN LAKNAS"		Shkalla e Vizatimit:
Emerimet i Fletes		1:200
PROFILET TERTHORE		Fleta Nr.
		22

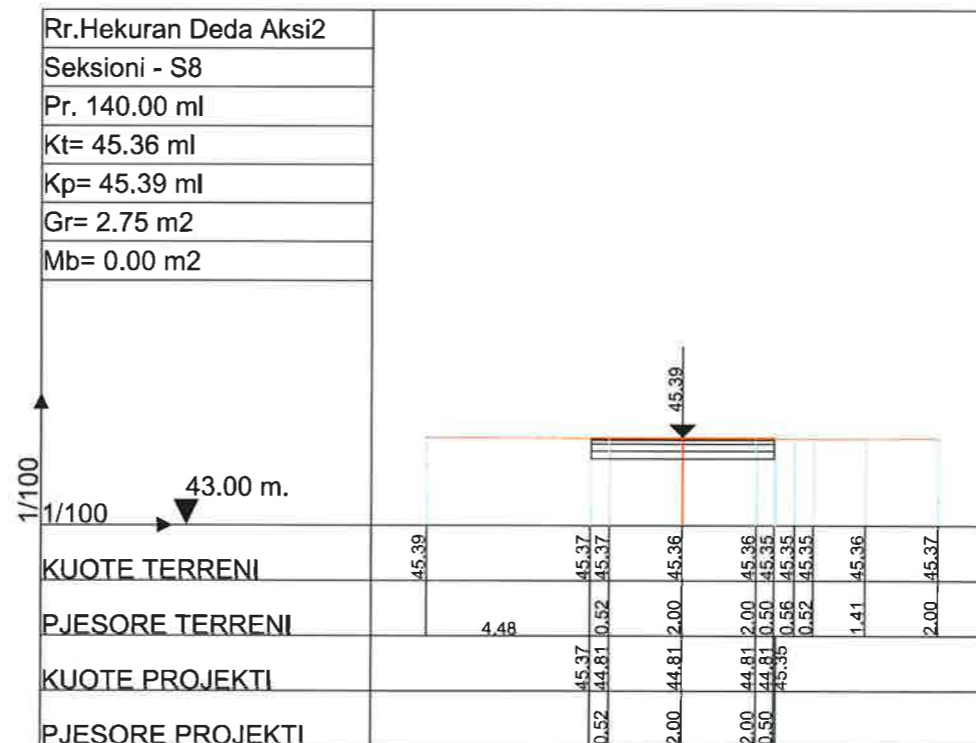
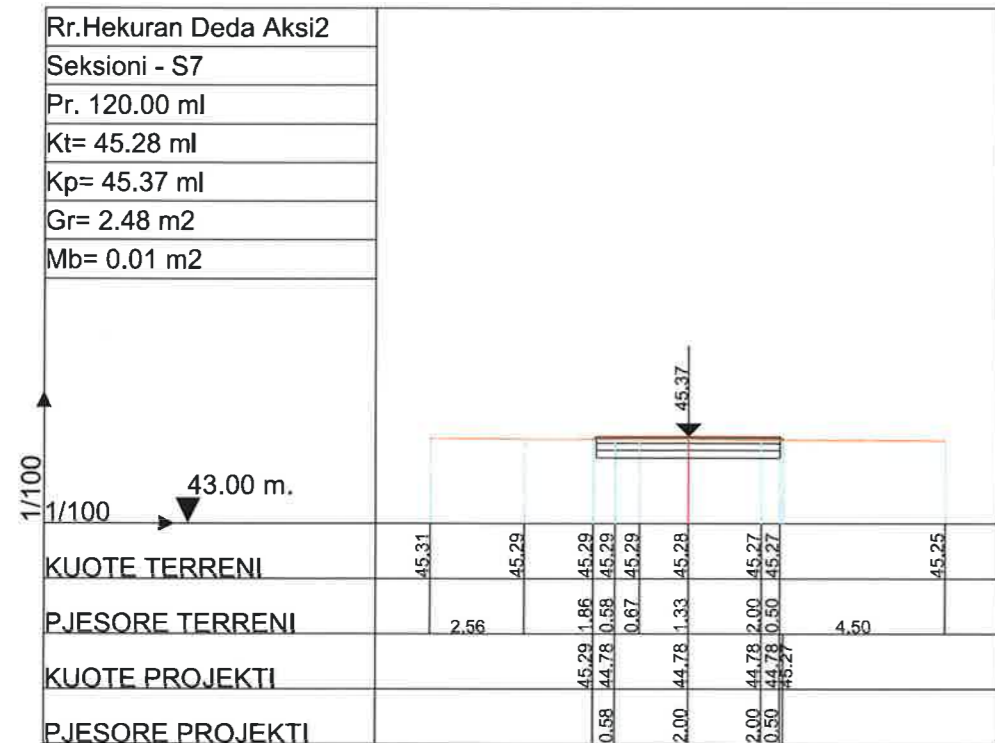
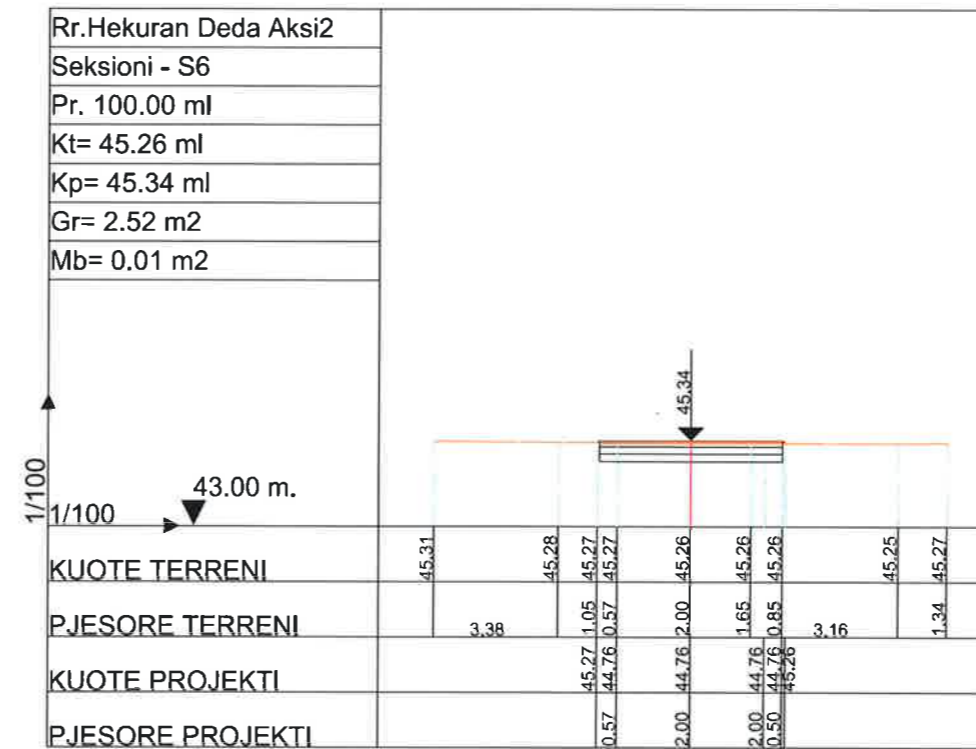
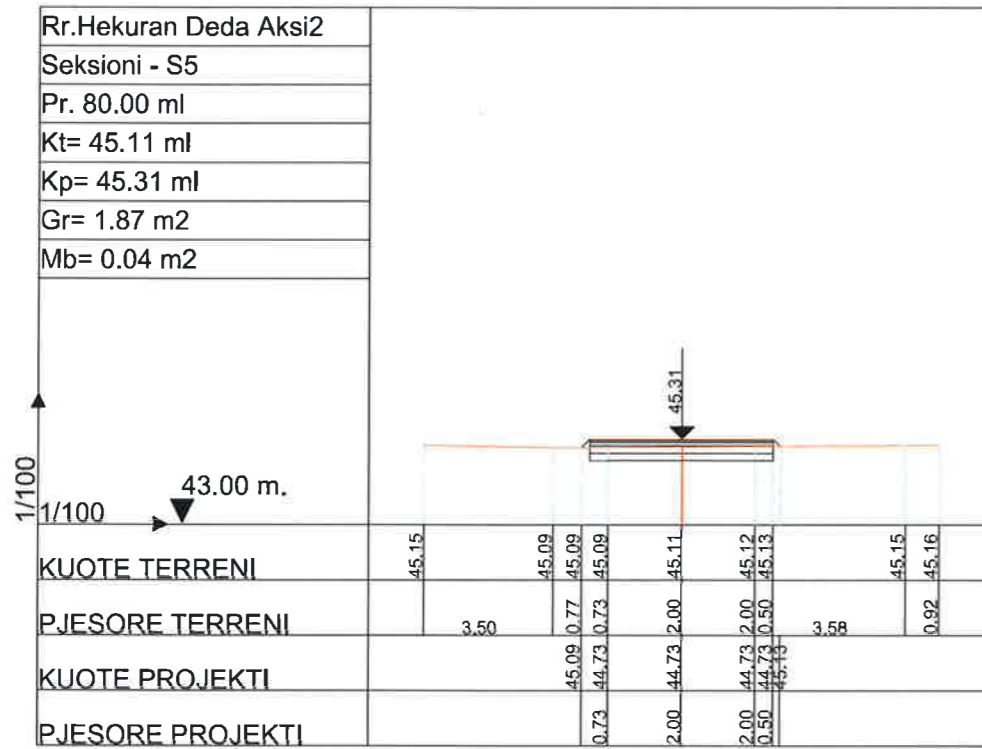

## BASHKIA KAMEZ

DREJTORIA E SHERBIMEVE PUBLIKE  
DREJTORIA E PROJEKTEVE DHE INVESTIMEVE  
DEPARTAMENTI I PROJEKTEVE

Dr. e Projekteve e Investimeve	FLORA MUCA								
STAFI TEKNIK PROJEKTES	<table border="1" style="width: 100%; border-collapse: collapse;"> <tr><td style="width: 20%;">Ing.</td><td>ARJOLA KURTI</td></tr> <tr><td>Ing.</td><td>ERBLIN LALA</td></tr> <tr><td>Ing.</td><td>DENIS PRENCI</td></tr> <tr><td>Ing.</td><td>RAMADAN HYSA</td></tr> </table>	Ing.	ARJOLA KURTI	Ing.	ERBLIN LALA	Ing.	DENIS PRENCI	Ing.	RAMADAN HYSA
Ing.	ARJOLA KURTI								
Ing.	ERBLIN LALA								
Ing.	DENIS PRENCI								
Ing.	RAMADAN HYSA								
<table border="1" style="width: 100%; border-collapse: collapse;"> <tr> <td style="width: 70%;">           Titulli i Projektit            NDERTIM RRUGET            "PJESHKORE, VELIPOJE, + RRUIGCAT, BALLSHI,            VALIAS            PINGUL ME HEKURAN DEDEN LAKNAS"            Emertimi i Fletes            PROFILET TERTHORE         </td> <td style="width: 30%;">           Faza e Projektit            PROJEKT ZBATIMI            Data e Implementimit :            Shkalla e Vizimit :            1:200            Fleta Nr. :  <div style="font-size: 24px; font-weight: bold; text-align: center;">23</div> </td> </tr> </table>		Titulli i Projektit NDERTIM RRUGET "PJESHKORE, VELIPOJE, + RRUIGCAT, BALLSHI, VALIAS PINGUL ME HEKURAN DEDEN LAKNAS" Emertimi i Fletes PROFILET TERTHORE	Faza e Projektit PROJEKT ZBATIMI Data e Implementimit : Shkalla e Vizimit : 1:200 Fleta Nr. : <div style="font-size: 24px; font-weight: bold; text-align: center;">23</div>						
Titulli i Projektit NDERTIM RRUGET "PJESHKORE, VELIPOJE, + RRUIGCAT, BALLSHI, VALIAS PINGUL ME HEKURAN DEDEN LAKNAS" Emertimi i Fletes PROFILET TERTHORE	Faza e Projektit PROJEKT ZBATIMI Data e Implementimit : Shkalla e Vizimit : 1:200 Fleta Nr. : <div style="font-size: 24px; font-weight: bold; text-align: center;">23</div>								



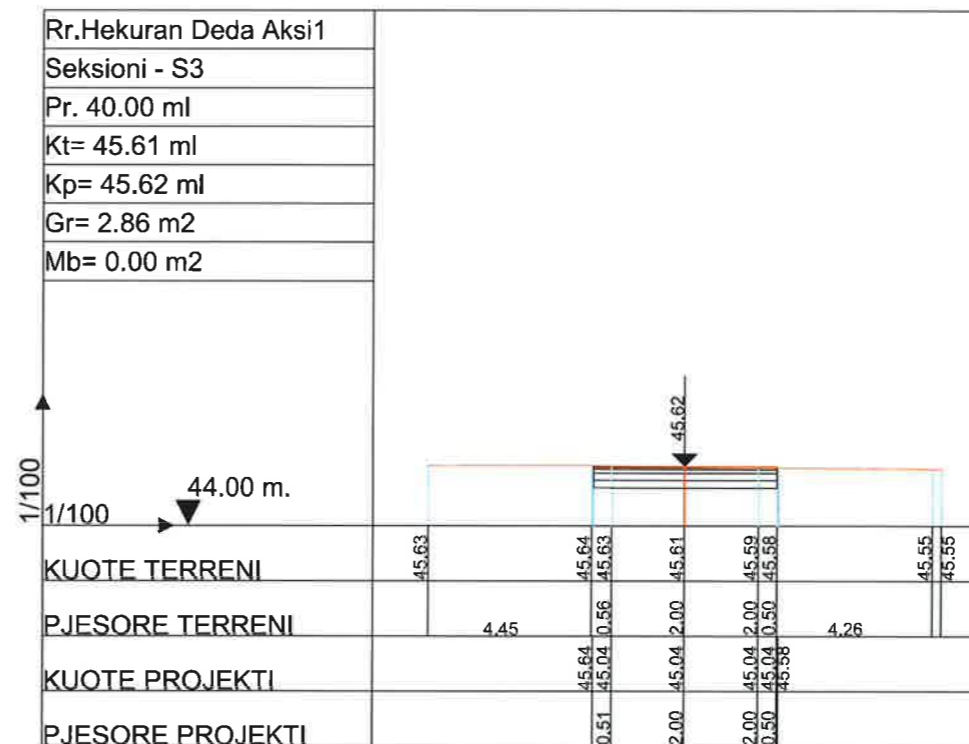
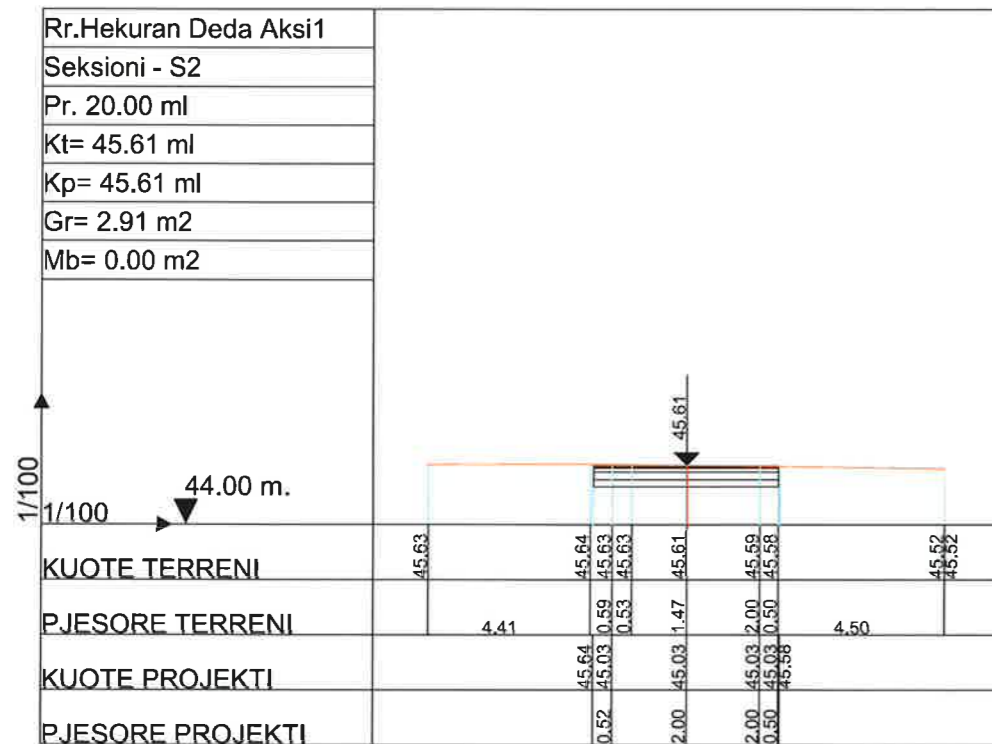
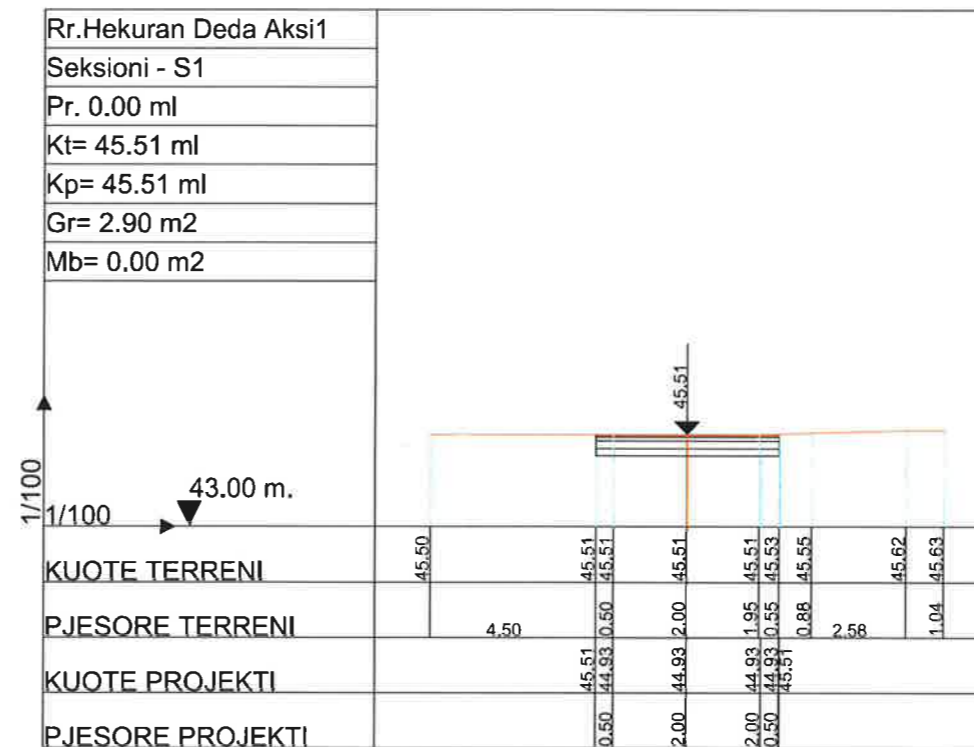
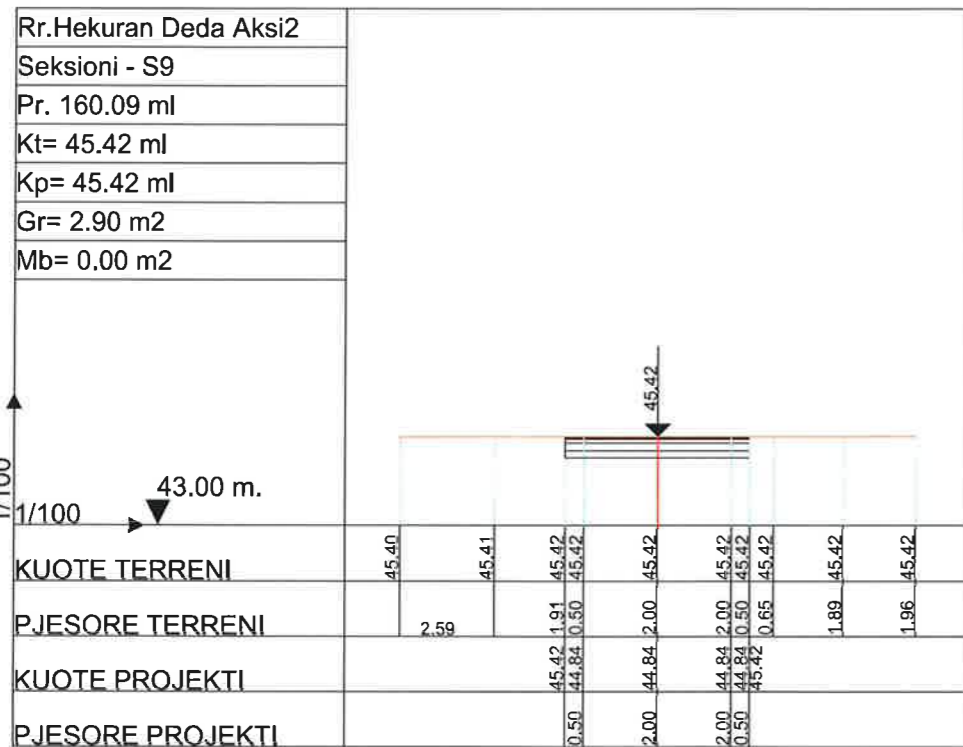

## BASHKIA KAMEZ

DREJTORIA E SHERBIMEVE PUBLIKE  
DREJTORIA E PROJEKTEVE DHE INVESTIMEVE  
DEPARTAMENTI I PROJEKTEVE

Dr. e Projekteve e Investimeve	FLORA MUCA								
STAFI TEKNIK PROJEKTES	<table border="1" style="width: 100%; border-collapse: collapse;"> <tr><td style="font-size: x-small;">Ing.</td><td>ARJOLA KURTI</td></tr> <tr><td style="font-size: x-small;">Ing.</td><td>ERBLIN LALA</td></tr> <tr><td style="font-size: x-small;">Ing.</td><td>DENIS PRENCI</td></tr> <tr><td style="font-size: x-small;">Ing.</td><td>RAMADAN HYSA</td></tr> </table>	Ing.	ARJOLA KURTI	Ing.	ERBLIN LALA	Ing.	DENIS PRENCI	Ing.	RAMADAN HYSA
Ing.	ARJOLA KURTI								
Ing.	ERBLIN LALA								
Ing.	DENIS PRENCI								
Ing.	RAMADAN HYSA								
Titulli i Projektit	Faza e Projektit								
NDERTIM RRUGET "PJESHKORE, VELIPOJE, + RRUGICAT, BALLSHI, VALIAS PINGUL ME HEKURAN DEDEN LAKNAS"	PROJEKT ZBATIMI								
Emertimi i Fietes	Data e Implementimit :								
PROFILET TERTHORE	Shkalla e Vizatimit <b>1:200</b>								
	Fleta Nr. <b>24</b>								

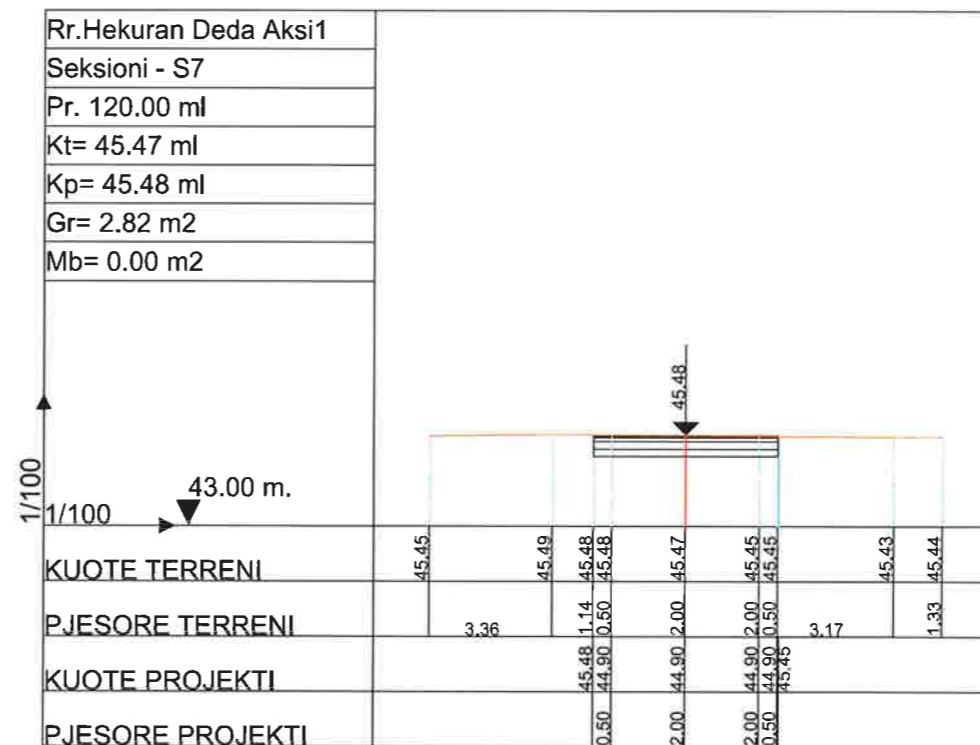
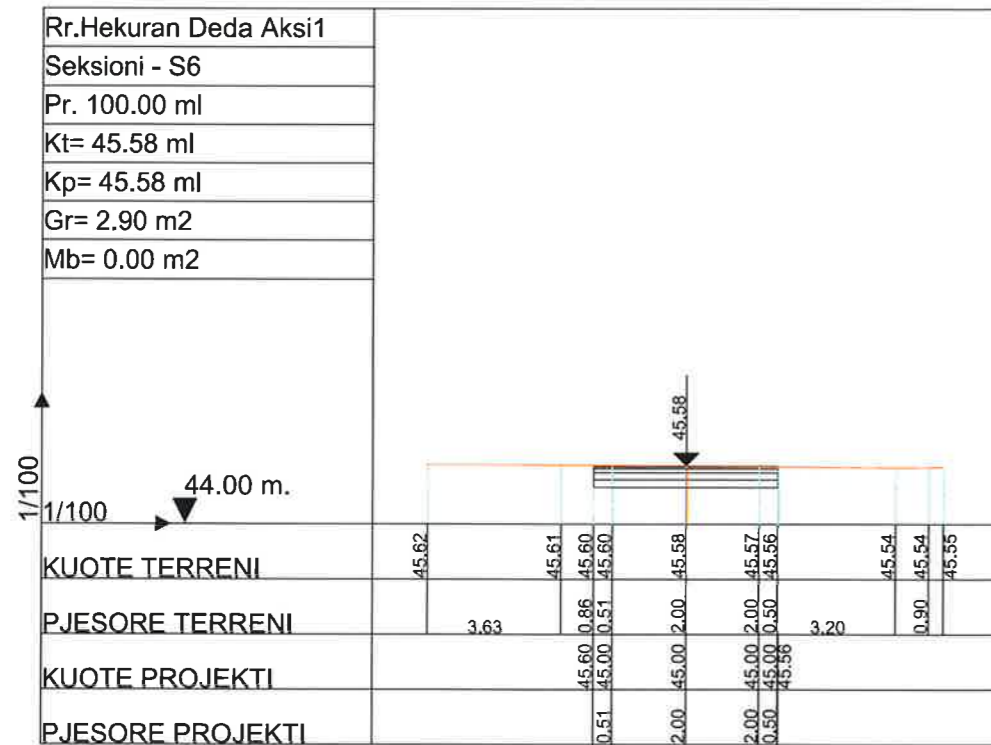
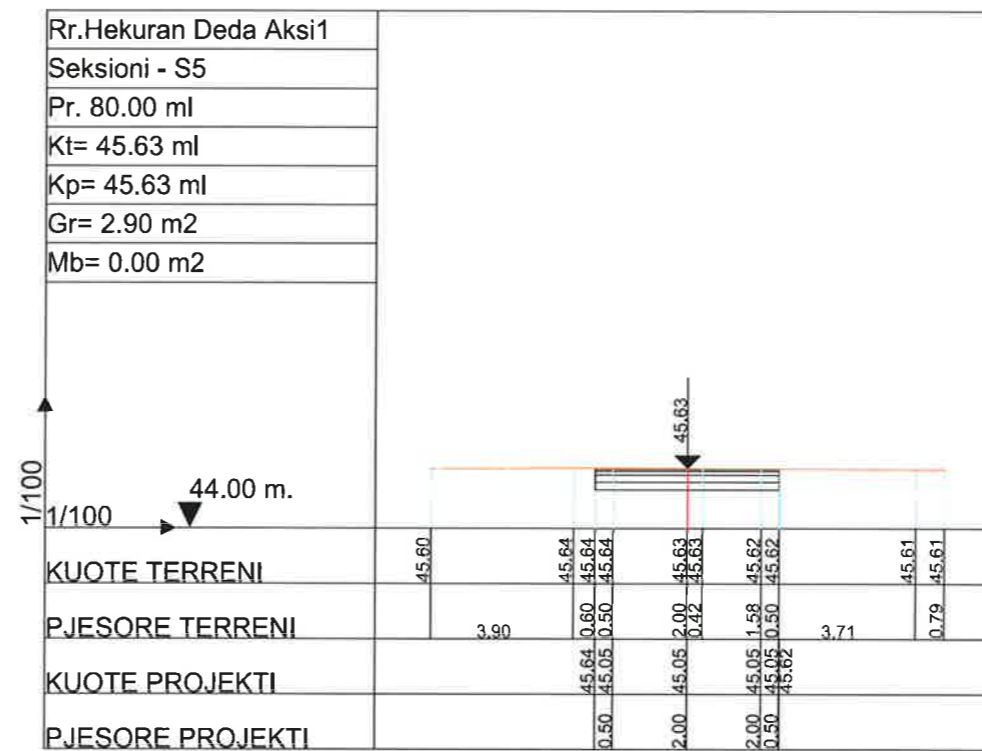
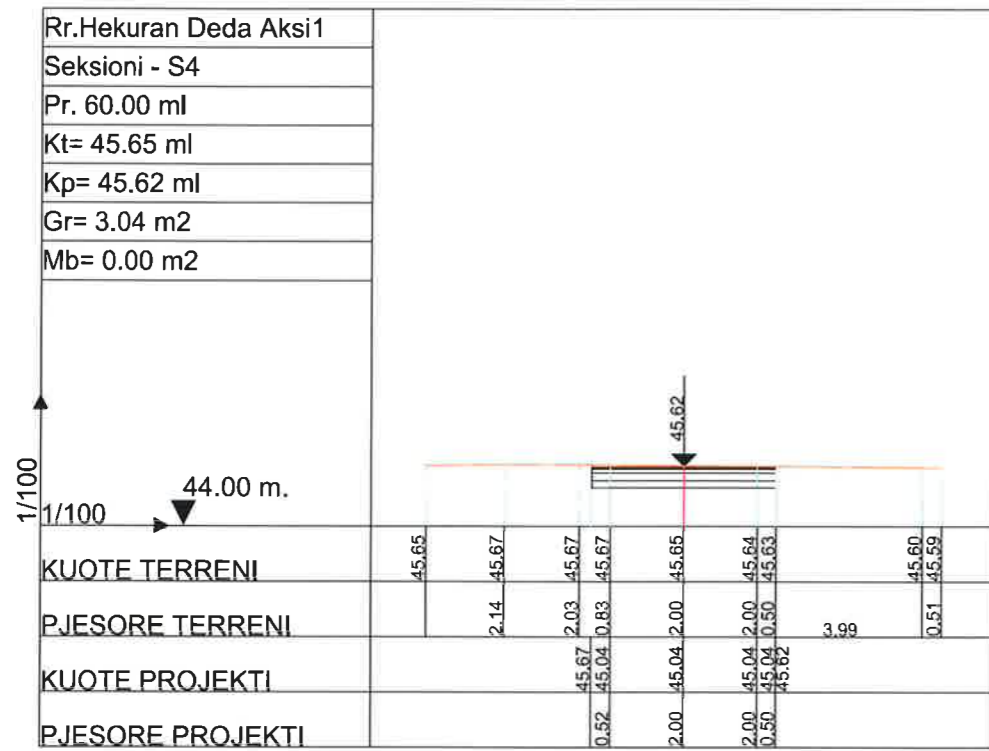



## BASHKIA KAMEZ

DREJTORIA E SHERBIMEVE PUBLIKE  
DREJTORIA E PROJEKTEVE DHE INVESTIMEVE  
DEPARTAMENTI I PROJEKTEVE

Dr. e Projekteve e Investimeve		FLORA MUCA
STAFI TEKNIK	Ing. ARJOLA KURTI	
PROJEKTUES	Ing. ERBLIN LALA	
	Ing. DENIS PRENCI	
	Ing. RAMADAN HYSA	
Titulli i Projektit		Faza e Projektit
NDERTIM RRUGET "PJESHKORE, VELIPOJE, + RRUGICAT, BALLSHI, VALIAS PINGUL ME HEKURAN DEDEN LAKNAS"		PROJEKT ZBATIMI
Emertimi i Fites		Data e Implementimit
PROFILET TERTHORE		Shkalla e Vizimit 1:200
		Fleta Nr. 25



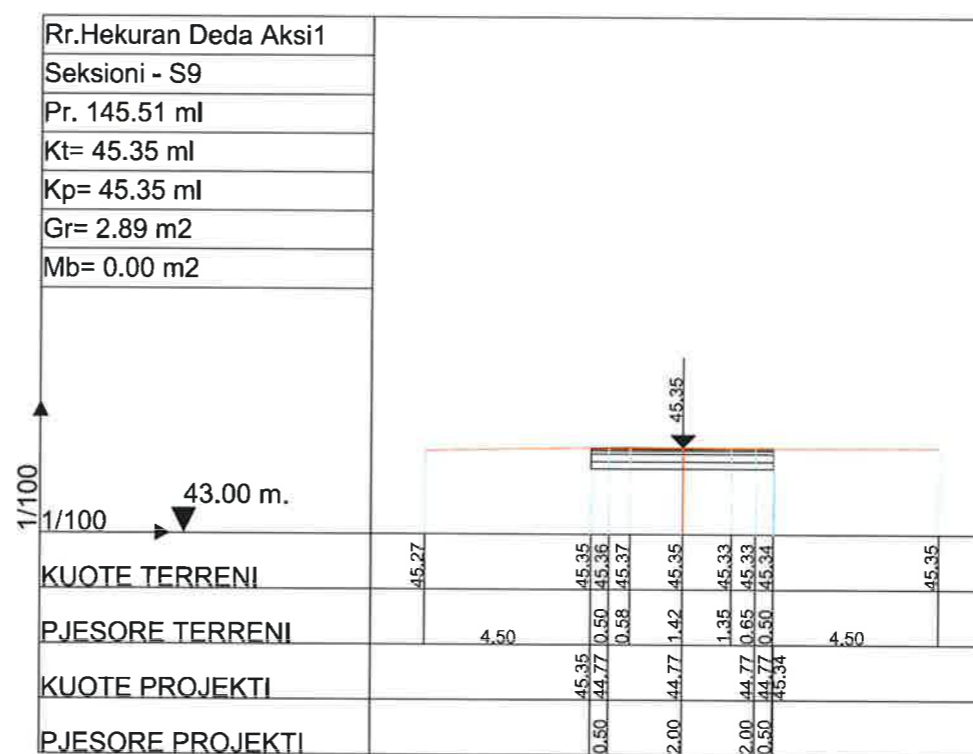
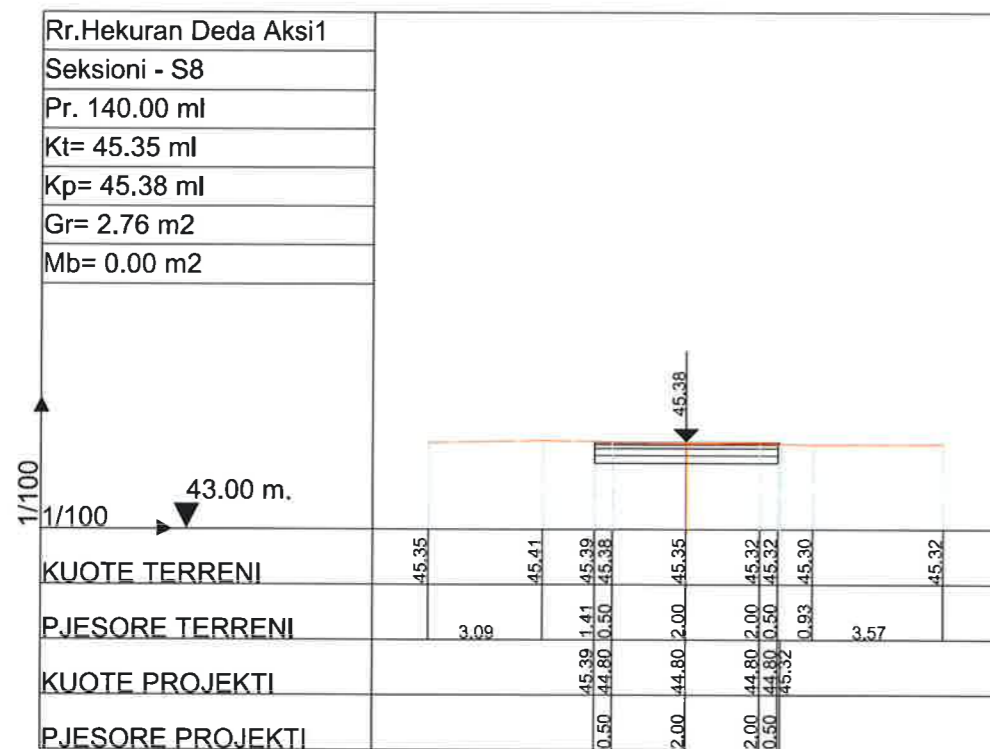

## BASHKIA KAMEZ

DREJTORIA E SHERBIMEVE PUBLIKE  
DREJTORIA E PROJEKTEVE DHE INVESTIMEVE  
DEPARTAMENTI I PROJEKTEVE

Dr. e Projekteve e Investimeve	FLORA MUCA	
STAFI TEKNIK PROJEKTUES	Ing. ARJOLA KURTI	
	Ing. ERBLIN LALA	
	Ing. DENIS PRENCI	
	Ing. RAMADAN HYSA	
Titulli i Projektit NDERTIM RRUGET "PJESHKORE, VELIPOJE, + RRUGICAT, BALLSHI, VALIAS PINGUL ME HEKURAN DEKEN LAKNAS"		Faza e Projektit <b>PROJEKT ZBATIMI</b> Data e Implementimit:
Emerimi i Fletes PROFILET TERTHORE		Shkalla e Vizatimit <b>1:200</b> Fleta Nr. <div style="font-size: 24px; font-weight: bold; text-align: center;">26</div>

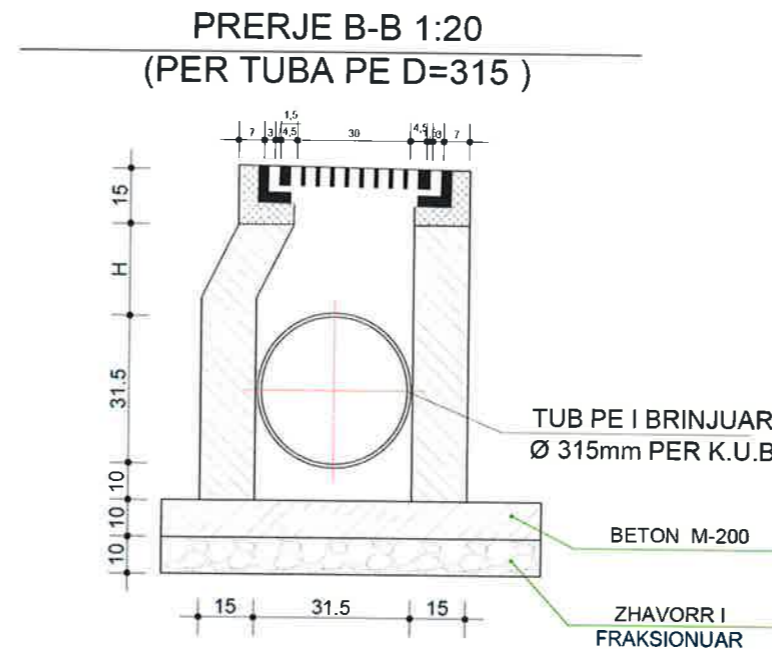
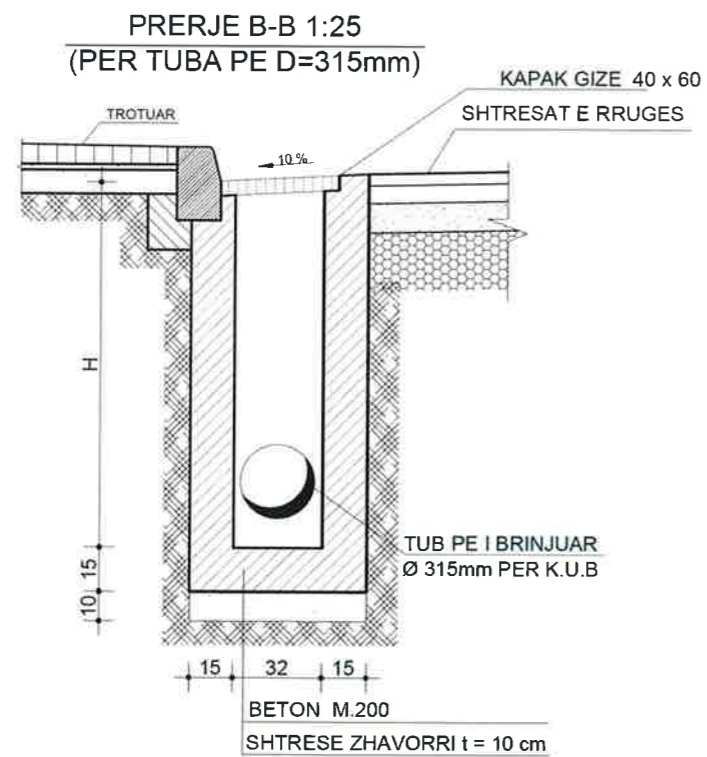
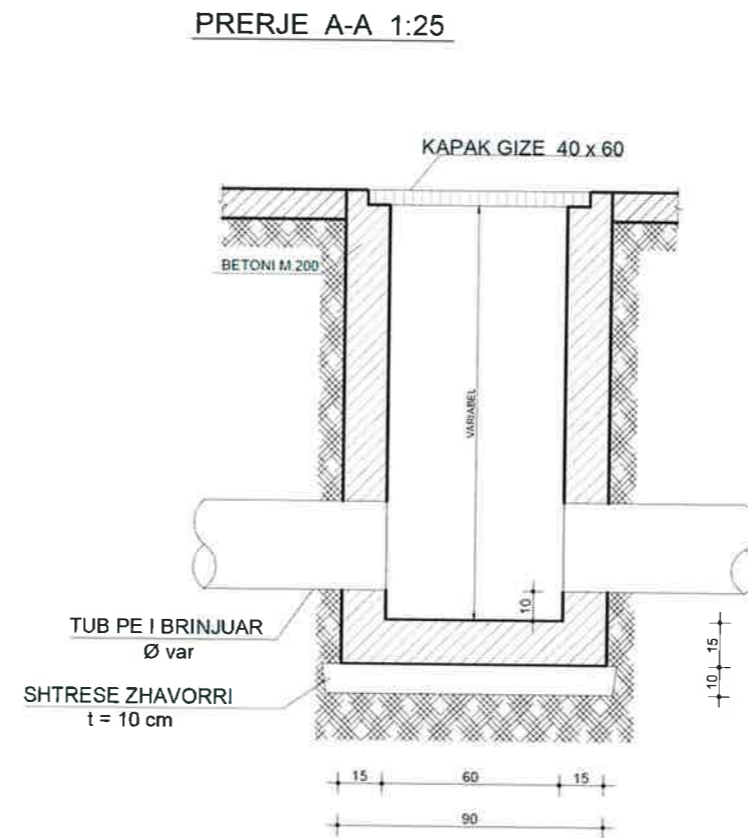
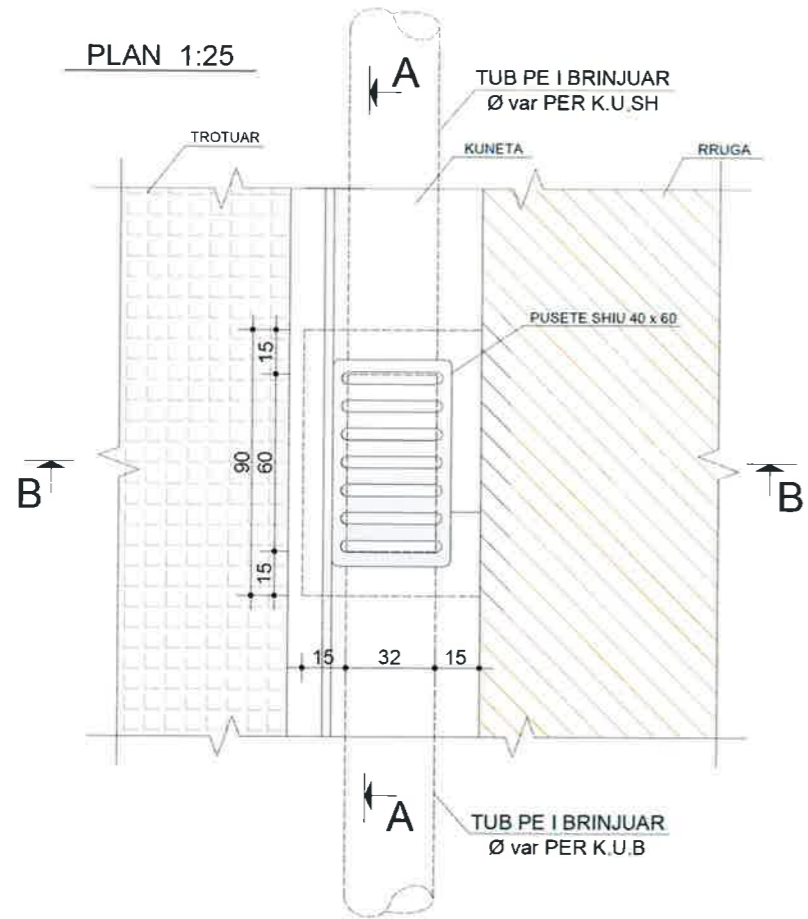

**BASHKIA KAMEZ**

DREJTORIA E SHERBIMEVE PUBLIKE  
DREJTORIA E PROJEKTEVE DHE INVESTIMEVE  
DEPARTAMENTI I PROJEKTEVE

Dr. e Projekteve e Investimeve		FLORA MUCA	
STAFI TEKNIK PROJEKTORES	Ing.	ARJOLA KURTI	
	Ing.	ERBLIN LALA	
	Ing.	DENIS PRENCI	
	Ing.	RAMADAN HYSA	
Titulli i Projektit		Faza e Projektit	
NDERTIM RRUGET "PJESHKORE, VELIPOJE, + RRUGICAT, BALLSHI, VALIAS PINGUL ME HEKURAN DEDEN LAKNAS"		PROJEKT ZBATIMI	
Emeritimi i Fletes		Data e Implementimit:	
DETAJE		Shkalla e Vizatimit: 1:50	
		Fleta Nr. 01	

# DETAJI PANDUSIT

PRERJA A-A SHK.1:50

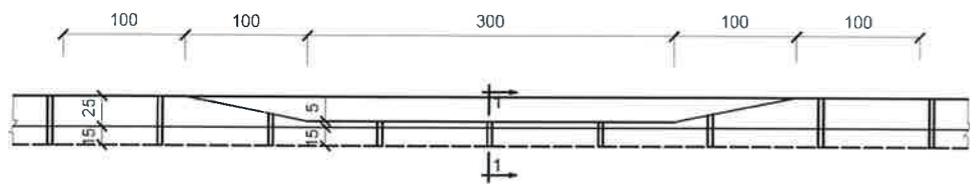

PLAN SHK.1:50

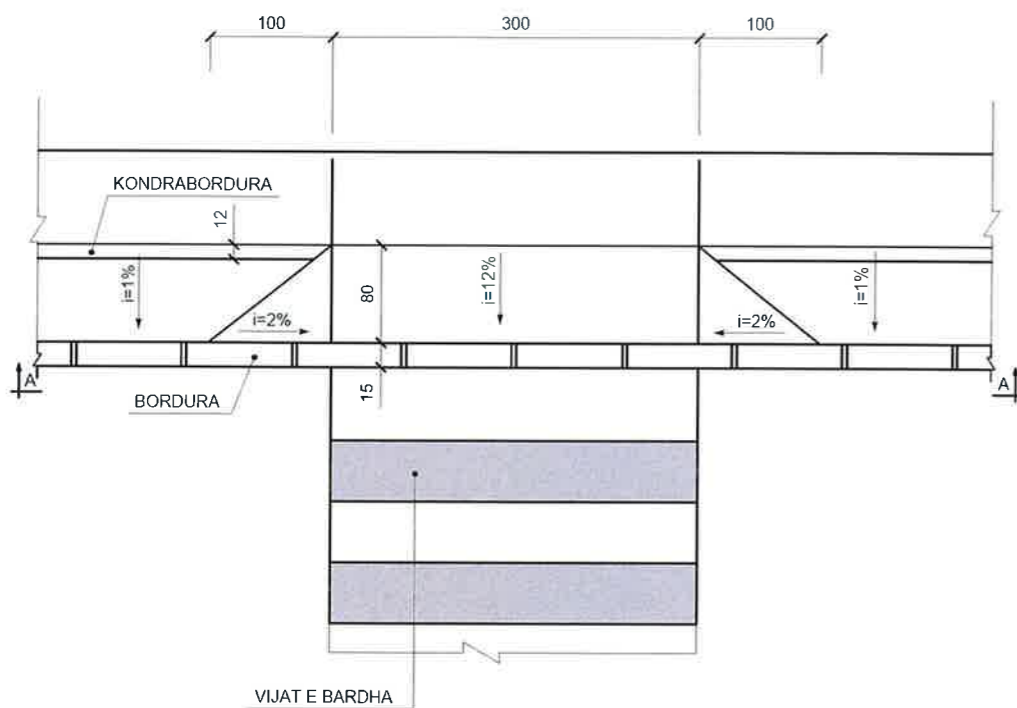

Shënim:  
NE CDO PIKE KU KRYQEZOHET RRUGA KRYESORE ME RRUGET DYTESORE DO TE VENDOSEN PANDUSET E TROTUAREVE

## DETAJI I PRERJES SE RRUGES ME PANDUS Sh 1:15

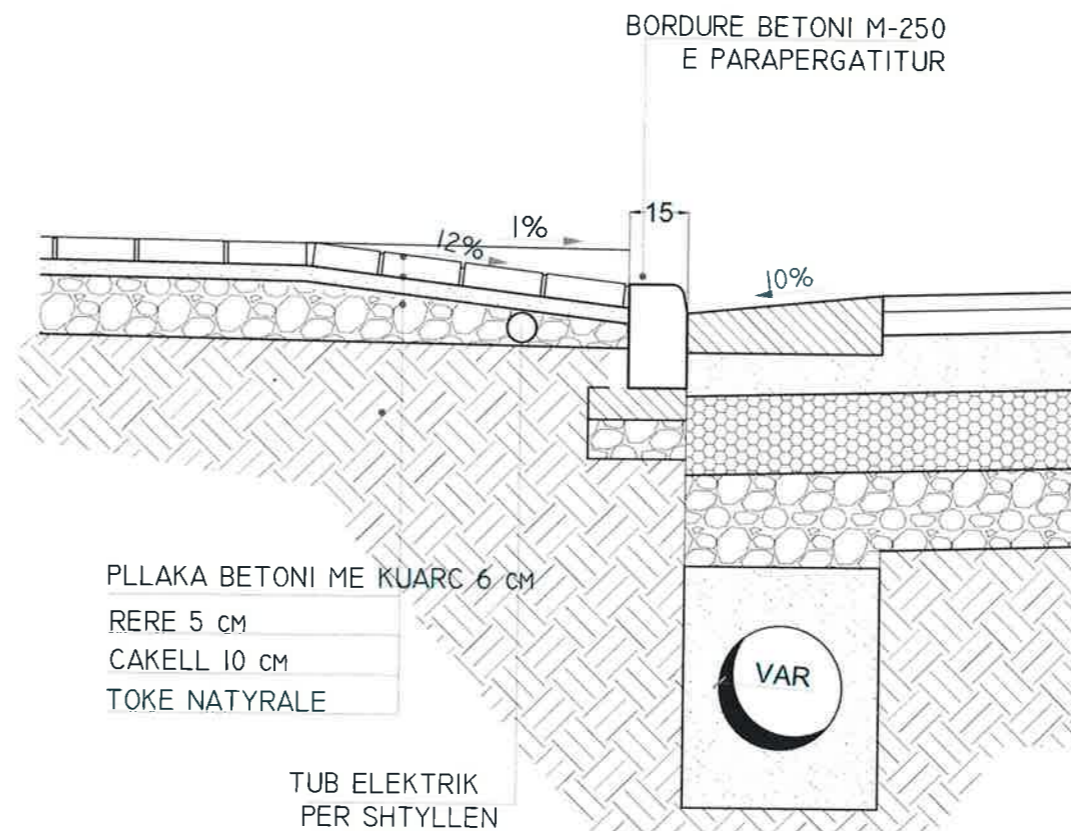

## Detaji i Bordurës dhe kunetes Sh 1:15

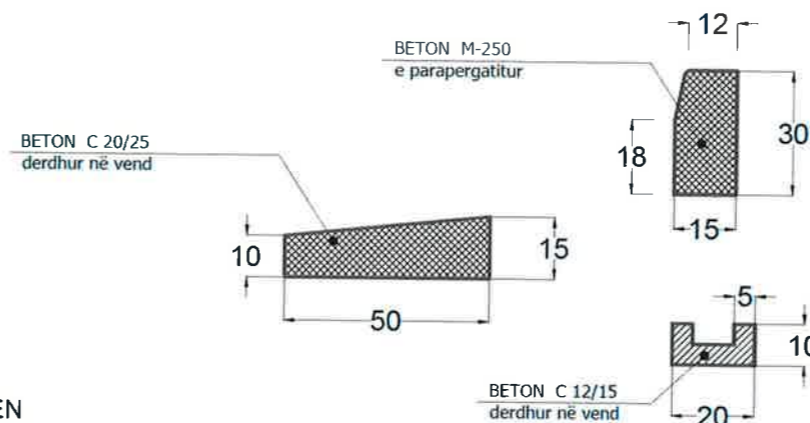

**BASHKIA KAMEZ**  
DREJTORIA E SHERBIMEVE PUBLIKE  
DREJTORIA E PROJEKTEVE DHE INVESTIMEVE  
DEPARTAMENTI I PROJEKTEVE

Dr. e Projekteve e Investimeve	FLORA MUCA	<i>[Signature]</i>
STAFI TEKNIK PROJEKTES	Ing. ARJOLA KURTI	<i>[Signature]</i>
	Ing. ERBLIN LALA	<i>[Signature]</i>
	Ing. DENIS PRENCI	<i>[Signature]</i>
	Ing. RAMADAN HYSA	<i>[Signature]</i>

Titulli i Projektit	Faza e Projektit
NDERTIM RRUGET "PJESHKORE, VELIPOJE, + RRUGICAT, BALLSHI, VALIAS PINGUL ME HEKURAN DEDEN LAKNAS"	PROJEKT ZBATIMI
Emertimi i Fletes	Data e Implementimit:
DETAJE	Shkalla e Vizimit: 1:50
	Fleta Nr. 02



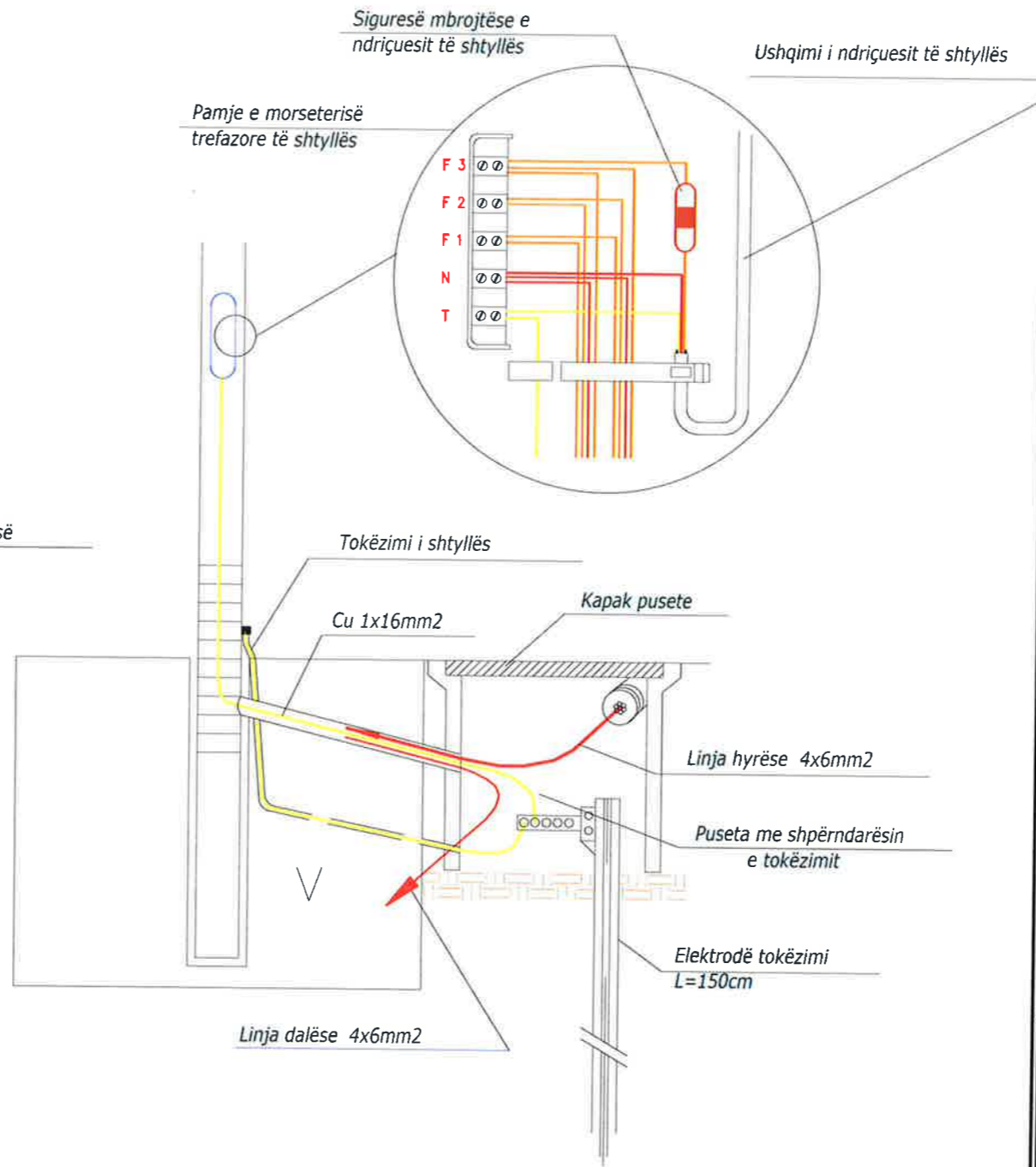
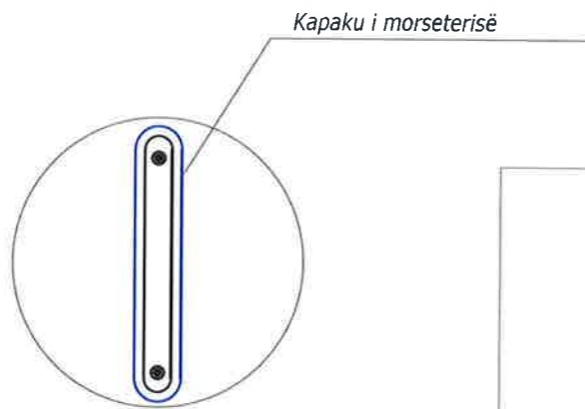
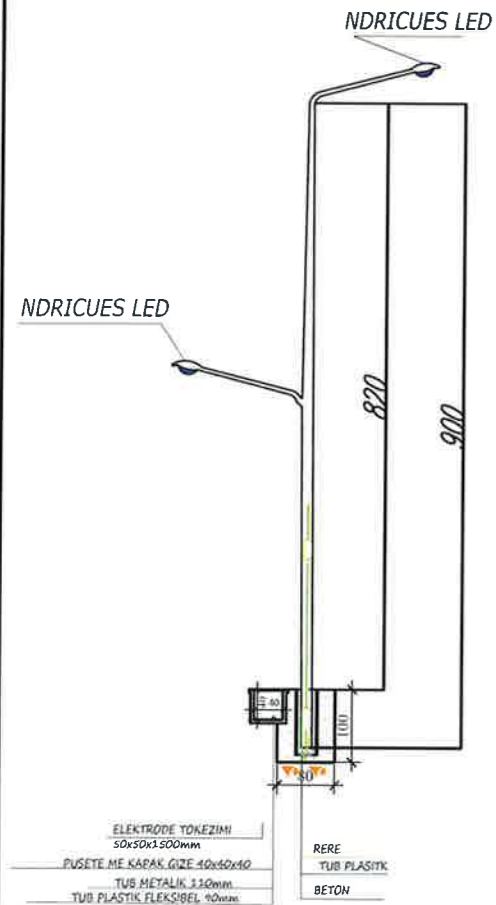

**BASHKIA KAMEZ**  
DREJTORIA E SHERBIMEVE PUBLIKE  
DREJTORIA E PROJEKTEVE DHE INVESTIMEVE  
DEPARTAMENTI I PROJEKTEVE

Dr. e Projekteve e Investimeve	FLORA MUCA	
STAFI TEKNIK	Ing. ARJOLA KURTI	
PROJEKTUES	Ing. ERBLIN LALA	
	Ing. DENIS PRENCI	
	Ing. RAMADAN HYSA	

Titulli i Projektit	Faza e Projektit
NDERTIM RRUGET "PJESHKORE, VELIPOJE, + RRUGICAT, BALLSHI, VALIAS PINGUL ME HEKURAN DEDEN LAKNAS"	PROJEKT ZBATIMI
Emerimi i Fletes	Data e Implementimit:
DETAJE	Shkalla e Vizimit: <b>1:50</b>
	Fleta Nr. <b>03</b>

**Detaj i tokëzimit të shtyllës së ndriçimit**

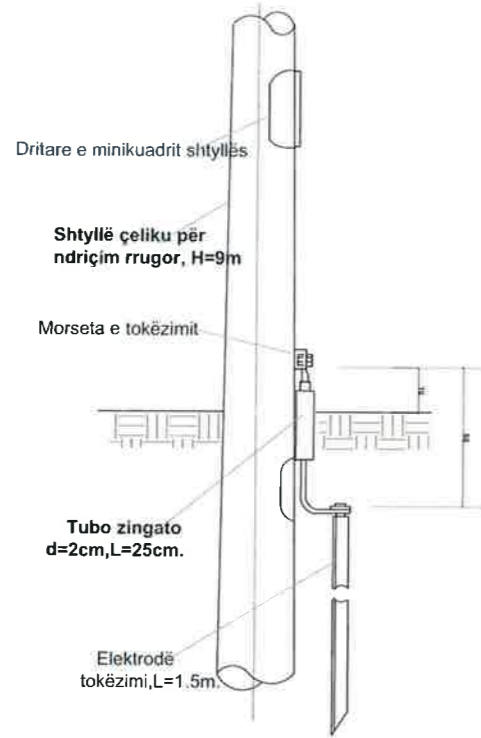

**Konstruksioni morseterisë**

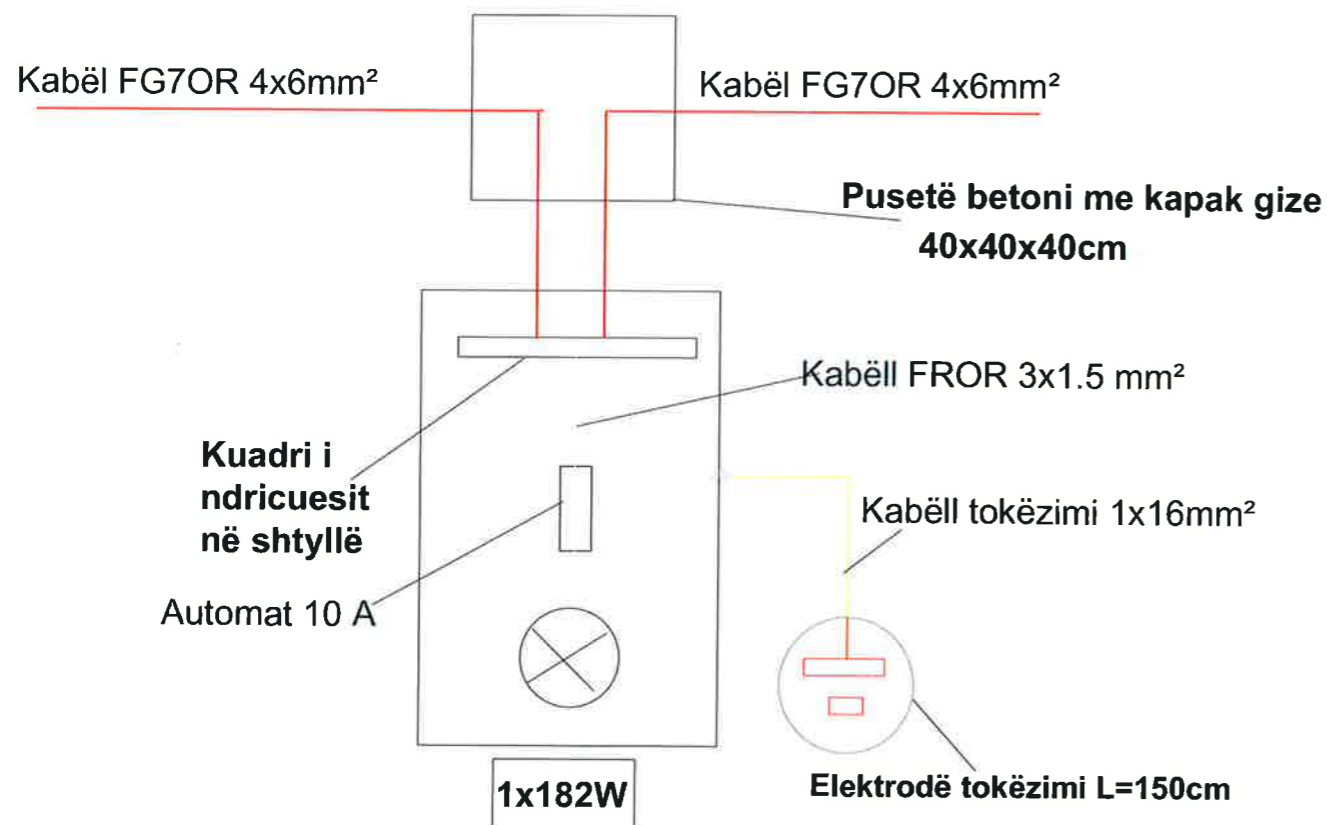
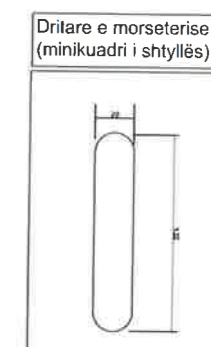
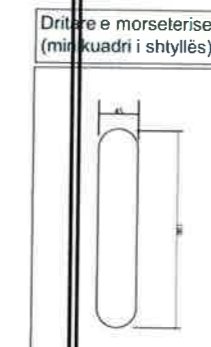
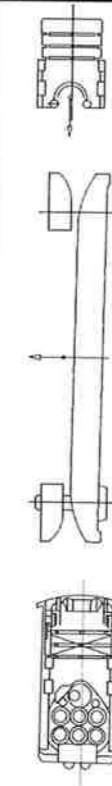
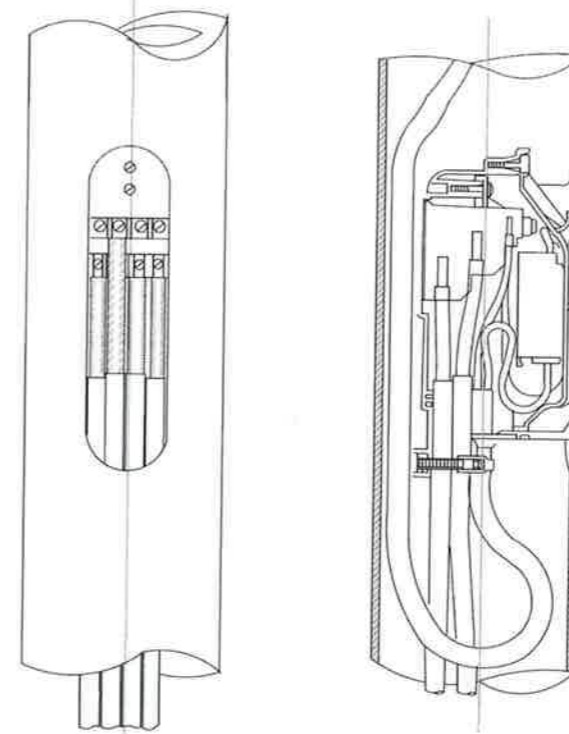

**BASHKIA KAMEZ**  
 DREJTORIA E SHERBIMEVE PUBLIKE  
 DREJTORIA E PROJEKTEVE DHE INVESTIMEVE  
 DEPARTAMENTI I PROJEKTEVE

Dr. e Projekteve e Investimeve	FLORA MUCA	
STAFI TEKNIK	Ing. ARJOLA KURTI	
PROJEKTUES	Ing. ERBLIN LALA	
	Ing. DENIS PRENCI	
	Ing. RAMADAN HYSA	

**Titulli i Projektit**  
 NDERTIM RRUGET  
 "PJESHKORE, VELIPOJE, + RRUGICAT, BALLSHI,  
 VALIAS  
 PINGUL ME HEKURAN DEDEN LAKNAS"

**Emertimi i Fletes**  
**DETAJE**

**Faza e Projektit**  
 PROJEKT ZBATIMI

**Data e Implementimit**

**Shkalla e Vizimit**  
**1:50**

**Fleta Nr.**  
**04**

Prerje e kapakut prej gize

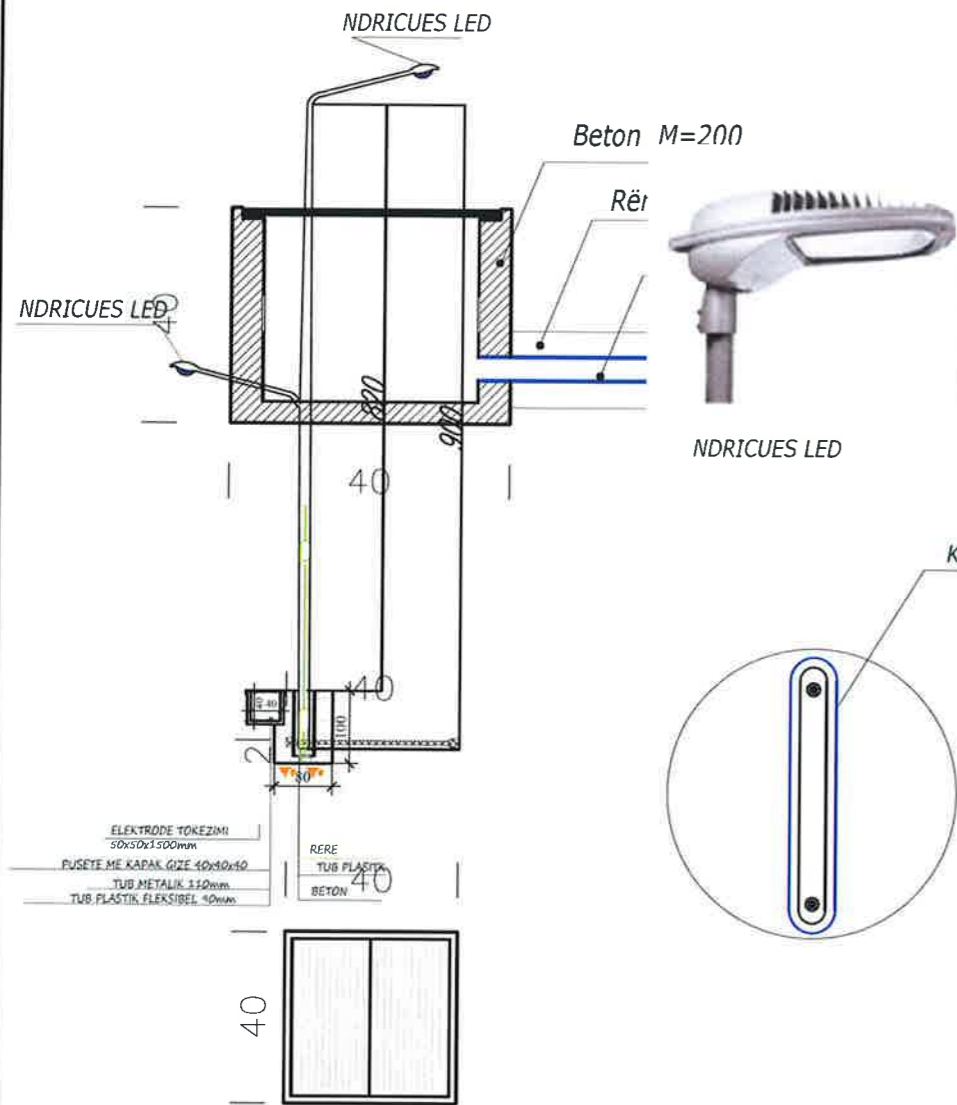

Kapaku i pusetës prej gize

Prerje e vendosjes së pusetave

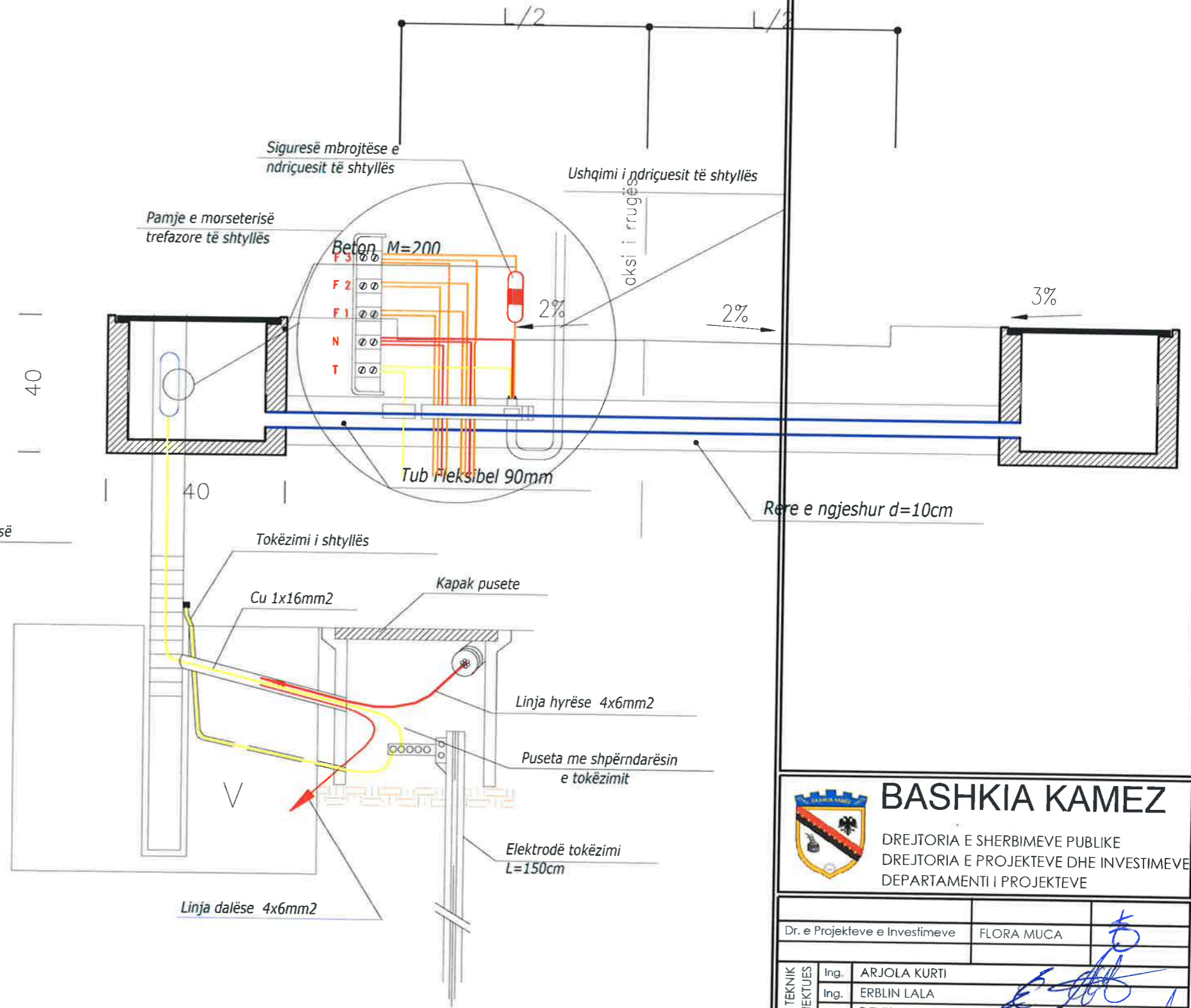

**BASHKIA KAMEZ**  
DREJTORIA E SHERBIMEVE PUBLIKE  
DREJTORIA E PROJEKTEVE DHE INVESTIMEVE  
DEPARTAMENTI I PROJEKTEVE

Dr. e Projekteve e Investimeve	FLORA MUCA	
STAFI TEKNIK PROJEKTUES	Ing. ARJOLA KURTI	
	Ing. ERBLIN LALA	
	Ing. DENIS PRENCI	
	Ing. RAMADAN HYSA	

**Titulli i Projektit:**  
NDERTIM RRUGET  
"PJESHKORE, VELIPOJE, + RRUGICAT, BALLSHI,  
VALIAS  
PINGUL ME HEKURAN DEDEN LAKNAS"

**Faza e Projektit:**  
PROJEKT ZBATIMI

Data e Implementimit:

Shkalla e Vizimit:  
1:50

Fleta Nr.  
05



**Hollësi e inkastrimit të kolonës së ndriçuesit me lartësi H=9m**

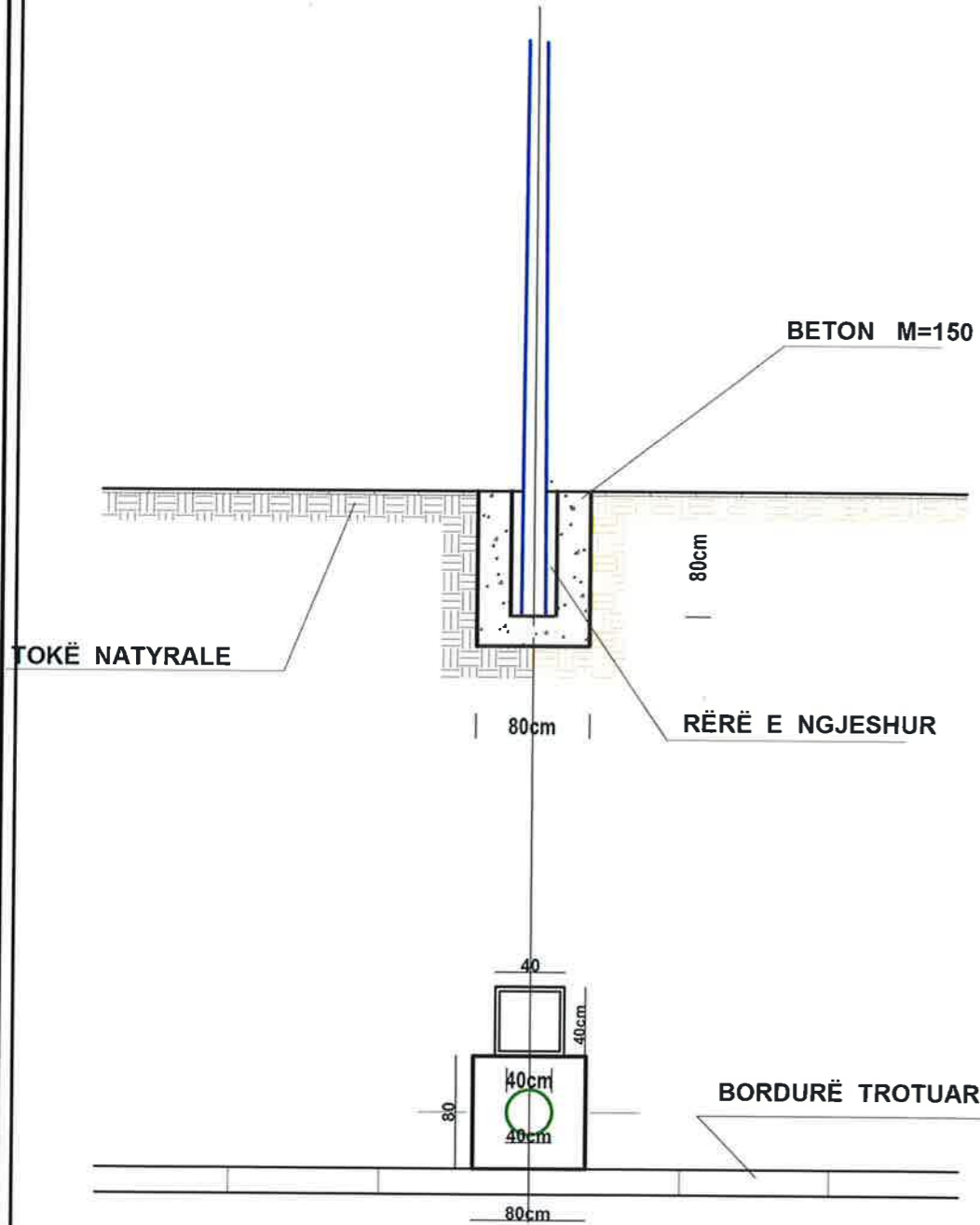

**Hollësi e vendosjes së pusetës për Tub fleksibel 90mm**

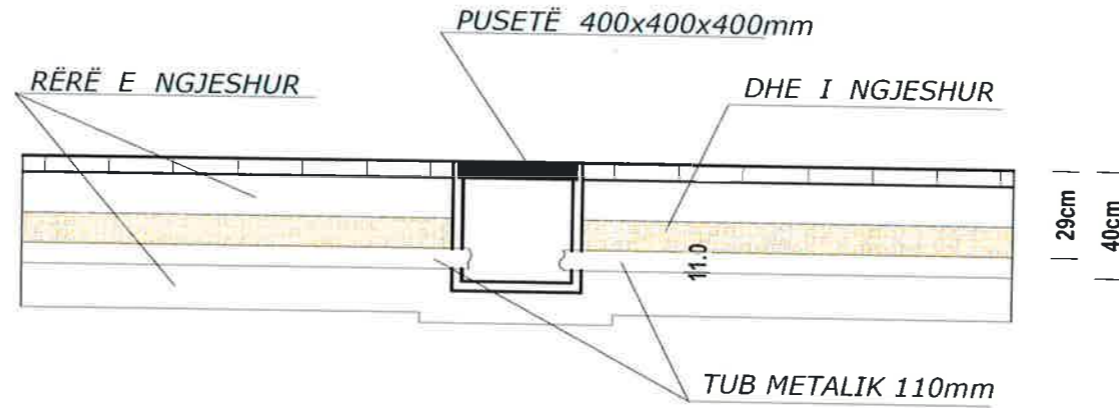

**Hollësi e vendosjes së pusetës për Tub metalik 110mm**

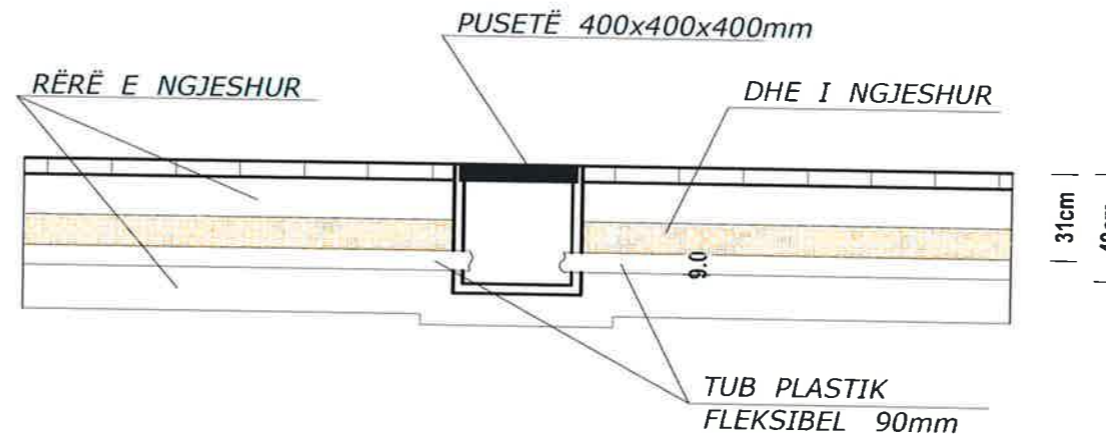

**BASHKIA KAMEZ**  
 DREJTORIA E SHERBIMEVE PUBLIKE  
 DREJTORIA E PROJEKTEVE DHE INVESTIMEVE  
 DEPARTAMENTI I PROJEKTEVE

Dr. e Projekteve e Investimeve	FLORA MUCA	
STAFI TEKNIK PROJEKTES	Ing. ARJOLA KURTI	
	Ing. ERBLIN LALA	
	Ing. DENIS PRENCI	
	Ing. RAMADAN HYSA	

Titulli i Projektit NDERTIM RRUGET "PJESHKORE, VELIPOJE, + RRUGICAT, BALLSHI, VALIAS PINGUL ME HEKURAN DE DEN LAKNAS"	Faza e Projektit PROJEKT ZBATIMI
Emertimi i Fletes DETAJE	Data e Implementimit: Shkalla e Vlerësimit 1:50 Fleta Nr. 06

Planimetria e instalimit të rrjetit kabllor të ndriçimit,

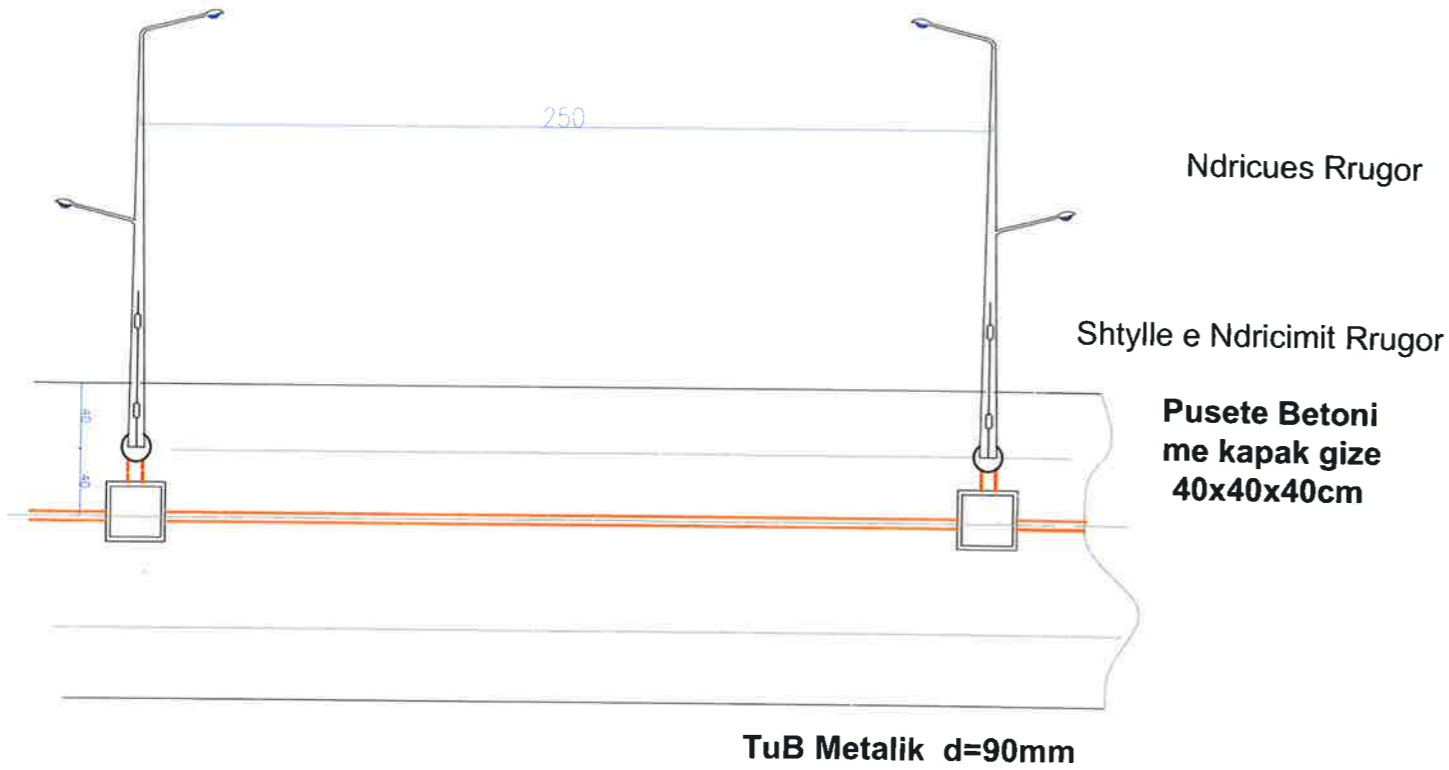

Shtrimi i kabllave te TU ne TP.direkt ne toke

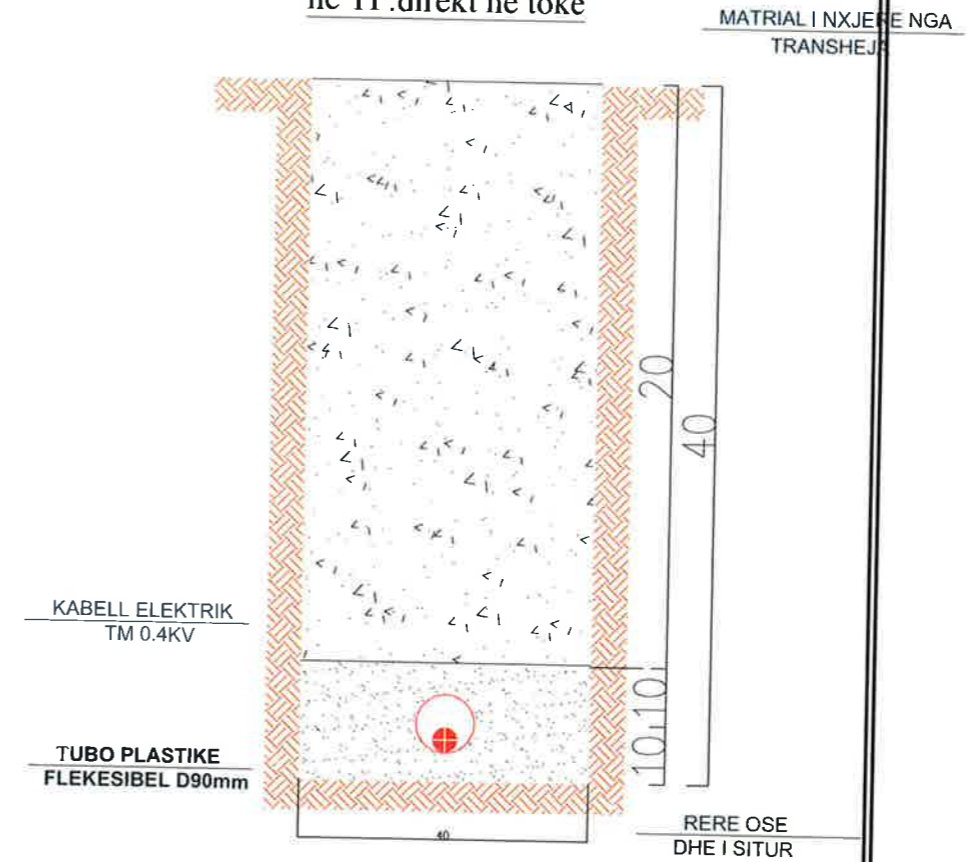

Detaj i montimit te pusetes dhe tokezimit te shtylles

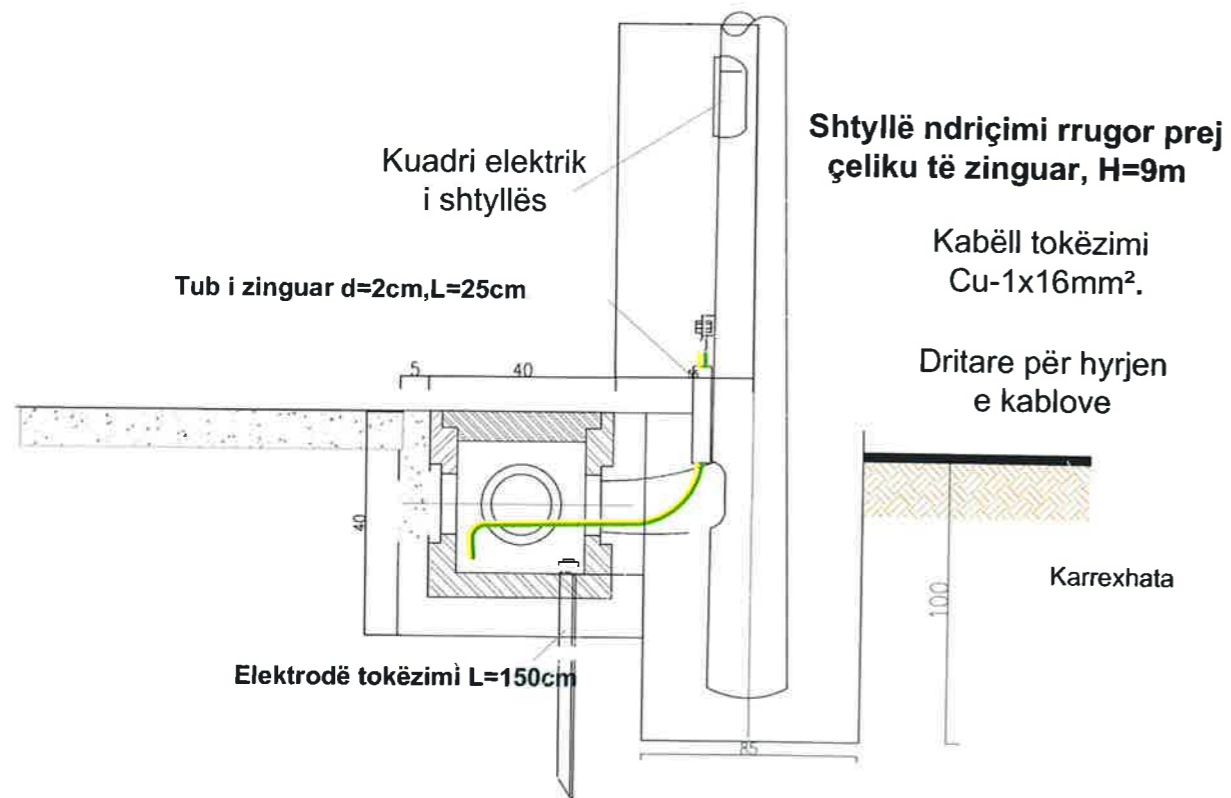

**BASHKIA KAMEZ**  
DREJTORIA E SHERBIMEVE PUBLIKE  
DREJTORIA E PROJEKTEVE DHE INVESTIMEVE  
DEPARTAMENTI I PROJEKTEVE

Dr. e Projekteve e Investimeve	FLORA MUCA	<i>[Signature]</i>
STAFI TEKNIK PROJEKTES	Ing. ARJOLA KURTI	<i>[Signature]</i>
	Ing. ERBLIN LALA	<i>[Signature]</i>
	Ing. DENIS PRENCI	<i>[Signature]</i>
	Ing. RAMADAN HYSA	<i>[Signature]</i>

Titulli i Projektit	Faza e Projektit
NDERTIM RRUGET "PJESHKORE, VELIPOJE, + RRUGICAT, BALLSHI, VALIAS PINGUL ME HEKURAN DEDED LAKNAS"	PROJEKT ZBATIMI
Emertimi i Fletes	Data e Implementimit:
DETAJE	Shkalla e Vizimit:
	1:50
	Fleta nr.
	07



# VENDOSJA DHE MONTIMI I SHENJES RRUGORE

# SHENJA LAJMERUESE

LAJMERIM PER NDERPRERJE NGA RRUGE DYTESORE, KTHESAT E KURBEZUARA, FEMIJET, KEMBESORET DHE PER NDALJE/DHENIE RRUGE

TREKENDSHI: E KUQE REFLEKTUESE  
SFONDI: I ZI  
SIMBOLI: E BARDHE REFLEKTUESE



TRIANGLE: RED REFLECTIVE  
BACKGROUND: WHITE REFLECTIVE  
SYMBOL: BLACK

# SHENJA NDALUESE

SHENJAT PER KUFIRIN E SHPEJTESISE DHE NDALIM PARAKALIMIN

RRETHI: E KUQE REFLEKTUESE  
SHENJA: E ZEZE REFLEKTUESE



SHENIM: SHENJAT RRUGORE PER NGA FORMA, MADHESIA, NGJYRA REFLEKTIVITETI DUHET TE JENE SIPAS KODIT RRUGOR TE REPUBLIKES SE SHQIPERISE MATERIALI PRAPAREFLEKTIV DUHET TE KETE JETEGJATESI 10VJET PER CLASIN 2 DHE 7 VJET PER CLASIN 1 SIMBOLI BRENDA SHENJES RRUGORE DUHET TE JETE I REALIZUAR ME BOJE TE TRAJTUAR ME PJEKJE E CILA NUK HUMBET TREGUESIT PRAPAREFLEKTIV SHENJA RRUGORE REALIZOHET ME LLAMARINE ÇELIKU E CILA LYHET ME BOJE OPAKE KUNDRANDRA KORROZIONIT DHE TRAJTOHET ME PJEKJE.

VENDOSJA E SHENJES RRUGORE

PRERJA TERTHORE E TABELES

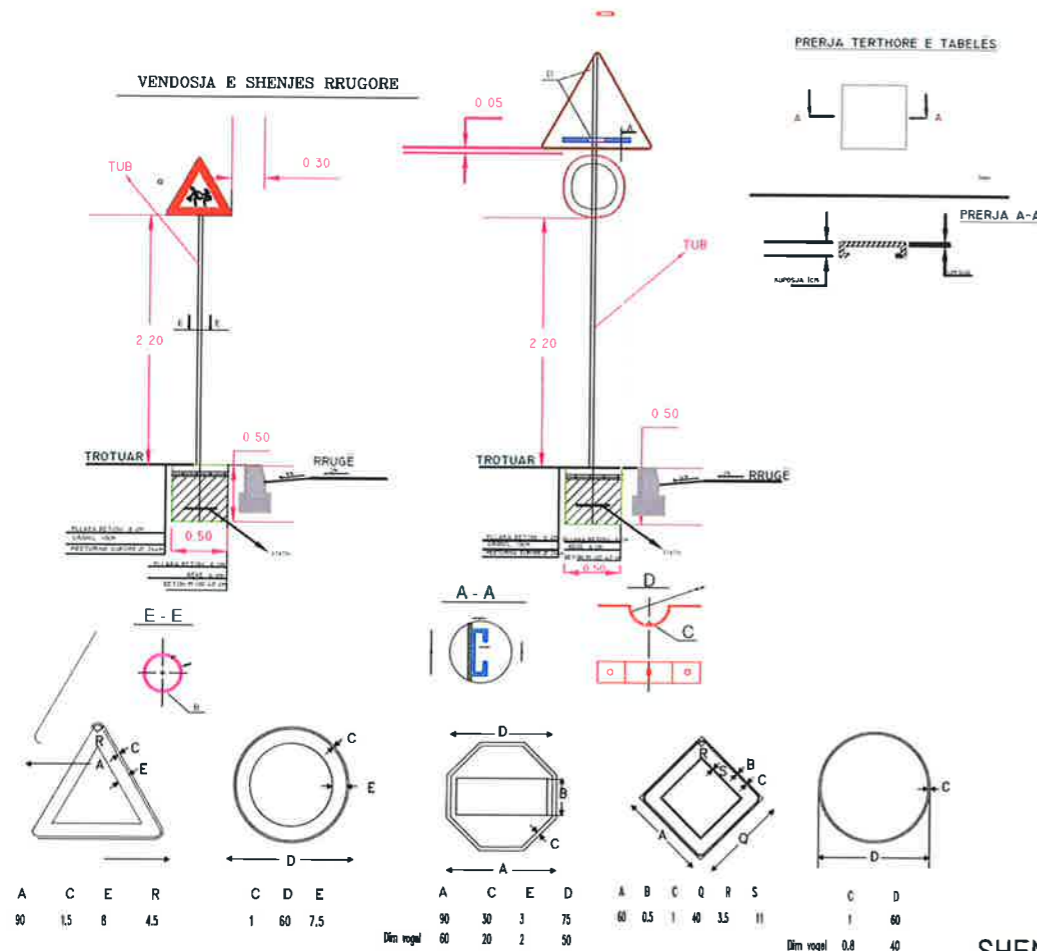

DETAJE Kurrizë artificiale h=5cm

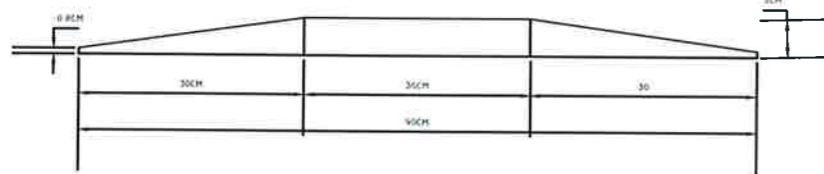

# SHENJA DETYRUESE

ANET & SHIGJETAT: E BARDHE REFLEKTUESE

EDGE & ARROW: WHITE REFLECTIVE



# SHENJA PLOTESUESE

SHENJA E KTHESES NE NJE DREJTIM & DY DREJTIME

SHENJA : E BARDHE REFLEKTUESE  
SFONDI: E ZEZE



# SHENJA INFORMUESE



**BASHKIA KAMEZ**  
DREJTORIA E SHERBIMEVE PUBLIKE  
DREJTORIA E PROJEKTEVE DHE INVESTIMEVE  
DEPARTAMENTI I PROJEKTEVE

Dr. e Projekteve e Investimeve		FLORA MUCA
STAFI TEKNIK PROJEKTUES	Ing.	ARJOLA KURTI
	Ing.	ERBLIN LALA
	Ing.	DENIS PRENCI
	Ing.	RAMADAN HYSA

Titulli i Projektit		Faza e Projektit
NDERTIM RRUGET "PJESHKORE, VELIPOJE, + RRUGICAT, BALLSHI, VALIAS PINGUL ME HEKURAN DEDED LAKNAS"		PROJEKT ZBATIMI
Emertimi i Fletes		Data e Implementimit :
DETAJE		Shkalla e Vizatimit 1:50
		Pieta Nr. 08



### PUSETE TIP D=100cm

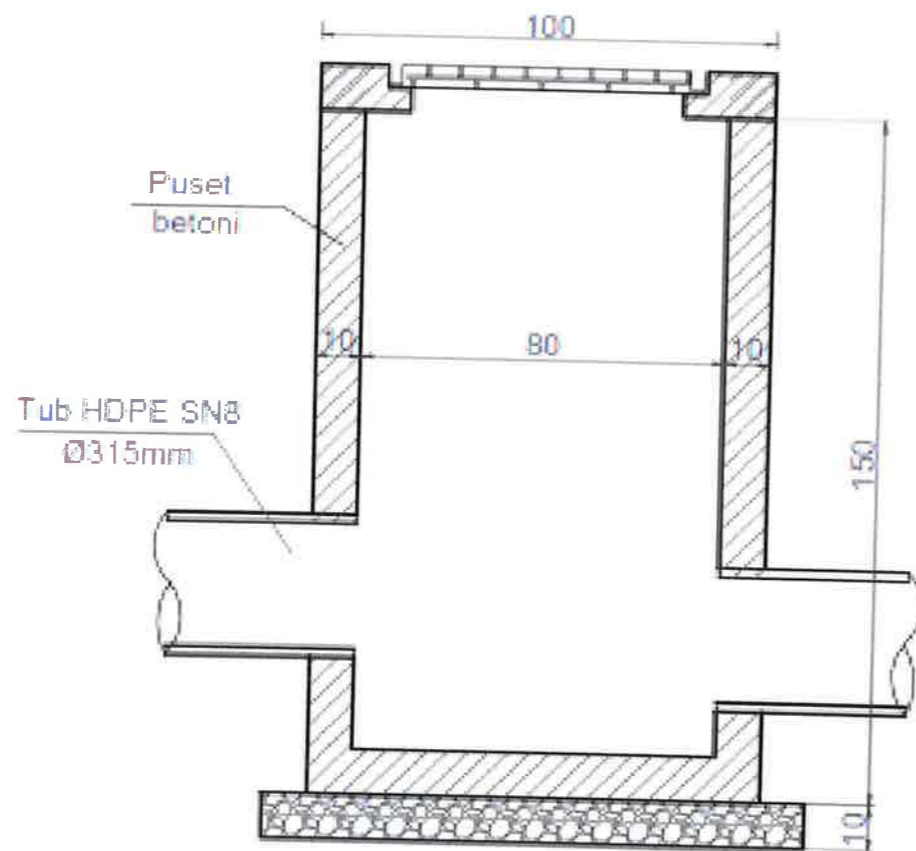
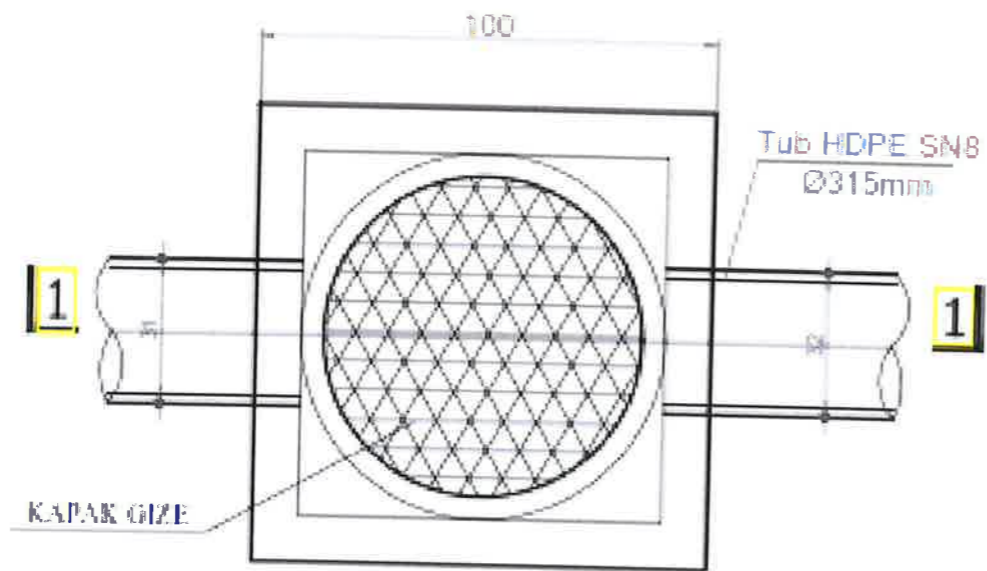



## BASHKIA KAMEZ

DREJTORIA E SHERBIMEVE PUBLIKE  
DREJTORIA E PROJEKTEVE DHE INVESTIMEVE  
DEPARTAMENTI I PROJEKTEVE

Dr. e Projekteve e Investimeve		FLORA MUCA	<i>[Signature]</i>
STAFI TEKNIK PROJEKTUES	Ing.	ARJOLA KURTI	<i>[Signature]</i>
	Ing.	ERBLIN LALA	
	Ing.	DENIS PRENCI	
	Ing.	RAMADAN HYSA	
Titulli i Projektit		Faza e Projektit	
NDERTIM RRUGET "PJESHKORE, VELIPOJE, + RRUICAT, BALLSHI, VALIAS PINGUL ME HEKURAN DEDEN LAKNAS"		PROJEKT ZBATIMI	
Emertimi i Fases		Data e Implementimit	
DETAJE		Shkallë e Vizimit	
		1:50	
		Fleta Nr.	
		13	