

# PROFILE TËRTHORE AKSI 8

Aksi 8  
- Sez.7  
- Progr. 0+120.00  
Scala 1:1000  
Q.Rif. 109.50m

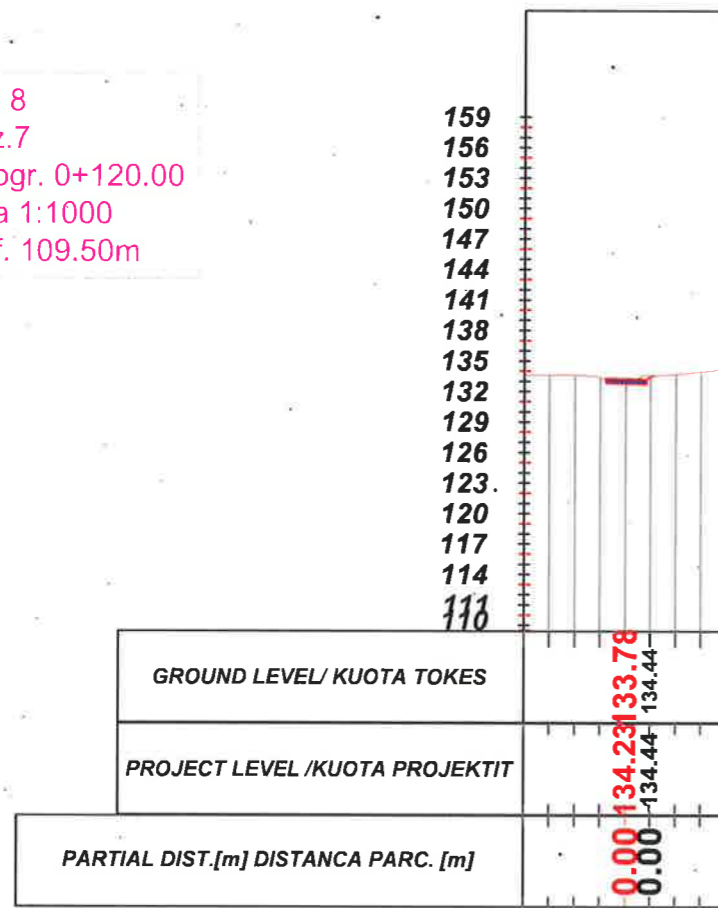

Aksi 8  
- Sez.9  
- Progr. 0+160.00  
Scala 1:1000  
Q.Rif. 118.50m

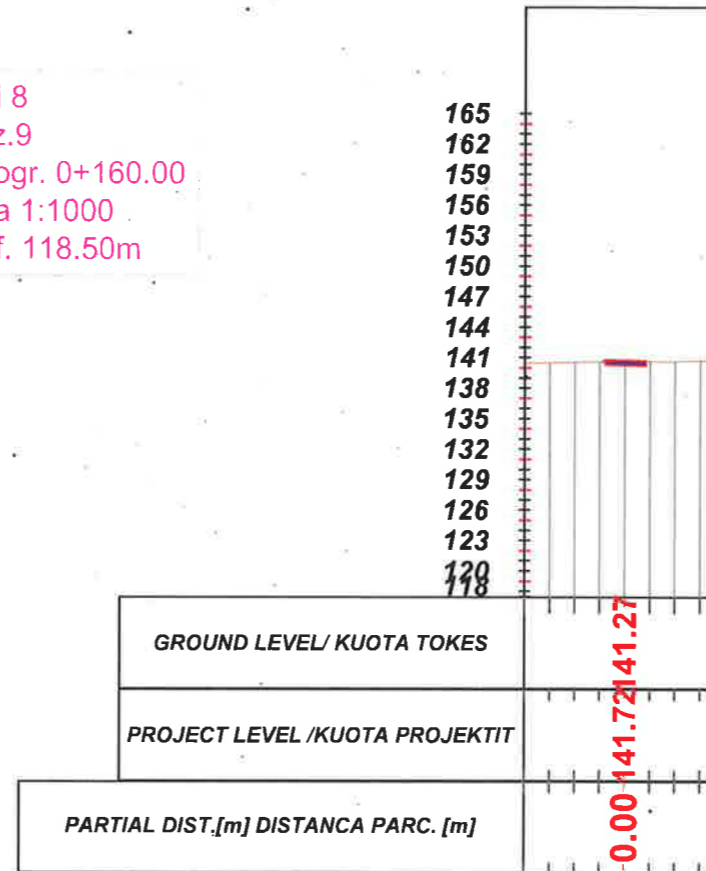

Aksi 8  
- Sez.8  
- Progr. 0+140.00  
Scala 1:1000  
Q.Rif. 112.50m

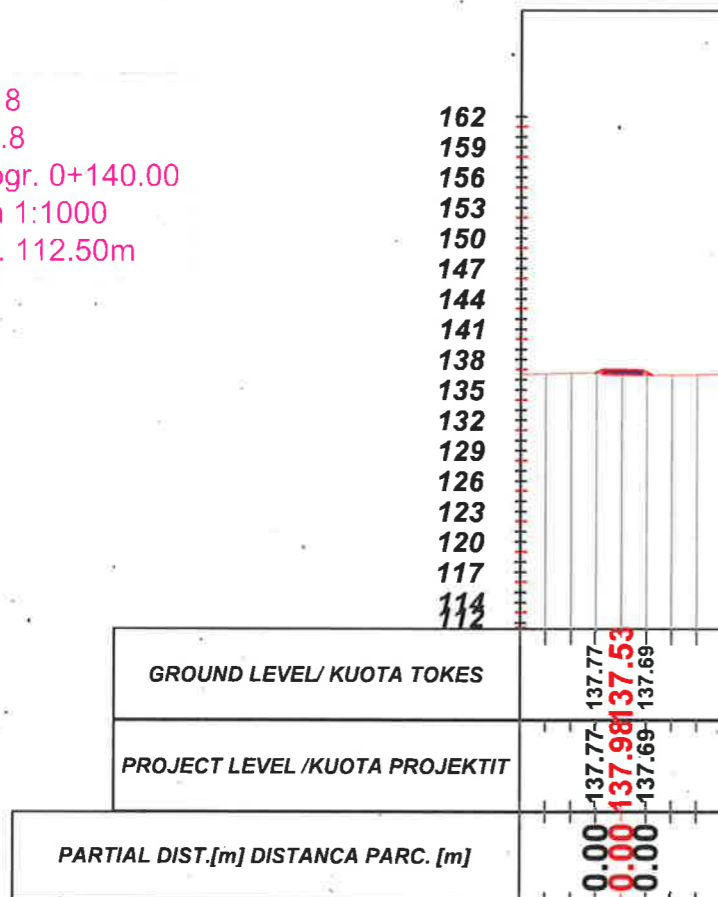

Aksi 8  
- Sez.10  
- Progr. 0+169.97  
Scala 1:1000  
Q.Rif. 118.50m

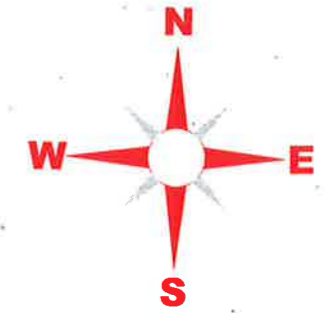
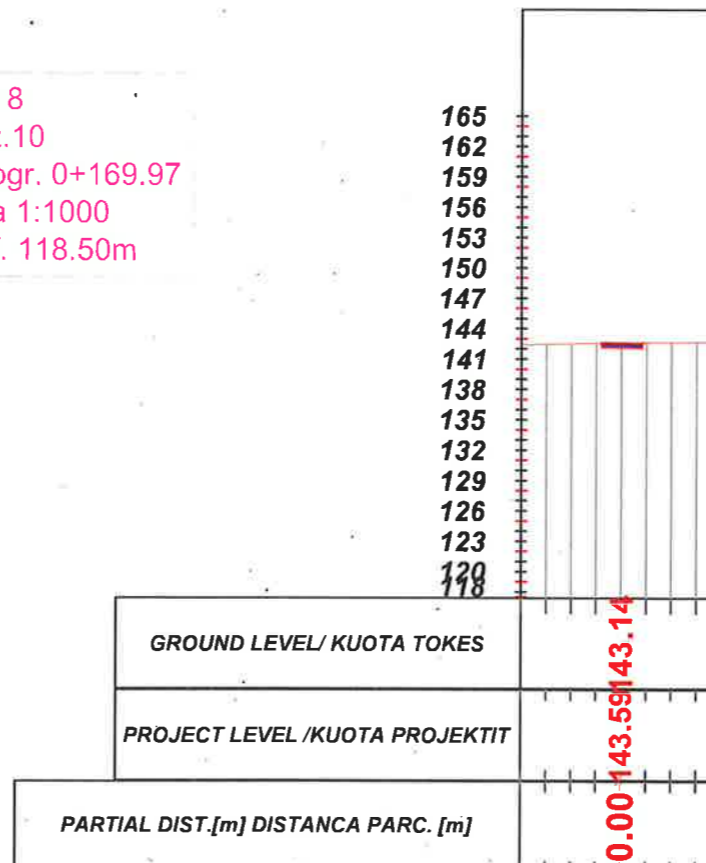

## LEGJENDA

- NIVELETA E RRUGES
- TERRENI NATYRAL



**BASHKIA KAMEZ**

DREJTORIA E PROJEKTEVE DHE INVESTIMEVE  
DEPARTAMENTI I PROJEKTEVE

Dr. e Projekteve e Investimeve	RAMADAN HYSA	
Pergj. Sektori i Projekteve	DENIS PRENÇI	
STAFI TEKNIK PROJEKTUES	Ing. EMANUELA MËZIU	
	Ing. ARTUR ÇAJKA	
	Ing. ALEKS DANI	
	Ark. ESTELA GJYRIQI	

Titulli i Projektit	Faza e Projektit
NDERTIM RRUGËT "PASKUQAN 1 DHE 2"	PROJEKT ZBATIMI
Emertimi i Fletes	Data e Implementimit :
PROFILET TËRTHORE	Shkalla e Vizatimit
	H 1:250
	Fleta Nr.
	01 (50)

# PROFILE TËRTHORE AKSI 9

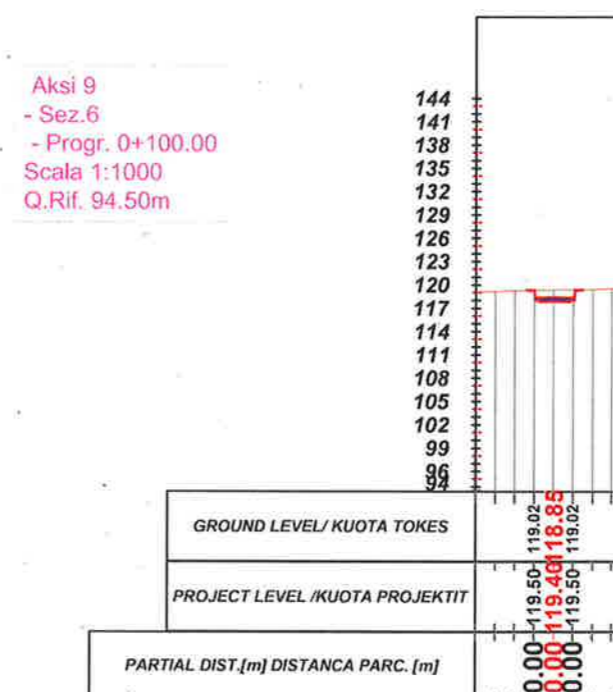
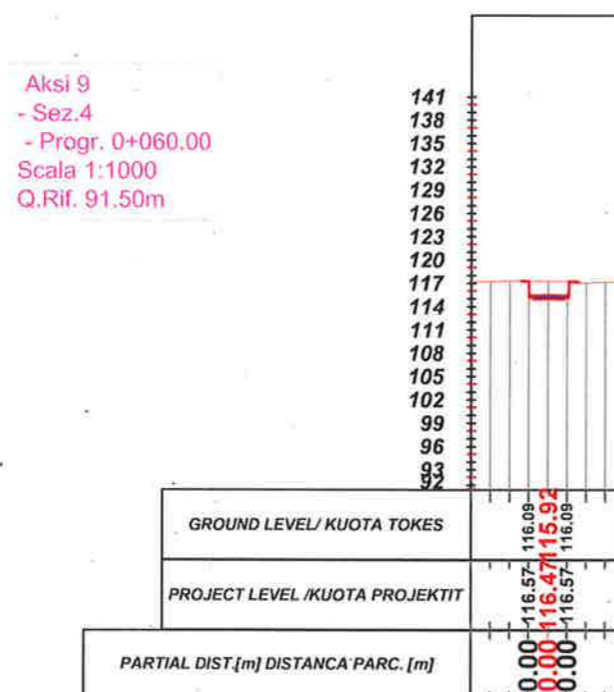
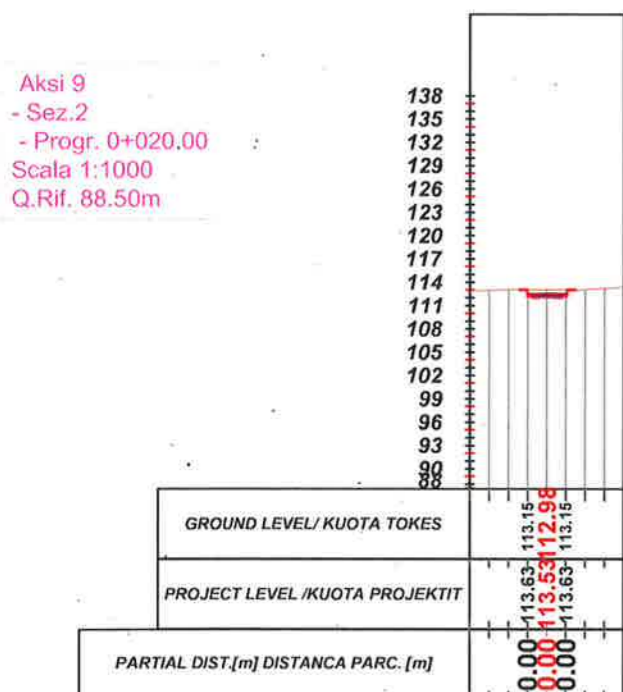
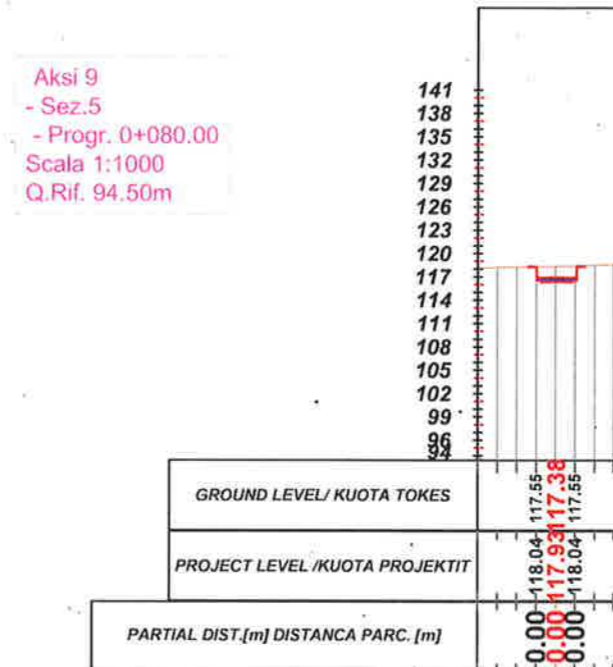
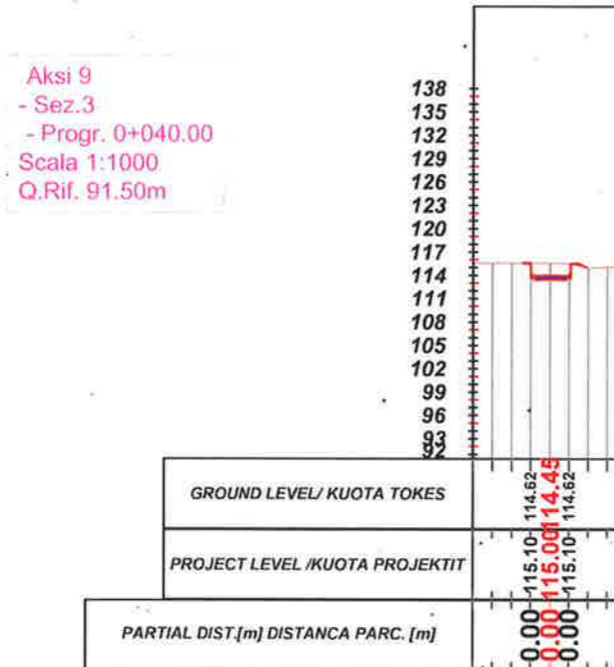
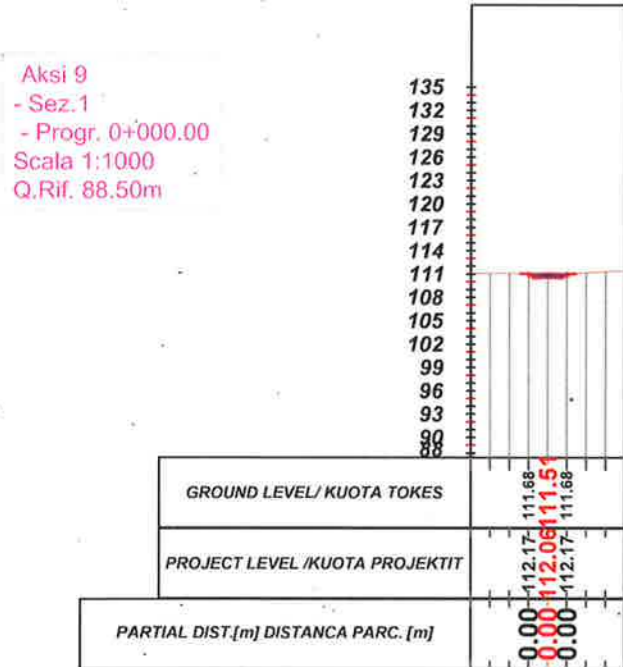
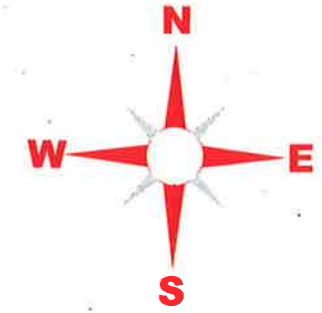

## LEGJENDA

- NIVELETA E RRUGES
- TERRENI NATYRAL



**BASHKIA KAMEZ**

DREJTORIA E PROJEKTEVE DHE INVESTIMEVE  
DEPARTAMENTI I PROJEKTEVE

Dr. e Projekteve e Investimeve	RAMADAN HYSA	
Pergj. Sektori i Projekteve	DENIS PRENÇI	
STAFI TEKNIK PROJEKTES	Ing. EMANUELA MËZIU	
	Ing. ARTUR ÇAJKA	
	Ing. ALEKS DANI	
	Ark. ESTELA GJYRIQI	

Titulli i Projektit	Faza e Projektit
NDERTIM RRUGËT "PASKÛQAN I DHE 2"	PROJEKT ZBATIMI
Emertimi i Fletes	Data e Implementimit :
PROFLET TËRTHORE	H 1:250
	Fleta Nr.
	01 (51)

# PROFILE TËRTHORE AKSI 9

Aksi 9  
- Sez.7  
- Progr. 0+120.00  
Scala 1:1000  
Q.Rif. 97.50m

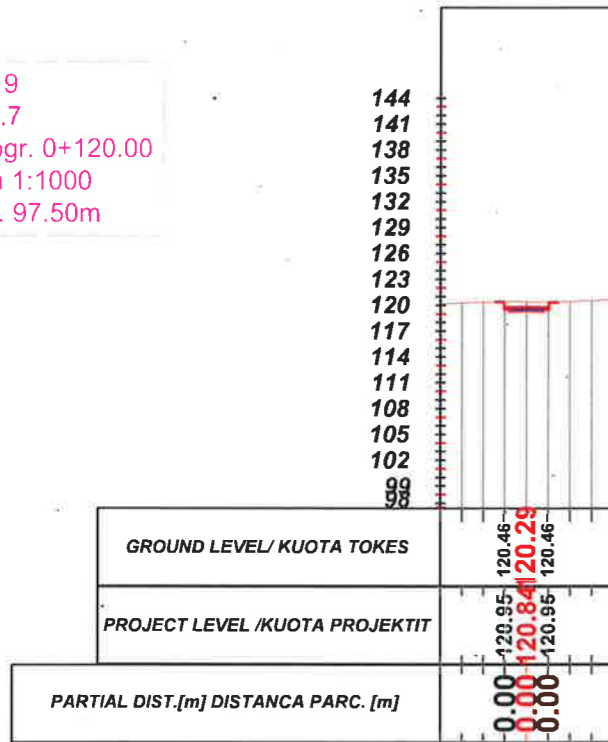

Aksi 9  
- Sez.9  
- Progr. 0+160.00  
Scala 1:1000  
Q.Rif. 100.50m

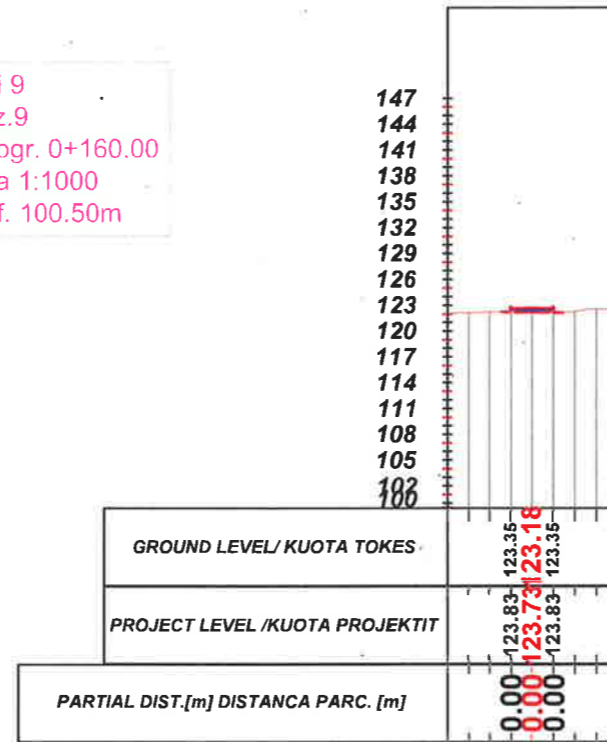

Aksi 9  
- Sez.11  
- Progr. 0+200.00  
Scala 1:1000  
Q.Rif. 100.50m

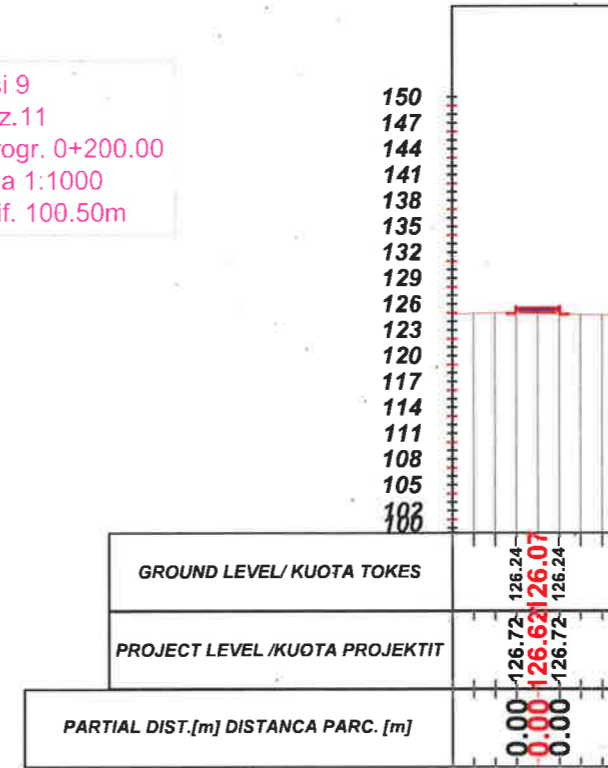

Aksi 9  
- Sez.8  
- Progr. 0+140.00  
Scala 1:1000  
Q.Rif. 97.50m

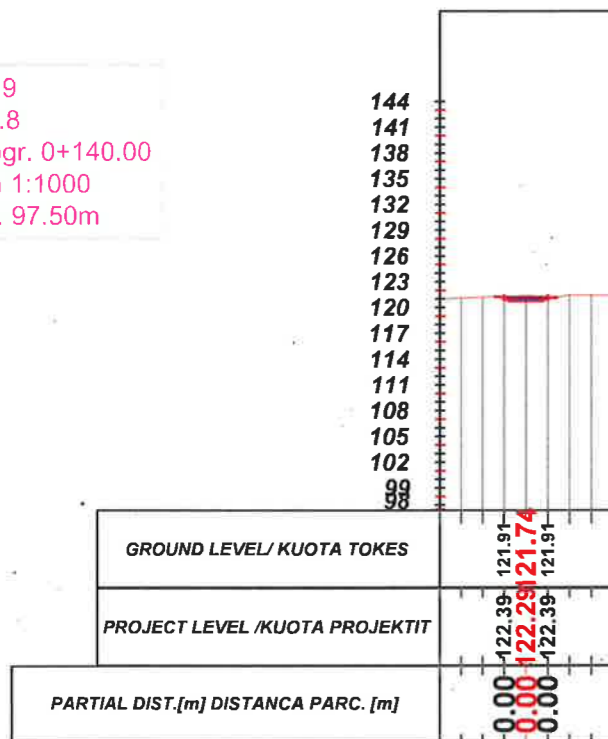

Aksi 9  
- Sez.10  
- Progr. 0+180.00  
Scala 1:1000  
Q.Rif. 100.50m

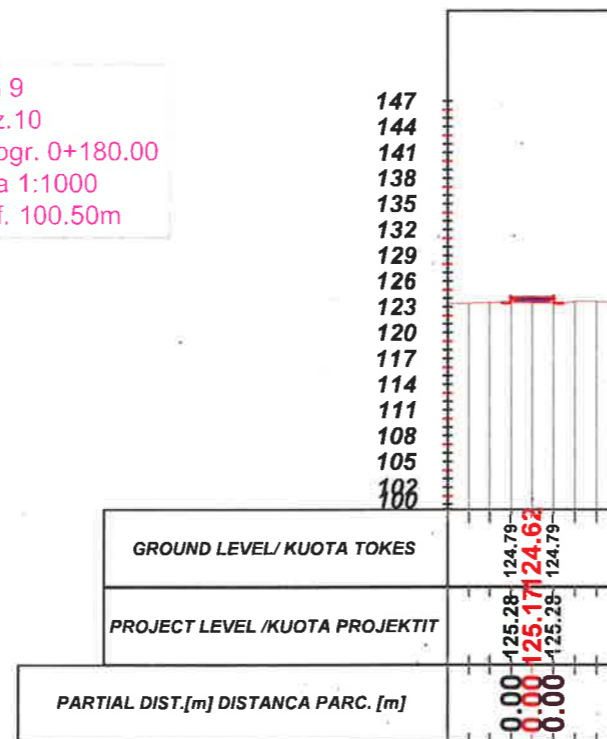

Aksi 9  
- Sez.12  
- Progr. 0+220.00  
Scala 1:1000  
Q.Rif. 103.50m

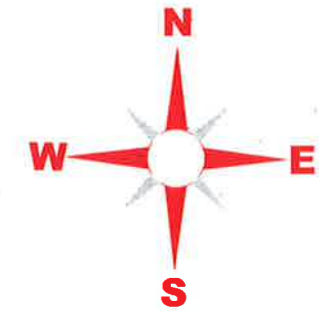
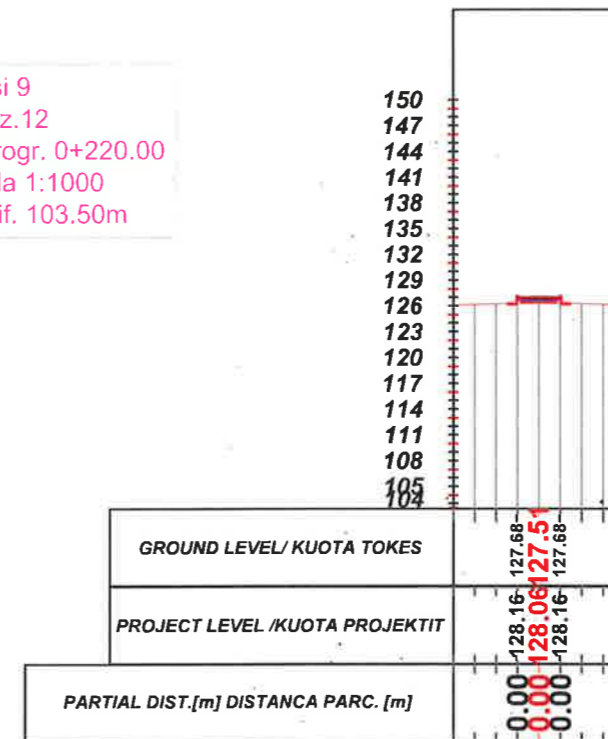

## LEGJENDA

- NIVELETA E RRUGES
- TERRENI NATYRAL



## BASHKIA KAMEZ

DREJTORIA E PROJEKTEVE DHE INVESTIMEVE  
DEPARTAMENTI I PROJEKTEVE

Dr. e Projekteve e Investimeve	RAMADAN HYSA	<i>[Signature]</i>
Pergj. Sektori i Projekteve	DENIS PRENÇI	<i>[Signature]</i>
STAFI TEKNIK PROJEKTES	Ing. EMANUELA MËZIU	<i>[Signature]</i>
	Ing. ARTUR ÇAJKA	<i>[Signature]</i>
	Ing. ALEKS DANI	<i>[Signature]</i>
	Ark. ESTELA GJYRIQI	<i>[Signature]</i>

Titulli i Projektit	NDERTIM RRUGËT "PASKUQAN 1 DHE 2"	Faza e Projektit	PROJEKT ZBATIMI
Emeritimi i Fletes	PROFILET TËRTHORE	Data e implementimit :	
		Shkalla e Vizimit	H 1:250
		Fleta Nr.	01 (52)

# PROFILE TËRTHORE AKSI 9

Aksi 9  
- Sez.13  
- Progr. 0+240.00  
Scala 1:1000  
Q.Rif. 103.50m

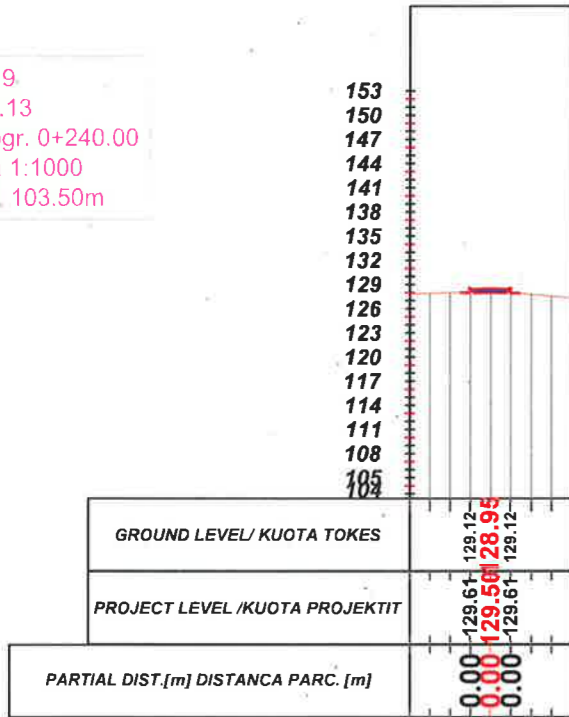

Aksi 9  
- Sez.15  
- Progr. 0+280.00  
Scala 1:1000  
Q.Rif. 106.50m

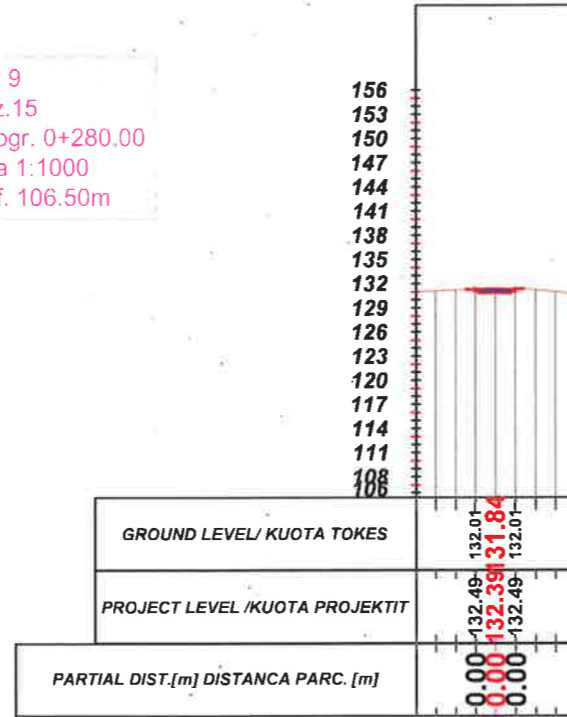

Aksi 9  
- Sez.17  
- Progr. 0+320.00  
Scala 1:1000  
Q.Rif. 109.50m

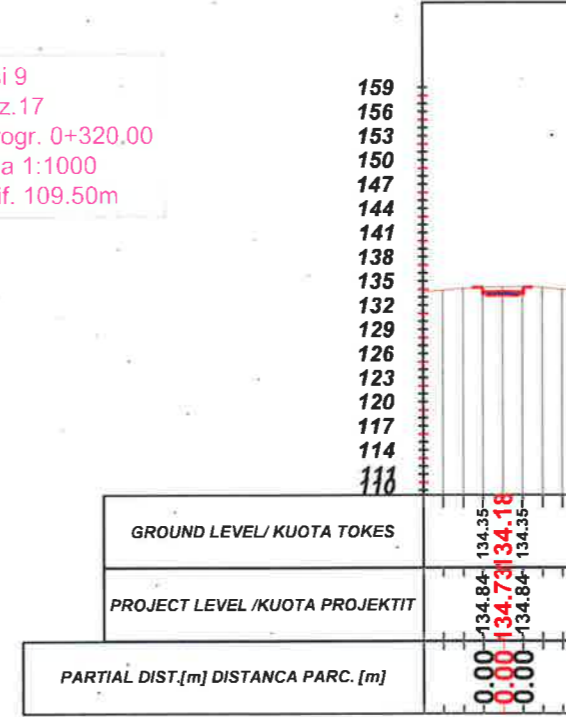

Aksi 9  
- Sez.14  
- Progr. 0+260.00  
Scala 1:1000  
Q.Rif. 106.50m

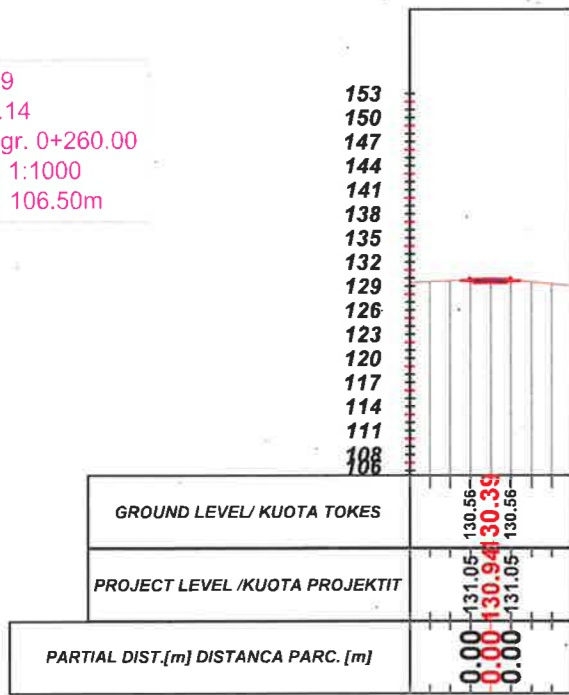

Aksi 9  
- Sez.16  
- Progr. 0+300.00  
Scala 1:1000  
Q.Rif. 109.50m

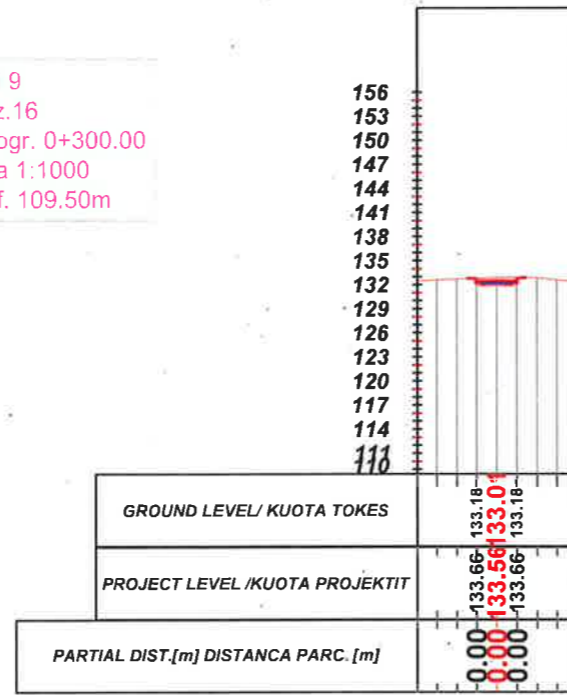

Aksi 9  
- Sez.18  
- Progr. 0+340.00  
Scala 1:1000  
Q.Rif. 112.50m

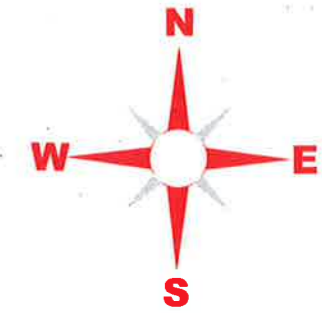
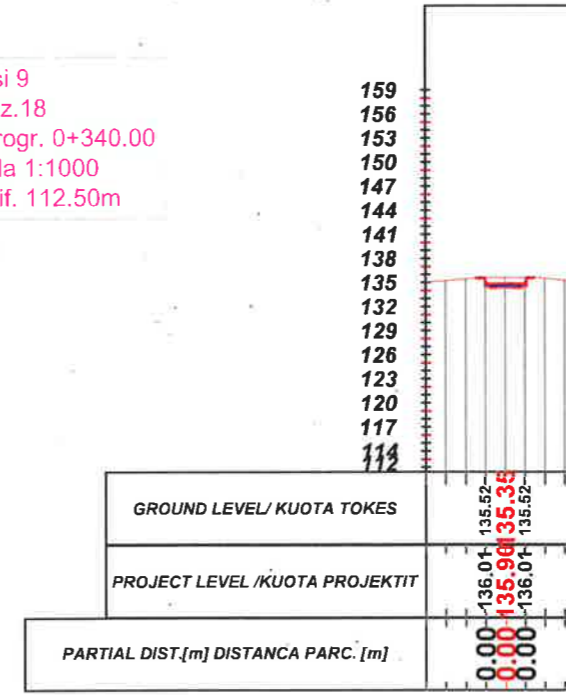

## LEGJENDA

- NIVELETA E RRUGES
- TERRENI NATYRAL



## BASHKIA KAMEZ

DREJTORIA E PROJEKTEVE DHE INVESTIMEVE  
DEPARTAMENTI I PROJEKTEVE

Dr. e Projekteve e Investimeve	RAMADAN HYSA	
Pergj. Sektori i Projekteve	DENIS PRENÇI	
STAFI TEKNIK	Ing. EMANUELA MËZIÛ	
PROJEKTUES	Ing. ARTUR ÇAJKA	
	Ing. ALEKS DANI	
	Ark. ESTELA GJYRIQI	

Titulli i Projektit	Faza e Projektit
NDERTIM RRUGËT "PASKUQAN I DHE 2"	PROJEKT ZBATIMI
Emergimi i Fietes	Data e Implementimit :
PROFILET TËRTHORE.	Shkalla e Vizatimit
	H 1:250
	Fleta Nr.
	01 (53)

# PROFILE TËRTHORE AKSI 9

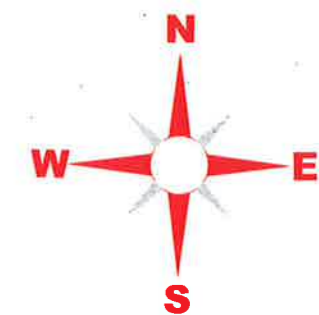

Aksi 9  
- Sez.19  
- Progr. 0+360.00  
Scala 1:1000  
Q.Rif. 112.50m

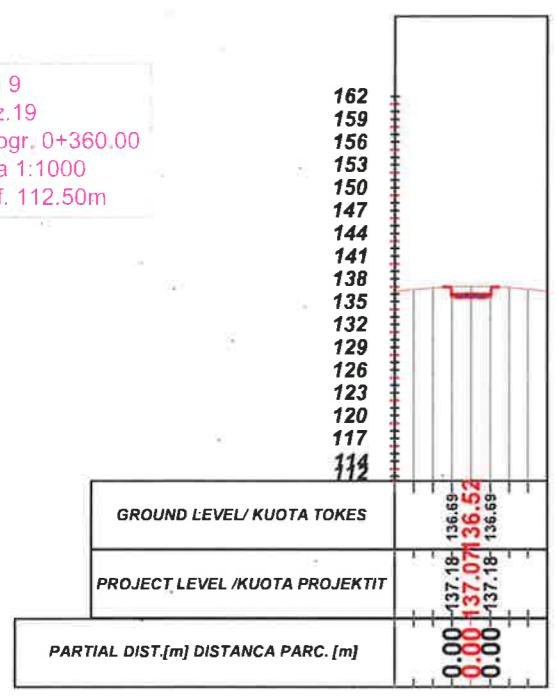

Aksi 9  
- Sez.21  
- Progr. 0+400.00  
Scala 1:1000  
Q.Rif. 115.50m

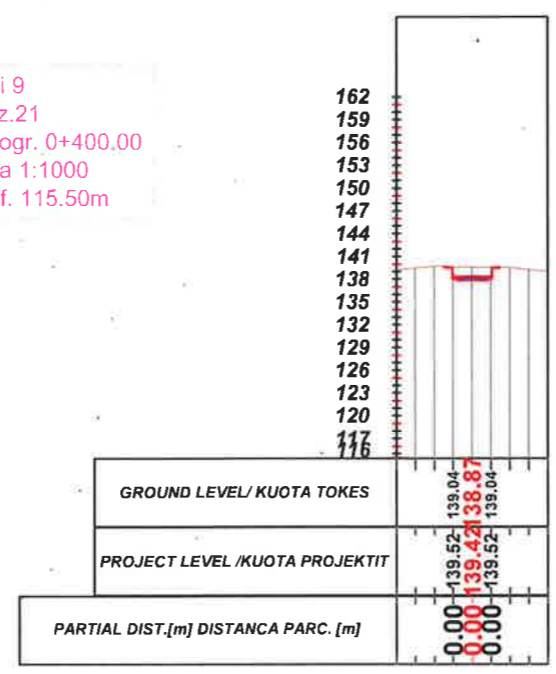

Aksi 9  
- Sez.23  
- Progr. 0+440.00  
Scala 1:1000  
Q.Rif. 118.50m

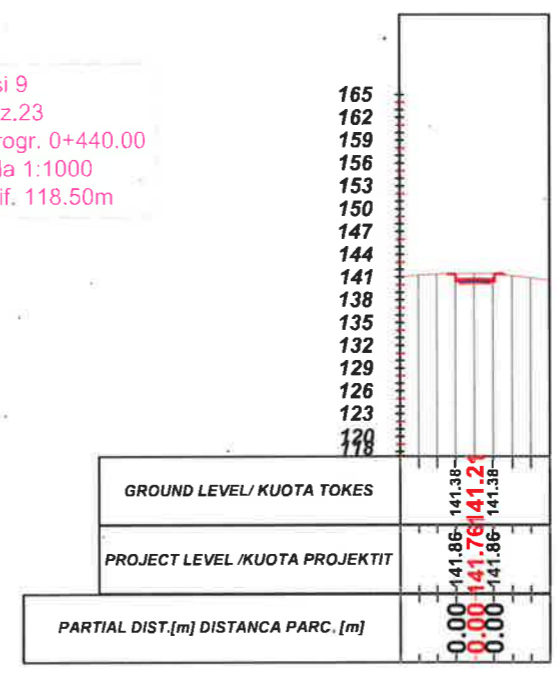

Aksi 9  
- Sez.20  
- Progr. 0+380.00  
Scala 1:1000  
Q.Rif. 112.50m

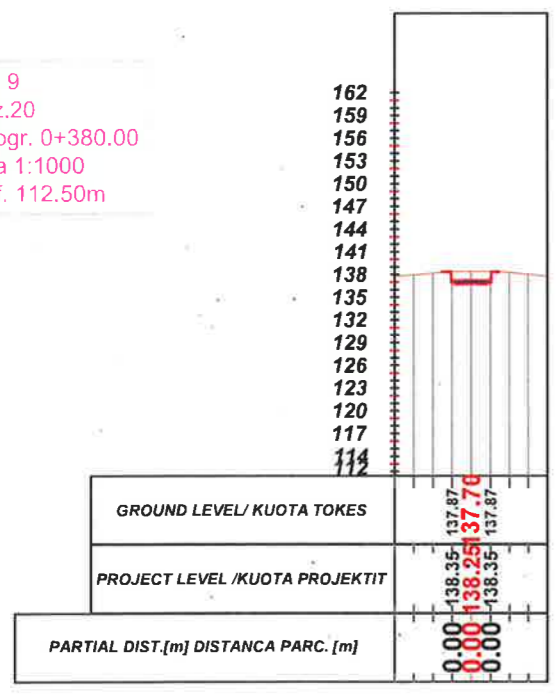

Aksi 9  
- Sez.22  
- Progr. 0+420.00  
Scala 1:1000  
Q.Rif. 115.50m

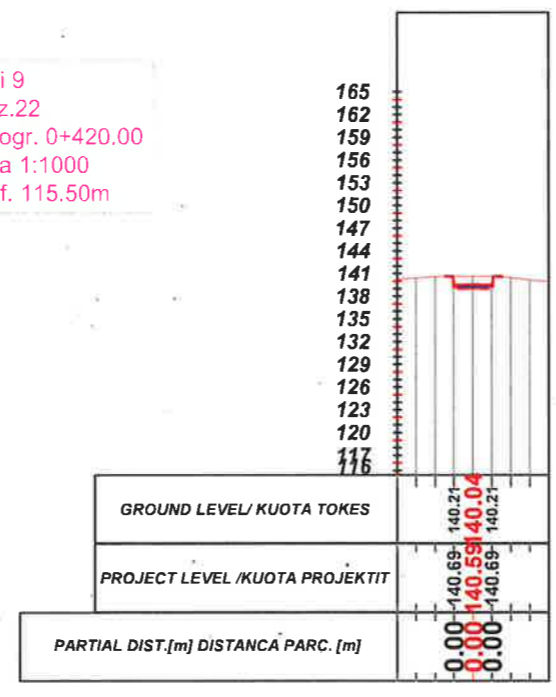

Aksi 9  
- Sez.24  
- Progr. 0+460.00  
Scala 1:1000  
Q.Rif. 118.50m

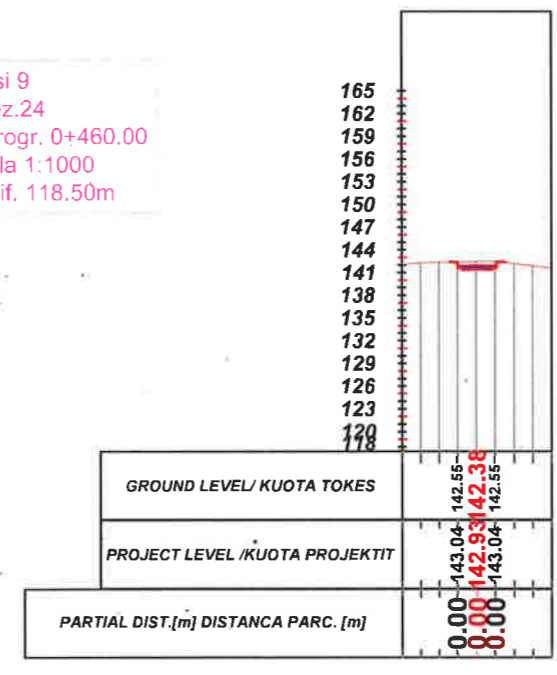

## LEGJENDA

- NIVELETA E RRUGES
- TERRENI NATYRAL

**BASHKIA KAMEZ**  
DREJTORIA E PROJEKTEVE DHE INVESTIMEVE  
DEPARTAMENTI I PROJEKTEVE

Dr. e Projekteve e Investimeve	RAMADAN HYSA	
Pergj. Sektori i Projekteve	DENIS PRENÇI	
STAFI TEKNIK	Ing. EMANUELA MËZIU	
PROJEKTUES	Ing. ARTUR ÇAJKA	
	Ing. ALEKS DANI	
	Ark. ESTELA GJYRIQI	

Titulli i Projektit	Faza e Projektit
NDERTIM RRUGËT "PASKUQAN I DHE 2"	PROJEKT ZBATIMI
Emergjimi i Fletes	Data e Implementimit :
PROFLET TËRTHORE	Shkalla e Vizatimit :
	H 1:250
	Fleta Nr.
	01 (54)

# PROFILE TËRTHORE AKSI 9

Aksi 9  
- Sez.25  
- Progr. 0+480.00  
Scala 1:1000  
Q.Rif. 118.50m

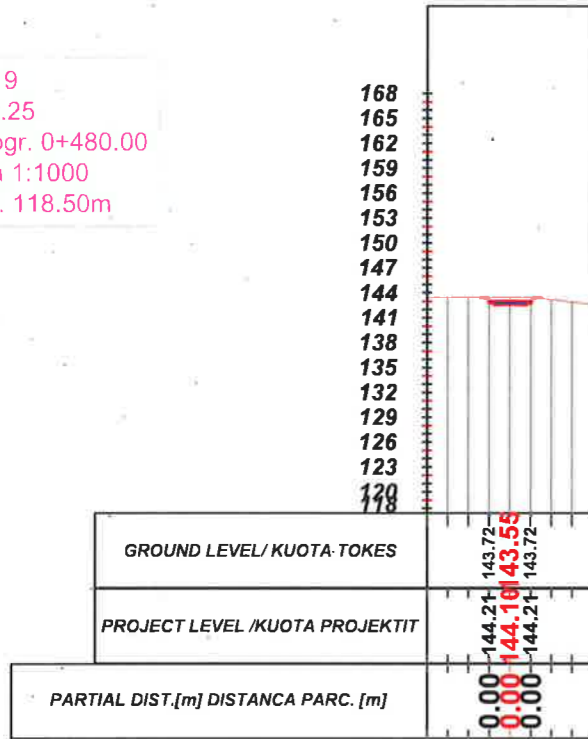

Aksi 9  
- Sez.27  
- Progr. 0+520.00  
Scala 1:1000  
Q.Rif. 121.50m

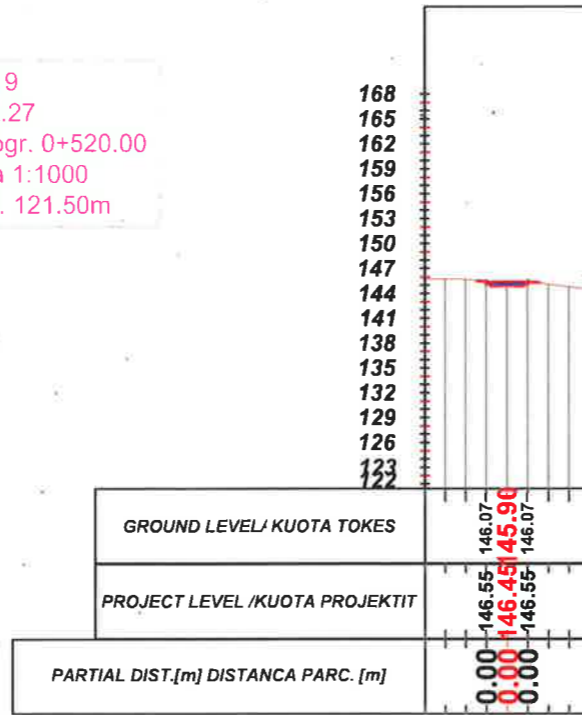

Aksi 9  
- Sez.29  
- Progr. 0+560.00  
Scala 1:1000  
Q.Rif. 121.50m

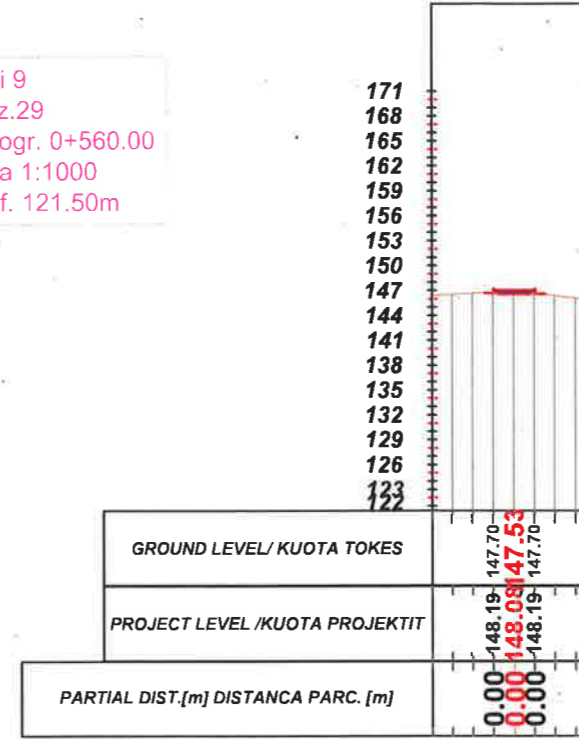

Aksi 9  
- Sez.26  
- Progr. 0+500.00  
Scala 1:1000  
Q.Rif. 121.50m

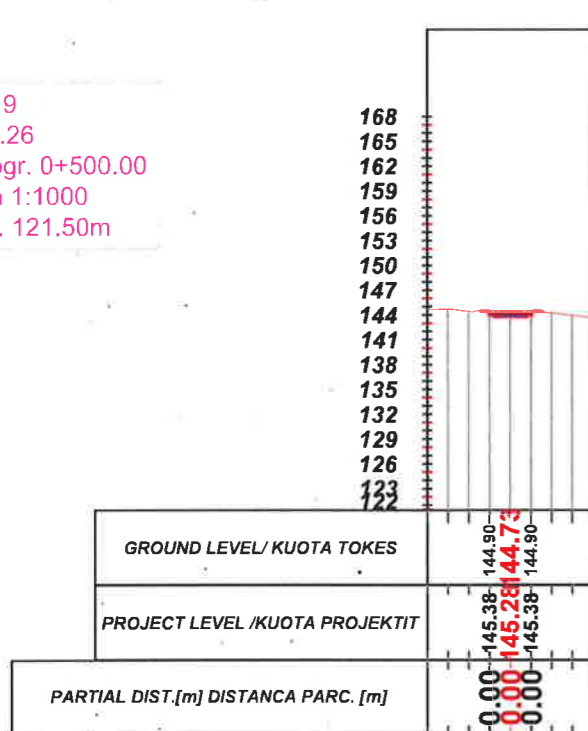

Aksi 9  
- Sez.28  
- Progr. 0+540.00  
Scala 1:1000  
Q.Rif. 121.50m

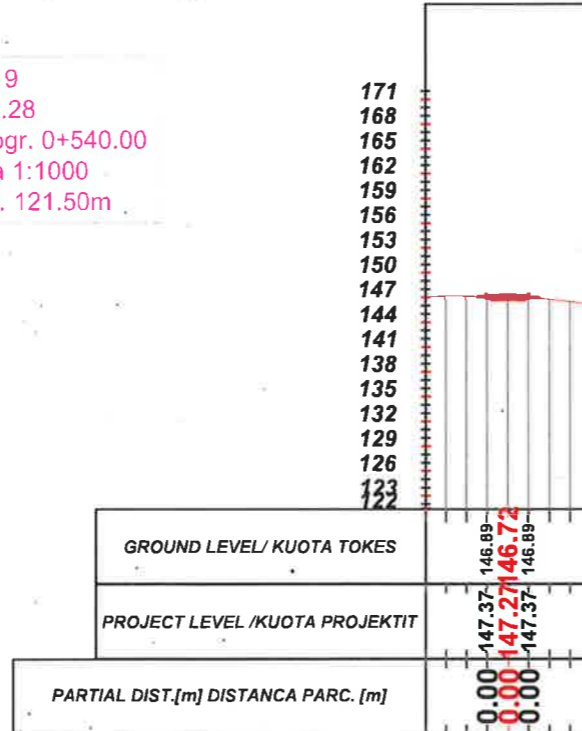

Aksi 9  
- Sez.30  
- Progr. 0+580.00  
Scala 1:1000  
Q.Rif. 124.50m

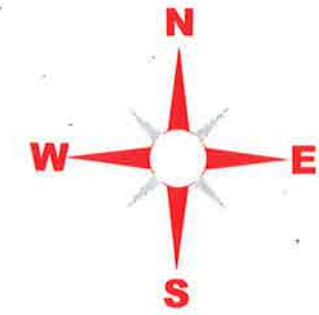
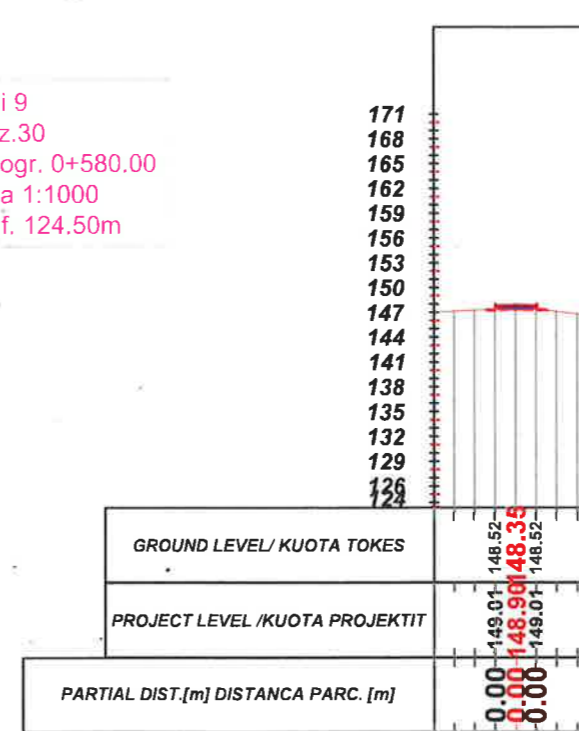

## LEGJENDA

- NIVELETA E RRUGES
- TERRENI NATYRAL



## BASHKIA KAMEZ

DREJTORIA E PROJEKTEVE DHE INVESTIMEVEVE  
DEPARTAMENTI I PROJEKTEVE

Dr. e Projekteve e Investimeve	RAMADAN HYSA	
Pergj. Sektori i Projekteve	DENIS PRENÇI	
STAFI TEKNIK PROJEKTUES	Ing. EMANUELA MËZIU	
	Ing. ARTUR ÇAJKA	
	Ing. ALEKS DANI	
	Ark. ESTELA GJYRIQI	

Titulli i Projektit	Faza e Projektit
NDERTIM RRUGËT "PASKUQAN 1 DHE 2"	PROJEKT ZBATIMI
Emertimi i Fietes	Data e Implementimit :
PROFILET TËRTHORE	Shkalla e Vizatimit
	H 1:250
	Fleta Nr.
	01 (55)

# PROFILE TËRTHORE AKSI 9

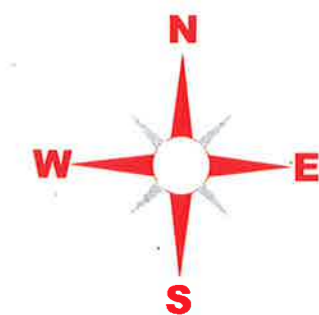

Aksi 9  
- Sez.31  
- Progr. 0+600.00  
Scala 1:1000  
Q.Rif. 124.50m

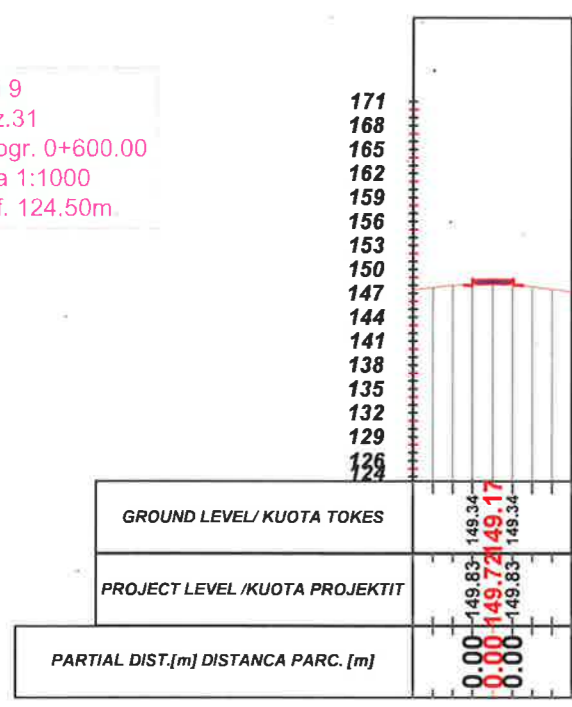

Aksi 9  
- Sez.33  
- Progr. 0+640.00  
Scala 1:1000  
Q.Rif. 124.50m

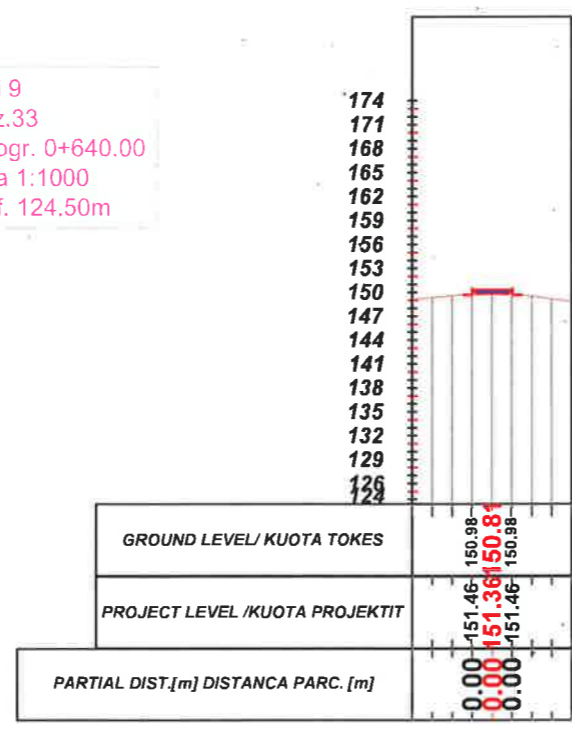

Aksi 9  
- Sez.35  
- Progr. 0+680.00  
Scala 1:1000  
Q.Rif. 127.50m

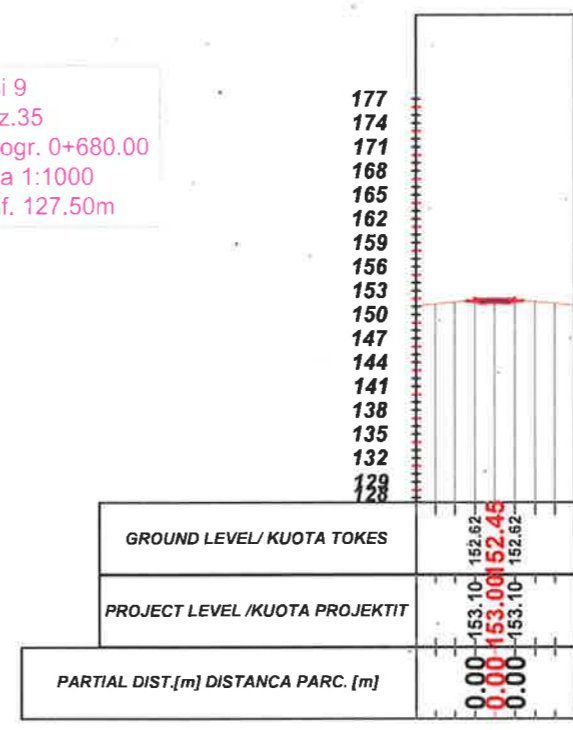

Aksi 9  
- Sez.32  
- Progr. 0+620.00  
Scala 1:1000  
Q.Rif. 124.50m

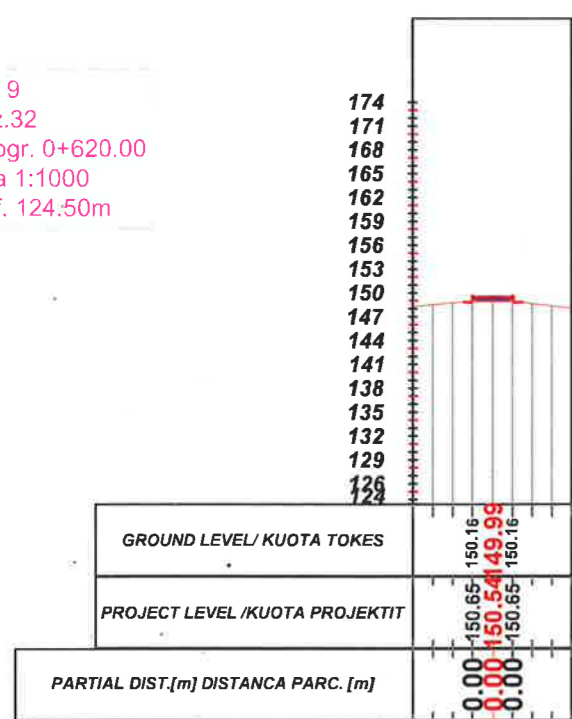

Aksi 9  
- Sez.34  
- Progr. 0+660.00  
Scala 1:1000  
Q.Rif. 127.50m

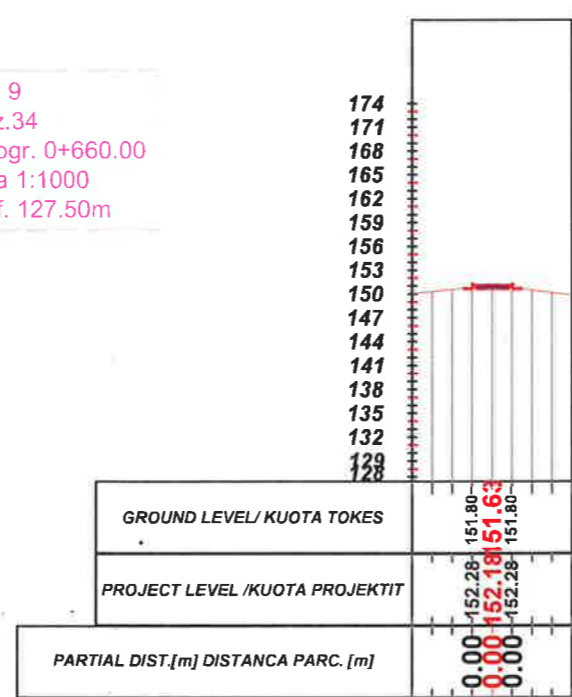

Aksi 9  
- Sez.36  
- Progr. 0+700.00  
Scala 1:1000  
Q.Rif. 130.50m

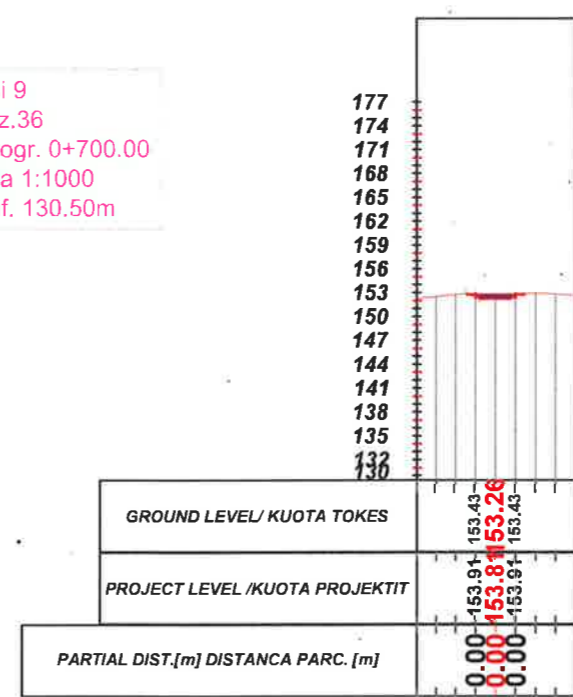

## LEGJENDA

- NIVELETA E RRUGES
- TERRENI NATYRAL

**BASHKIA KAMEZ**  
DREJTORIA E PROJEKTEVE DHE INVESTIMEVE  
DEPARTAMENTI I PROJEKTEVE

Dr. e Projekteve e Investimeve	RAMADAN HYSA	
Pergj. Sektori i Projekteve	DENIS PRENÇI	
STAFI TEKNIK	Ing. EMANUELA MËZIU	
PROJEKTUES	Ing. ARTUR ÇAJKA	
	Ing. ALEKS DANI	
	Ark. ESTELA GJYRIQI	

Titulli i Projektit	Faza e Projektit
NDERTIM RRUGËT "PASKUQAN 1 DHE 2"	PROJEKT ZBATIMI
Emeritimi i Fletes	Data e Implementimit :
PROFILET TËRTHORE	Shkalla e Vizatimit
	H 1:250
	Fleta Nr.
	01 (56)

# PROFILE TËRTHORE AKSI 9

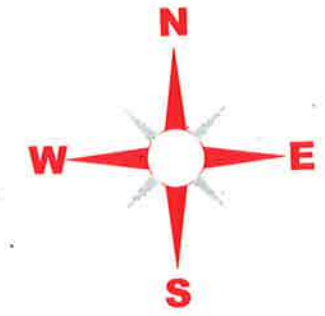

Aksi 9  
- Sez.37  
- Progr. 0+720.00  
Scala 1:1000  
Q.Rif. 130.50m

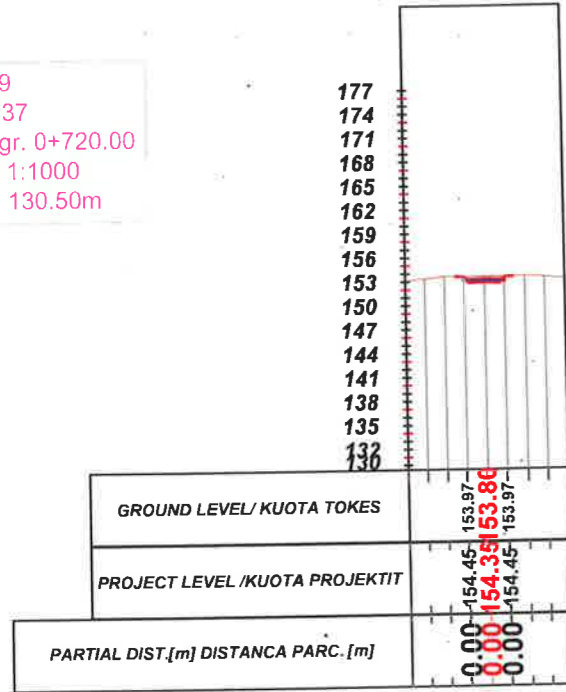

Aksi 9  
- Sez.39  
- Progr. 0+760.00  
Scala 1:1000  
Q.Rif. 130.50m

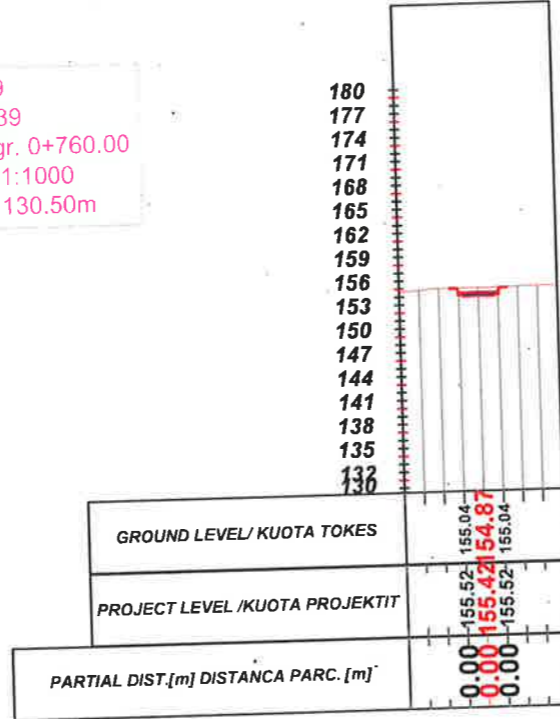

Aksi 9  
- Sez.41  
- Progr. 0+800.00  
Scala 1:1000  
Q.Rif. 130.50m

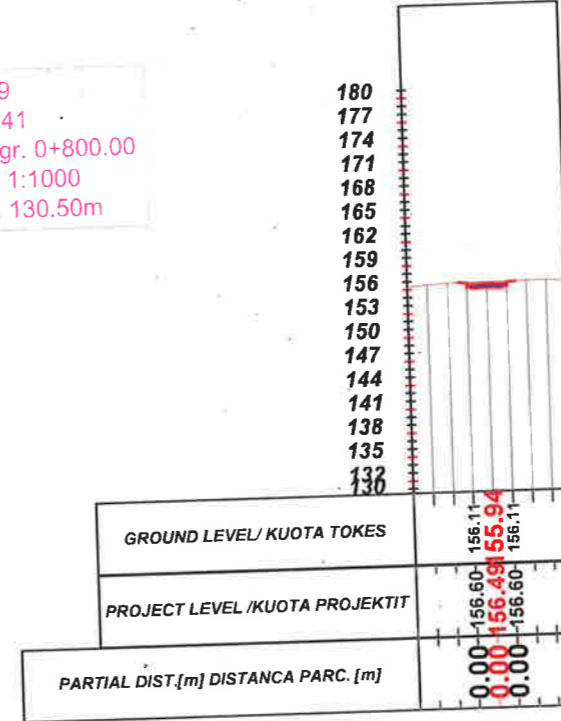

Aksi 9  
- Sez.38  
- Progr. 0+740.00  
Scala 1:1000  
Q.Rif. 130.50m

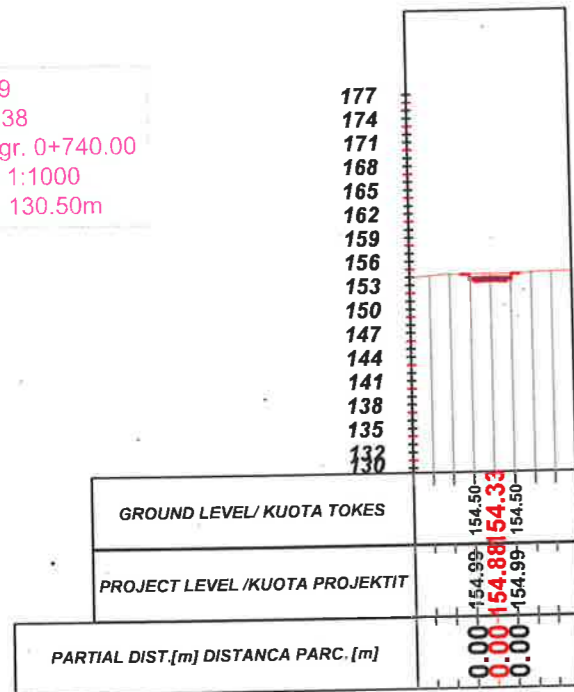

Aksi 9  
- Sez.40  
- Progr. 0+780.00  
Scala 1:1000  
Q.Rif. 130.50m

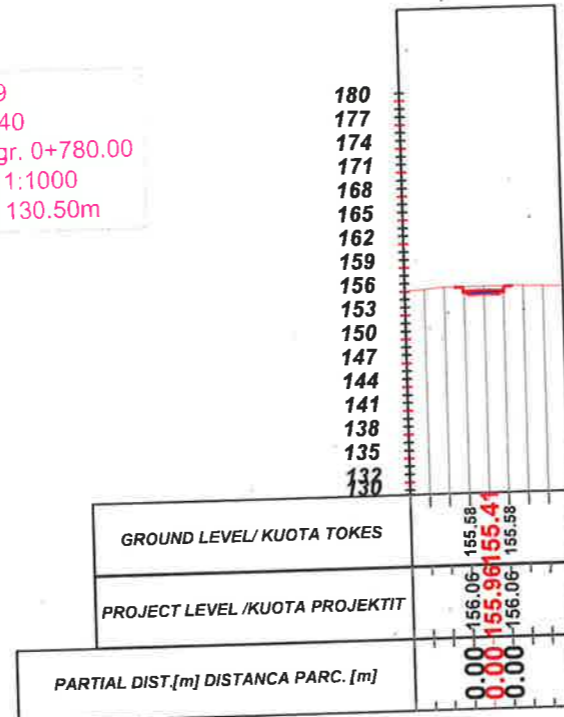

Aksi 9  
- Sez.42  
- Progr. 0+820.00  
Scala 1:1000  
Q.Rif. 133.50m

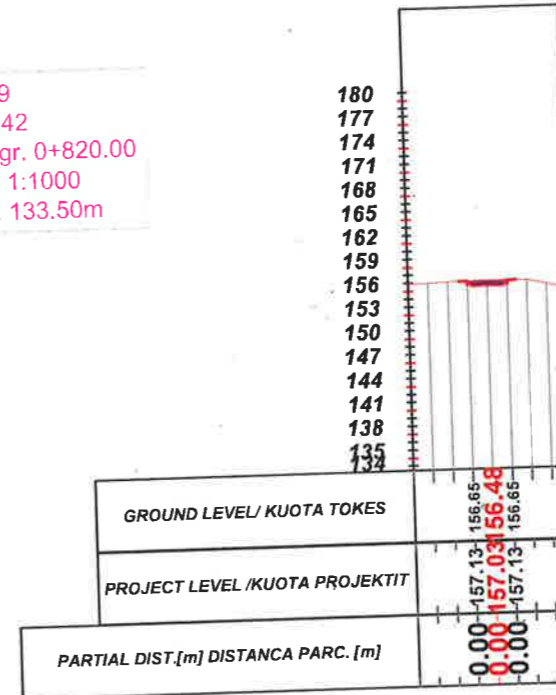

## LEGJENDA

- NIVELETA E RRUGES
- TERRENI NATYRAL



## BASHKIA KAMEZ

DREJTORIA E PROJEKTEVE DHE INVESTIMEVE  
DEPARTAMENTI I PROJEKTEVE

Dr. e Projekteve e Investimeve	RAMADAN HYSA	
Pergj. Sektori i Projekteve	DENIS PRENÇI	
STAFI TEKNIK PROJEKTES	Ing. EMANUELA MËZIU	
	Ing. ARTUR ÇAJKA	
	Ing. ALEKS DANI	
	Ark. ESTELA GJYRIQI	

Titulli i Projektit	NDERTIM RRUGËT "PASKUQAN 1 DHE 2"	Faza e Projektit PROJEKT ZBATIMI
Emeritimi i Fletes	PROFLET TËRTHORE	Data e Implementimit H 1:250
		Fleta Nr. 01 (57)

# PROFILE TËRTHORE AKSI 9

Aksi 9  
- Sez.43  
- Progr. 0+840.00  
Scala 1:1000  
Q.Rif. 133.50m

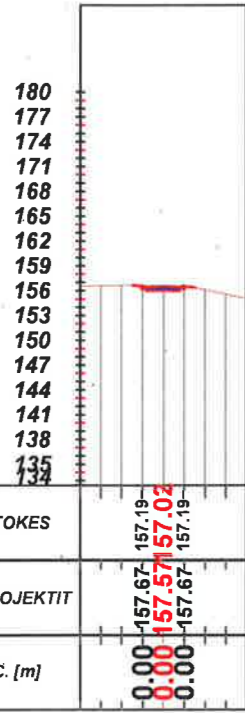

Aksi 9  
- Sez.45  
- Progr. 0+880.00  
Scala 1:1000  
Q.Rif. 133.50m

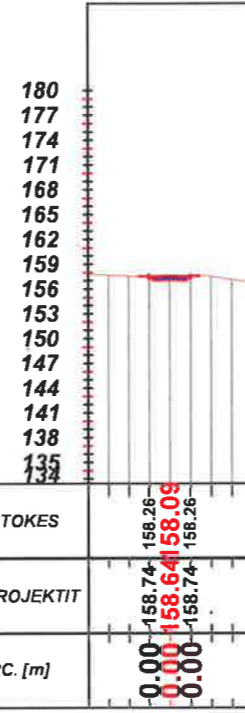

Aksi 9  
- Sez.47  
- Progr. 0+920.00  
Scala 1:1000  
Q.Rif. 136.50m

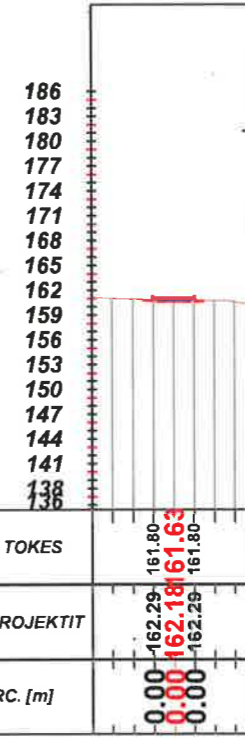

Aksi 9  
- Sez.44  
- Progr. 0+860.00  
Scala 1:1000  
Q.Rif. 133.50m

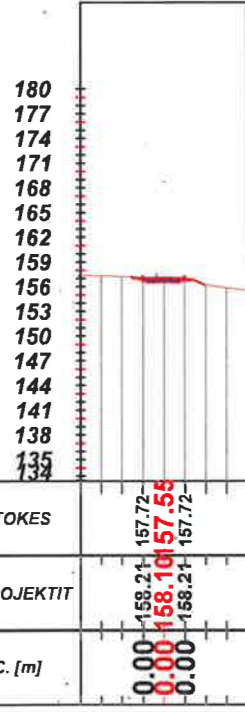

Aksi 9  
- Sez.46  
- Progr. 0+900.00  
Scala 1:1000  
Q.Rif. 136.50m

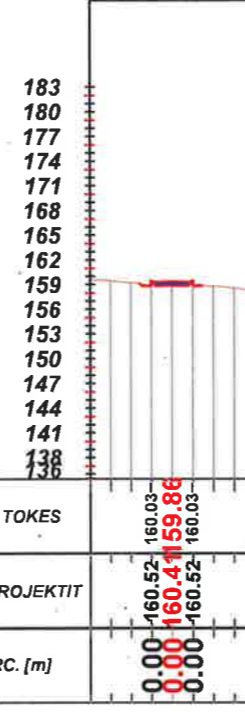

Aksi 9  
- Sez.48  
- Progr. 0+940.00  
Scala 1:1000  
Q.Rif. 139.50m

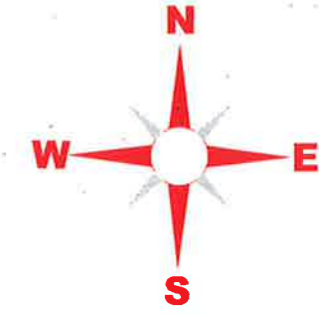
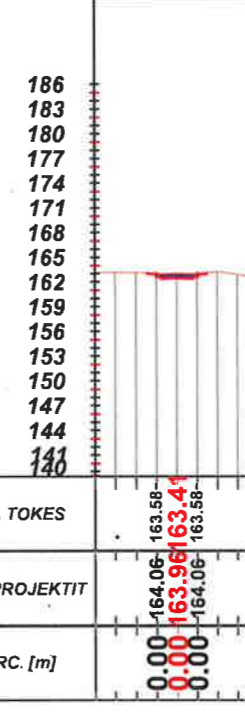

## LEGJENDA

- NIVELETA E RRUGES
- TERRENI NATYRAL



## BASHKIA KAMEZ

DREJTORIA E PROJEKTEVE DHE INVESTIMEVE  
DEPARTAMENTI I PROJEKTEVE

Dr. e Projekteve e Investimeve	RAMADAN HYSA	
Pergj. Sektori i Projekteve	DENIS PRENÇI	
STAFI TEKNIK PROJEKTES	Ing. EMANUELA MËZIU	
	Ing. ARTUR ÇAJKA	
	Ing. ALEKS DANI	
	Ark. ESTELA GJYRIQI	

Titulli i Projektit	Faza e Projektit
NDERTIM RRUGËT "PASKUQAN 1 DHE 2"	PROJEKT ZBATIMI
Emeritimi i Fletes	Data e Implementimit :
PROFILET TËRTHORE.	Shkalla e Vizatimit H 1:250
	Fleta Nr. 01 (58)

# PROFILE TËRTHORE AKSI 9

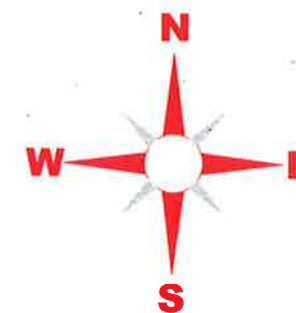

Aksi 9  
- Sez.49  
- Progr. 0+960.00  
Scala 1:1000  
Q.Rif. 142.50m

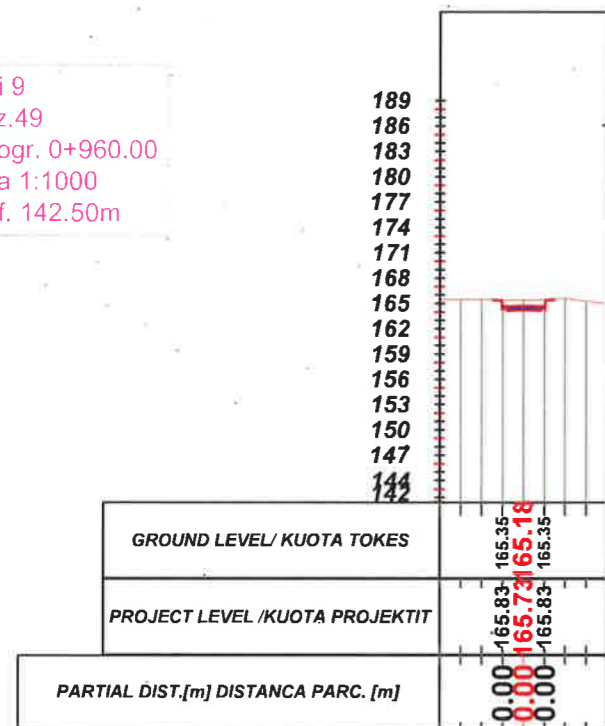

Aksi 9  
- Sez.51  
- Progr. 1+000.00  
Scala 1:1000  
Q.Rif. 145.50m

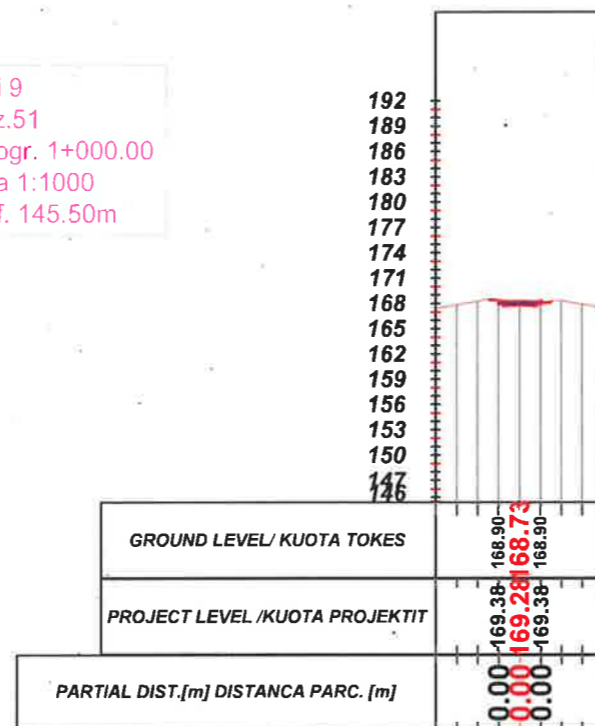

Aksi 9  
- Sez.53  
- Progr. 1+040.00  
Scala 1:1000  
Q.Rif. 142.50m

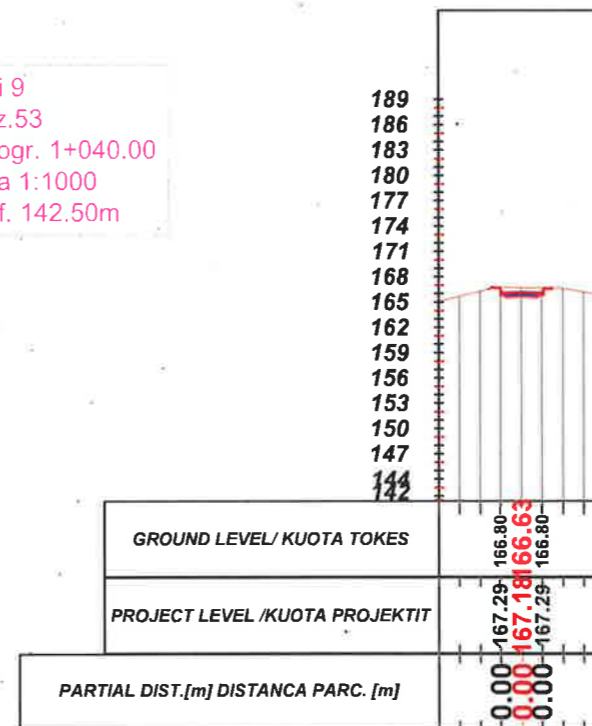

Aksi 9  
- Sez.50  
- Progr. 0+980.00  
Scala 1:1000  
Q.Rif. 142.50m

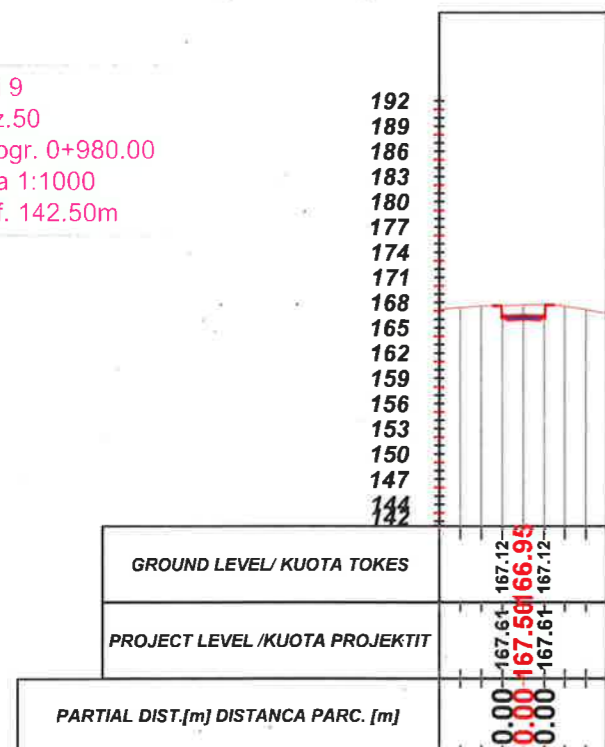

Aksi 9  
- Sez.52  
- Progr. 1+020.00  
Scala 1:1000  
Q.Rif. 142.50m

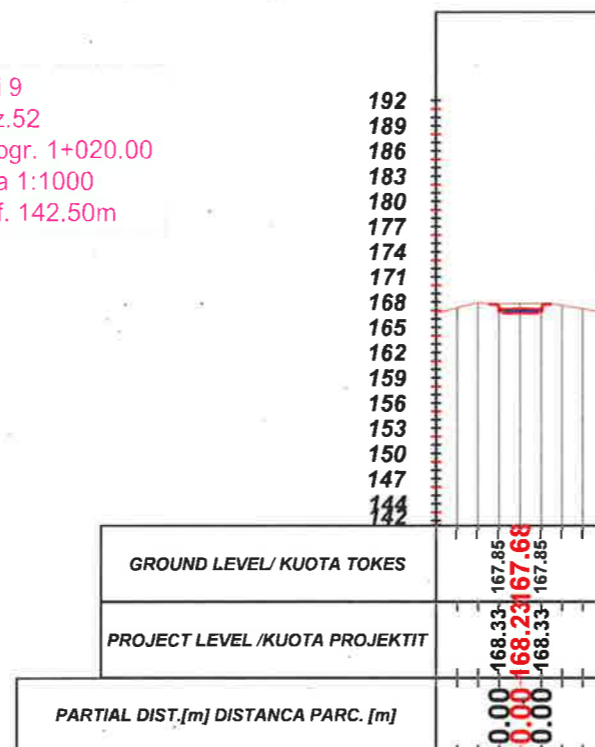

Aksi 9  
- Sez.54  
- Progr. 1+060.00  
Scala 1:1000  
Q.Rif. 142.50m

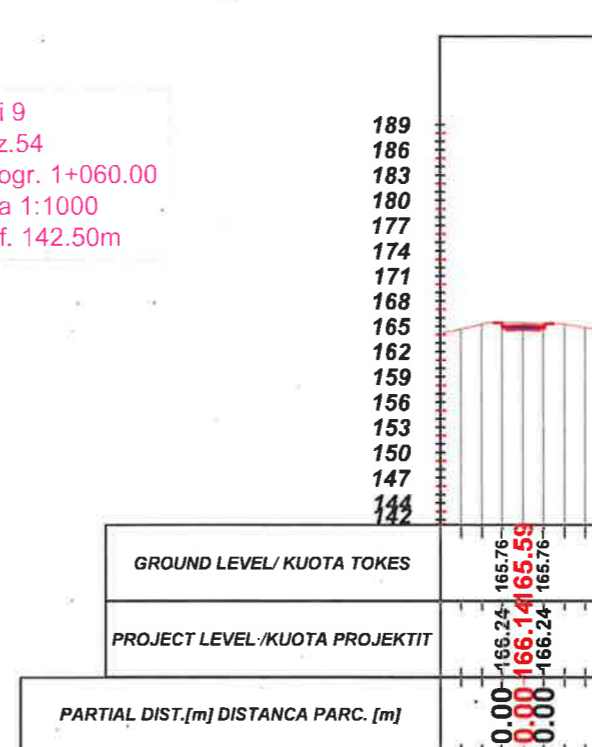

## LEGJENDA

- NIVELETA E RRUGES
- TERRENI NATYRAL



## BASHKIA KAMEZ

DREJTORIA E PROJEKTEVE DHE INVESTIMEVEVE  
DEPARTAMENTI I PROJEKTEVE

Dr. e Projekteve e Investimeve	RAMADAN HYSA	
Pergj. Sektorit i Projekteve	DENIS PRENÇI	
STAFI TEKNIK	Ing. EMANUELA MËZIU	
PROJEKTUES	Ing. ARTUR ÇAJKA	
	Ing. ALEKS DANI	
	Ark. ESTELA GJYRIQI	

Titulli i Projektit	NDERTIM RRUGËT "PASKUQAN 1 DHE 2"	Faza e Projektit	PROJEKT ZBATIMI
Emeritimi i Fletes	PROFILET TËRTHORE	Data e Implementimit	
		Shkalla e Vizatimit	H 1:250
		Fleta Nr.	01 (59)

# PROFILE TËRTHORE AKSI 9

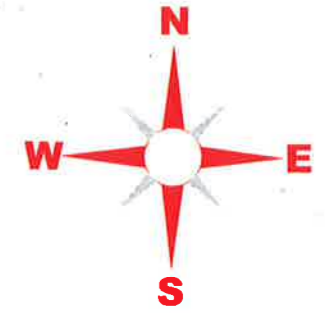

Aksi 9  
- Sez.55  
- Progr. 1+080.00  
Scala 1:1000  
Q.Rif. 139.50m

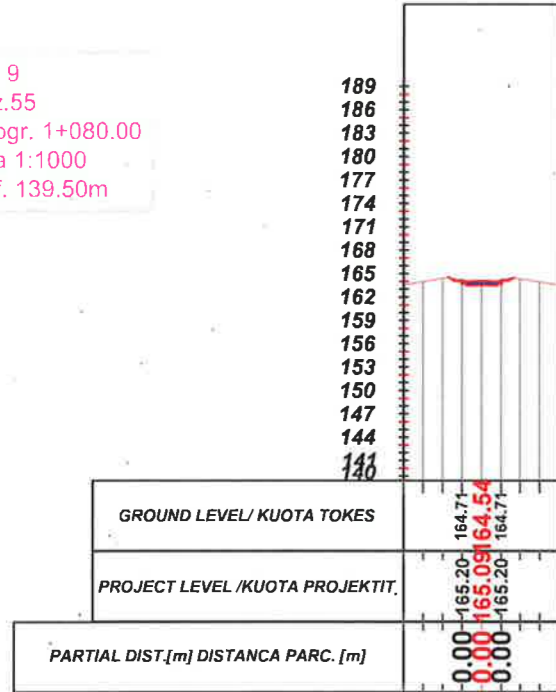

Aksi 9  
- Sez.57  
- Progr. 1+120.00  
Scala 1:1000  
Q.Rif. 139.50m

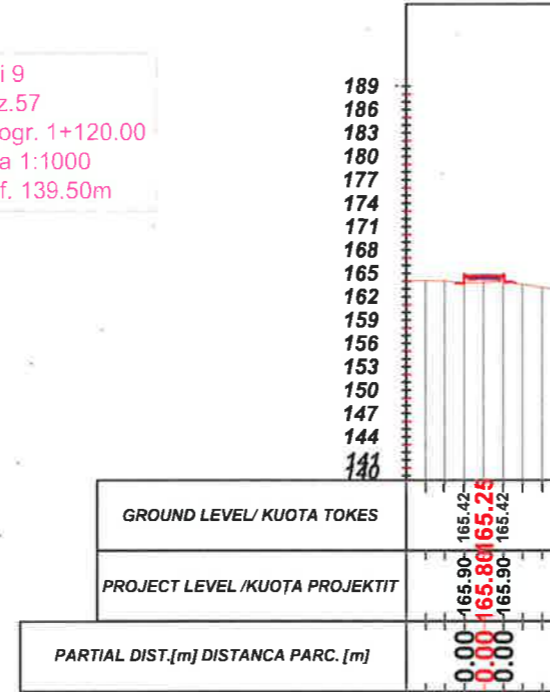

Aksi 9  
- Sez.59  
- Progr. 1+160.00  
Scala 1:1000  
Q.Rif. 142.50m

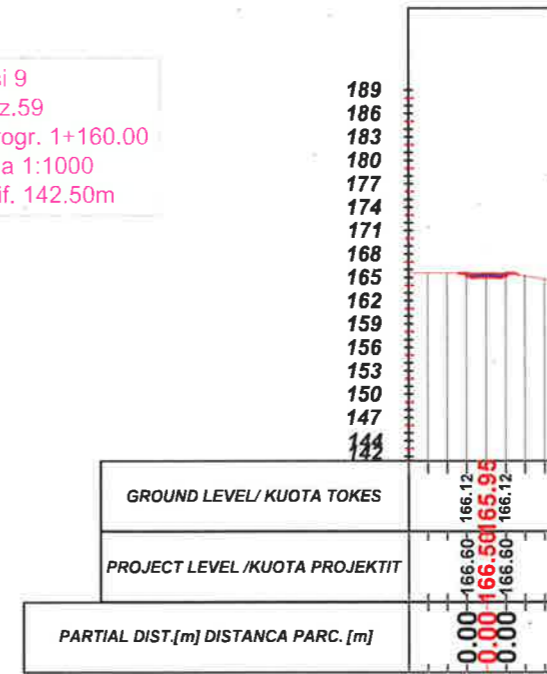

Aksi 9  
- Sez.56  
- Progr. 1+100.00  
Scala 1:1000  
Q.Rif. 139.50m

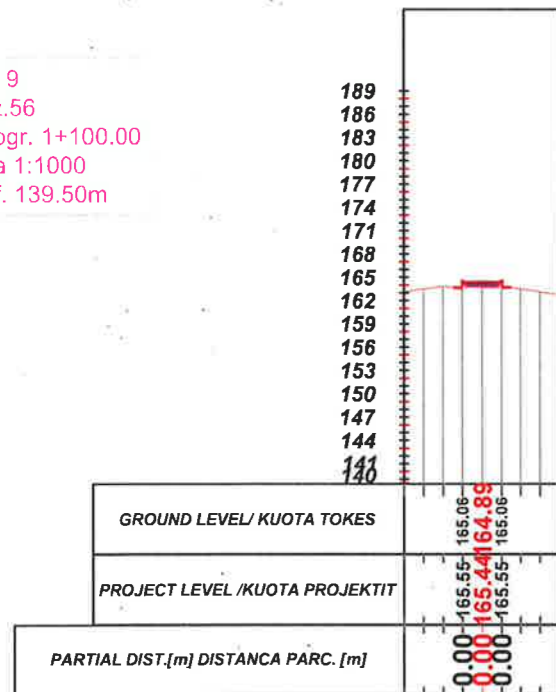

Aksi 9  
- Sez.58  
- Progr. 1+140.00  
Scala 1:1000  
Q.Rif. 139.50m

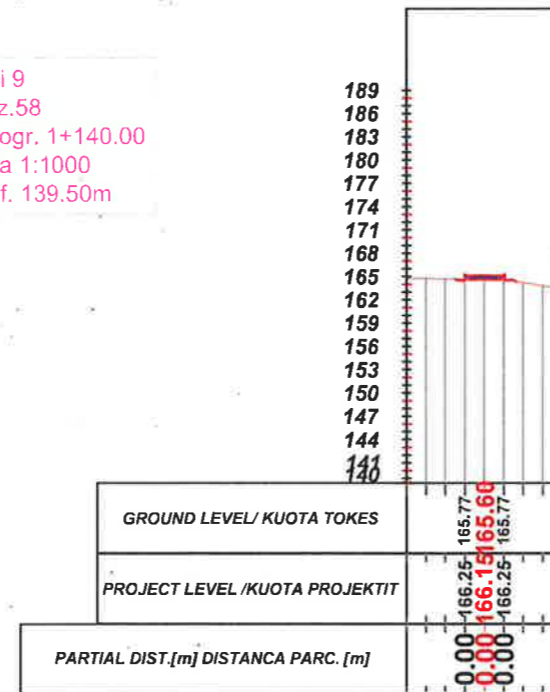

Aksi 9  
- Sez.60  
- Progr. 1+180.00  
Scala 1:1000  
Q.Rif. 142.50m

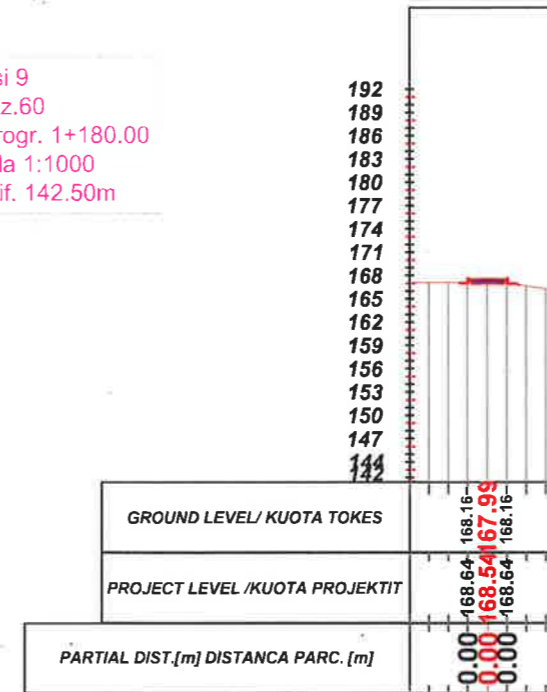

## LEGJENDA

- NIVELETA E RRUGES
- TERRENI NATYRAL



## BASHKIA KAMEZ

DREJTORIA E PROJEKTEVE DHE INVESTIMEVE  
DEPARTAMENTI I PROJEKTEVE

Dr. e Projekteve e Investimeve	RAMADAN HYSA	
Pergj. Sektori i Projekteve	DENIS PRENÇI	
STAFI TEKNIK	Ing. EMANUELA MËZIU	
PROJEKTUES	Ing. ARTUR ÇAJKA	
	Ing. ALEKS DANI	
	Ark. ESTELA GJYRIQI	

Titulli i Projektit	Faza e Projektit
NDERTIM RRUGËT "PASKUQAN 1 DHE 2"	PROJEKT ZBATIMI
Emertimi i Fletes	Data e Implementimit :
PROFILET TËRTHORE	Shkalla e Vizatimit
	H 1:250
	Fleta Nr.
	01 (60)

# PROFILE TËRTHORE AKSI 9

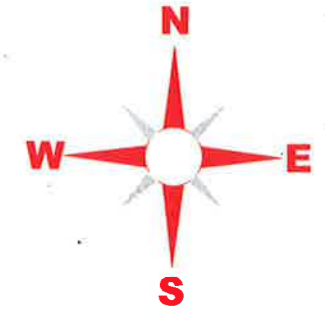

Aksi 9  
- Sez.61  
- Progr. 1+200.00  
Scala 1:1000  
Q.Rif. 145.50m

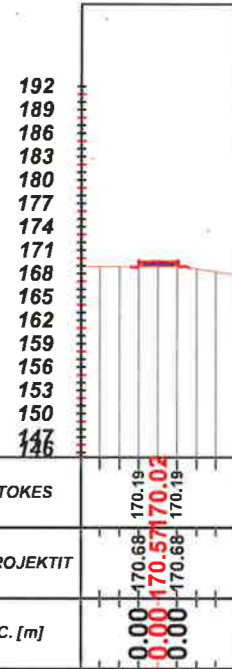

Aksi 9  
- Sez.63  
- Progr. 1+240.00  
Scala 1:1000  
Q.Rif. 148.50m

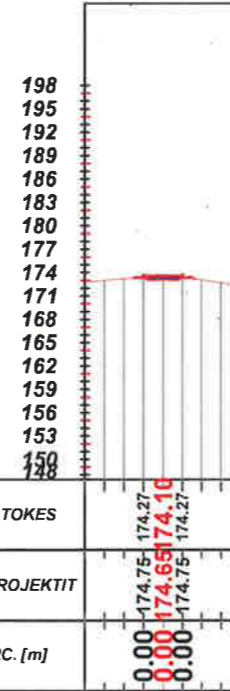

Aksi 9  
- Sez.65  
- Progr. 1+280.00  
Scala 1:1000  
Q.Rif. 154.50m

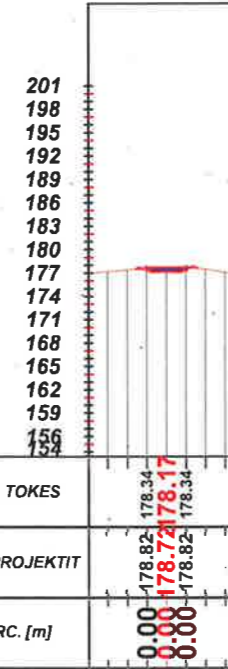

Aksi 9  
- Sez.62  
- Progr. 1+220.00  
Scala 1:1000  
Q.Rif. 145.50m

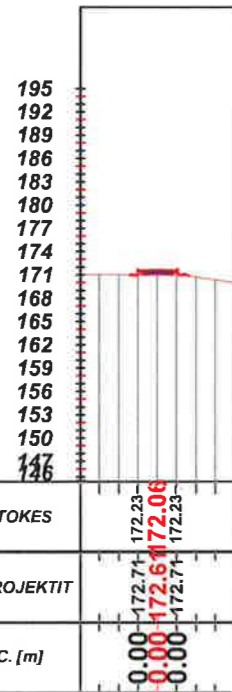

Aksi 9  
- Sez.64  
- Progr. 1+260.00  
Scala 1:1000  
Q.Rif. 151.50m

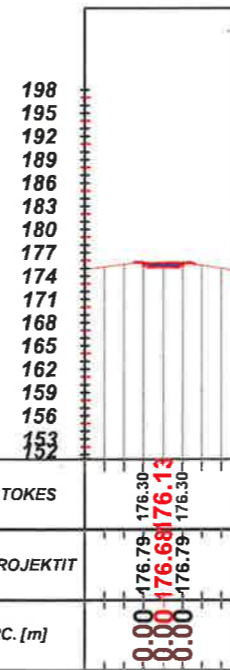

Aksi 9  
- Sez.66  
- Progr. 1+300.00  
Scala 1:1000  
Q.Rif. 154.50m

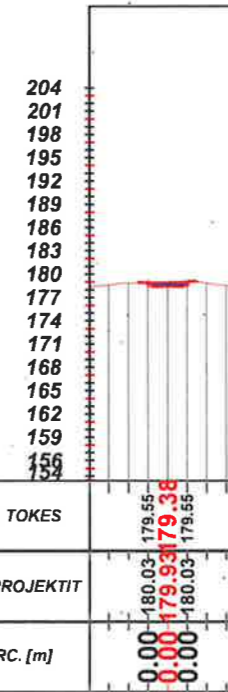

## LEGJENDA

- NIVELETA E RRUGES
- TERRENI NATYRAL



## BASHKIA KAMEZ

DREJTORIA E PROJEKTEVE DHE INVESTIMEVE  
DEPARTAMENTI I PROJEKTEVE

Dr. e Projekteve e Investimeve	RAMADAN HYSA	
Pergj. Sektori i Projekteve	DENIS PRENÇI	
STAFI TEKNIK PROJEKTES	Ing. EMANUELA MËZIU	
	Ing. ARTUR ÇAJKA	
	Ing. ALEKS DANI	
	Ark. ESTELA GJYRIQI	

Titulli i Projektit	Faza e Projektit
NDERTIM RRUGËT "PASKUQAN 1 DHE 2"	PROJEKT ZBATIMI
Emertimi i Fietes	Data e Implementimit :
PROFILET TËRTHORE	Shkalla e Vizatimit
	H 1:250
	Fleta Nr.
	01 (61)

# PROFILE TËRTHORE AKSI 9

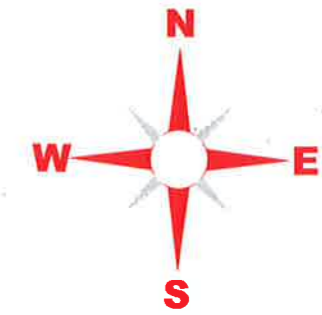

Aksi 9  
- Sez.67  
- Progr. 1+320.00  
Scala 1:1000  
Q.Rif. 157.50m

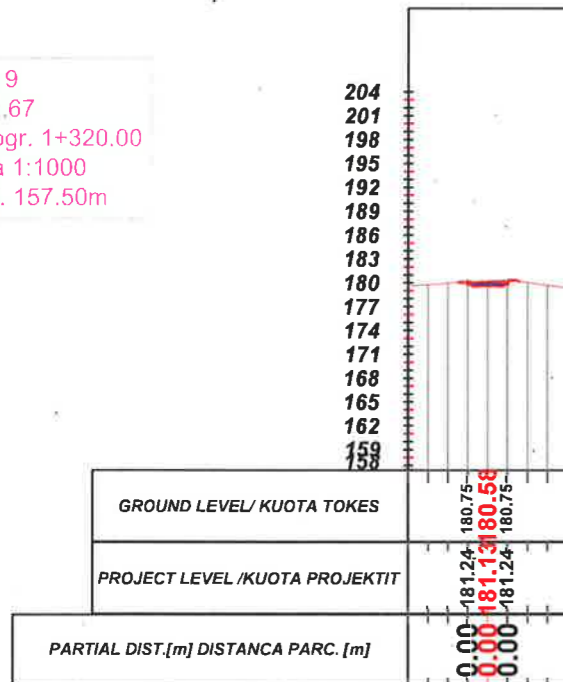

Aksi 9  
- Sez.69  
- Progr. 1+360.00  
Scala 1:1000  
Q.Rif. 157.50m

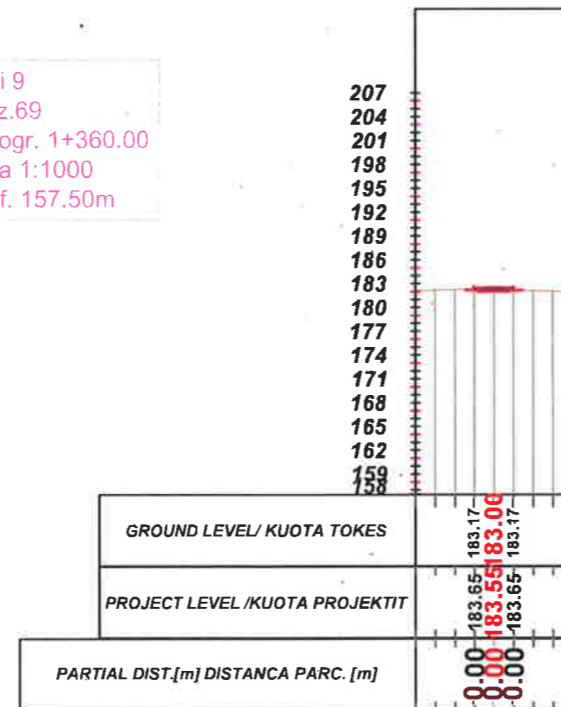

Aksi 9  
- Sez.71  
- Progr. 1+400.00  
Scala 1:1000  
Q.Rif. 160.50m

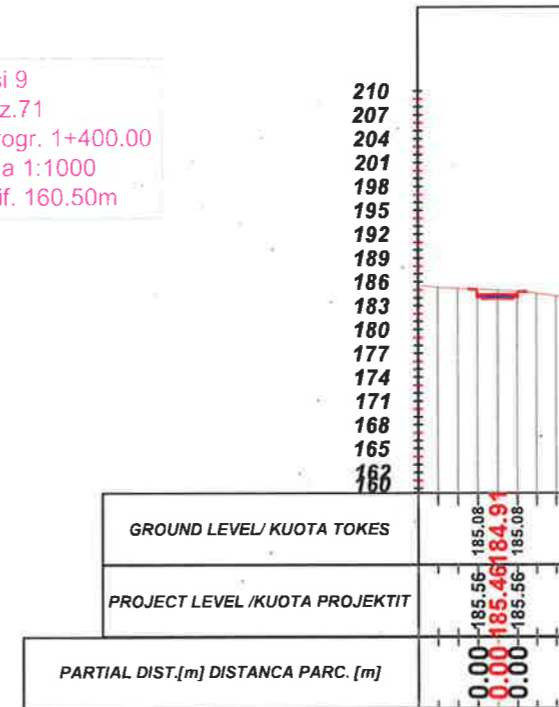

Aksi 9  
- Sez.68  
- Progr. 1+340.00  
Scala 1:1000  
Q.Rif. 157.50m

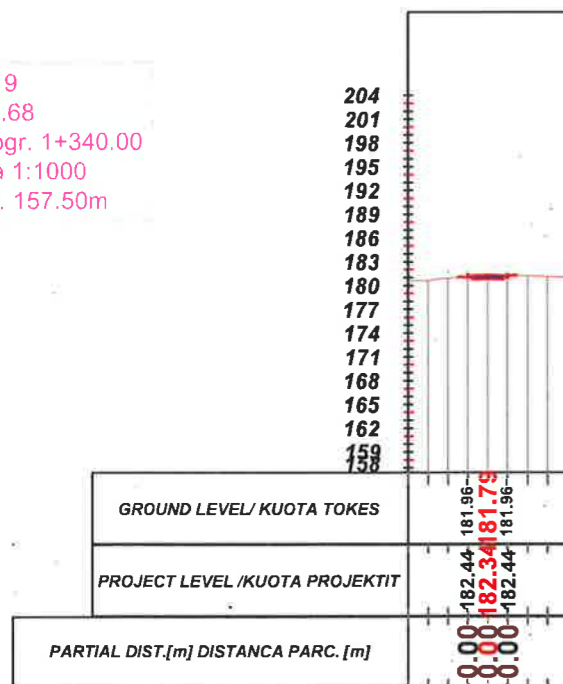

Aksi 9  
- Sez.70  
- Progr. 1+380.00  
Scala 1:1000  
Q.Rif. 160.50m

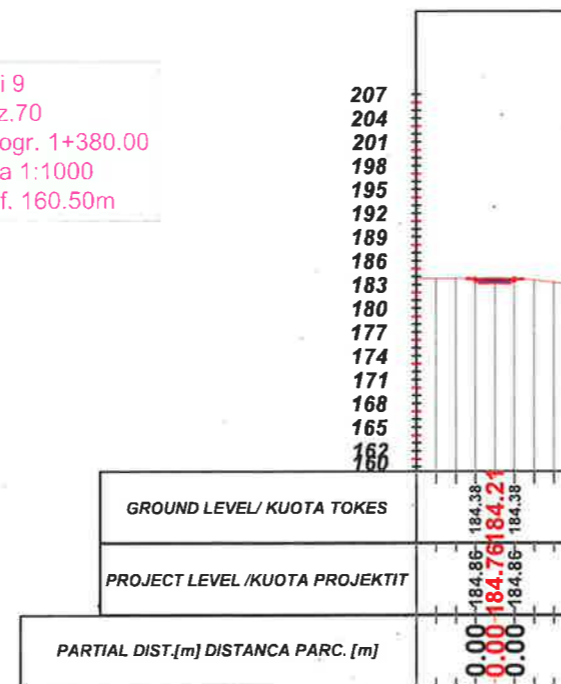

Aksi 9  
- Sez.72  
- Progr. 1+420.00  
Scala 1:1000  
Q.Rif. 160.50m

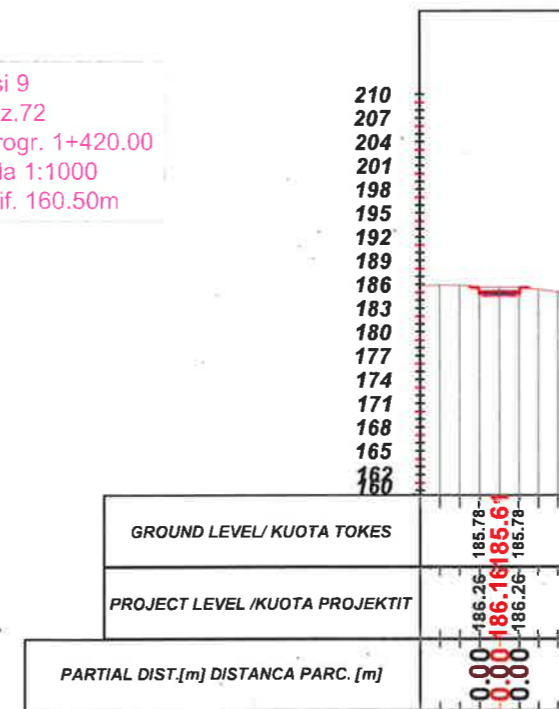

## LEGJENDA

- NIVELETA E RRUGES
- TERRENI NATYRAL



## BASHKIA KAMEZ

DREJTORIA E PROJEKTEVE DHE INVESTIMEVE  
DEPARTAMENTI I PROJEKTEVE

Dr. e Projekteve e Investimeve	RAMADAN HYSA	<i>[Signature]</i>
Pergj. Sektori i Projekteve	DENIS PRENÇI	<i>[Signature]</i>
STAFI TEKNIK	Ing. EMANUELA MËZIU	<i>[Signature]</i>
PROJEKTUES	Ing. ARTUR ÇAJKA	<i>[Signature]</i>
	Ing. ALEKS DANI	<i>[Signature]</i>
Ark.	ESTELA GJYRIQI	<i>[Signature]</i>

Titulli i Projektit	Faza e Projektit
NDERTIM RRUGËT "PASKUQAN 1 DHE 2"	PROJEKT ZBATIMI
Emertimi i Fletes	Data e Implementimit
PROFILET TËRTHORE	H 1:250
	Fleta Nr.
	01 (62)

# PROFILE TËRTHORE AKSI 9

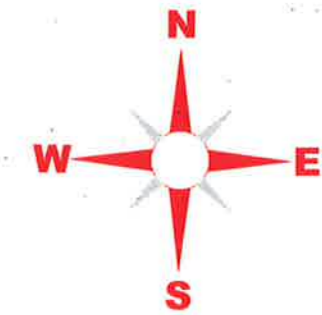

Aksi 9  
- Sez.73  
- Progr. 1+440.00  
Scala 1:1000  
Q.Rif. 163.50m

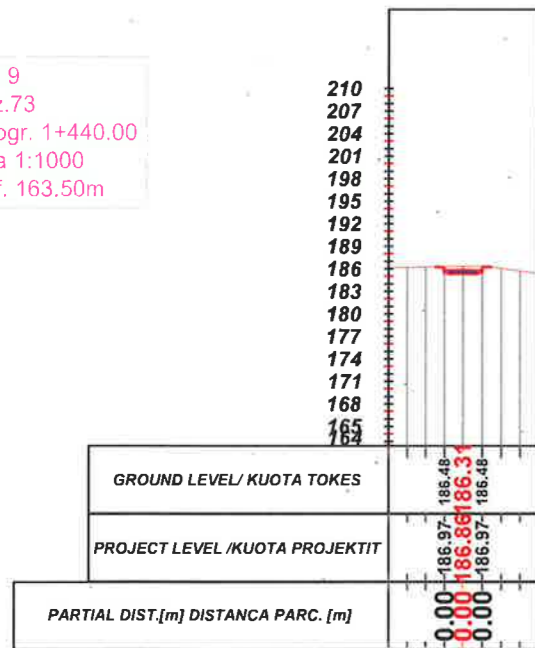

Aksi 9  
- Sez.75  
- Progr. 1+480.00  
Scala 1:1000  
Q.Rif. 163.50m

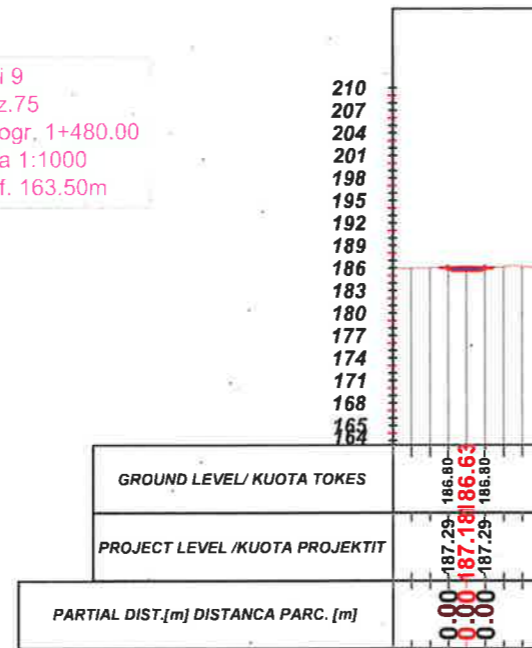

Aksi 9  
- Sez.77  
- Progr. 1+520.00  
Scala 1:1000  
Q.Rif. 160,50m

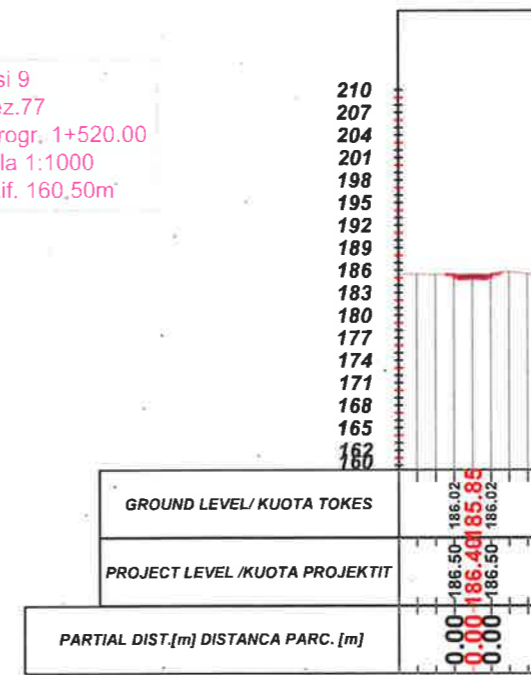

Aksi 9  
- Sez.74  
- Progr. 1+460.00  
Scala 1:1000  
Q.Rif. 163.50m

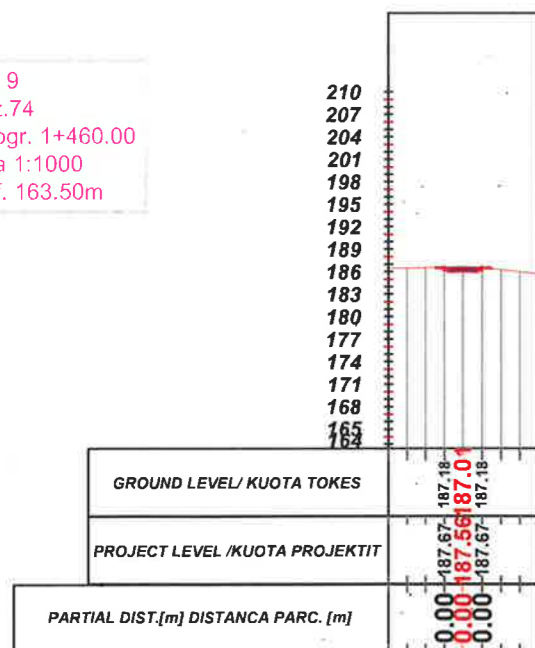

Aksi 9  
- Sez.76  
- Progr. 1+500.00  
Scala 1:1000  
Q.Rif. 163.50m

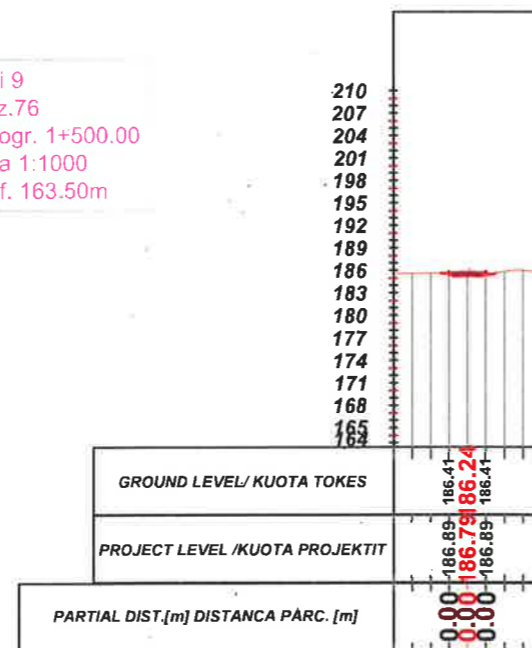

Aksi 9  
- Sez.78  
- Progr. 1+540.00  
Scala 1:1000  
Q.Rif. 160,50m

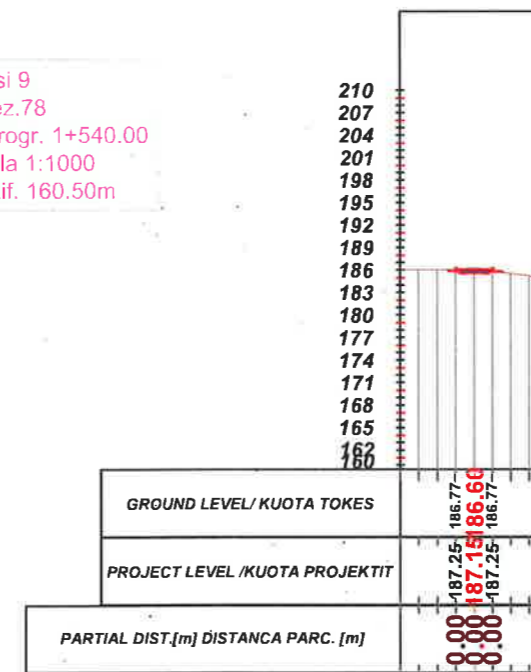

## LEGJENDA

- NIVELETA E RRUGES
- TERRENI NATYRAL



## BASHKIA KAMEZ

DREJTORIA E PROJEKTEVE DHE INVESTIMEVE  
DEPARTAMENTI I PROJEKTEVE

Dr. e Projekteve e Investimeve	RAMADAN HYSA	
Pergj. Sektori i Projekteve	DENIS PRENÇI	
STAFI TEKNIK PROJEKTUES	Ing. EMANUELA MËZIU	
	Ing. ARTUR ÇAJKA	
	Ing. ALEKS DANI	
Ark.	ESTELA GJYRIQI	

Titulli i Projektit	Faza e Projektit
NDERTIM RRUGËT "PASKUQAN I DHE 2"	PROJEKT ZBATIMI
Emertimi i Fletes	Data e Implementimit :
PROFILET TËRTHORE	Shkalla e Vizimit H 1:250
	Fleta Nr. 01 (63)

# PROFILE TËRTHORE AKSI 9

Aksi 9  
 - Sez.79  
 - Progr. 1+560.00  
 Scala 1:1000  
 Q.Rif. 163.50m

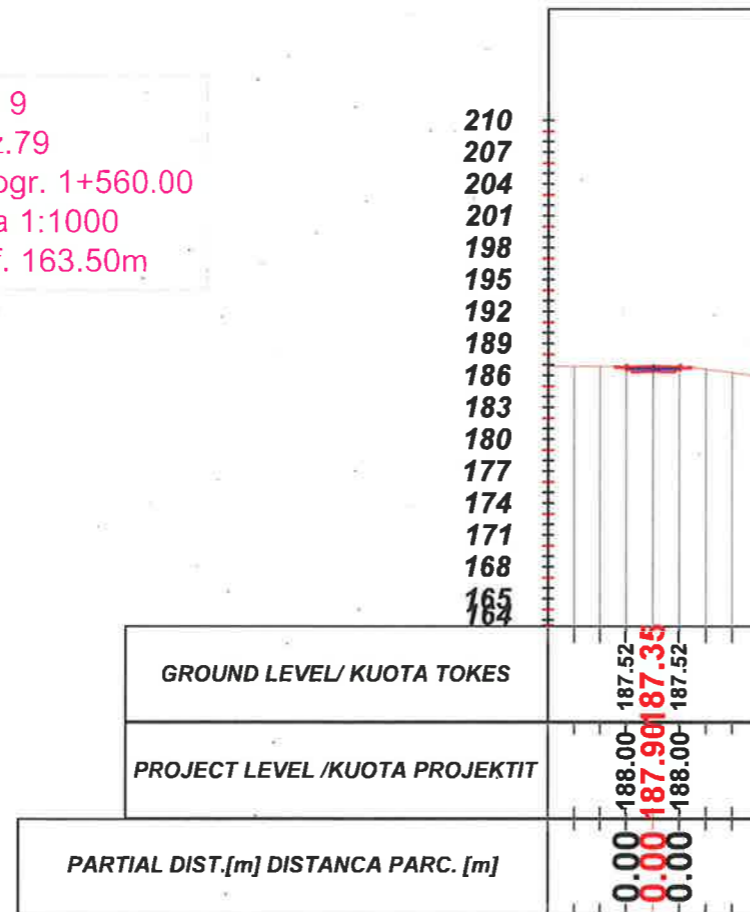

Aksi 9  
 - Sez.80  
 - Progr. 1+576.47  
 Scala 1:1000  
 Q.Rif. 163.50m

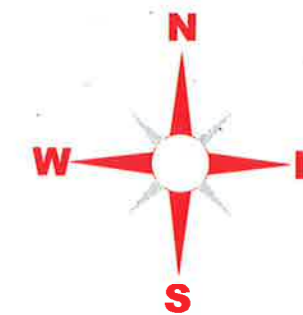
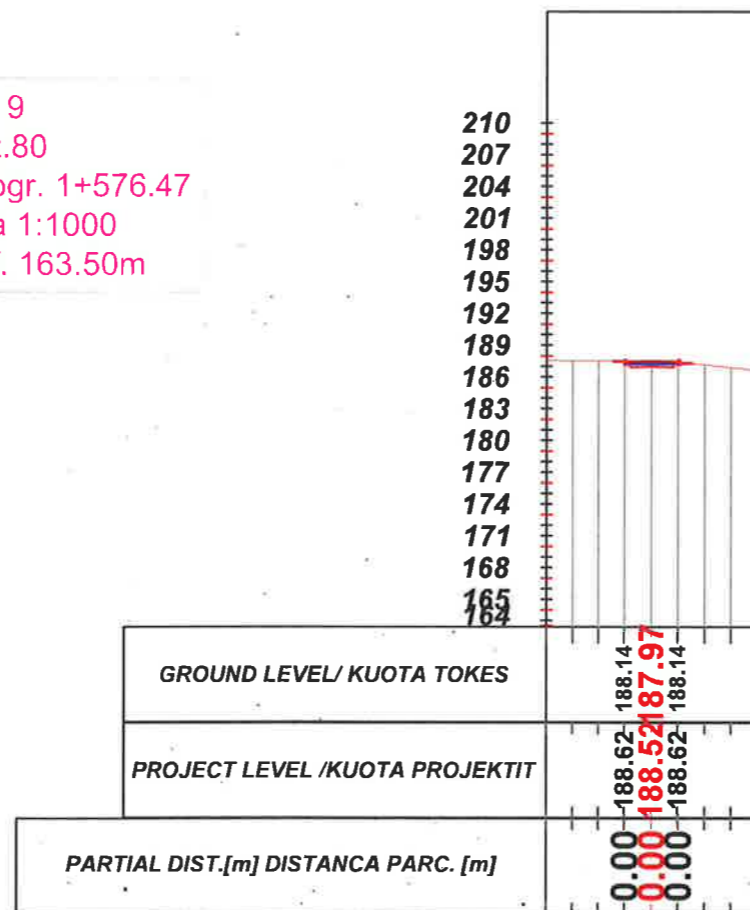

## LEGJENDA

- NIVELETA E RRUGES
- TERRENI NATYRAL



## BASHKIA KAMEZ

DREJTORIA E PROJEKTEVE DHE INVESTIMEVE  
 DEPARTAMENTI I PROJEKTEVE

Dr. e Projekteve e Investimeve	RAMADAN HYSA	<i>[Signature]</i>
Pergj. Sektori i Projekteve	DENIS PRENÇI	<i>[Signature]</i>
STAFI TEKNIK PROJEKTUES	Ing. EMANUELA MËZIU	<i>[Signature]</i>
	Ing. ARTUR ÇAJKA	<i>[Signature]</i>
	Ing. ALEKS DANI	<i>[Signature]</i>
	Ark. ESTELA GJYRIQI	<i>[Signature]</i>
Titulli i Projektit	NDERTIM RRUGËT "PASKUQAN 1 DHE 2"	
Faza e Projektit	PROJEKT ZBATIMI	
Emertimi i Fletes	PROFILET TËRTHORE	
Data e Implementimit:		
Shkalla e Vizatimit	H 1:250	
Fleta Nr.	01 (64)	

# PROFILE TËRTHORE AKSI 10

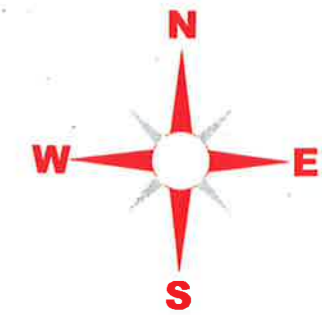

Aksi 10  
- Sez.1  
- Progr. 0+000.00  
Scala 1:1000  
Q.Rif. 133.50m

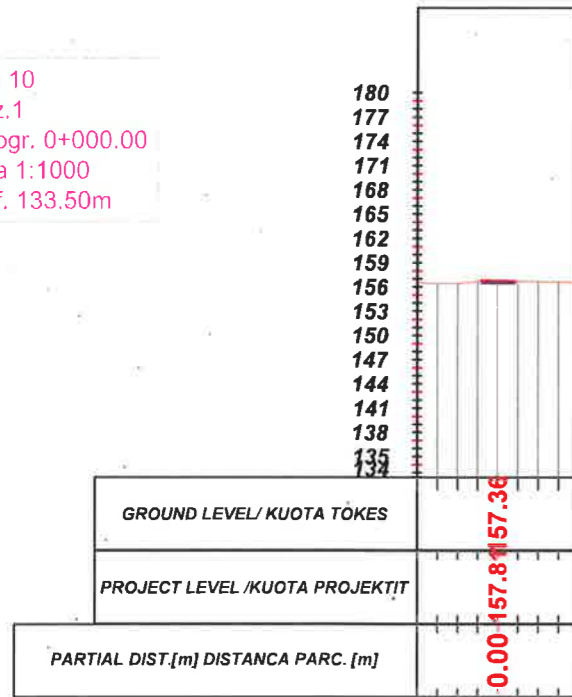

Aksi 10  
- Sez.3  
- Progr. 0+040.00  
Scala 1:1000  
Q.Rif. 124.50m

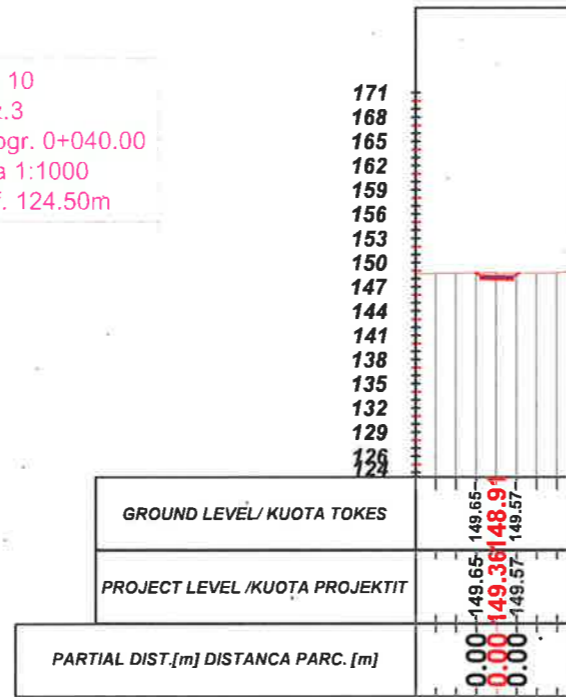

Aksi 10  
- Sez.5  
- Progr. 0+080.00  
Scala 1:1000  
Q.Rif. 118.50m

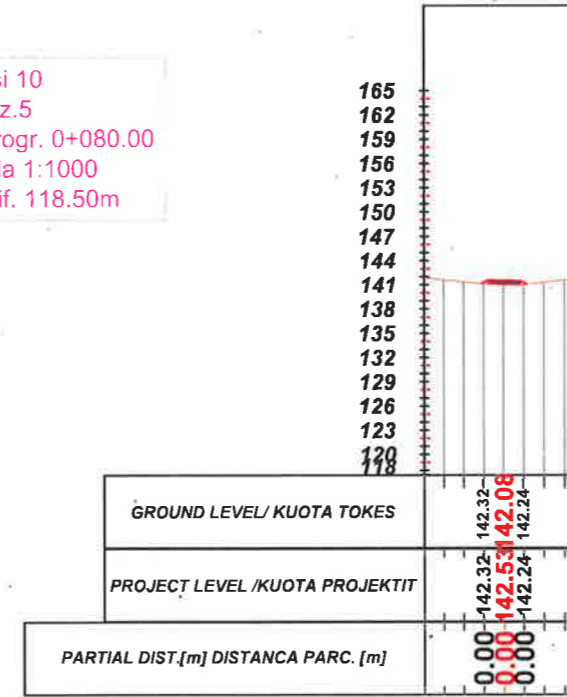

Aksi 10  
- Sez.2  
- Progr. 0+020.00  
Scala 1:1000  
Q.Rif. 130.50m

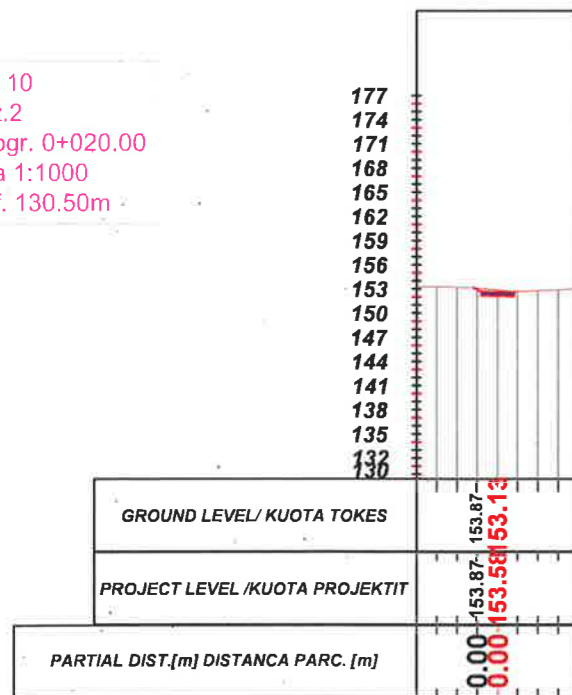

Aksi 10  
- Sez.4  
- Progr. 0+060.00  
Scala 1:1000  
Q.Rif. 121.50m

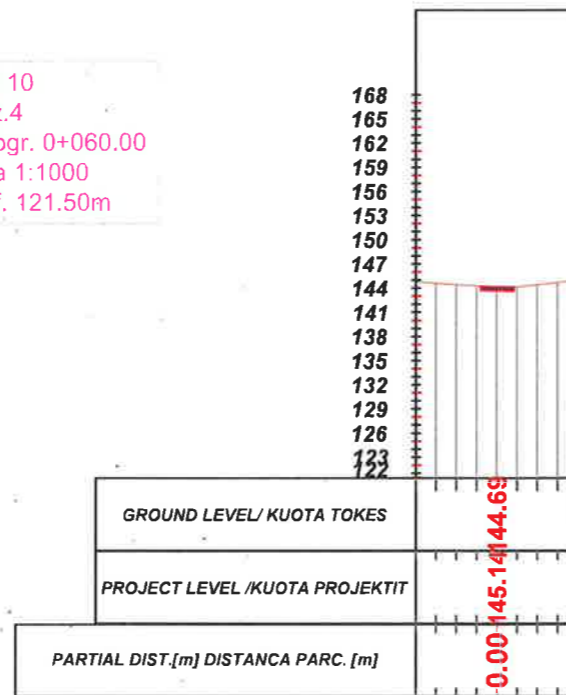

Aksi 10  
- Sez.6  
- Progr. 0+100.00  
Scala 1:1000  
Q.Rif. 115.50m

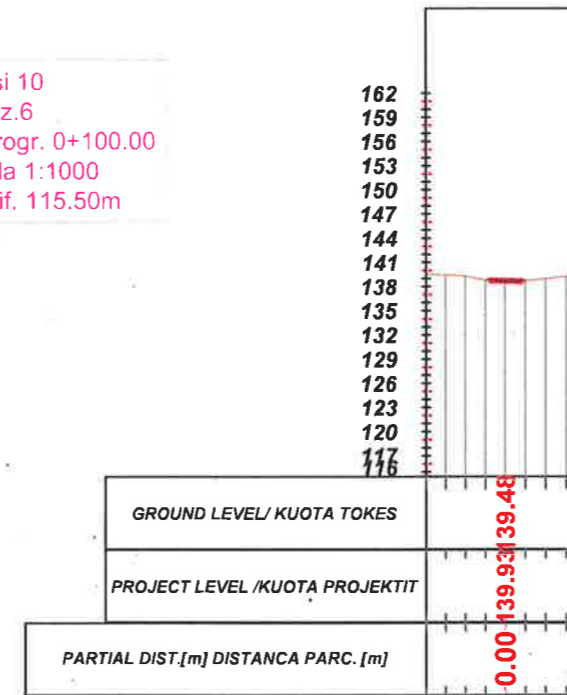

## LEGJENDA

- NIVELETA E RRUGES
- TERRENI NATYRAL



## BASHKIA KAMEZ

DREJTORIA E PROJEKTEVE DHE INVESTIMEVE  
DEPARTAMENTI I PROJEKTEVE

Dr. e Projekteve e Investimeve	RAMADAN HYSA	
Pergj. Sektori i Projekteve	DENIS PRENÇI	
STAFI TEKNIK PROJEKTES	Ing. EMANUELA MËZIU	
	Ing. ARTUR ÇAJKA	
	Ing. ALEKS DANI	
	Ark. ESTELA GJYRIQI	

Titulli i Projektit	Faza e Projektit
NDERTIM RRUGËT "PASKUQAN I DHE 2"	PROJEKT ZBATIMI
Emertimi i Fletes	Data e Implementimit :
PROFLET TËRTHORE	Shkalla e Vizatimit
	H 1:250
	Fleta Nr.
	01 (65)

PROFILE TËRTHORE AKSI 10

Aksi 10  
 - Sez.7  
 - Progr. 0+104.89  
 Scala 1:1000  
 Q.Rif. 115.50m

162  
 159  
 156  
 153  
 150  
 147  
 144  
 141  
 138  
 135  
 132  
 129  
 126  
 123  
 120  
 117  
 116

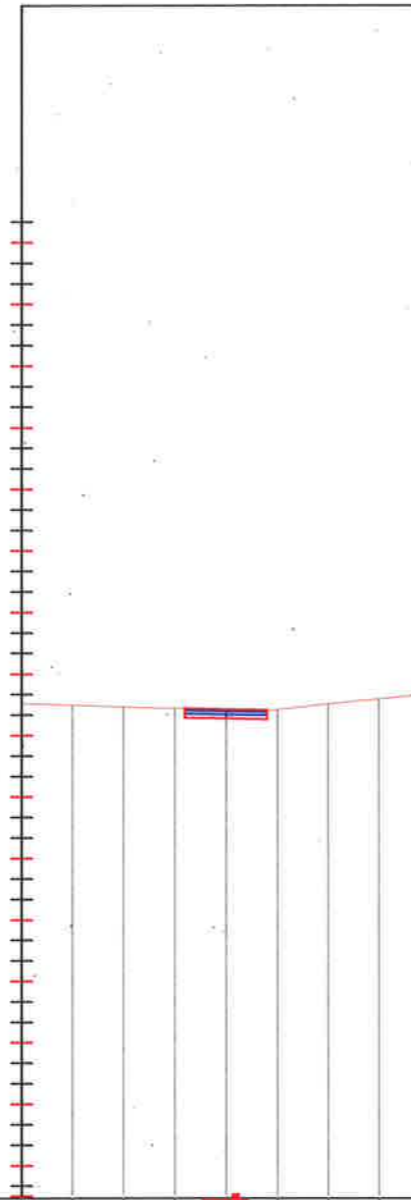

GROUND LEVEL/ KUOTA TOKES

PROJECT LEVEL /KUOTA PROJEKTIT

PARTIAL DIST.[m] DISTANCA PARC. [m]

0.00 139.29 138.84

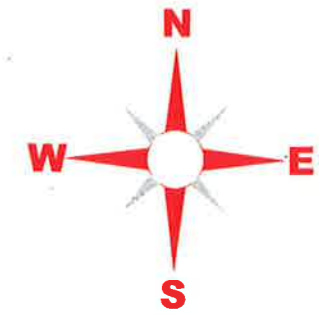

LEGJENDA

- NIVELETA E RRUGES
- TERRENI NATYRAL



BASHKIA KAMEZ

DREJTORIA E PROJEKTEVE DHE INVESTIMEVE  
 DEPARTAMENTI I PROJEKTEVE

Dr. e Projekteve e Investimeve	RAMADAN HYSA	
Pergj. Sektori i Projekteve	DENIS PRENÇI	
STAFI TEKNIK PROJEKTUES	Ing. EMANUELA MËZIU	
	Ing. ARTUR ÇAJKA	
	Ing. ALEKS DANI	
	Ark. ESTELA GJYRIQI	

Titulli i Projektit	Faza e Projektit
NDERTIM RRUGËT "PASKUQAN 1 DHE 2"	PROJEKT ZBATIMI
Emertimi i Fletes	Data e Implementimit :
PROFILET TËRTHORE	Shkalla e Vizatimit H 1:250
	Fleta Nr. 01 (66)

# PROFILE TËRTHORE AKSI 11

Aksi 11  
- Sez.1  
- Progr. 0+000.00  
Scala 1:1000  
Q.Rif. 130.50m

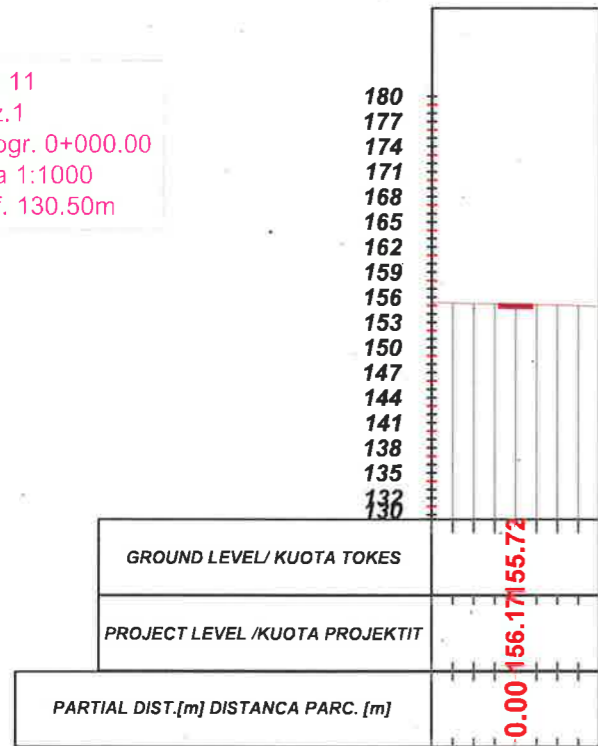

Aksi 11  
- Sez.3  
- Progr. 0+040.00  
Scala 1:1000  
Q.Rif. 127.50m

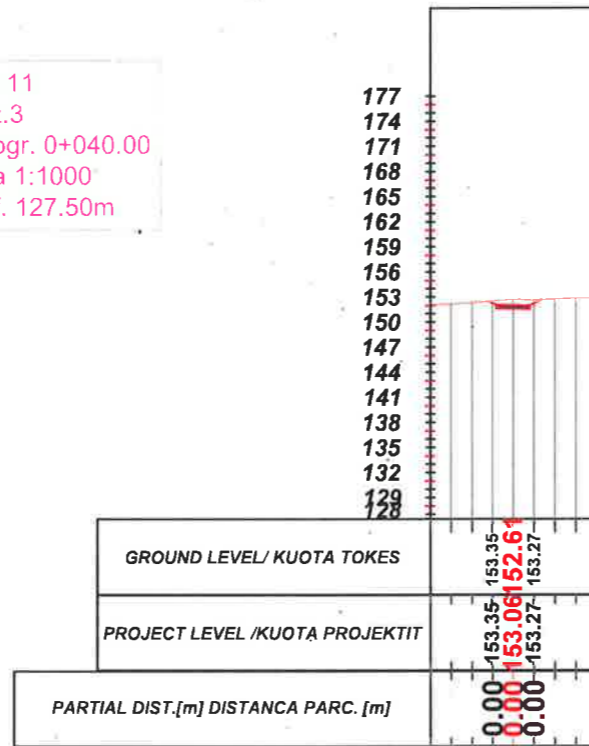

Aksi 11  
- Sez.5  
- Progr. 0+080.00  
Scala 1:1000  
Q.Rif. 121.50m

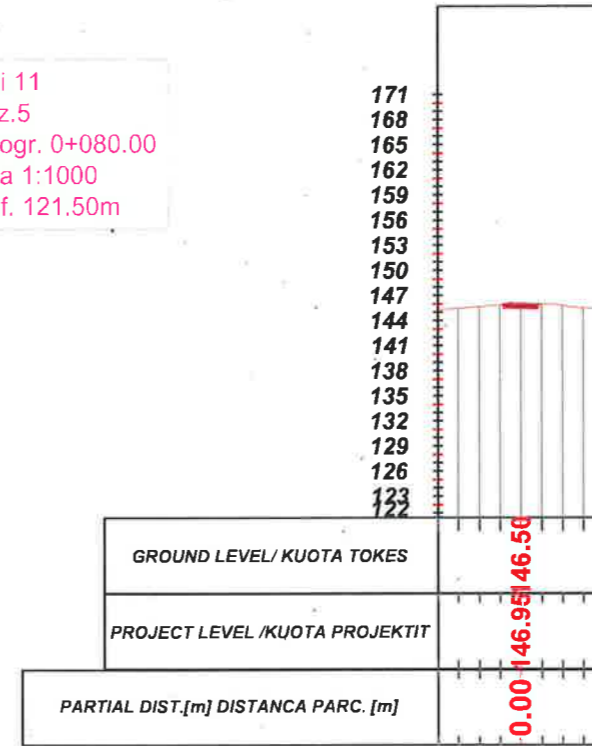

Aksi 11  
- Sez.2  
- Progr. 0+020.00  
Scala 1:1000  
Q.Rif. 130.50m

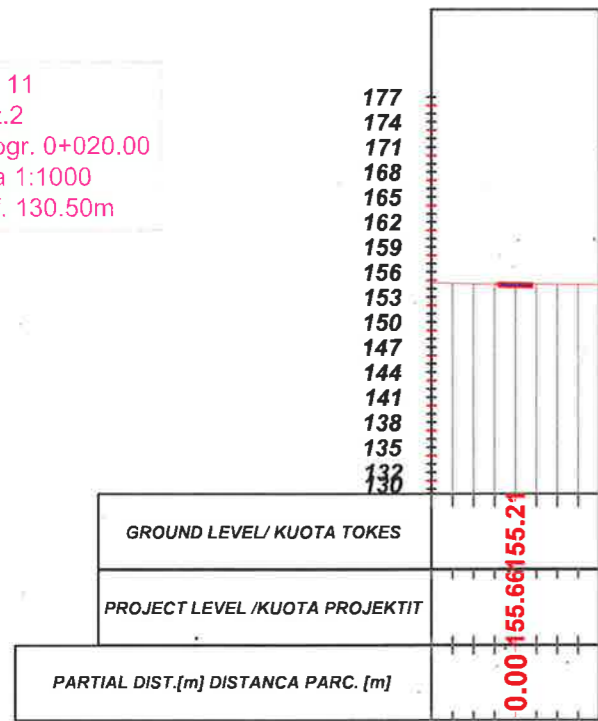

Aksi 11  
- Sez.4  
- Progr. 0+060.00  
Scala 1:1000  
Q.Rif. 124.50m

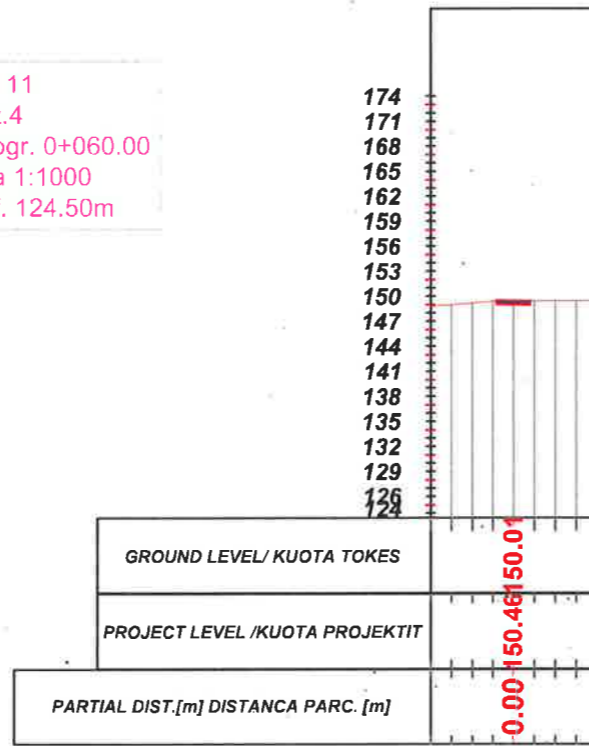

Aksi 11  
- Sez.6  
- Progr. 0+081.77  
Scala 1:1000  
Q.Rif. 121.50m

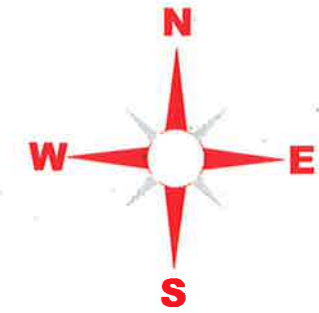
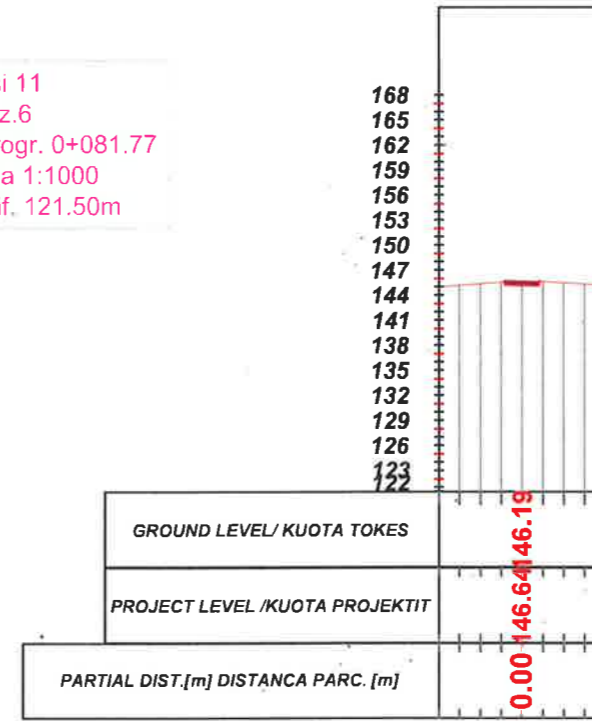

## LEGJENDA

- NIVELETA E RRUGES
- TERRENI NATYRAL



## BASHKIA KAMEZ

DREJTORIA E PROJEKTEVE DHE INVESTIMEVE  
DEPARTAMENTI I PROJEKTEVE

Dr. e Projekteve e Investimeve	RAMADAN HYSA	
Pergj. Sektori i Projekteve	DENIS PRENÇI	
STAFI TEKNIK PROJEKTES	Ing. EMANUELA MËZIU	
	Ing. ARTUR ÇAJKA	
	Ing. ALEKS DANI	
	Ark. ESTELA GJYRIQI	

Titulli i Projektit	Faza e Projektit
NDERTIM RRUGËT "PASKUQAN 1 DHE 2"	PROJEKT ZBATIMI
Emertimi i Fletes	Data e implementimit :
PROFILET TËRTHORE	Shkalla e Vizatimit
	H 1:250
	Fleta Nr.
	01 (67)

# PROFILE TËRTHORE AKSI 12

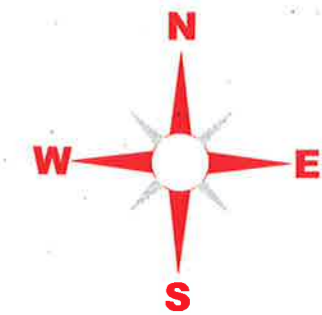

Aksi 12  
- Sez.1  
- Progr. 0+000.00  
Scala 1:1000  
Q.Rif. 130.50m

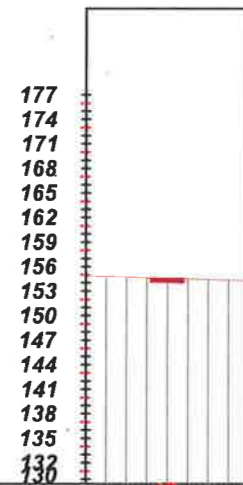

GROUND LEVEL/ KUOTA TOKES	0.00 155.60	55.15
PROJECT LEVEL /KUOTA PROJEKTIT		
PARTIAL DIST.[m] DISTANCA PARC. [m]	0.00	

Aksi 12  
- Sez.3  
- Progr. 0+040.00  
Scala 1:1000  
Q.Rif. 130.50m

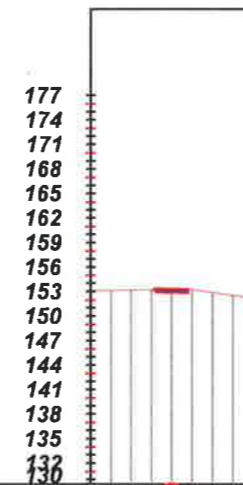

GROUND LEVEL/ KUOTA TOKES	0.00 154.34	53.85
PROJECT LEVEL /KUOTA PROJEKTIT		
PARTIAL DIST.[m] DISTANCA PARC. [m]	0.00	

Aksi 12  
- Sez.5  
- Progr. 0+064.92  
Scala 1:1000  
Q.Rif. 124.50m

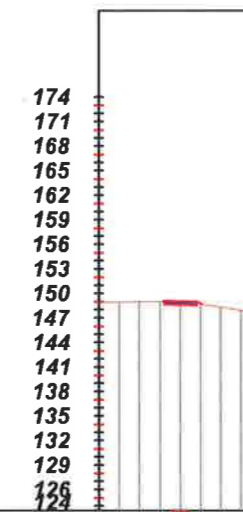

GROUND LEVEL/ KUOTA TOKES	0.00 150.06	49.61
PROJECT LEVEL /KUOTA PROJEKTIT		
PARTIAL DIST.[m] DISTANCA PARC. [m]	0.00	

Aksi 12  
- Sez.2  
- Progr. 0+020.00  
Scala 1:1000  
Q.Rif. 130.50m

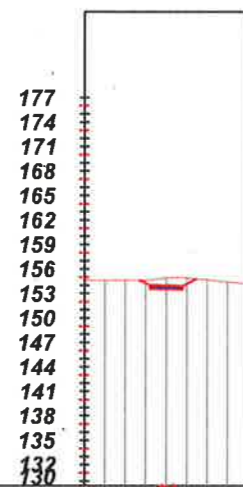

GROUND LEVEL/ KUOTA TOKES	0.00 155.26	155.28
PROJECT LEVEL /KUOTA PROJEKTIT	0.00 154.97	54.52
PARTIAL DIST.[m] DISTANCA PARC. [m]	0.00	

Aksi 12  
- Sez.4  
- Progr. 0+060.00  
Scala 1:1000  
Q.Rif. 124.50m

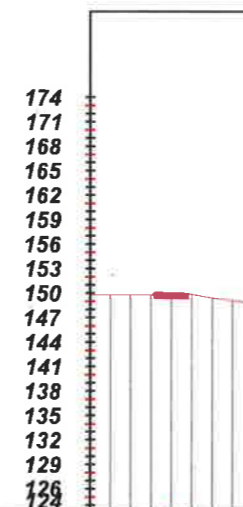

GROUND LEVEL/ KUOTA TOKES	0.00 150.91	50.46
PROJECT LEVEL /KUOTA PROJEKTIT		
PARTIAL DIST.[m] DISTANCA PARC. [m]	0.00	

## LEGJENDA

- NIVELETA E RRUGES
- TERRENI NATYRAL



## BASHKIA KAMEZ

DREJTORIA E PROJEKTEVE DHE INVESTIMEVE  
DEPARTAMENTI I PROJEKTEVE

Dr. e Projekteve e Investimeve	RAMADAN HYSA	
Pergj. Sektori i Projekteve	DENIS PRENÇI	
STAFI TEKNIK PROJEKTES	Ing. EMANUELA MËZIU	
	Ing. ARTUR ÇAJKA	
	Ing. ALEKS DANI	
	Ark. ESTELA GJYRIQI	

Titulli i Projektit	Faza e Projektit
NDERTIM RRUGËT "PASKUQAN 1 DHE 2"	PROJEKT ZBATIMI
Emertimi i Fletes	Data e implementimit :
PROFLET TËRTHORE	Shkalla e Vizimit H 1:250
	Fleta Nr. 01 (68)

# PROFILE TËRTHORE AKSI 13

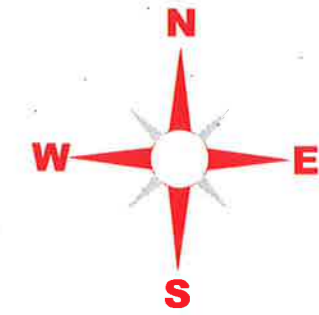
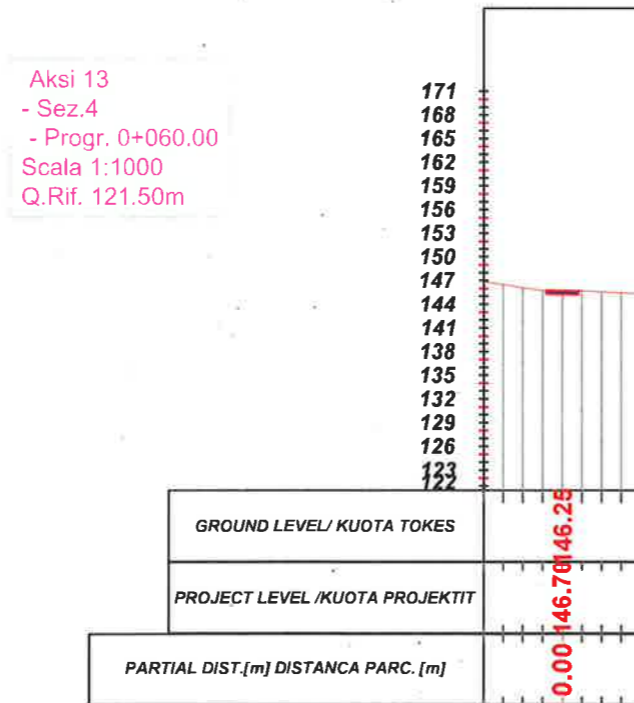
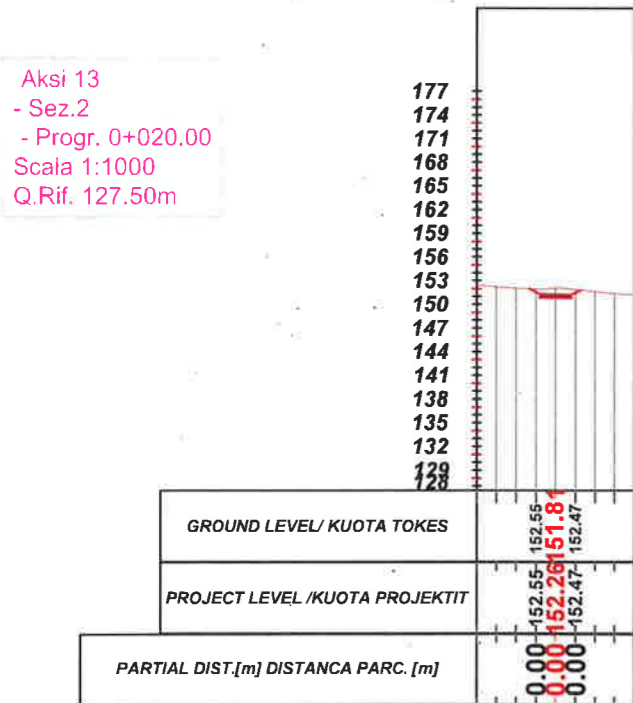
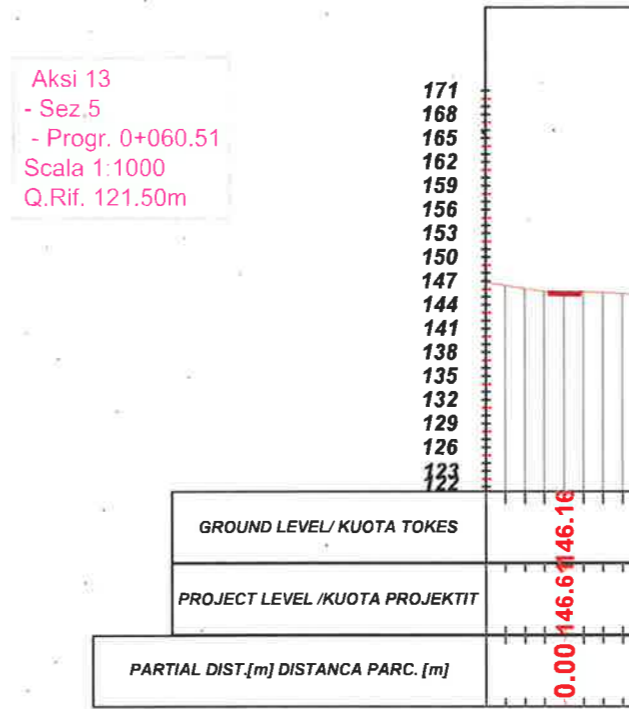
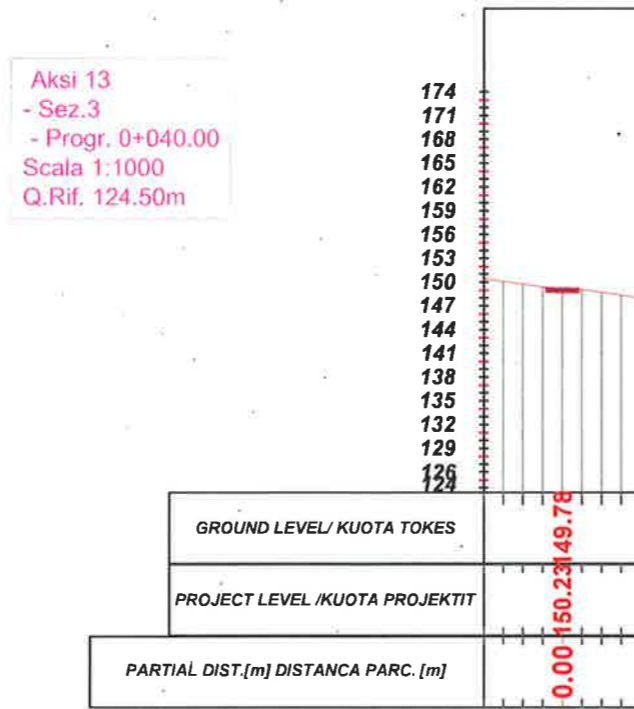
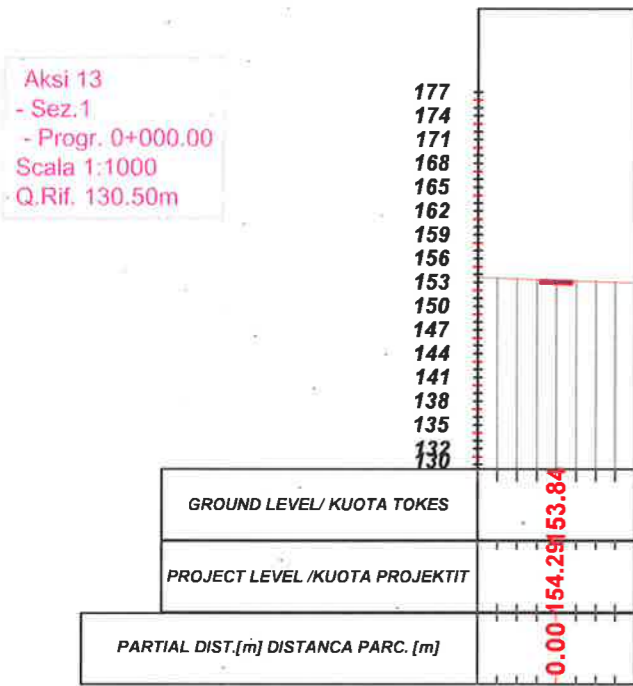

## LEGJENDA

- NIVELETA E RRUGES
- TERRENI NATYRAL



## BASHKIA KAMEZ

DREJTORIA E PROJEKTEVE DHE INVESTIMEVE  
DEPARTAMENTI I PROJEKTEVE

Dr. e Projekteve e Investimeve	RAMADAN HYSA	
Pergj. Sektori i Projekteve	DENIS PRENÇI	
STAFI TEKNIK PROJEKTUES	Ing. EMANUELA MËZIU	
	Ing. ARTUR ÇAJKA	
	Ing. ALEKS DANI	
Ark. ESTELA GJYRIQI		

Titulli i Projektit	Faza e Projektit
NDERTIM RRUGËT "PASKUQAN 1 DHE 2"	PROJEKT ZBATIMI
Emertimi i Fletes	Data e Implantimit :
PROFILET TËRTHORE	Shkalla e Vizatimit H 1:250
	Fleta Nr. 01 (69)

# PROFILE TËRTHORE AKSI 14

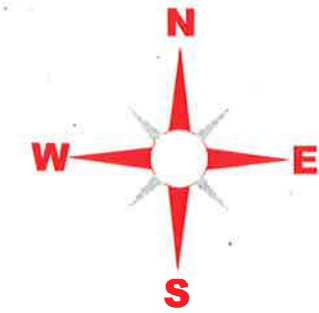

Aksi 14  
- Sez.1  
- Progr. 0+000.00  
Scala 1:1000  
Q.Rif. 148.50m

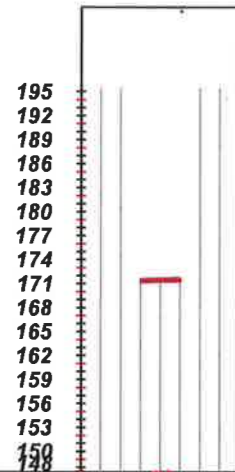

GROUND LEVEL/ KUOTA TOKES	172.62, 172.17, 172.22
PROJECT LEVEL /KUOTA PROJEKTIT	0.00, 172.67, 172.27
PARTIAL DIST.[m] DISTANCA PARC. [m]	0.00, 172.72, 172.27

Aksi 14  
- Sez.3  
- Progr. 0+040.00  
Scala 1:1000  
Q.Rif. 145.50m

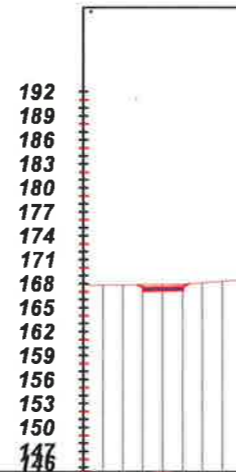

GROUND LEVEL/ KUOTA TOKES	168.51, 168.06, 168.11
PROJECT LEVEL /KUOTA PROJEKTIT	0.00, 168.56, 168.16
PARTIAL DIST.[m] DISTANCA PARC. [m]	0.00, 168.61, 168.16

Aksi 14  
- Sez.5  
- Progr. 0+080.00  
Scala 1:1000  
Q.Rif. 139.50m

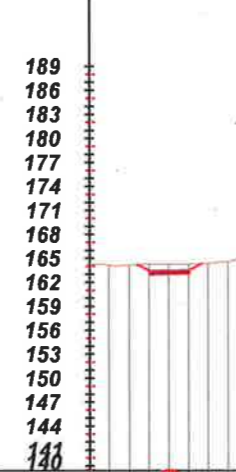

GROUND LEVEL/ KUOTA TOKES	164.40, 163.95, 164.05
PROJECT LEVEL /KUOTA PROJEKTIT	0.00, 164.45, 164.05
PARTIAL DIST.[m] DISTANCA PARC. [m]	0.00, 164.50, 164.05

Aksi 14  
- Sez.2  
- Progr. 0+020.00  
Scala 1:1000  
Q.Rif. 145.50m

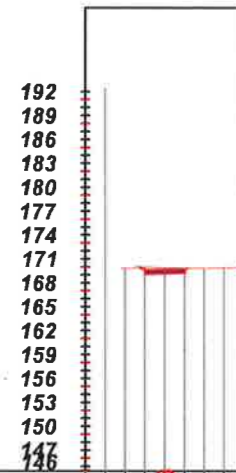

GROUND LEVEL/ KUOTA TOKES	170.11, 170.16, 170.21
PROJECT LEVEL /KUOTA PROJEKTIT	0.00, 170.56, 170.16
PARTIAL DIST.[m] DISTANCA PARC. [m]	0.00, 170.66, 170.21

Aksi 14  
- Sez.4  
- Progr. 0+060.00  
Scala 1:1000  
Q.Rif. 142.50m

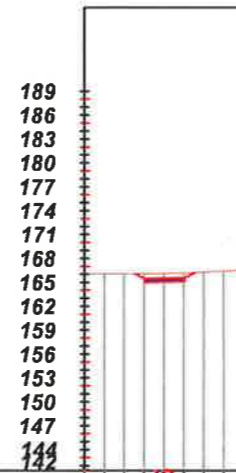

GROUND LEVEL/ KUOTA TOKES	166.45, 166.00, 166.05
PROJECT LEVEL /KUOTA PROJEKTIT	0.00, 166.50, 166.05
PARTIAL DIST.[m] DISTANCA PARC. [m]	0.00, 166.55, 166.10

Aksi 14  
- Sez.6  
- Progr. 0+100.00  
Scala 1:1000  
Q.Rif. 136.50m

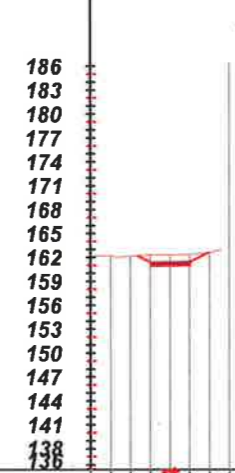

GROUND LEVEL/ KUOTA TOKES	162.34, 161.89, 161.94
PROJECT LEVEL /KUOTA PROJEKTIT	0.00, 162.39, 161.94
PARTIAL DIST.[m] DISTANCA PARC. [m]	0.00, 162.44, 161.99

## LEGJENDA

- NIVELETA E RRUGES
- TERRENI NATYRAL



## BASHKIA KAMEZ

DREJTORIA E PROJEKTEVE DHE INVESTIMEVE  
DEPARTAMENTI I PROJEKTEVE

Dr. e Projekteve e Investimeve	RAMADAN HYSA	
Pergj. Sektori i Projekteve	DENIS PRENÇI	
STAFI TEKNIK	Ing. EMANUELA MËZIU	
PROJEKTUES	Ing. ARTUR ÇAJKA	
	Ing. ALEKS DANI	
	Ark. ESTELA GJYRIQI	

Titulli i Projektit	Faza e Projektit
NDERTIM RRUGËT "PASKUQAN 1 DHE 2"	PROJEKT ZBATIMI
Emertimi i Fletes	Data e Implementimit :
PROFILET TËRTHORE	Shkalla e Vizatimit H 1:250
	Fleta Nr. 01 (70)

# PROFILE TËRTHORE AKSI 14

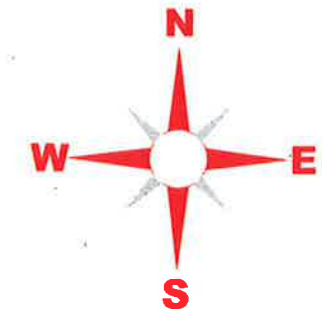

Aksi 14  
- Sez.7  
- Progr. 0+120.00  
Scala 1:1000  
Q.Rif. 136.50m

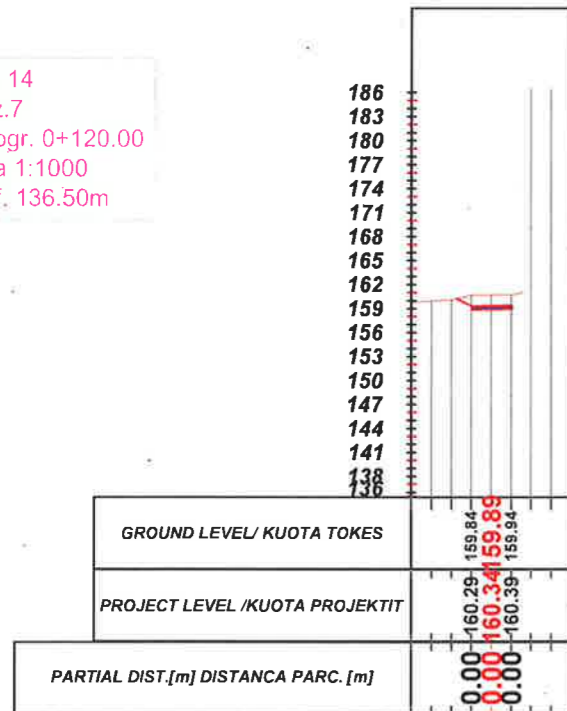

Aksi 14  
- Sez.9  
- Progr. 0+160.00  
Scala 1:1000  
Q.Rif. 130.50m

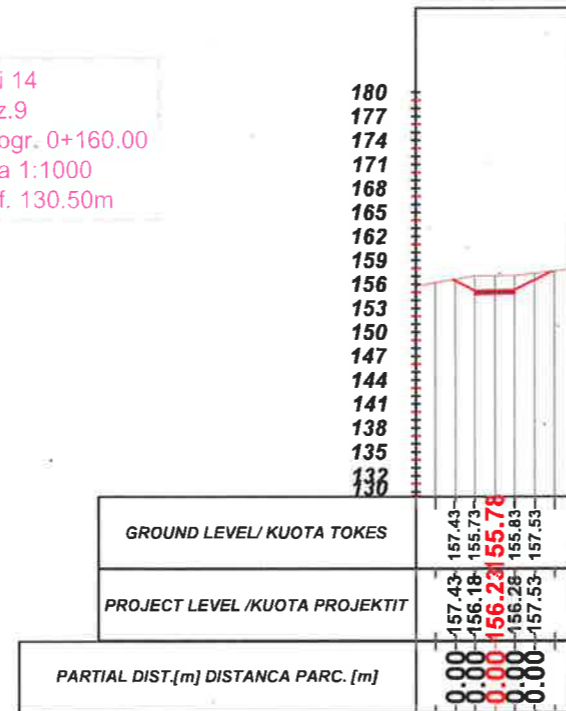

Aksi 14  
- Sez.11  
- Progr. 0+200.00  
Scala 1:1000  
Q.Rif. 127.50m

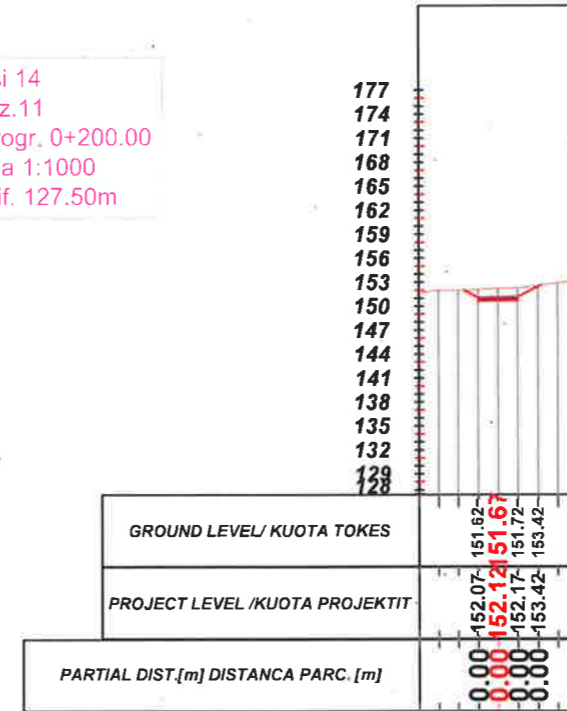

Aksi 14  
- Sez.8  
- Progr. 0+140.00  
Scala 1:1000  
Q.Rif. 133.50m

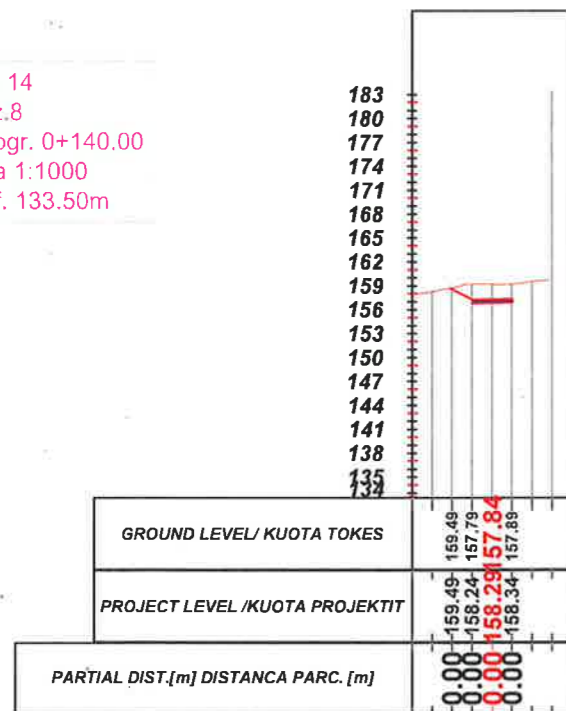

Aksi 14  
- Sez.10  
- Progr. 0+180.00  
Scala 1:1000  
Q.Rif. 130.50m

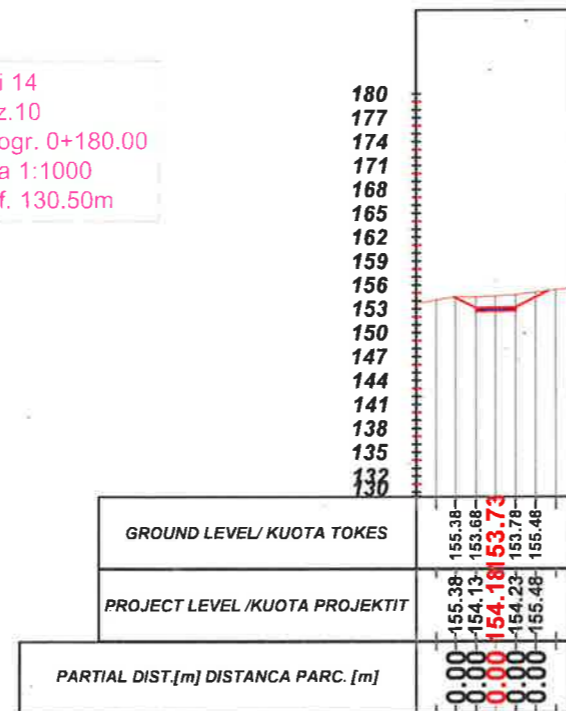

Aksi 14  
- Sez.12  
- Progr. 0+220.00  
Scala 1:1000  
Q.Rif. 124.50m

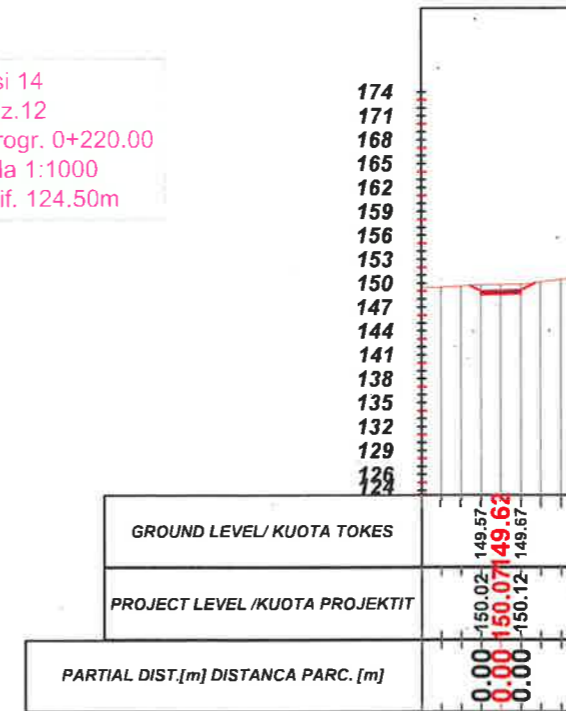

## LEGJENDA

- NIVELETA E RRUGES
- TERRENI NATYRAL



## BASHKIA KAMEZ

DREJTORIA E PROJEKTEVE DHE INVESTIMEVE  
DEPARTAMENTI I PROJEKTEVE

Dr. e Projekteve e Investimeve	RAMADAN HYSA	
Pergj. Sektori i Projekteve	DENIS PRENÇI	
STAFI TEKNIK	Ing. EMANUELA MËZIU	
PROJEKTUES	Ing. ARTUR ÇAJKA	
	Ing. ALEKS DANI	
Ark.	ESTELA GJYRIQI	

Titulli i Projektit	Faza e Projektit
NDERTIM RRUGËT "PASKUQAN 1 DHE 2"	PROJEKT ZBATIMI
Emeritimi i Fletes	Data e Implementimit :
PROFILET TËRTHORE	H 1:250
	Fleta Nr.
	01 (71)

# PROFILE TËRTHORE AKSI 14

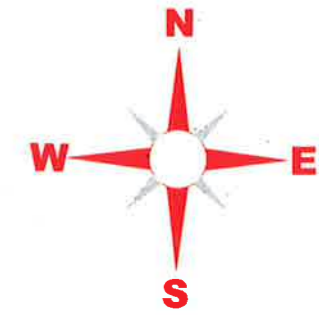

Aksi 14  
- Sez.13  
- Progr. 0+240.00  
Scala 1:1000  
Q.Rif. 124.50m

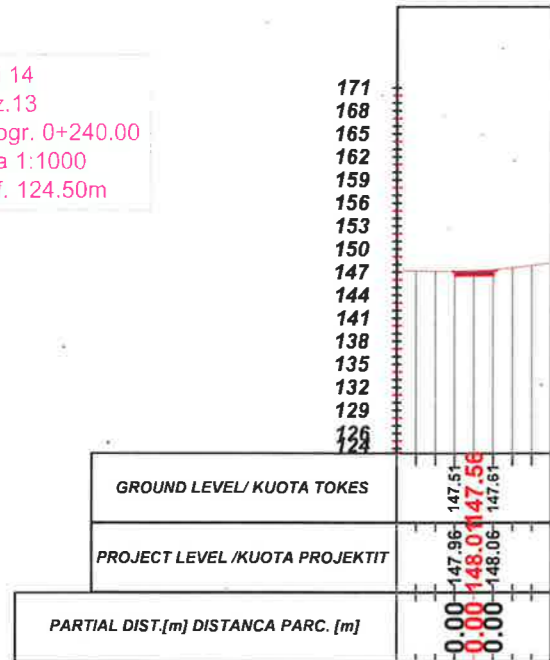

Aksi 14  
- Sez.15  
- Progr. 0+280.00  
Scala 1:1000  
Q.Rif. 121.50m

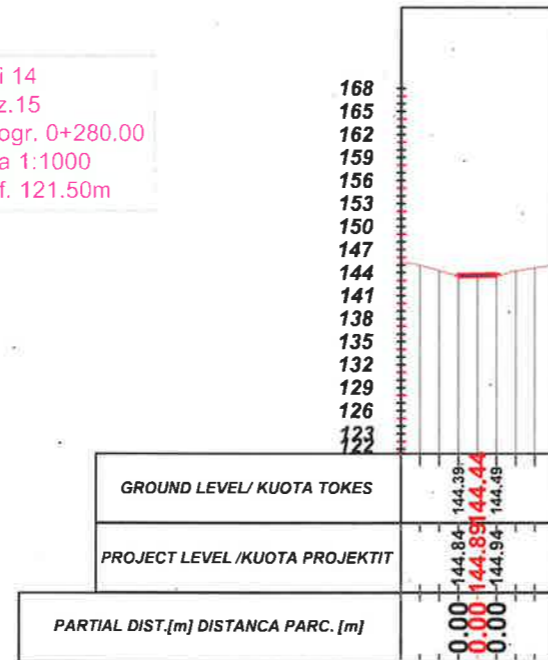

Aksi 14  
- Sez.17  
- Progr. 0+320.00  
Scala 1:1000  
Q.Rif. 118.50m

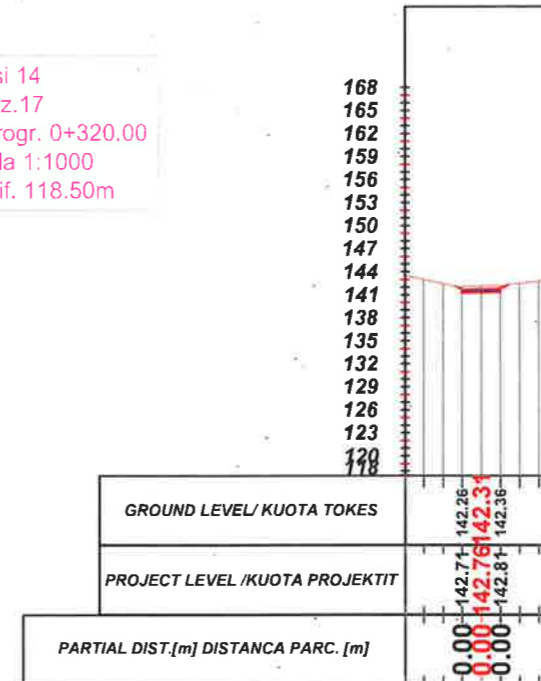

Aksi 14  
- Sez.14  
- Progr. 0+260.00  
Scala 1:1000  
Q.Rif. 121.50m

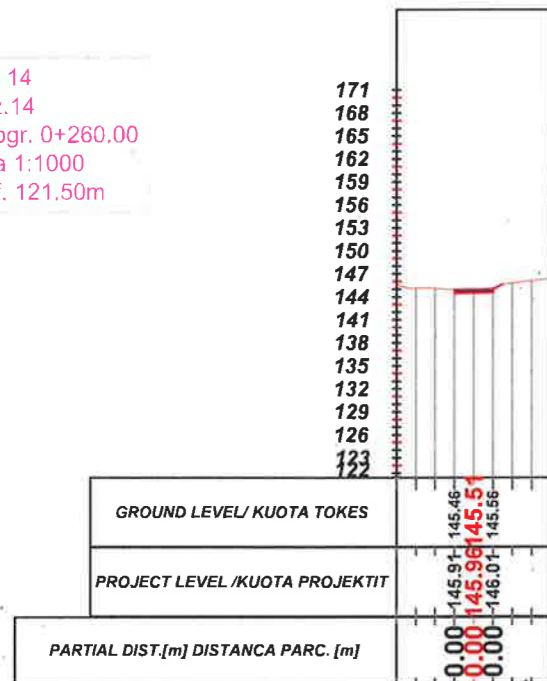

Aksi 14  
- Sez.16  
- Progr. 0+300.00  
Scala 1:1000  
Q.Rif. 118.50m

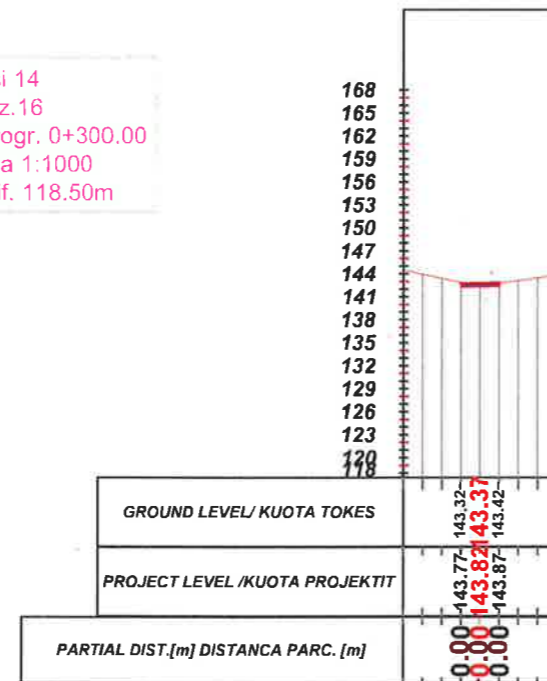

Aksi 14  
- Sez.18  
- Progr. 0+340.00  
Scala 1:1000  
Q.Rif. 118.50m

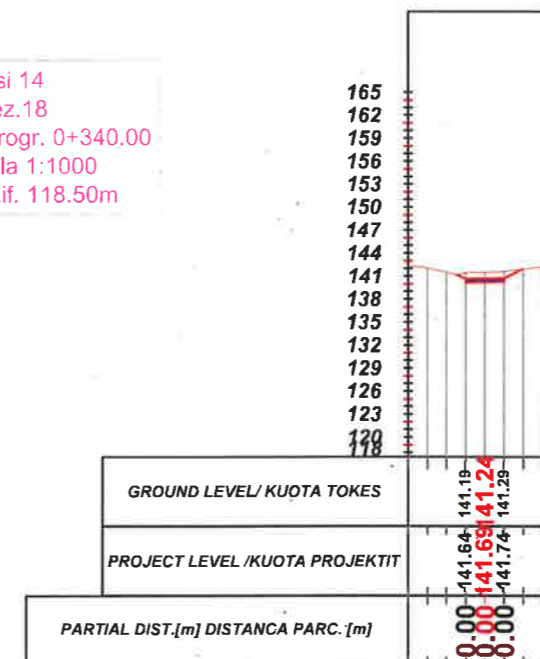

## LEGJENDA

- NIVELETA E RRUGES
- TERRENI NATYRAL



## BASHKIA KAMEZ

DREJTORIA E PROJEKTEVE DHE INVESTIMEVE  
DEPARTAMENTI I PROJEKTEVE

Dr. e Projekteve e Investimeve	RAMADAN HYSA	
Pergj. Sektori i Projekteve	DENIS PRENÇI	
STAFI TEKNIK PROJEKTUES	Ing. EMANUELA MËZIU	
	Ing. ARTUR ÇAJKA	
	Ing. ALEKS DANI	
	Ark. ESTELA GJYRIQI	

Titulli i Projektit	Faza e Projektit
NDERTIM RRUGËT "PASKUQAN I DHE 2"	PROJEKT ZBATIMI
Emerntimi i Fletes	Data e Implementimit :
PROFLET TËRTHORE	Shkalla e Vizatimit
	H 1:250
	Fleta Nr.
	01 (72)

# PROFILE TËRTHORE AKSI 14

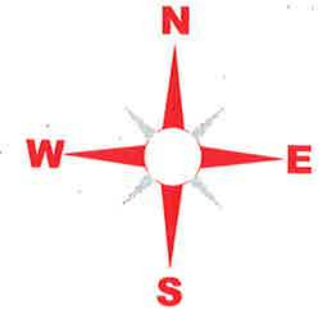

Aksi 14  
- Sez.19  
- Progr. 0+360.00  
Scala 1:1000  
Q.Rif. 115.50m

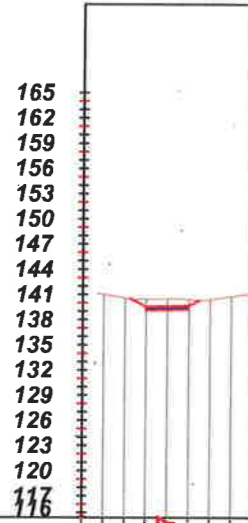

GROUND LEVEL/ KUOTA TOKES	140.12	140.17	140.22
PROJECT LEVEL /KUOTA PROJEKTIT	140.57	140.62	140.67
PARTIAL DIST.[m] DISTANCA PARC. [m]	0.00	0.00	0.00

Aksi 14  
- Sez.21  
- Progr. 0+400.00  
Scala 1:1000  
Q.Rif. 112.50m

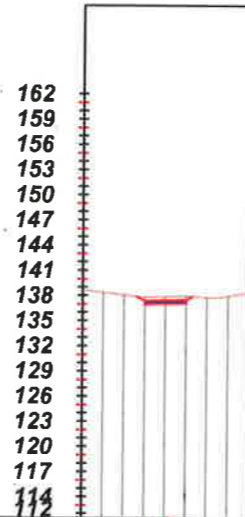

GROUND LEVEL/ KUOTA TOKES	137.99	138.04	138.09
PROJECT LEVEL /KUOTA PROJEKTIT	138.44	138.49	138.54
PARTIAL DIST.[m] DISTANCA PARC. [m]	0.00	0.00	0.00

Aksi 14  
- Sez.23  
- Progr. 0+440.00  
Scala 1:1000  
Q.Rif. 112.50m

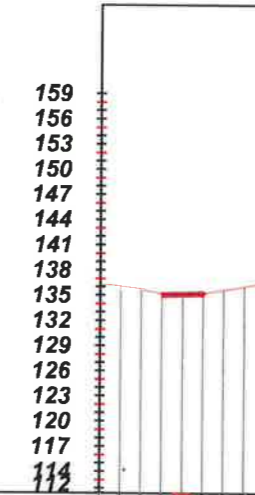

GROUND LEVEL/ KUOTA TOKES	135.86	135.91	135.96
PROJECT LEVEL /KUOTA PROJEKTIT	136.31	136.36	136.41
PARTIAL DIST.[m] DISTANCA PARC. [m]	0.00	0.00	0.00

Aksi 14  
- Sez.20  
- Progr. 0+380.00  
Scala 1:1000  
Q.Rif. 115.50m

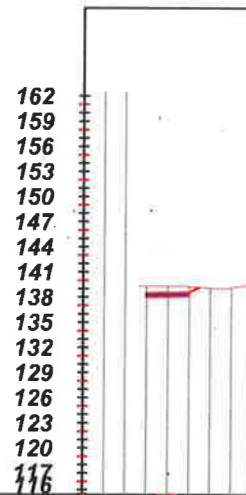

GROUND LEVEL/ KUOTA TOKES	139.06	139.11	139.16
PROJECT LEVEL /KUOTA PROJEKTIT	139.51	139.56	139.61
PARTIAL DIST.[m] DISTANCA PARC. [m]	0.00	0.00	0.00

Aksi 14  
- Sez.22  
- Progr. 0+420.00  
Scala 1:1000  
Q.Rif. 112.50m

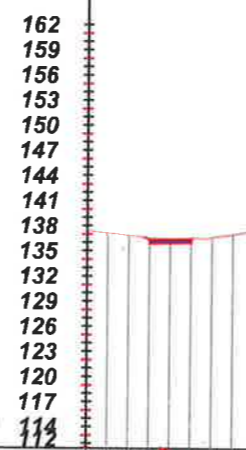

GROUND LEVEL/ KUOTA TOKES	136.92	136.97	137.02
PROJECT LEVEL /KUOTA PROJEKTIT	137.37	137.42	137.47
PARTIAL DIST.[m] DISTANCA PARC. [m]	0.00	0.00	0.00

Aksi 14  
- Sez.24  
- Progr. 0+460.00  
Scala 1:1000  
Q.Rif. 109.50m

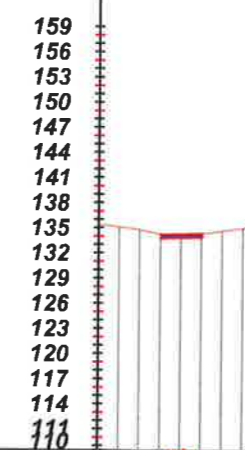

GROUND LEVEL/ KUOTA TOKES	134.79	134.84	134.89
PROJECT LEVEL /KUOTA PROJEKTIT	135.24	135.29	135.34
PARTIAL DIST.[m] DISTANCA PARC. [m]	0.00	0.00	0.00

## LEGJENDA

- NIVELETA E RRUGES
- TERRENI NATYRAL



**BASHKIA KAMEZ**

DREJTORIA E PROJEKTEVE DHE INVESTIMEVE  
DEPARTAMENTI I PROJEKTEVE

Dr. e Projekteve e Investimeve	RAMADAN HYSA	
Pergj. Sektori i Projekteve	DENIS PRENÇI	
STAFI TEKNIK PROJEKTES	Ing. EMANUELA MËZIU	
	Ing. ARTUR ÇAJKA	
	Ing. ALEKS DANI	
	Ark. ESTELA GJYRIQI	

Titulli i Projektit	Faza e Projektit
NDERTIM RRUGËT "PASKUQAN 1 DHE 2"	PROJEKT ZBATIMI
Emertimi i Fletes	Data e Implementimit
PROFILET TËRTHORE	Shkalla e Vizatimit
	H 1:250
	Fleta Nr.
	01 (73)

# PROFILE TËRTHORE AKSI 14

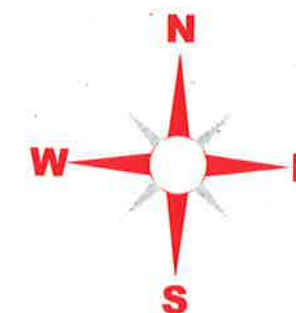

Aksi 14  
- Sez.25  
- Progr. 0+480.00  
Scala 1:1000  
Q.Rif. 109.50m

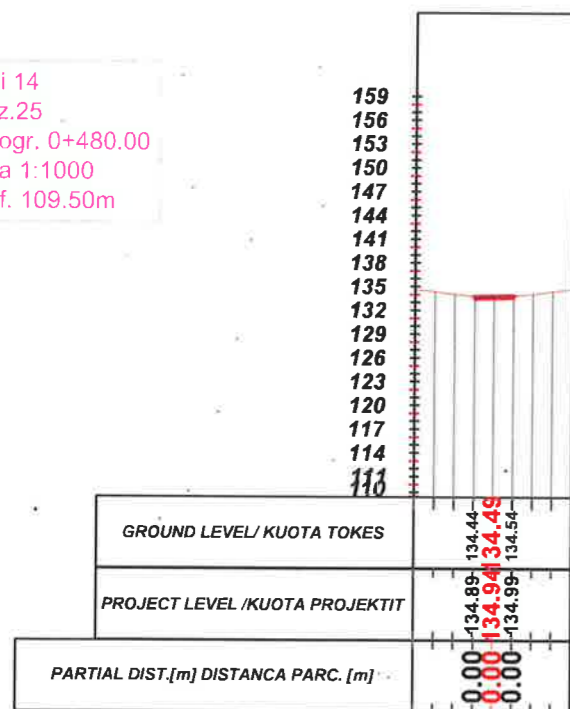

Aksi 14  
- Sez.27  
- Progr. 0+520.00  
Scala 1:1000  
Q.Rif. 109.50m

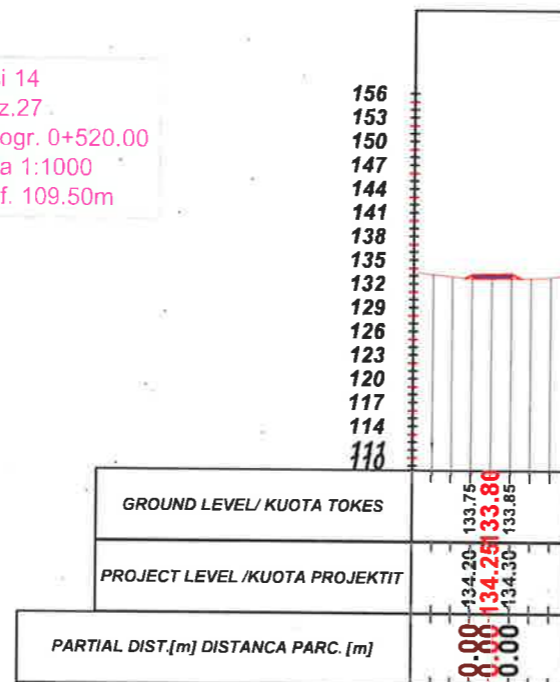

Aksi 14  
- Sez.29  
- Progr. 0+560.00  
Scala 1:1000  
Q.Rif. 109.50m

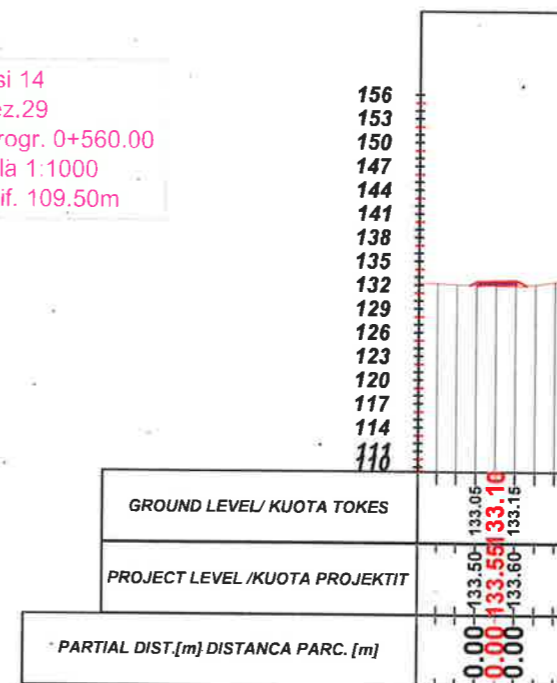

Aksi 14  
- Sez.26  
- Progr. 0+500.00  
Scala 1:1000  
Q.Rif. 109.50m

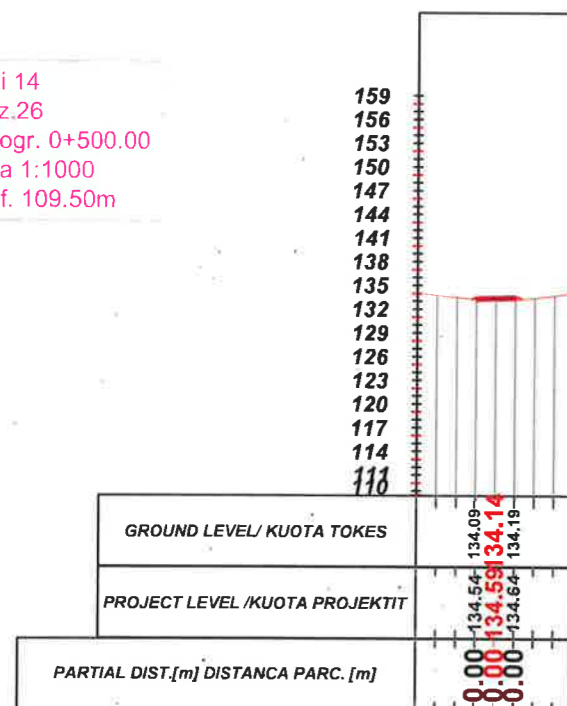

Aksi 14  
- Sez.28  
- Progr. 0+540.00  
Scala 1:1000  
Q.Rif. 109.50m

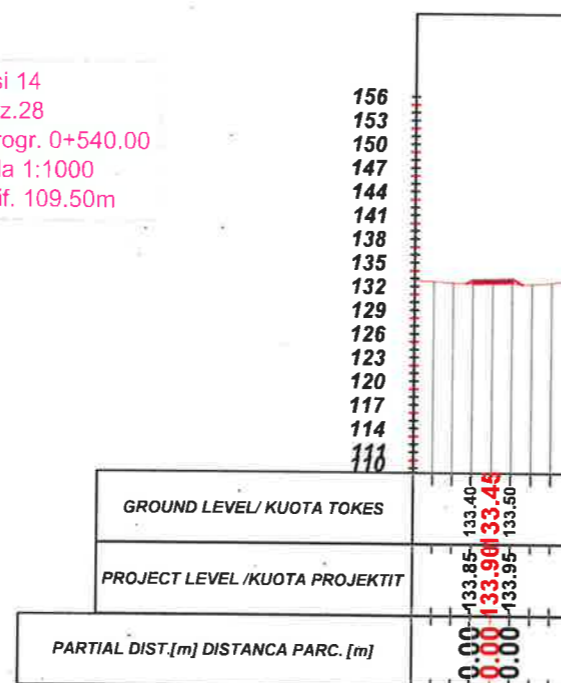

Aksi 14  
- Sez.30  
- Progr. 0+580.00  
Scala 1:1000  
Q.Rif. 109.50m

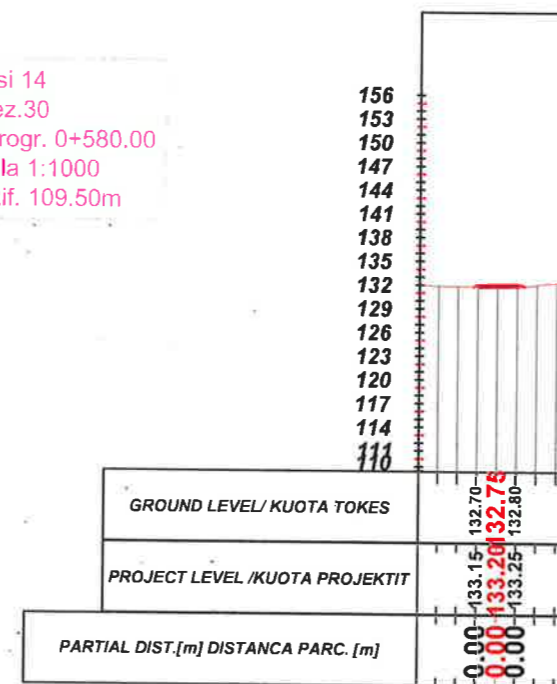

## LEGJENDA

- NIVELETA E RRUGES
- TERRENI NATYRAL



**BASHKIA KAMEZ**

DREJTORIA E PROJEKTEVE DHE INVESTIMEVE  
DEPARTAMENTI I PROJEKTEVE

Dr. e Projekteve e Investimeve	RAMADAN HYSA	
Pergj. Sektori i Projekteve	DENIS PRENÇI	
STAFI TEKNIK PROJEKTES	Ing. EMANUELA MËZIU	
	Ing. ARTUR ÇAJKA	
	Ing. ALEKS DANI	
Ark. ESTELA GJYRIQI		

Titulli i Projektit	Faza e Projektit
NDERTIM RRUGËT "PASKUQAN 1 DHE 2"	PROJEKT ZBATIMI
Emertimi i Fletes	Data e Implementimit :
PROFILET TËRTHORE	Shkalla e Vizatimit
	H 1:250
	Fleta Nr.
	01 (74)

# PROFILE TËRTHORE AKSI 14

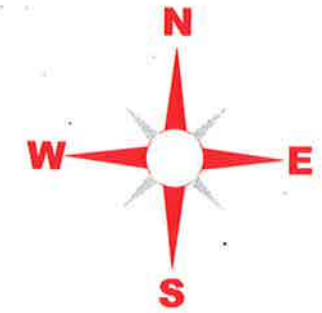

Aksi 14  
- Sez.31  
- Progr. 0+600.00  
Scala 1:1000  
Q.Rif. 109.50m

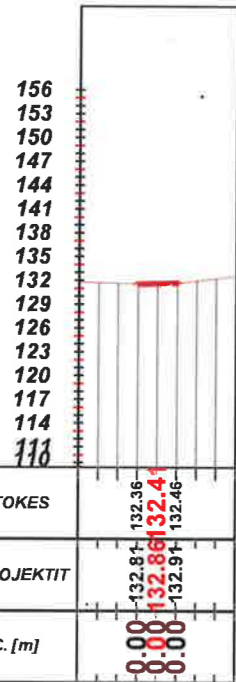

Aksi 14  
- Sez.33  
- Progr. 0+640.00  
Scala 1:1000  
Q.Rif. 106.50m

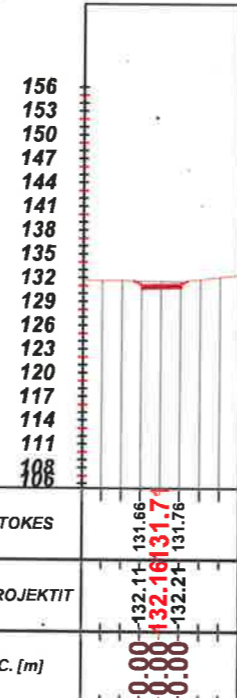

Aksi 14  
- Sez.35  
- Progr. 0+680.00  
Scala 1:1000  
Q.Rif. 106.50m

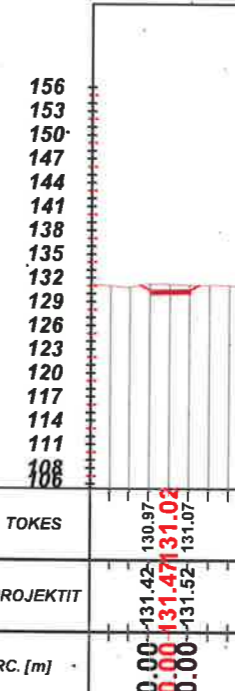

Aksi 14  
- Sez.32  
- Progr. 0+620.00  
Scala 1:1000  
Q.Rif. 109.50m

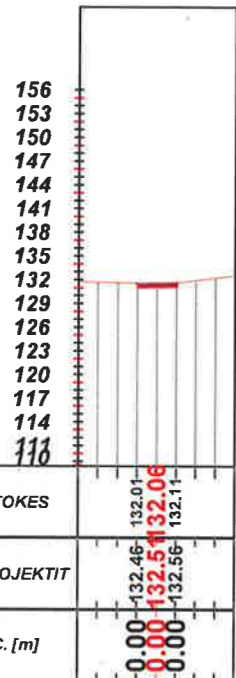

Aksi 14  
- Sez.34  
- Progr. 0+660.00  
Scala 1:1000  
Q.Rif. 106.50m

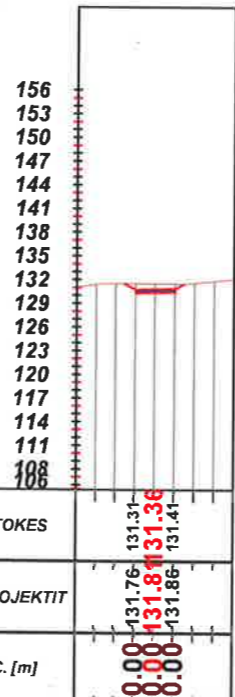

Aksi 14  
- Sez.36  
- Progr. 0+700.00  
Scala 1:1000  
Q.Rif. 106.50m

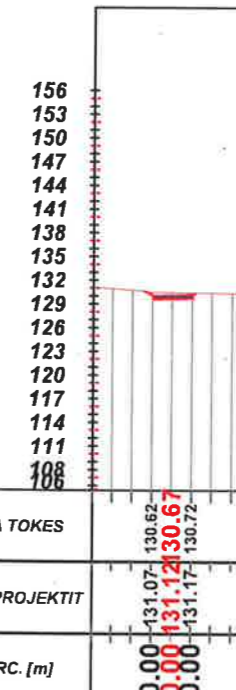

## LEGJENDA

- NIVELETA E RRUGES
- TERRENI NATYRAL



## BASHKIA KAMEZ

DREJTORIA E PROJEKTEVE DHE INVESTIMEVE  
DEPARTAMENTI I PROJEKTEVE

Dr. e Projekteve e Investimeve	RAMADAN HYSA	
Pergj. Sektori i Projekteve	DENIS PRENÇI	
STAFI TEKNIK PROJEKTUES	Ing. EMANUELA MËZIU	
	Ing. ARTUR ÇAJKA	
	Ing. ALEKS DANI	
	Ark. ESTELA GJYRIQI	

Titulli i Projektit	Faza e Projektit
NDERTIM RRUGËT "PASKUQAN 1 DHE 2"	PROJEKT ZBATIMI
Emeritimi i Fletes	Data e Implementimit :
PROFLET TËRTHORE	Shkalla e Vizatimit
	H 1:250
	Fleta Nr.
	01 (75)

# PROFILE TËRTHORE AKSI 14

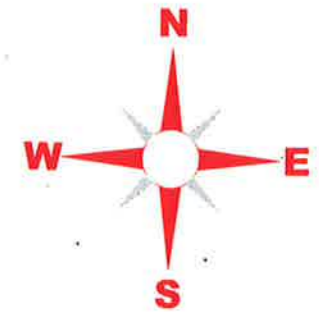

Aksi 14  
- Sez.37  
- Progr. 0+720.00  
Scala 1:1000  
Q.Rif. 106.50m

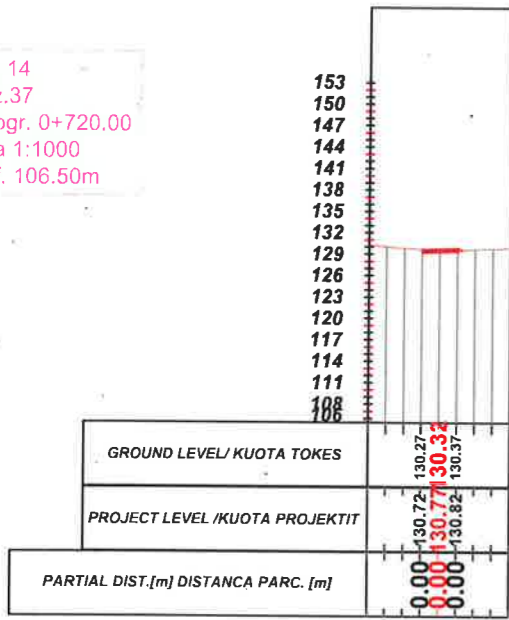

Aksi 14  
- Sez.39  
- Progr. 0+760.00  
Scala 1:1000  
Q.Rif. 106.50m

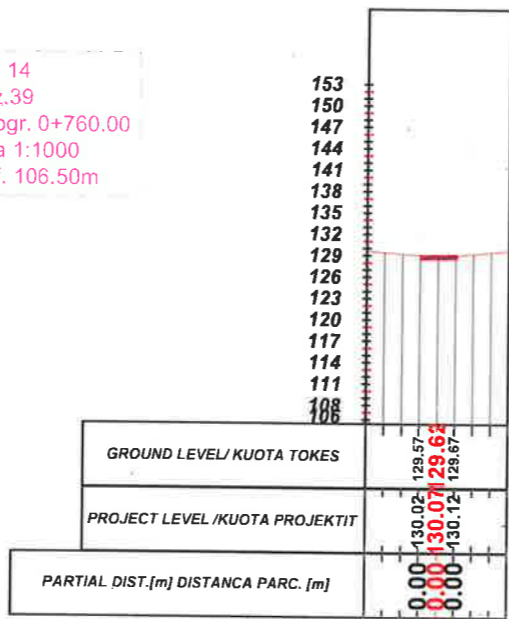

Aksi 14  
- Sez.41  
- Progr. 0+800.00  
Scala 1:1000  
Q.Rif. 106.50m

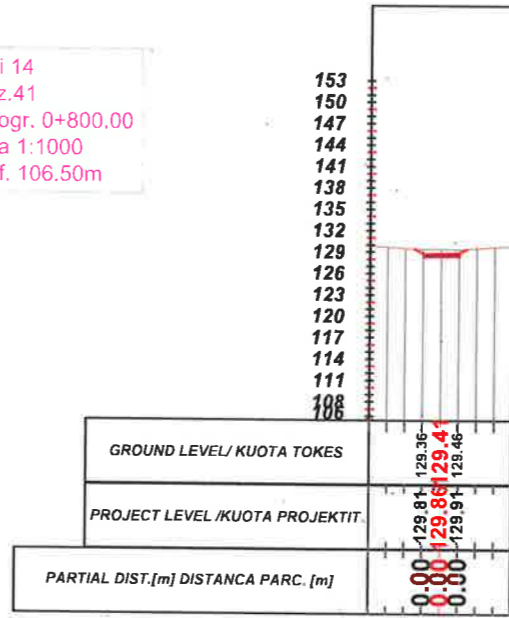

Aksi 14  
- Sez.38  
- Progr. 0+740.00  
Scala 1:1000  
Q.Rif. 106.50m

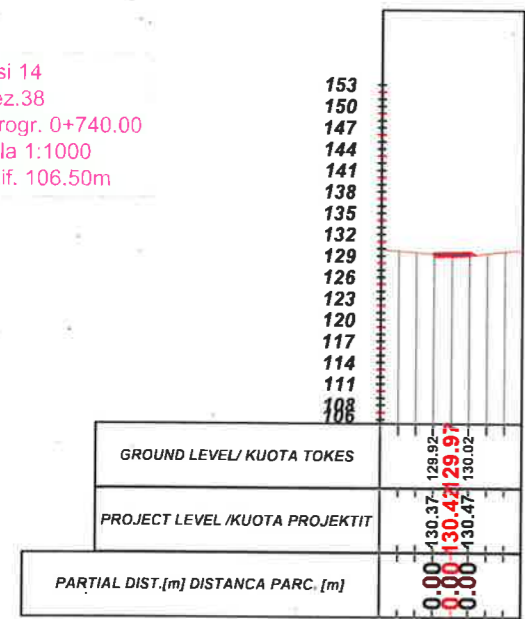

Aksi 14  
- Sez.40  
- Progr. 0+780.00  
Scala 1:1000  
Q.Rif. 106.50m

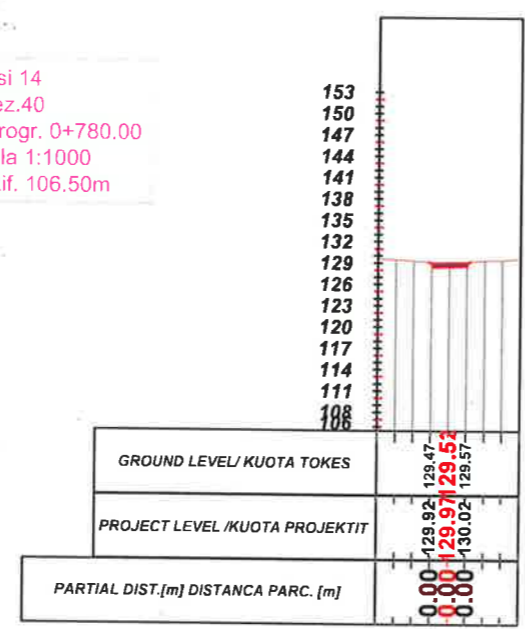

Aksi 14  
- Sez.42  
- Progr. 0+820.00  
Scala 1:1000  
Q.Rif. 106.50m

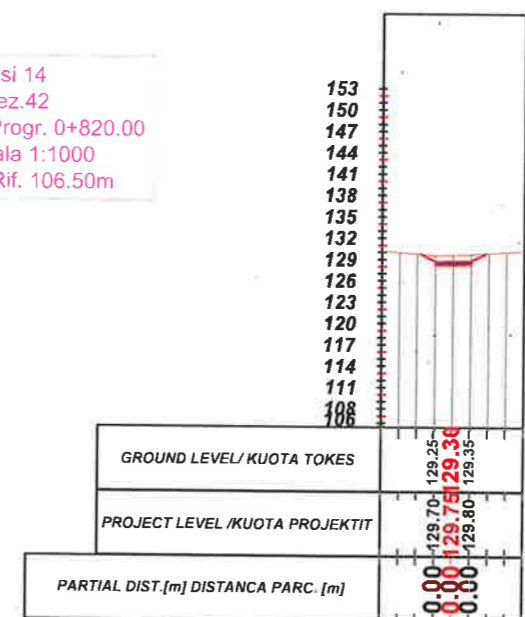

## LEGJENDA

- NIVELETA E RRUGES
- TERRENI NATYRAL



**BASHKIA KAMEZ**

DREJTORIA E PROJEKTEVE DHE INVESTIMEVE  
DEPARTAMENTI I PROJEKTEVE

Dr. e Projekteve e Investimeve	RAMADAN HYSA	
Pergj. Sektori i Projekteve	DENIS PRENÇI	
STAFI TEKNIK	Ing. EMANUELA MËZIU	
PROJEKTUES	Ing. ARTUR ÇAJKA	
	Ing. ALEKS DANI	
	Ark. ESTELA GJYRIQI	

Titulli i Projektit	Faza e Projektit
NDERTIM RRUGËT "PASKUQAN 1 DHE 2"	PROJEKT ZBATIMI
Emertimi i Fletes	Data e Implementimit :
PROFLET TËRTHORE	Shkalla e Vizatimit
	H 1:250
	Fleta Nr.
	01 (76)

# PROFILE TËRTHORE AKSI 14

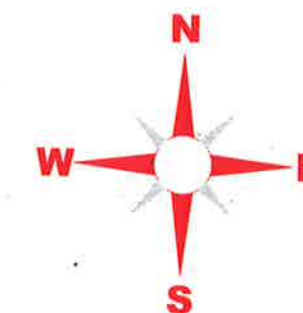

Aksi 14  
- Sez.43  
- Progr. 0+840.00  
Scala 1:1000  
Q.Rif. 106.50m

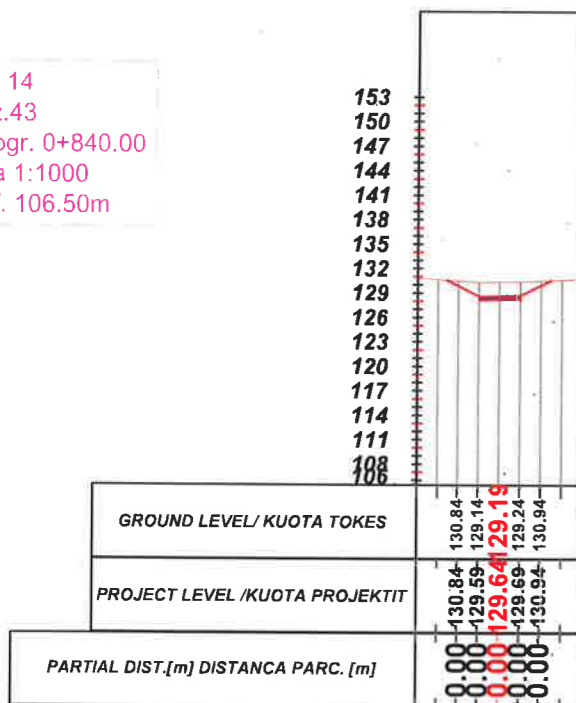

Aksi 14  
- Sez.45  
- Progr. 0+880.00  
Scala 1:1000  
Q.Rif. 103.50m

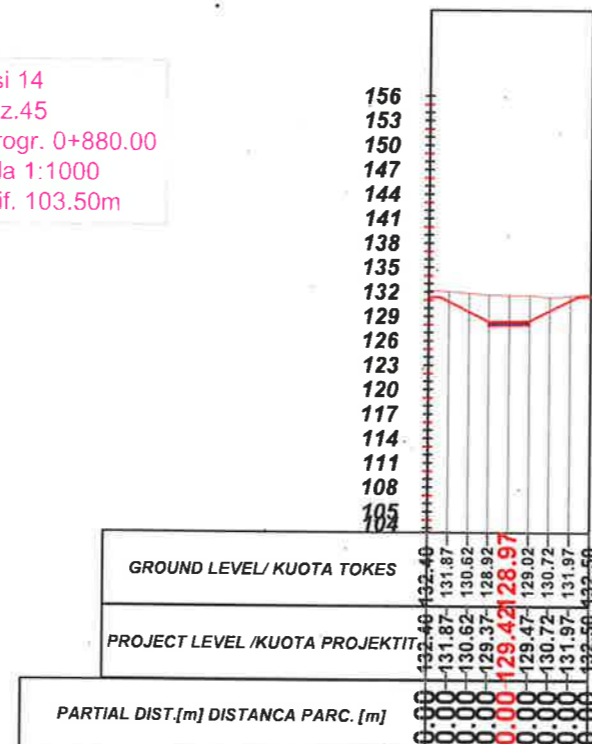

Aksi 14  
- Sez.47  
- Progr. 0+920.00  
Scala 1:1000  
Q.Rif. 103.50m

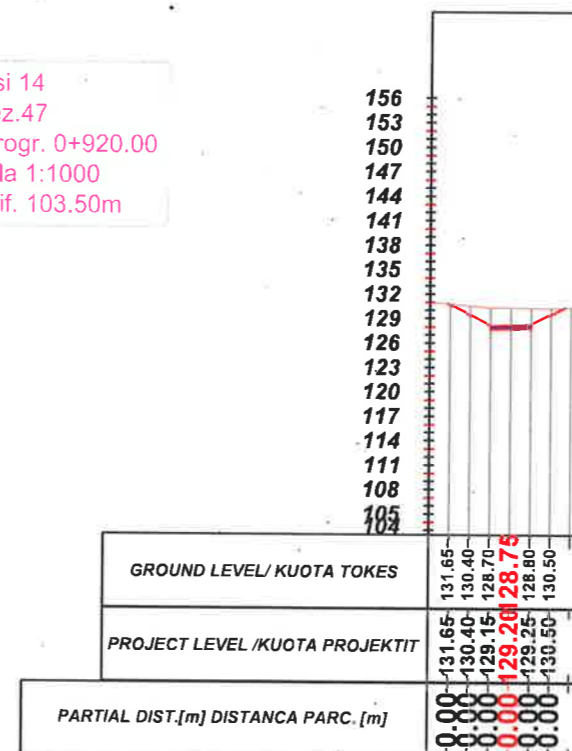

Aksi 14  
- Sez.44  
- Progr. 0+860.00  
Scala 1:1000  
Q.Rif. 106.50m

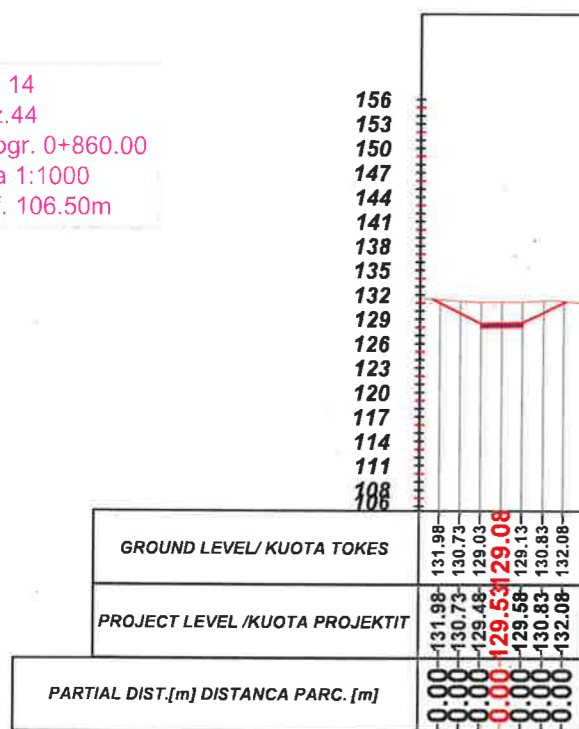

Aksi 14  
- Sez.46  
- Progr. 0+900.00  
Scala 1:1000  
Q.Rif. 103.50m

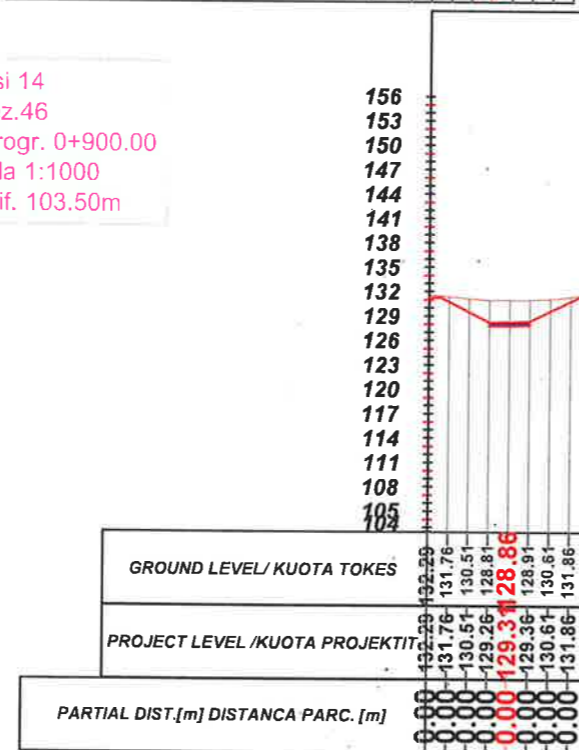

Aksi 14  
- Sez.48  
- Progr. 0+940.00  
Scala 1:1000  
Q.Rif. 103.50m

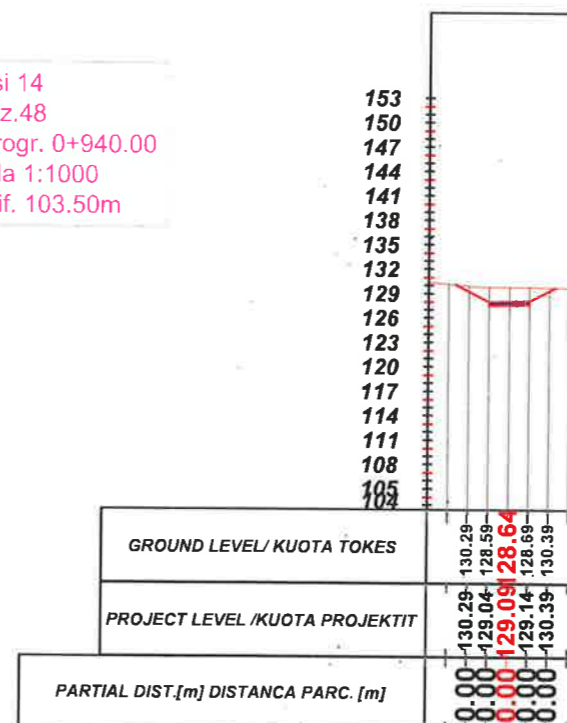

## LEGJENDA

- NIVELETA E RRUGES
- TERRENI NATYRAL



**BASHKIA KAMEZ**

DREJTORIA E PROJEKTEVE DHE INVESTIMEVE  
DEPARTAMENTI I PROJEKTEVE

Dr. e Projekteve e Investimeve	RAMADAN HYSA	
Pergj. Sektori i Projekteve	DENIS PRENÇI	
STAFI TEKNIK PROJEKTES	Ing. EMANUELA MËZIU	
	Ing. ARTUR ÇAJKA	
	Ing. ALEKS DANI	
Ark. ESTELA GJYRIQI		

Titulli i Projektit	Faza e Projektit
NDERTIM RRUGËT "PASKUQAN 1 DHE 2"	PROJEKT ZBATIMI
Emertimi i Fletes	Data e Implementimit:
PROFLET TËRTHORE	Shkalla e Vizatimit
	H 1:250
	Fleta Nr.
	01 (77)

# PROFILE TËRTHORE AKSI 14

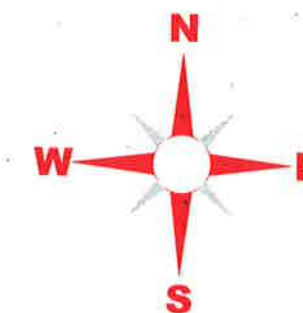

Aksi 14  
- Sez.49  
- Progr. 0+960.00  
Scala 1:1000  
Q.Rif. 103.50m

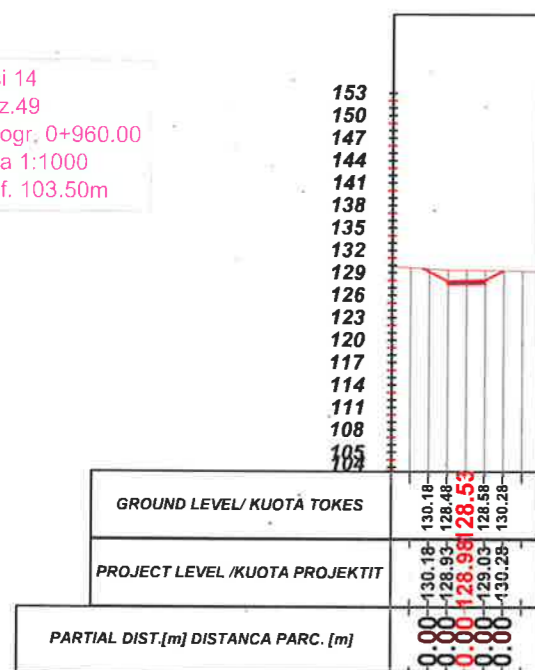

Aksi 14  
- Sez.51  
- Progr. 1+000.00  
Scala 1:1000  
Q.Rif. 103.50m

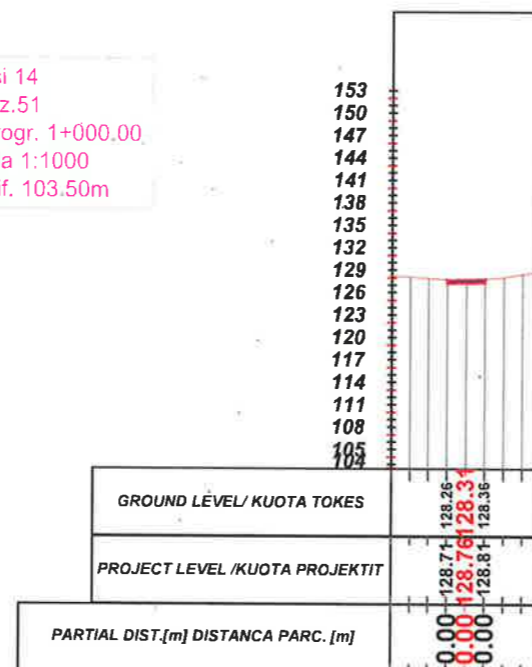

Aksi 14  
- Sez.53  
- Progr. 1+040.00  
Scala 1:1000  
Q.Rif. 103.50m

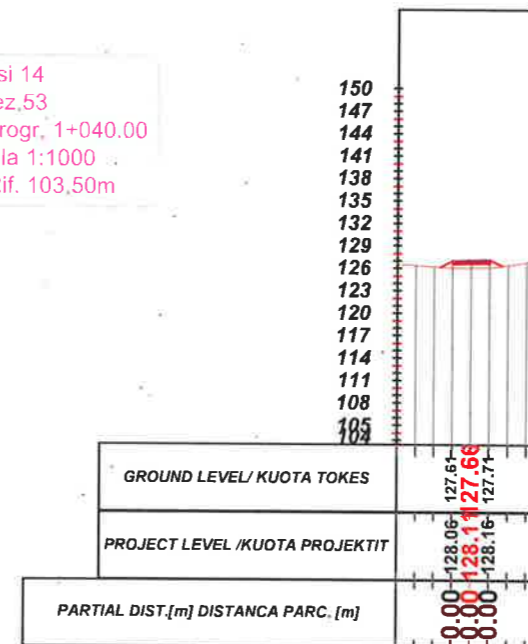

Aksi 14  
- Sez.50  
- Progr. 0+980.00  
Scala 1:1000  
Q.Rif. 103.50m

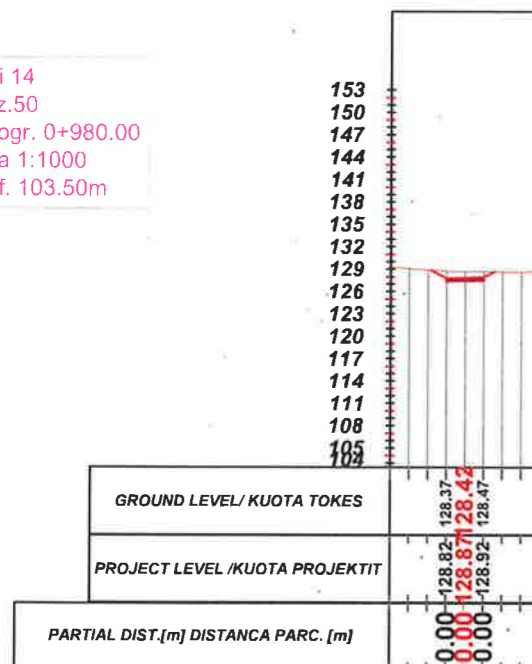

Aksi 14  
- Sez.52  
- Progr. 1+020.00  
Scala 1:1000  
Q.Rif. 103.50m

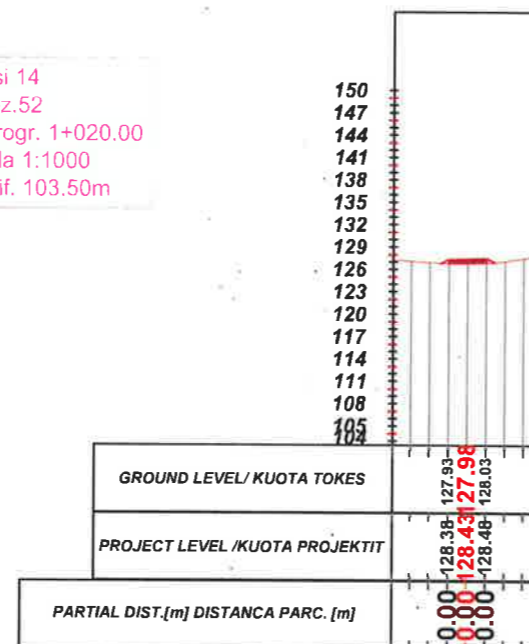

Aksi 14  
- Sez.54  
- Progr. 1+060.00  
Scala 1:1000  
Q.Rif. 103.50m

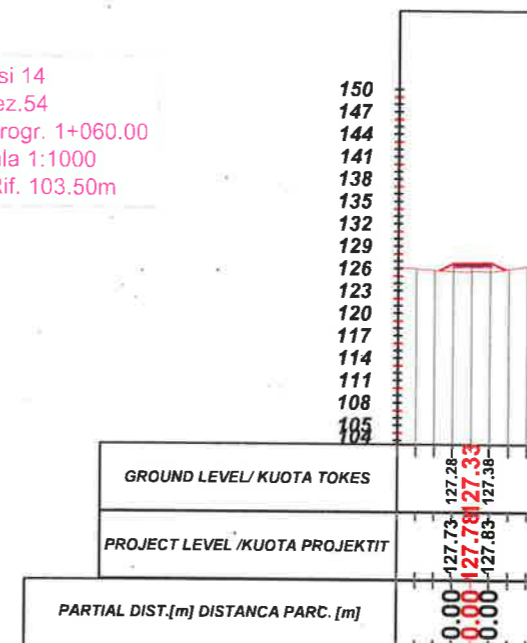

## LEGJENDA

- NIVELETA E RRUGES
- TERRENI NATYRAL



**BASHKIA KAMEZ**

DREJTORIA E PROJEKTEVE DHE INVESTIMEVE  
DEPARTAMENTI I PROJEKTEVE

Dr. e Projekteve e Investimeve	RAMADAN HYSA	
Pergj. Sektori i Projekteve	DENIS PRENÇI	
STAFI TEKNIK PROJEKTUES	Ing. EMANUELA MËZIU	
	Ing. ARTUR ÇAJKA	
	Ing. ALEKS DANI	
Ark.	ESTELA GJYRIQI	

Titulli i Projektit	Faza e Projektit
NDERTIM RRUGËT "PASKUQAN 1 DHE 2"	PROJEKT ZBATIMI
Emertimi i Fletes	Data e Implementimit :
PROFILLET TËRTHORE	Shkalla e Vizatimit:
	H 1:250
	Fleta Nr.
	01 (78)

# PROFILE TËRTHORE AKSI 14

Aksi 14  
- Sez.55  
- Progr. 1+080.00  
Scala 1:1000  
Q.Rif. 103.50m

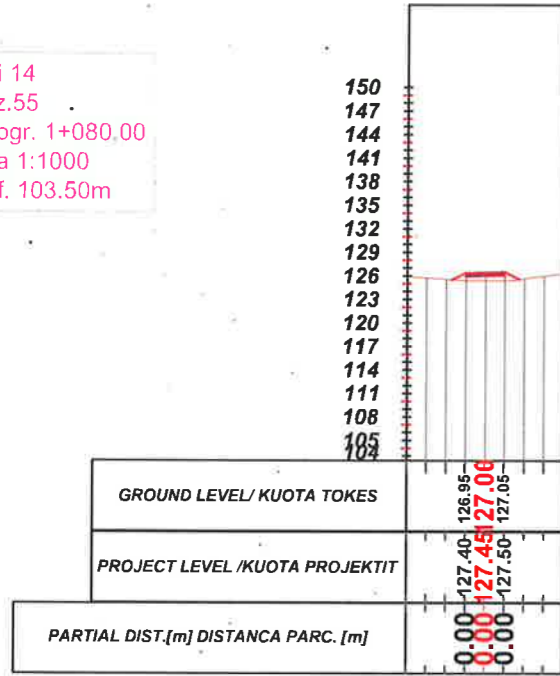

Aksi 14  
- Sez.57  
- Progr. 1+120.00  
Scala 1:1000  
Q.Rif. 100.50m

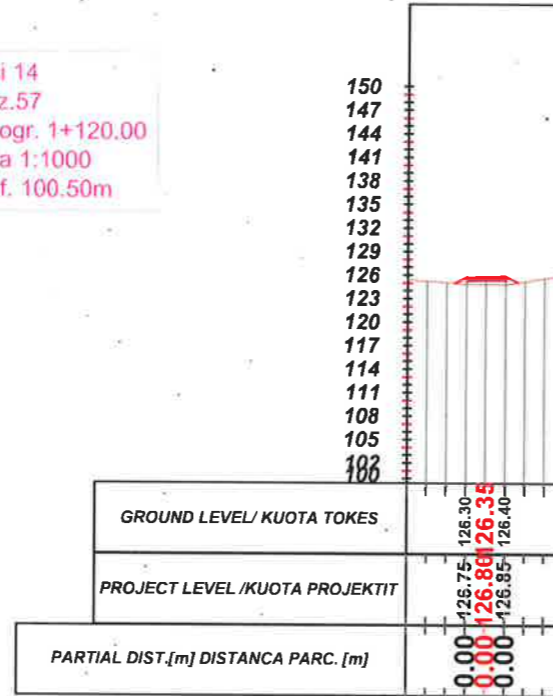

Aksi 14  
- Sez.59  
- Progr. 1+160.00  
Scala 1:1000  
Q.Rif. 100.50m

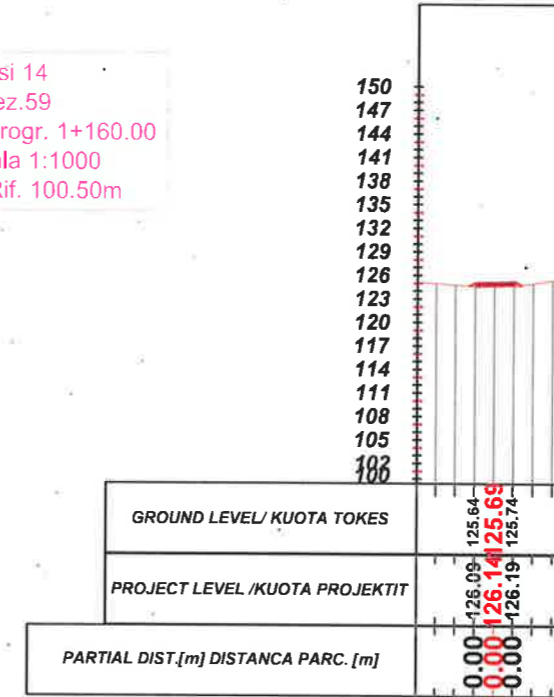

Aksi 14  
- Sez.56  
- Progr. 1+100.00  
Scala 1:1000  
Q.Rif. 103.50m

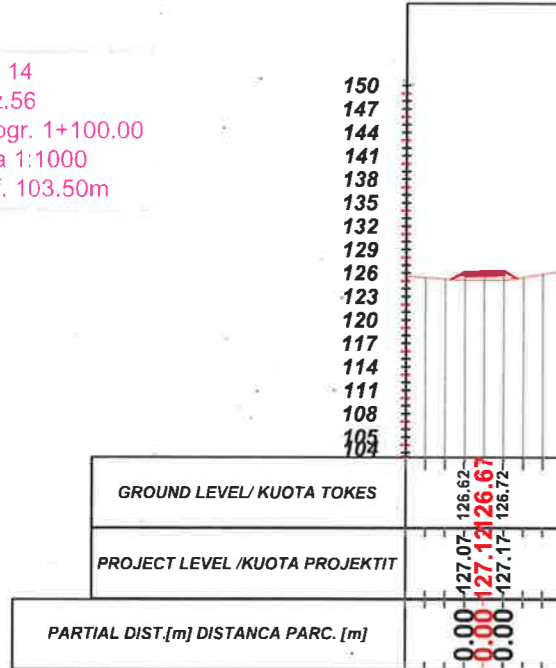

Aksi 14  
- Sez.58  
- Progr. 1+140.00  
Scala 1:1000  
Q.Rif. 100.50m

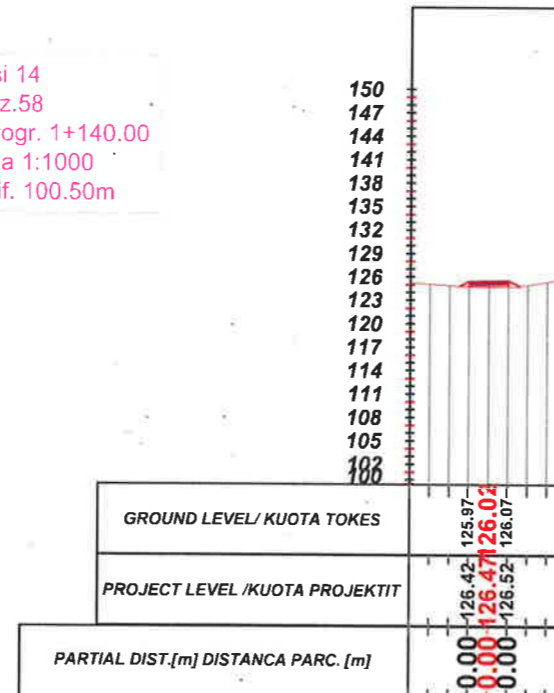

Aksi 14  
- Sez.60  
- Progr. 1+180.00  
Scala 1:1000  
Q.Rif. 100.50m

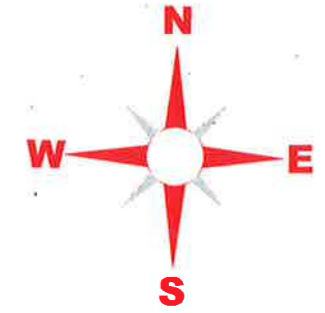
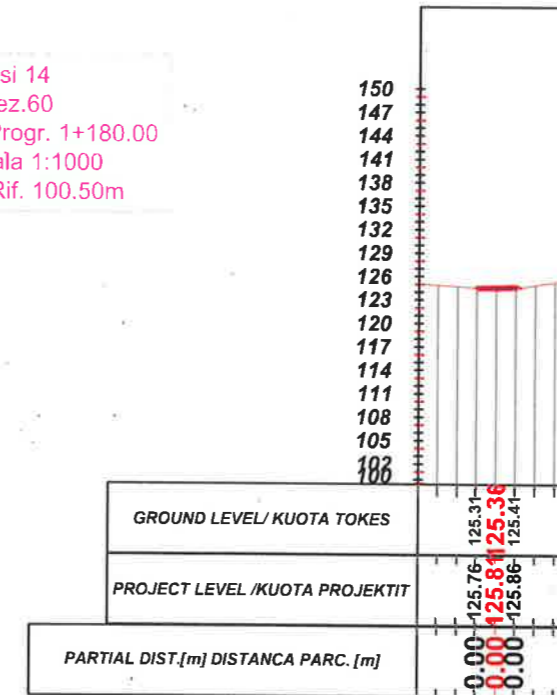

## LEGJENDA

- NIVELETA E RRUGES
- TERRENI NATYRAL



**BASHKIA KAMEZ**

DREJTORIA E PROJEKTEVE DHE INVESTIMEVE  
DEPARTAMENTI I PROJEKTEVE

Dr. e Projekteve e Investimeve	RAMADAN HYSA	
Pergj. Sektori i Projekteve	DENIS PRENÇI	
STAFI TEKNIK PROJEKTUES	Ing. EMANUELA MËZIU	
	Ing. ARTUR ÇAJKA	
	Ing. ALEKS DANI	
Ark.	ESTELA GJYRIQI	

Titulli i Projektit	Faza e Projektit
NDERTIM RRUGËT "PASKUQAN 1 DHE 2"	PROJEKT ZBATIMI
Emertimi i Fletes	Data e Implementimit :
PROFLET TËRTHORE	Shkalla e Vizatimit
	H 1:250
	Fleta Nr.
	01 (79)

# PROFILE TËRTHORE AKSI 14

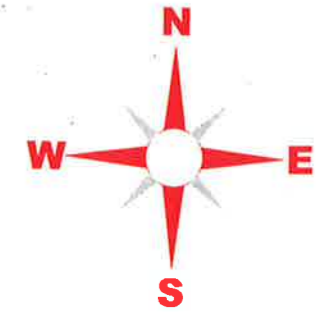

Aksi 14  
- Sez.61  
- Progr. 1+200.00  
- Scala 1:1000  
- Q.Rif. 100.50m

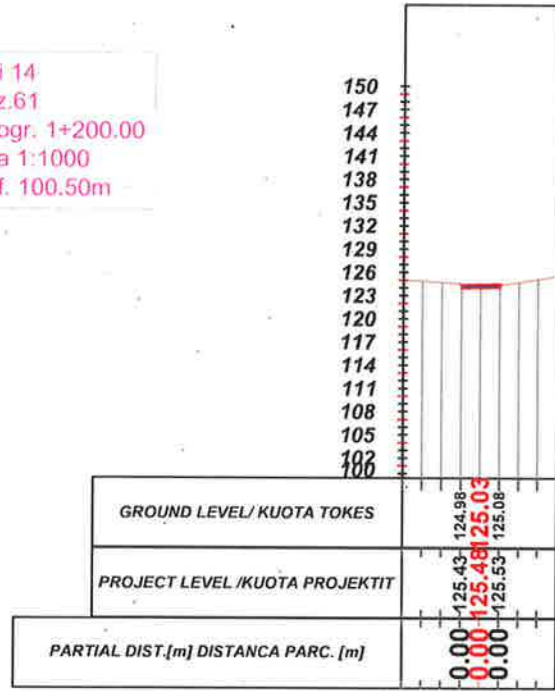

Aksi 14  
- Sez.63  
- Progr. 1+240.00  
- Scala 1:1000  
- Q.Rif. 100.50m

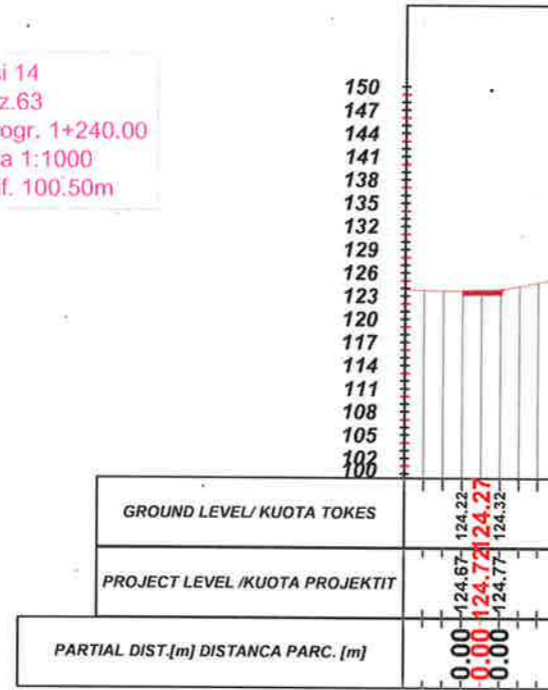

Aksi 14  
- Sez.65  
- Progr. 1+280.00  
- Scala 1:1000  
- Q.Rif. 100.50m

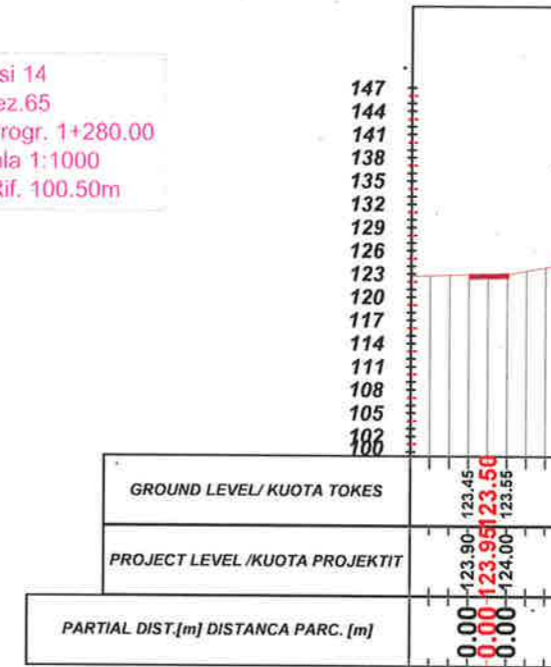

Aksi 14  
- Sez.62  
- Progr. 1+220.00  
- Scala 1:1000  
- Q.Rif. 100.50m

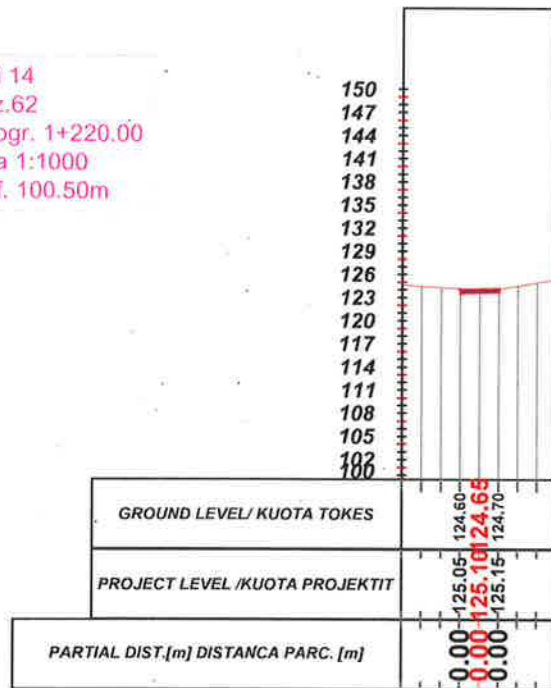

Aksi 14  
- Sez.64  
- Progr. 1+260.00  
- Scala 1:1000  
- Q.Rif. 100.50m

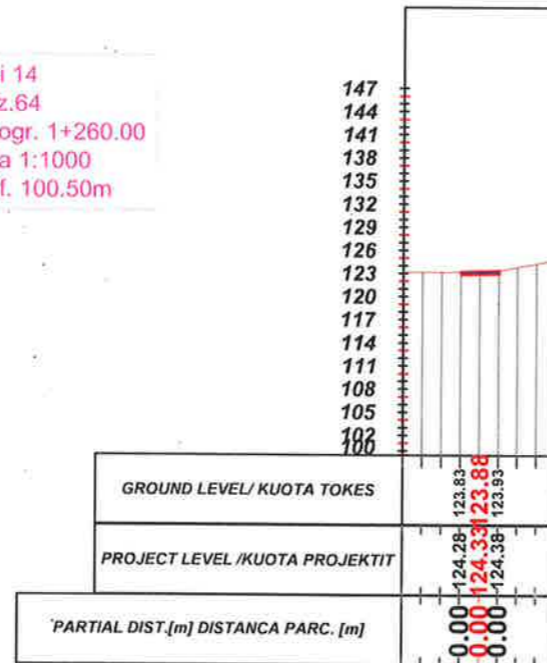

Aksi 14  
- Sez.66  
- Progr. 1+300.00  
- Scala 1:1000  
- Q.Rif. 100.50m

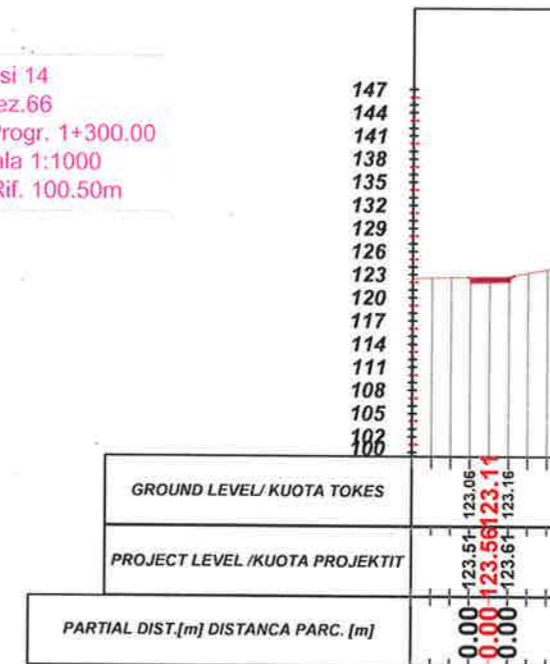

## LEGJENDA

- NIVELETA E RRUGES
- TERRENI NATYRAL



**BASHKIA KAMEZ**

DREJTORIA E PROJEKTEVE DHE INVESTIMEVE  
DEPARTAMENTI I PROJEKTEVE

Dr. e Projekteve e Investimeve	RAMADAN HYSA	
Pergj. Sektori i Projekteve	DENIS PRENÇI	
STAFI TEKNIK	Ing. EMANUELA MËZIU	
PROJEKTUES	Ing. ARTUR ÇAJKA	
	Ing. ALEKS DANI	
	Ark. ESTELA GJYRIQI	

Titulli i Projektit	Faza e Projektit
NDERTIM RRUGËT "PASKUQAN 1 DHE 2"	PROJEKT ZBATIMI
Emertimi i Fletes	Data e Implementimit :
PROFILET TËRTHORE	Shkalta e Vizatimit
	H 1:250
	Fleta Nr.
	01 (80)

# PROFILE TËRTHORE AKSI 14

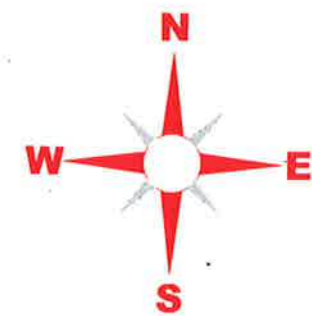

Aksi 14  
- Sez.61  
- Progr. 1+200.00  
- Scala 1:1000  
- Q.Rif. 100.50m

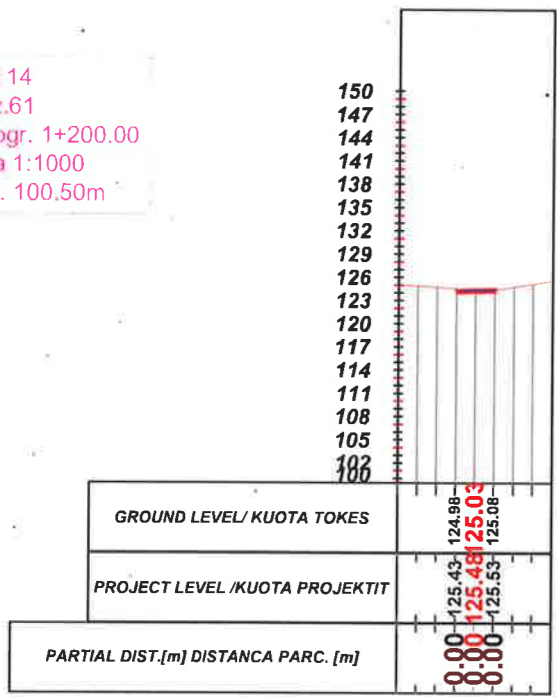

Aksi 14  
- Sez.63  
- Progr. 1+240.00  
- Scala 1:1000  
- Q.Rif. 100.50m

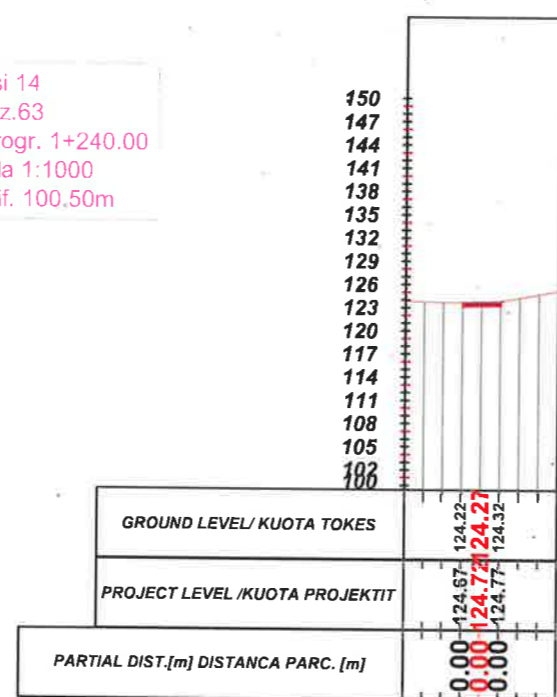

Aksi 14  
- Sez.65  
- Progr. 1+280.00  
- Scala 1:1000  
- Q.Rif. 100.50m

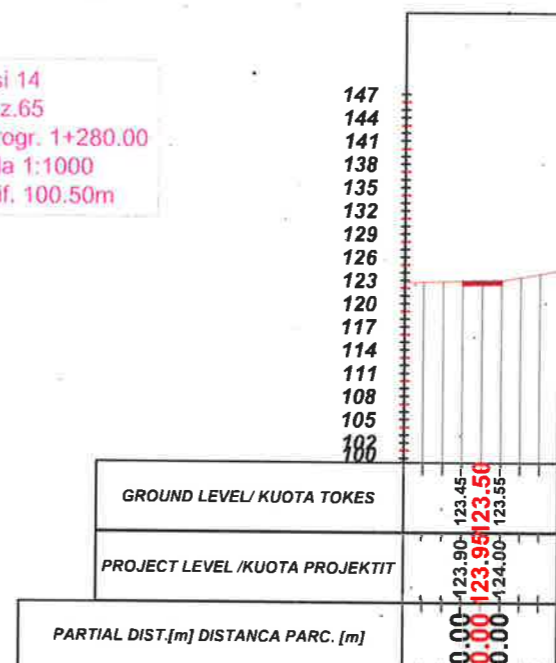

Aksi 14  
- Sez.62  
- Progr. 1+220.00  
- Scala 1:1000  
- Q.Rif. 100.50m

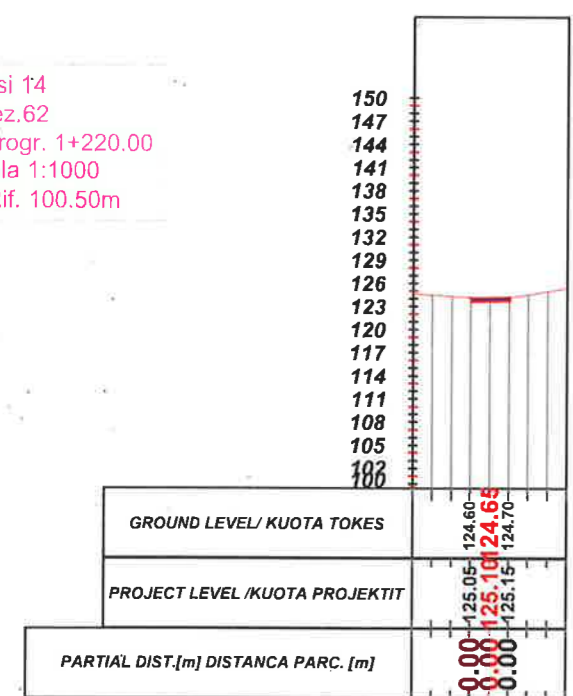

Aksi 14  
- Sez.64  
- Progr. 1+260.00  
- Scala 1:1000  
- Q.Rif. 100.50m

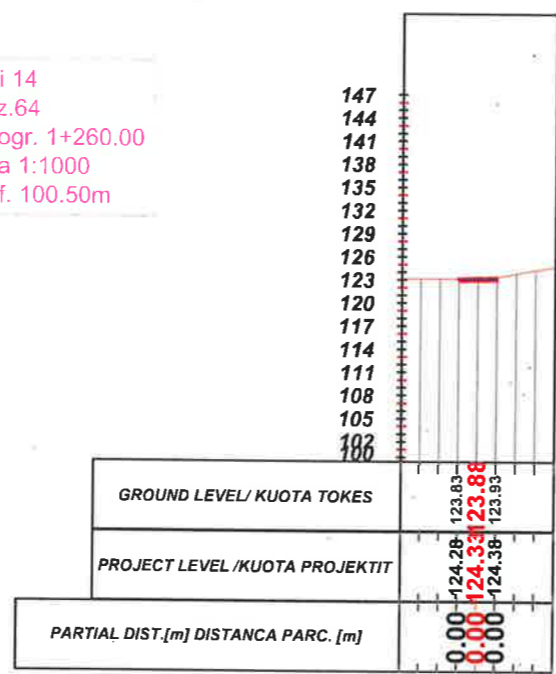

Aksi 14  
- Sez.66  
- Progr. 1+300.00  
- Scala 1:1000  
- Q.Rif. 100.50m

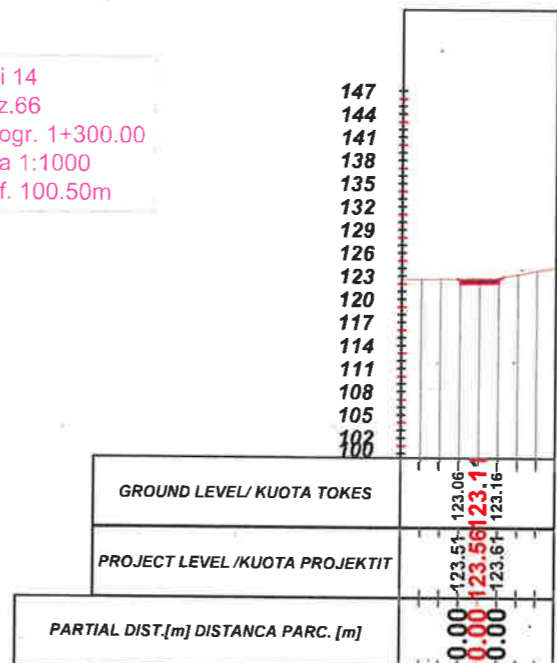

## LEGJENDA

- NIVELETA E RRUGES
- TERRENI NATYRAL



## BASHKIA KAMEZ

DREJTORIA E PROJEKTEVE DHE INVESTIMEVE  
DEPARTAMENTI I PROJEKTEVE

Dr. e Projekteve e Investimeve	RAMADAN HYSA	
Pergj. Sektori i Projekteve	DENIS PRENÇI	
STAFI TEKNIK PROJEKTUES	Ing. EMANUELA MËZIU	
	Ing. ARTUR ÇAJKA	
	Ing. ALEKS DANI	
	Ark. ESTELA GJYRIQI	

Titulli i Projektit	Faza e Projektit
NDERTIM RRUGËT "PASKUQAN I DHE 2"	PROJEKT ZBATIMI
Emertimi i Fletes	Data e Implementimit :
PROFILET TËRTHORE	Shkalla e Vizatimit
	H 1:250
	Fleta Nr.
	01 (81)

# PROFILE TËRTHORE AKSI 14

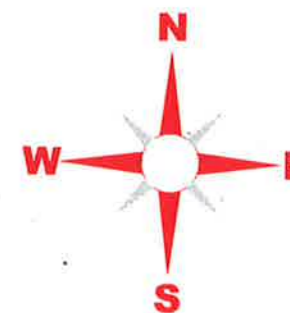

Aksi 14  
- Sez.67  
- Progr. 1+320.00  
Scala 1:1000  
Q.Rif. 97.50m

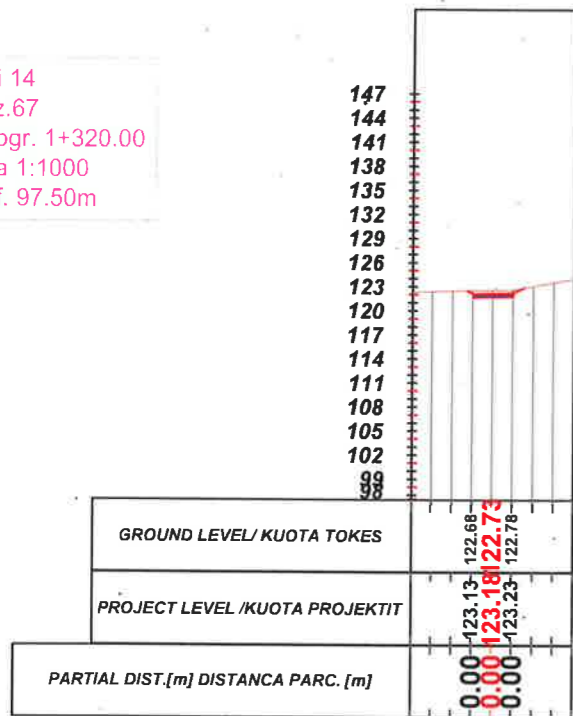

Aksi 14  
- Sez.69  
- Progr. 1+360.00  
Scala 1:1000  
Q.Rif. 97.50m

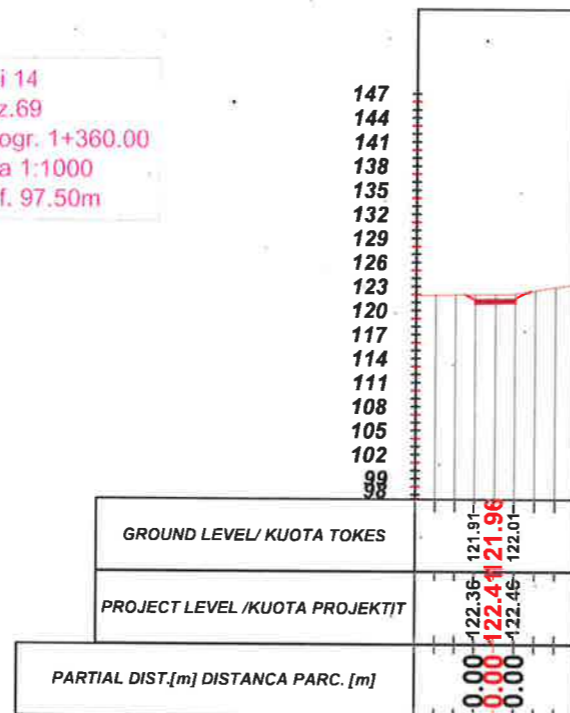

Aksi 14  
- Sez.71  
- Progr. 1+400.00  
Scala 1:1000  
Q.Rif. 97.50m

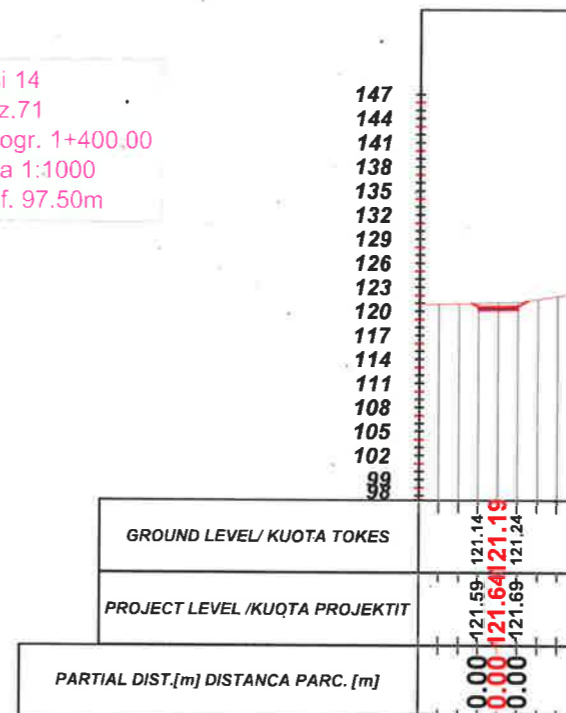

Aksi 14  
- Sez.68  
- Progr. 1+340.00  
Scala 1:1000  
Q.Rif. 97.50m

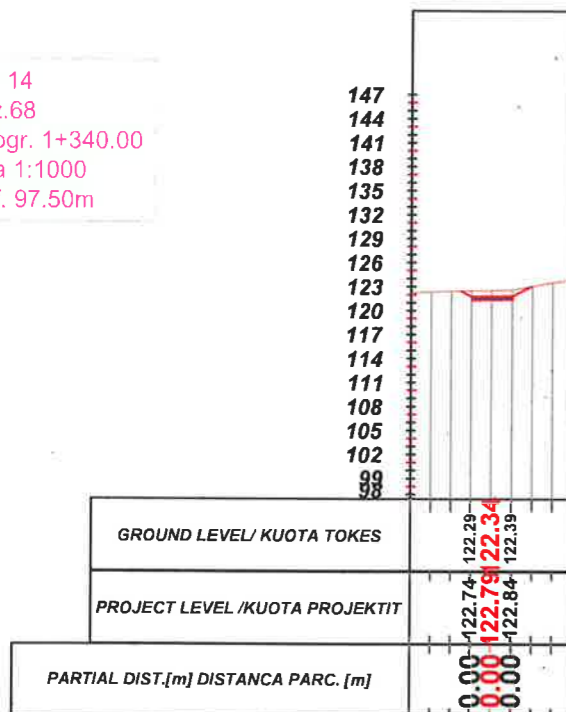

Aksi 14  
- Sez.70  
- Progr. 1+380.00  
Scala 1:1000  
Q.Rif. 97.50m

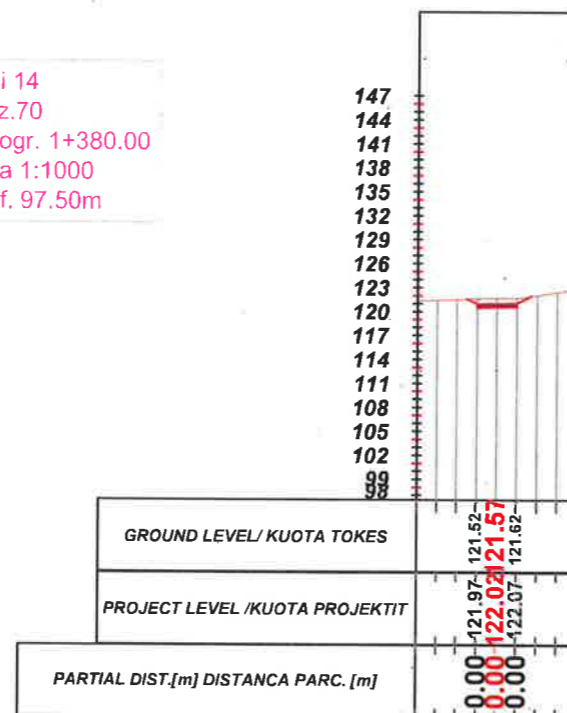

Aksi 14  
- Sez.72  
- Progr. 1+420.00  
Scala 1:1000  
Q.Rif. 97.50m

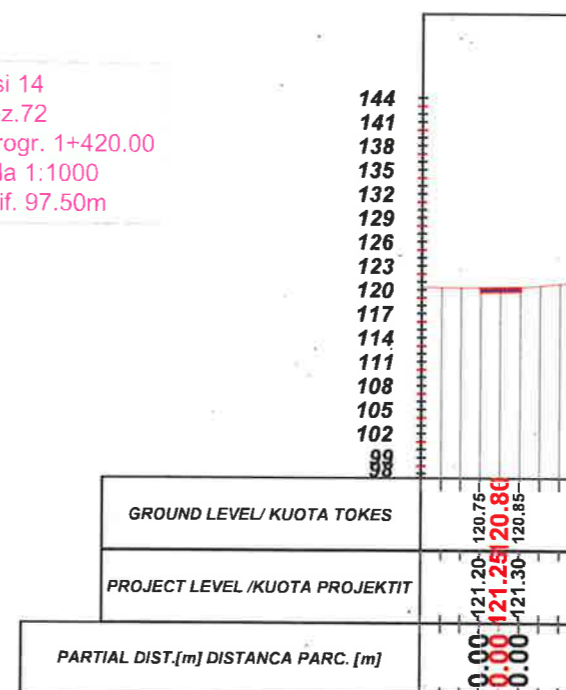

## LEGJENDA

- NIVELETA E RRUGES
- TERRENI NATYRAL



## BASHKIA KAMEZ

DREJTORIA E PROJEKTEVE DHE INVESTIMEVE  
DEPARTAMENTI I PROJEKTEVE

Dr. e Projekteve e Investimeve	RAMADAN HYSA	
Pergj. Sektori i Projekteve	DENIS PRENÇI	
STAFI TEKNIK PROJEKTES	Ing. EMANUELA MËZIU	
	Ing. ARTUR ÇAJKA	
	Ing. ALEKS DANI	
Ark. ESTELA GJYRIQI		

Titulli i Projektit	Faza e Projektit
NDERTIM RRUGËT "PASKUQAN 1 DHE 2"	PROJEKT ZBATIMI
Emertimi i Fletes	Data e Implementimit :
PROFILET TËRTHORE	Shkalla e Vizatimit
	H 1:250
	Fleta Nr.
	01 (82)

# PROFILE TËRTHORE AKSI 14

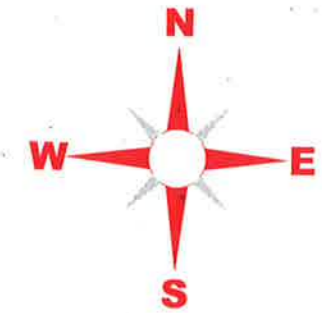

Aksi 14  
- Sez.73  
- Progr. 1+440.00  
Scala 1:1000  
Q.Rif. 97.50m

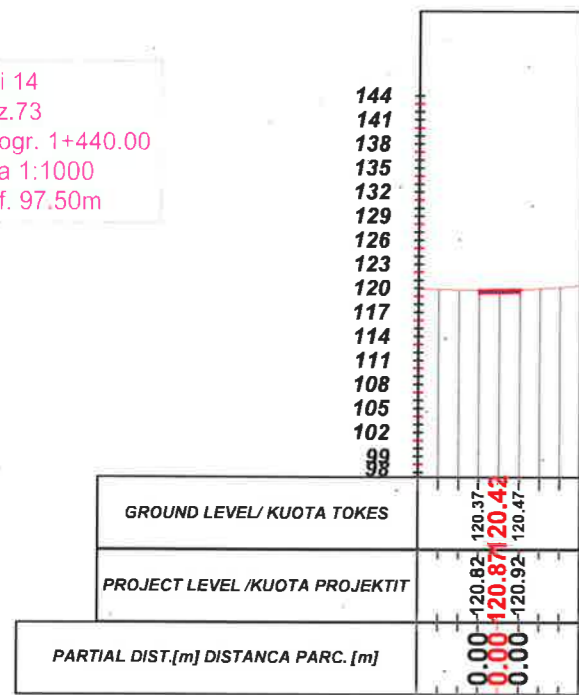

Aksi 14  
- Sez.75  
- Progr. 1+480.00  
Scala 1:1000  
Q.Rif. 94.50m

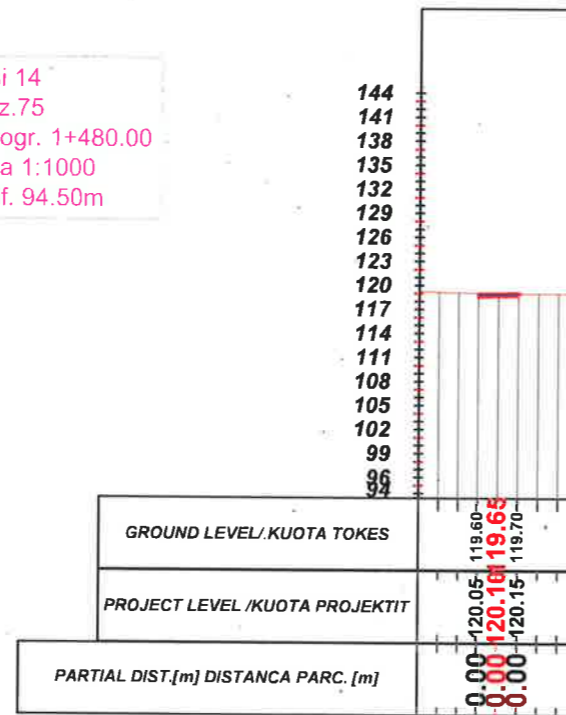

Aksi 14  
- Sez.77  
- Progr. 1+520.00  
Scala 1:1000  
Q.Rif. 94.50m

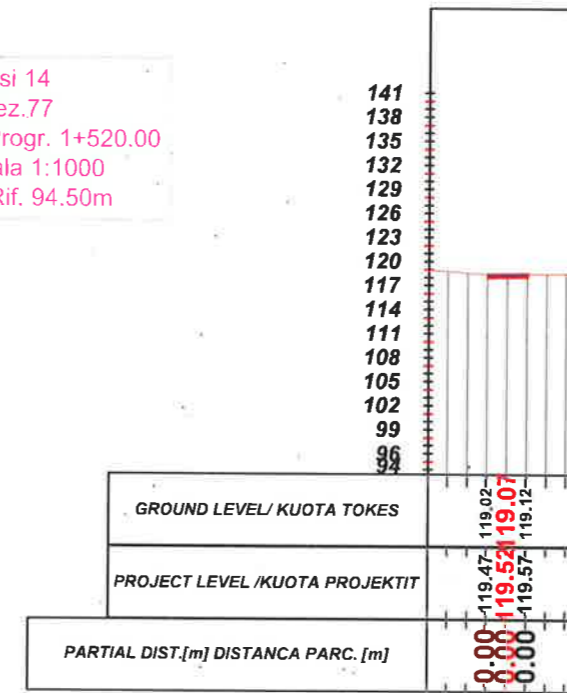

Aksi 14  
- Sez.74  
- Progr. 1+460.00  
Scala 1:1000  
Q.Rif. 94.50m

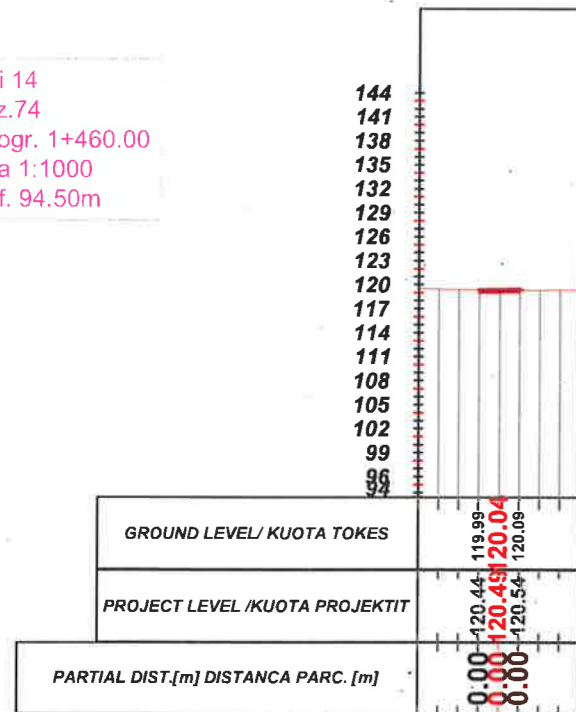

Aksi 14  
- Sez.76  
- Progr. 1+500.00  
Scala 1:1000  
Q.Rif. 94.50m

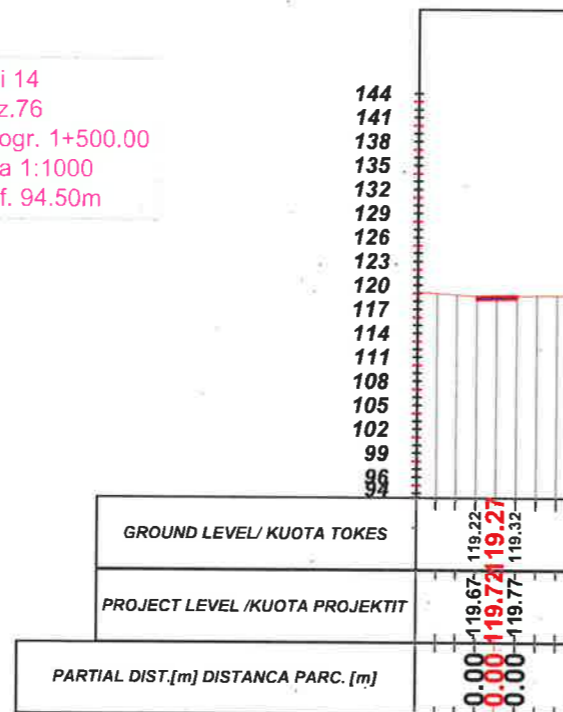

Aksi 14  
- Sez.78  
- Progr. 1+540.00  
Scala 1:1000  
Q.Rif. 94.50m

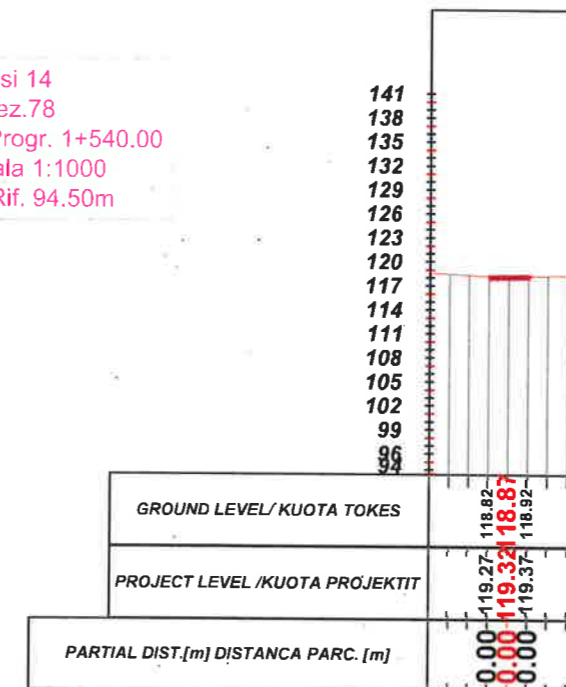

## LEGJENDA

- NIVELETA E RRUGES
- TERRENI NATYRAL



## BASHKIA KAMEZ

DREJTORIA E PROJEKTEVE DHE INVESTIMEVE  
DEPARTAMENTI I PROJEKTEVE

Dr. e Projekteve e Investimeve	RAMADAN HYSA	<i>[Signature]</i>
Pergj. Sektori i Projekteve	DENIS PRENÇI	<i>[Signature]</i>
STAFI TEKNIK PROJEKTES	Ing. EMANUELA MËZIÛ	<i>[Signature]</i>
	Ing. ARTUR ÇAJKA	<i>[Signature]</i>
	Ing. ALEKS DANI	<i>[Signature]</i>
	Ark. ESTELA GJYRIQI	<i>[Signature]</i>

Titulli i Projektit	Faza e Projektit
NDERTIM RRUGËT "PASKUQAN 1 DHE 2"	PROJEKT ZBATIMI
Emertimi i Fletes	Data e Implementimit :
PROFILET TËRTHORE	Shkalla e Vizatimit
	H 1:250
	Fleta Nr.

# PROFILE TËRTHORE AKSI 14

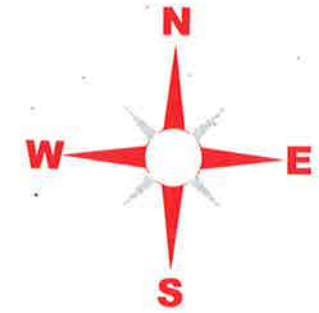

Aksi 14  
- Sez.79  
- Progr. 1+560.00  
Scala 1:1000  
Q.Rif. 94.50m

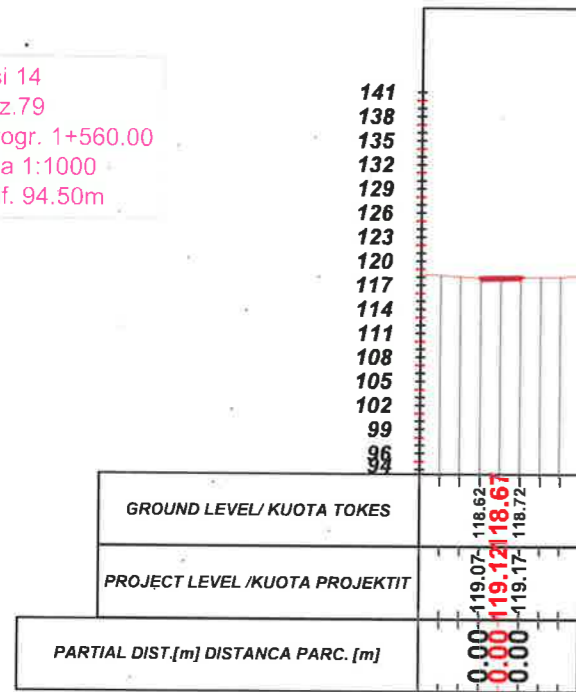

Aksi 14  
- Sez.81  
- Progr. 1+600.00  
Scala 1:1000  
Q.Rif. 94.50m

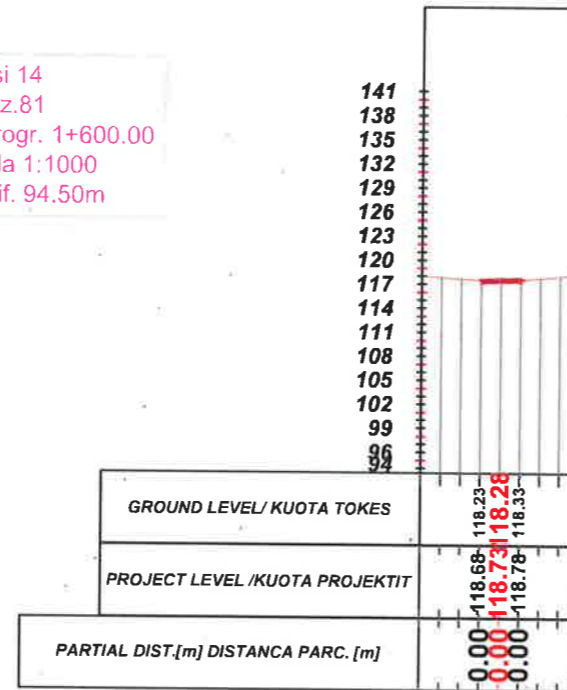

Aksi 14  
- Sez.83  
- Progr. 1+640.00  
Scala 1:1000  
Q.Rif. 94.50m

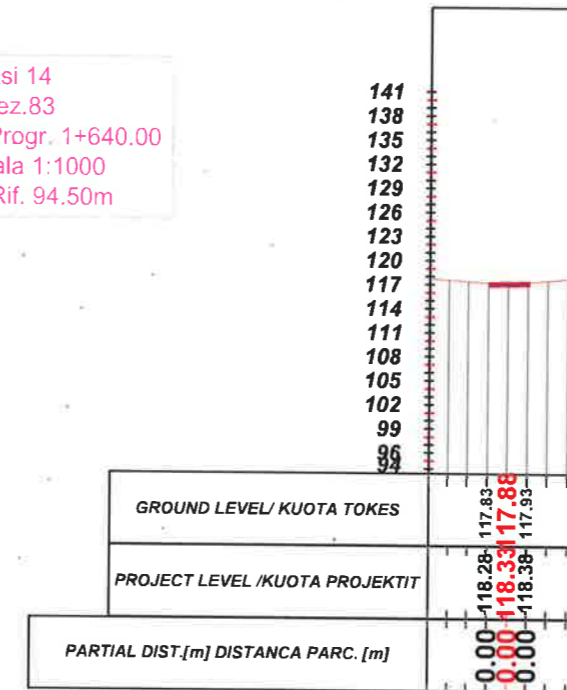

Aksi 14  
- Sez.80  
- Progr. 1+580.00  
Scala 1:1000  
Q.Rif. 94.50m

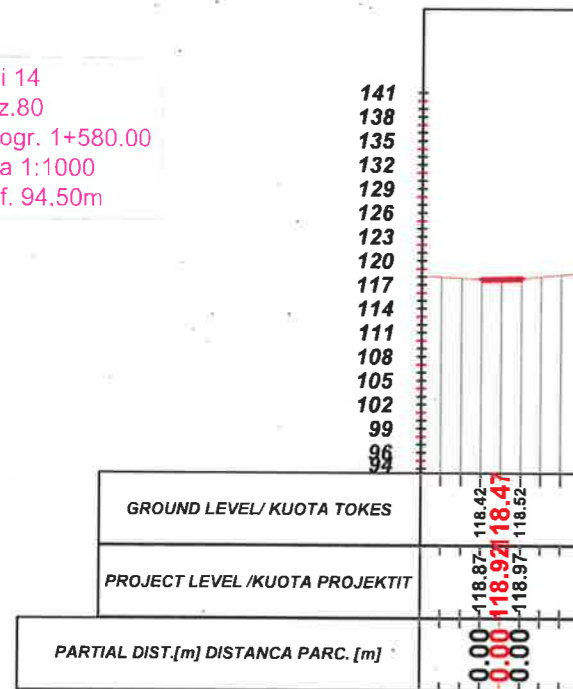

Aksi 14  
- Sez.82  
- Progr. 1+620.00  
Scala 1:1000  
Q.Rif. 94.50m

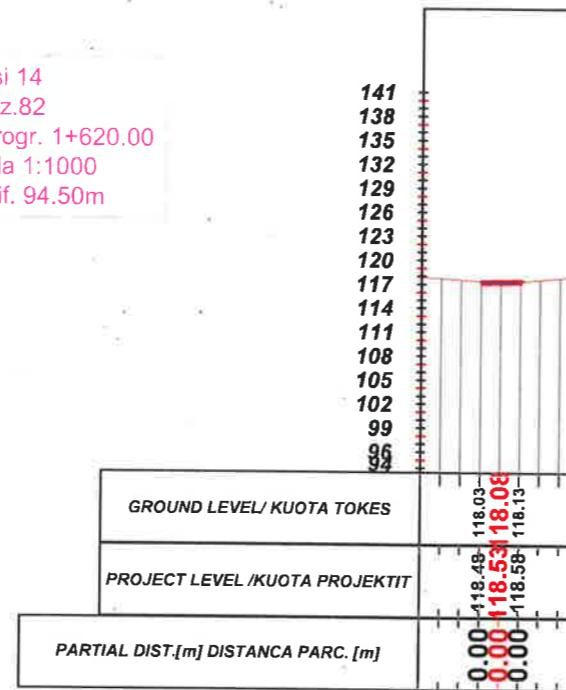

Aksi 14  
- Sez.84  
- Progr. 1+660.00  
Scala 1:1000  
Q.Rif. 94.50m

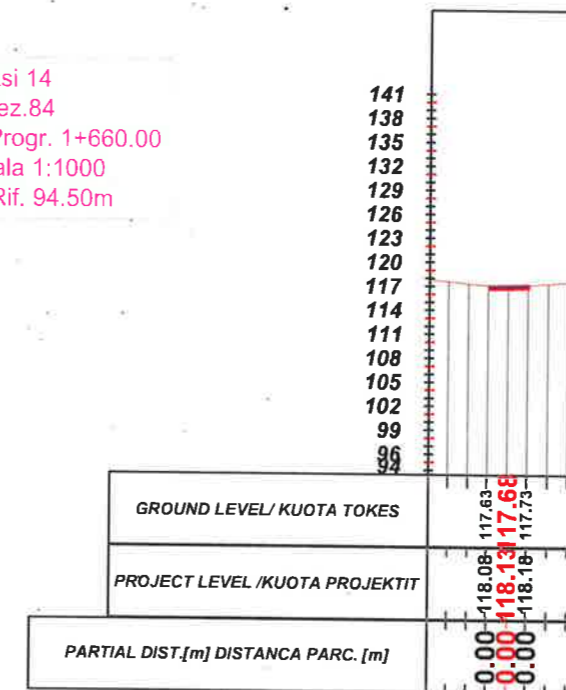

## LEGJENDA

- NIVELETA E RRUGES
- TERRENI NATYRAL



## BASHKIA KAMEZ

DREJTORIA E PROJEKTEVE DHE INVESTIMEVE  
DEPARTAMENTI I PROJEKTEVE

Dr. e Projekteve e Investimeve	RAMADAN HYSA	
Pergj. Sektori i Projekteve	DENIS PRENÇI	
STAFI TEKNIK PROJEKTUES	Ing. EMANUELA MËZIU	
	Ing. ARTUR ÇAJKA	
	Ing. ALEKS DANI	
Ark.	ESTELA GJYRIQI	

Titulli i Projektit	Faza e Projektit
NDERTIM RRUGËT "PASKUQAN 1 DHE 2"	PROJEKT ZBATIMI
Emertimi i Fletes	Data e Implementimit :
PROFLET TËRTHORE	Shkalla e Vizatimit
	H 1:250
	Fleta Nr.
	01 (84)

# PROFILI TËRTHORE AKSI 14

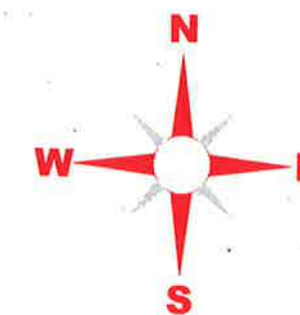

Aksi 14  
- Sez.85  
- Progr. 1+680.00  
Scala 1:1000  
Q.Rif. 94.50m

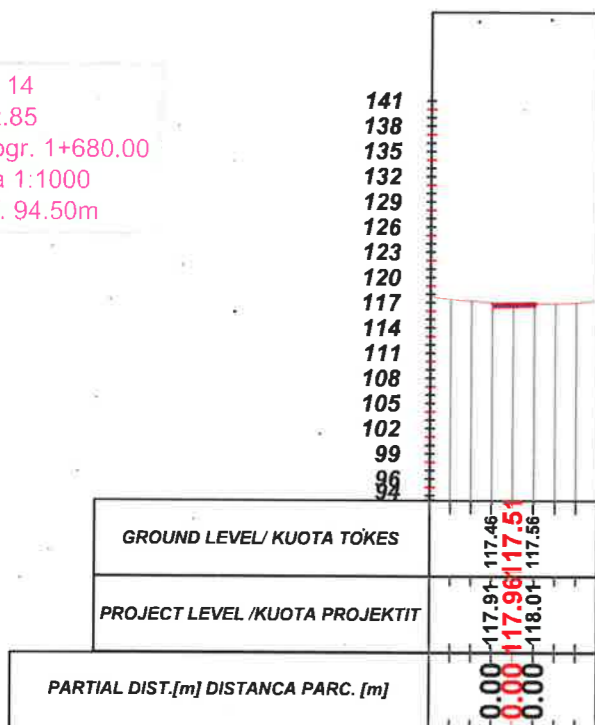

Aksi 14  
- Sez.87  
- Progr. 1+720.00  
Scala 1:1000  
Q.Rif. 94.50m

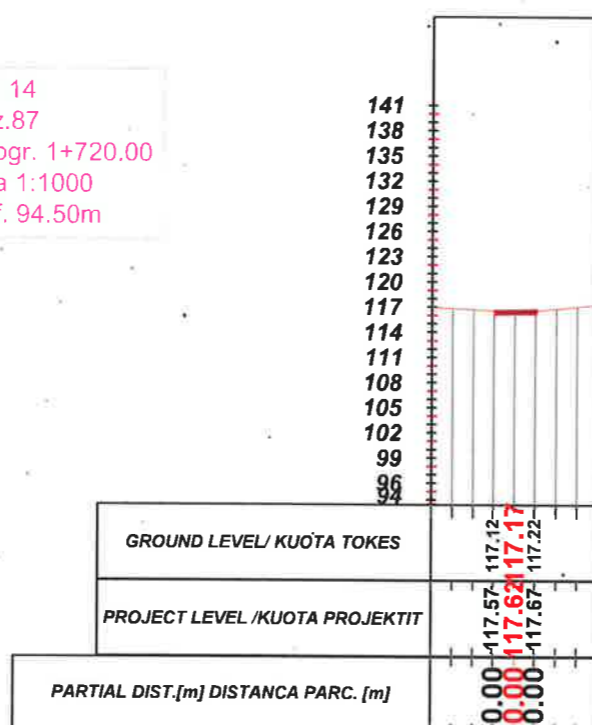

Aksi 14  
- Sez.89  
- Progr. 1+760.00  
Scala 1:1000  
Q.Rif. 91.50m

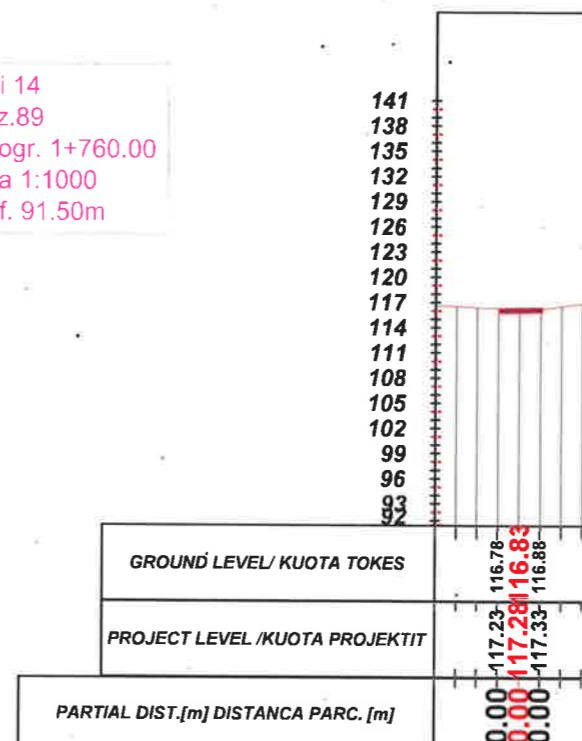

Aksi 14  
- Sez.86  
- Progr. 1+700.00  
Scala 1:1000  
Q.Rif. 94.50m

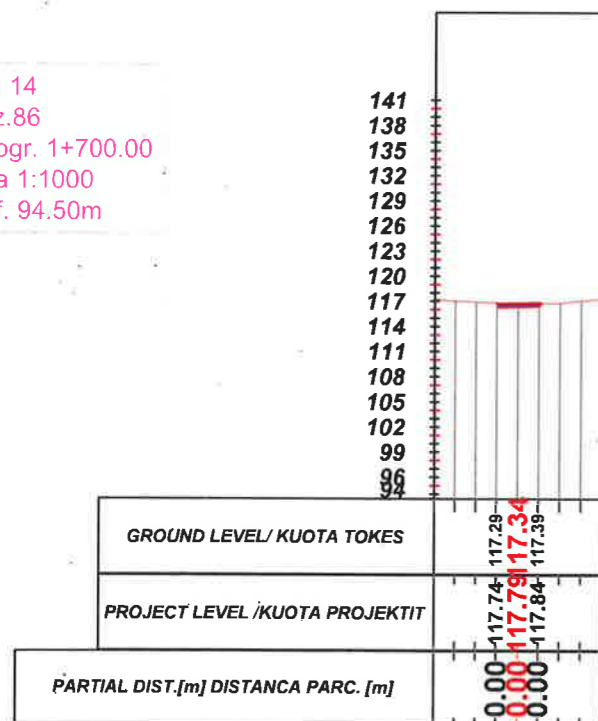

Aksi 14  
- Sez.88  
- Progr. 1+740.00  
Scala 1:1000  
Q.Rif. 91.50m

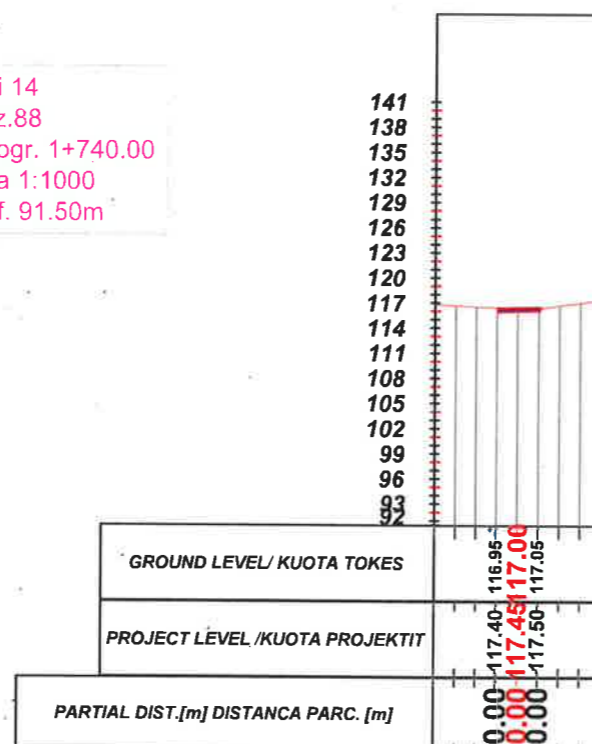

Aksi 14  
- Sez.90  
- Progr. 1+780.00  
Scala 1:1000  
Q.Rif. 91.50m

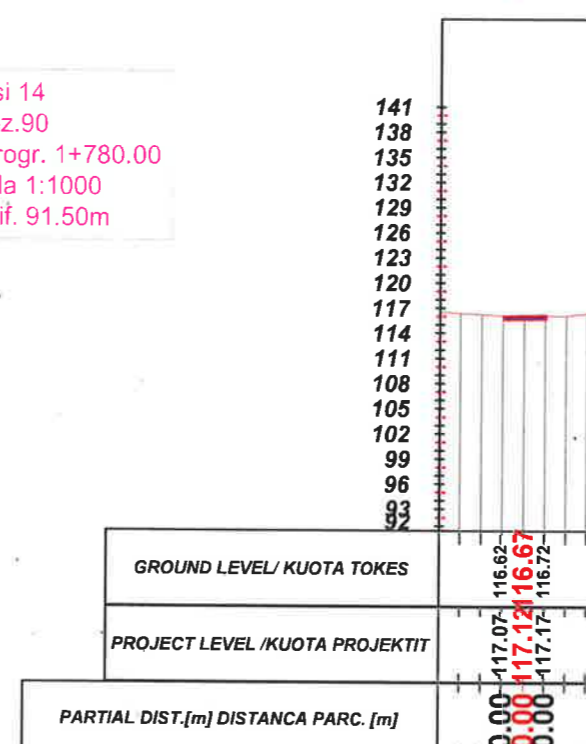

## LEGJENDA

- NIVELETA E RRUGES
- TERRENI NATYRAL



## BASHKIA KAMEZ

DREJTORIA E PROJEKTEVE DHE INVESTIMEVE  
DEPARTAMENTI I PROJEKTEVE

Dr. e Projekteve e Investimeve	RAMADAN HYSA	
Pergj. Sektori i Projekteve	DENIS PRENÇI	
STAFI TEKNIK PROJEKTES	Ing. EMANUELA MËZIU	
	Ing. ARTUR ÇAJKA	
	Ing. ALEKS DANI	
	Ark. ESTELA GJYRIQI	

Titulli i Projektit	Faza e Projektit
NDERTIM RRUGËT "PASKUQAN 1 DHE 2"	PROJEKT ZBATIMI
Emertimi i Fletes	Data e Implementimit :
PROFILIET TËRTHORE	Shkalla e Vizatimit
	H 1:250
	Fleta Nr.
	01 (85)

PROFILE TËRTHORE AKSI 14

Aksi 14  
 - Sez.91  
 - Progr. 1+792.25  
 Scala 1:1000  
 Q.Rif. 91.50m

141  
 138  
 135  
 132  
 129  
 126  
 123  
 120  
 117  
 114  
 111  
 108  
 105  
 102  
 99  
 96  
 93  
 92

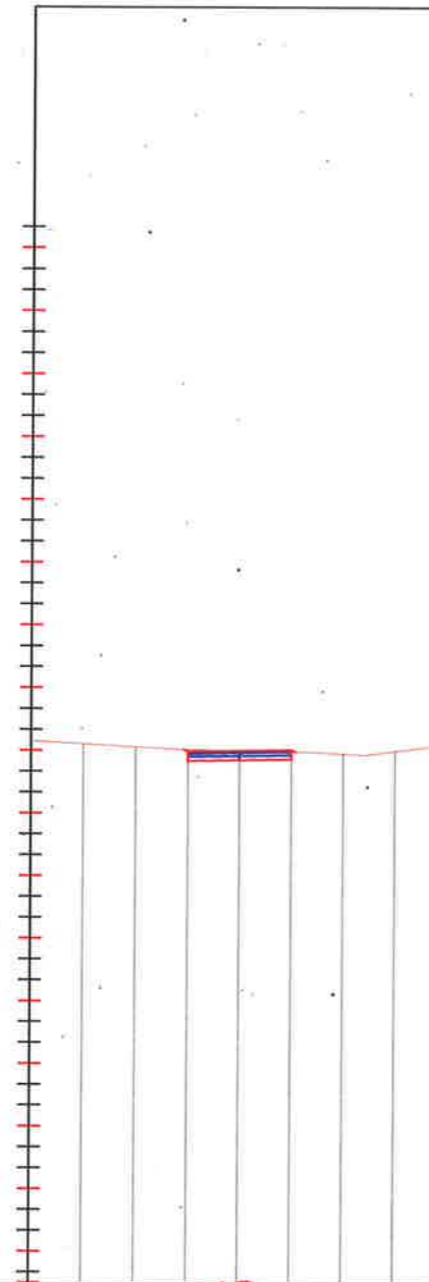

GROUND LEVEL/ KUOTA TOKES

116.51  
 116.56  
 116.61

PROJECT LEVEL /KUOTA PROJEKTIT

116.96  
 117.01  
 117.06

PARTIAL DIST.[m] DISTANCA PARC. [m]

0.00  
 0.00  
 0.00

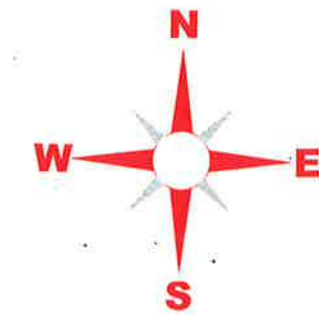

LEGJENDA

- NIVELETA E RRUGES
- TERRENI NATYRAL



BASHKIA KAMEZ

DREJTORIA E PROJEKTEVE DHE INVESTIMEVE  
 DEPARTAMENTI I PROJEKTEVE

Dr. e Projekteve e Investimeve	RAMADAN HYSA	
Pergj. Sektori i Projekteve	DENIS PRENÇI	
STAFI TEKNIK PROJEKTUES	Ing. EMANUELA MËZIU	
	Ing. ARTUR ÇAJKA	
	Ing. ALEKS DANI	
	Ark. ESTELA GJYRIQI	

Titulli i Projektit	Faza e Projektit
NDERTIM RRUGËT "PASKUQAN 1 DHE 2"	PROJEKT ZBATIMI
Emertimi i Fletes	Data e Implementimit :
PROFILET TËRTHORE	Shkalla e Vizatimit
	H 1:250
	Fleta Nr.
	01 (86)

# PROFILE TËRTHORE AKSI 15

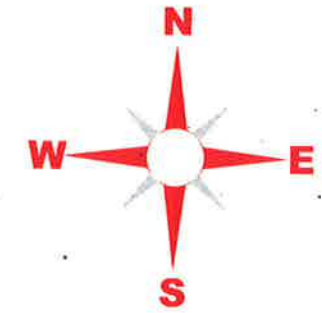

Aksi 15  
- Sez.1  
- Progr. 0+000.00  
Scala 1:1000  
Q.Rif. 121.50m

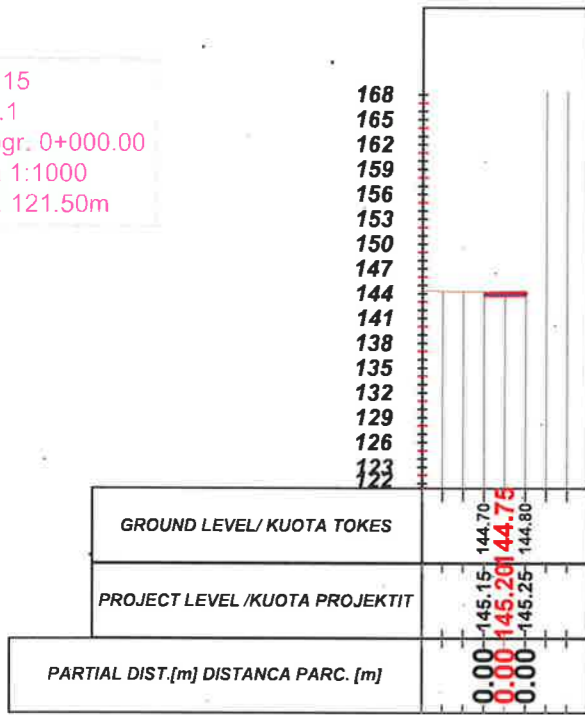

Aksi 15  
- Sez.3  
- Progr. 0+040.00  
Scala 1:1000  
Q.Rif. 121.50m

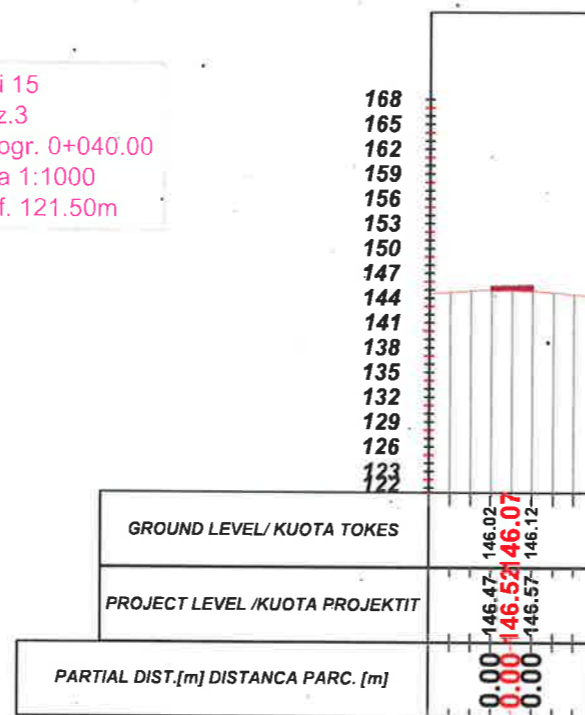

Aksi 15  
- Sez.5  
- Progr. 0+080.00  
Scala 1:1000  
Q.Rif. 121.50m

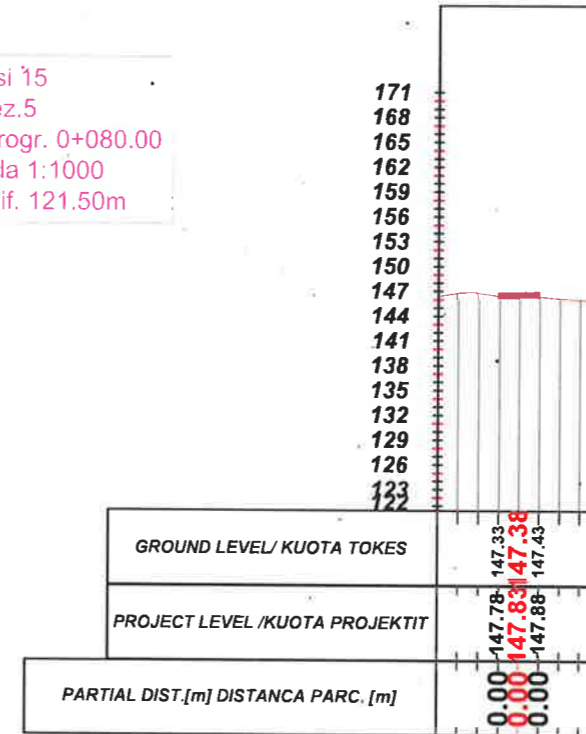

Aksi 15  
- Sez.2  
- Progr. 0+020.00  
Scala 1:1000  
Q.Rif. 121.50m

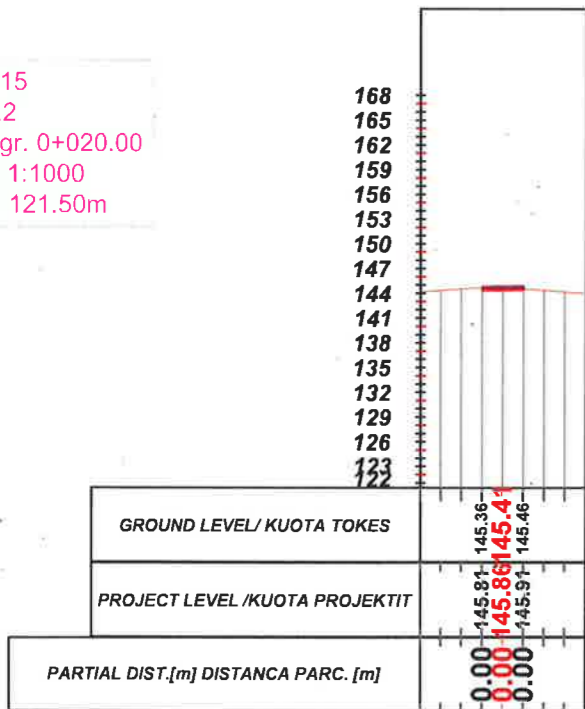

Aksi 15  
- Sez.4  
- Progr. 0+060.00  
Scala 1:1000  
Q.Rif. 121.50m

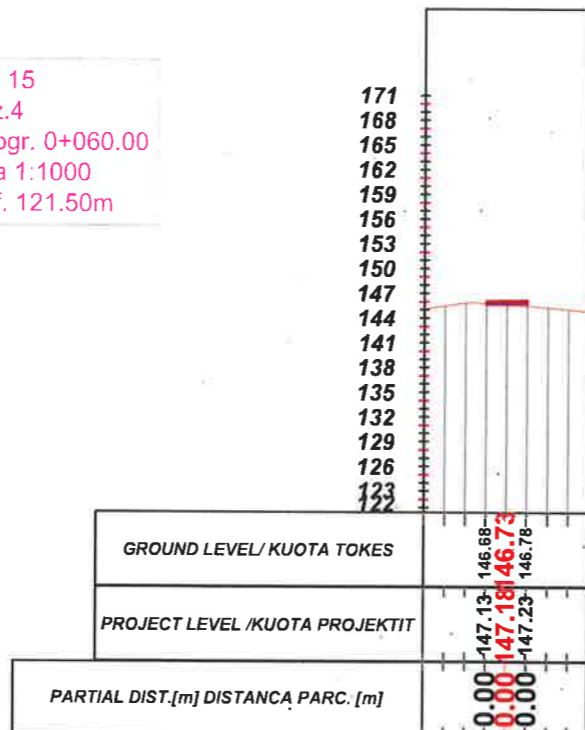

Aksi 15  
- Sez.6  
- Progr. 0+100.00  
Scala 1:1000  
Q.Rif. 124.50m

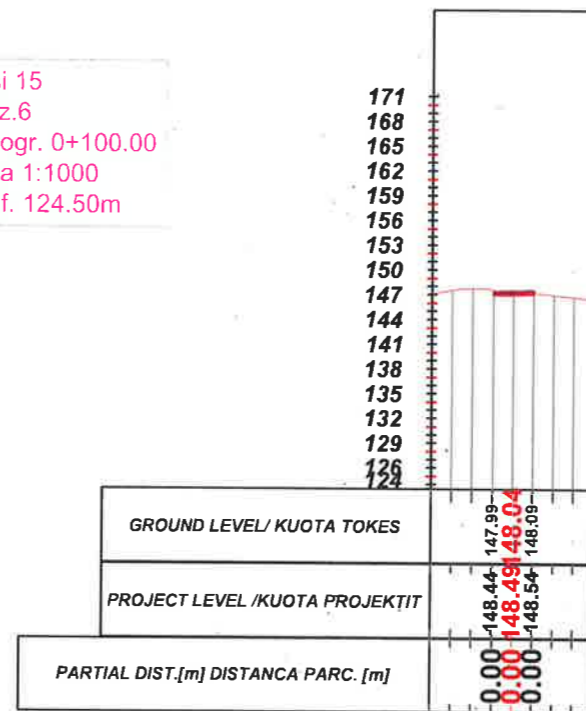

## LEGJENDA

- NIVELETA E RRUGES
- TERRENI NATYRAL



## BASHKIA KAMEZ

DREJTORIA E PROJEKTEVE DHE INVESTIMEVE  
DEPARTAMENTI I PROJEKTEVE

Dr. e Projekteve e Investimeve	RAMADAN HYSA	
Pergj. Sektori i Projekteve	DENIS PRENÇI	
STAFI TEKNIK PROJEKTUES	Ing. EMANUELA MËZIU	
	Ing. ARTUR ÇAJKA	
	Ing. ALEKS DANI	
	Ark. ESTELA GJYRIQI	

Titulli i Projektit	Faza e Projektit
NDERTIM RRUGËT "PASKUQAN 1 DHE 2"	PROJEKT ZBATIMI
Emertimi i Fletes	Data e Implementimit:
PROFILET TËRTHORE	Shkalla e Vizatimit
	H 1:250
	Fleta Nr.
	01 (87)

# PROFILE TËRTHORE AKSI 15

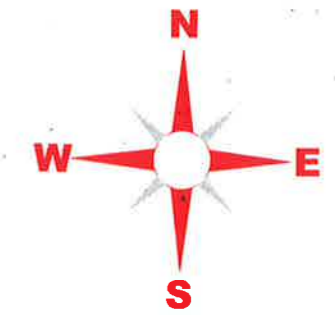

Aksi 15  
- Sez.7  
- Progr. 0+120.00  
Scala 1:1000  
Q.Rif. 124.50m

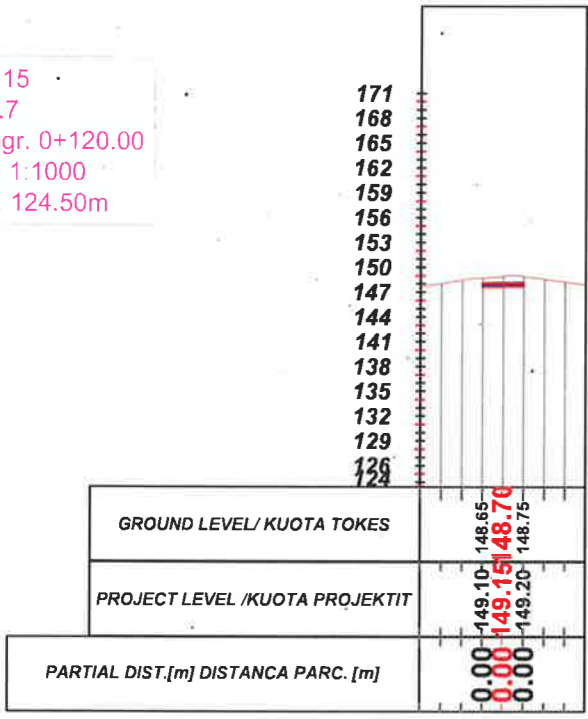

Aksi 15  
- Sez.9  
- Progr. 0+160.00  
Scala 1:1000  
Q.Rif. 124.50m

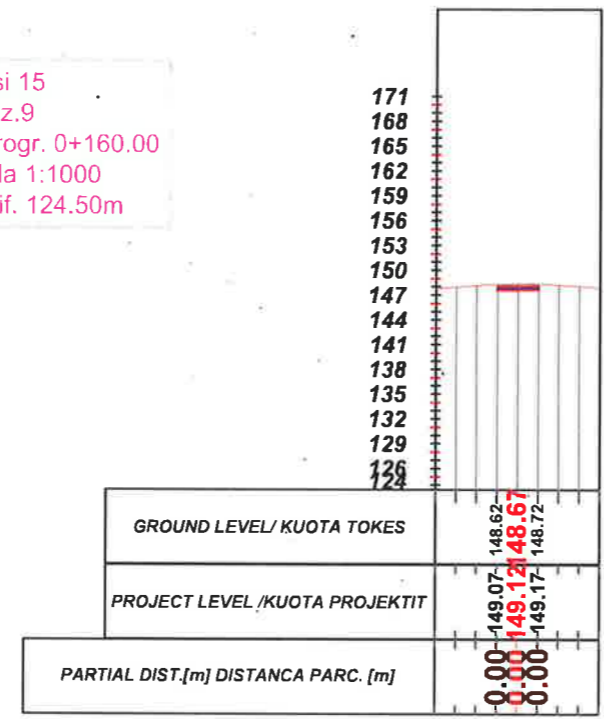

Aksi 15  
- Sez.11  
- Progr. 0+200.00  
Scala 1:1000  
Q.Rif. 124.50m

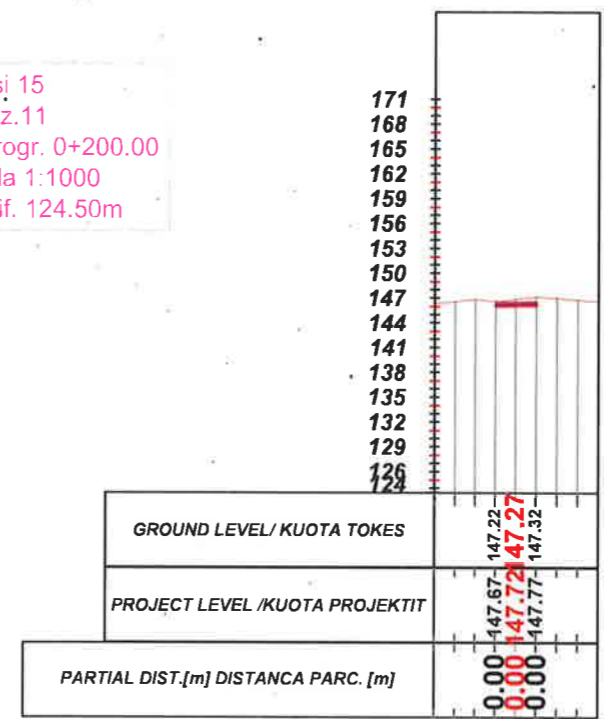

Aksi 15  
- Sez.8  
- Progr. 0+140.00  
Scala 1:1000  
Q.Rif. 124.50m

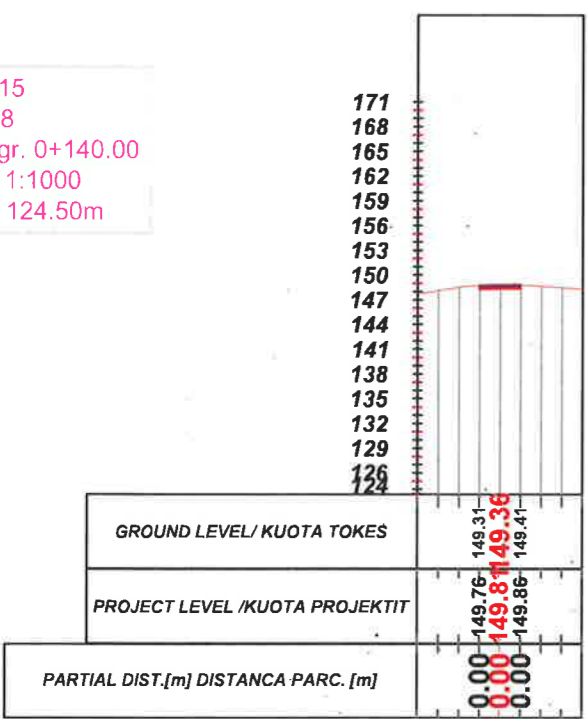

Aksi 15  
- Sez.10  
- Progr. 0+180.00  
Scala 1:1000  
Q.Rif. 124.50m

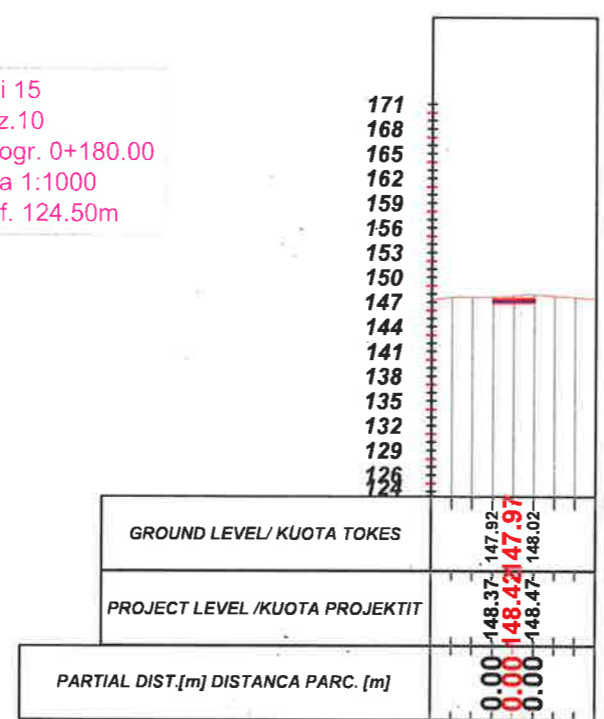

Aksi 15  
- Sez.12  
- Progr. 0+220.00  
Scala 1:1000  
Q.Rif. 121.50m

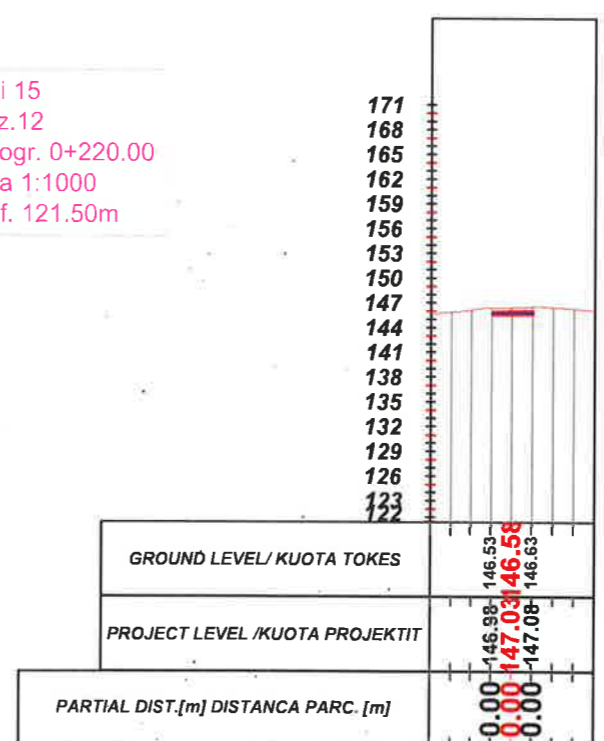

## LEGJENDA

- NIVELETA E RRUGES
- TERRENI NATYRAL



## BASHKIA KAMEZ

DREJTORIA E PROJEKTEVE DHE INVESTIMEVE  
DEPARTAMENTI I PROJEKTEVE

Dr. e Projekteve e Investimeve	RAMADAN HYSA	
Pergj. Sektori i Projekteve	DENIS PRENÇI	
STAFI TEKNIK PROJEKTUES	Ing. EMANUELA MËZIU	
	Ing. ARTUR ÇAJKA	
	Ing. ALEKS DANI	
	Ark. ESTELA GJYRIQI	

Titulli i Projektit	Faza e Projektit
NDERTIM RRUGËT "PASKUQAN 1 DHE 2"	PROJEKT ZBATIMI
Emertimi i Fletes	Data e Implementimit :
PROFLET TËRTHORE.	Shkalla e Vizatimit H 1:250
	Fleta Nr. 01 (88)

# PROFILE TËRTHORE AKSI 15

Aksi 15  
- Sez.13  
- Progr. 0+240.00  
Scala 1:1000  
Q.Rif. 121.50m

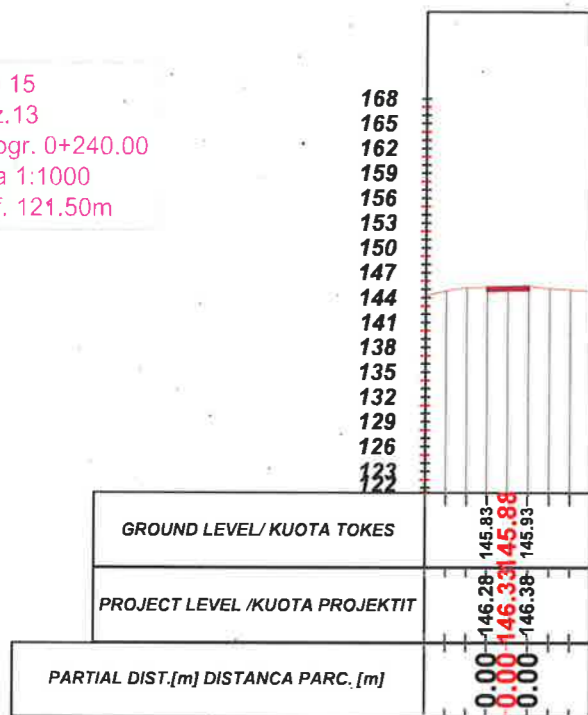

Aksi 15  
- Sez.15  
- Progr. 0+280.00  
Scala 1:1000  
Q.Rif. 118.50m

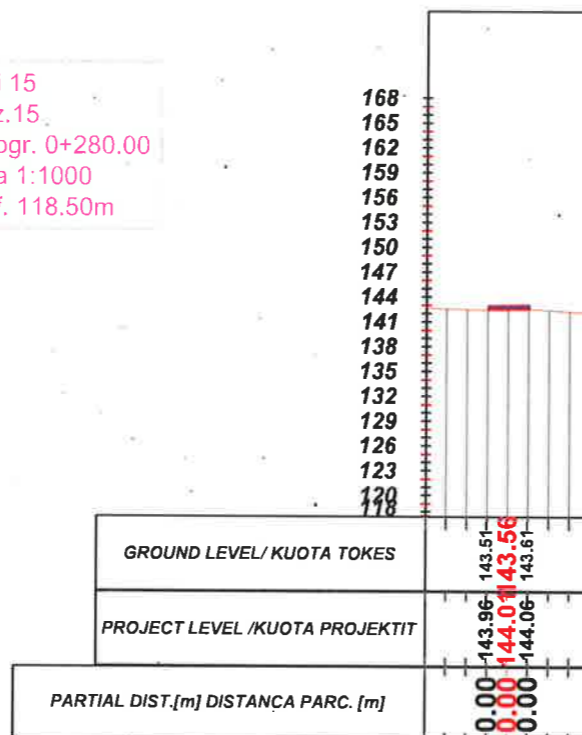

Aksi 15  
- Sez.17  
- Progr. 0+320.00  
Scala 1:1000  
Q.Rif. 118.50m

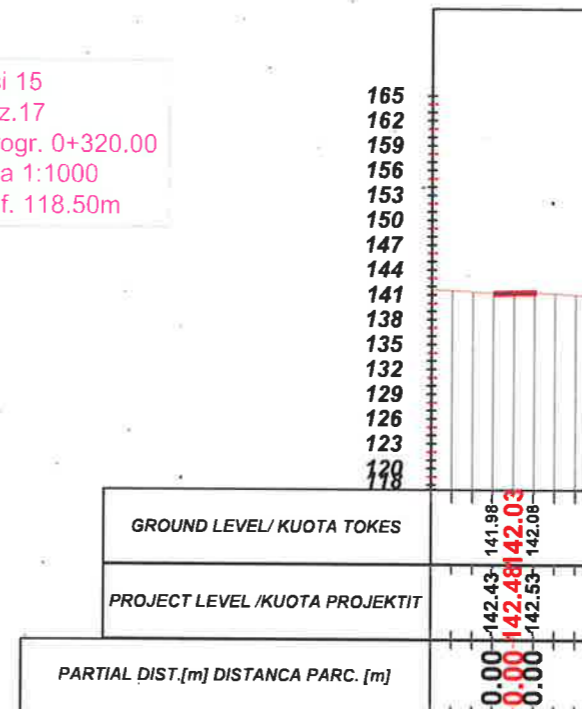

Aksi 15  
- Sez.14  
- Progr. 0+260.00  
Scala 1:1000  
Q.Rif. 121.50m

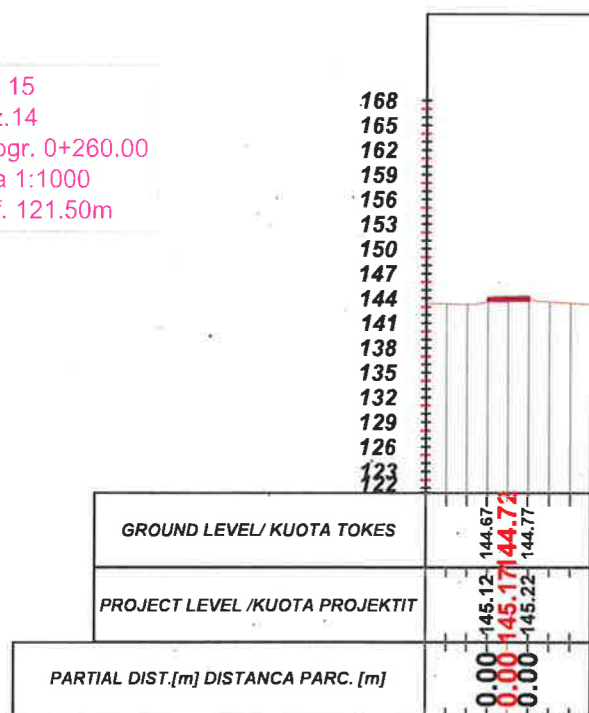

Aksi 15  
- Sez.16  
- Progr. 0+300.00  
Scala 1:1000  
Q.Rif. 118.50m

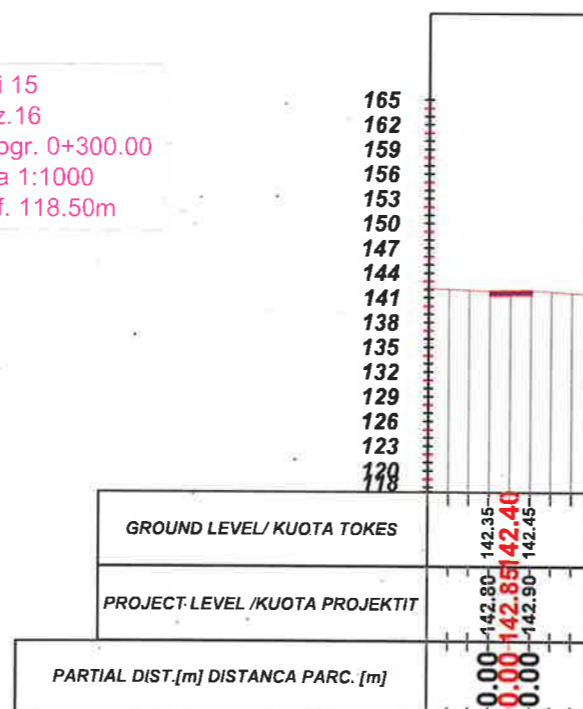

Aksi 15  
- Sez.18  
- Progr. 0+340.00  
Scala 1:1000  
Q.Rif. 118.50m

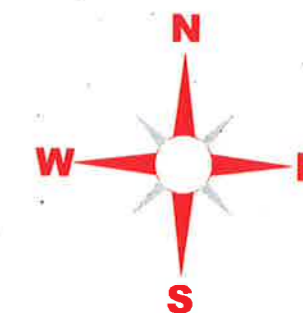
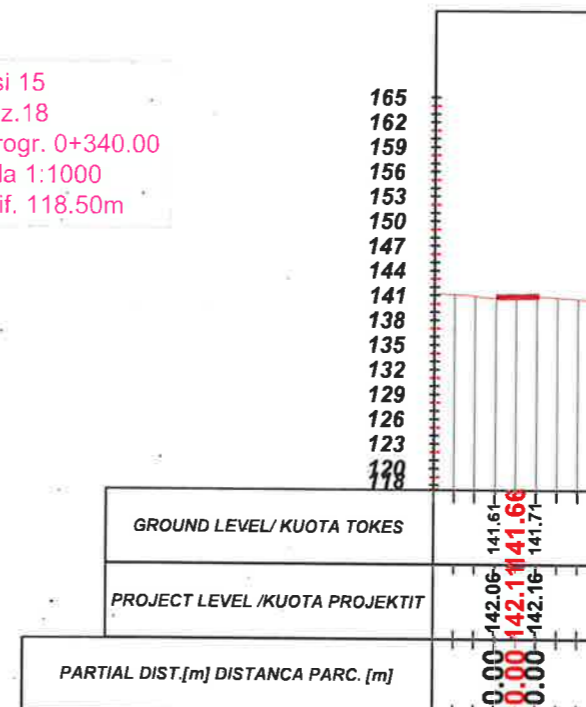

## LEGJENDA

- NIVELETA E RRUGES
- TERRENI NATYRAL



## BASHKIA KAMEZ

DREJTORIA E PROJEKTEVE DHE INVESTIMEVE  
DEPARTAMENTI I PROJEKTEVE

Dr. e Projekteve e Investimeve	RAMADAN HYSA	
Pergj. Sektori i Projekteve	DENIS PRENÇI	
STAFI TEKNIK PROJEKTUES	Ing. EMANUELA MËZIU	
	Ing. ARTUR ÇAJKA	
	Ing. ALEKS DANI	
	Ark. ESTELA GJYRIQI	

Titulli i Projektit	Faza e Projektit
NDERTIM RRUGËT "PASKUQAN 1 DHE 2"	PROJEKT ZBATIMI
Emertimi i Fietes	Data e Implementimit :
PROFILJET TËRTHORE	Shkalla e Vizatimit
	H 1:250
	Fleta Nr.
	01 (89)

# PROFILE TËRTHORE AKSI 15

Aksi 15  
- Sez.19  
- Progr. 0+360.00  
Scala 1:1000  
Q.Rif. 115.50m

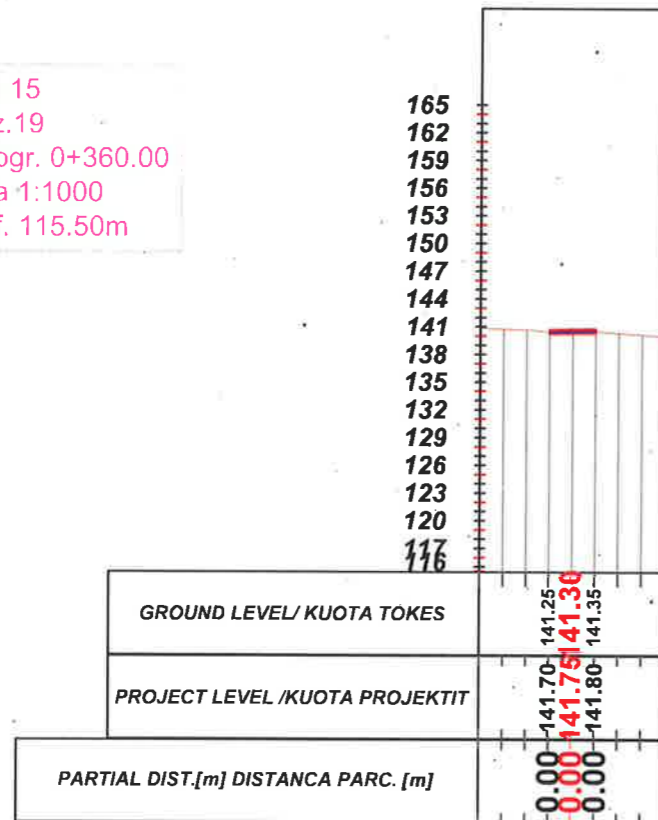

Aksi 15  
- Sez.21  
- Progr. 0+400.00  
Scala 1:1000  
Q.Rif. 115.50m

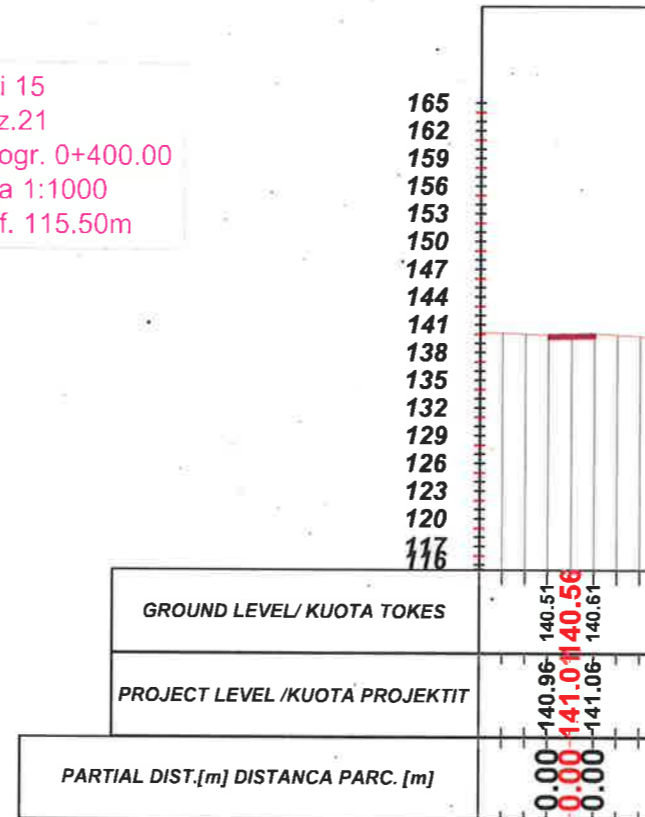

Aksi 15  
- Sez.20  
- Progr. 0+380.00  
Scala 1:1000  
Q.Rif. 115.50m

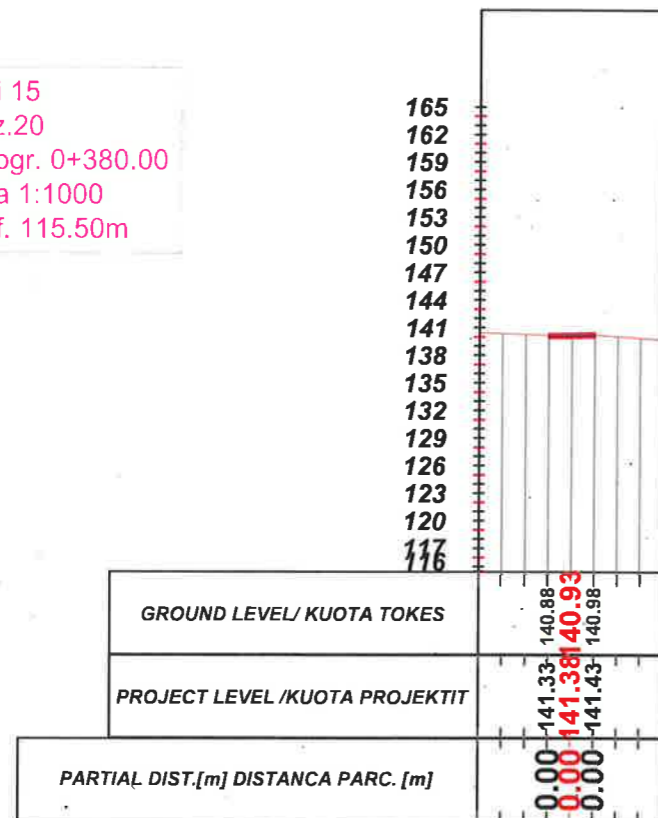

Aksi 15  
- Sez.22  
- Progr. 0+400.87  
Scala 1:1000  
Q.Rif. 115.50m

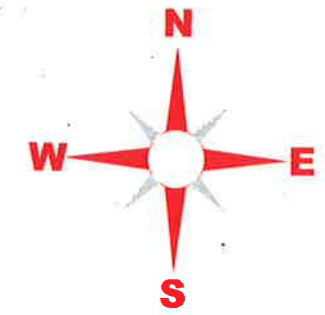
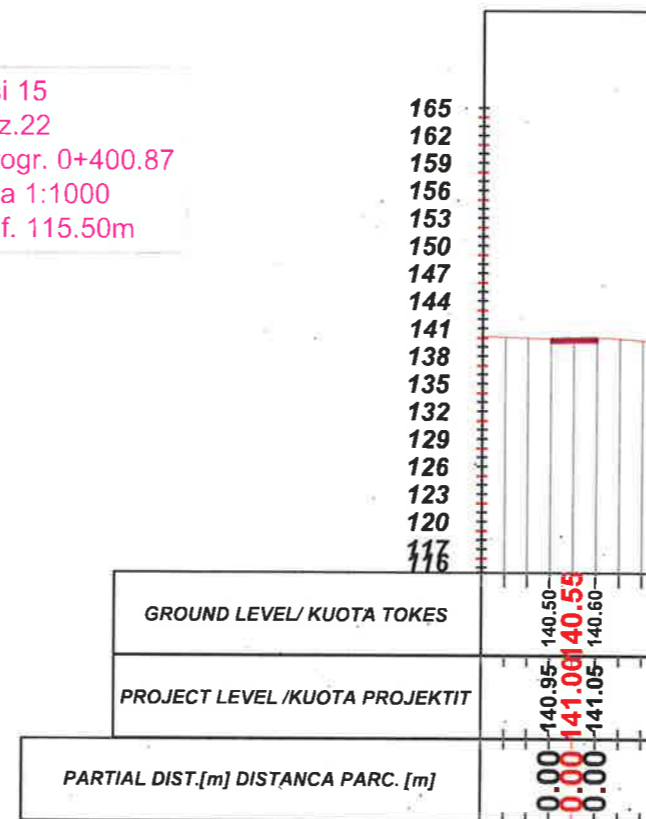

## LEGJENDA

- NIVELETA E RRUGES
- TERRENI NATYRAL



## BASHKIA KAMEZ

DREJTORIA E PROJEKTEVE DHE INVESTIMEVE  
DEPARTAMENTI I PROJEKTEVE

Dr. e Projekteve e Investimeve	RAMADAN HYSA	
Pergj. Sektori i Projekteve	DENIS PRENÇI	
STAFI TEKNIK PROJEKTUES	Ing. EMANUELA MËZIU	
	Ing. ARTUR ÇAJKA	
	Ing. ALEKS DANI	
	Ark. ESTELA GJYRIQI	

Titulli i Projektit	Faza e Projektit
NDERTIM RRUGËT "PASKUQAN 1 DHE 2"	PROJEKT ZBATIMI
Emertimi i Fletes	Data e Implementimit
PROFILET TËRTHORE	Shkalla e Vizatimit
	H 1:250
	Fleta Nr.
	01 (90)

# PROFILE TËRTHORE AKSI 16

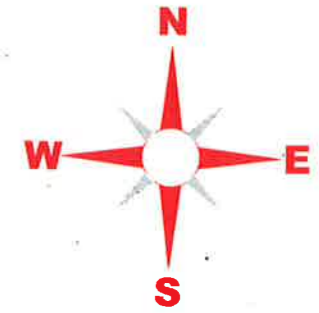

Aksi 16  
- Sez.1  
- Progr. 0+000.00  
Scala 1:1000  
Q.Rif. 97.50m

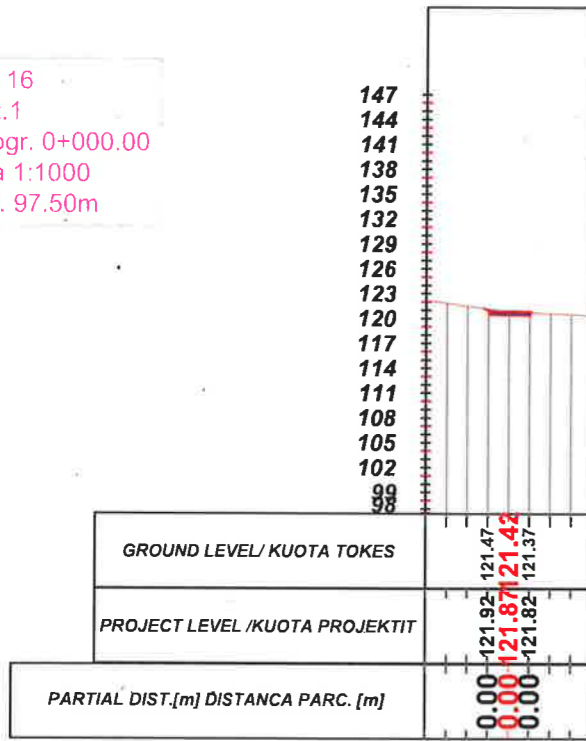

Aksi 16  
- Sez.3  
- Progr. 0+040.00  
Scala 1:1000  
Q.Rif. 94.50m

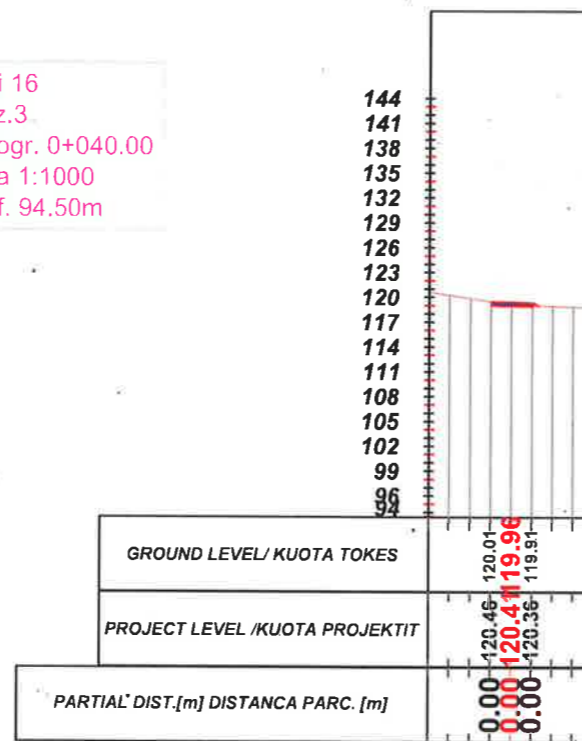

Aksi 16  
- Sez.5  
- Progr. 0+080.00  
Scala 1:1000  
Q.Rif. 94.50m

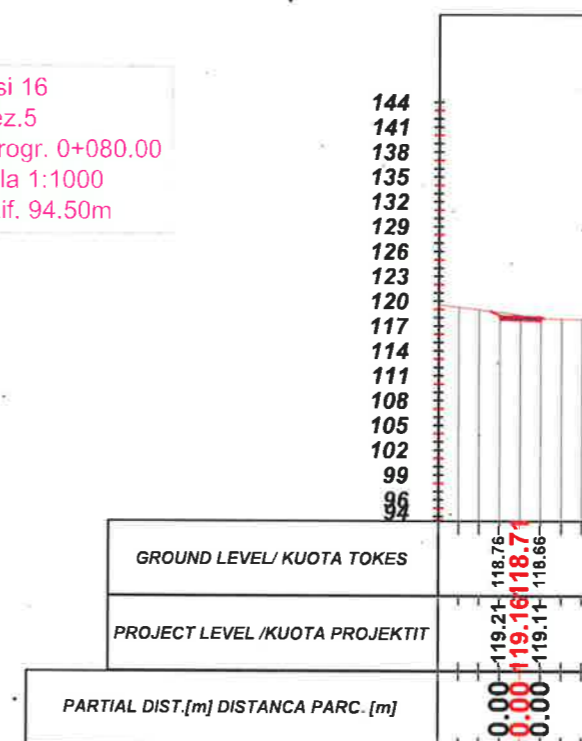

Aksi 16  
- Sez.2  
- Progr. 0+020.00  
Scala 1:1000  
Q.Rif. 97.50m

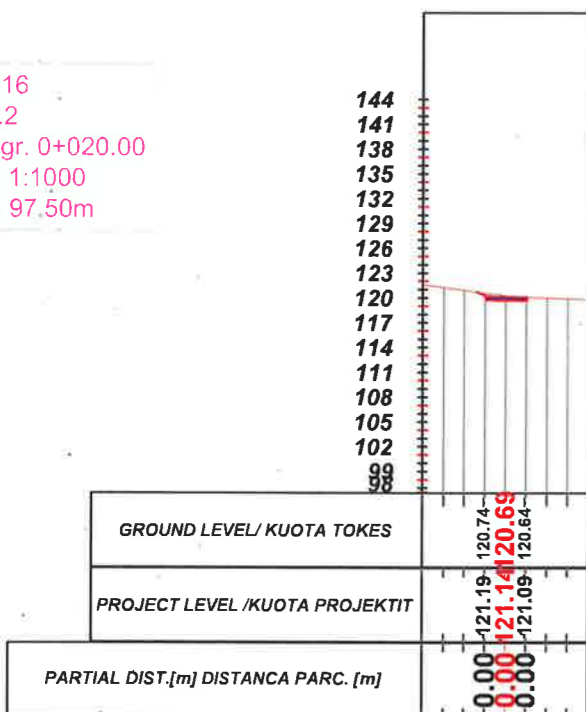

Aksi 16  
- Sez.4  
- Progr. 0+060.00  
Scala 1:1000  
Q.Rif. 94.50m

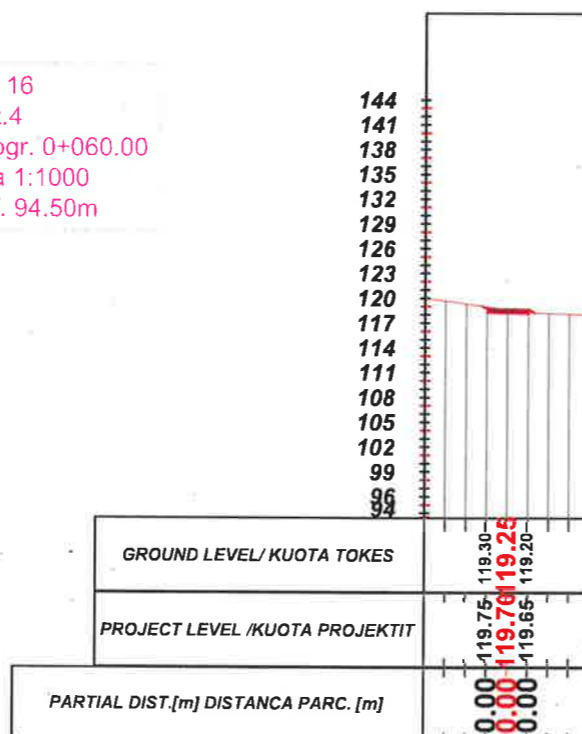

Aksi 16  
- Sez.6  
- Progr. 0+093.89  
Scala 1:1000  
Q.Rif. 94.50m

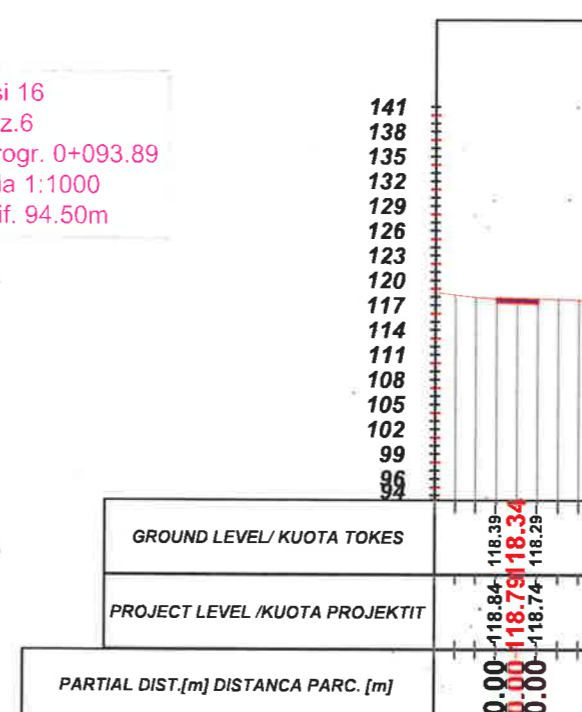

## LEGJENDA

- NIVELETA E RRUGES
- TERRENI NATYRAL



## BASHKIA KAMEZ

DREJTORIA E PROJEKTEVE DHE INVESTIMEVE  
DEPARTAMENTI I PROJEKTEVE

Dr. e Projekteve e Investimeve	RAMADAN HYSA	
Pergj. Sektori i Projekteve	DENIS PRENÇI	
STAFI TEKNIK	Ing. EMANUELA MËZIU	
PROJEKTUES	Ing. ARTUR ÇAJKA	
	Ing. ALEKS DANI	
	Ark. ESTELA GJYRIQI	

Titulli i Projektit	Faza e Projektit
NDERTIM RRUGËT "PASKUQAN 1 DHE 2"	PROJEKT ZBATIMI
Emertimi i Fletes	Data e Implementimit :
PROFLET TËRTHORE	H 1:250
	Fleta Nr.
	01 (91)

# PROFILE TËRTHORE AKSI 17

Aksi 17  
- Sez.1  
- Progr. 0+000.00  
Scala 1:1000  
Q.Rif. 94.50m

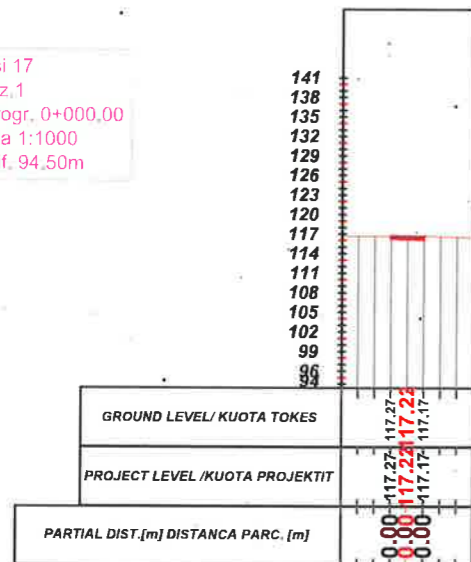

Aksi 17  
- Sez.3  
- Progr. 0+040.00  
Scala 1:1000  
Q.Rif. 91.50m

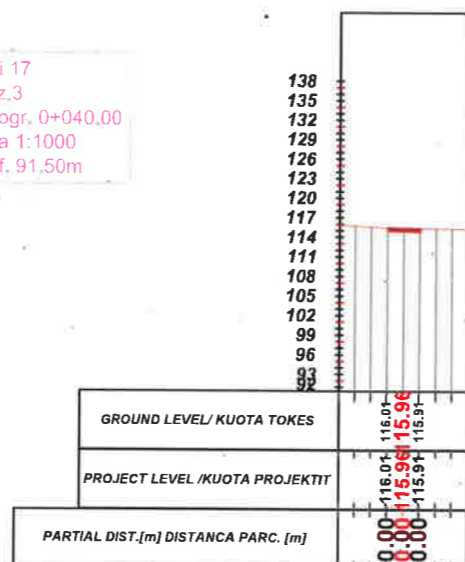

Aksi 17  
- Sez.5  
- Progr. 0+080.00  
Scala 1:1000  
Q.Rif. 94.50m

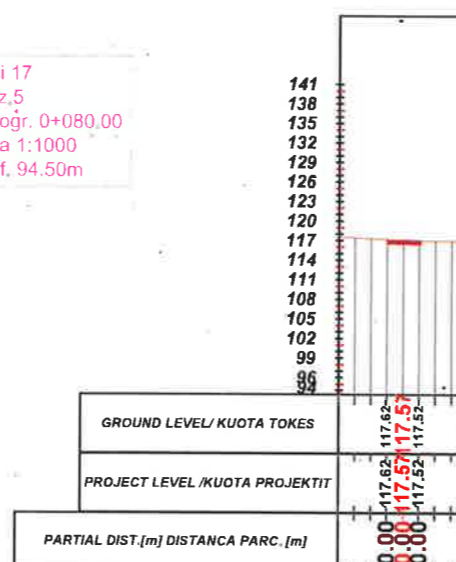

Aksi 17  
- Sez.6  
- Progr. 0+092.68  
Scala 1:1000  
Q.Rif. -25.50m

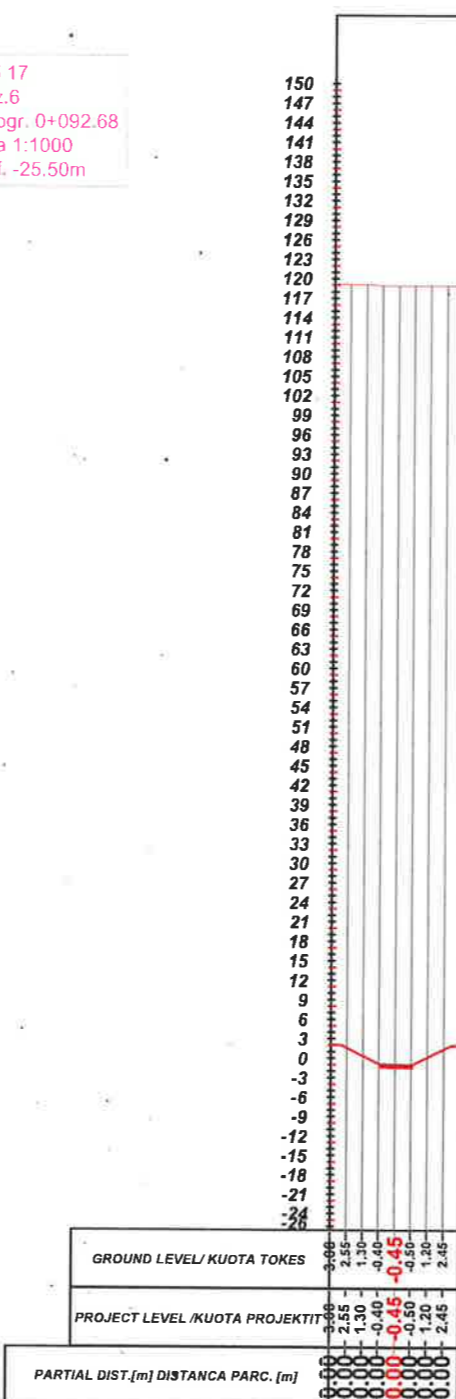

Aksi 17  
- Sez.2  
- Progr. 0+020.00  
Scala 1:1000  
Q.Rif. 91.50m

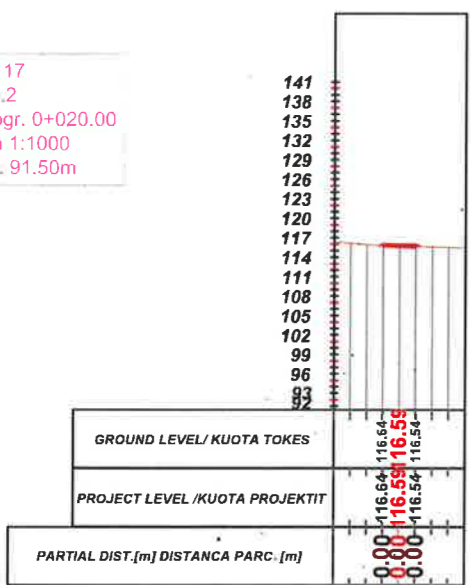

Aksi 17  
- Sez.4  
- Progr. 0+060.00  
Scala 1:1000  
Q.Rif. 91.50m

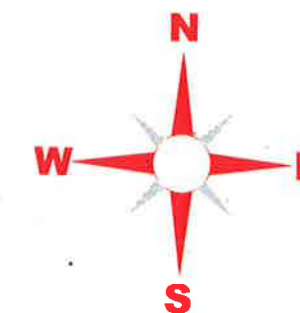
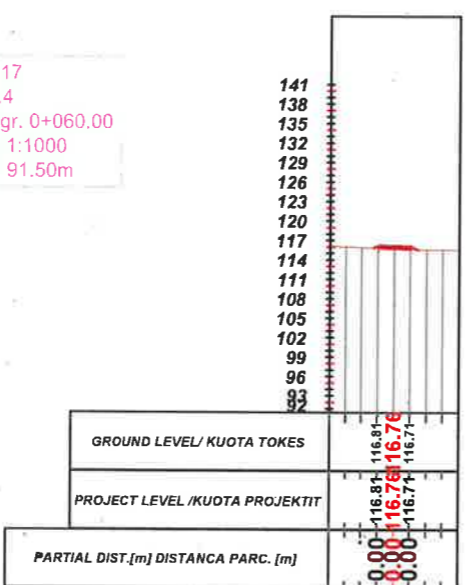

## LEGJENDA

- NIVELETA E RRUGES
- TERRENI NATYRAL



**BASHKIA KAMEZ**

DREJTORIA E PROJEKTEVE DHE INVESTIMEVE  
DEPARTAMENTI I PROJEKTEVE

Dr. e Projekteve e Investimeve	RAMADAN HYSA	
Pergj. Sektori i Projekteve	DENIS PRENÇI	
STAFI TEKNIK PROJEKTUES	Ing. EMANUELA MËZIU	
	Ing. ARTUR ÇAJKA	
	Ing. ALEKS DANI	
Ark.	ESTELA GJYRIQI	

Titulli i Projektit	Faza e Projektit
NDERTIM RRUGËT "PASKUQAN 1 DHE 2"	PROJEKT ZBATIMI
Emeritimi i Fietes	Data e Implementimit :
PROFILLET TËRTHORE	Shkalla e Vizatimit
	H 1:250
	Fleta Nr.
	01 (92)

# PROFILE TËRTHORE AKSI 18

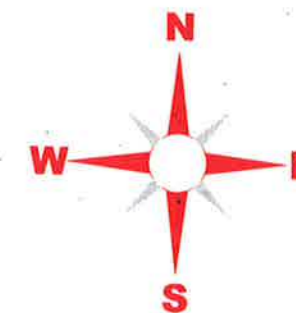

Aksi 18  
- Sez.1  
- Progr. 0+000.00  
Scala 1:1000  
Q.Rif. 106.50m

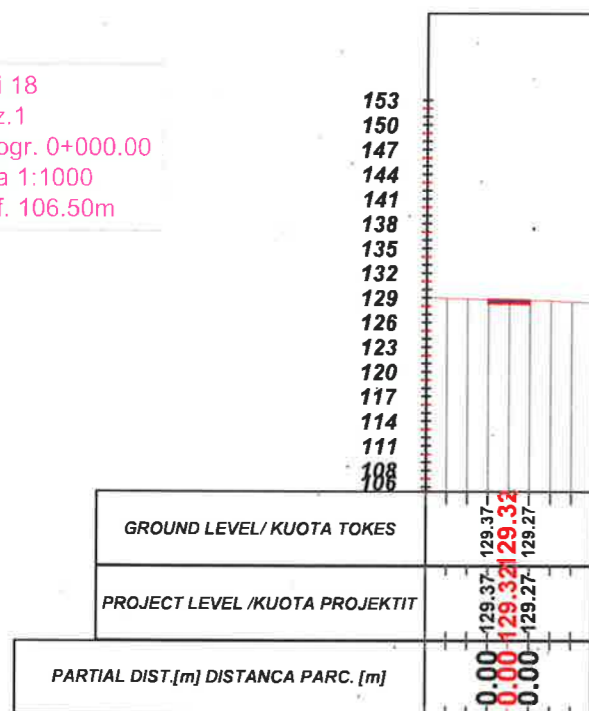

Aksi 18  
- Sez.3  
- Progr. 0+040.00  
Scala 1:1000  
Q.Rif. 106.50m

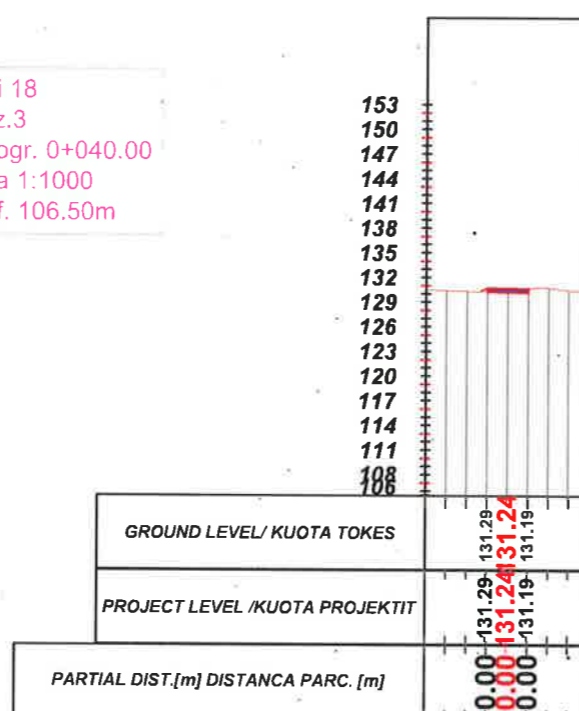

Aksi 18  
- Sez.5  
- Progr. 0+080.00  
Scala 1:1000  
Q.Rif. 106.50m

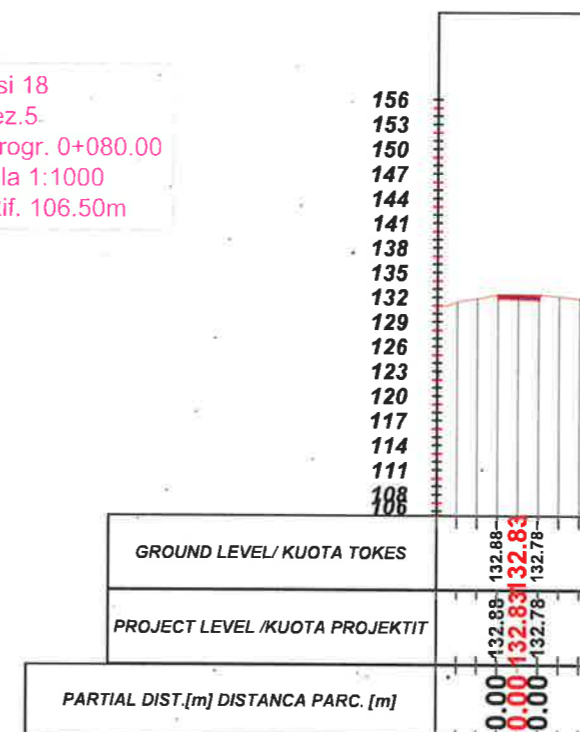

Aksi 18  
- Sez.2  
- Progr. 0+020.00  
Scala 1:1000  
Q.Rif. 106.50m

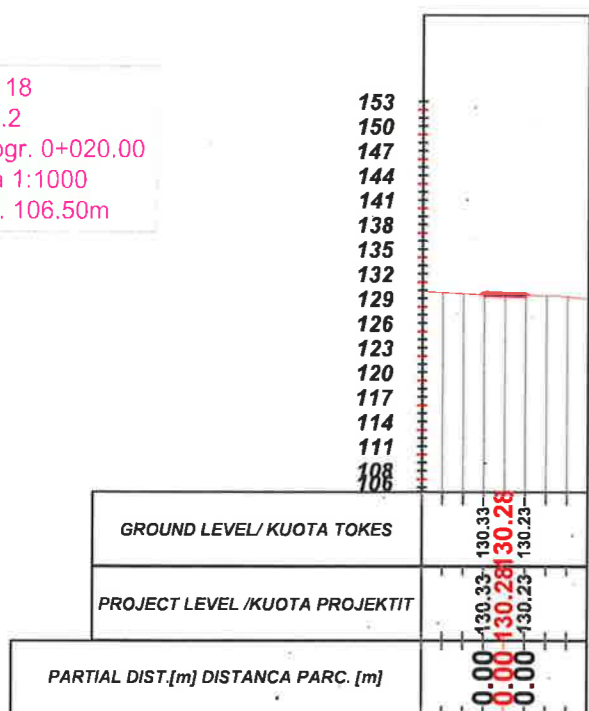

Aksi 18  
- Sez.4  
- Progr. 0+060.00  
Scala 1:1000  
Q.Rif. 106.50m

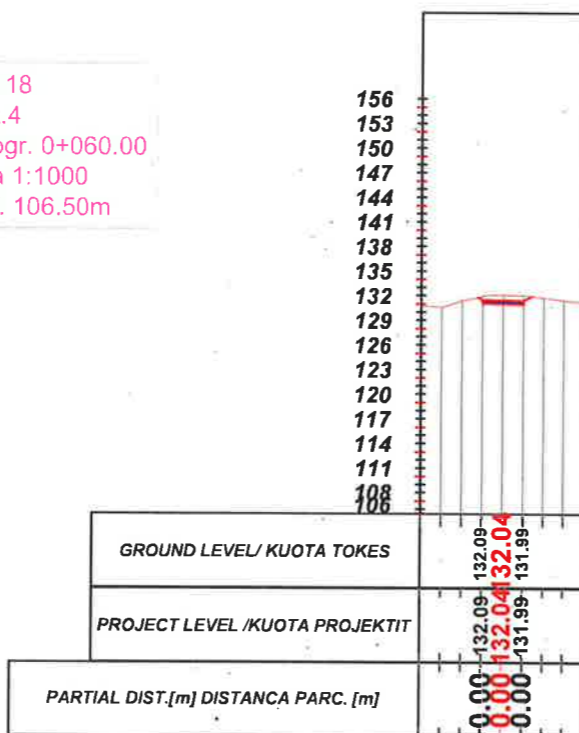

Aksi 18  
- Sez.6  
- Progr. 0+100.00  
Scala 1:1000  
Q.Rif. 106.50m

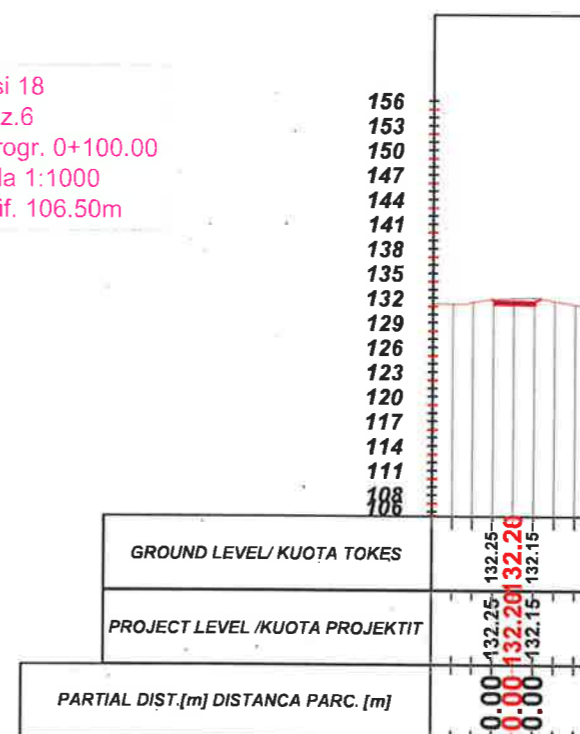

## LEGJENDA

- NIVELETA E RRUGES
- TERRENI NATYRAL



## BASHKIA KAMEZ

DREJTORIA E PROJEKTEVE DHE INVESTIMEVE  
DEPARTAMENTI I PROJEKTEVE

Dr. e Projekteve e Investimeve	RAMADAN HYSA	
Pergj. Sektori i Projekteve	DENIS PRENÇI	
STAFI TEKNIK PROJEKTES	Ing. EMANUELA MËZIÛ	
	Ing. ARTUR ÇAJKA	
	Ing. ALEKS DANI	
Ark. ESTELA GJYRIQI		

Titulli i Projektit	Faza e Projektit
NDERTIM RRUGËT "PASKUQAN 1 DHE 2"	PROJEKT ZBATIMI
Emertimi i Fletes	Data e Implementimit :
PROFLET TËRTHORE.	Shkalla e Vizatimit
	H 1:250
	Fleta Nr.
	01 (93)

# PROFILE TËRTHORE AKSI 18

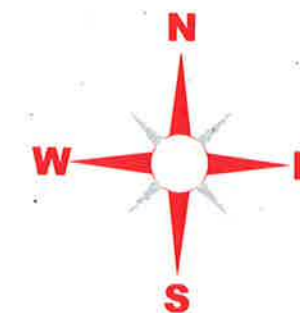

Aksi 18  
- Sez.7  
- Progr. 0+120.00  
Scala 1:1000  
Q.Rif. 106.50m

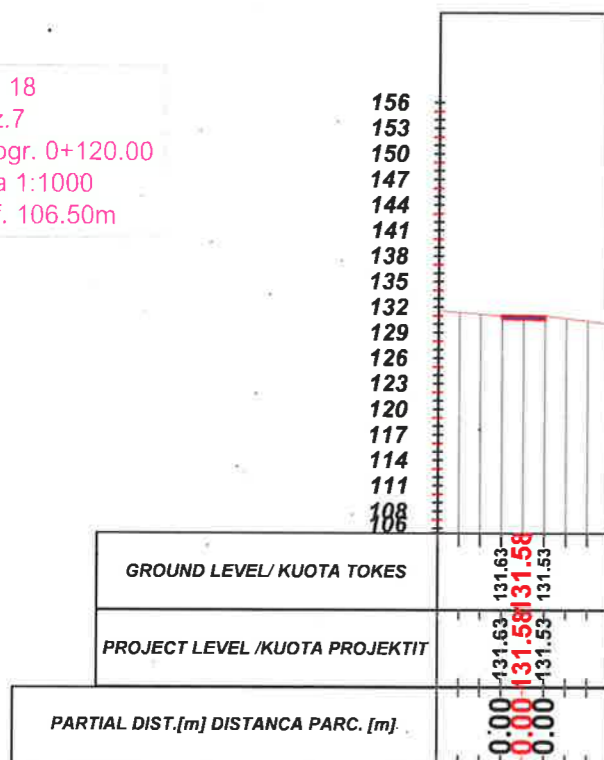

Aksi 18  
- Sez.9  
- Progr. 0+160.00  
Scala 1:1000  
Q.Rif. 103.50m

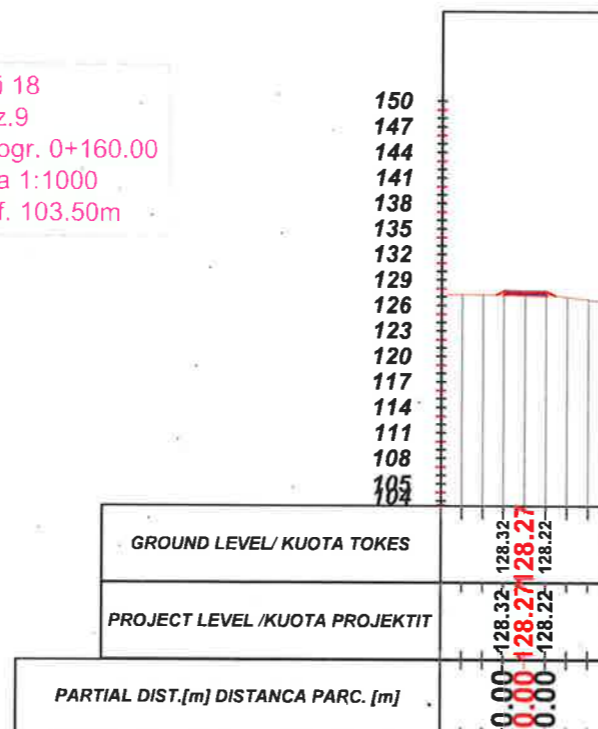

Aksi 18  
- Sez.11  
- Progr. 0+200.00  
Scala 1:1000  
Q.Rif. 100.50m

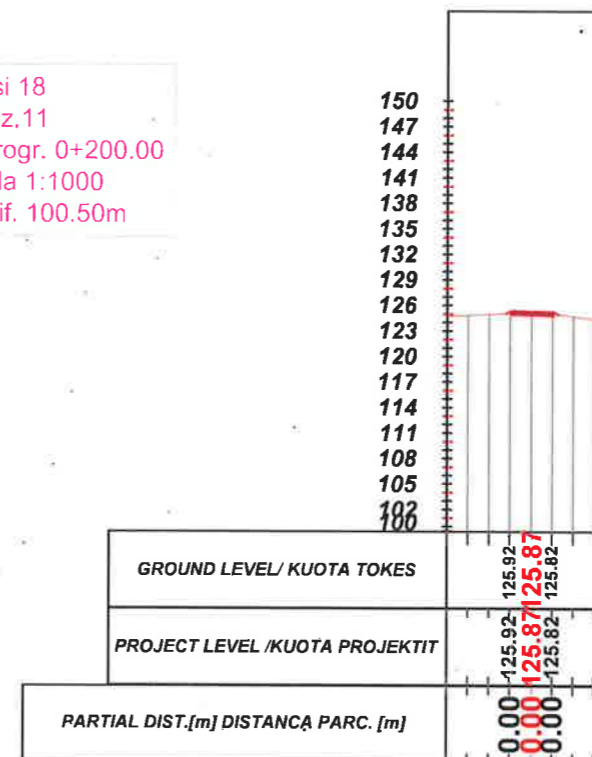

Aksi 18  
- Sez.8  
- Progr. 0+140.00  
Scala 1:1000  
Q.Rif. 106.50m

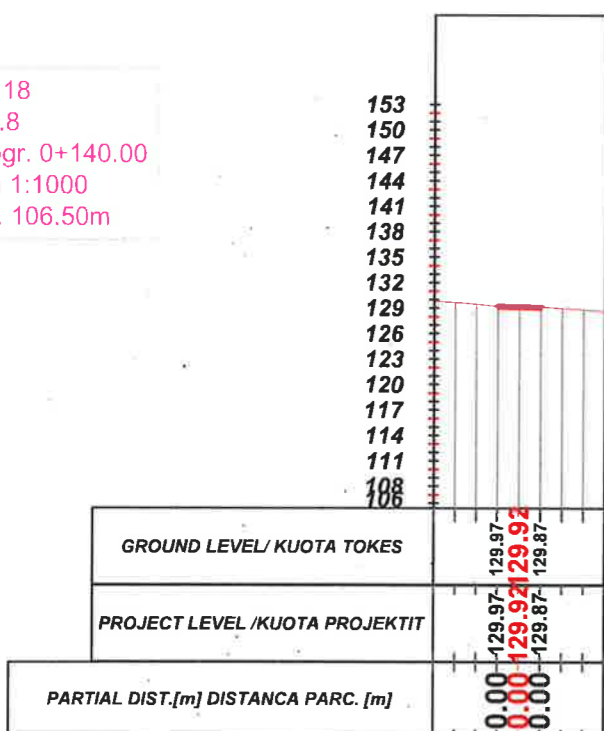

Aksi 18  
- Sez.10  
- Progr. 0+180.00  
Scala 1:1000  
Q.Rif. 103.50m

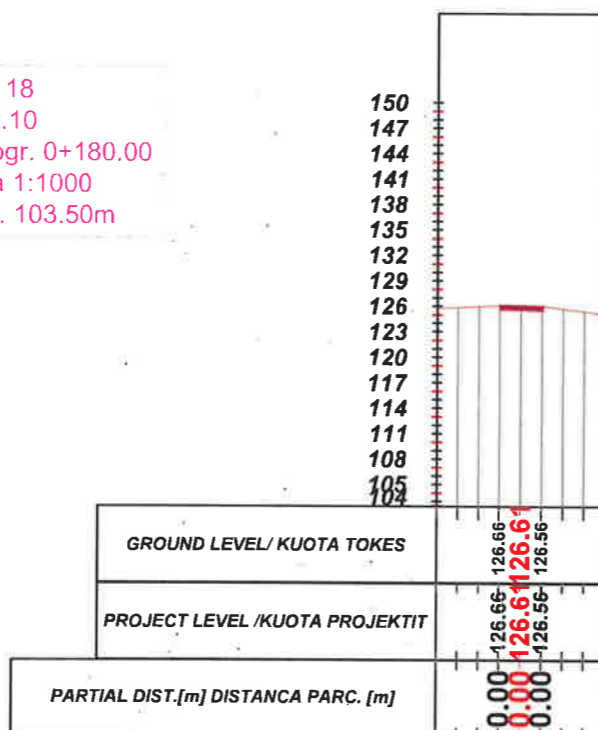

Aksi 18  
- Sez.12  
- Progr. 0+220.00  
Scala 1:1000  
Q.Rif. 100,50m

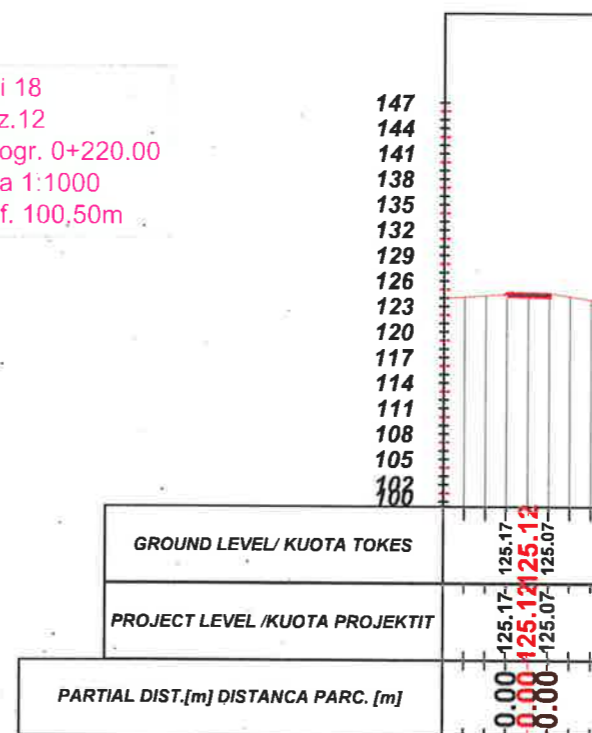

## LEGJENDA

- NIVELETA E RRUGES
- TERRENI NATYRAL



## BASHKIA KAMEZ

DREJTORIA E PROJEKTEVE DHE INVESTIMEVE  
DEPARTAMENTI I PROJEKTEVE

Dr. e Projekteve e Investimeve	RAMADAN HYSA	
Pergj. Sektori i Projekteve	DENIS PRENÇI	
STAFI TEKNIK PROJEKTES	Ing. EMANUELA MËZIU	
	Ing. ARTUR ÇAJKA	
	Ing. ALEKS DANI	
Ark.	ESTELA GJYRIQI	

Titulli i Projektit	Faza e Projektit
NDERTIM RRUGËT "PASKUQAN 1 DHE 2"	PROJEKT ZBATIMI
Data e Implementimit :	

Emertimi i Fietes	Shkalla e Vizatimit
PROFILET TËRTHORE	H 1:250
Fleta Nr.	

# PROFILI TËRTHORE AKSI 18

Aksi 18  
- Sez.13  
- Progr. 0+240.00  
Scala 1:1000  
Q.Rif. 100.50m

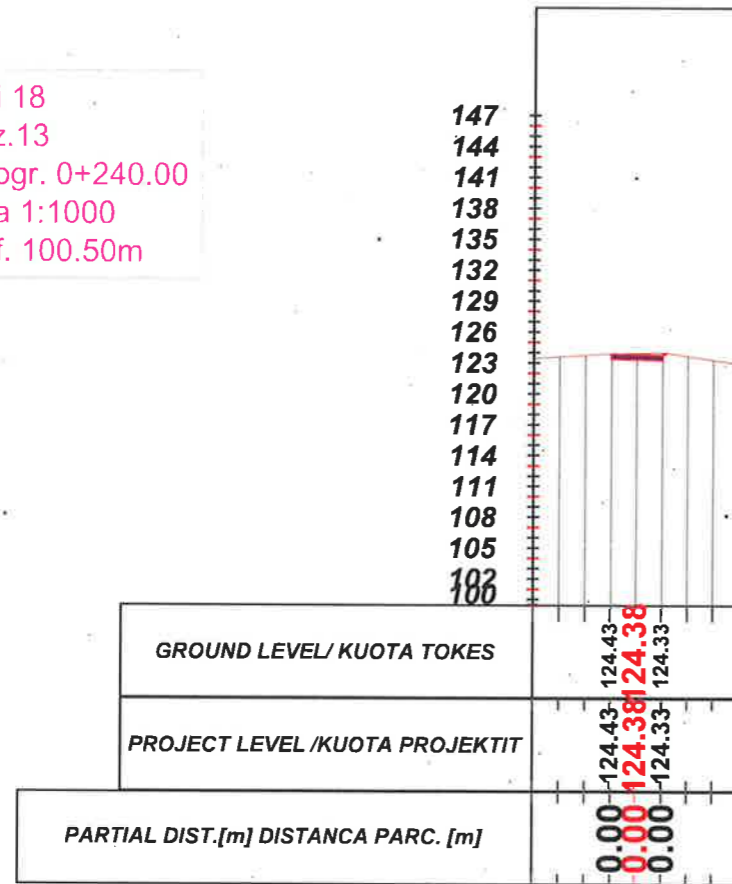

Aksi 18  
- Sez.15  
- Progr. 0+280.00  
Scala 1:1000  
Q.Rif. 97.50m

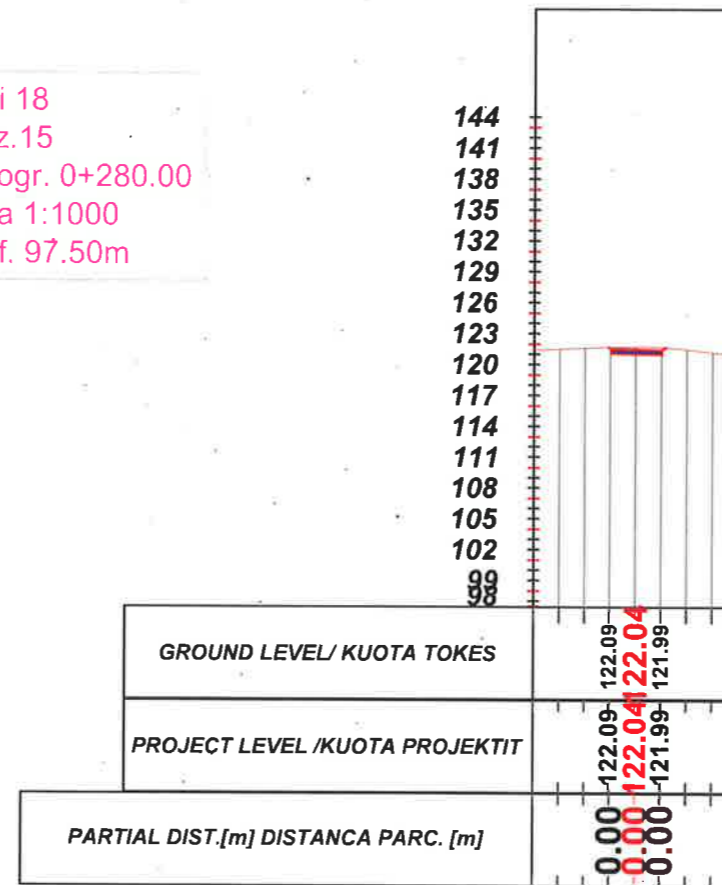

Aksi 18  
- Sez.14  
- Progr. 0+260.00  
Scala 1:1000  
Q.Rif. 100.50m

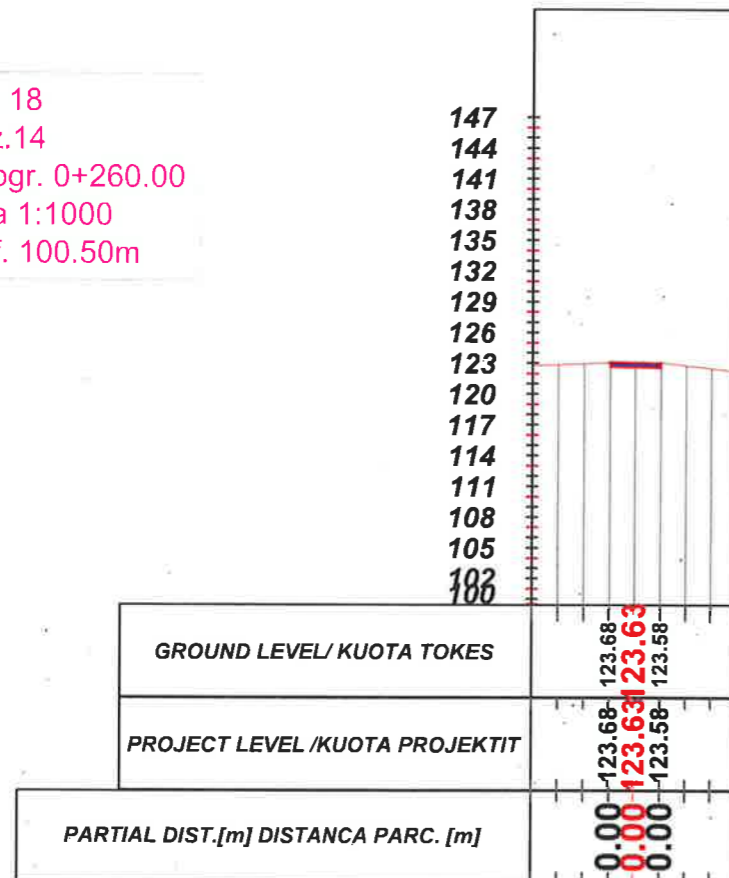

Aksi 18  
- Sez.16  
- Progr. 0+300.00  
Scala 1:1000  
Q.Rif. 97.50m

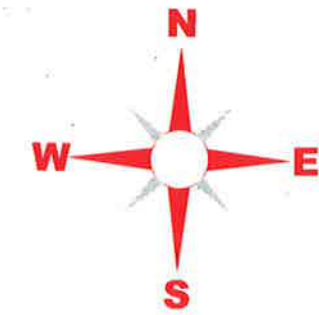
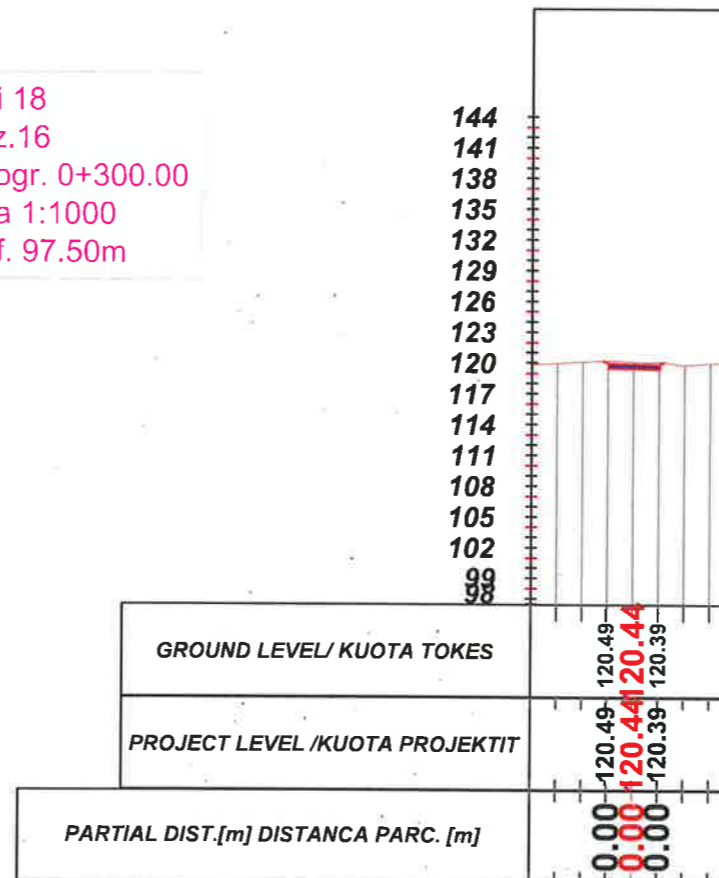

## LEGJENDA

- NIVELETA E RRUGES
- TERRENI NATYRAL



## BASHKIA KAMEZ

DREJTORIA E PROJEKTEVE DHE INVESTIMEVE  
DEPARTAMENTI I PROJEKTEVE

Dr. e Projekteve e Investimeve	RAMADAN HYSA	
Pergj. Sektori i Projekteve	DENIS PRENÇI	
STAFI TEKNIK PROJEKTUES	Ing. EMANUELA MËZIU	
	Ing. ARTUR ÇAJKA	
	Ing. ALEKS DANI	
	Ark. ESTELA GJYRIQI	

Titulli i Projektit	Faza e Projektit
NDERTIM RRUGËT "PASKUQAN 1 DHE 2"	PROJEKT ZBATIMI
Emeritimi i Fletes	Data e Implementimit :
PROFILIET TËRTHORE	Shkalla e Vizatimit :
	H 1:250
	Fleta Nr.
	01 (95)

# PROFILE TËRTHORË AKSI 18

Aksi 18  
 - Sez.17  
 - Progr. 0+305.29  
 Scala 1:1000  
 Q.Rif. -25.50m

165  
162  
159  
156  
153  
150  
147  
144  
141  
138  
135  
132  
129  
126  
123  
120  
117  
114  
111  
108  
105  
102  
99  
96  
93  
90  
87  
84  
81  
78  
75  
72  
69  
66  
63  
60  
57  
54  
51  
48  
45  
42  
39  
36  
33  
30  
27  
24  
21  
18  
15  
12  
9  
6  
3  
0  
-3  
-6  
-9  
-12  
-15  
-18  
-21  
-24  
-26

GROUND LEVEL / KUOTA TOKES	3.08	2.55	1.30	-0.40	-0.45	-0.50	1.20	2.45	2.98
PROJECT LEVEL / KUOTA PROJEKTIT	3.08	2.55	1.30	-0.40	-0.45	-0.50	1.20	2.45	2.98
PARTIAL DIST.[m] / DISTANCA PARC. [m]	0.00	0.00	0.00	0.00	0.00	0.00	0.00	0.00	0.00

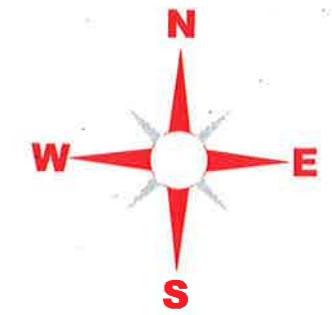

## LEGJENDA

- NIVELETA E RRUGES
- TERRENI NATYRAL



## BASHKIA KAMEZ

DREJTORIA E PROJEKTEVE DHE INVESTIMEVE  
 DEPARTAMENTI I PROJEKTEVE

Dr. e Projekteve e Investimeve	RAMADAN HYSA	
Pergj. Sektori i Projekteve	DENIS PRENÇI	
STAFI TEKNIK PROJEKTVES	Ing. EMANUELA MËZIU	
	Ing. ARTUR ÇAJKA	
	Ing. ALEKS DANI	
	Ark. ESTELA GJYRIQI	

Titulli i Projektit	Faza e Projektit
NDERTIM RRUGËT "PASKUQAN 1 DHE 2"	PROJEKT ZBATIMI
Emertimi i Fletes	Data e Implementimit :
PROFILET TËRTHORE	Shkalla e Vizatimit
	H 1:250
	Fletq Nr.
	01 (96)

# PROFILE TËRTHORE AKSI 19

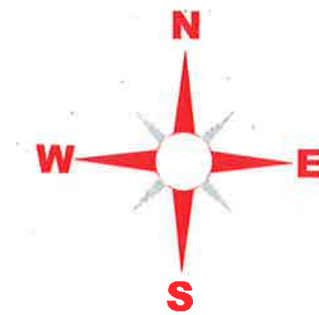

Aksi 19  
- Sez.1  
- Progr. 0+000.00  
Scala 1:1000  
Q.Rif. 94.50m

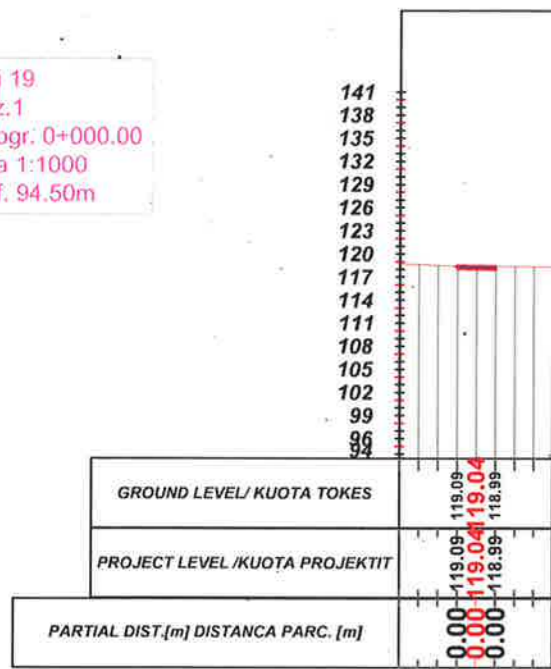

Aksi 19  
- Sez.3  
- Progr. 0+040.00  
Scala 1:1000  
Q.Rif. 91.50m

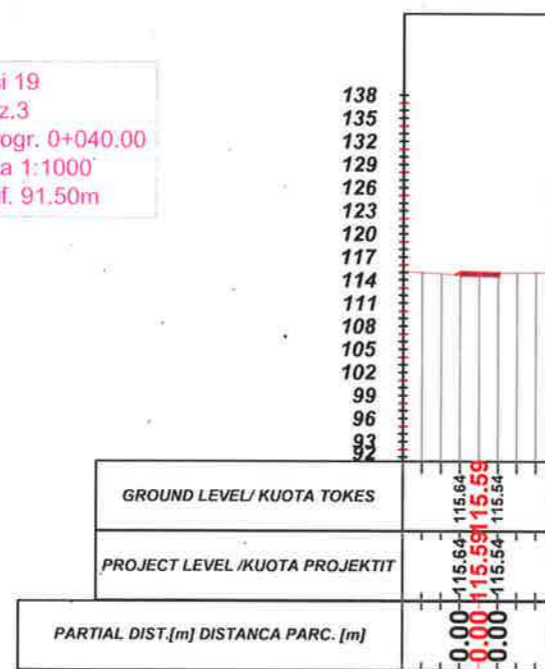

Aksi 19  
- Sez.5  
- Progr. 0+080.00  
Scala 1:1000  
Q.Rif. 91.50m

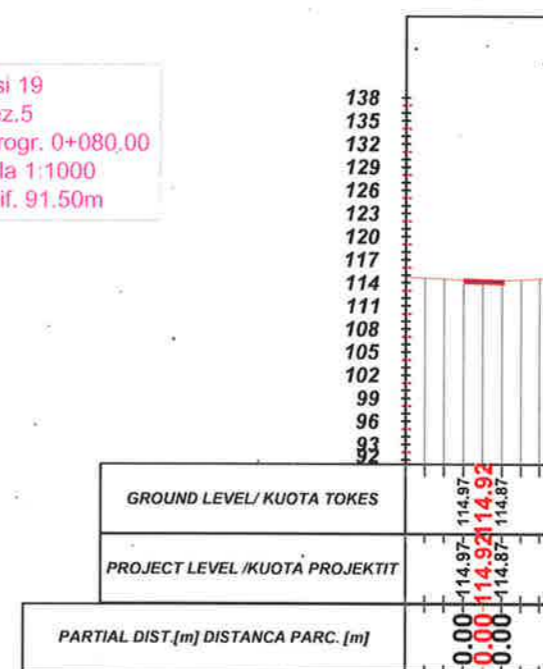

Aksi 19  
- Sez.2  
- Progr. 0+020.00  
Scala 1:1000  
Q.Rif. 91.50m

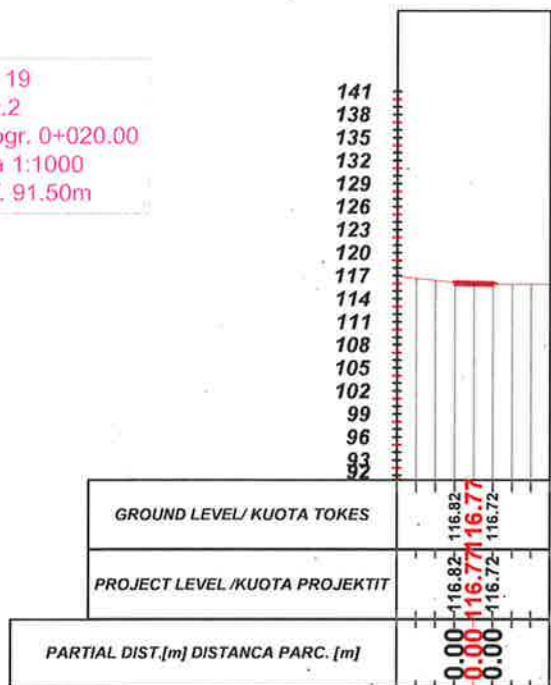

Aksi 19  
- Sez.4  
- Progr. 0+060.00  
Scala 1:1000  
Q.Rif. 91.50m

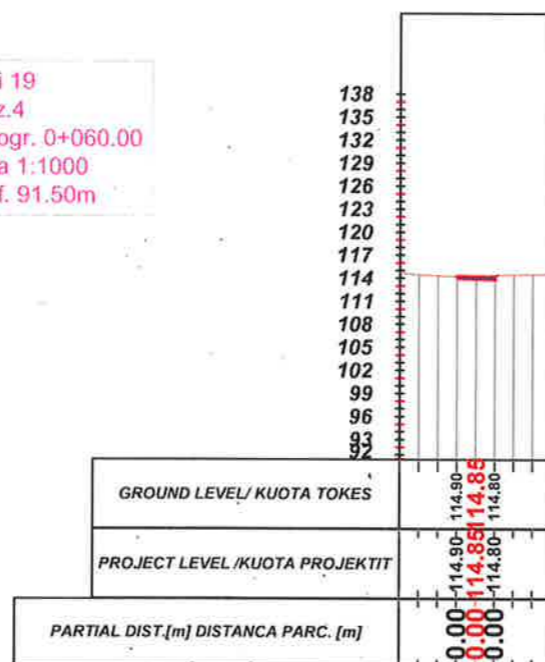

Aksi 19  
- Sez.6  
- Progr. 0+085.92  
Scala 1:1000  
Q.Rif. 91.50m

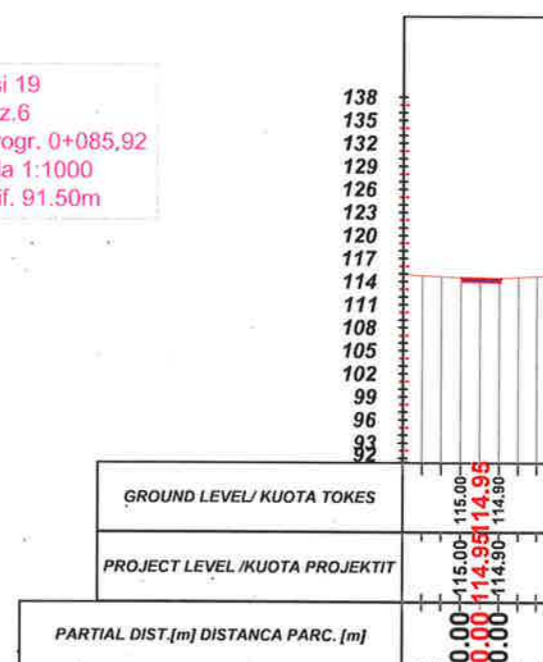

## LEGJENDA

- NIVELETA E RRUGES
- TERRENI NATYRAL



## BASHKIA KAMEZ

DREJTORIA E PROJEKTEVE DHE INVESTIMEVE  
DEPARTAMENTI I PROJEKTEVE

Dr. e Projekteve e Investimeve	RAMADAN HYSA	
Pergj. Sektori i Projekteve	DENIS PRENÇI	
STAFI TEKNIK PROJEKTUES	Ing. EMANUELA MËZIU	
	Ing. ARTUR ÇAJKA	
	Ing. ALEKS DANI	
Ark. ESTELA GJYRIQI		

Titulli i Projektit	Faza e Projektit
NDERTIM RRUGËT "PASKUQAN 1 DHE 2"	PROJEKT ZBATIMI
Emeritimi i Fietes	Data e Implementimit :
PROFILLET TËRTHORE	Shkalla e Vizatimit
	H 1:250
	Fleta Nr.
	01 (97)

# PROFİLË TËRTHORE AKSI 20

Aksi 20  
- Sez.1  
- Progr. 0+000.00  
Scala 1:1000  
Q.Rif. 94.50m

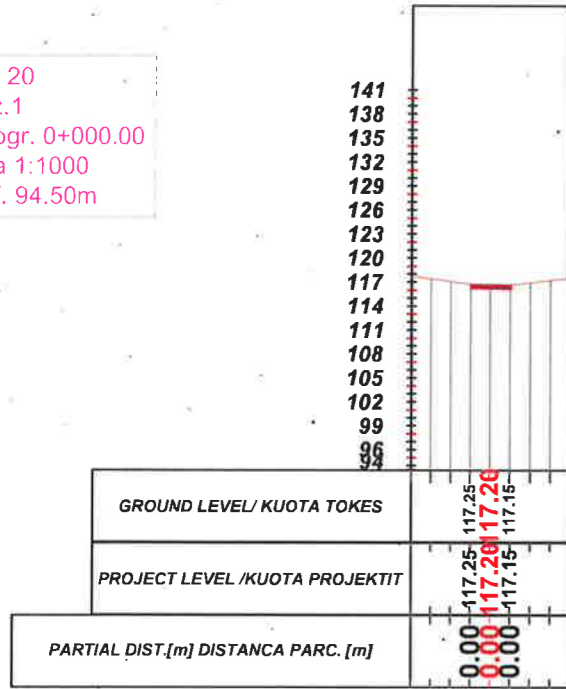

Aksi 20  
- Sez.3  
- Progr. 0+040.00  
Scala 1:1000  
Q.Rif. 97.50m

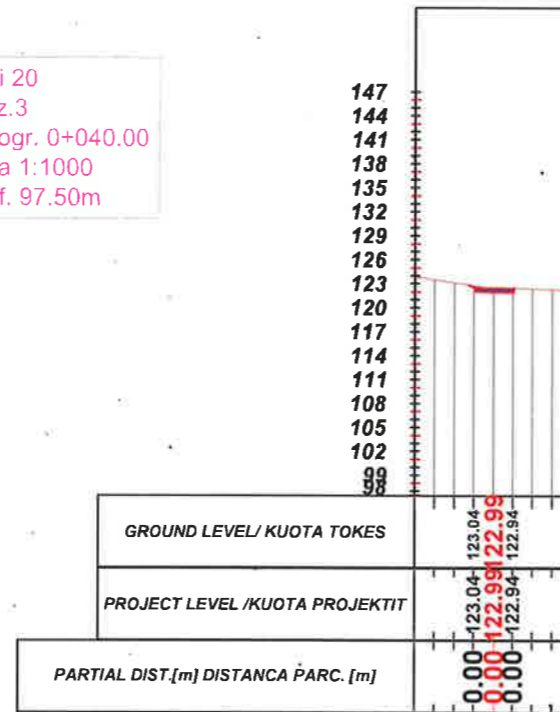

Aksi 20  
- Sez.5  
- Progr. 0+080.00  
Scala 1:1000  
Q.Rif. 100.50m

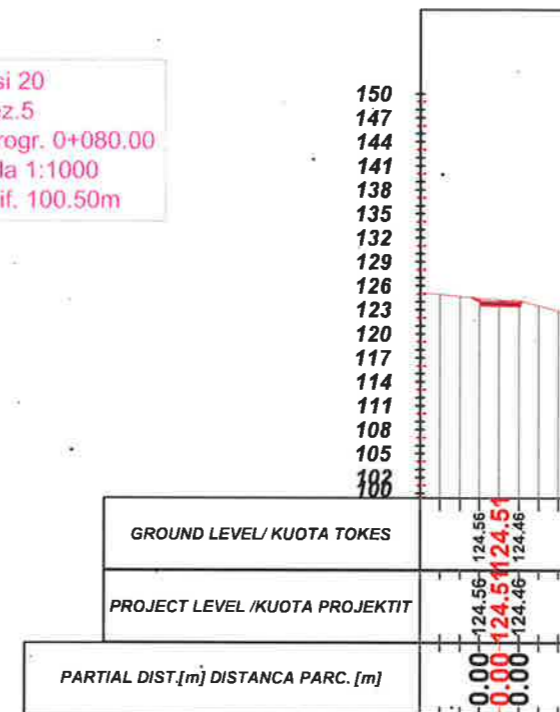

Aksi 20  
- Sez.2  
- Progr. 0+020.00  
Scala 1:1000  
Q.Rif. 94.50m

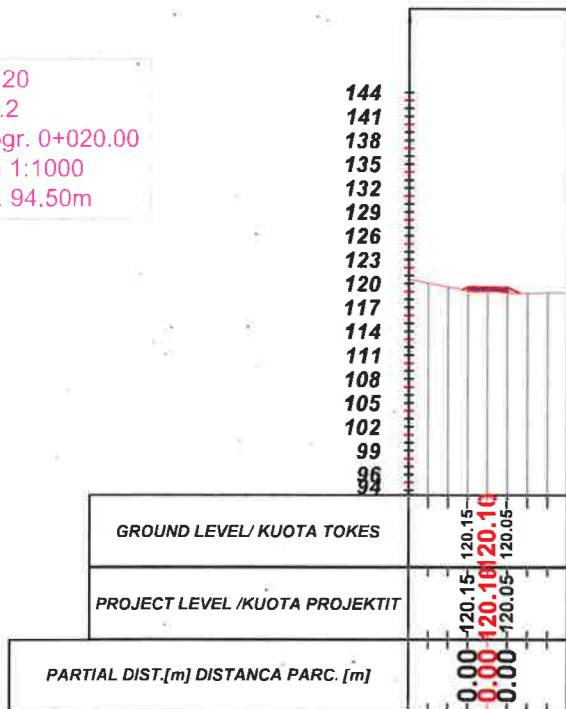

Aksi 20  
- Sez.4  
- Progr. 0+060.00  
Scala 1:1000  
Q.Rif. 100.50m

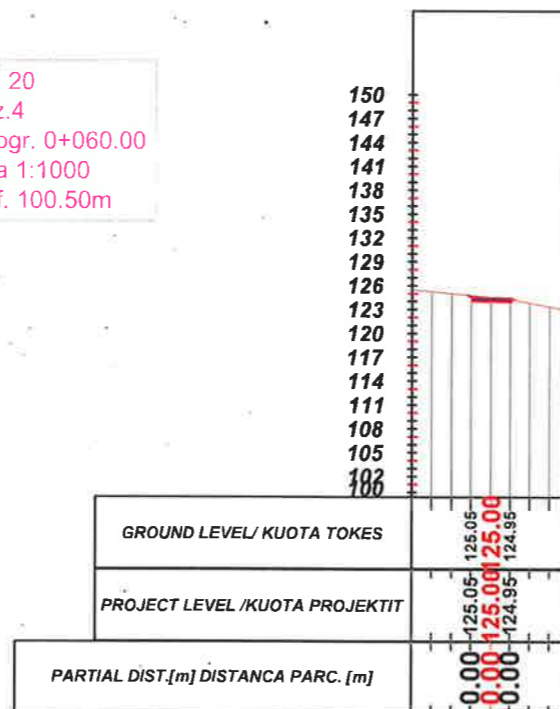

Aksi 20  
- Sez.6  
- Progr. 0+089.94  
Scala 1:1000  
Q.Rif. 100.50m

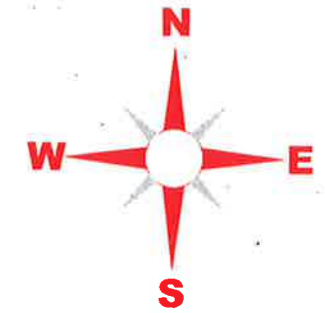
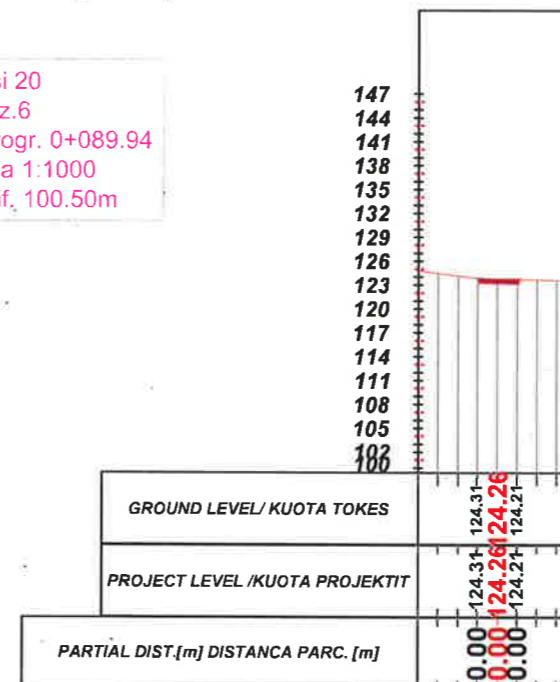

## LEGJENDA

- NIVELETA E RRUGES
- TERRENI NATYRAL



## BASHKIA KAMEZ

DREJTORIA E PROJEKTEVE DHE INVESTIMEVE  
DEPARTAMENTI I PROJEKTEVE

Dr. e Projekteve e Investimeve	RAMADAN HYSA	
Pergj. Sektori i Projekteve	DENIS PRENÇI	
STAFI TEKNIK PROJEKTUES	Ing. EMANUELA MËZIU	
	Ing. ARTUR ÇAJKA	
	Ing. ALEKS DANI	
	Ark. ESTELA GJYRIQI	

Titulli i Projektit	Faza e Projektit
NDERTIM RRUGËT "PASKUQAN 1 DHE 2"	PROJEKT ZBATIMI
Emeritimi i Fletes	Data e Implementimit :
PROFILËT TËRTHORE	Shkalla e Vizatimit
	H 1:250
	Fleta Nr.
	01 (98)

# PROFILE TËRTHORE AKSI 21

Aksi 21  
- Sez.1  
- Progr. 0+000.00  
Scala 1:1000  
Q.Rif. 118.50m

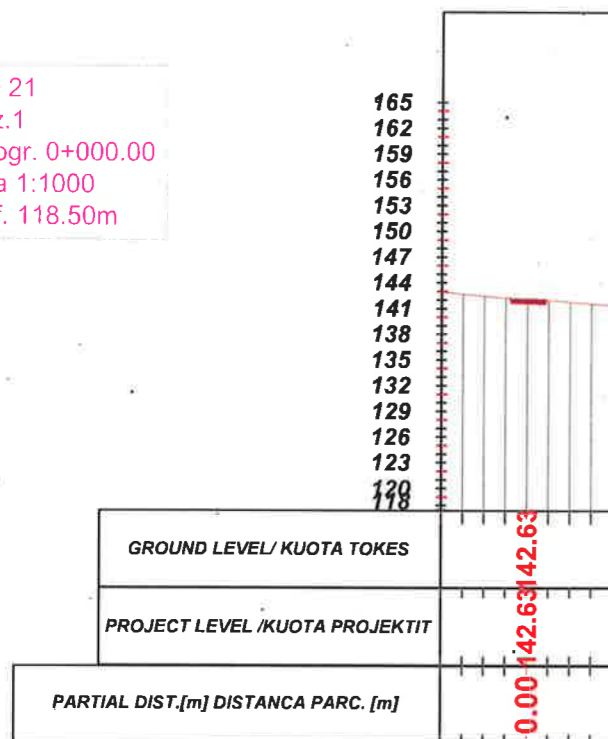

Aksi 21  
- Sez.3  
- Progr. 0+040.00  
Scala 1:1000  
Q.Rif. 115.50m

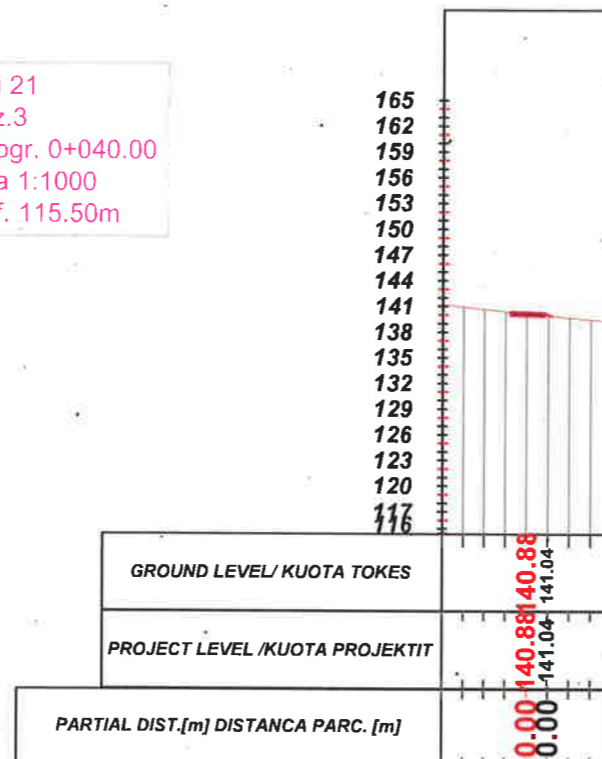

Aksi 21  
- Sez.5  
- Progr. 0+080.00  
Scala 1:1000  
Q.Rif. 118.50m

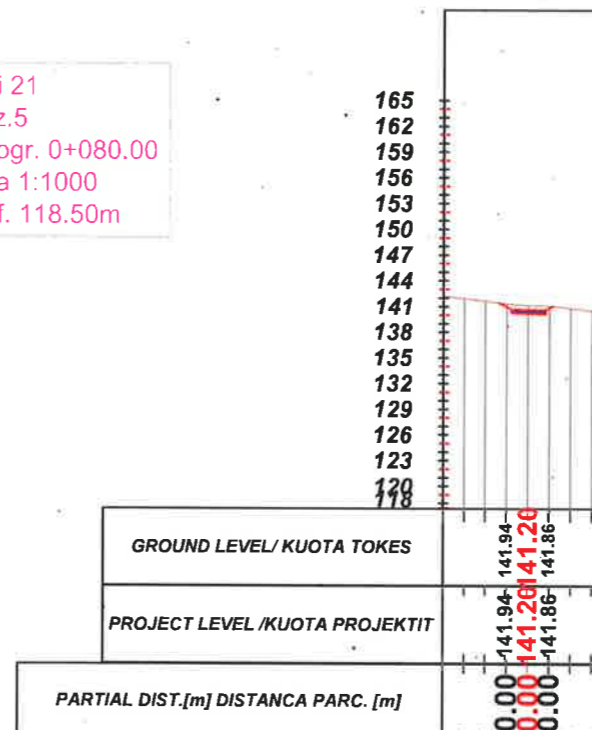

Aksi 21  
- Sez.2  
- Progr. 0+020.00  
Scala 1:1000  
Q.Rif. 118.50m

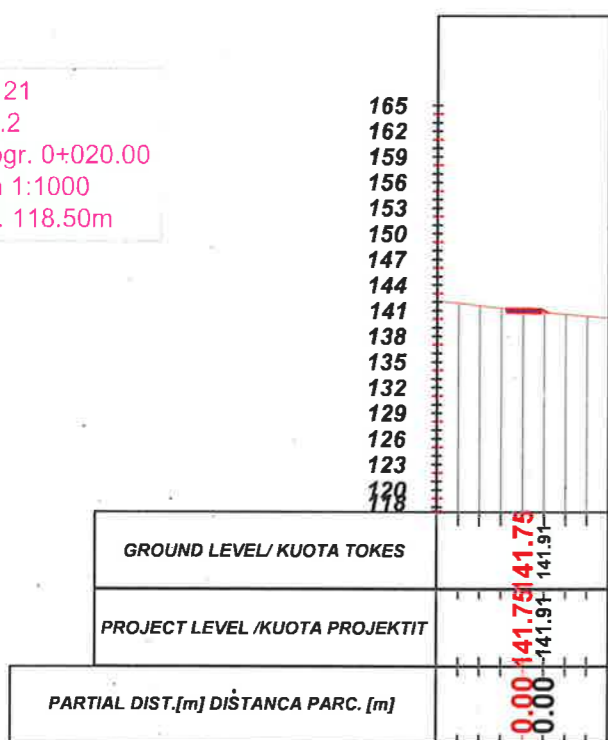

Aksi 21  
- Sez.4  
- Progr. 0+060.00  
Scala 1:1000  
Q.Rif. 115.50m

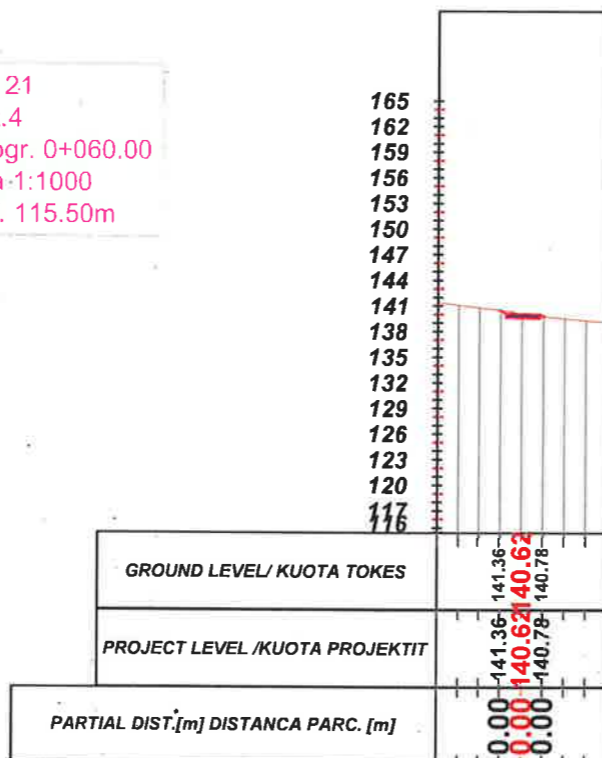

Aksi 21  
- Sez.6  
- Progr. 0+100.00  
Scala 1:1000  
Q.Rif. 118.50m

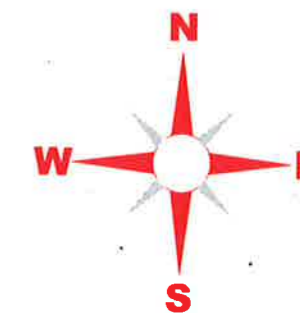
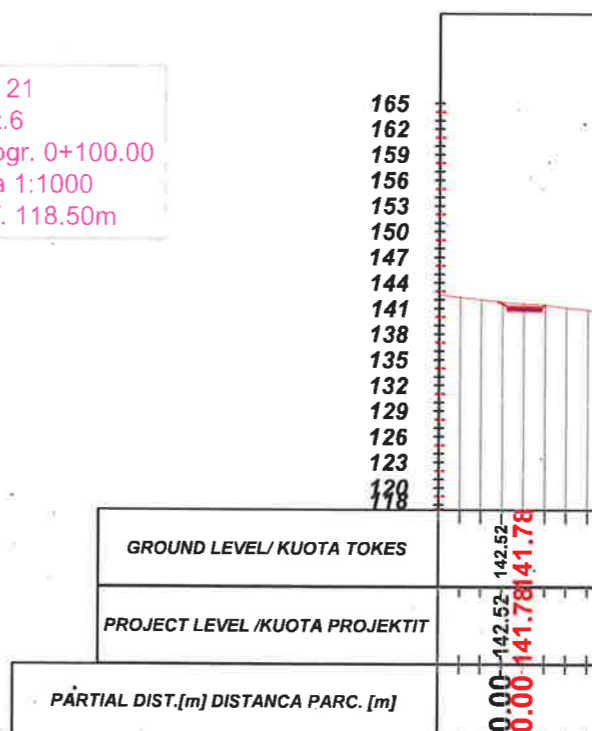

## LEGJENDA

- NIVELETA E RRUGES
- TERRENI NATYRAL



## BASHKIA KAMEZ

DREJTORIA E PROJEKTEVE DHE INVESTIMEVE  
DEPARTAMENTI I PROJEKTEVE

Dr. e Projekteve e Investimeve	RAMADAN HYSA	
Pergj. Sektori i Projekteve	DENIS PRENÇI	
STAFI TEKNIK PROJEKTES	Ing. EMANUELA MËZIU	
	Ing. ARTUR ÇAJKA	
	Ing. ALEKS DANI	
Ark.	ESTELA GJYRIQI	

Titulli i Projektit	Faza e Projektit
NDERTIM RRUGËT "PASKUQAN 1 DHE 2"	PROJEKT ZBATIMI
Emertimi i Fletes	Data e Implementimit :
PROFILET TËRTHORE	Shkalla e Vizatimit
	H 1:250
	Fleta Nr.
	01 (99)

# PROFILE TËRTHORE AKSI 21

Aksi 21  
- Sez.7  
- Progr. 0+120.00  
Scala 1:1000  
Q.Rif. 118.50m

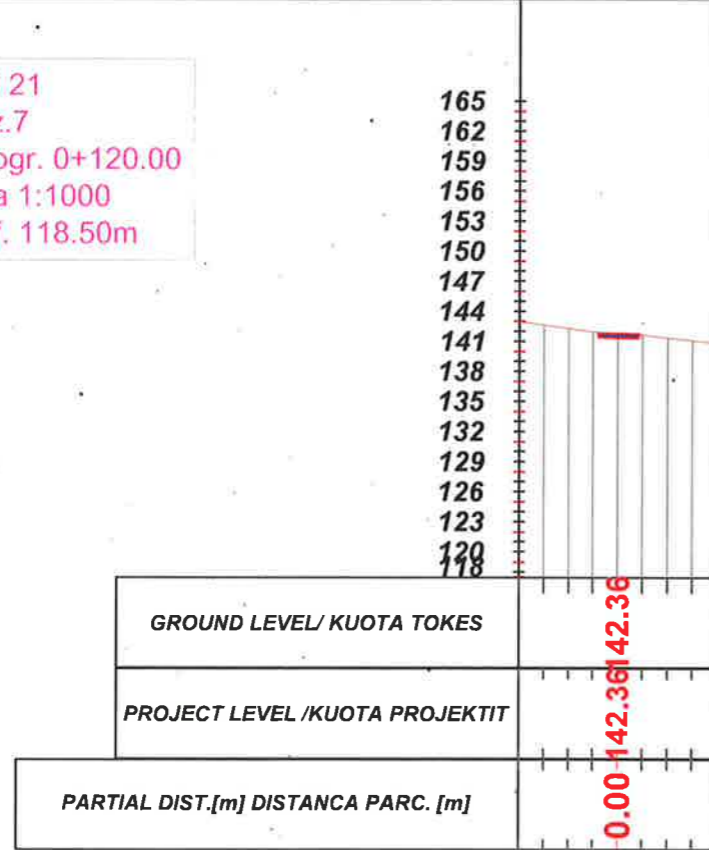

Aksi 21  
- Sez.9  
- Progr. 0+160.00  
Scala 1:1000  
Q.Rif. 121.50m

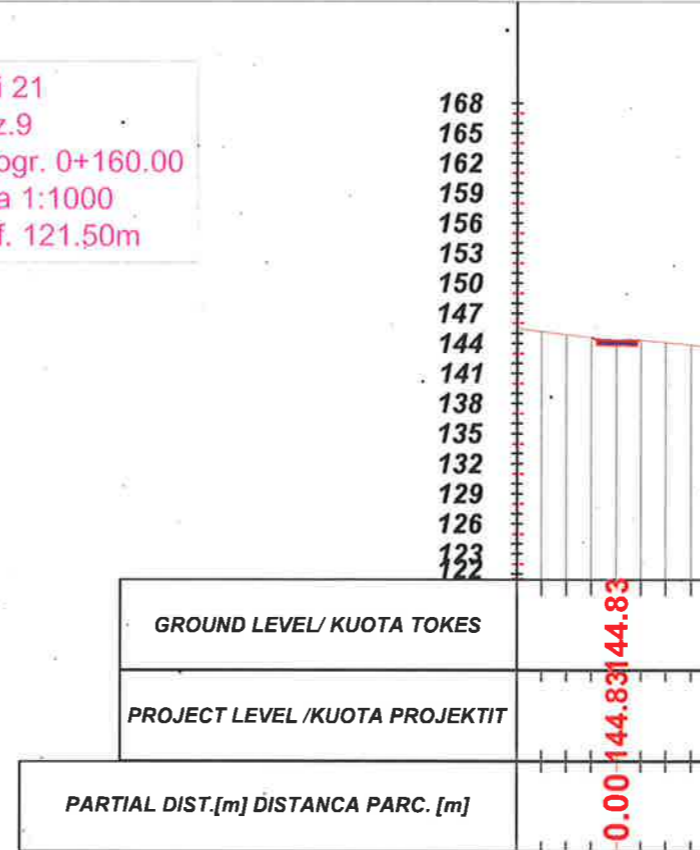

Aksi 21  
- Sez.8  
- Progr. 0+140.00  
Scala 1:1000  
Q.Rif. 118.50m

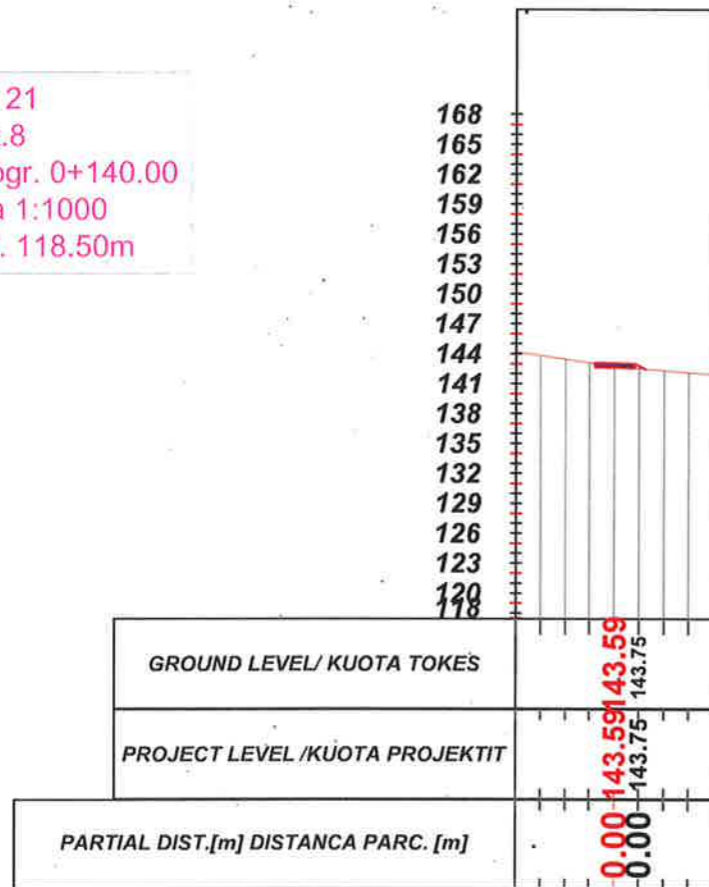

Aksi 21  
- Sez.10  
- Progr. 0+174.52  
Scala 1:1000  
Q.Rif. 121.50m

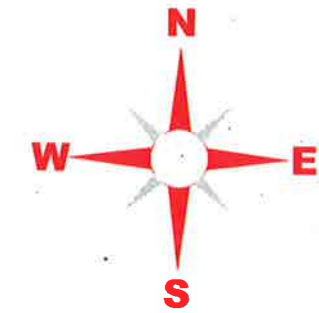
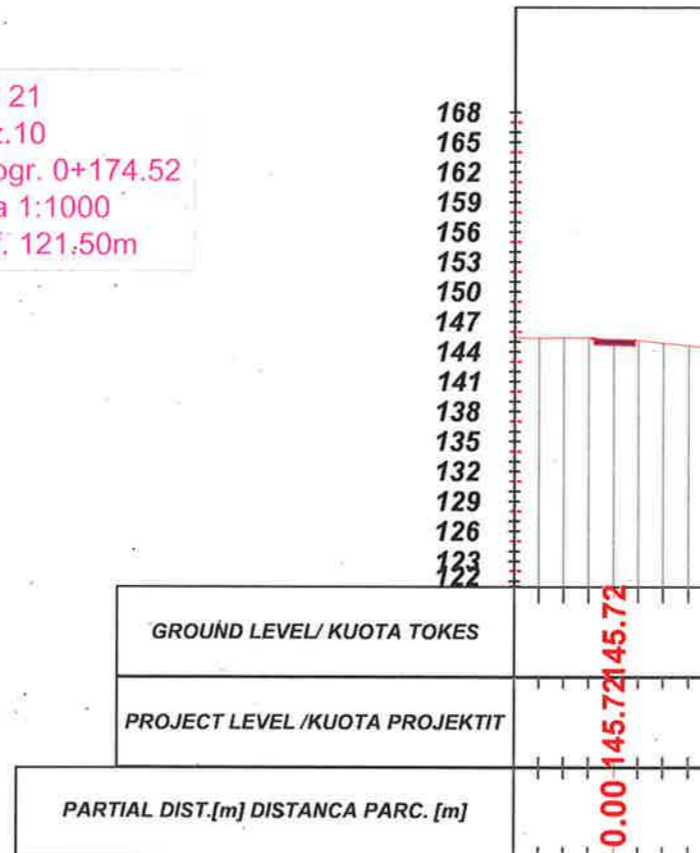

## LEGJENDA

- NIVELETA E RRUGES
- TERRENI NATYRAL



**BASHKIA KAMEZ**

DREJTORIA E PROJEKTEVE DHE INVESTIMEVE  
DEPARTAMENTI I PROJEKTEVE

Dr. e Projekteve e Investimeve	RAMADAN HYSA	
Pergj. Sektori i Projekteve	DENIS PRENÇI	
STAFI TEKNIK PROJEKTUES	Ing. EMANUELA MËZIU	
	Ing. ARTUR ÇAJKA	
	Ing. ALEKS DANI	
	Ark. ESTELA GJYRIQI	

Titulli i Projektit	Faza e Projektit
NDERTIM RRUGËT "PASKUQAN 1 DHE 2"	PROJEKT ZBATIMI
Emertimi i Fletes	Data e Implementimit :
PROFILET TËRTHORE	Shkalla e Vizatimit H 1:250
	Fleta Nr. 01 (100)

# PROFILE TËRTHORË AKSI 22

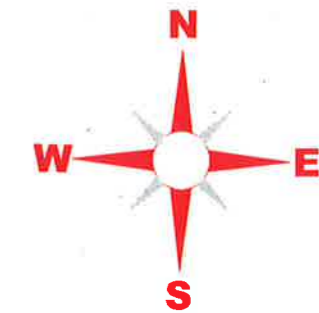

Aksi 22  
- Sez.1  
- Progr. 0+000.00  
Scala 1:1000  
Q.Rif. 124.50m

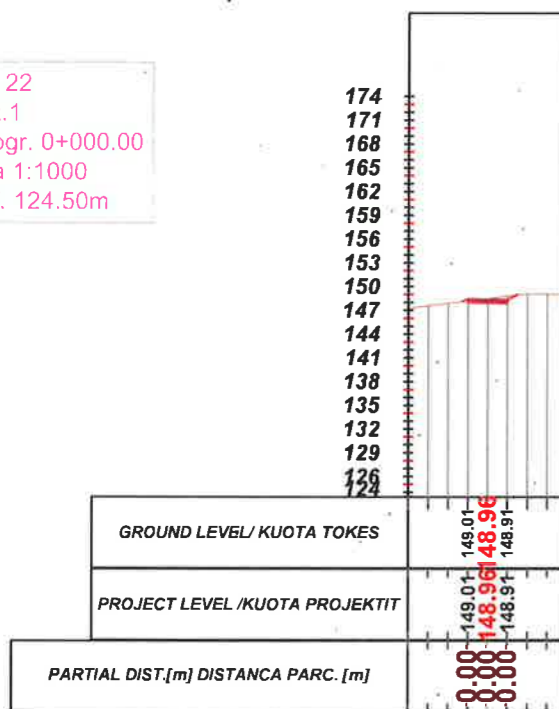

Aksi 22  
- Sez.3  
- Progr. 0+040.00  
Scala 1:1000  
Q.Rif. 121.50m

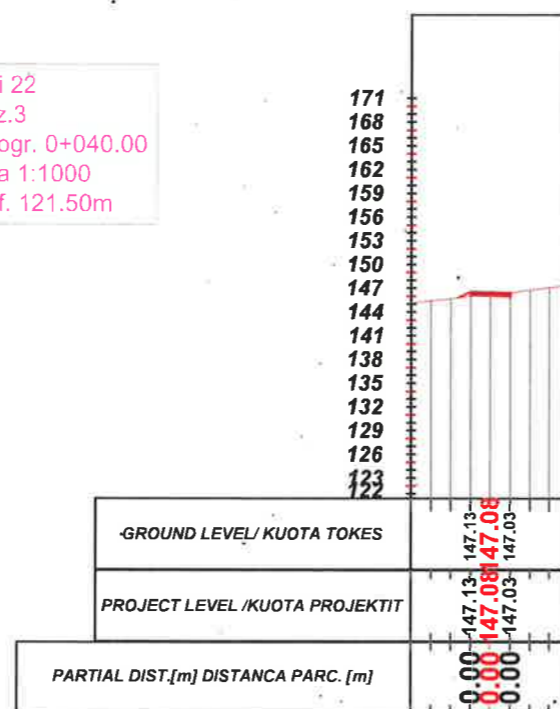

Aksi 22  
- Sez.5  
- Progr. 0+080.00  
Scala 1:1000  
Q.Rif. 121.50m

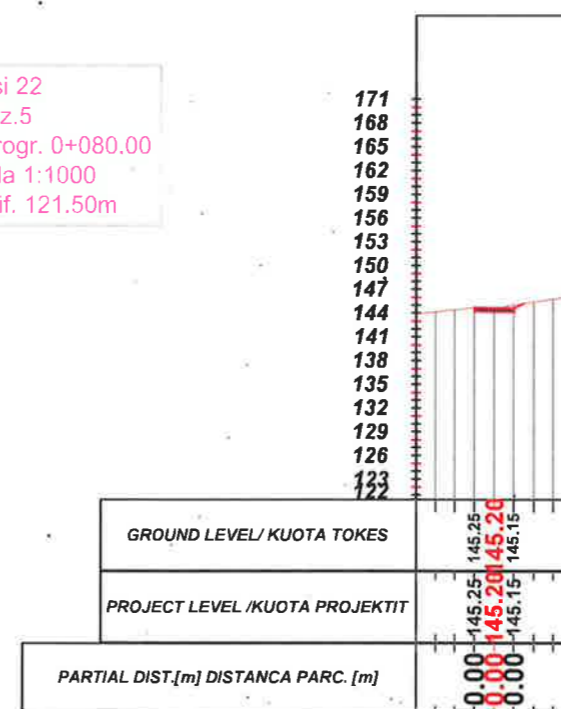

Aksi 22  
- Sez.2  
- Progr. 0+020.00  
Scala 1:1000  
Q.Rif. 124.50m

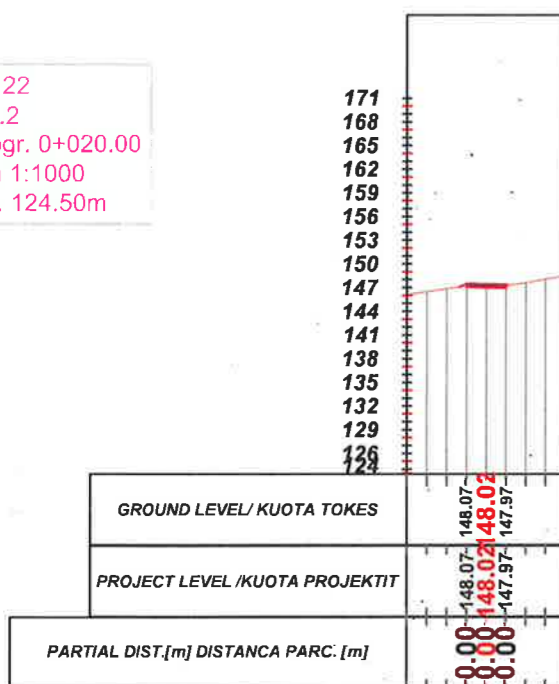

Aksi 22  
- Sez.4  
- Progr. 0+060.00  
Scala 1:1000  
Q.Rif. 121.50m

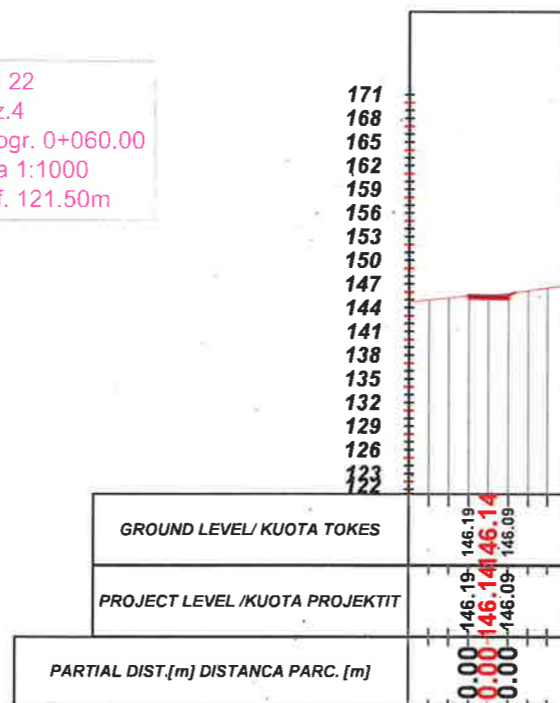

Aksi 22  
- Sez.6  
- Progr. 0+100.00  
Scala 1:1000  
Q.Rif. 121.50m

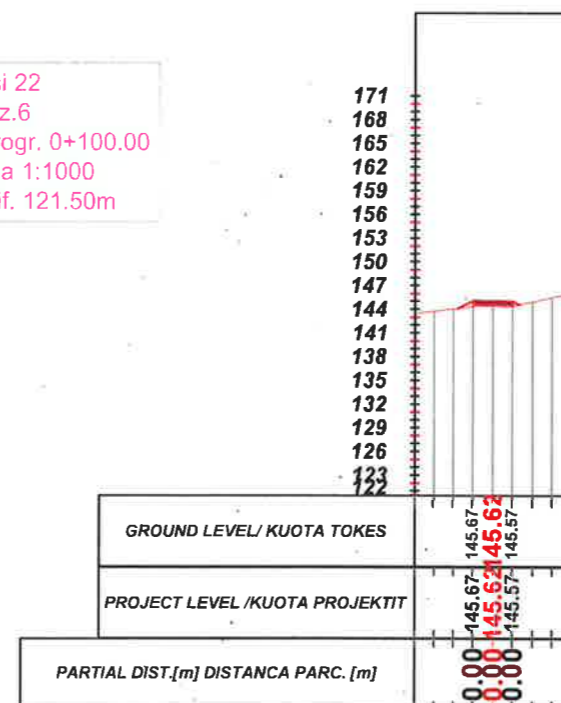

## LEGJENDA

- NIVELETA E RRUGES
- TERRENI NATYRAL



## BASHKIA KAMEZ

DREJTORIA E PROJEKTEVE DHE INVESTIMEVE  
DEPARTAMENTI I PROJEKTEVE

Dr. e Projekteve e Investimeve	RAMADAN HYSA	
Pergj. Sektori i Projekteve	DENIS PRENÇI	
STAFI TEKNIK	Ing. EMANUELA MËZIU	
PROJEKTUES	Ing. ARTUR ÇAJKA	
	Ing. ALEKS DANI	
	Ark. ESTELA GJYRIQI	

Titulli i Projektit	Faza e Projektit
NDERTIM RRUGËT "PASKUQAN I DHE 2"	PROJEKT ZBATIMI
Emertimi i Fletes	Data e implementimit :
PROFLET TËRTHORE	Shkalla e Vizatimit H 1:250
	Fleta Nr. 01 (101)

# PROFILE TËRTHORE AKSI 22

Aksi 22  
- Sez.7  
- Progr. 0+120.00  
Scala 1:1000  
Q.Rif. 121.50m

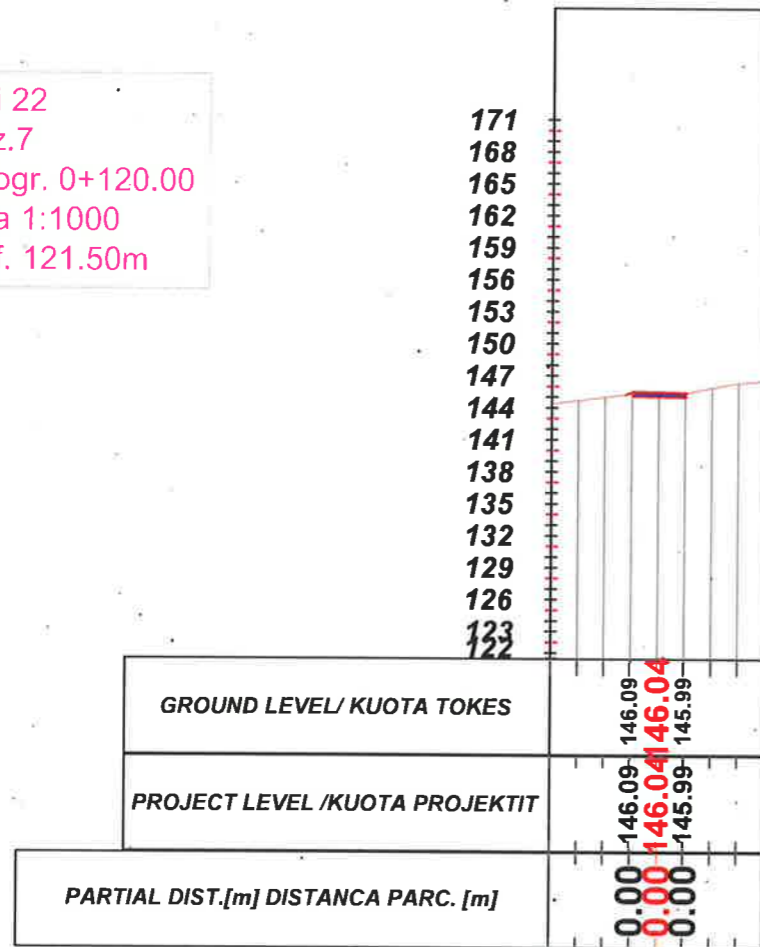

Aksi 22  
- Sez.9  
- Progr. 0+153.80  
Scala 1:1000  
Q.Rif. 121.50m

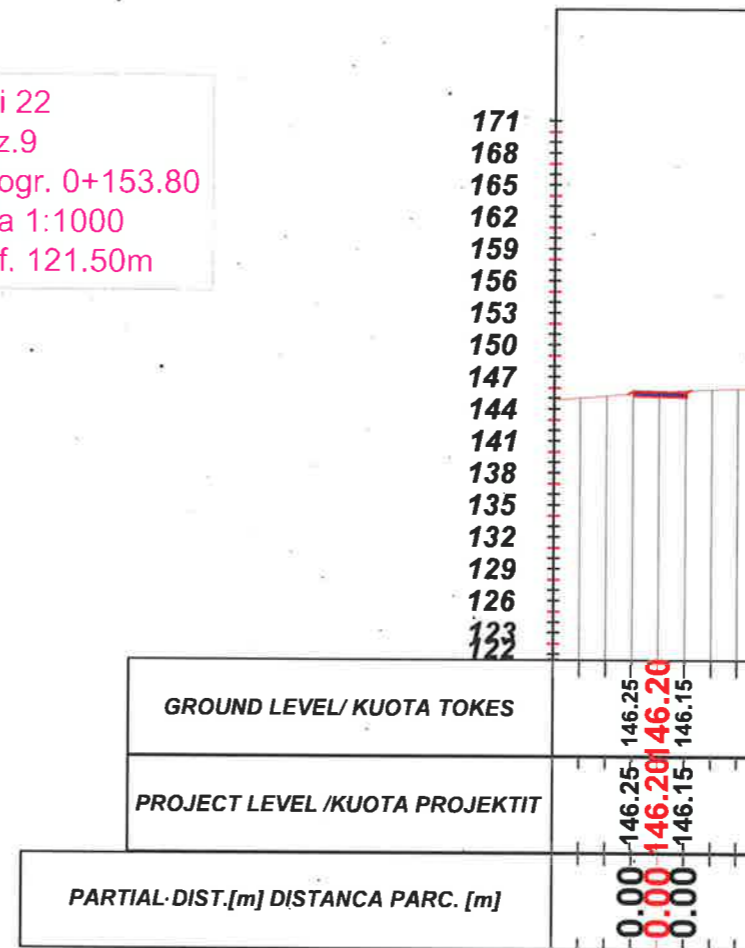

Aksi 22  
- Sez.8  
- Progr. 0+140.00  
Scala 1:1000  
Q.Rif. 121.50m

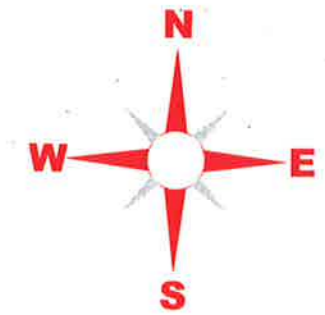
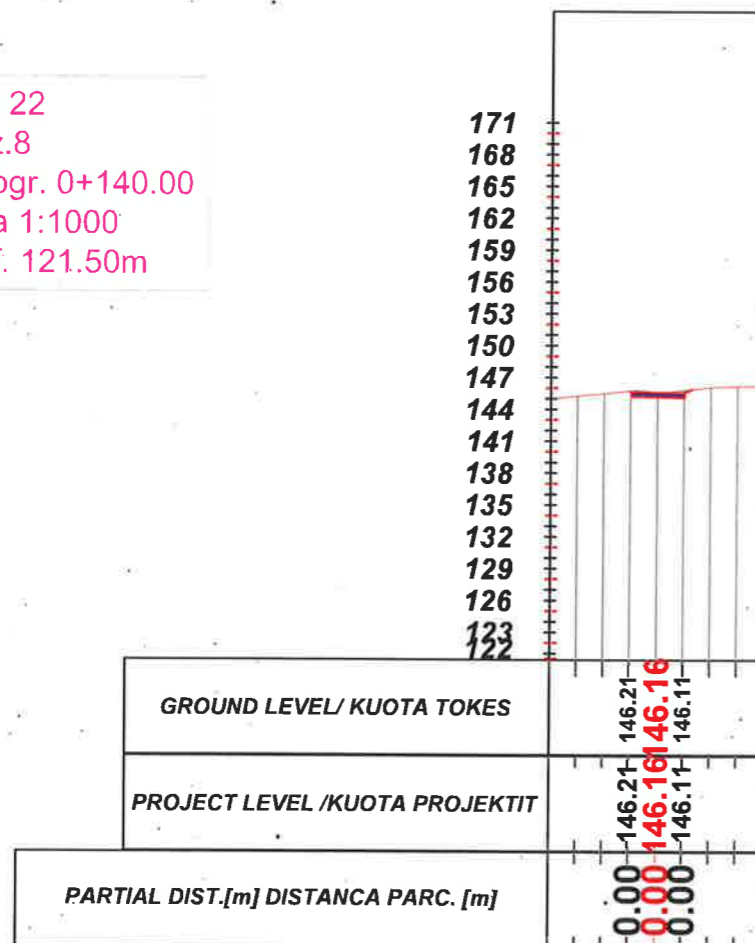

## LEGJENDA

- NIVELETA E RRUGES
- TERRENI NATYRAL



**BASHKIA KAMEZ**

DREJTORIA E PROJEKTEVE DHE INVESTIMEVE  
DEPARTAMENTI I PROJEKTEVE

Dr. e Projekteve e Investimeve	RAMADAN HYSA	
Pergj. Sektori i Projekteve	DENIS PRENÇI	
STAFI TEKNIK PROJEKTES	Ing. EMANUELA MËZIU	
	Ing. ARTUR ÇAJKA	
	Ing. ALEKS DANI	
Ark.	ESTELA GJYRIQI	

Titulli i Projektit		Faza e Projektit
NDERTIM RRUGËT "PASKUQAN 1 DHE 2"		PROJEKT ZBATIMI
Emertimi i Fletes		Data e Implementimit :
PROFILET TËRTHORE		Shkalla e Vizatimit
		H 1:250
		Fleta Nr.
		01 (102)

# PROFİLË TËRTHORE AKSI 23

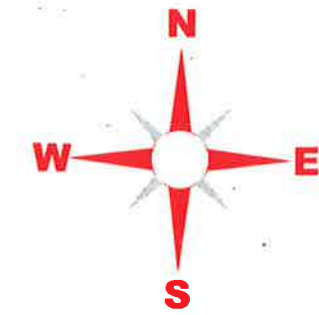

Aksi 23  
- Sez.1  
- Progr. 0+000.00  
Scala 1:1000  
Q.Rif. 127.50m

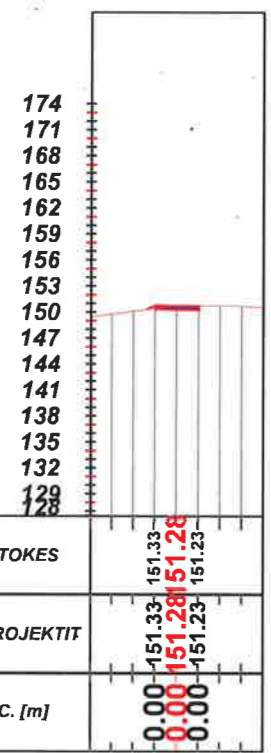

Aksi 23  
- Sez.3  
- Progr. 0+040.00  
Scala 1:1000  
Q.Rif. 124.50m

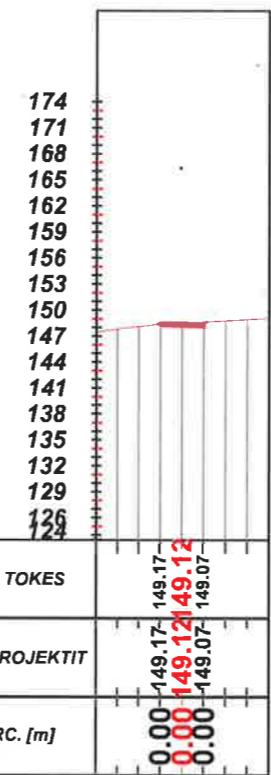

Aksi 23  
- Sez.5  
- Progr. 0+060.20  
Scala 1:1000  
Q.Rif. 124.50m

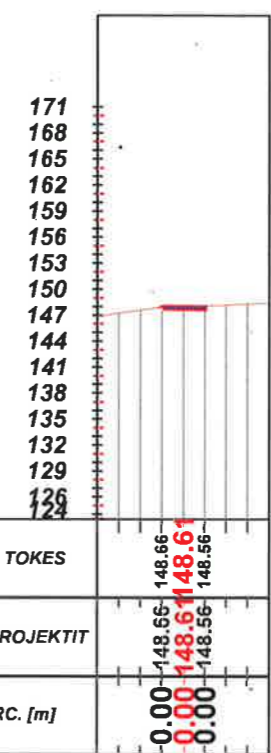

Aksi 23  
- Sez.2  
- Progr. 0+020.00  
Scala 1:1000  
Q.Rif. 124.50m

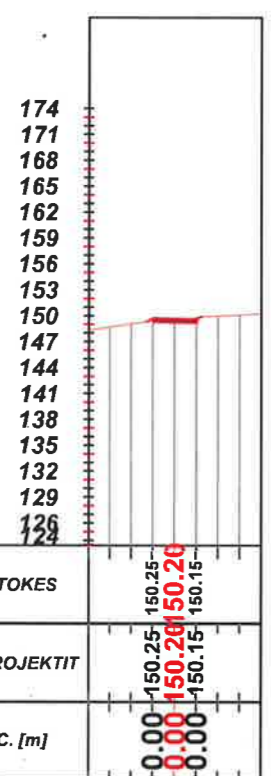

Aksi 23  
- Sez.4  
- Progr. 0+060.00  
Scala 1:1000  
Q.Rif. 124.50m

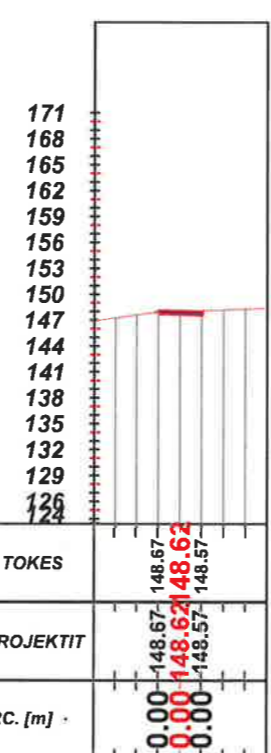

## LEGJENDA

- NIVELETA E RRUGES
- TERRENI NATYRAL



## BASHKIA KAMEZ

DREJTORIA E PROJEKTEVE DHE INVESTIMEVE  
DEPARTAMENTI I PROJEKTEVE

Dr. e Projekteve e Investimeve	RAMADAN HYSA	
Pergj. Sektori i Projekteve	DENIS PRENÇI	
STAFI TEKNIK PROJEKTUES	Ing. EMANUELA MËZIU	
	Ing. ARTUR ÇAJKA	
	Ing. ALEKS DANI	
	Ark. ESTELA GJYRIQI	

Titulli i Projektit	Faza e Projektit
NDERTIM RRUGËT "PASKUQAN 1 DHE 2"	PROJEKT ZBATIMI
Emertimi i Fletes	Data e Implementimit :
PROFILËT TËRTHORE	Shkalla e Vizimit H 1:250
	Fleta Nr. 01 (103)



BASHKIA KAMËZ

# PROJEKT ZBATIMI

## OBJEKTI:

NDERTIM DHE RIKONSTRUKSION RRUGËT BLOKU "BABRRU".

## 9. PROFILET TËRTHORE TIP



BASHKIA KAMËZ

DREJTORIA E PROJEKTEVE DHE INVESTIMEVE  
DEPARTAMENTI I PROJEKTEVE

Dr. e Projekteve e Investimeve	RAMADAN HYSA	
Prgj. Sektori i Projekteve	DENIS PRENÇI	
STAFI TEKNIK PROJEKTES	Ing. EMANUELA MEZIU	
	Ing. ARTUR ÇAJKA	
	Ing. ALEKS DANI	
	Ark. ESTELA GJYRIQI	

<b>Titulli i Projektit</b>	<b>Faza e Projektit</b>
NDËRTIM DHE RIKONSTRUKSION RRUGËT BLOKU "BABRRU".	PROJEKT ZBATIMI
<b>Emertimi i Fletes</b>	<b>Data e Implementimit:</b>
PROFILI TËRTHOR TIP	<b>Shkalla e Vizatimit</b>
	<b>Fleta Nr.</b>
	00

### PROFIL TËRTHOR TIP 1

OBJEKET: "Seg.1,2 Pingul Rruga Mustafa Matohiti", "Seg.Pingul Rr Mustafa Xhani", "Seg. 1,2,3,4,5,6 Pingul Koferenca e Mukjes", "Seg. 1,2,3 Pingul Halit Haxhia", "Rruga Piro Epirit", "Pjeter Buda", "Reshit Collaku", "Paralel Reshit Collaku", "Seg.Pingul Bilal Xhaferri", "Seg. Pingul Ibrahim Rugova", "Rruga Pingul Koferenca e Mukjes tek Shkolla Don Nikoll Kacorri", "Rr. Pingul Koferenca e Mukjes dhe Sado Koshenko", "Rruga Sado Koshenko", "Seg.1,2 pingul 28 Nentori", "Seg. Pingul Themistokli Germeji", "Xhemal Aranitasi", "Seg, Pingul Faik Kulla", "Seg. Pingul Perlat Rexhepi".

Sh-1:50

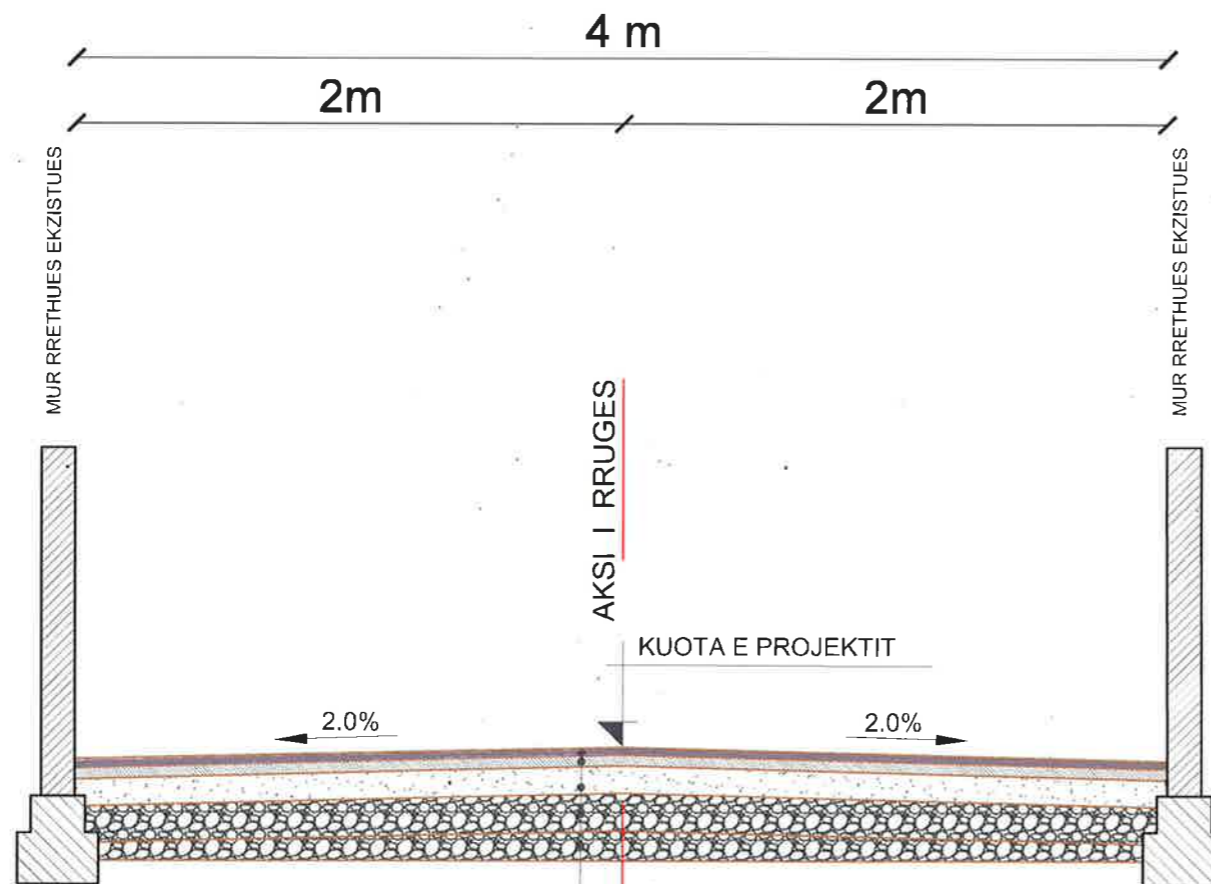

SHTRESE ASFALTOBETONI	3cm
SHTRESE BINDERI	5cm
SHTRESE STABILIZANTI	10cm
ÇAKELL MAKINERIE	20cm
CAKELL & GUR GURORE	~10 cm

**BASHKIA KAMËZ**  
 DREJTORIA E PROJEKTEVE DHE INVESTIMEVE  
 DEPARTAMENTI I PROJEKTEVE

Dr. e Projekteve e Investimeve	RAMADAN HYSA	<i>[Signature]</i>
Prgj. Sektori i Projekteve	DENIS PRENÇI	<i>[Signature]</i>
STA FI TEKNIK	Ing. EMANUELA MEZIU	<i>[Signature]</i>
PROJEKTUES	Ing. ARTUR ÇAJKA	<i>[Signature]</i>
	Ing. ALEKS DANI	<i>[Signature]</i>
	Ark. ESTELA GJYRIQI	<i>[Signature]</i>

Titulli i Projektit	Faza e Projektit
NDËRTIM DHE RIKONSTRUKSION RRUGËT BLOKU "BABRRU".	PROJEKT ZBATIMI
Emertimi / Fletes	Data e Implementimit:
PROFILI TËRTHOR TIP	Shkalla e Vizatimit
	Fleta Nr.
	<b>01</b>

**PROFIL TËRTHOR TIP 1/2**  
**OBJEKTI: Rruga "Paralel Reshit Collaku",**

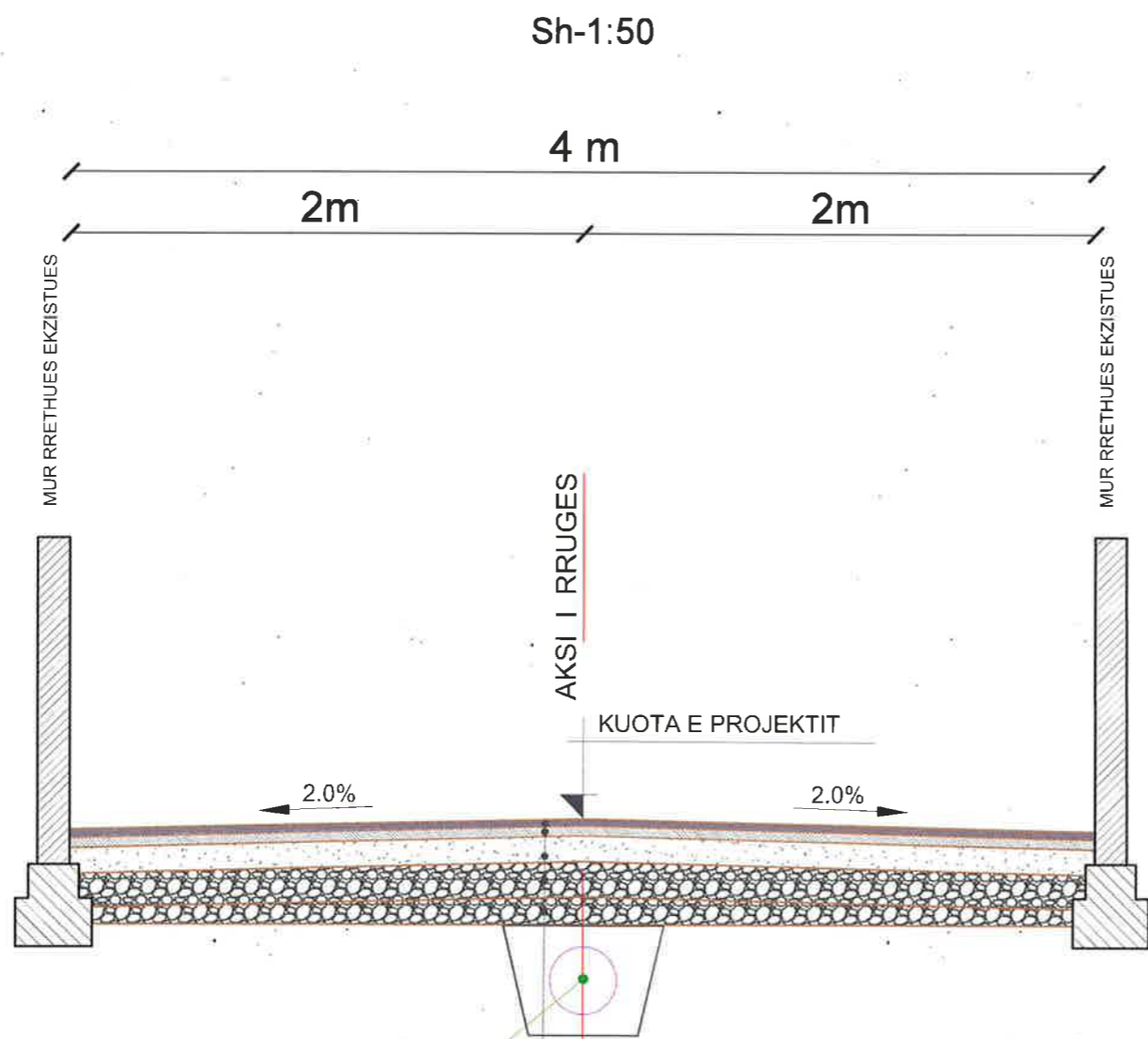

Linje KUZ, Ø315

SHTRESE ASFALTOBETONI	3cm
SHTRESE BINDERI	5cm
SHTRESE STABILIZANTI	10cm
ÇAKELL MAKINERIE	20cm
ÇAKELL & GUR GURORE	~10 cm



**BASHKIA KAMËZ**

DREJTORIA E PROJEKTEVE DHE INVESTIMEVE  
 DEPARTAMENTI I PROJEKTEVE

Dr. e Projekteve e Investimeve	RAMADAN HYSA	<i>[Signature]</i>
Prgj. Sektori i Projekteve	DENIS PRENÇI	<i>[Signature]</i>

STAFI TEKNIK PROJEKTUES	Ing.	EMANUELA MEZIU	<i>[Signature]</i>
	Ing.	ARTUR ÇAJKA	
	Ing.	ALEKS DANI	
	Ark.	ESTELA GJYRIQI	

Titulli i Projektit	Phaza e Projektit
NDËRTIM DHE RIKONSTRUKSION RRUGËT BLOKU "BABRRU".	PROJEKT ZBATIMI
Emertimi / Faza	Data e Implementimit:
PROFILI TËRTHOR TIP	Shkalla e Vizatimit:
	Fleta Nr.

PROFIL TËRTHOR TIP 2  
NDËRTIM RRUGA FAIK KULLA

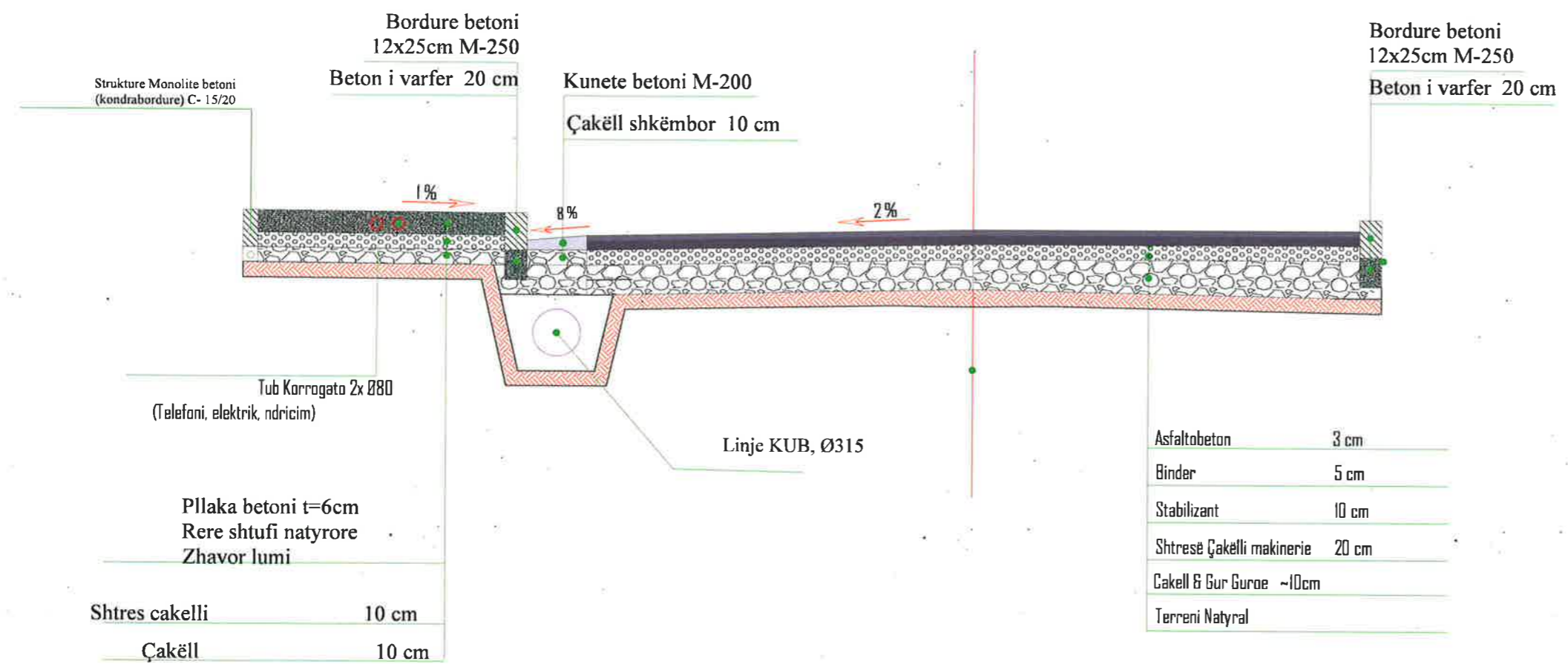
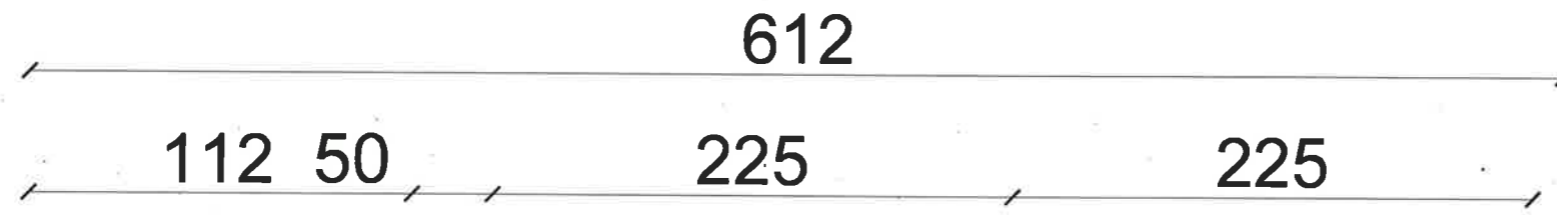

**BASHKIA KAMËZ**  
DREJTORIA E PROJEKTEVE DHE INVESTIMEVE  
DEPARTAMENTI I PROJEKTEVE

Dr. e Projekteve e Investimeve	RAMADAN HYSA	<i>[Signature]</i>
Prgj. Sektori i Projekteve	DENIS PRENÇI	<i>[Signature]</i>
STAFI TEKNIK PROJEKTES	Ing. EMANUELA MEZIU	<i>[Signature]</i>
	Ing. ARTUR ÇAJKA	<i>[Signature]</i>
	Ing. ALEKS DANI	<i>[Signature]</i>
Ark.	ESTELA GJYRIQI	<i>[Signature]</i>

Titulli i Projektit	Faza e Projektit
NDËRTIM DHE RIKONSTRUKSION RRUGËT BLOKU "BABRRU".	PROJEKT ZBATIMI
Emerëtimi i Fietes	Data e Implementimit:
PROFILI TËRTHOR TIP	Shkalla e Vizatimit:
	Fleta Nr.
	<b>03</b>

PROFIL TËRTHOR TIP 3  
 NDËRTIM TROTUAR + KUB + RIASFALTIM RRUGA "MUSTAFA MATOHITI"

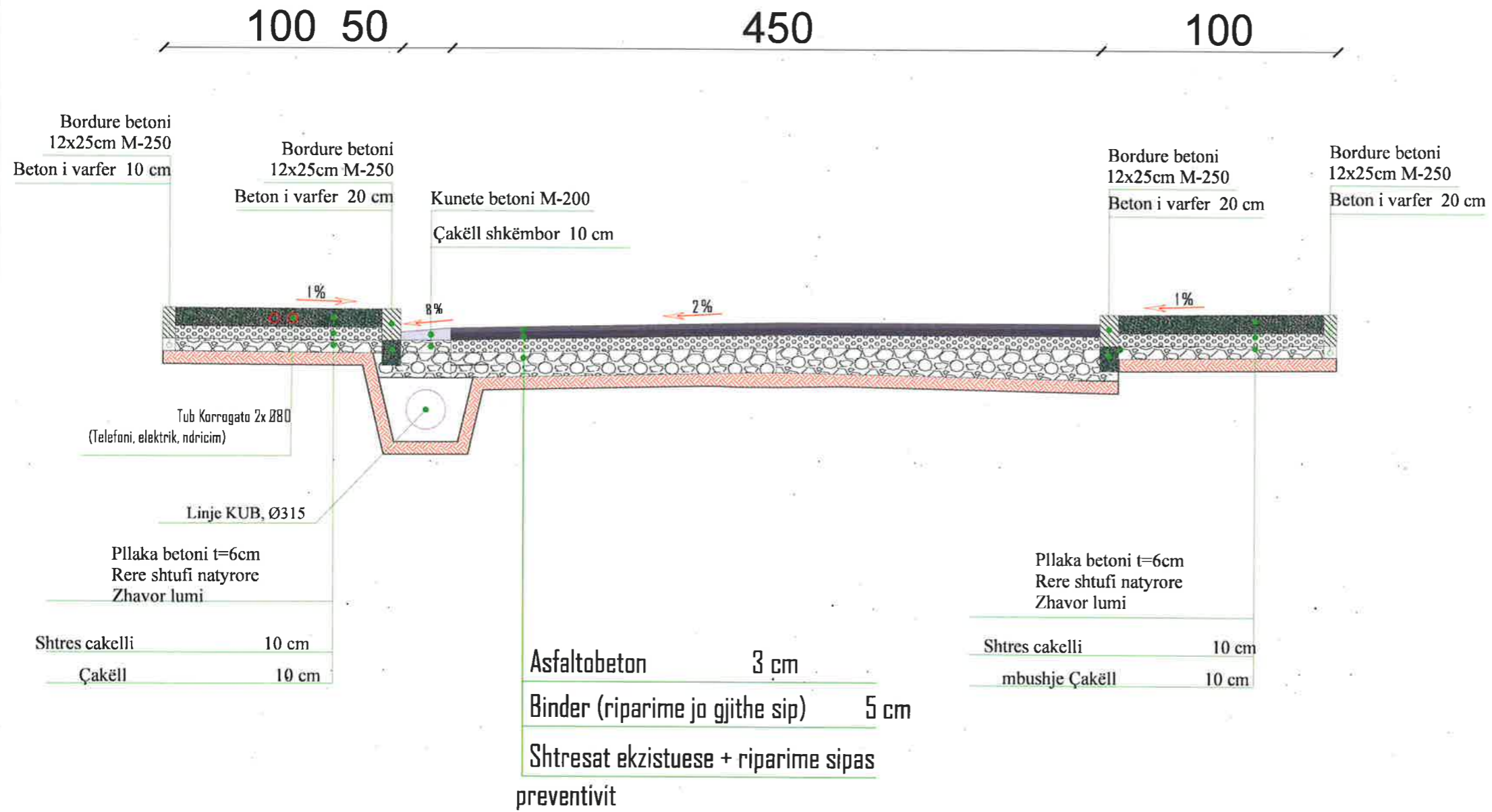

**BASHKIA KAMËZ**  
 DREJTORIA E PROJEKTEVE DHE INVESTIMEVE  
 DEPARTAMENTI I PROJEKTEVE

Dr. e Projekteve e Investimeve	RAMADAN HYSA	<i>[Signature]</i>
Prgj. Sektori i Projekteve	DENIS PRENÇI	<i>[Signature]</i>
STAFI TEKNIK PROJEKTES	Ing.	EMANUELA MEZIU
	Ing.	ARTUR ÇAJKA
	Ing.	ALEKS DANI
	Ark.	ESTELA GJYRIQI

Titulli i Projektit	Faza e Projektit
NDËRTIM DHE RIKONSTRUKSION RRUGËT BLOKU "BABRRU".	PROJEKT ZBATIMI
Emertimi i Fletës	Data e Implementimit:
PROFILI TËRTHOR TIP	Shkallja e Vizatimit:
	Fleta Nr.
	<b>04</b>

**PROFIL TERTHOR TIP 4**  
**RIASFALTIM+NDERTIM TROTUARE+ KUB RRUGA HALIT HAXHIA L=700 ML AKSI 1**

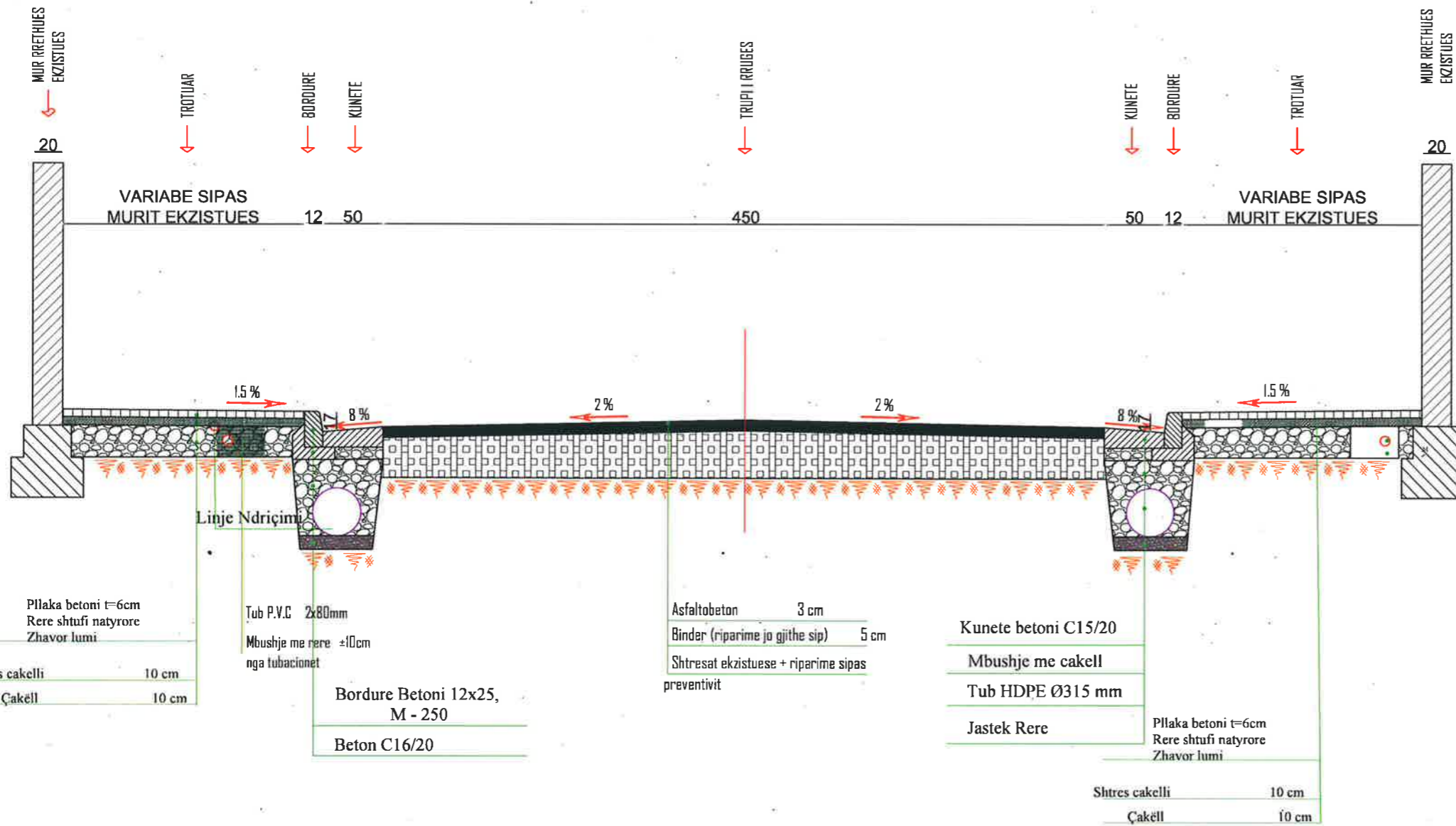

**BASHKIA KAMËZ**  
DREJTORIA E PROJEKTEVE DHE INVESTIMEVE  
DEPARTAMENTI I PROJEKTEVE

Dr. e Projekteve e Investimeve	RAMADAN HYSA	<i>[Signature]</i>
Prgj. Sektori i Projekteve	DENIS PRENÇI	<i>[Signature]</i>
STAFI TEKNIK	Ing. EMANUELA MEZIU	<i>[Signature]</i>
PROJEKTUES	Ing. ARTUR ÇAJKA	<i>[Signature]</i>
	Ing. ALEKS DANI	<i>[Signature]</i>
	Ark. ESTELA GJYRIQI	<i>[Signature]</i>

Titulli i Projektit	Faza e Projektit
NDËRTIM DHE RIKONSTRUKSION RRUGËT BLOKU "BABRRU".	PROJEKT ZBATIMI
Emerënji i Fletës	Data e implementimit:
PROFILI TËRTHOR TIP	Shkalla e Vizatimit
	Fleta Nr.
	<b>05</b>

**PROFIL TERTHOR TIP 4/1**  
**RIASFALTIM+NDERTIM TROTUARE+ KUB RRUGA HALIT HAXHIA L=700 ML AKSI 1**

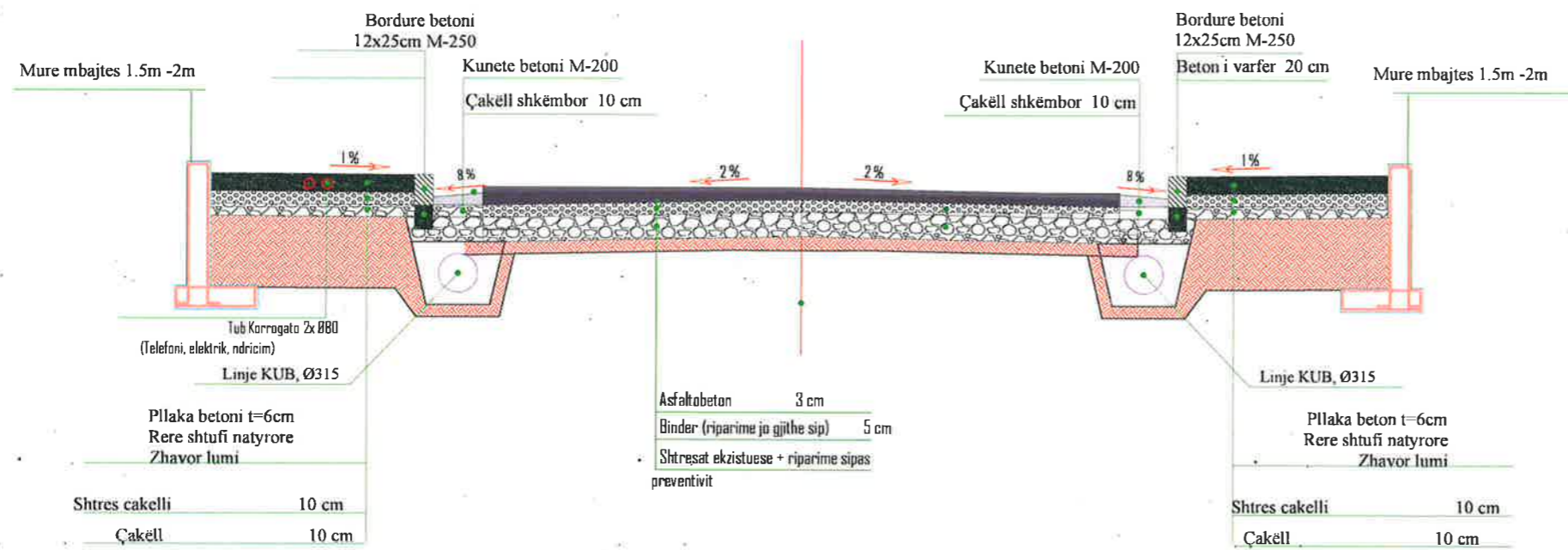

**BASHKIA KAMËZ**

DREJTORIA E PROJEKTEVE DHE INVESTIMEVE  
 DEPARTAMENTI I PROJEKTEVE

Dr. e Projekteve e Investimeve	RAMADAN HYSA	<i>[Signature]</i>
Prgj. Sektori i Projekteve	DENIS PRENÇI	<i>[Signature]</i>
STAFI TEKNIK PROJEKTES	Ing. EMANUELA MEZIU	<i>[Signature]</i>
	Ing. ARTUR ÇAJKA	
	Ing. ALEKS DANI	
	Ark. ESTELA GJYRIQI	
Titulli i Projektit		Phaza e Projektit
NDËRTIM DHE RIKONSTRUKSION RRUGËT BLOKU "BABRRU".		PROJEKT ZBATIMI
Emertimi / Fletës		Data e Implementimit:
PROFILI TËRTHOR TIP		Shkalla e Vizatimit
		Fleta Nr.
		<b>06</b>

**PROFIL TËRTHOR TIP 5**  
**NDËRTIM TROTUARE+ KUB RRUGA HALIT HAXHIA L=692 ML AKSI 2**

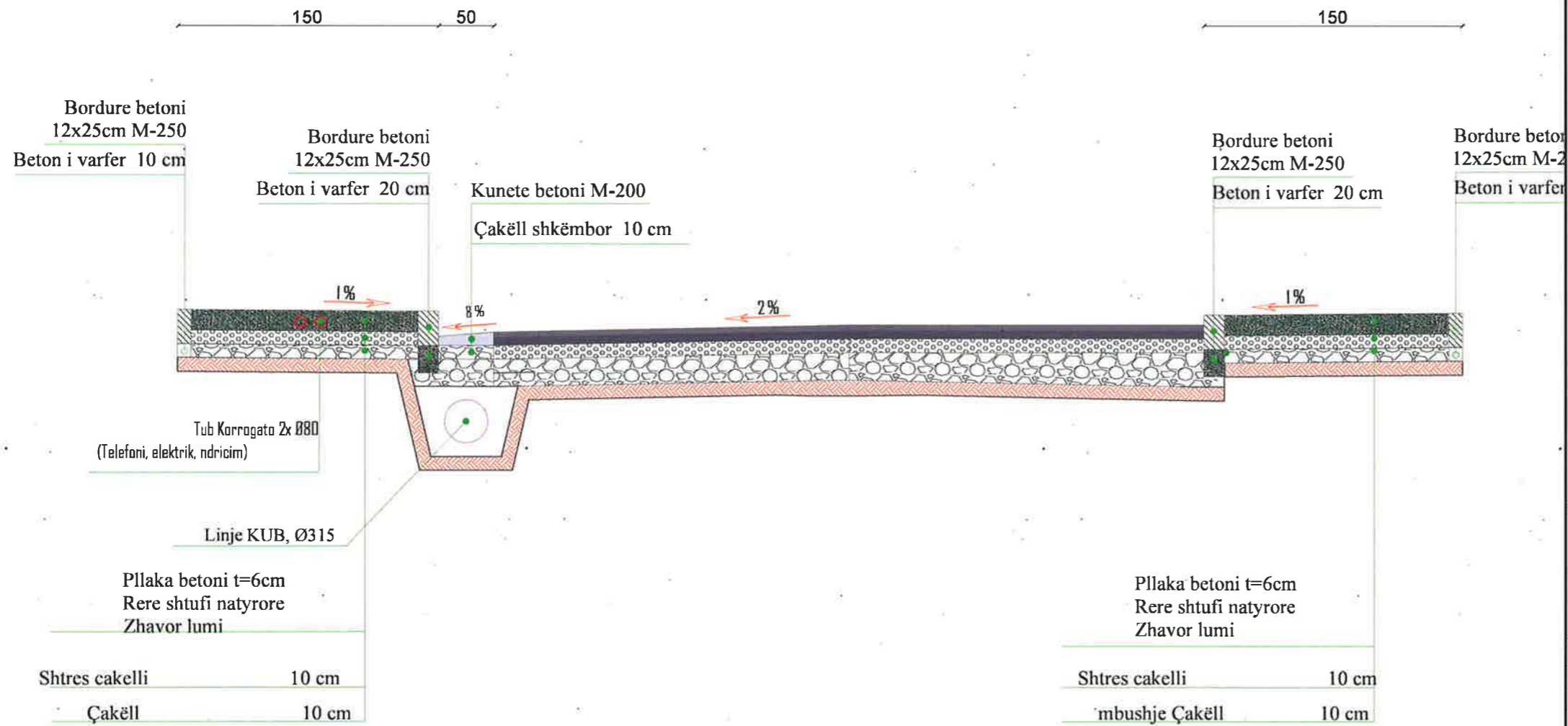

**BASHKIA KAMËZ**  
 DREJTORIA E PROJEKTEVE DHE INVESTIMEVE  
 DEPARTAMENTI I PROJEKTEVE

Dr. e Projekteve e Investimeve	RAMADAN HYSA	
Prgj. Sektori i Projekteve	DENIS PRENÇI	
STAFI TEKNIK PROJEKTUES	Ing. EMANUELA MEZIU	
	Ing. ARTUR ÇAJKA	
	Ing. ALEKS DANI	
	Ark. ESTELA GJYRIQI	

Titulli i Projektit	NDËRTIM DHE RIKONSTRUKSION RRUGËT BLOKU "BABRRU".
Emertimi i Fielës	PROFILI TËRTHOR TIP
Paza e Përfunduar	PROJEKT ZBATIMI
Date e Implementimit:	
Shkalla e Vizatimit	
Fleta Nr.	<b>07</b>

# NDERTIM TROTUARE+ KUB RRUGA HALIT HAXHIA L=692 ML AKSI 2

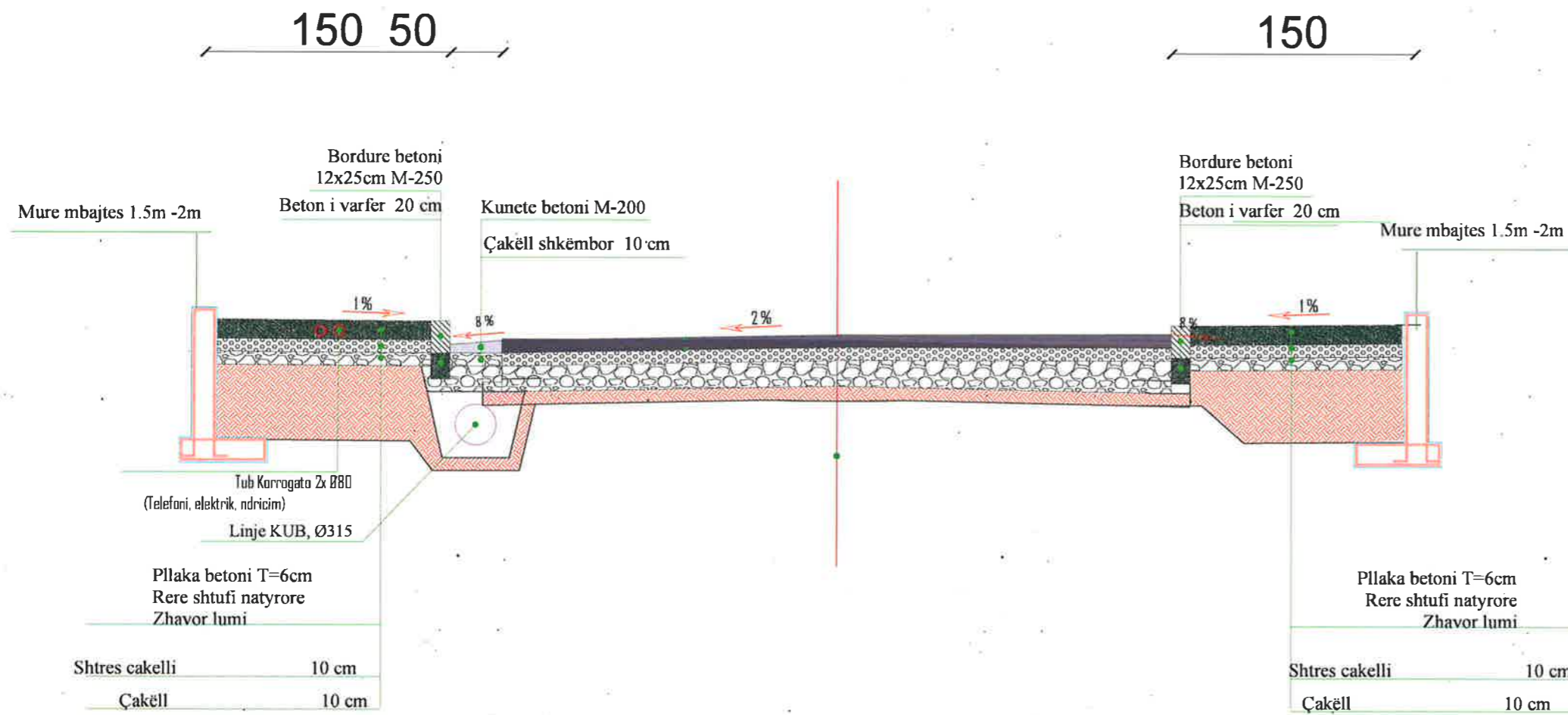

**BASHKIA KAMËZ**  
 DREJTORIA E PROJEKTEVE DHE INVESTIMEVE  
 DEPARTAMENTI I PROJEKTEVE

Dr. e Projekteve e Investimeve	RAMADAN HYSA	<i>[Signature]</i>
Prgj. Sektori i Projekteve	DENIS PRENÇI	<i>[Signature]</i>
STAFI TEKNIK	Ing. EMANUELA MEZIU	<i>[Signature]</i>
PROJEKTUES	Ing. ARTUR ÇAJKA	
	Ing. ALEKS DANI	
	Ark. ESTELA GJYRIQI	<i>[Signature]</i>

<b>Titulli i Projektit</b>	<b>Faza e Projektit</b>
NDËRTIM DHE RIKONSTRUKSION RRUGËT BLOKU "BABRRU".	PROJEKT ZBATIMI
<b>Emertimi i Fietes</b>	<b>Data e Implementimit:</b>
PROFILI TËRTHOR TIP	<b>Shkalla e Vizatimit</b>
	<b>Fleta Nr.</b>
	08

**PROFIL TËRTHOR TIP 6**  
**RIASFALTIM RRUGET "SALI MURAT VRANISHTIM, TAJAR ZAVALANI, PJETER ARBNORI, KERCIKVE, PINGUL XHEMALI DERVISHI, KOFERENCA E MUKJES "**

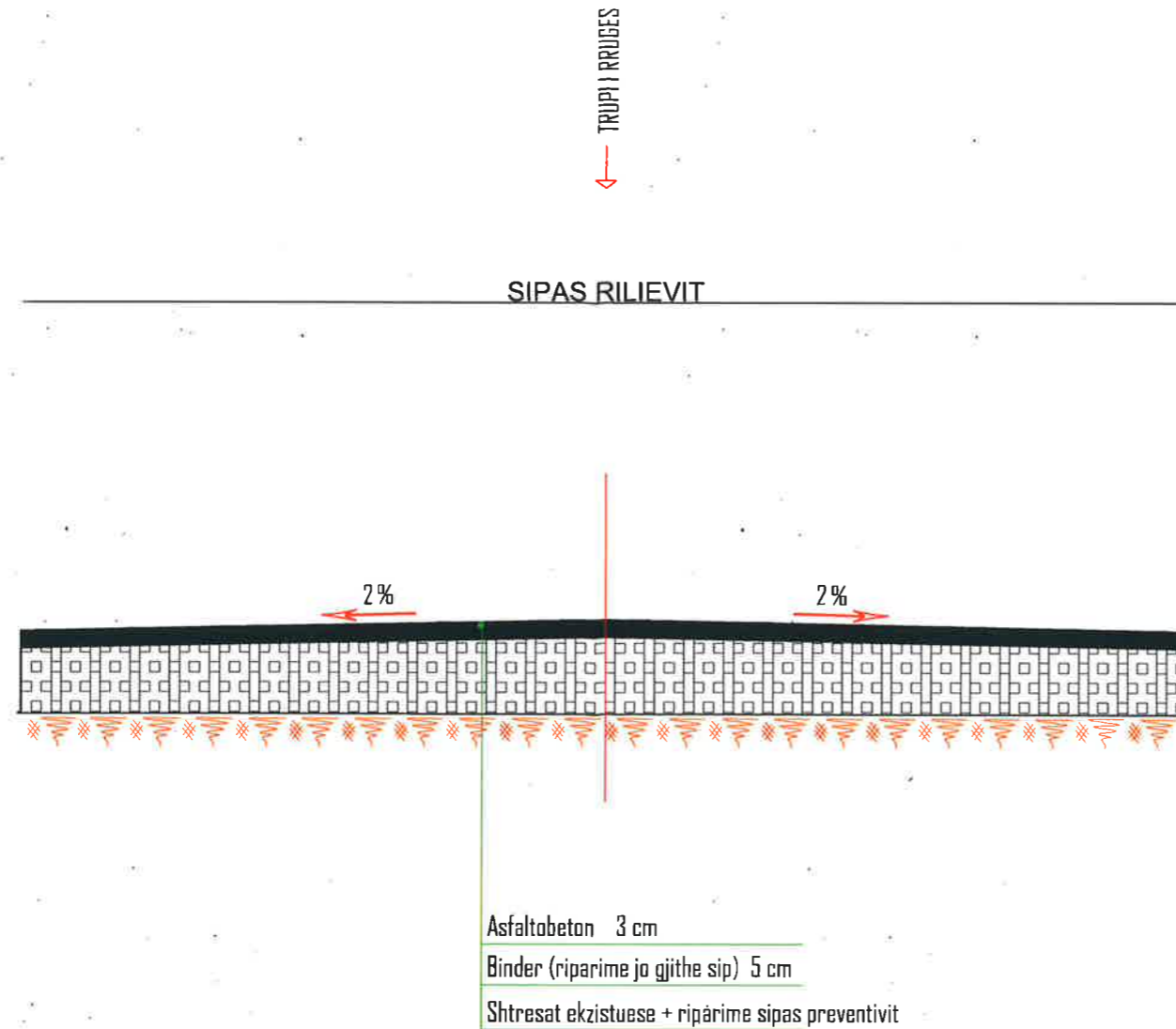

**BASHKIA KAMËZ**  
 DREJTORIA E PROJEKTEVE DHE INVESTIMEVE  
 DEPARTAMENTI I PROJEKTEVE

Dr. e Projekteve e Investimeve	RAMADAN HYSA	<i>[Signature]</i>
Prgj. Sektori i Projekteve	DENIS PRENÇI	<i>[Signature]</i>
STAFI TEKNIK PROJEKTUES	Ing. EMANUELA MEZIU	<i>[Signature]</i>
	Ing. ARTUR ÇAJKA	<i>[Signature]</i>
	Ing. ALEKS DANI	<i>[Signature]</i>
Ark. ESTELA GJYRIQI		<i>[Signature]</i>

<b>Titulli i Projektit</b> NDËRTIM DHE RIKONSTRUKSION RRUGËT BLOKU "BABRRU".	<b>Faza e Projektit</b> PROJEKT ZBATIMI
<b>Emertimi i Fletës</b> PROFILI TËRTHOR TIP	<b>Data e Implementimit:</b>  <b>Shkalla e Vizatimit</b>  <b>Fleta Nr.</b> 09

## PROFIL TERTHOR TIP 7 NDERTIM TROTUARE+ KUB RRUGA KOFERENCA E MUKJES L=1944 ML

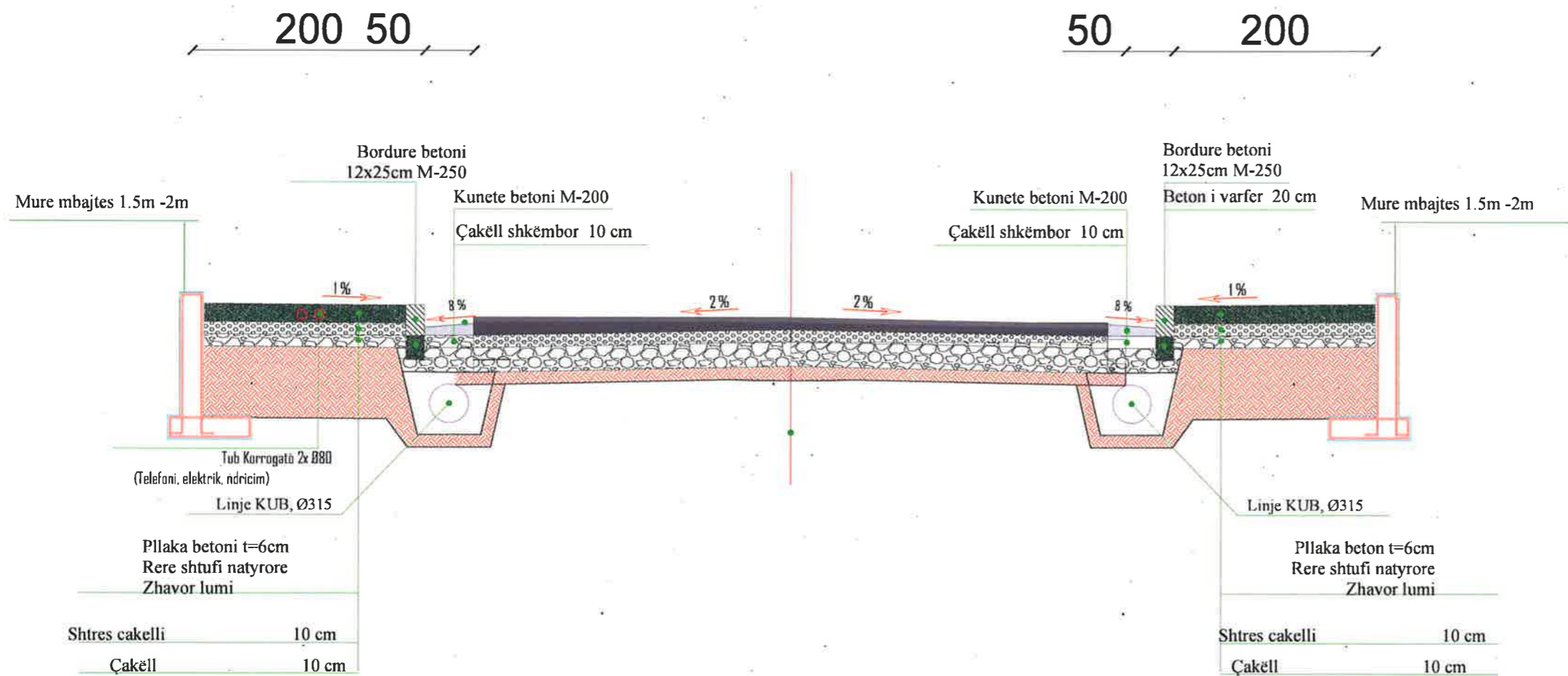

**BASHKIA KAMËZ**

DREJTORIA E PROJEKTEVE DHE INVESTIMEVE  
DEPARTAMENTI I PROJEKTEVE

Dr. e Projekteve e Investimeve	RAMADAN HYSA	
Prgj. Sektori i Projekteve	DENIS PRENÇI	
STAFI TEKNIK PROJEKTUES	Ing. EMANUELA MEZIU	
	Ing. ARTUR ÇAJKA	
	Ing. ALEKS DANI	
Ark.	ESTELA GJYRIQI	

Titulli i Projektit	NDËRTIM DHE RIKONSTRUKSION RRUGËT BLOKU "BABRRU".
Faza e Projektit	PROJEKT ZBATIMI
Data e implementimit:	
Shkalla e Vizatimit	
Emertimi i Fildes	PROFILI TËRTHOR TIP
Fleta Nr.	10

PROFIL TERTHOR TIP 8  
 NDERTIM TROTUAR RRUGET:  
 "MUSTAFA KRUJA, "

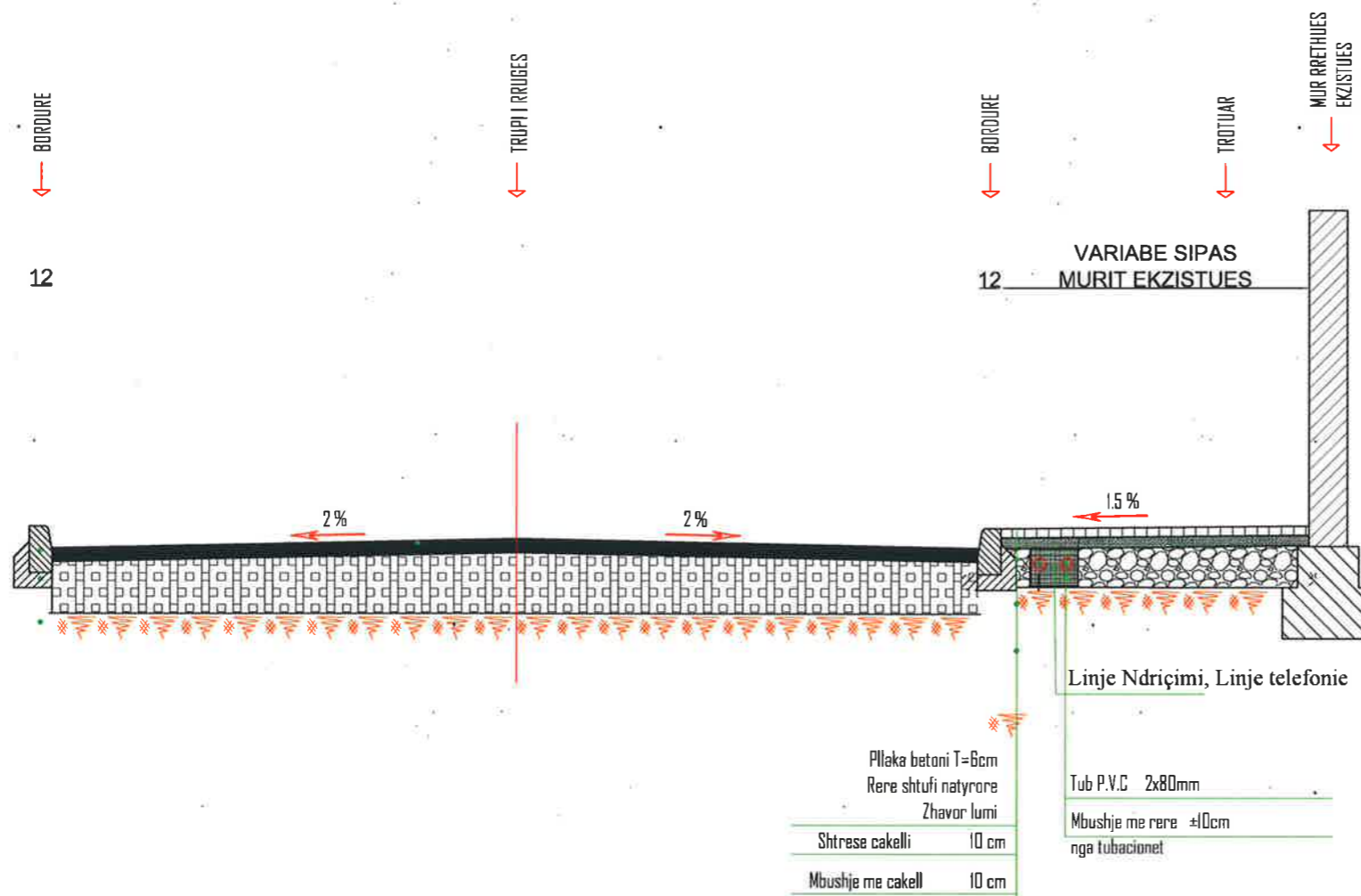

**BASHKIA KAMËZ**  
 DREJTORIA E PROJEKTEVE DHE INVESTIMEVE  
 DEPARTAMENTI I PROJEKTEVE

Dr. e Projekteve e Investimeve	RAMADAN HYSA
Prgj. Sektori i Projekteve	DENIS PRENÇI
STAFI TEKNIK PROJEKTORES	Ing. EMANUELA MEZIU Ing. ARTUR ÇAJKA Ing. ALEKS DANI Ark. ESTELA GJYRIQI

Titulli i Projektit	Faza e Projektit
NDËRTIM DHE RIKONSTRUKSION RRUGËT BLOKU "BABRRU".	PROJEKT ZBATIMI
Emeritimi i Fletës	Data e implementimit:
PROFILI TËRTHOR TIP	Shkalla e Vizatimit
	Fleta Nr.



BASHKIA KAMËZ

# PROJEKT ZBATIMI

**OBJEKTI:**

RIKONSTRUKSOON DHE NDERTIM RRUGËT BLOKU "BABRRU".

10. DETAJE



**BASHKIA KAMËZ**

DREJTORIA E PROJEKTEVE DHE INVESTIMEVE  
DEPARTAMENTI I PROJEKTEVE

Dr. e Projekteve e Investimeve	RAMADAN HYSA	
Përgj. Sekl. i Projekteve	DENIS PRENÇI	
STAFI TEKNIK PROJEKTES	Ing. EMANUELA MËZIU	
	Ing. ARTUR ÇAJKA	
	Ing. ALEKS DANI	
	Ark. ESTELA GJYRIQI	

<b>Titulli i Projektit</b> NDËRTIM RRUGËT BLOKU "BABRRU".	<b>Faza e Projektit</b> PROJEKT ZBATIMI
<b>Emerën timer i Fletes</b> <b>DETAJET</b>	<b>Data e Implementimit :</b> <b>Shtkalla e Vizatimit</b> <b>Fleta Nr.</b> <b>KAPAKU</b>

# DETAJE KUB

PLANI I PUSITES KUSH  
SH- 1:25

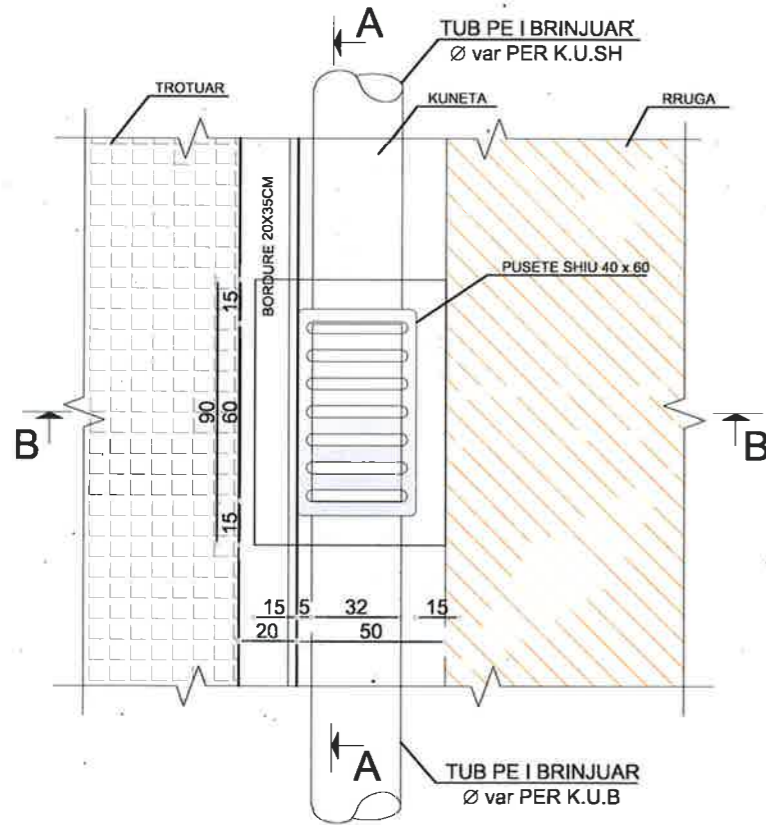

PRERJE B-B  
(PER TUBA HDPE D=315MM)  
SH- 1:25

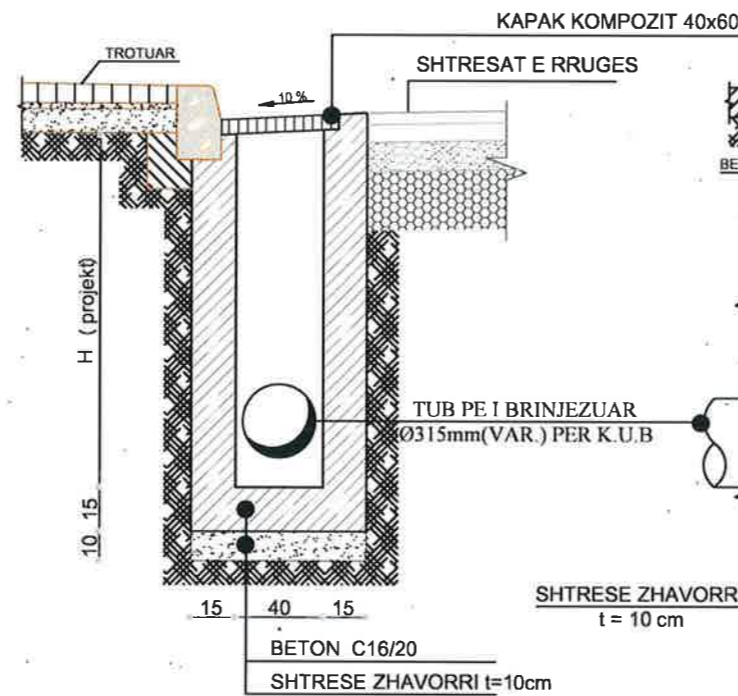

PRERJE A-A  
SH- 1:25

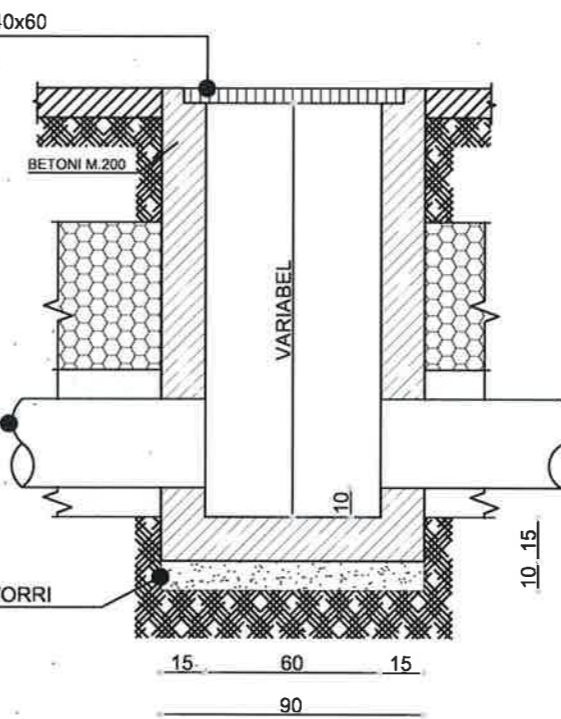

ZGARE GIZE 40X60cm  
SH- 1:25

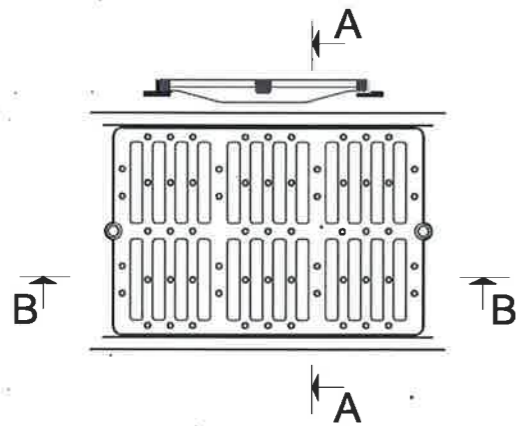

PRERJE A-A



PRERJE B-B

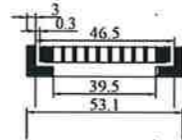

## SHËNIME TEKNIKE :

- Muret e pusetes do te jene beton C16/20 dhe me trashesi 15cm.
- Telajo e kapakut do te jete gize i inkastruar me brezin e betonit dhe i vendosur ne nivelin e mbaruar te rruges sipas projektit.
- Fundi i tubit duhet te jete 10cm nga fundi i pusetes.
- Diametri i tubit do te jete sipas projektit ne plan.

- NE KETE FLETE JANE PARAQITUR DETAJET E NDERTIMIT TE PUSITES SE MBLEDHJES SE UJRAVE TE SHIUT TIP 60 x40 cm ME KAPAK GIZE, TIPI P-1. KETO LLOJ PUSETASH DO TE NDERTOHEN NE TE DY ANET E RRUGES NE DISTANCEN SIKUNDER JEPET NE PLANIMETRINE E KANALIZIMIT TE UJRAVE TE SHIUT.
- ZGARA KOMPOZITE TE JETE E FIKSUAR ME MENTESHE NE SKATULL, NDERSA KJO E FUNDIT DUHET TE JETE FIKSUAR MIRE NE BETON PER TE MOS U VJEDHUR.

## SHENIME TEKNIKE

- NE KETE FLETE PROJEKTI ESHTHE DHENE SEKSIONI MINIMAL PER GERMINIM E KANALEVE PER KULLIMIN E UJRAVE TE SHIUT PER KATESISHT PER TUBA ME D=315 mm, PER D<sub>1</sub>=400 mm dhe per D<sub>2</sub>=500mm. ESHTHE KUSHT PER MBROJTJEN E TUBAVE NGA KALIMI I MJETEVE. NE RRUGE QE TRASHESIA E MBUSHJEVE MBI TUB TE JETE JO ME PAK SE 80 cm. ATJE KU KJO TRASHESIA NUK REALIZOHET DUHET QE TE NDERTOHEJ NJE SHITRESE BETONI ME TRASHESI 20 cm ARMUAR ME RRJETE HEKURI ME D= 8 mm (20 x20) cm.



**BASHKIA KAMËZ**

DREJTORIA E PROJEKTEVE DHE INVESTIMEVE  
DEPARTAMENTI I PROJEKTEVE

Dr. e Projekteve e Investimeve	RAMADAN HYSA	
Përgj. Sekt. i Projekteve	DENIS PRENÇI	
STAFI TEKNIK PROJEKTUES	Ing. EMANUELA MËZIU	
	Ing. ARTUR ÇAJKA	
	Ing. ALEKS DANI	
	Ark. ESTELA GJYRIQI	

Titulli i Projektit	PROJEKT ZBATIMI
NDËRTIM RRUGËT BLOKU "BABRRU".	Date e implementimit :
Emertimi i Fletes	Shkalla e Vizatimit 1:25
DETAJE KUB	Fleta Nr. 01

**PAMJE E BORDURAVE DHE TROTUARIT**

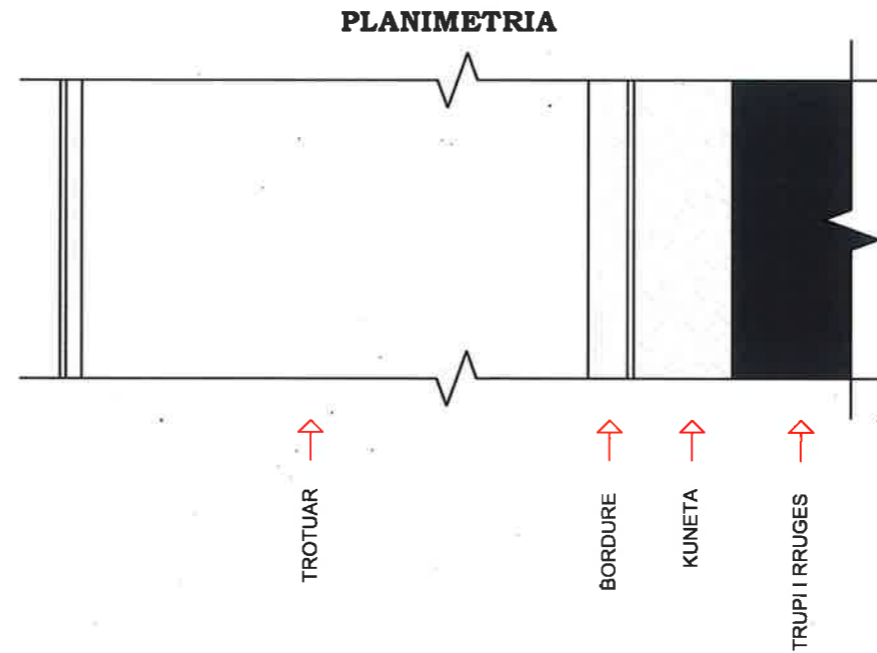
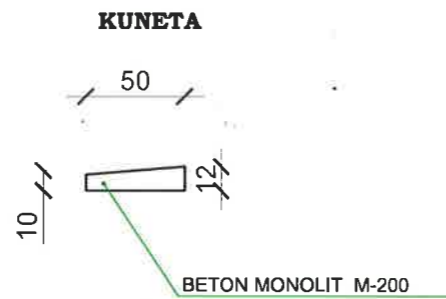
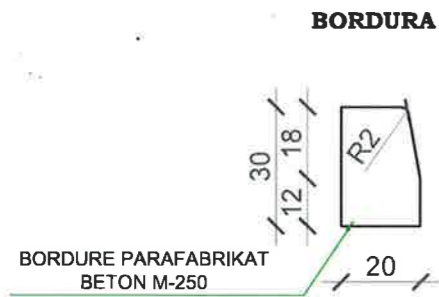
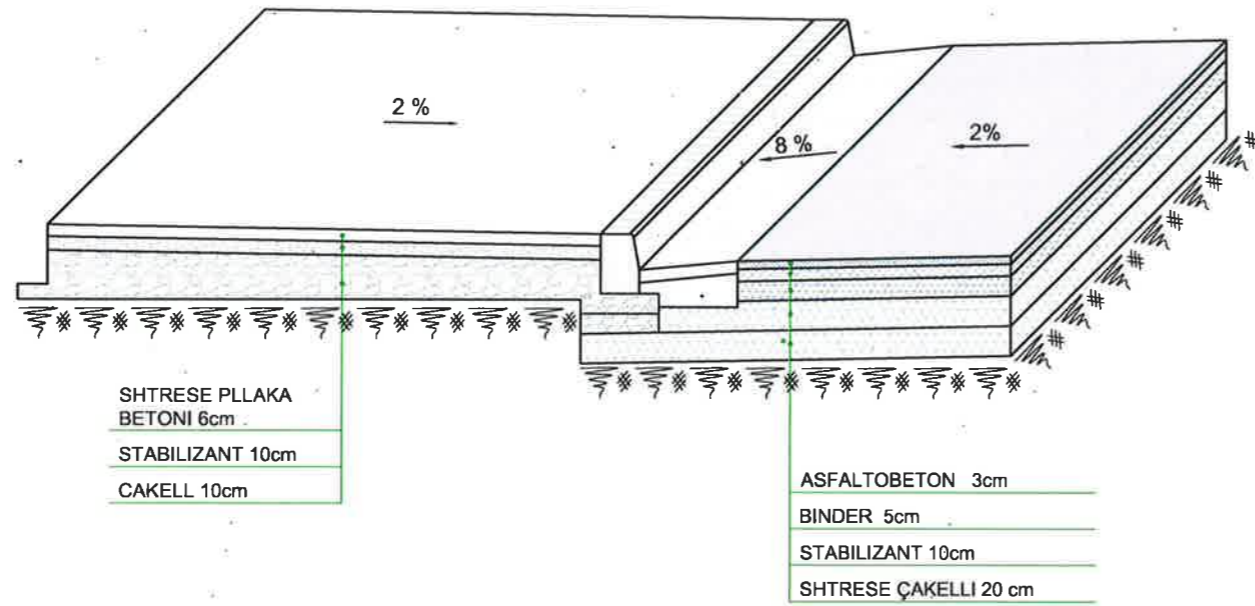

**SHENIME :**

- Hapesira midis fugave mbushet me rere.
- Ne rastet kur trotuari kufizohet me objekte ose mure rrethues, bordura nga ana e jashtme nuk vendoset.

**BASHKIA KAMËZ**  
DREJTORIA E PROJEKTEVE DHE INVESTIMEVE  
DEPARTAMENTI I PROJEKTEVE

Dr. e Projekteve e Investimeve	RAMADAN HYSA		
Përgj. Sekt. i Projekteve	DENIS PRENÇI		
STAFI TEKNIK PROJEKTES	Ing.	EMANUELA MËZIU	
	Ing.	ARTUR ÇAJKA	
	Ing.	ALEKS DANI	
	Ark.	ESTELA GJYRIQI	

Titulli i Projektit	Faza e Projektit
NDËRTIM RRUGËT BLOKU "BABRRU".	PROJEKT ZBATIMI
Emertimi i Fletes	Data e Implementimit :
DETAJE BORDURA DHE TROTUARI	Shkalla e Vizatimit
	1:25
	Fleta Nr.
	02

# DETAJI PANDUSIT

PRERJA A-A SHK.1:50

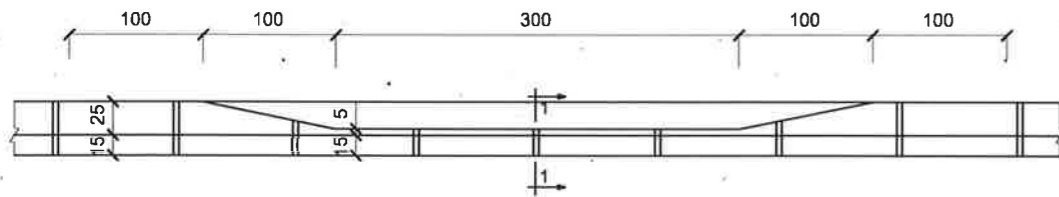

PLAN SHK.1:50

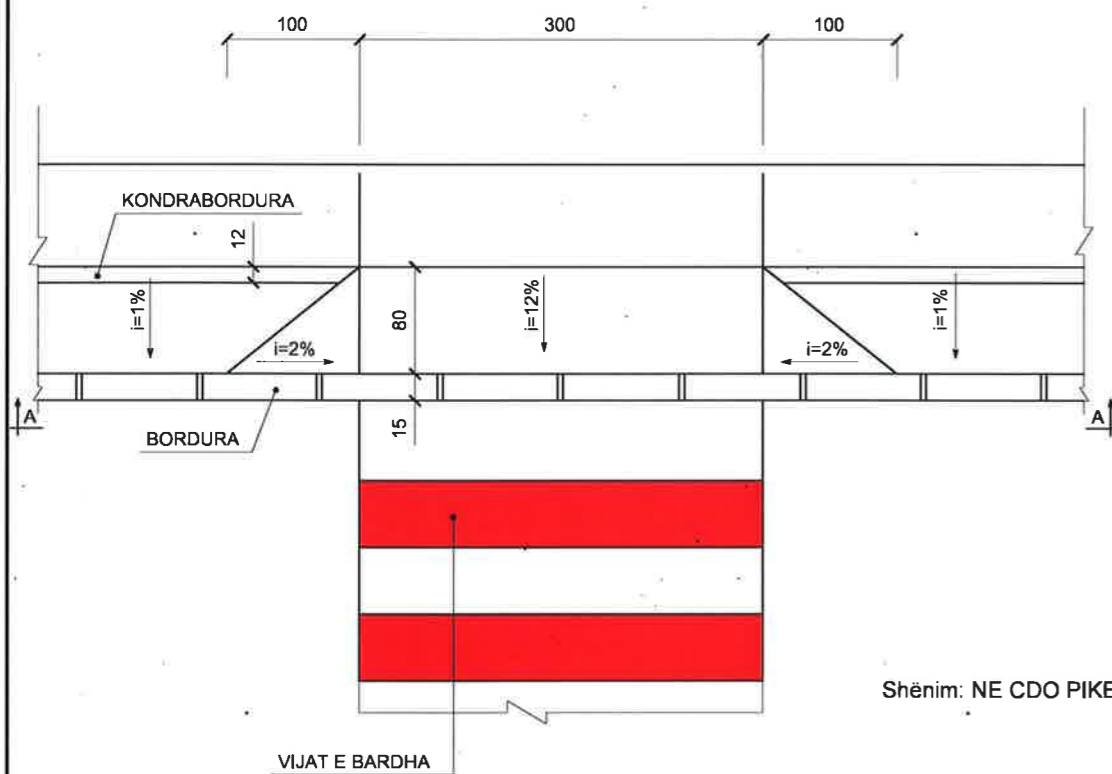

## DETAJI I PRERJES SE RRUGES ME PANDUS Sh 1:15

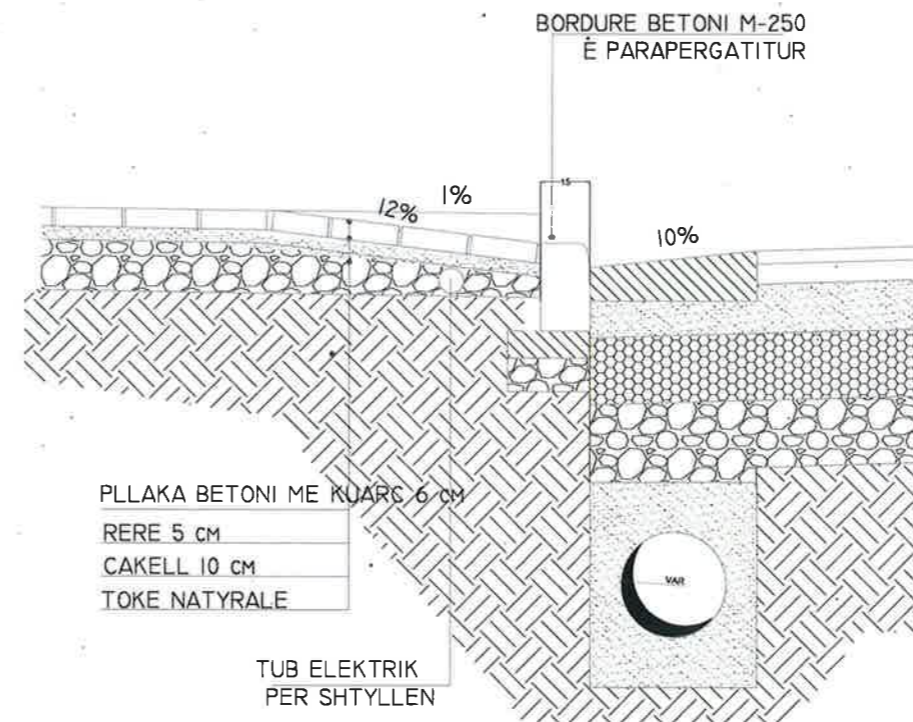

Shënim: NE CDO PIKE KU KRYQEZOHET RRUGA KRYESORE ME RRUGET DYTESORE DO TE VENDOSEN PANDUSET E TROTUAREVE



**BASHKIA KAMËZ**

DREJTORIA E PROJEKTEVE DHE INVESTIMEVE  
DEPARTAMENTI I PROJEKTEVE

Dr. e Projekteve e Investimeve	RAMADAN HYSA	<i>[Signature]</i>
Përgj. Sekt. i Projekteve	DENIS PRENÇI	<i>[Signature]</i>
STAFI TEKNIK PROJEKTUES	Ing. EMANUELA MËZIU	<i>[Signature]</i>
	Ing. ARTUR ÇAJKA	<i>[Signature]</i>
	Ing. ALEKS DANI	<i>[Signature]</i>
	Ark. ESTELA GJYRIQI	<i>[Signature]</i>

<b>Titulli i Projektit</b>	NDËRTIM RRUGËT BLOKU "BABRRU".	<b>Faza e Projektit</b>	PROJEKT ZBATIMI
<b>Emertimi i Fletes</b>	DETAJE PANDUSI	<b>Data e Implementimit:</b>	
		<b>Shkalla e Vizatimit:</b>	1:25
		<b>Fleta Nr.</b>	03

## VENDOSJA DHE MONTIMI I SHENJES RRUGORE

## SHENJA LAJMERUESE

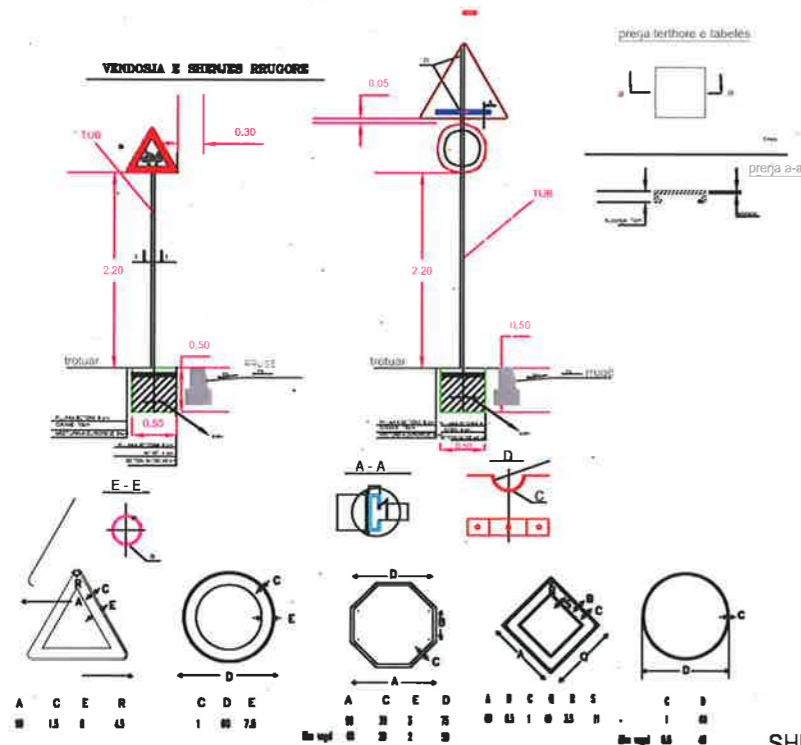

LAJMERIM PER NDERPRERJE NGA RRUGE DYTESORE, KTHESAT E KURBEZUARA, FEMIJET, KEMBESORET DHE PER NDALJE/DHENIE RRUGE

Trekëndeshi: e kuqe reflektuese  
Sfondi: i bardhe reflektues  
Simboli: i zi



Triangle: red reflective  
Background: white reflective  
Symbol: black

## SHENJA NDALUESE

shenjat per kufirin e shpejtesise dhe ndalim parakalimin

rrethi: e kuqe reflektuese  
shenja: e zeze reflektuese



SHENIM: Shenjat rrugore per nga forma, madhesia, ngjyra reflektiviteti duhet te jene sipas Kodit Rrugor te Republikes se Shqiperise. Materiali praparefektiv duhet te kete jetegjatesi 10vjet per Clasin 2 dhe 7 vjet per Clasin 1. Simboli brenda shenjes rrugore duhet te jete i realizuar me boje te trajtuar me pjekje e cila nuk humbet treguesit praparefektiv. Shenja rrugore realizohet me llmarine çeliku e cila lyhet me boje opake kundrandra korozionidhe trajtohet me pjekje.

DETAJE Kurrizë artificiale h=5cm

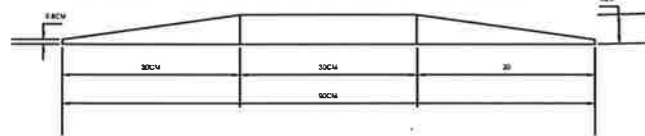

## SHENJA DETYRUESE

Anet & Shigjetat: E bardhe reflektuese

Edge & arrow: white reflective



## SHENJA PLOTESUESE

SHENJA E KTHESES NE NJE DREJTIM & DY DREJTIME

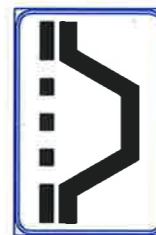

90

Shenja : e bardhe reflektuese

Stondi: e zeze



SHENJA INFORMUESE

240x90

240x90



**BASHKIA KAMËZ**

DREJTORIA E PROJEKTEVE DHE INVESTIMEVE  
DEPARTAMENTI I PROJEKTEVE

Dr. e Projekteve e Investimeve RAMADAN HYSA  
Përgj. Sekt. i Projekteve DENIS PRENÇI

STAFI TEKNIK PROJEKTUES	Ing.	EMANUELA MËZIU
	Ing.	ARTUR ÇAJKA
	Ing.	ALEKS DANI
	Ark.	ESTELA GJYRIQI

Titulli i Projektit	Faza e Projektit
NDËRTIM RRUGËT BLOKU "BABRRU".	PROJEKT ZBATIMI
Emertimi i Fletes	Data e Implementimit:
DETAJE SINJALISTIKE	Shkalla e Vizatimit: 1:25
	Fleta Nr. 04

Prerje e kapakut prej gize

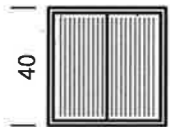
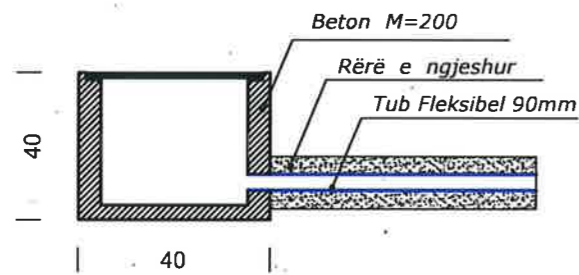

Kapaku i pusetës prej gize

Prerje e vendosjes së pusetave

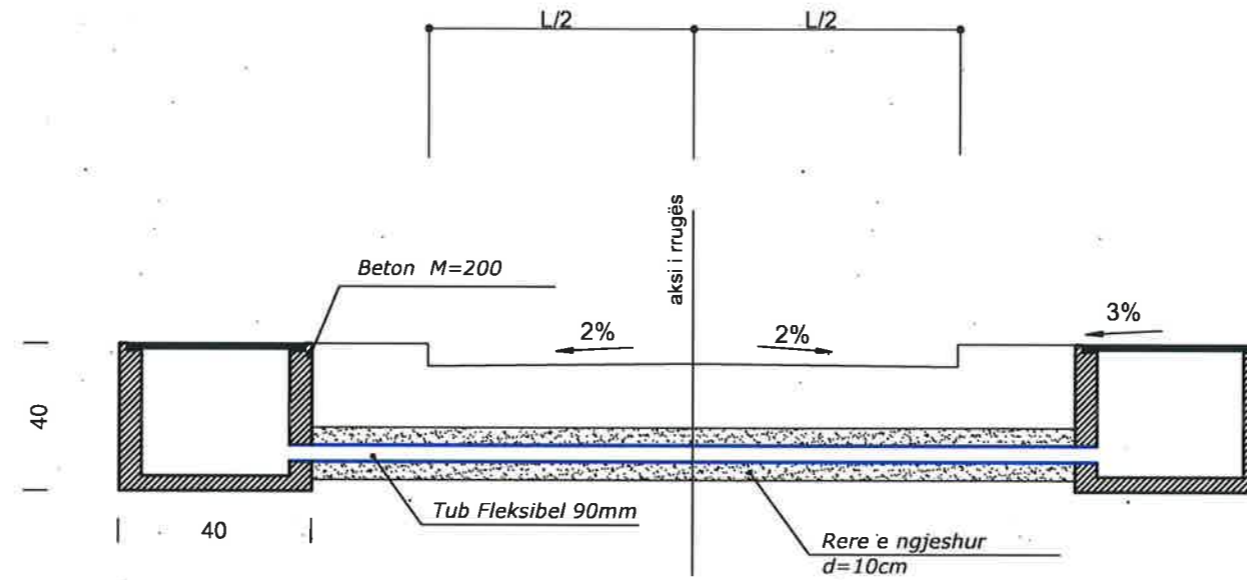

**BASHKIA KAMËZ**  
 DREJTORIA E PROJEKTEVE DHE INVESTIMEVE  
 DEPARTAMENTI I PROJEKTEVE

Dr. e Projekteve e Investimeve	RAMADAN HYSA		
Përgj. Sekt. i Projekteve	DENIS PRENÇI		
STAFI TEKNIK PROJEKTUES	Ing.	EMANUELA MËZIU	
	Ing.	ARTUR ÇAJKA	
	Ing.	ALEKS DANI	
	Ark.	EŞTELA GJYRIQI	

<b>Titulli i Projektit</b>	NDËRTIM RRUGËT BLOKU "BABRRU".	<b>Faza e Projektit</b>	PROJEKT ZBATIMI
<b>Emeritimi i Fletës</b>	DETAJE PUSETA ME KAPAK GIZE	<b>Data e Implementimit:</b>	
		<b>Shkalla e Vizatimit</b>	
		<b>Fleta Nr.</b>	05

Hollësi e inkastrimit të kolonës së ndriçuesit me lartësi H=9m

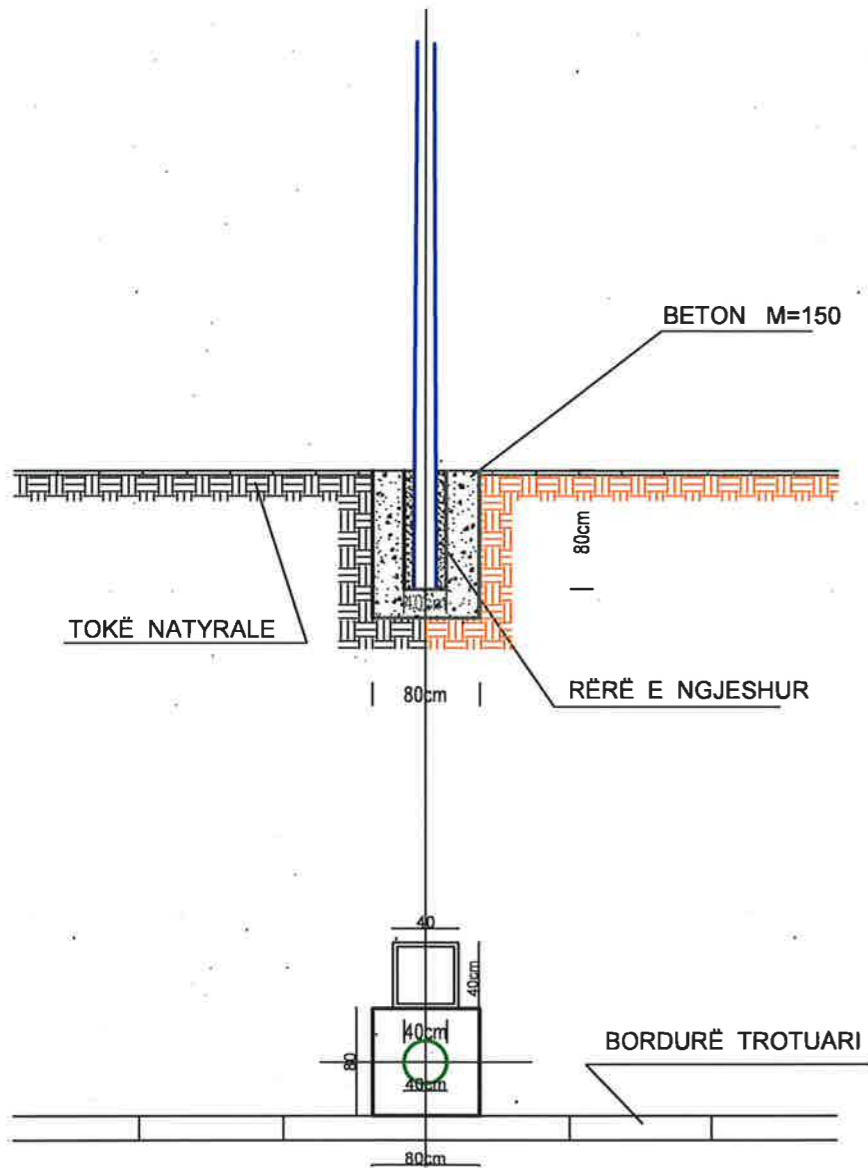

Hollësi e vendosjes së pusetës për Tub metalik 110mm

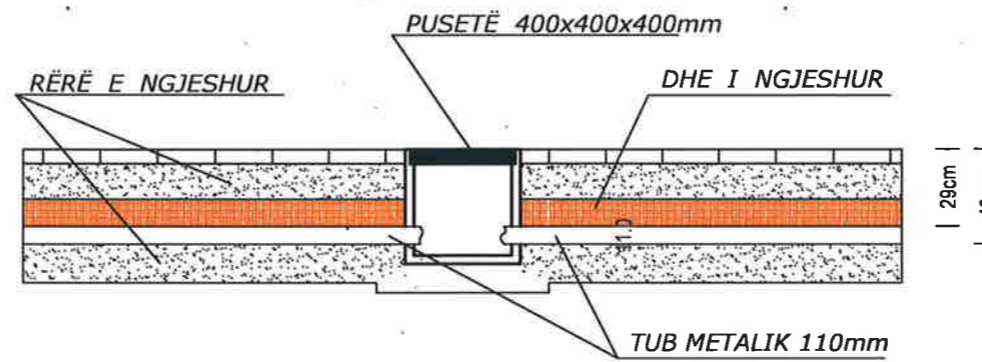

Hollësi e vendosjes së pusetës për Tub fleksibel 90mm

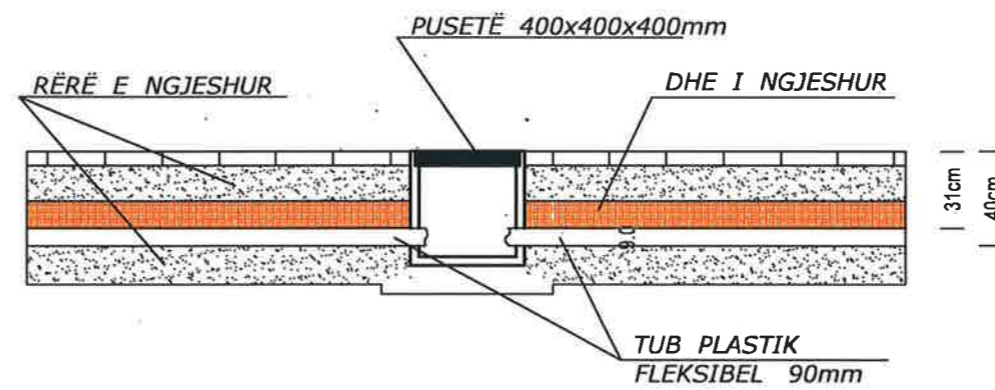

**BASHKIA KAMËZ**  
 DREJTORIA E PROJEKTEVE DHE INVESTIMEVE  
 DEPARTAMENTI I PROJEKTEVE

Dr. e Projekteve e Investimeve	RAMADAN HYSA	<i>[Signature]</i>
Përgj. Sekf. i Projekteve	DENIS PRENÇI	<i>[Signature]</i>
STAFI TEKNIK PROJEKTES	Ing. EMANUELA MËZIU	<i>[Signature]</i>
	Ing. ARTUR ÇAJKA	<i>[Signature]</i>
	Ing. ALEKS DANI	<i>[Signature]</i>
	Ark. ESTELA GJYRIQI	<i>[Signature]</i>

<b>Tiulli i Projektit</b>	<b>Faza e Projektit</b>
NDËRTIM RRUËT BLOKU "BABRRU".	PROJEKT ZBATIMI
<i>Emertimi i Fletës</i>	<i>Data e Implementimit :</i>
DETAJE INKASTRIMI	<i>Shkalla e Vizatimit</i>
	<i>Fleta Nr.</i>
	06

# Detaji Fiber Optike

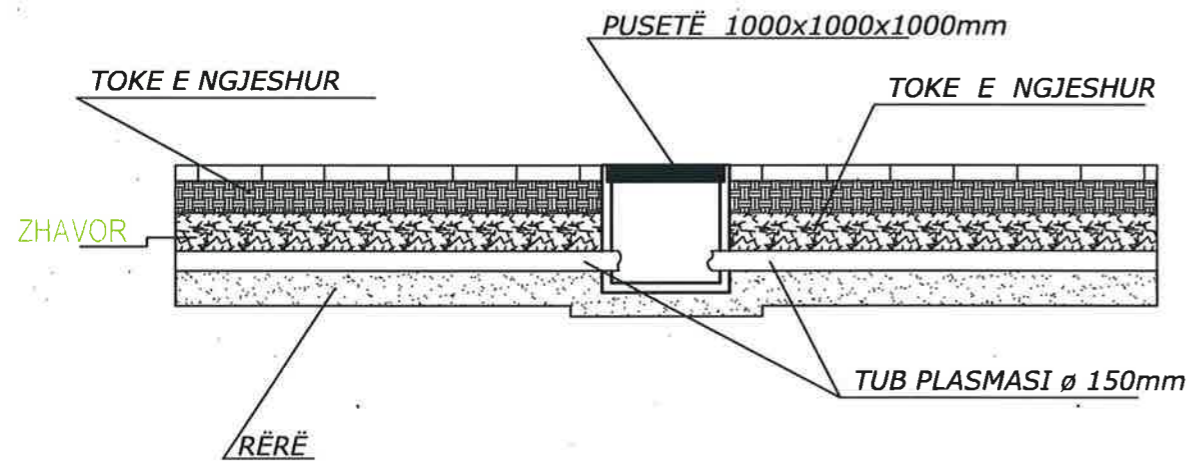
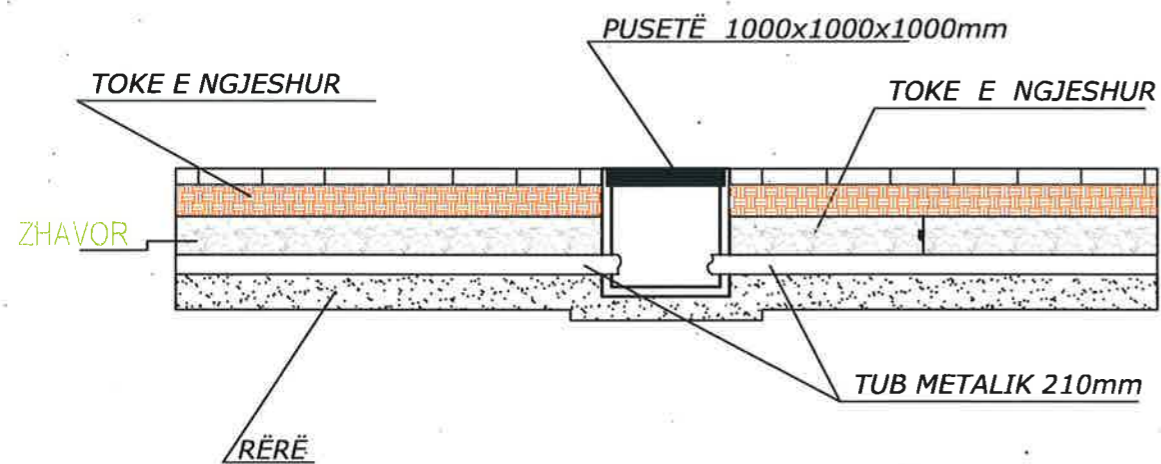

## PRERJA TERTHORE

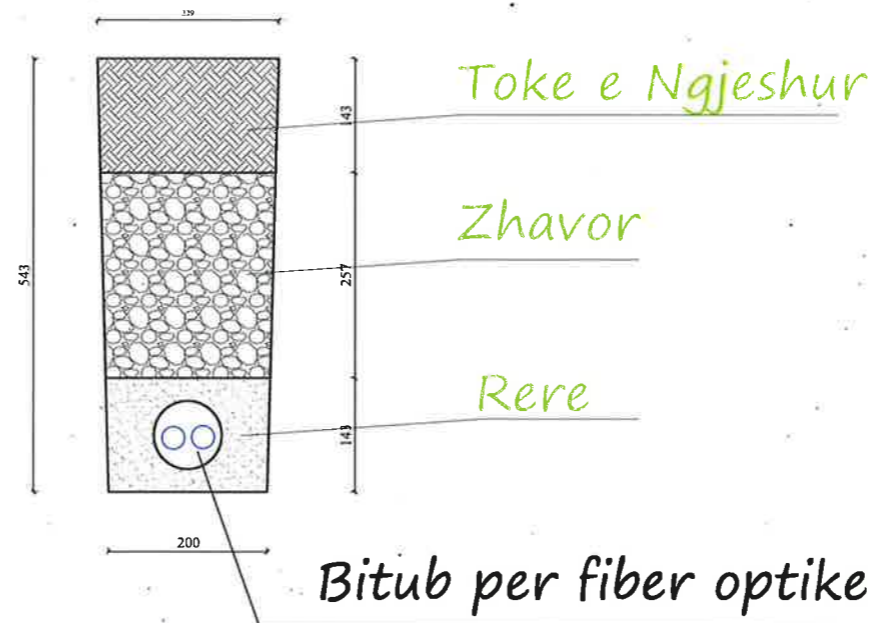

### SHËNIME :

- Gjatë realizimit të intersektimeve kuota e vendosjes së pusetave mund të ndryshojë sipas rastit
- Tubi mund të vendoset me një pjerrësi të lehtë sipas nevojës , por gjithnjë thellësia minimale e vendosjes duhet të jetë 70cm nga sip. e asfaltit.

**BASHKIA KAMËZ**  
DREJTORIA E PROJEKTEVE DHE INVESTIMEVE  
DEPARTAMENTI I PROJEKTEVE

Dr. e Projekteve e Investimeve	RAMADAN HYSA	<i>[Signature]</i>
Përgj. Sekt. i Projekteve	DENIS PRENÇI	<i>[Signature]</i>
STAFI TEKNIK PROJEKTES	Ing.	EMANUELA MËZIU
	Ing.	ARTUR ÇAJKA
	Ing.	ALEKS DANI
	Ark.	ESTELA GJYRIQI

Titulli i Projektit	Faza e Projektit
NDËRTIM RRUGËT BLOKU "BABRRU".	PROJEKT ZBATIMI
Emeritimi i Flites	Data e Implementimit:
DETAJE FIBER OPTIKE	Shkalla e Vizatimit:
	Flita Nr.
	07

MURE MBAJTES B/ARME M-I H=2.-2.6M L= 20 ML

$[\sigma]_t=2\text{kg/cm}^2$  DHE  $4\text{kg/cm}^2$ ,  $\varphi_m \geq 35^\circ$

SH. 1:25



TABELA E HEKURAVE  
PER  $[\sigma]_t=2\text{kg/cm}^2$  DHE  $4\text{kg/cm}^2$

NR.	Ø mm	L mm	SASIA cope	L m	PERMBLEDHJE E ARMATURES.			
					Ø mm	ΣL m	PESHA kg/ml	PESHA kg
1	12	2905	7	20.335	6	7.28	0.222	1.62
2	12	2905	5	14.525				
3	12	1000	20	20.00	12	107.372	0.888	95.346
3a	14	1000	3	3.00	14	3.00	1.208	3.62
4	12	2608	7	18.256				
5	12	2608	7	18.256				
6	12	1000	16	16.00				
7	6	520	6	3.12				
8	6	520	8	4.16				
9								
beton $1.51 \text{ m}^3/\text{m}$					shuma		kg/ml	100.586
beton $r_{ck}=250\text{kg/cm}^2$							$\text{m}^3/\text{m}$	1.62

SHENIME:

- MURI ESHTË PROJEKTUAR PER:
  - NGARKESE TE LEVIZESHME NE PRIZMIN E SHKATERIMIT  $q=1.7\text{T/m}^2$
  - MBUSHJE MBRAPA TIJ ME MATERIAL SHKEMBOR ME KEND TE FERKIMIT TE MBRENDSHËM  $\varphi \geq 35^\circ$ .
  - NGARKESE TE LEJUAR NE TABAN  $[\sigma]=2\text{kg/cm}^2$  DHE  $4\text{kg/cm}^2$
- MURI ESHTË PARASHIKUAR TE NDERTOHEJ:
  - ME BETON  $r_{ck}=300\text{kg/cm}^2$
  - ARMATURE PREJ CELIKU Feb-40K.
- LARGESIA NGA FAQJA E BETONIT DERI TEK FAQJA E ARMATURES PUNUESE DO TE MERRET 30mm.
- PERMASAT E BETONIT JANE DHENE NE CENTIMETRA (cm), TE ARMATURES SE HEKURIT NE MILIMETRA (mm).

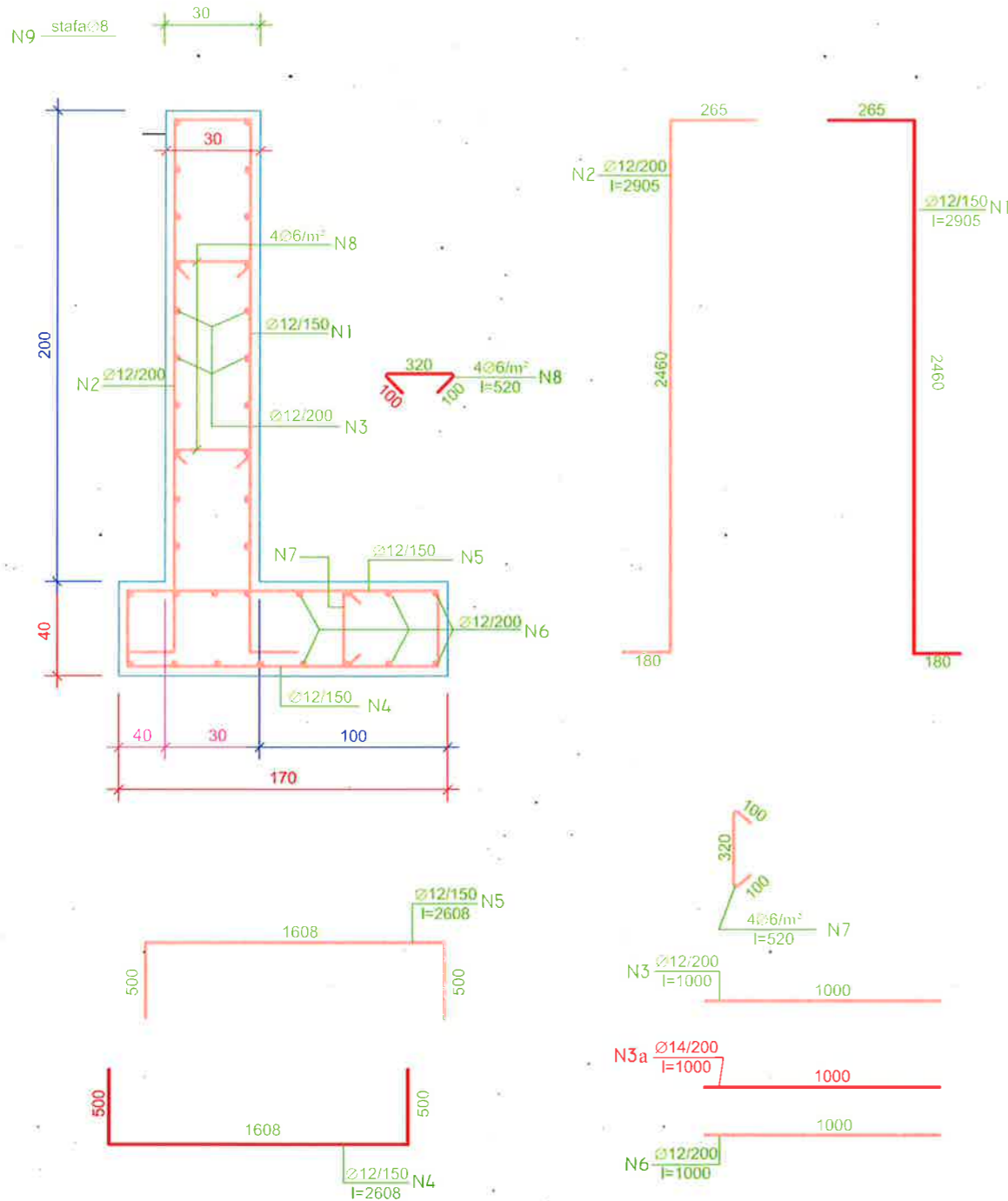

BASHKIA KAMËZ

DREJTORIA E PROJEKTEVE DHE INVESTIMEVE  
DEPARTAMENTI I PROJEKTEVE

Dr. e Projekteve e Investimeve	RAMADAN HYSA	<i>[Signature]</i>
Përgj. Sekt. i Projekteve	DENIS PRENÇI	<i>[Signature]</i>
STAFI TEKNIK PROJEKTES	Ing. EMANUELA MËZIU	<i>[Signature]</i>
	Ing. ARTUR ÇAJKA	<i>[Signature]</i>
	Ing. ALEKS DANI	<i>[Signature]</i>
	Ark. ESTELA GJYRIQI	<i>[Signature]</i>

Titulli i Projektit	NDËRTIM RRUGËT BLOKU "BABRRU".	Faza e Projektit PROJEKT ZBATIMI
Emertimi i Fletes	PRERJE E ARMIMIT TE MUREVE MBAJTESE	Data e Implementimit:
		Shkalla e Vizatimit:
		Fleta Nr. 08

# NGRITJE PUSETE

PRERJE 1-1 Sh 1:20

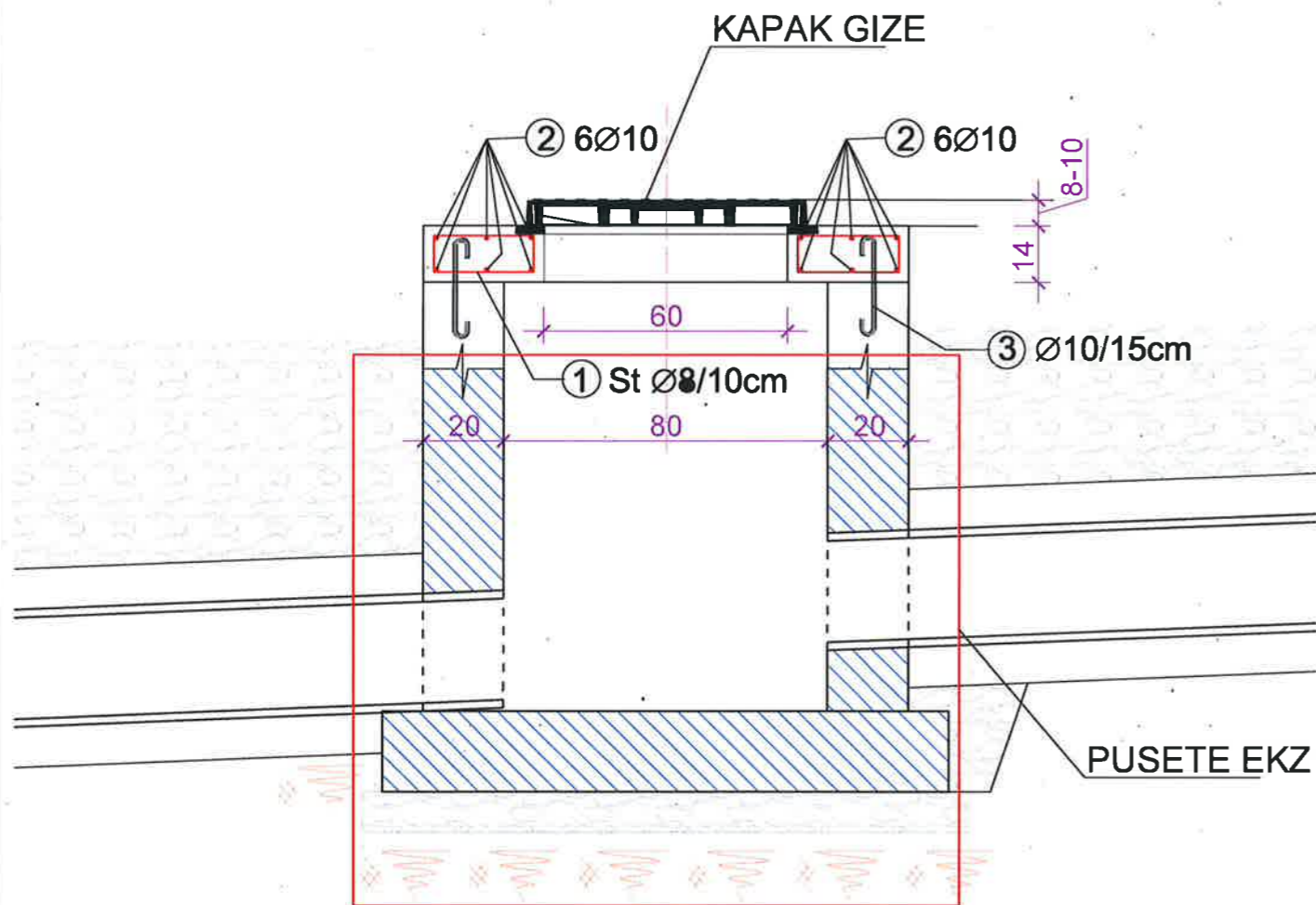

PRERJE 1-1 Sh 1:20



**BASHKIA KAMËZ**

DREJTORIA E PROJEKTEVE DHE INVESTIMEVE  
DEPARTAMENTI I PROJEKTEVE

Dr. e Projekteve e Investimeve	RAMADAN HYSA	<i>[Signature]</i>
Përgj. Sekt. i Projekteve	DENIS PRENÇI	<i>[Signature]</i>
STAFI TEKNIK PROJEKTES	Ing.	EMANUELA MËZIU
	Ing.	ARTUR ÇAJKA
	Ing.	ALEKS DANI
	Ark.	ESTELA GJYRIQI

Titulli i Projektit	NDËRTIM RRUGËT BLOKU "BABRRU".	Faza e Projektit	PROJEKT ZBATIMI
	Emortimi i Fletes	DETAJ MBRINGRITJE PUSETE	Data e Implementimit:
		Shkalla e Vizatimit	
		Fleta Nr.	09

**PUSETE TIP D=100cm**

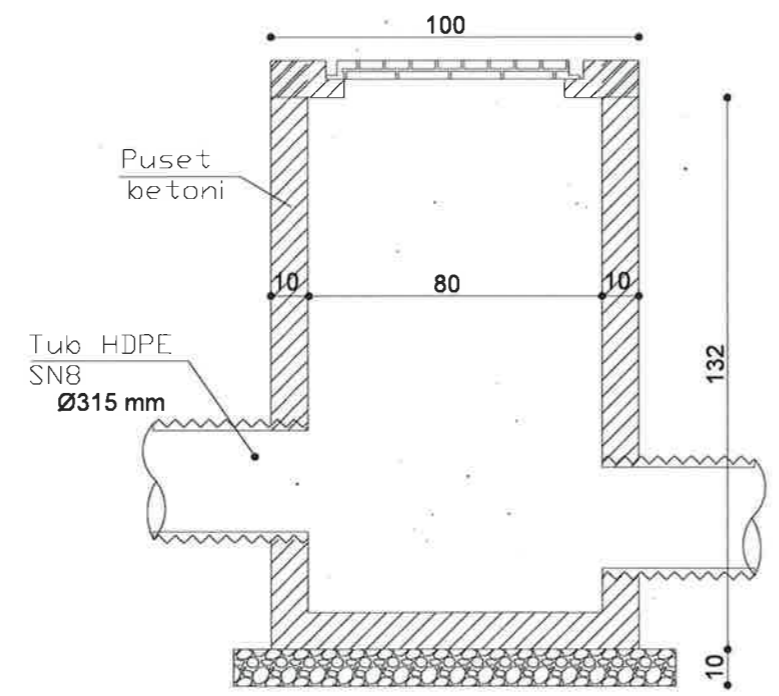
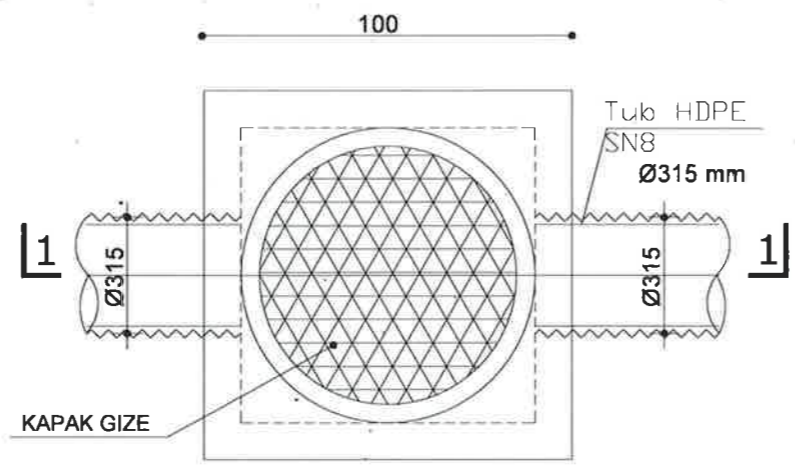

**BASHKIA KAMËZ**  
 DREJTORIA E PROJEKTEVE DHE INVESTIMEVE  
 DEPARTAMENTI I PROJEKTEVE

Dr. e Projekteve e Investimeve	RAMADAN HYSA	<i>[Signature]</i>	
Përgj. Sekt. i Projekteve	DENIS PRENÇI	<i>[Signature]</i>	
STAFI TEKNIK PROJEKTUES	Ing.	EMANUELA MËZIU	<i>[Signatures]</i>
	Ing.	ARTUR ÇAJKA	
	Ing.	ALEKS DANI	
	Ark.	EËTELA GJYRIQI	

<b>Titulli i Projektit</b>	<b>Faza e Projektit</b>
NDËRTIM RRUGËT BLOKU "BABRRU".	PROJEKT ZBATIMI
<b>Emertimi i Fletes</b>	<b>Data e Implementimit:</b>
DETAJ PUSETE TIP 100X100X150	
	<b>Shkalla e Vizimit</b>
	1:20
	<b>Fleta Nr.</b>
	10

SHTYLLE ELEKTRIKE ME PUSETE NE TOKE ME LIDHJE  
EKUIPOTENCIALE DHE MORSETERIA E LINJES  
SE NDRICIMIT

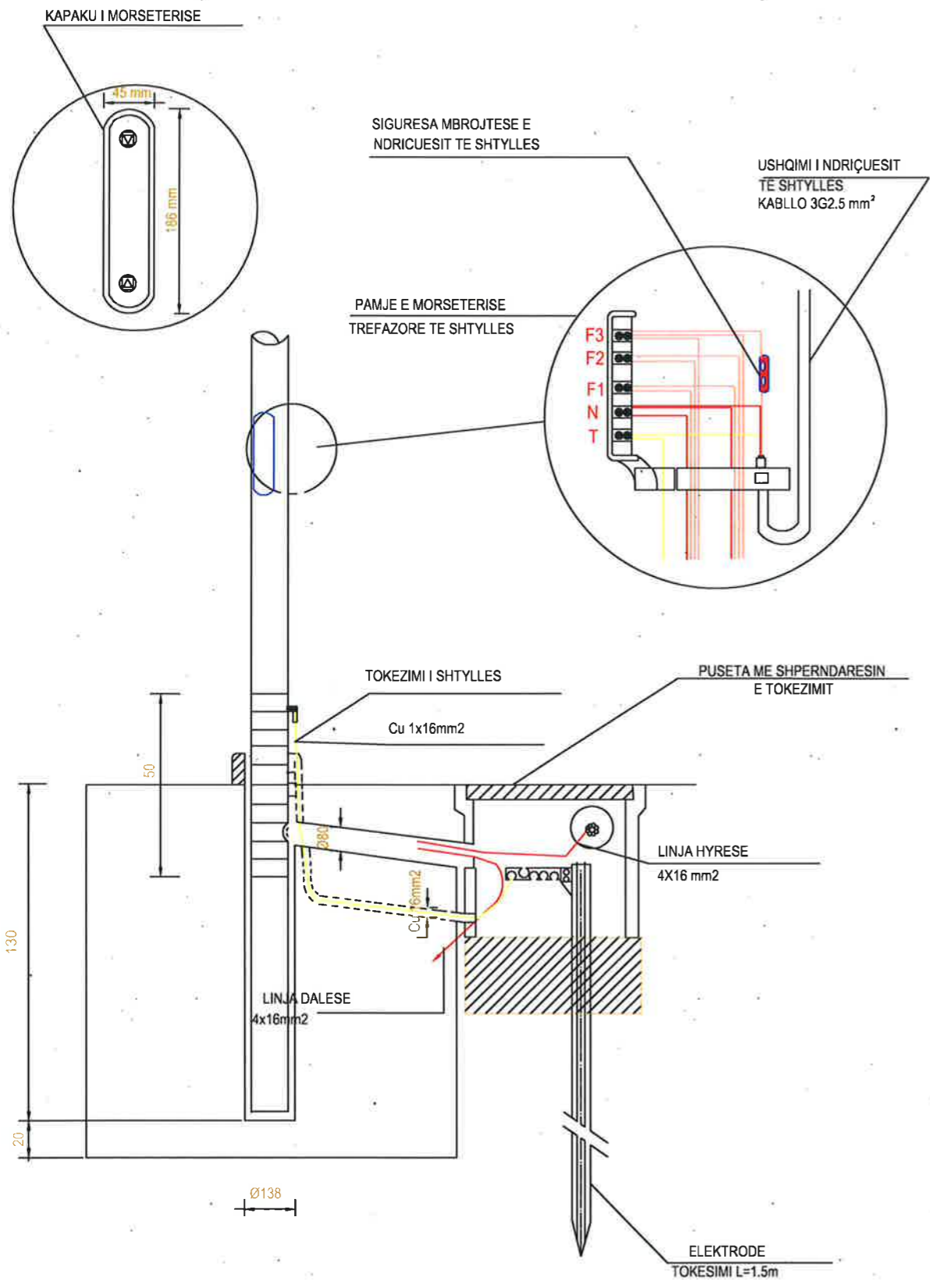

PLANI I DETAJIT TE PUSETES ,PLASTIKE 40X40X40 CM, SE NDRICIMIT  
DHE I MONTIMIT TE SAJ NE TOKE ME TUB

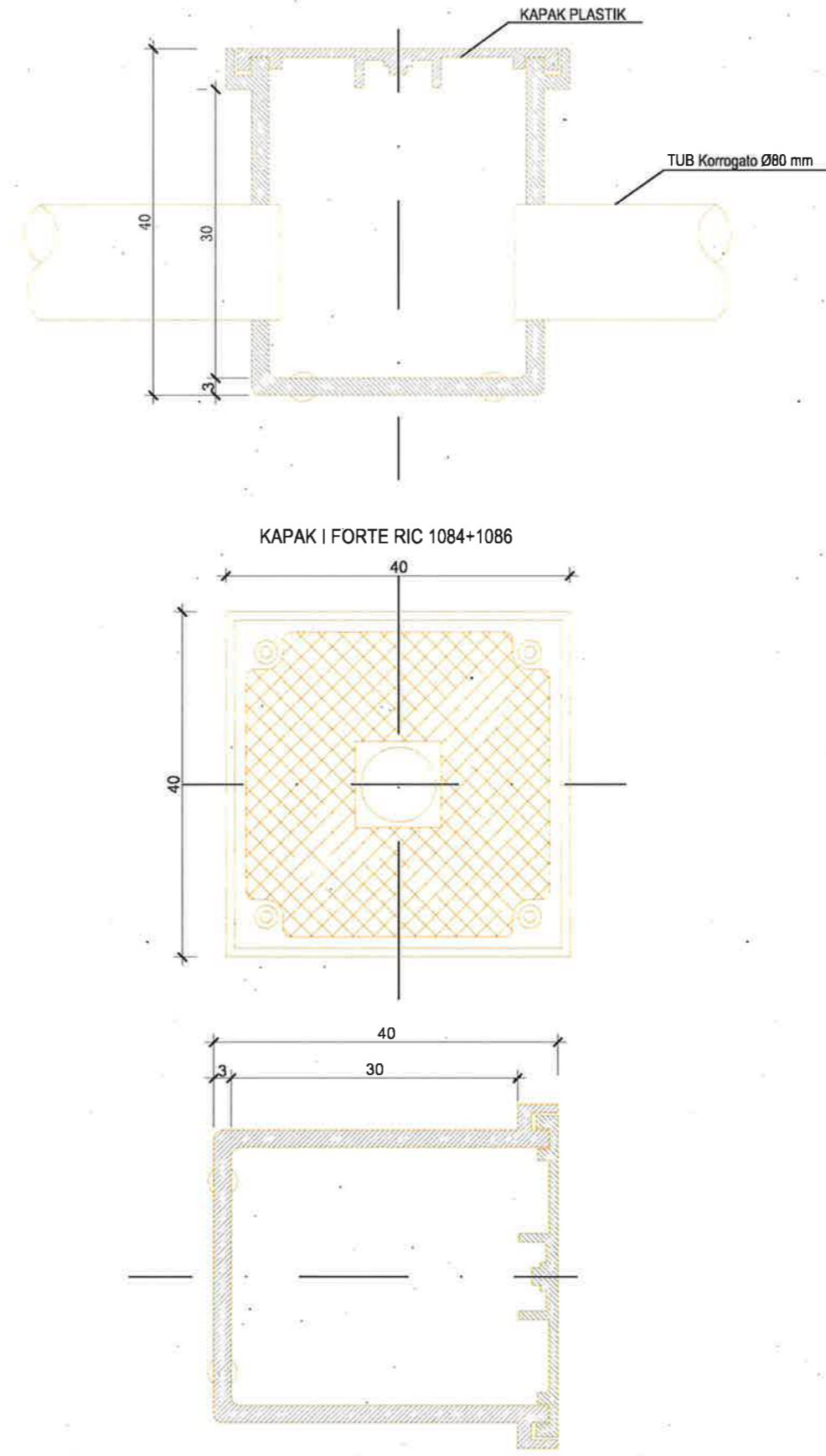

**BASHKIA KAMËZ**  
DREJTORIA E PROJEKTEVE DHE INVESTIMEVE  
DEPARTAMENTI I PROJEKTEVE

Dr. e Projekteve e Investimeve	RAMADAN HYSA	<i>[Signature]</i>
Përgj. Sekf. i Projekteve	DENIS PRENÇI	<i>[Signature]</i>
STAFI TEKNIK PROJEKTES	Ing. EMANUELA MËZIU	<i>[Signature]</i>
	Ing. ARTUR ÇAJKA	<i>[Signature]</i>
	Ing. ALEKS DANI	<i>[Signature]</i>
	Ark. ESTELA GJYRIQI	<i>[Signature]</i>

Titulli i Projektit	Faza e Projektit
NDËRTIM RRUGËT BLOKU "BABRRU".	PROJEKT ZBATIMI
Emertimi i Fletes	Data e Implementimit :
DETAJE TOKEZIMI, MORSETERIE, PUSETA PVC	Shkalla e Vizatimit
	Fleta Nr.
	11

Armimi i Murit Hvar=75cm  
Shk.1:20

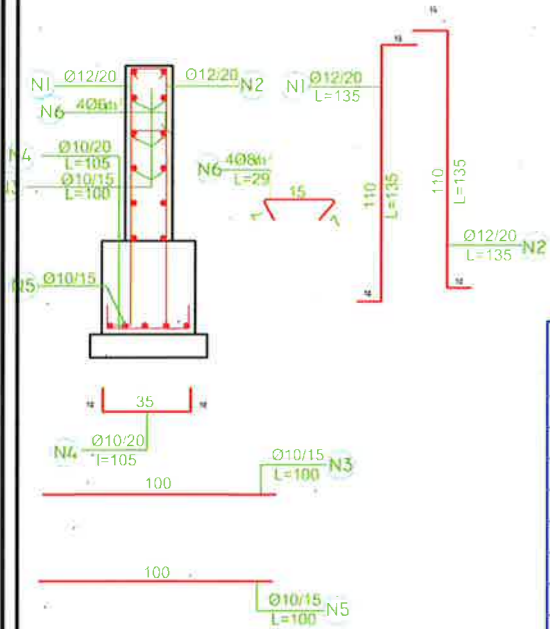

SHENIME:

- Muri është projektuar për:
  - ngarkese të levizëshme në prizmin e shkaterimit  $q = 1.7 \text{ t/m}^2$
  - mbushje mbrapa tij me material shkëmbor me kënd të feikimit të brendshëm  $\phi \geq 35^\circ$
  - ngarkese të lejuar në taban  $[\sigma] = 2 \text{ kg/cm}^2$  dhe  $4 \text{ kg/cm}^2$
- Muri është parashikuar të ndërtohet:
  - me beton C12/15
  - armature prej çeliku feb-44k
- Largësia nga faqja e betonit deri tek faqja e armatues përuuese do të jenë 25mm.
- Permasat e betonit janë dhënë në centimetra (cm), të armatues se hekurit në milimetra (mm).
- Shtresa e betonit C12/15, nën themel do të zbatohet vetëm në rastet kur formacioni ka veti fiziko-mekanike të dobta.

Tabela e Hekurave  
për  $[\sigma] = 2 \text{ kg/cm}^2$  dhe  $4 \text{ kg/cm}^2$

NR.	Ø mm	L cm	SASIA cope	L m	PERMBLEDHJE E ARMATURES.				
					Ø mm	ΣL m	PESHA kg/ml	PESHA kg	
1	12	135	5	6.75	8	4.35	0.389	1.69	
2	12	135	5	6.75	10	19.75	0.619	12.22	
3	10	100	12	12	12	13.5	0.888	11.99	
4	10	55	5	2.75					
5	10	100	5	5					
6	8	29	15	4.35					
Hekur S-500							kg/ml	25.9	
Beton C12/15							m <sup>3</sup> /ml	0.36	

BAJTES B/ARME M-I H=2.-2.6M L= 20 ML  
 $[\sigma] = 2 \text{ kg/cm}^2$  DHE  $4 \text{ kg/cm}^2$ ,  $\phi_m > 35^\circ$   
 SH. 1:25



TABELA E HEKURAVE  
PER  $[\sigma] = 2 \text{ kg/cm}^2$  DHE  $4 \text{ kg/cm}^2$

NR.	Ø mm	L mm	SASIA cope	L m	PERMBLEDHJE E ARMATURES.			
					Ø mm	ΣL m	PESHA kg/ml	PESHA kg
1	12	2905	7	20.335	6	7.28	0.222	1.62

**BASHKIA KAMËZ**  
 DREJTORIA E PROJEKTEVE DHE INVESTIMEVE  
 DEPARTAMENTI I PROJEKTEVE

Dr. e Projekteve e Investimeve	RAMADAN HYSA	
Përgj. Sekt. i Projekteve	DENIS PRENÇI	
STAFI TEKNIK PROJEKTUES	Ing.	EMANUELA MËZIU
	Ing.	ARTUR ÇAJKA
	Ing.	ALEKS DANI
	Ark.	ESTELA GJYRIQI

Titulli i Projektit	Faza e Projektit
NDËRTIM RRUGËT BLOKU "BABRRU".	PROJEKT ZBATIMI
Emertimi i Fietes	Data e Implementimit:
DETAJE TOKEZIMI, MORSETERIE, PUSETA PVC	Shkalla e Vizimit
	Fleta Nr.
	12

# PUSETE TIP D=100cm

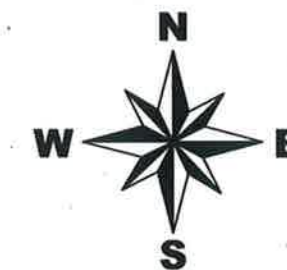
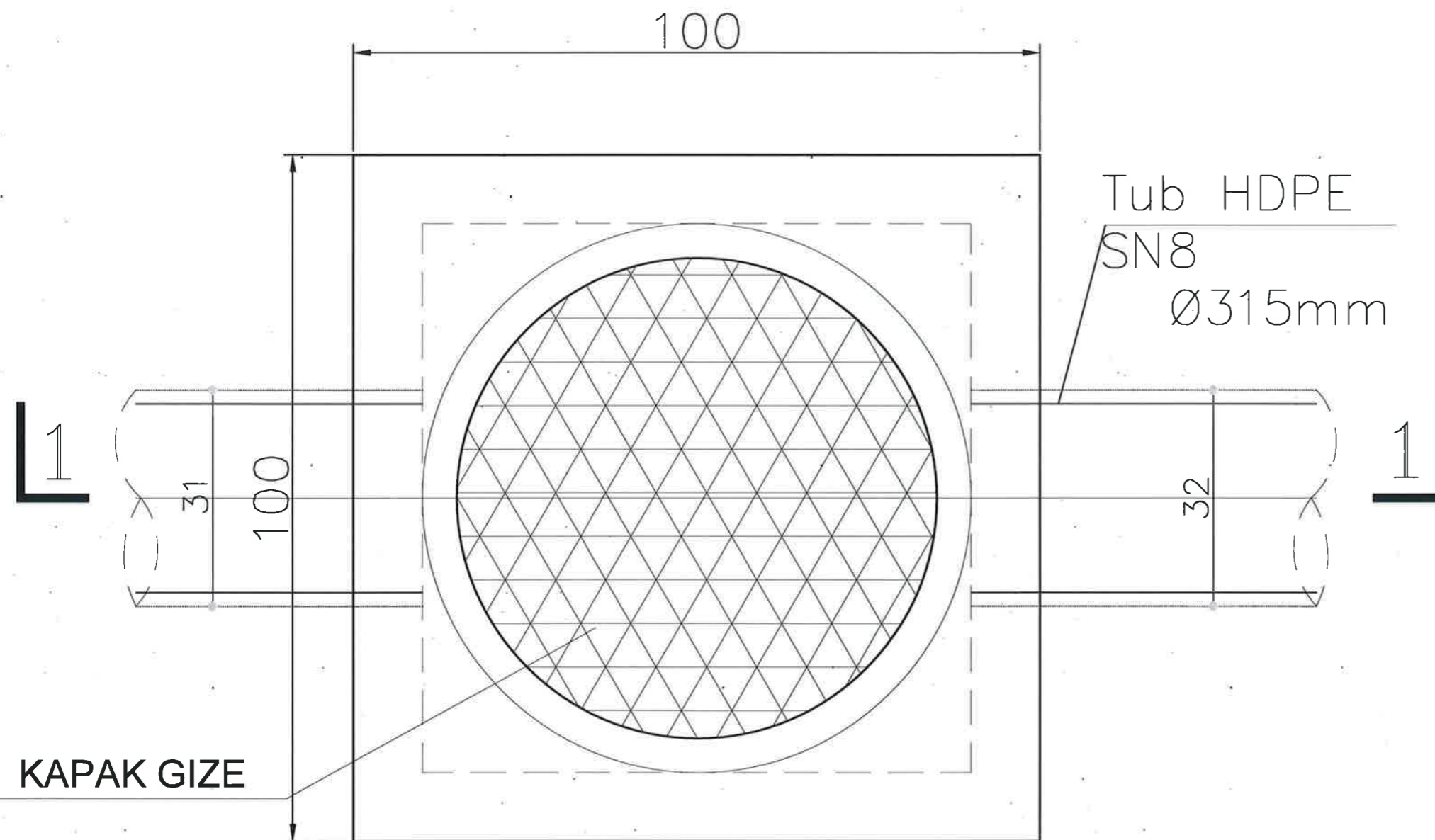

## LEGJENDË

-  Tub H.D.P.E  $\Phi=315$  KUB
-  Tub H.D.P.E  $\Phi=315$  KUN
-  PUSETE KUB
-  PUSETE KUN
-  DREJTIMI I RRJEDHES KUB & KUN



## BASHKIA KAMËZ



DREJTORIA E PROJEKTEVE DHE INVESTIMEVE  
DEPARTAMENTI I PROJEKTEVE

Dr. e Projekteve e Investimeve	RAMADAN HYSA	
Prgj. Sektori i Projekteve	DENIS PRENÇI	
STAFI TEKNIK	Ing. EMANUELA MËZIU	
PROJEKTUES	Ing. ARTUR ÇAJKA	
	Ing. ALEKS DANI	
	Ark. ESTELA GJYRIQI	

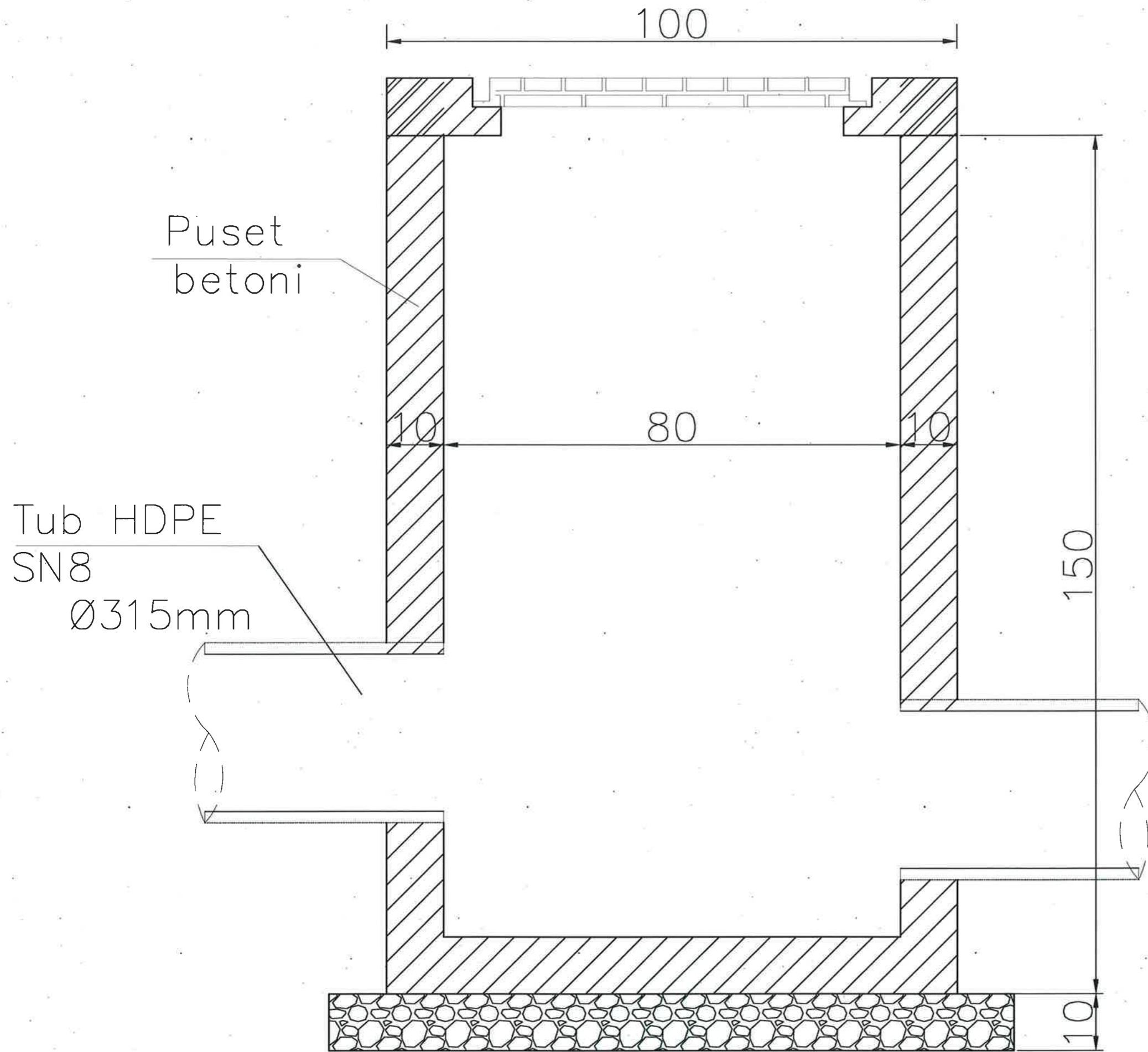
<b>Titulli i Projektit</b>	<b>Faza e Projektit</b>
NDËRTIM RRUGËT BLOKU "BA BRRU".	PROJEKT ZBATIMI
<b>Emertimi i Fletës</b>	<b>Data e Implementimit:</b>
DETAJE KUN	Shkalla e Vizatimit: 1:500
	Fleta Nr. <b>013.</b>



LEGJENDË

-  Tub H.D.P.E  $\Phi=315$  KUB
-  Tub H.D.P.E  $\Phi=315$  KUN
-  PUSETE KUB
-  PUSETE KUN
-  DREJTIMI I RRJEDHES KUB & KUN



**BASHKIA KAMËZ**



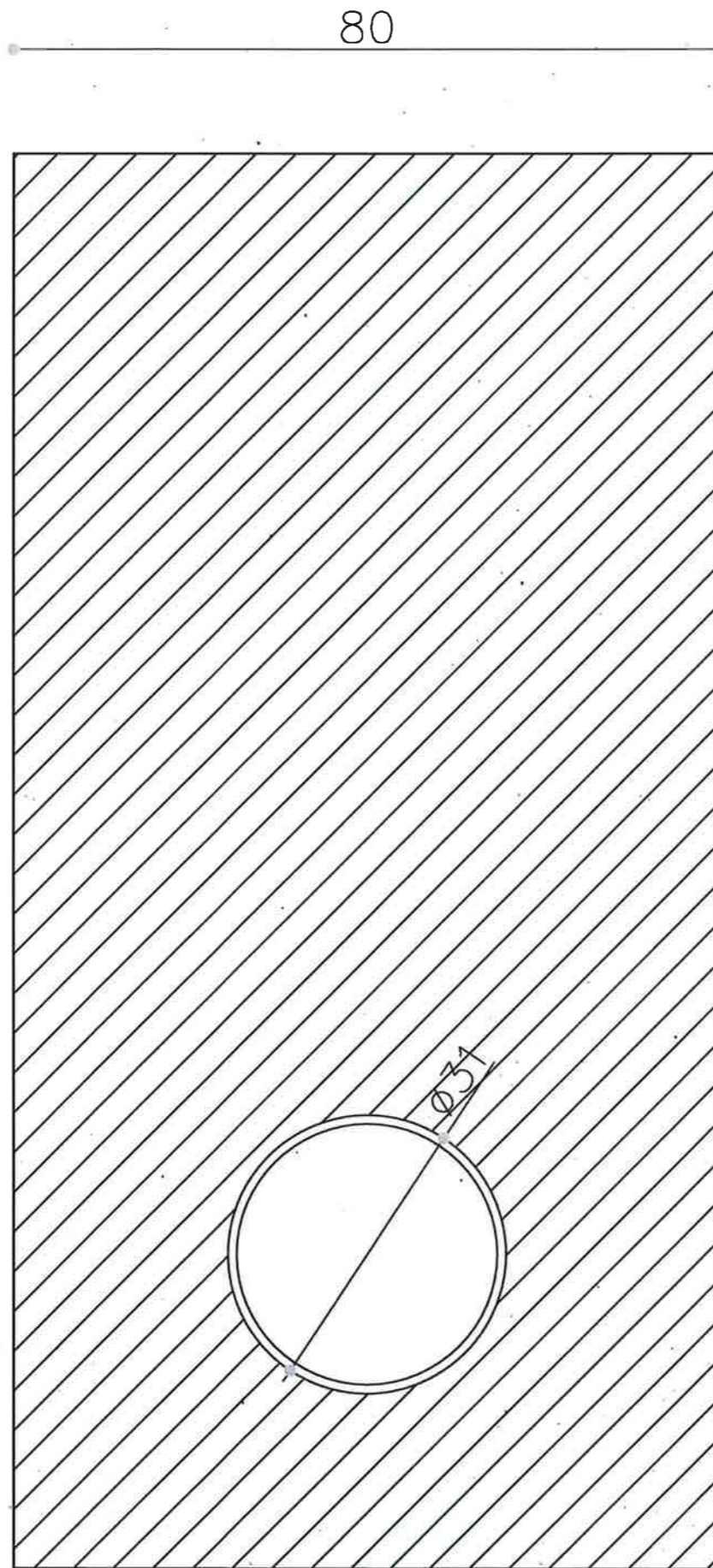

DREJTORIA E PROJEKTEVE DHE INVESTIMEVE  
DEPARTAMENTI I PROJEKTEVE

Dr. e Projekteve e Investimeve	RAMADAN HYSA	
Prgj. Sektori i Projekteve	DENIS PRENÇI	
STAFI TEKNIK PROJEKTUES	Ing. EMANUELA MËZIU	
	Ing. ARTUR ÇAJKA	
	Ing. ALEKS DANI	
	Ark. ESTELA GJYRIQI	

Titulli i Projektit	Faza e Projektit
NDËRTIM RRUGËT BLOKU "BABRRU".	PROJEKT ZBATIMI
Emertimi i Fietas	Data e Implementimit :
DETAJE KUN	Shkalla e Vizatimit : 1:500
	Fleta Nr. 14.



LEGJENDË

-  Tub H.D.P.E  $\Phi=315$  KUB
-  Tub H.D.P.E  $\Phi=315$  KUN
-  PUSETE KUB
-  PUSETE KUN
-  DREJTIMI I RRJEDHES KUB & KUN



**BASHKIA KAMËZ**

DREJTORIA E PROJEKTEVE DHE INVESTIMEVE  
DEPARTAMENTI I PROJEKTEVE

Dr. e Projekteve e Investimeve	RAMADAN HYSA	
Prgj. Sektori i Projekteve	DENIS PRENÇI	
STAFI TEKNIK PROJEKTES	Ing. EMANUELA MËZIU	
	Ing. ARTUR ÇAJKA	
	Ing. ALEKS DANI	
	Ark. ESTELA GJYRIQI	

Titulli i Projektit	Faza e Projektit
NDËRTIM RRUGËT BLOKU "BABRRU".	PROJEKT ZBATIMI
Emertimi i Fletës	Data e Implementimit:
DETAJE KUN	Shkalla e Vizimit 1:500
	Fleta Nr. 15.

**PROFIL TËRTHOR TIP 8  
NDËRTIM TROTUAR RRUGET:  
"1 MAJ, PJETER BUDI, MITHAT FRASHERI, DERVIZH LUZHA,  
KOFERENCA E BUJANIT, PINGUL ME AZEM GALICEN"**

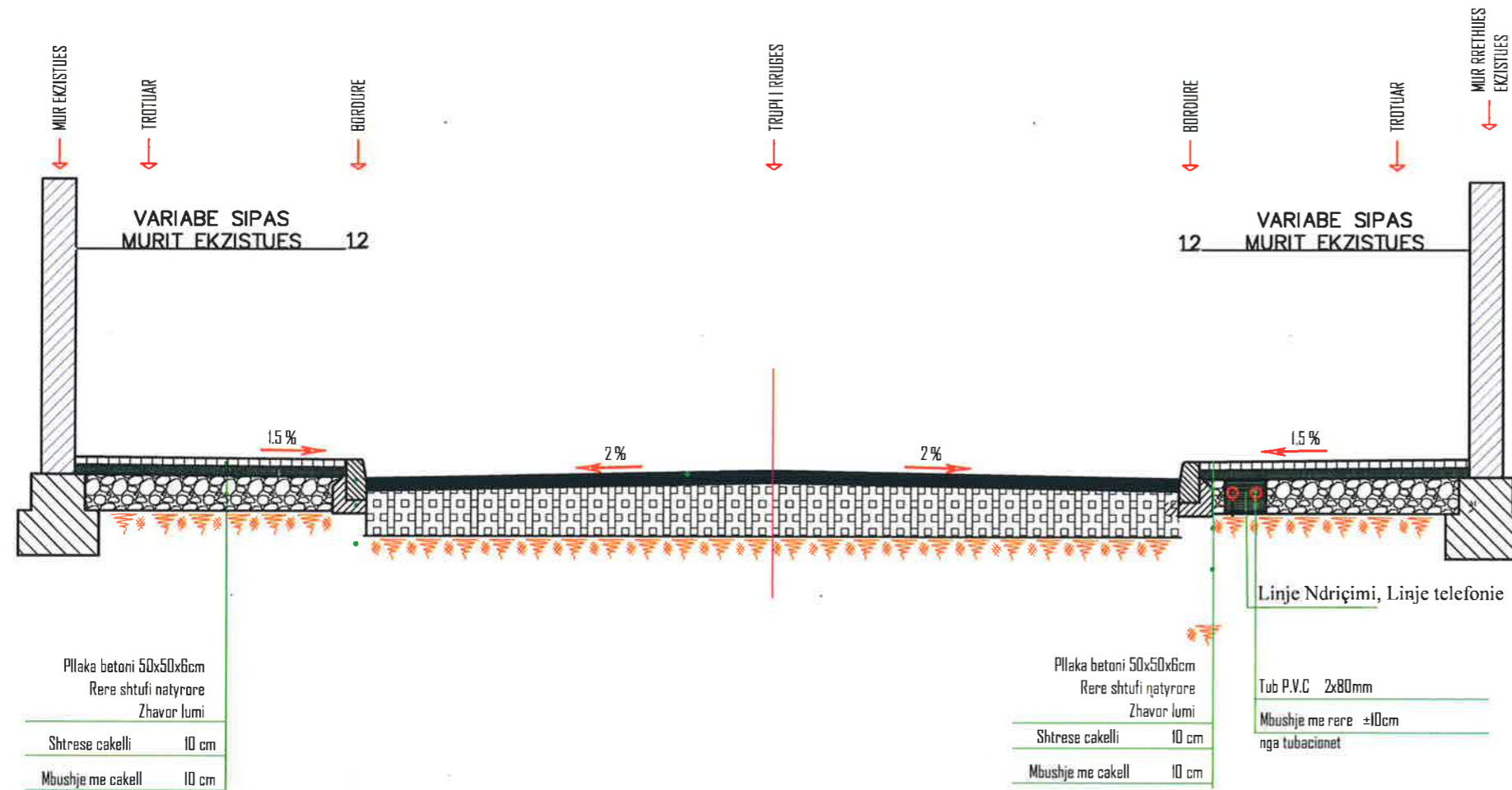

**BASHKIA KAMËZ**  
DREJTORIA E PROJEKTEVE DHE INVESTIMEVE  
DEPARTAMENTI I PROJEKTEVE

Dr. e Projekteve e Investimeve	RAMADAN HYSA
Prgj. Sektori i Projekteve	DENIS PRENÇI
STAFI TEKNIK PROJEKTES	Ing. EMANUELA MEZIU
	Ing. ARTUR ÇAJKA
	Ing. ALEKS DANI
	Ark. ESTELA GJYRIQI

Titulli i Projektit NDËRTIM DHE RIKONSTRUKSION RRUGËT BLOKU "BABRRU".	Faza e Projektit PROJEKT ZBATIMI
Emertimi i Fletës PROFILI TËRTHOR TIP	Data e Implementimit: Shkalla e Vizimit: Fleta Nr. <b>11</b>