



**REPUBLIKA E SHQIPERISE**  
**BASHKIA PATOS**  
DREJTORIA E ZHVILLIMIT TE TERRITORIT DHE EMERGJENCAVE CIVILE

**OBJEKTI: RIKONSTRUKSION I RRUGES RILINDJA BELINE**  
**PLANIMETRIA E RRUGES**

Nr. i fletëve: 5(pesë)fletë

Grupi i Projektimit:

**Ing: Boreta Murati**

Drejtor :

**ING. BORETA MURATI**

MIRATOHET  
KRYETAR  
**Fation Duro**

**MAJ 2026**



REPUBLIKA E SHQIPERISE  
BASHKIA PATOS  
DREJTORIA E ZHVILLIMIT TE  
TERRITORIT DHE EMERGJENCAVE  
CIVILE

EMERTIMI I PROJEKTIT:

**RIKONSTRUKSION I RRUGES  
RILINDJA BELINE**

EMERTIMI I FLETES:

**PLANIMETRIA E RRUGES**

GRUPI I PROJEKTIMIT:

ING. BORETA MURATI

DREJTORIA E ZHVILLIMIT TE  
TERRITORIT DHE  
EMERGJENCAVE CIVILE

ING. BORETA MURATI

SHKALLA

1:500

Fleta: Nr. 1

MAJ 2026

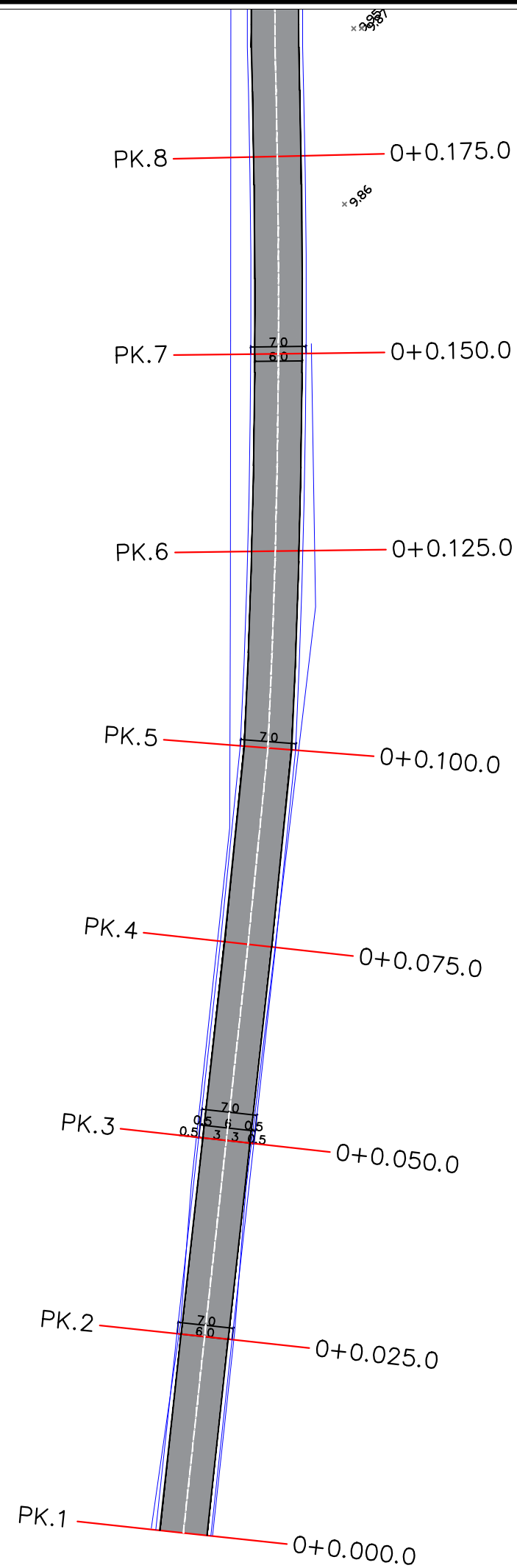



REPUBLIKA E SHQIPERISE  
BASHKIA PATOS  
DREJTORIA E ZHVILLIMIT TE  
TERRITORIT DHE EMERGJENCAVE  
CIVILE

EMERTIMI I PROJEKTIT:

**RIKONSTRUKSION I RRUGES  
RILINDJA BELINE**

EMERTIMI I FLETES:

**PLANIMETRIA E RRUGES**

GRUPI I PROJEKTIMIT:

ING. BORETA MURATI

DREJTORIA E ZHVILLIMIT TE  
TERRITORIT DHE  
EMERGJENCAVE CIVILE

ING. BORETA MURATI

SHKALLA

1:500

Fleta: Nr. 2

MAJ 2026

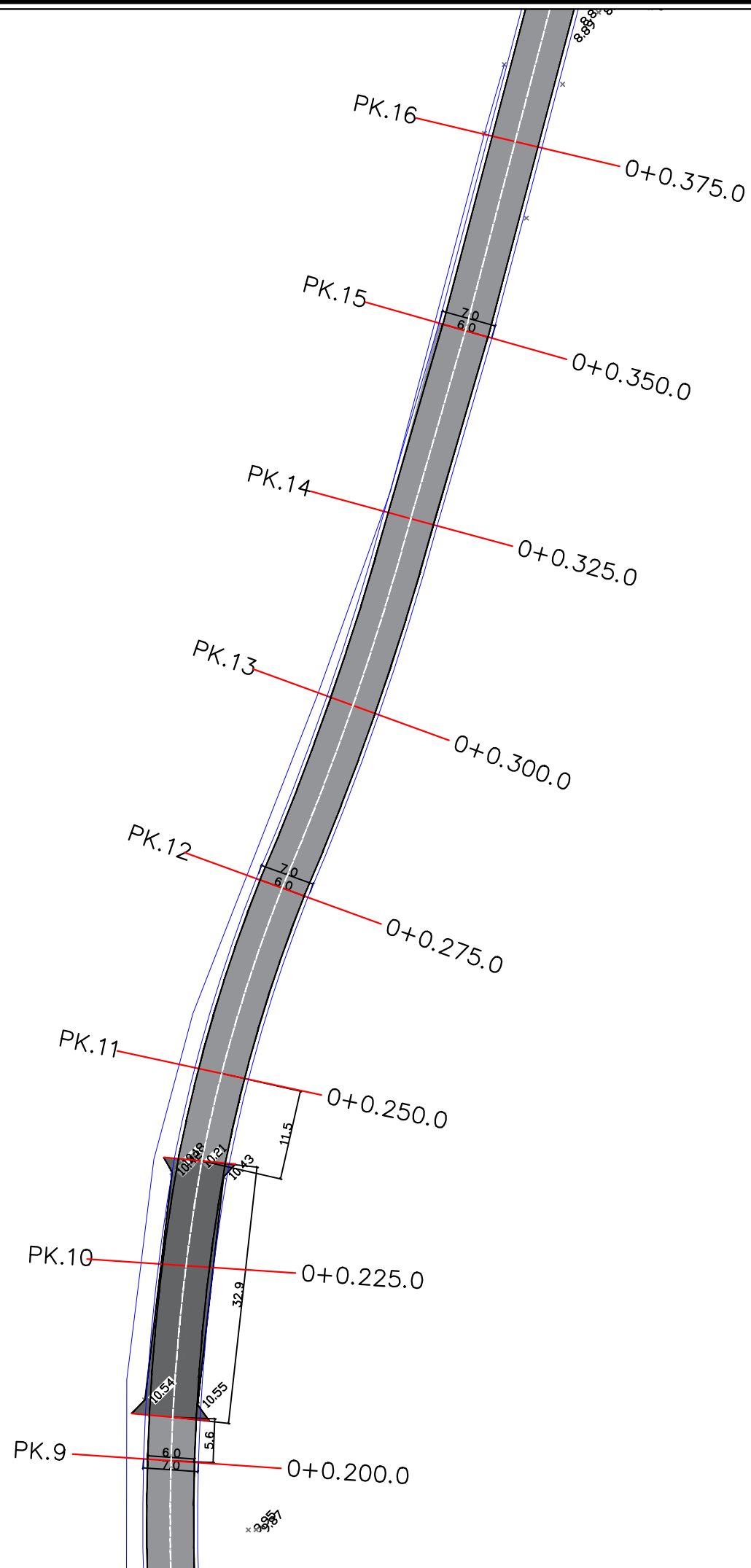



REPUBLIKA E SHQIPERISE  
BASHKIA PATOS  
DREJTORIA E ZHVILLIMIT TE  
TERRITORIT DHE EMERGJENCAVE  
CIVILE

EMERTIMI I PROJEKTIT:

**RIKONSTRUKSION I RRUGES  
RILINDJA BELINE**

EMERTIMI I FLETES:

**PLANIMETRIA E RRUGES**

GRUPI I PROJEKTIMIT:

ING. BORETA MURATI

DREJTORIA E ZHVILLIMIT TE  
TERRITORIT DHE  
EMERGJENCAVE CIVILE

ING. BORETA MURATI

SHKALLA

1:500

Fleta: Nr. 3

MAJ 2026

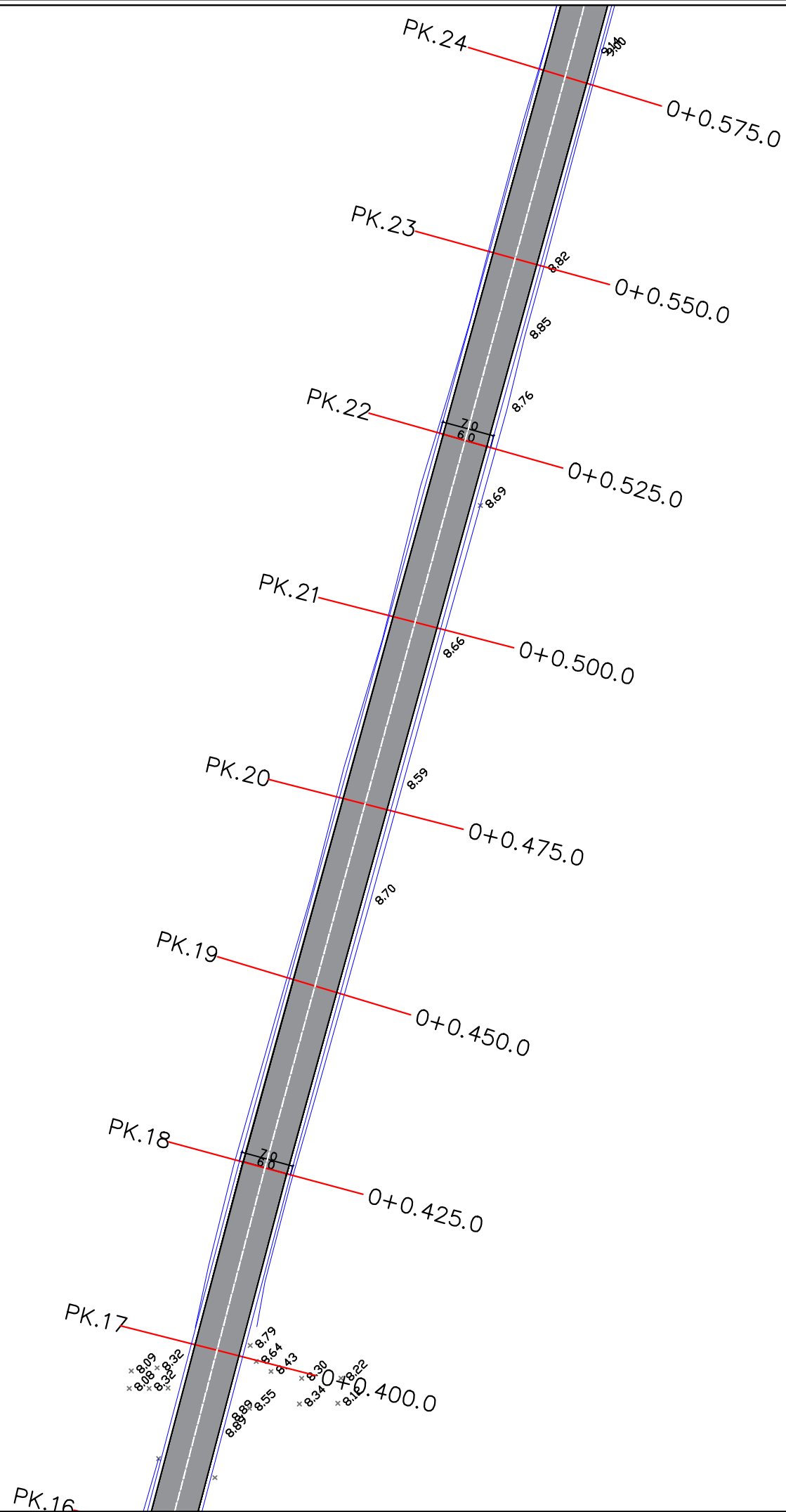



REPUBLIKA E SHQIPERISE  
BASHKIA PATOS  
DREJTORIA E ZHVILLIMIT TE  
TERRITORIT DHE EMERGJENCAVE  
CIVILE

EMERTIMI I PROJEKTIT:

**RIKONSTRUKSION I RRUGES  
RILINDJA BELINE**

EMERTIMI I FLETES:

**PLANIMETRIA E RRUGES**

GRUPI I PROJEKTIMIT:

ING. BORETA MURATI

DREJTORIA E ZHVILLIMIT TE  
TERRITORIT DHE  
EMERGJENCAVE CIVILE

ING. BORETA MURATI

SHKALLA

1:500

Fleta: Nr. 4

MAJ 2026

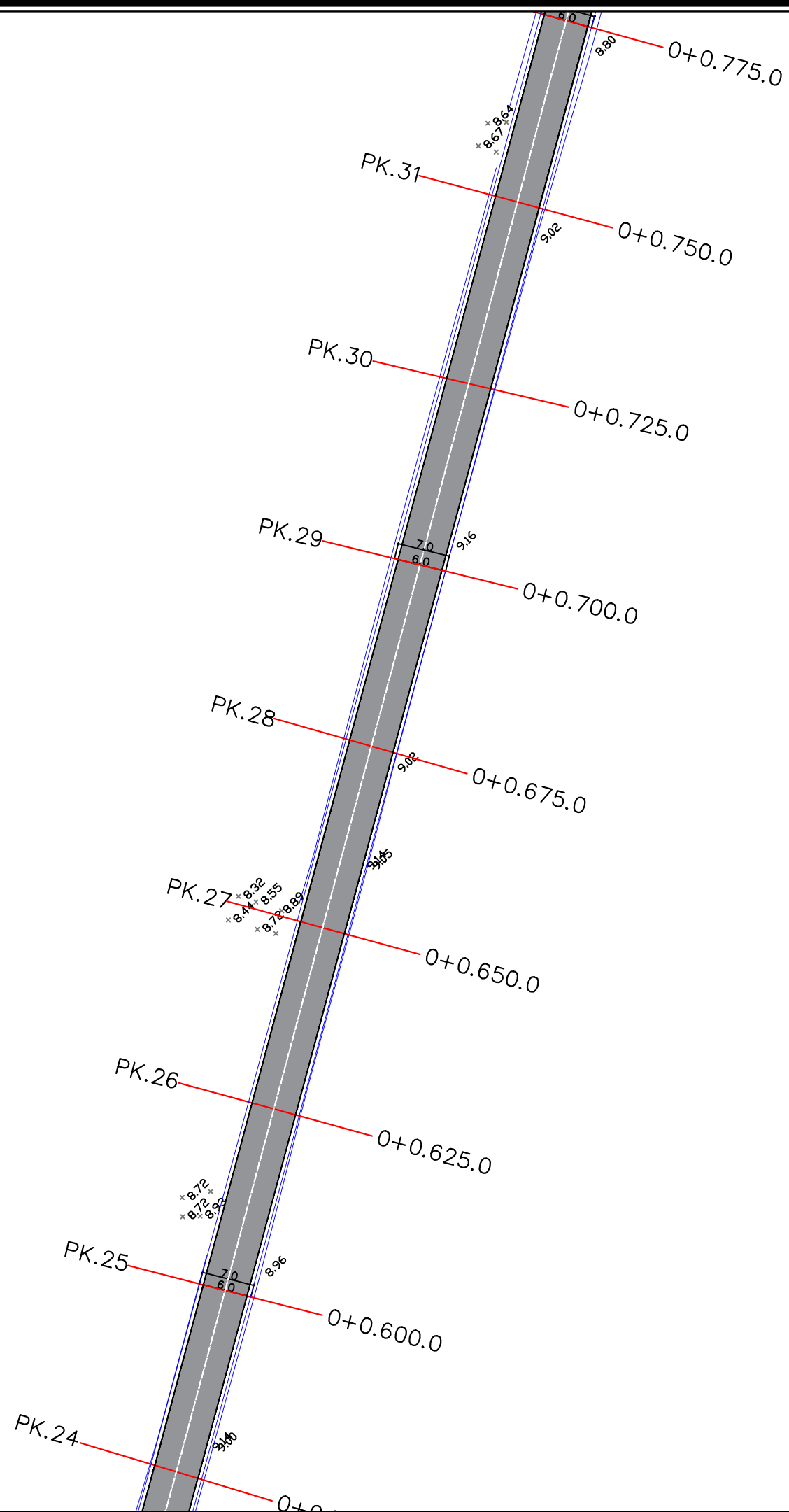



REPUBLIKA E SHQIPERISE  
BASHKIA PATOS  
DREJTORIA E ZHVILLIMIT TE  
TERRITORIT DHE EMERGJENCAVE CIVILE

EMERTIMI I PROJEKTIT:

**RIKONSTRUKSION I RRUGES  
RILINDJA BELINE**

EMERTIMI I FLETES:

**PLANIMETRIA E RRUGES**

GRUPI I PROJEKTIMIT:

ING. BORETA MURATI

DREJTORIA E ZHVILLIMIT TE  
TERRITORIT DHE  
EMERGJENCAVE CIVILE

ING. BORETA MURATI

SHKALLA

1:500

Fleta: Nr. 5

MAJ 2026

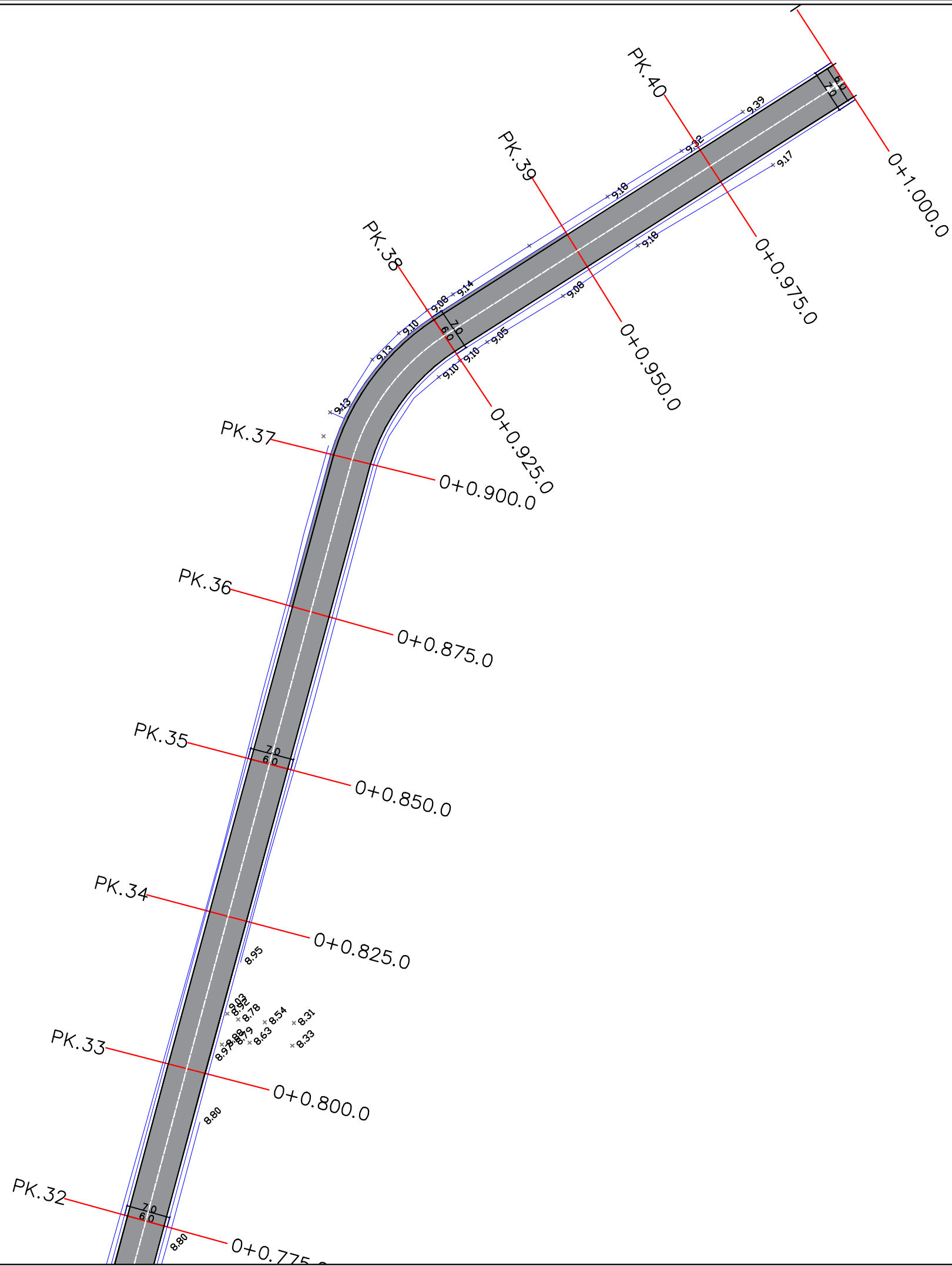



**REPUBLIKA E SHQIPERISE**  
**BASHKIA PATOS**  
DREJTORIA E ZHVILLIMIT TE TERRITORIT DHE EMERGJENCAVE CIVILE

**OBJEKTI: RIKONSTRUKSION I RRUGES RILINDJA BELINE**  
**PROFILAT GJATESOR DHE TERTHOR**

Nr. i fletëve: 12 (dymbëdhjetë) fletë

Grupi i Projektimit:

**Ing: Boreta Murati**

Drejtör :

**ING. BORETA MURATI**

MIRATOHET  
KRYETAR  
**Fation Duro**

**MAJ 2026**





REPUBLIKA E SHQIPERISE  
BASHKIA PATOS  
DREJTORIA E ZHVILLIMIT TE  
TERRITORIT DHE EMERGJENCAVE CIVILE

EMERTIMI I PROJEKTIT:

RIKONSTRUKSION I RRUGES  
RILINDJA BELINE

EMERTIMI I FLETES:

PROFILI GJATESOR

GRUPI I PROJEKTIMIT:

ING. MARSILDA KAMBERAJ

ING. BORETA MURATI

DREJTORIA E ZHVILLIMIT TE  
TERRITORIT DHE  
EMERGJENCAVE CIVILE

ING. BORETA MURATI

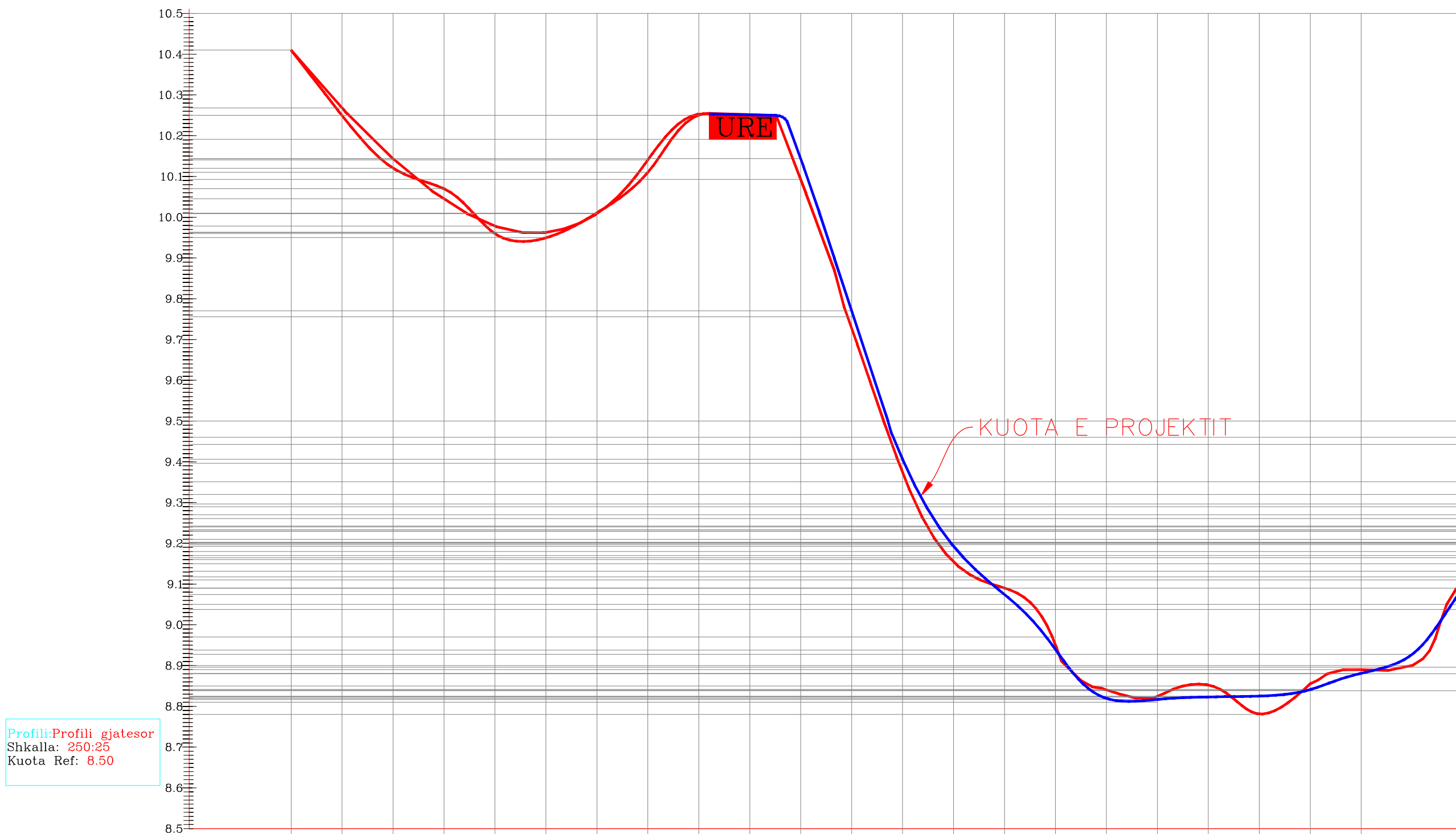

Profili: Profili gjatesor  
Shkalla: 250:25  
Kuota Ref: 8.50

DISTANCA PJESORE	25	25	25	25	25	25	25	25	25	25	25	25	25	25	25	25	25	25	25	25	25	25	25	
DISTANCA PROGRESIVE	0.00	0.25	0.50	0.75	0.100	0.125	0.150	0.175	0.200	0.225	0.250	0.275	0.300	0.325	0.350	0.375	0.400	0.425	0.450	0.475	0.500	0.525	0.550	0.575
KUOTA E TERRENIT	10.41	10.25	10.12	10.07	9.96	9.95	10.01	10.11	10.25	10.09	9.76	9.40	9.16	9.09	8.97	8.84	8.81	8.85	8.78	8.84	8.94	8.80	9.11	
KUOTA E PROJEKTIT	10.41	10.27	10.15	10.05	9.98	9.96	10.01	10.14	10.25	10.14	9.77	9.41	9.19	9.07	8.94	8.82	8.82	8.82	8.82	8.84	8.88	8.93	9.09	
PIKETA	PK.1	PK.2	PK.3	PK.4	PK.5	PK.6	PK.7	PK.8	PK.9	PK.10	PK.11	PK.12	PK.13	PK.14	PK.15	PK.16	PK.17	PK.18	PK.19	PK.20	PK.21	PK.22	PK.23	PK.24

SHKALLA

1:750

Fleta: Nr. 2

MAJ 2026





REPUBLIKA E SHQIPERISE  
BASHKIA PATOS  
DREJTORIA E ZHVILLIMIT TE  
TERRITORIT DHE EMERGJENCAVE  
CIVILE

EMERTIMI I PROJEKTIT:

RIKONSTRUKSION I RRUGES  
RILINDJA BELINE

EMERTIMI I FLETES:

PROFILAT TERTHORE  
TE RRUGES EKZISTUESE

GRUPI I PROJEKTIMIT:

ING. MARSILDA KAMBERAJ

ING. BORETA MURATI

DREJTORIA E ZHVILLIMIT TE  
TERRITORIT DHE  
EMERGJENCAVE CIVILE

ING. BORETA MURATI

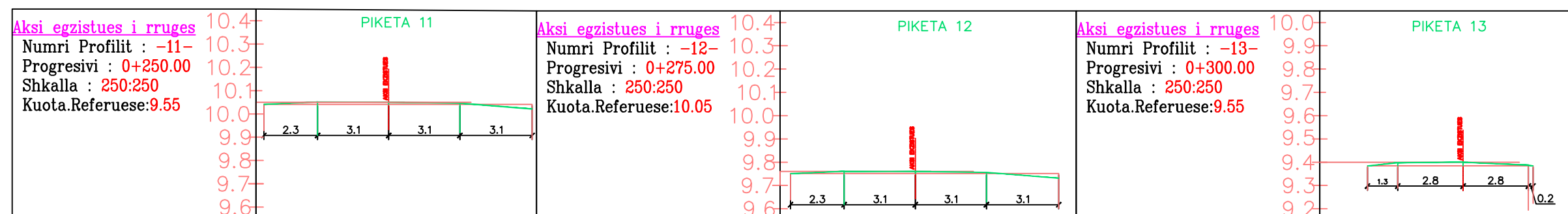
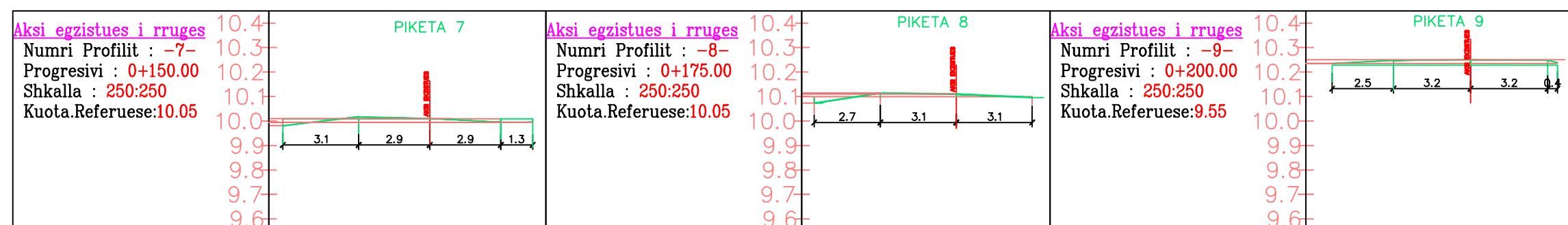
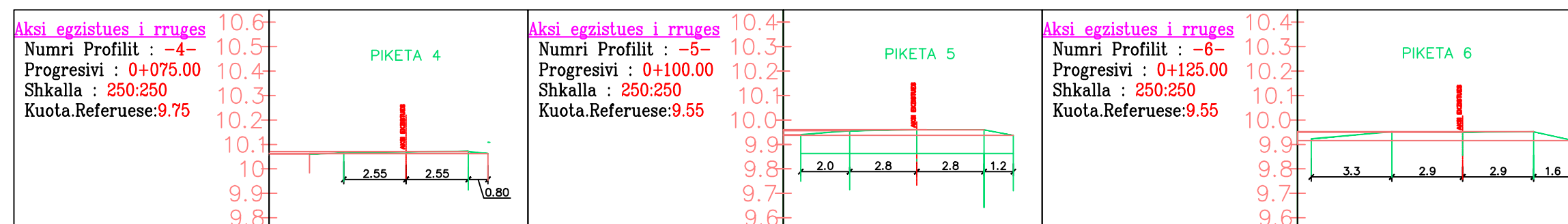
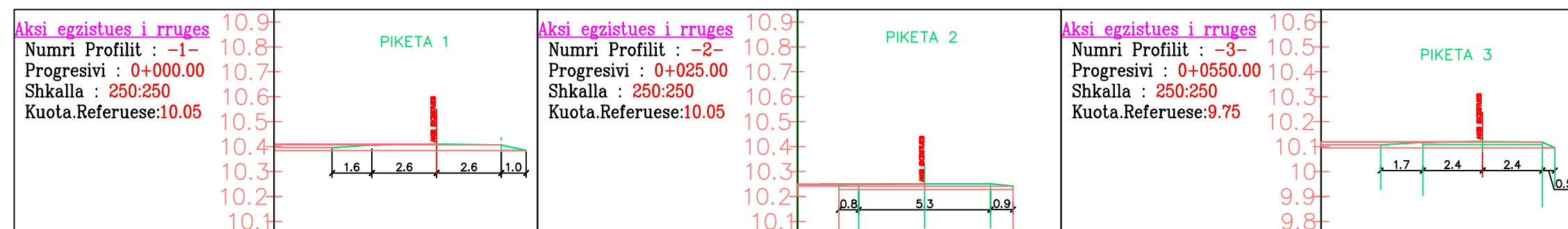

SHKALLA

1:150

Fleta: Nr. 4

MAJ 2026



REPUBLIKA E SHQIPERISE  
BASHKIA PATOS  
DREJTORIA E ZHVILLIMIT TE  
TERRITORIT DHE EMERGJENCAVE  
CIVILE

EMERTIMI I PROJEKTIT:

RIKONSTRUKSION I RRUGES  
RILINDJA BELINE

EMERTIMI I FLETES:

PROFILAT TERTHORE  
TE RRUGES EKZISTUESE

GRUPI I PROJEKTIMIT:

ING. MARSILDA KAMBERAJ

ING. BORETA MURATI

DREJTORIA E ZHVILLIMIT TE  
TERRITORIT DHE  
EMERGJENCAVE CIVILE

ING. BORETA MURATI

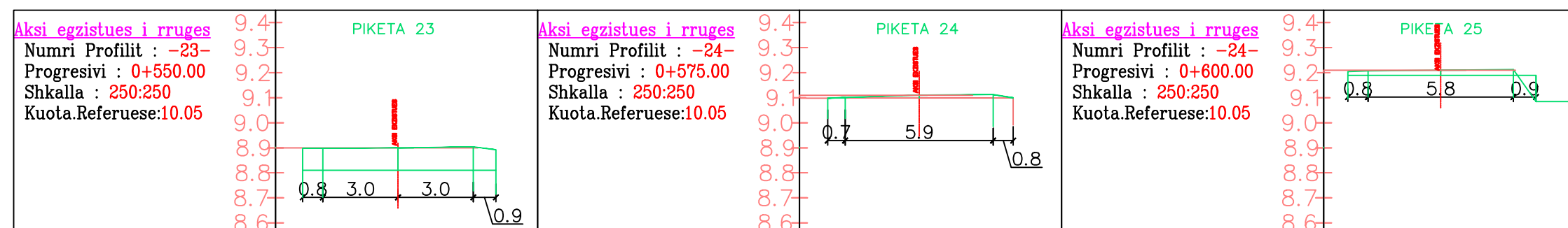
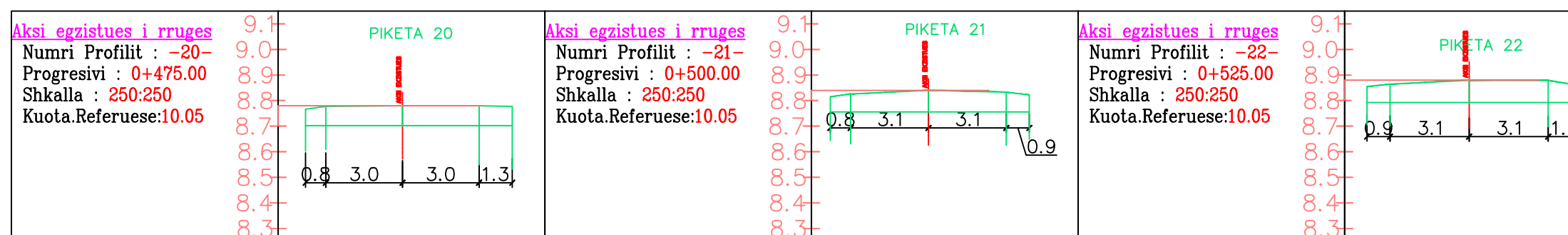
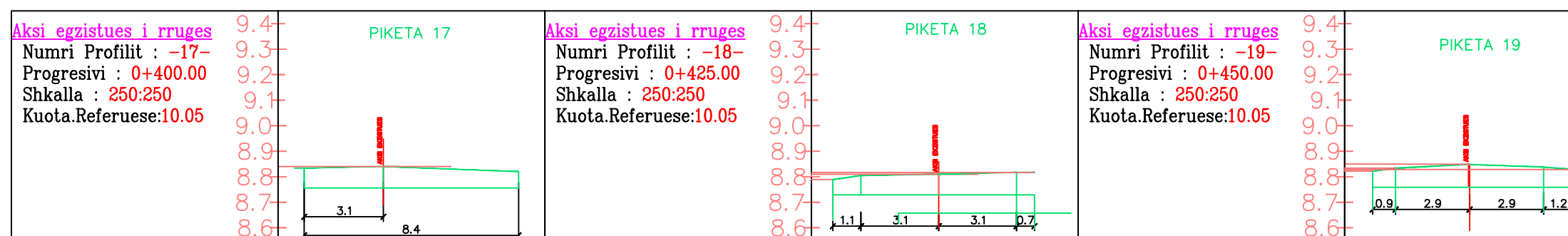
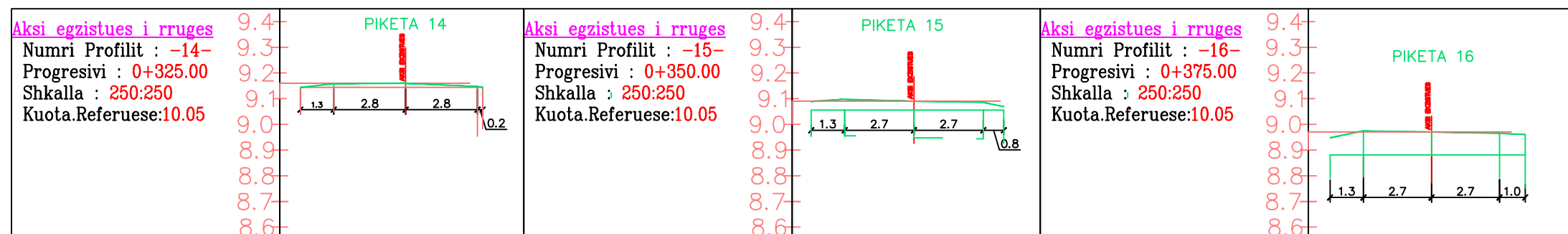

SHKALLA

1:150

Fleta: Nr. 5

MAJ 2026



REPUBLIKA E SHQIPERISE  
BASHKIA PATOS  
DREJTORIA E ZHVILLIMIT TE  
TERRITORIT DHE EMERGJENCAVE  
CIVILE

EMERTIMI I PROJEKTIT:

RIKONSTRUKSION I RRUGES  
RILINDJA BELINE

EMERTIMI I FLETES:

PROFILAT TERTHORE  
TE RRUGES EKZISTUESE

GRUPI I PROJEKTIMIT:

ING. MARSILDA KAMBERAJ

ING. BORETA MURATI

DREJTORIA E ZHVILLIMIT TE  
TERRITORIT DHE  
EMERGJENCAVE CIVILE

ING. BORETA MURATI

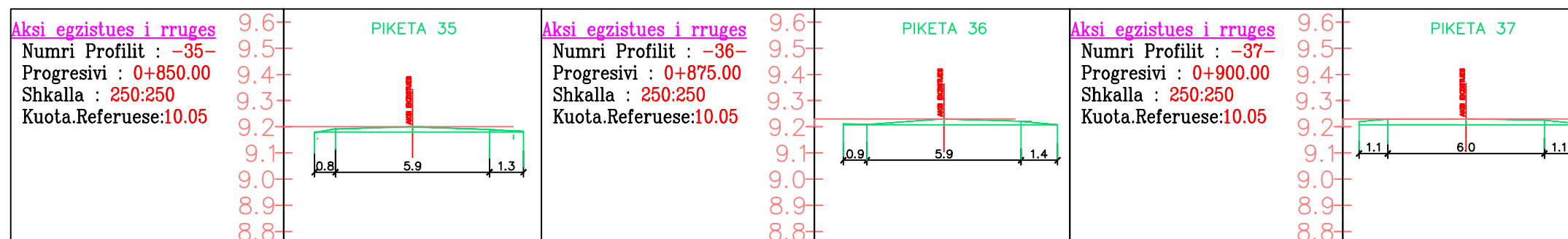
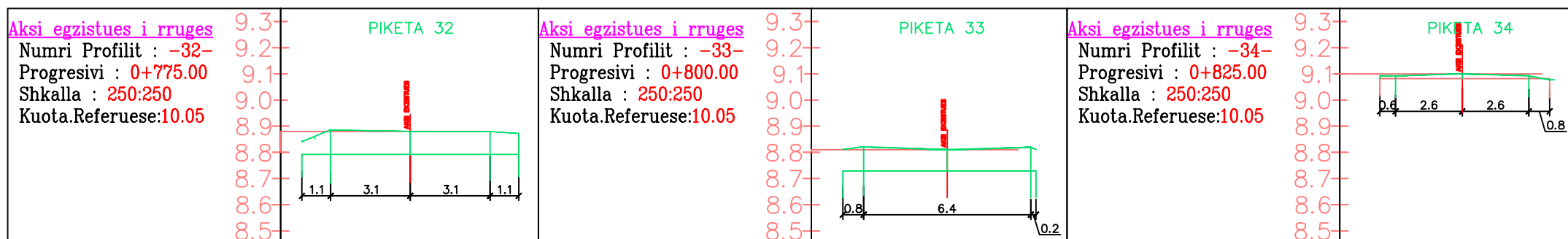
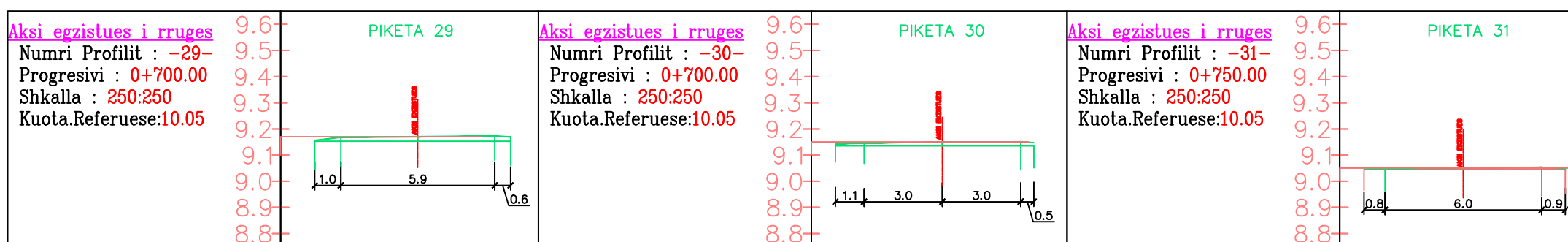
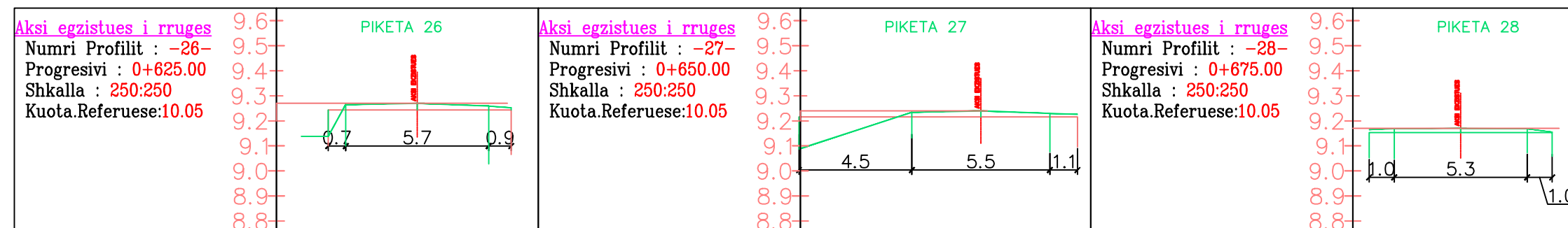

SHKALLA

1:150

Fleta: Nr. 6

MAJ 2026



REPUBLIKA E SHQIPERISE  
BASHKIA PATOS  
DREJTORIA E ZHVILLIMIT TE  
TERRITORIT DHE EMERGJENCAVE  
CIVILE

EMERTIMI I PROJEKTIT:

RIKONSTRUKSION I RRUGES  
RILINDJA BELINE

EMERTIMI I FLETES:

PROFILAT TERTHORE  
TE RRUGES EKZISTUESE

GRUPI I PROJEKTIMIT:

ING. MARSILDA KAMBERAJ

ING. BORETA MURATI

DREJTORIA E ZHVILLIMIT TE  
TERRITORIT DHE  
EMERGJENCAVE CIVILE

ING. BORETA MURATI

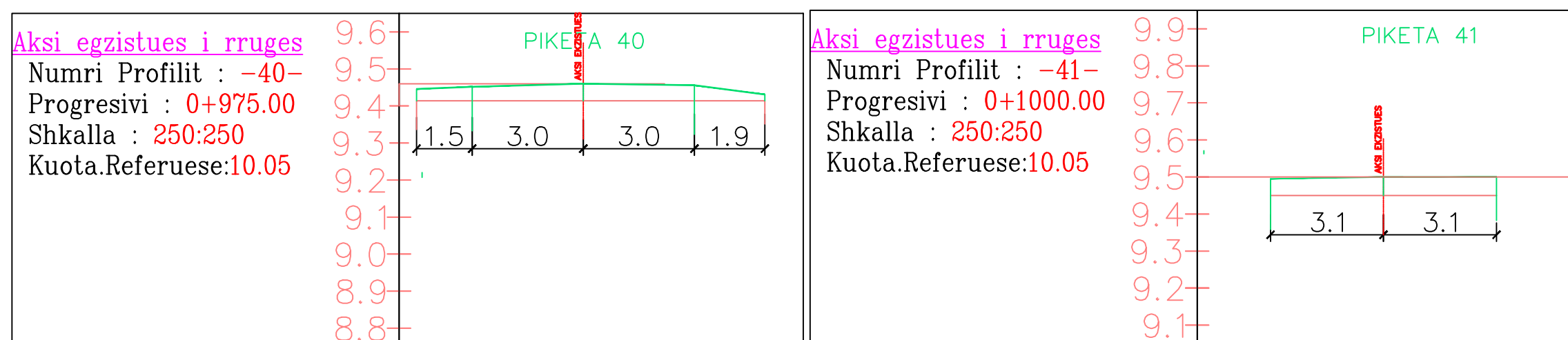
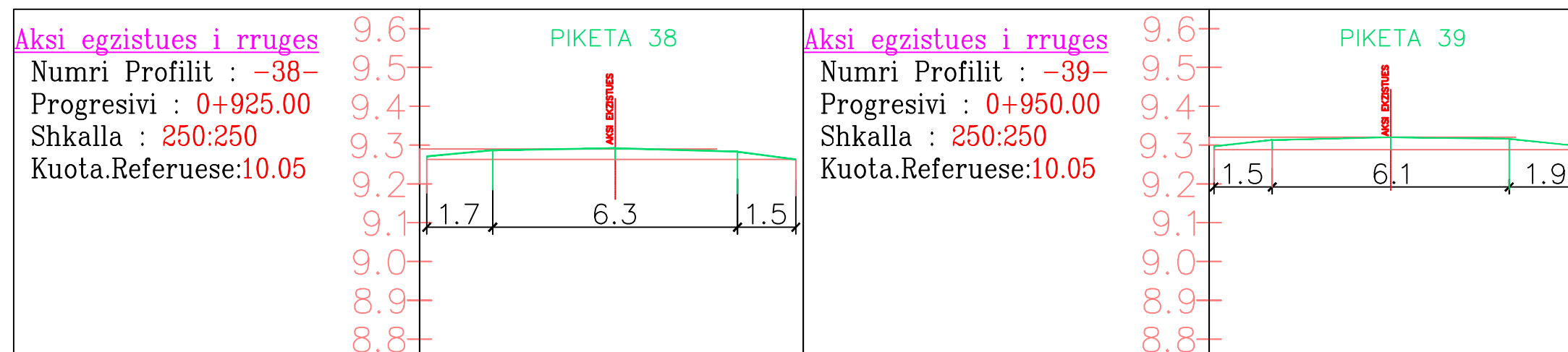

SHKALLA

1:100

Fleta: Nr. 7

MAJ 2026



REPUBLIKA E SHQIPERISE  
BASHKIA PATOS

DREJTORIA E ZHVILLIMIT TË TERRITORIT  
DHE EMERGJENCAVE CIVILE

EMERTIMI I PROJEKTIT:

**RIKONSTRUKSION I RRUGES  
"RILINDJA", BELINE**

EMERTIMI I FLETES:

Profil tërthor Tip nr.1 i rruges

GRUPI I PROJEKTIMIT:

Ing. Boreta Murati

DREJTORIA E ZHVILLIMIT TË  
TERRITORIT DHE  
EMERGJENCAVE CIVILE

Ing. Boreta Murati

SHKALLA

1:500

Fleta: Nr. 8

Prill 2026

# PROFIL TERTHOR TIP

AKSI I RRUGES

700

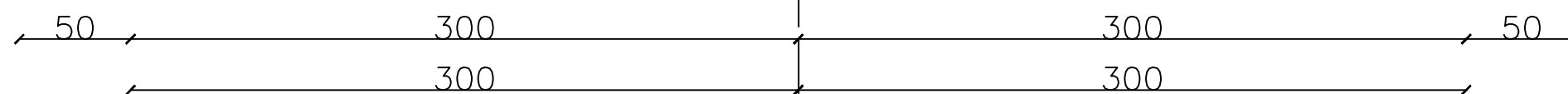

2.5%

2.5%

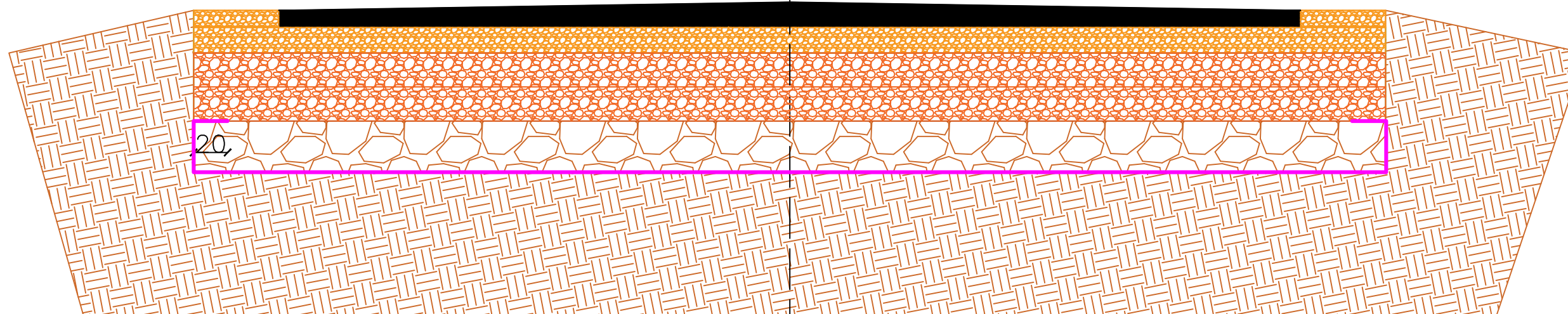

- Shtrese Asfaltobeton 4 cm
- Shtrese Binder 6 cm
- Shtrese Stabilizant 15 cm
- Shtrese Cakell i ngjeshur 20 cm
- Shtrese Cakell i ngjeshur 20 cm
- Shtrese gur te radhitur 30 cm
- Gjeotekstil me gramature 280g/m2
- Kasonete e cilindruar



REPUBLIKA E SHQIPERISE  
BASHKIA PATOS  
DREJTORIA E ZHVILLIMIT TE  
TERRITORIT DHE EMERGJENCAVE  
CIVILE

EMERTIMI I PROJEKTIT:

RIKONSTRUKSION I RRUGES  
RILINDJA BELINE

EMERTIMI I FLETES:

PROFILAT TERTHORE TE  
RRUGES SE RE

GRUPI I PROJEKTIMIT:

ING. MARSILDA KAMBERAJ

ING. BORETA MURATI

DREJTORIA E ZHVILLIMIT TE  
TERRITORIT DHE  
EMERGJENCAVE CIVILE

ING. BORETA MURATI

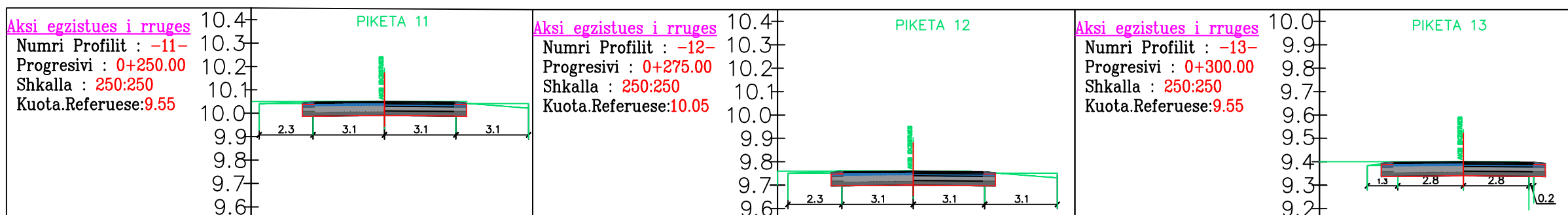
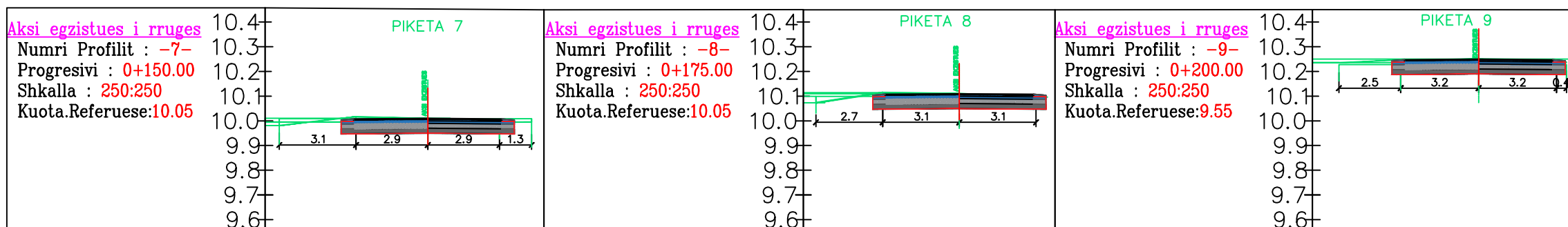
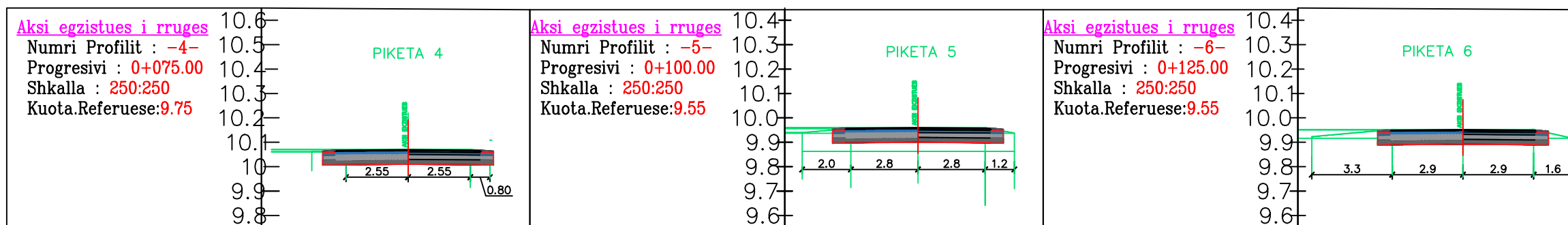
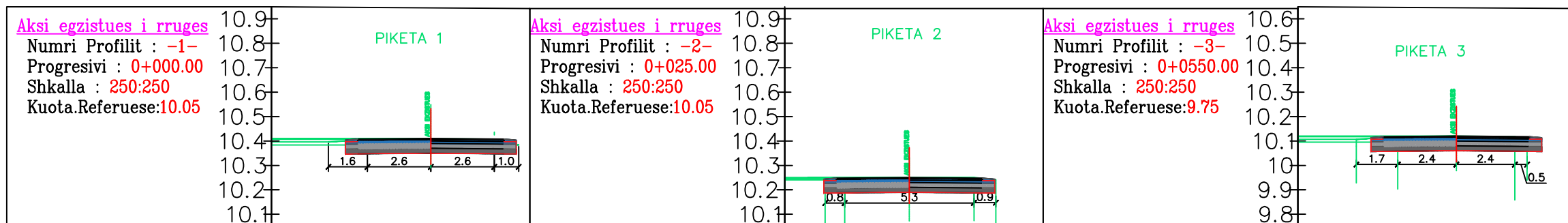

SHKALLA

1:150

Fleta: Nr. 9

MAJ 2026



REPUBLIKA E SHQIPERISE  
BASHKIA PATOS  
DREJTORIA E ZHVILLIMIT TE  
TERRITORIT DHE EMERGJENCAVE  
CIVILE

EMERTIMI I PROJEKTIT:

RIKONSTRUKSION I RRUGES  
RILINDJA BELINE

EMERTIMI I FLETES:

PROFILAT TERTHORE TE  
RRUGES SE RE

GRUPI I PROJEKTIMIT:

ING. MARSILDA KAMBERAJ

ING. BORETA MURATI

DREJTORIA E ZHVILLIMIT TE  
TERRITORIT DHE  
EMERGJENCAVE CIVILE

ING. BORETA MURATI

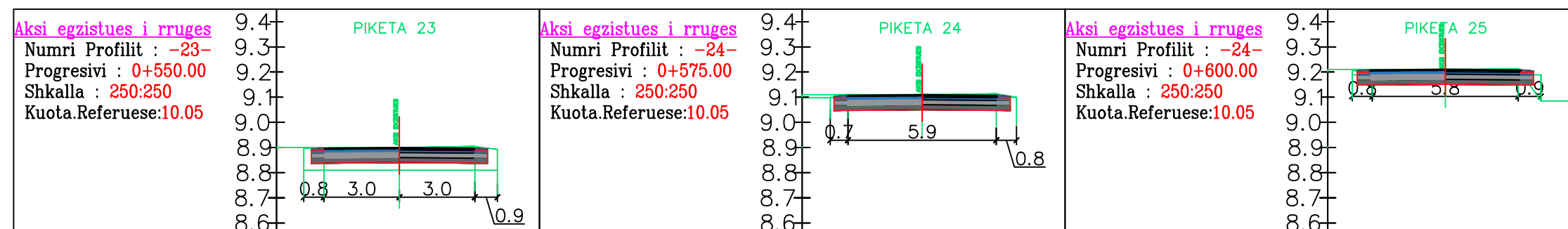
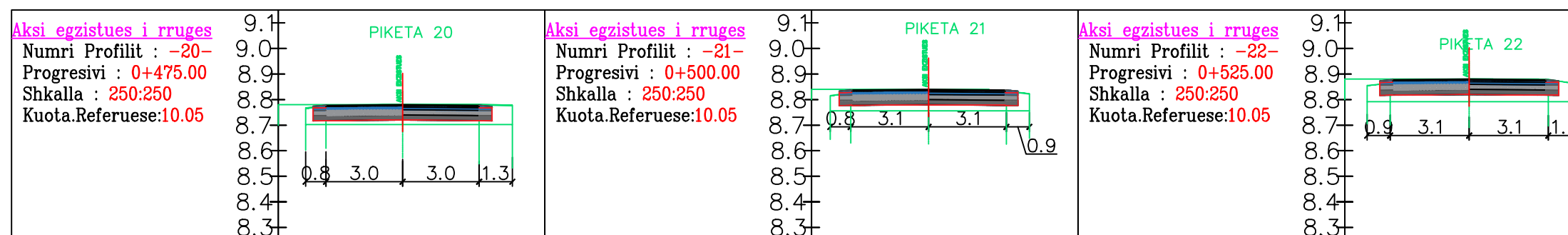
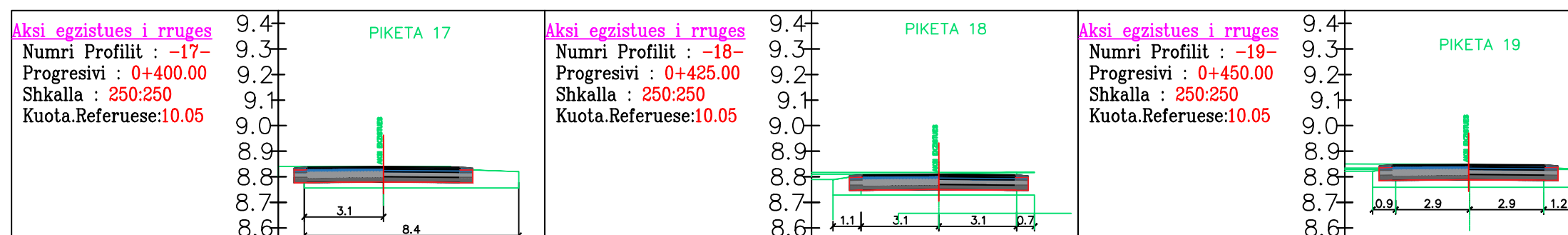
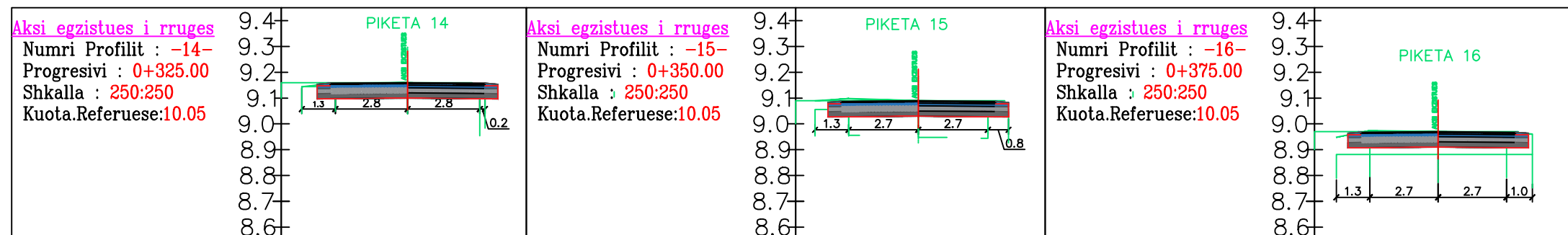

SHKALLA

1:150

Fleta: Nr. 10

MAJ 2026



REPUBLIKA E SHQIPERISE  
BASHKIA PATOS  
DREJTORIA E ZHVILLIMIT TE  
TERRITORIT DHE EMERGJENCAVE  
CIVILE

EMERTIMI I PROJEKTIT:

RIKONSTRUKSION I RRUGES  
RILINDJA BELINE

EMERTIMI I FLETES:

PROFILAT TERTHORE TE  
RRUGES SE RE

GRUPI I PROJEKTIMIT:

ING. MARSILDA KAMBERAJ

ING. BORETA MURATI

DREJTORIA E ZHVILLIMIT TE  
TERRITORIT DHE  
EMERGJENCAVE CIVILE

ING. BORETA MURATI

SHKALLA

1:150

Fleta: Nr.11

MAJ 2026

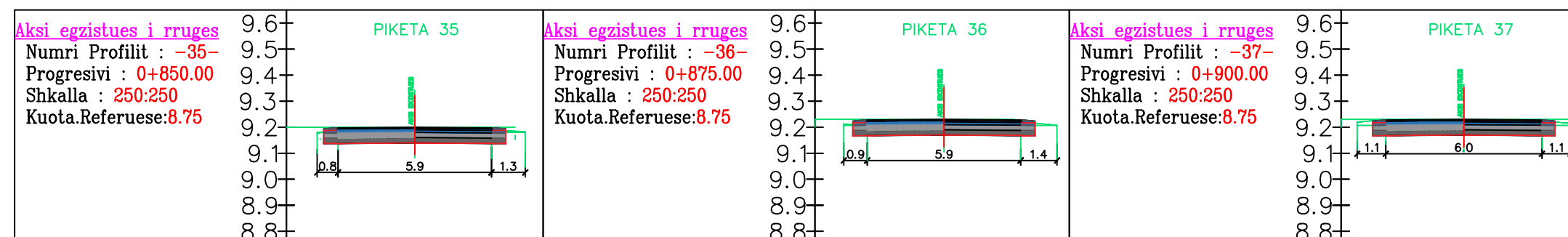
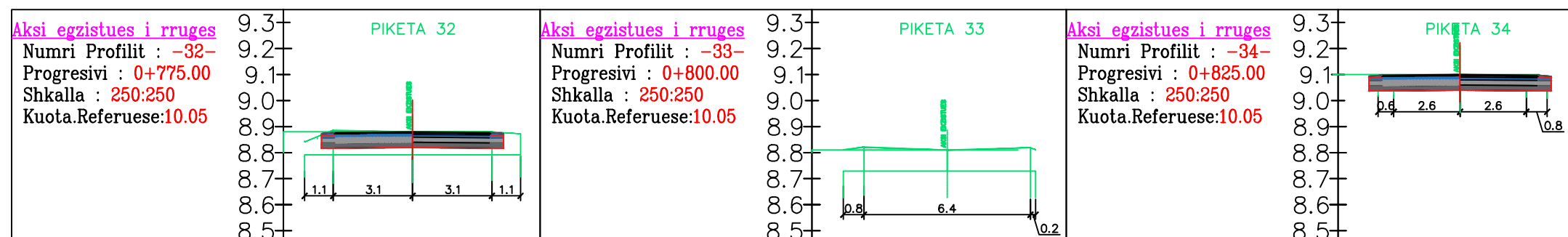
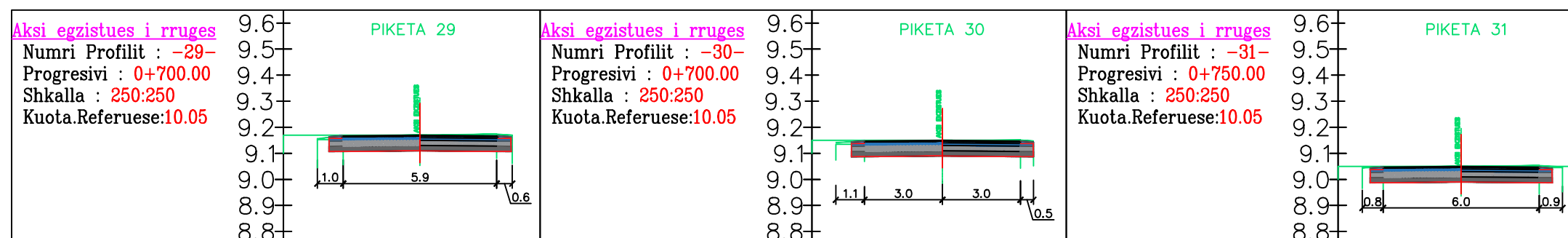
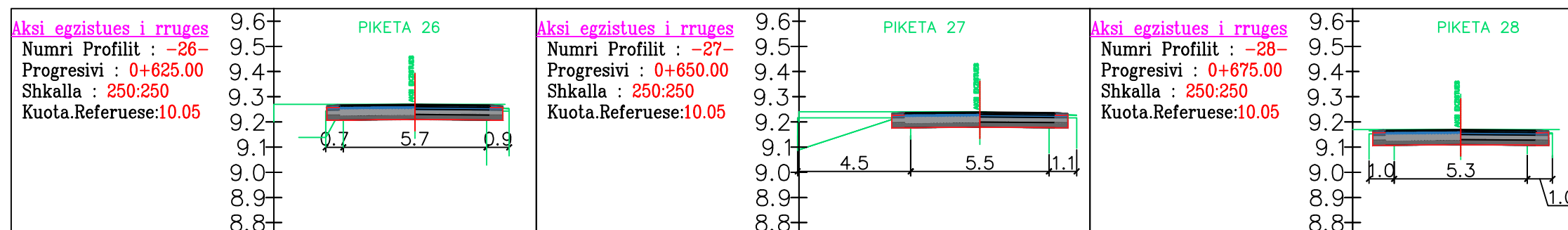



REPUBLIKA E SHQIPERISE  
BASHKIA PATOS  
DREJTORIA E ZHVILLIMIT TE  
TERRITORIT DHE EMERGJENCAVE  
CIVILE

EMERTIMI I PROJEKTIT:

RIKONSTRUKSION I RRUGES  
RILINDJA BELINE

EMERTIMI I FLETES:

PROFILAT TERTHORE TE  
RRUGES SE RE

GRUPI I PROJEKTIMIT:

ING. MARSILDA KAMBERAJ

ING. BORETA MURATI

DREJTORIA E ZHVILLIMIT TE  
TERRITORIT DHE  
EMERGJENCAVE CIVILE

ING. BORETA MURATI

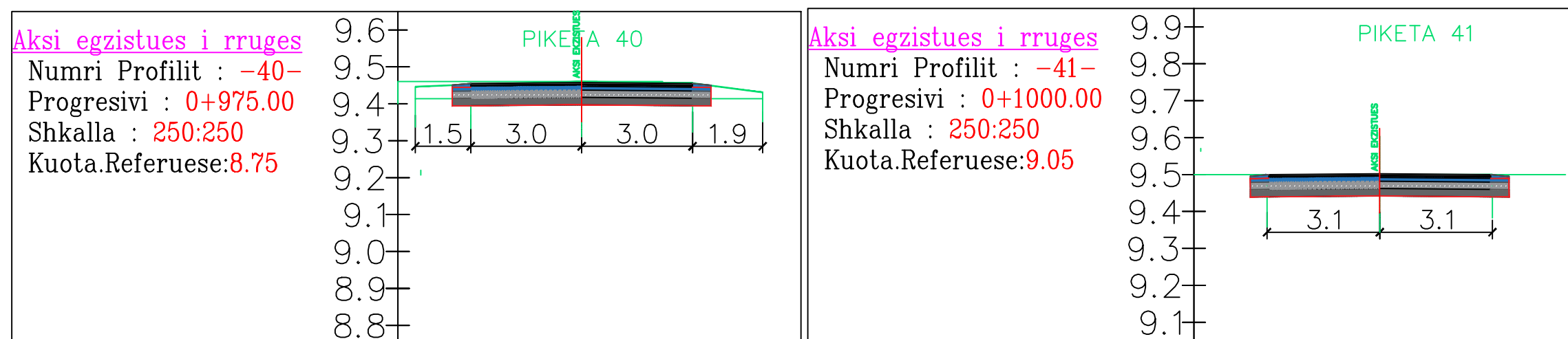
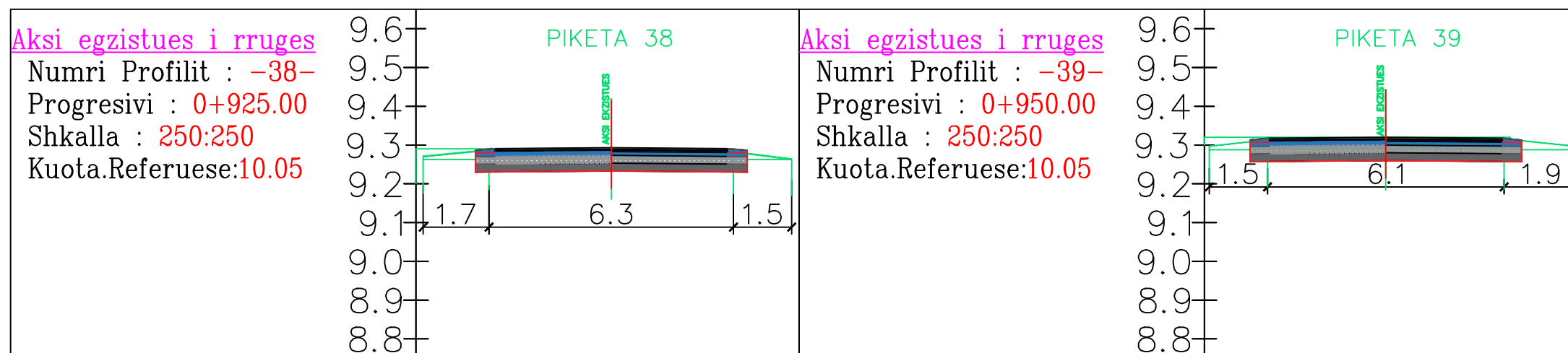

SHKALLA

1:150

Fleta: Nr. 12

MAJ 2026