

TITULLI I PROJEKTIT

“Rikualifikim Blloku qe Kufizohet nga Rruget "Haxhi Xhuzi" - "Reze Drite" - "Halil Hoxha”

FAZA

PROJEKT ZBATIM

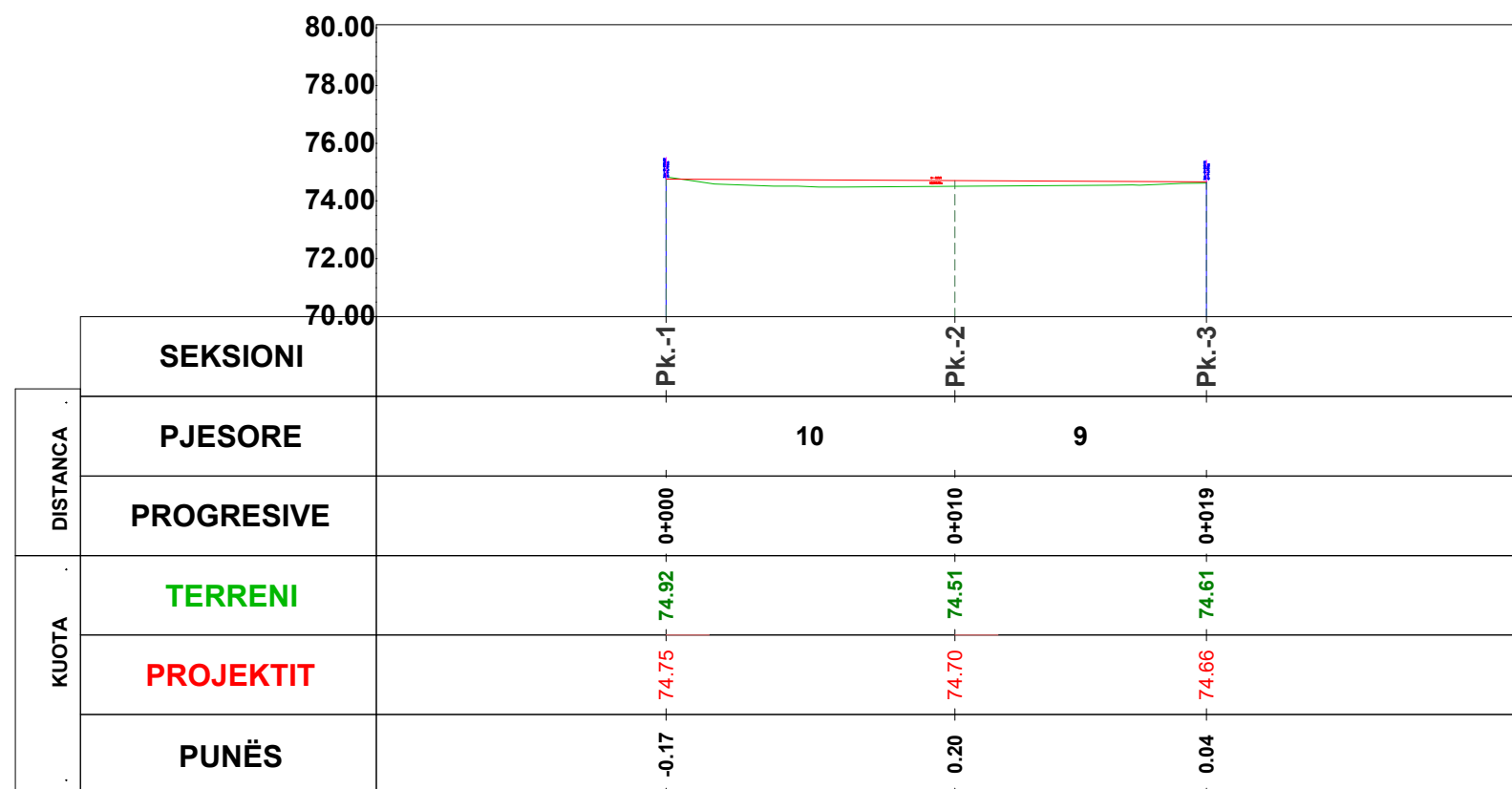

PROFILI GJATESOR

EMËRTIMI I FLETËS **AKSI 4**

SHKALLA **1:250**

NUMRI I FLETËS **T-52**

2024

AUTORITETI KONTRAKTOR:
BASHKIA TIRANË



PROJEKTUESI: "MANTE KONSTRUKSION" SH.P.K. & "FOCUS ARCHITECTURE" SH.P.K.



TITULLI I PROJEKTIT

“Rikualifikim Blloku qe Kufizohet nga Rruget "Haxhi Xhuzi" - "Reze Drite" - "Halil Hoxha”

FAZA

PROJEKT ZBATIM

SEKSIONET TERTHORE

EMËRTIMI I FLETËS **AKSI 4**

SHKALLA **1:100**

NUMRI I FLETËS **T-53**

2024

AUTORITETI KONTRAKTOR:
BASHKIA TIRANË



BASHKIA
TIRANË

PROJEKTUESI: "VAANTE KONSTRUKSION" SH.P.A. & "FOCUS ARCHITECTURE" SH.P.A.



PROJEKTI TERRENI

Km.0+000.00 (Progresivi-1)

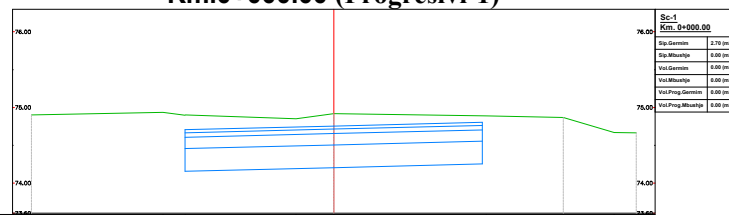

Kuota	74.50	74.94	74.90	74.85	74.92	74.89	74.97	74.67
Prog.	-4.00	-2.26	-1.96	-0.50	0.00	2.02	3.03	3.70
Kuota		-4.97	-74.71		0.00	-74.75		4.00
Prog.						1.96	-74.80	

PROJEKTI TERRENI

Km.0+010.00 (Progresivi-2)

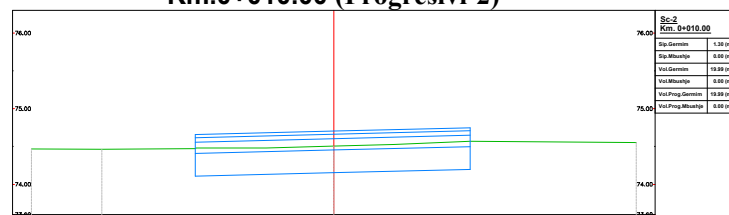

Kuota	74.47	74.46	74.48	74.48	74.51	74.53	74.57	74.55
Prog.	-4.00	-3.07	-1.82	-0.90	0.00	0.79	1.80	4.00
Kuota			-74.66		0.00	-74.70	-74.75	
Prog.			-1.83				1.80	

PROJEKTI TERRENI

Km.0+018.71 (Progresivi-3)

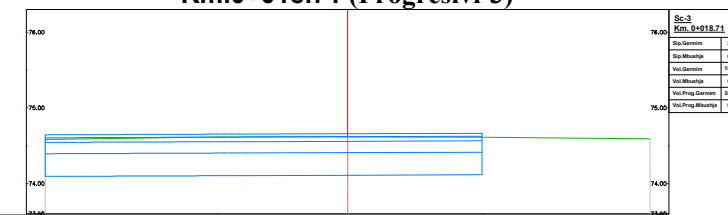

Kuota	74.59		74.62		74.51	74.51	74.59
Prog.	-4.00		-1.72		0.00	1.79	4.00
Kuota	-74.64	-74.65	-74.65	-74.66	-74.65	-74.65	
Prog.		-3.04	-2.03	-1.03	0.00	1.07	1.78

TITULLI I PROJEKTIT

“Rikualifikim Blloku qe Kufizohet nga Rruget "Haxhi Xhuzi" - "Reze Drite" - "Halil Hoxha”

FAZA

PROJEKT ZBATIM

Tabela Volumeve

Progresivi	Sip.Mbushje	Sip.Germim	Vol.Mbushje	Vol.Germim	Vol.Prog.Mbush	Vol.Prog.Germim
0+000.00	0.00	2.70	0.00	0.00	0.00	0.00
0+010.00	0.00	1.30	0.00	19.99	0.00	19.99
0+018.71	0.00	2.91	0.00	18.34	0.00	38.33

TABELA E VOLUMEVE

EMËRTIMI I FLETËS **AKSI 4**

SHKALLA

NUMRI I FLETËS **T-54**

2024

AUTORITETI KONTRAKTOR:
BASHKIA TIRANË



PROJEKTUESI: "MANTE KONSTRUKSION" SH.P.K. & "FOCUS ARCHITECTURE" SH.P.K.



TITULLI I PROJEKTIT

“Rikualifikim Blloku qe Kufizohet nga Rruget "Haxhi Xhuzi" - "Reze Drite" - "Halil Hoxha”

FAZA

PROJEKT ZBATIM

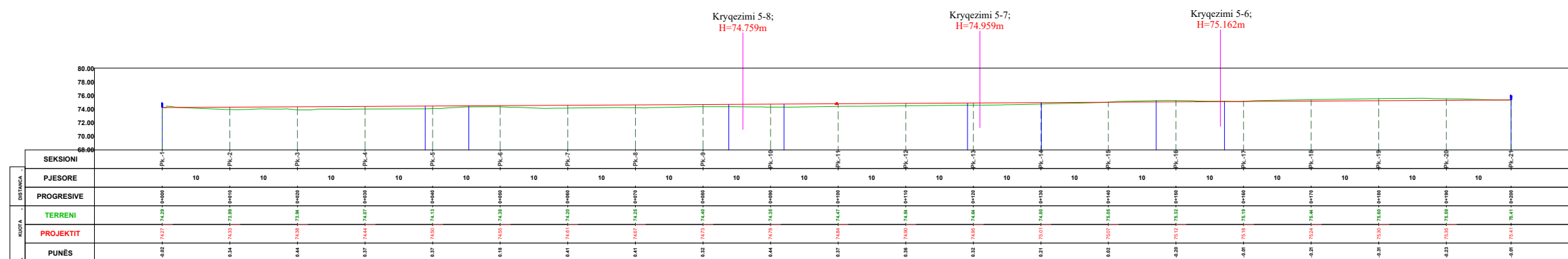

PROFILI GJATESOR

EMËRTIMI I FLETËS **AKSI 5**

SHKALLA

NUMRI I FLETËS **T-55**

2024

AUTORITETI KONTRAKTOR:
BASHKIA TIRANË



PROJEKTUESI: "MANTE KONSTRUKSION" SH.P.K. & "FOCUS ARCHITECTURE" SH.P.K.



TITULLI I PROJEKTIT

“Rikualifikim Blloku qe Kufizohet nga Rruget "Haxhi Xhuzi" - "Reze Drite" - "Halil Hoxha”

FAZA

PROJEKT ZBATIM

PROFILI GJATESOR

EMËRTIMI I FLETËS **AKSI 5**

SHKALLA **1:250**

NUMRI I FLETËS **T-56**

2024

AUTORITETI KONTRAKTOR:
BASHKIA TIRANË



PROJEKTUESI: "MANTE KONSTRUKSION" SH.P.K. & "FOCUS ARCHITECTURE" SH.P.K.

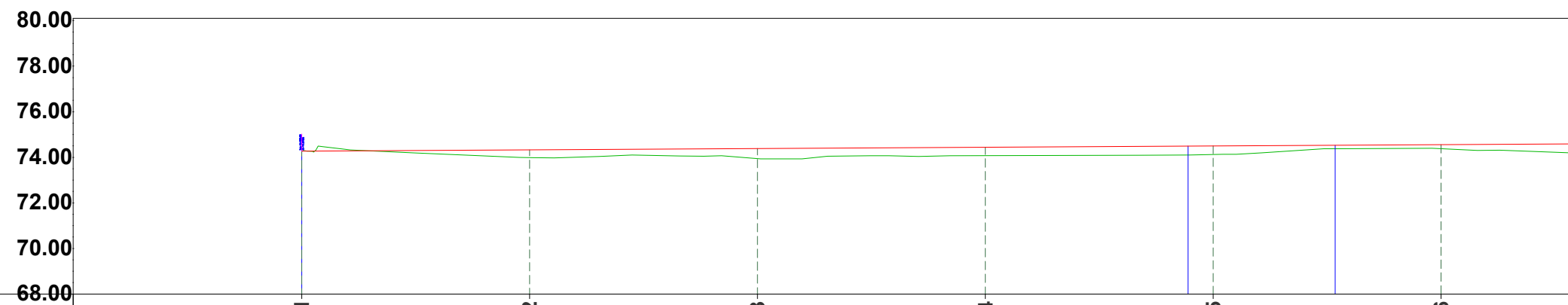

DISTANCA	SEKSIONI	Pk.-1	Pk.-2	Pk.-3	Pk.-4	Pk.-5	Pk.-6
	PJESORE		10	10	10	10	10
PROGRESIVE		0+000	0+010	0+020	0+030	0+040	0+050
KUOTA	TERRENI	74.29	73.99	73.94	74.07	74.13	74.38
	PROJEKTIT	74.27	74.33	74.38	74.44	74.50	74.55
	PUNËS	-0.02	0.34	0.44	0.37	0.37	0.18

TITULLI I PROJEKTIT

“Rikualifikim Blloku qe Kufizohet nga Rruget "Haxhi Xhuzi" - "Reze Drite" - "Halil Hoxha”

FAZA

PROJEKT ZBATIM

PROFILI GJATESOR

EMËRTIMI I FLETËS **AKSI 5**

SHKALLA **1:250**

NUMRI I FLETËS **T-57**

2024

AUTORITETI KONTRAKTOR:
BASHKIA TIRANË



PROJEKTUESI: "MANTE KONSTRUKSION" SH.P.K. & "FOCUS ARCHITECTURE" SH.P.K.

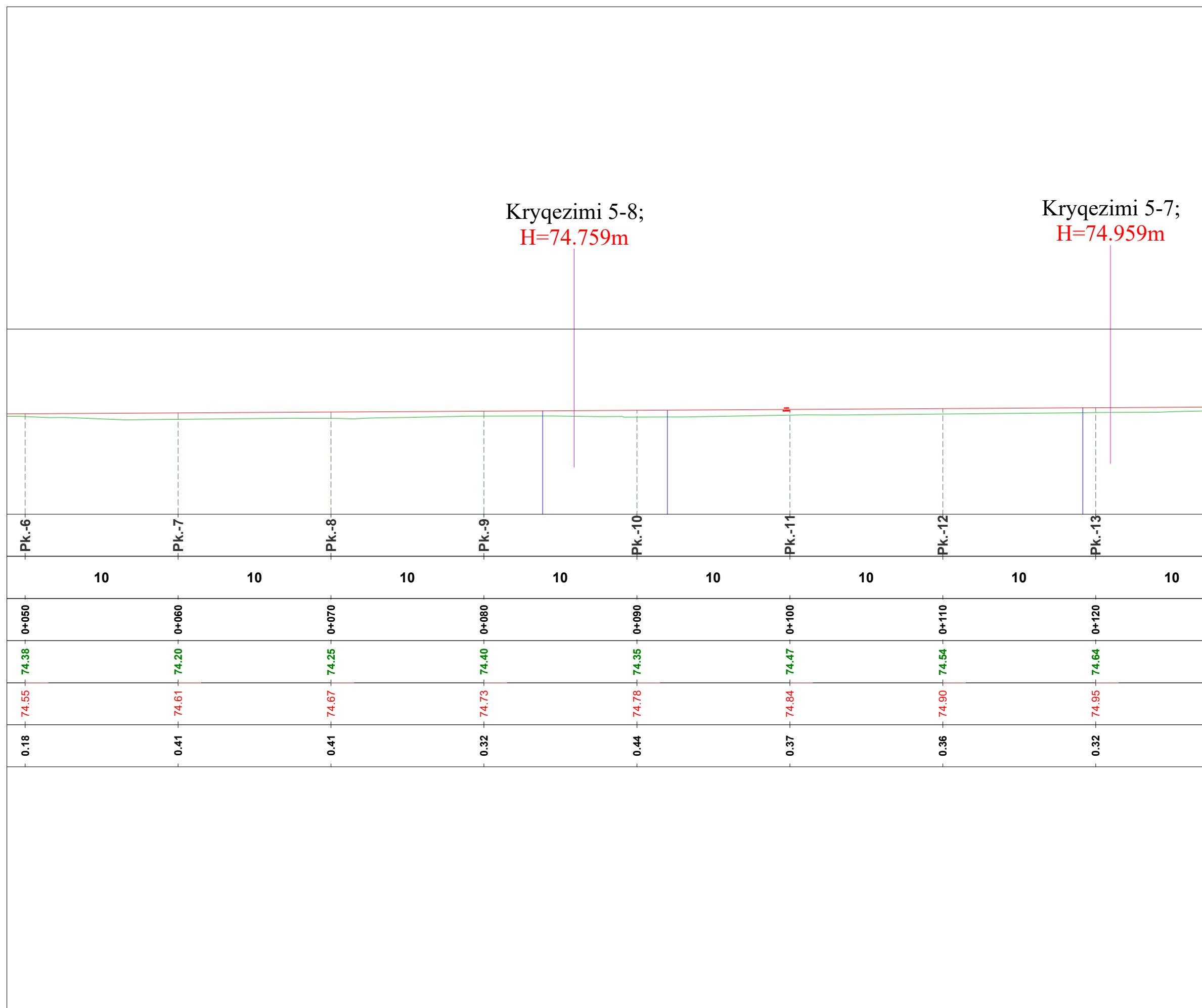

TITULLI I PROJEKTIT

“Rikualifikim Blloku qe Kufizohet nga Rruget "Haxhi Xhuzi" - "Reze Drite" - "Halil Hoxha”

FAZA

PROJEKT ZBATIM

PROFILI GJATESOR

EMËRTIMI I FLETËS **AKSI 5**

SHKALLA **1:250**

NUMRI I FLETËS **T-58**

2024

AUTORITETI KONTRAKTOR:
BASHKIA TIRANË



PROJEKTUESI: "MANTE KONSTRUKSION" SH.P.K. & "FOCUS ARCHITECTURE" SH.P.K.



Kryqezimi 5-7;
H=74.959m

Kryqezimi 5-6;
H=75.162m

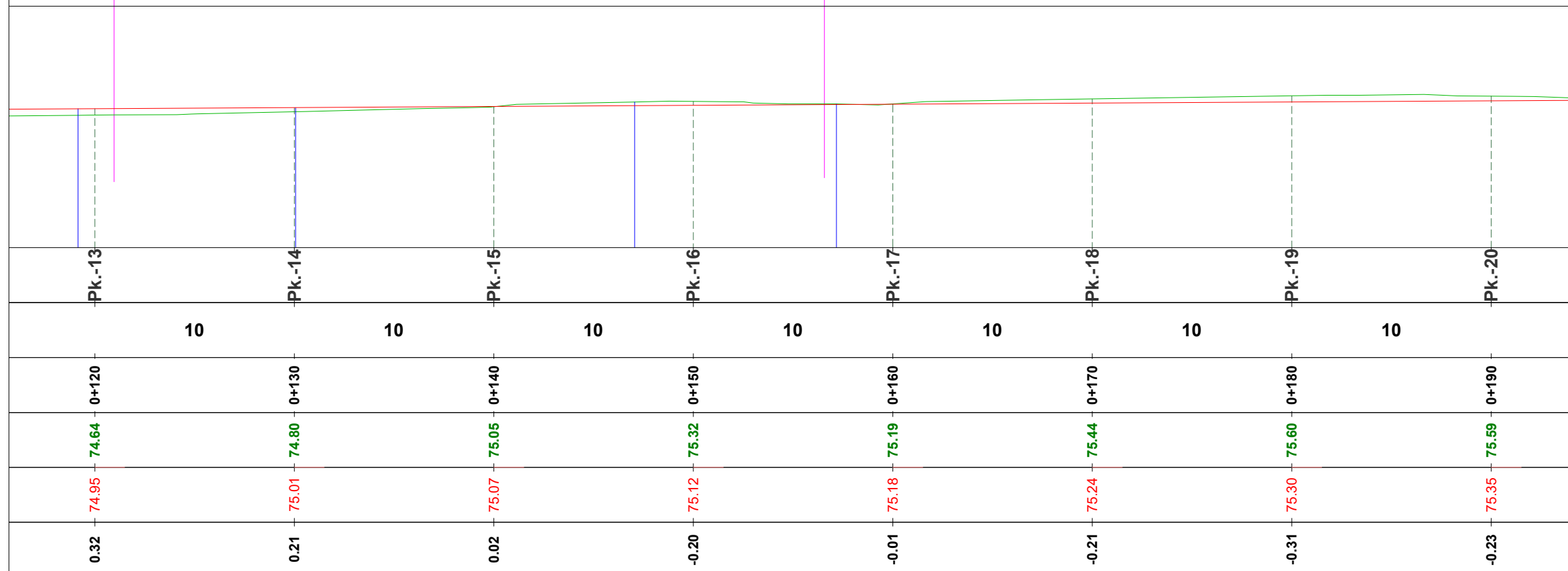

TITULLI I PROJEKTIT

“Rikualifikim Blloku qe Kufizohet nga Rruget "Haxhi Xhuzi" - "Reze Drite" - "Halil Hoxha”

FAZA

PROJEKT ZBATIM

PROFILI GJATESOR

EMËRTIMI I FLETËS **AKSI 5**

SHKALLA **1:250**

NUMRI I FLETËS **T-59**

2024

AUTORITETI KONTRAKTOR:
BASHKIA TIRANË



BASHKIA
TIRANË

PROJEKTUESI: "MANTE KONSTRUKSION" SH.P.K. & "FOCUS ARCHITECTURE" SH.P.K.

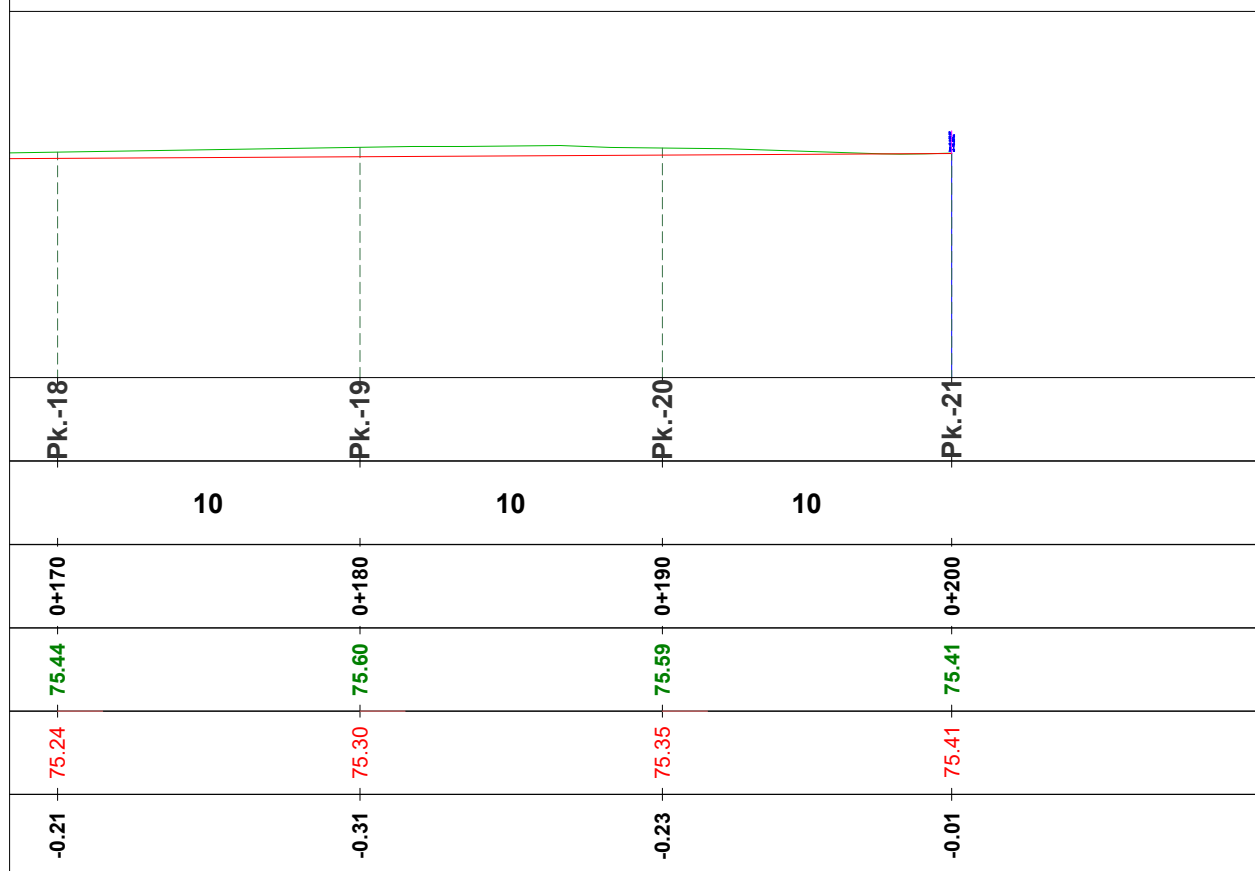

TITULLI I PROJEKTIT

“Rikualifikim Blloku qe Kufizohet nga Rruget "Haxhi Xhuzi" - "Reze Drite" - "Halil Hoxha”

FAZA

PROJEKT ZBATIM

SEKSIONET TERTHORE

EMËRTIMI I FLETËS **AKSI 5**

SHKALLA **1:100**

NUMRI I FLETËS **T-60**

2024

AUTORITETI KONTRAKTOR:
BASHKIA TIRANË



BASHKIA TIRANË

PROJEKTUESI: "MANTE KONSTRUKSION" SH.P.A. & "FOCUS ARCHITECTURE" SH.P.A.



Km.0+000.00 (Progresivi-1)

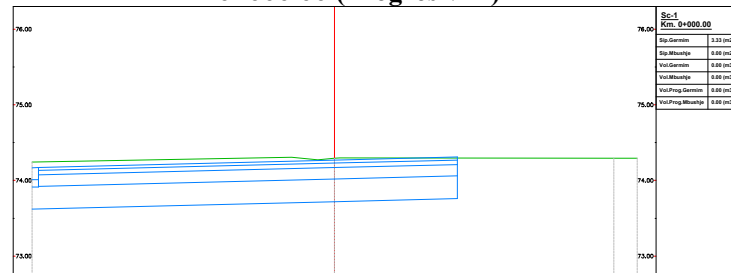

PROJEKTI TERRENI

Kuota		74.25	74.29	74.29	74.29
Prog.	-4.00		0.00	3.69	4.00
Kuota		74.17	74.27	74.31	
Prog.	-4.00	-3.92		1.63	

Km.0+020.00 (Progresivi-3)

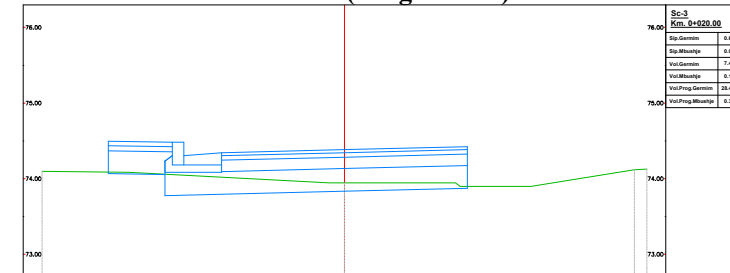

PROJEKTI TERRENI

Kuota		74.10	74.09	73.94	73.94	74.12	74.13
Prog.	-4.00		-2.85	0.00	1.47	3.83	4.00
Kuota		74.50	74.34	74.38	74.42		
Prog.		-3.13	-1.63	0.00	1.62		

Km.0+010.00 (Progresivi-2)

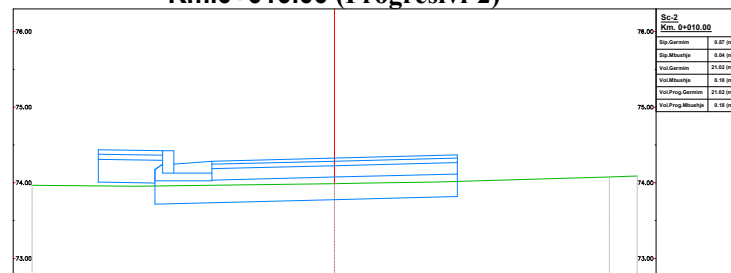

PROJEKTI TERRENI

Kuota		73.97	73.95	73.99	74.01	74.08	74.09
Prog.	-4.00		-2.64	0.00	1.32	3.63	4.00
Kuota		74.44	74.29	74.33	74.37		
Prog.		-3.13	-1.63	0.00	1.63		

Km.0+030.00 (Progresivi-4)

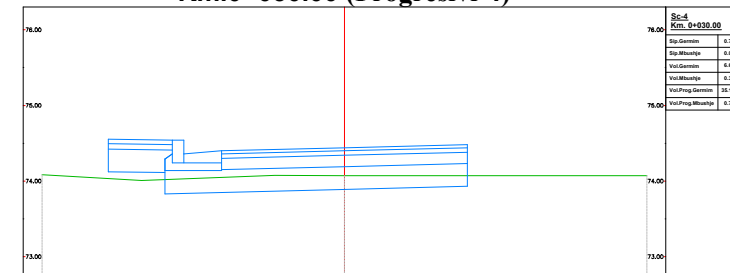

PROJEKTI TERRENI

Kuota		74.08	74.01	74.07	74.07	74.07	74.07
Prog.	-4.00		-2.68	0.00	1.51	4.00	
Kuota		74.55	74.40	74.44	74.48		
Prog.		-3.13	-1.63	0.00	1.63		

TITULLI I PROJEKTIT

“Rikualifikim Blloku qe Kufizohet nga Rruget "Haxhi Xhuzi" - "Reze Drite" - "Halil Hoxha”

FAZA

PROJEKT ZBATIM

SEKSIONET TERTHORE

EMËRTIMI I FLETËS **AKSI 5**

SHKALLA **1:100**

NUMRI I FLETËS **T-61**

2024

AUTORITETI KONTRAKTOR:
BASHKIA TIRANË



BASHKIA TIRANË

PROJEKTUESI: "MANTE KONSTRUKSION" SH.P.A. & "FOCUS ARCHITECTURE" SH.P.A.



Km.0+040.00 (Progresivi-5)

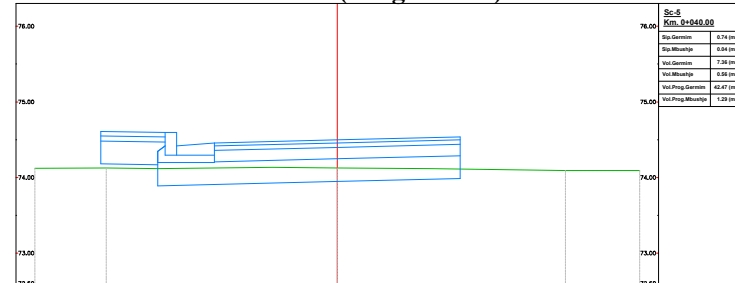

Sht. 6 Km. 0+040.00	
Sip. Gjerimesi	0.74 (m ²)
Sip. Mbrojtje	0.04 (m ²)
Vat. Gjerimesi	2.08 (m ²)
Vat. Mbrojtje	0.08 (m ²)
Vat. Prog. Gjerimesi	45.07 (m ²)
Vat. Prog. Mbrojtje	1.28 (m ²)

PROJEKTI TERRENI

Kuota	74.12					
Prog.	-4.00					
Kuota		74.61				
Prog.		-3.13				
Kuota			74.12			
Prog.			-2.37			
Kuota				74.13		
Prog.				0.00		
Kuota					74.12	
Prog.					-1.22	
Kuota						74.09
Prog.						-3.02
Kuota						74.09
Prog.						4.00

Km.0+060.00 (Progresivi-7)

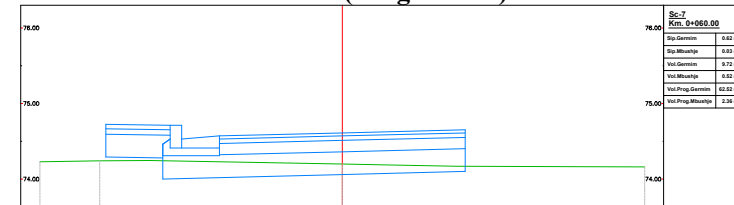

Sht. 7 Km. 0+060.00	
Sip. Gjerimesi	0.62 (m ²)
Sip. Mbrojtje	0.02 (m ²)
Vat. Gjerimesi	0.23 (m ²)
Vat. Mbrojtje	0.02 (m ²)
Vat. Prog. Gjerimesi	42.82 (m ²)
Vat. Prog. Mbrojtje	2.28 (m ²)

PROJEKTI TERRENI

Kuota	74.23					
Prog.	-4.00					
Kuota		74.17				
Prog.		-3.12				
Kuota			74.25			
Prog.			-2.55			
Kuota				74.20		
Prog.				0.00		
Kuota					74.17	
Prog.					-1.52	
Kuota						74.16
Prog.						4.00

Km.0+050.00 (Progresivi-6)

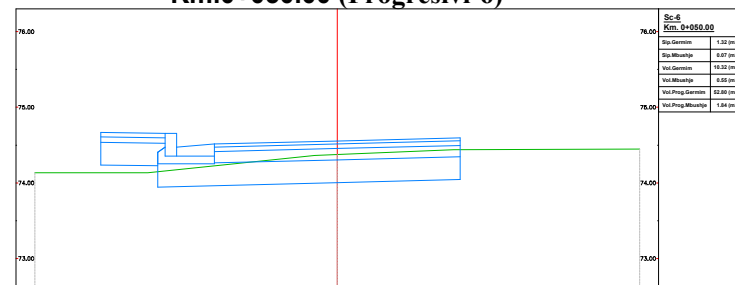

Sht. 6 Km. 0+050.00	
Sip. Gjerimesi	1.10 (m ²)
Sip. Mbrojtje	0.07 (m ²)
Vat. Gjerimesi	11.10 (m ²)
Vat. Mbrojtje	0.08 (m ²)
Vat. Prog. Gjerimesi	22.00 (m ²)
Vat. Prog. Mbrojtje	1.04 (m ²)

PROJEKTI TERRENI

Kuota	74.13					
Prog.	-4.00					
Kuota		74.67				
Prog.		-3.12				
Kuota			74.13			
Prog.			-2.50			
Kuota				74.38		
Prog.				0.00		
Kuota					74.44	
Prog.					-1.54	
Kuota						74.45
Prog.						4.00

Km.0+070.00 (Progresivi-8)

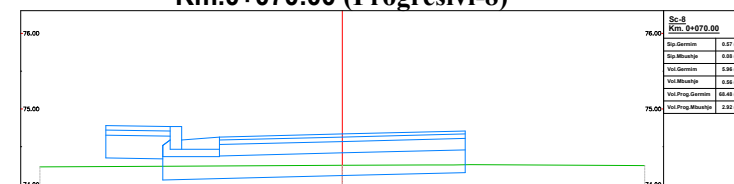

Sht. 8 Km. 0+070.00	
Sip. Gjerimesi	0.67 (m ²)
Sip. Mbrojtje	0.02 (m ²)
Vat. Gjerimesi	0.00 (m ²)
Vat. Mbrojtje	0.00 (m ²)
Vat. Prog. Gjerimesi	40.00 (m ²)
Vat. Prog. Mbrojtje	0.00 (m ²)

PROJEKTI TERRENI

Kuota	74.23					
Prog.	-4.00					
Kuota		74.78				
Prog.		-3.12				
Kuota			74.24			
Prog.			-2.26			
Kuota				74.25		
Prog.				0.00		
Kuota					74.26	
Prog.					-1.11	
Kuota						74.25
Prog.						4.00

TITULLI I PROJEKTIT

“Rikualifikim Blloku qe Kufizohet nga Rruget "Haxhi Xhuzi" - "Reze Drite" - "Halil Hoxha”

FAZA

PROJEKT ZBATIM

SEKSIONET TERTHORE

EMËRTIMI I FLETËS AKSI 5

SHKALLA 1:100

NUMRI I FLETËS T-62

2024

AUTORITETI KONTRAKTOR:
BASHKIA TIRANË



BASHKIA
TIRANË

PROJEKTUESI: "MANTE KONSTRUKSION" SH.P.K. & "FOCUS ARCHITECTURE" SH.P.K.



Km.0+080.00 (Progresivi-9)

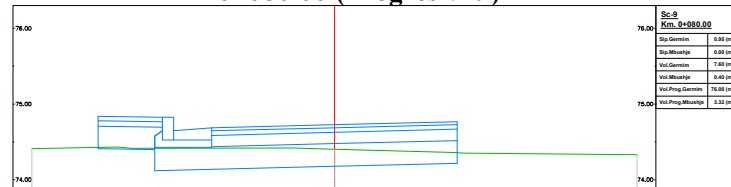

St-9	Km. 0+080.00
Sp.Garimit	0.95 (m)
Sp.Mbrojtje	0.00 (m)
Vid.Garimit	7.80 (m)
Vid.Mbrojtje	0.40 (m)
Vid.Prog.Garimit	70.00 (m)
Vid.Prog.Mbrojtje	3.30 (m)

PROJEKTI TERRENI

Kuota	74.41	74.41	74.40	74.36	74.33
Prog.	-4.00	-2.68	0.00	1.57	4.00
Kuota		74.84	74.69	74.73	74.77
Prog.		-3.12	-1.62	0.00	1.62

Km.0+100.00 (Progresivi-11)

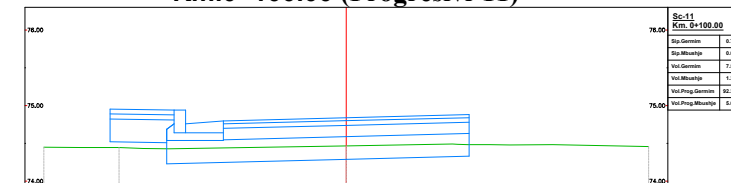

St-11	Km. 0+100.00
Sp.Garimit	0.70 (m)
Sp.Mbrojtje	0.00 (m)
Vid.Garimit	7.00 (m)
Vid.Mbrojtje	1.00 (m)
Vid.Prog.Garimit	60.00 (m)
Vid.Prog.Mbrojtje	0.00 (m)

PROJEKTI TERRENI

Kuota	74.45	74.45	74.43	74.47	74.49	74.48	74.46
Prog.	-4.00	-3.51	-2.35	0.00	1.40	2.73	4.00
Kuota		74.95	74.80	74.84	74.88		
Prog.		-3.13	-1.63	0.00	1.63		

Km.0+090.00 (Progresivi-10)

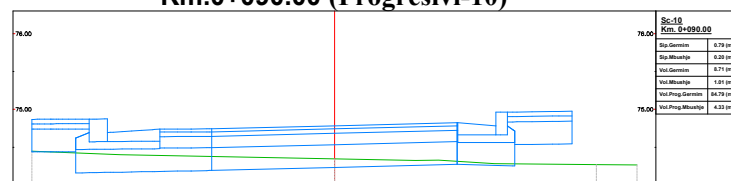

St-10	Km. 0+090.00
Sp.Garimit	0.70 (m)
Sp.Mbrojtje	0.00 (m)
Vid.Garimit	8.70 (m)
Vid.Mbrojtje	0.00 (m)
Vid.Prog.Garimit	60.00 (m)
Vid.Prog.Mbrojtje	4.00 (m)

PROJEKTI TERRENI

Kuota	74.45	74.40	74.34	74.32	74.28	74.27	74.27
Prog.	-4.00	-2.83	0.00	1.07	2.12	3.47	4.00
Kuota	74.87	74.87	74.72	74.74	74.82	74.97	74.97
Prog.	-4.00	-3.65	-2.63	-1.63	0.00	1.62	2.74
							3.14

Km.0+110.00 (Progresivi-12)

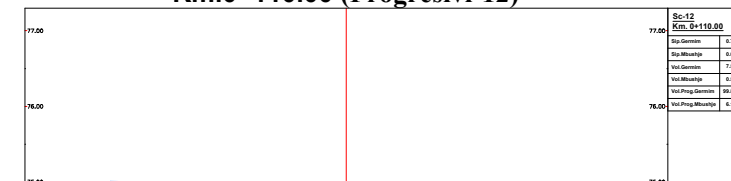

St-12	Km. 0+110.00
Sp.Garimit	0.70 (m)
Sp.Mbrojtje	0.00 (m)
Vid.Garimit	7.00 (m)
Vid.Mbrojtje	0.00 (m)
Vid.Prog.Garimit	60.00 (m)
Vid.Prog.Mbrojtje	0.00 (m)

PROJEKTI TERRENI

Kuota	74.49	74.52	74.54	74.55	74.49	74.48
Prog.	-4.00	-2.62	0.00	1.54	3.47	4.00
Kuota		75.01	74.86	74.90	74.94	
Prog.		-3.13	-1.63	0.00	1.63	

TITULLI I PROJEKTIT

“Rikualifikim Blloku qe Kufizohet nga Rruget "Haxhi Xhuzi" - "Reze Drite" - "Halil Hoxha”

FAZA

PROJEKT ZBATIM

SEKSIONET TERTHORE

EMËRTIMI I FLETËS **AKSI 5**

SHKALLA **1:100**

NUMRI I FLETËS **T-63**

2024

AUTORITETI KONTRAKTOR:
BASHKIA TIRANË



BASHKIA
TIRANË

PROJEKTUESI: "VANITE KONSTRUKSION" SH.P.K. & "FOCUS ARCHITECTURE" SH.P.K.

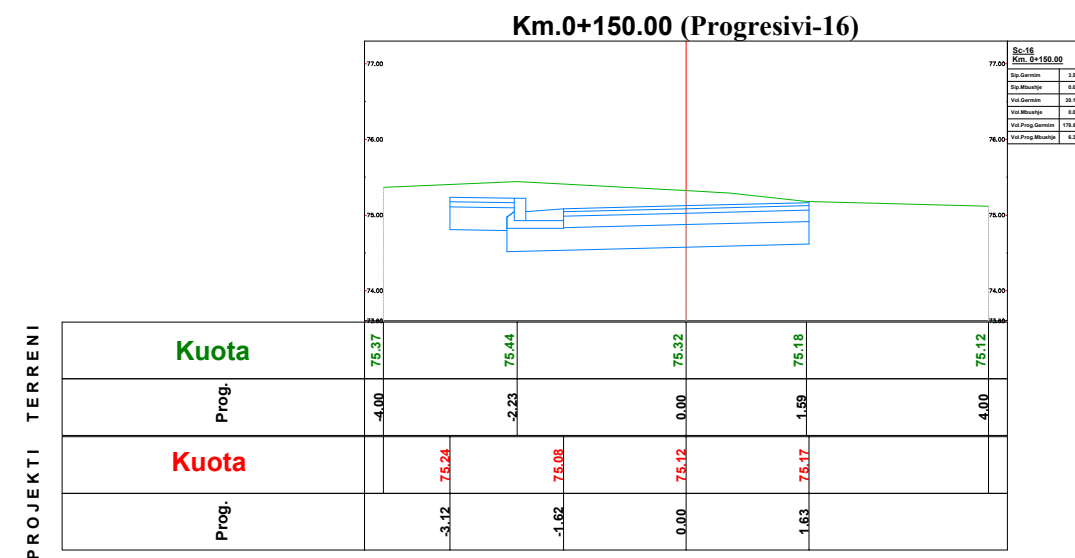
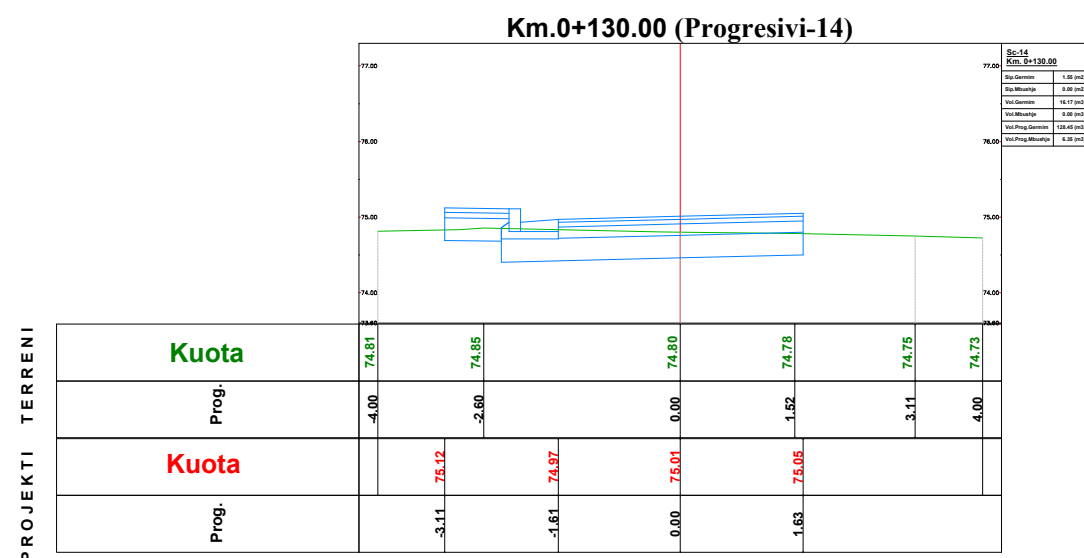
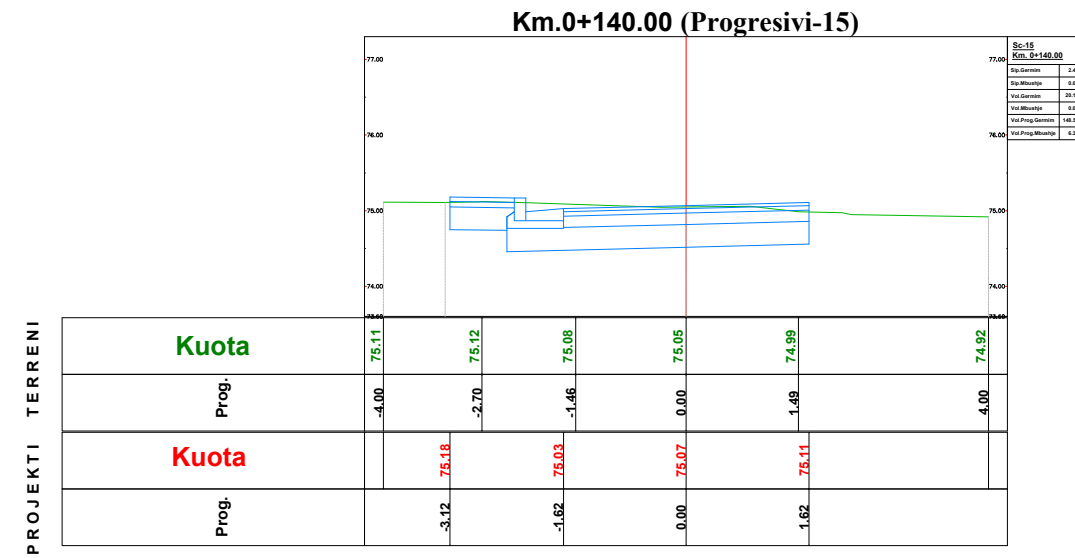
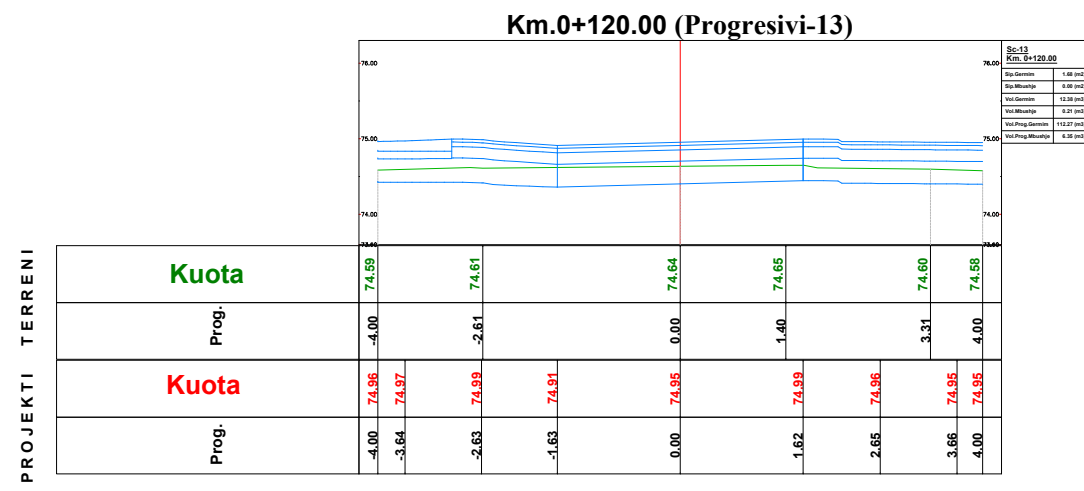

PROJEKTI TERRENI

PROJEKTI TERRENI

PROJEKTI TERRENI

PROJEKTI TERRENI

Km.0+199.57 (Progresivi-21)

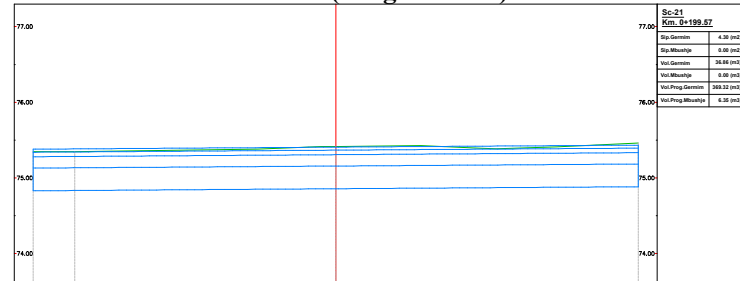

PROJEKTI TERRENI	Kuota	
	Proj.	Kuota
	-4.00	75.38
	-3.07	75.38
	-2.07	75.39
	-1.06	75.40
	0.00	75.41
	1.04	75.41
	2.04	75.42
	3.04	75.43
	4.00	75.43

TITULLI I PROJEKTIT

“Rikualifikim Blloku qe Kufizohet nga Rruget "Haxhi Xhuzi" - "Reze Drite" - "Halil Hoxha”

FAZA

PROJEKT ZBATIM

SEKSIONET TERTHORE

EMËRTIMI I FLETËS **AKSI 5**

SHKALLA **1:100**

NUMRI I FLETËS **T-65**

2024

AUTORITETI KONTRAKTOR:
BASHKIA TIRANË



PROJEKTUESI: "MANTE KONSTRUKSION" SH.P.K. & "FOCUS ARCHITECTURE" SH.P.K.



Tabela Volumeve

Progresivi	Sip.Mbushje	Sip.Germim	Vol.Mbushje	Vol.Germim	Vol.Prog.Mbush	Vol.Prog.Germim
0+000.00	0.00	3.33	0.00	0.00	0.00	0.00
0+010.00	0.04	0.87	0.18	21.02	0.18	21.02
0+020.00	0.00	0.61	0.18	7.40	0.36	28.43
0+030.00	0.07	0.73	0.37	6.69	0.73	35.11
0+040.00	0.04	0.74	0.56	7.36	1.29	42.47
0+050.00	0.07	1.32	0.55	10.32	1.84	52.80
0+060.00	0.03	0.62	0.52	9.72	2.36	62.52
0+070.00	0.08	0.57	0.56	5.96	2.92	68.48
0+080.00	0.00	0.95	0.40	7.60	3.32	76.08
0+090.00	0.20	0.79	1.01	8.71	4.33	84.79
0+100.00	0.06	0.72	1.30	7.55	5.63	92.34
0+110.00	0.04	0.79	0.51	7.56	6.14	99.89
0+120.00	0.00	1.68	0.21	12.38	6.35	112.27
0+130.00	0.00	1.55	0.00	16.17	6.35	128.45
0+140.00	0.00	2.48	0.00	20.14	6.35	148.59
0+150.00	0.00	3.54	0.00	30.10	6.35	178.69
0+160.00	0.00	4.37	0.00	39.52	6.35	218.21
0+170.00	0.00	3.51	0.00	39.38	6.35	257.59
0+180.00	0.00	4.03	0.00	37.70	6.35	295.29
0+190.00	0.00	3.40	0.00	37.18	6.35	332.47
0+199.57	0.00	4.30	0.00	36.86	6.35	369.32

TITULLI I PROJEKTIT

“Rikualifikim Blloku qe Kufizohet nga Rruget "Haxhi Xhuzi" - "Reze Drite" - "Halil Hoxha”

FAZA

PROJEKT ZBATIM

TABELA E VOLUMEVE

EMËRTIMI I FLETËS **AKSI 5**

SHKALLA

NUMRI I FLETËS **T-66**

2024

AUTORITETI KONTRAKTOR:
BASHKIA TIRANË



BASHKIA
TIRANË

PROJEKTUESI: "MANTE KONSTRUKSION" SH.P.K. & "FOCUS ARCHITECTURE" SH.P.K.



TITULLI I PROJEKTIT

“Rikualifikim Blloku qe Kufizohet nga Rruget "Haxhi Xhuzi" - "Reze Drite" - "Halil Hoxha”

FAZA

PROJEKT ZBATIM

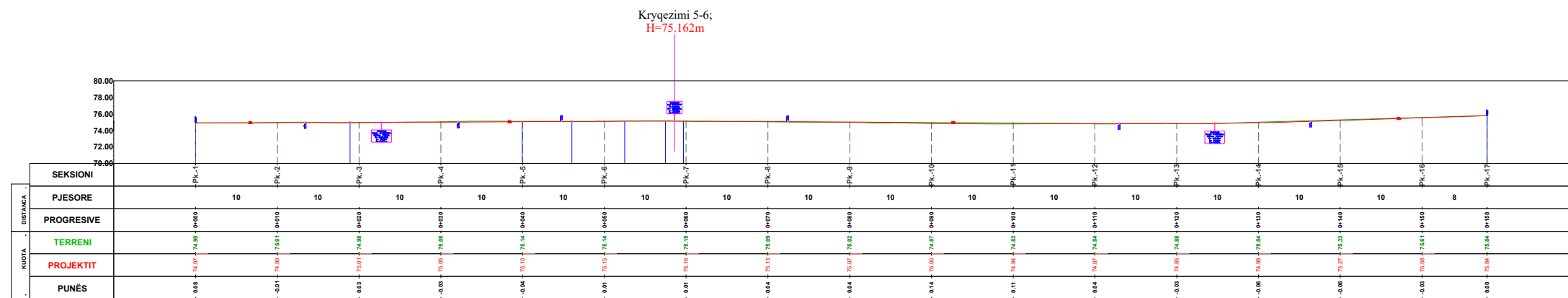

PROFILI GJATESOR

EMËRTIMI I FLETËS **AKSI 6**

SHKALLA

NUMRI I FLETËS **T-67**

2024

AUTORITETI KONTRAKTOR:
BASHKIA TIRANË



PROJEKTUESI: "MANTE KONSTRUKSION" SH.P.A. & "FOCUS ARCHITECTURE" SH.P.A.



TITULLI I PROJEKTIT

“Rikualifikim Blloku qe Kufizohet nga Rruget "Haxhi Xhuzi" - "Rezet Drite" - "Halil Hoxha”

FAZA

PROJEKT ZBATIM

K

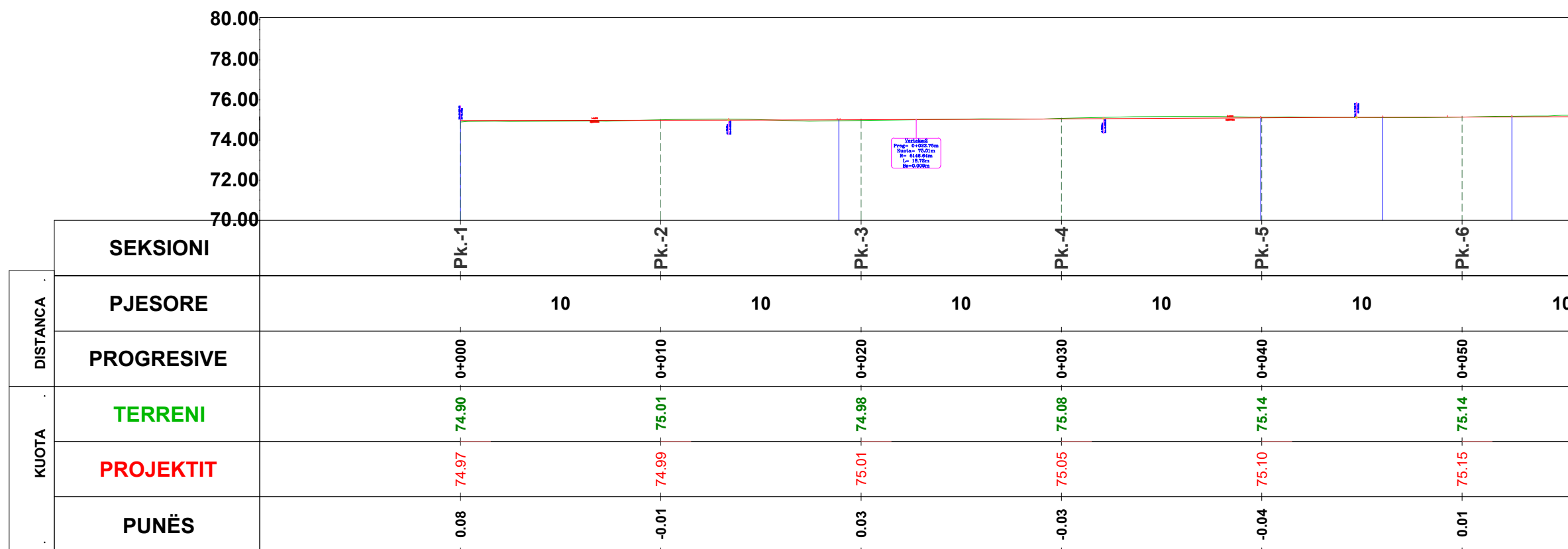

PROFILI GJATESOR

EMËRTIMI I FLETËS AKSI 6

SHKALLA 1:250

NUMRI I FLETËS T-68

2024

AUTORITETI KONTRAKTOR:
BASHKIA TIRANË



PROJEKTUESI: "MANTE KONSTRUKSION" SH.P.K. & "FOCUS ARCHITECTURE" SH.P.K.



TITULLI I PROJEKTIT

“Rikualifikim Blloku qe Kufizohet nga Rruget "Haxhi Xhuzi" - "Reze Drite" - "Halil Hoxha”

FAZA

PROJEKT ZBATIM

PROFILI GJATESOR

EMËRTIMI I FLETËS AKSI 6

SHKALLA 1:250

NUMRI I FLETËS T-69

2024

AUTORITETI KONTRAKTOR:
BASHKIA TIRANË



PROJEKTUESI: "MANTE KONSTRUKSION" SH.P.A. & "FOCUS ARCHITECTURE" SH.P.A.



Kryqezimi 5-6;
H=75.162m

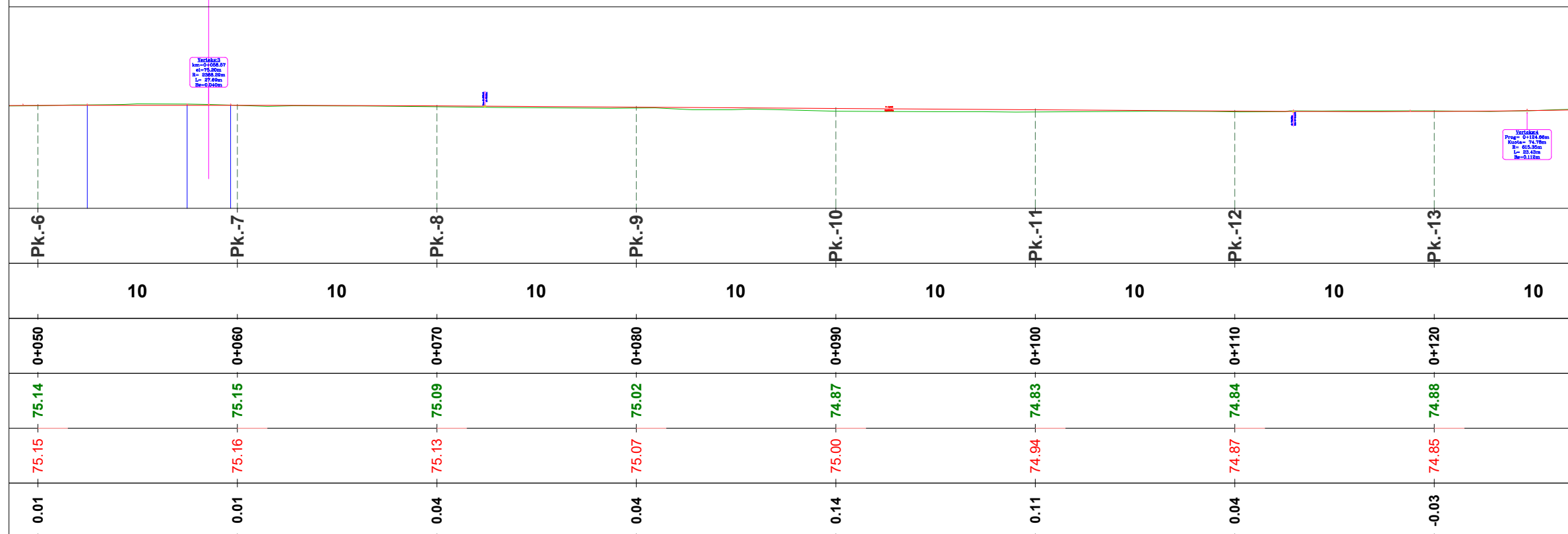

Viridhësi
Prog= 0+100.00m
K= -0.800m
L= 27.00m
H= 75.000m

Viridhësi
Prog= 0+120.00m
K= 0.000m
L= 0.00m
H= 74.880m

TITULLI I PROJEKTIT

“Rikualifikim Blloku qe Kufizohet nga Rruget "Haxhi Xhuzi" - "Reze Drite" - "Halil Hoxha”

FAZA

PROJEKT ZBATIM

PROFILI GJATESOR

EMËRTIMI I FLETËS **AKSI 6**

SHKALLA **1:250**

NUMRI I FLETËS **T-70**

2024

AUTORITETI KONTRAKTOR:
BASHKIA TIRANË



PROJEKTUESI: "MANTE KONSTRUKSION" SH.P.K. & "FOCUS ARCHITECTURE" SH.P.K.

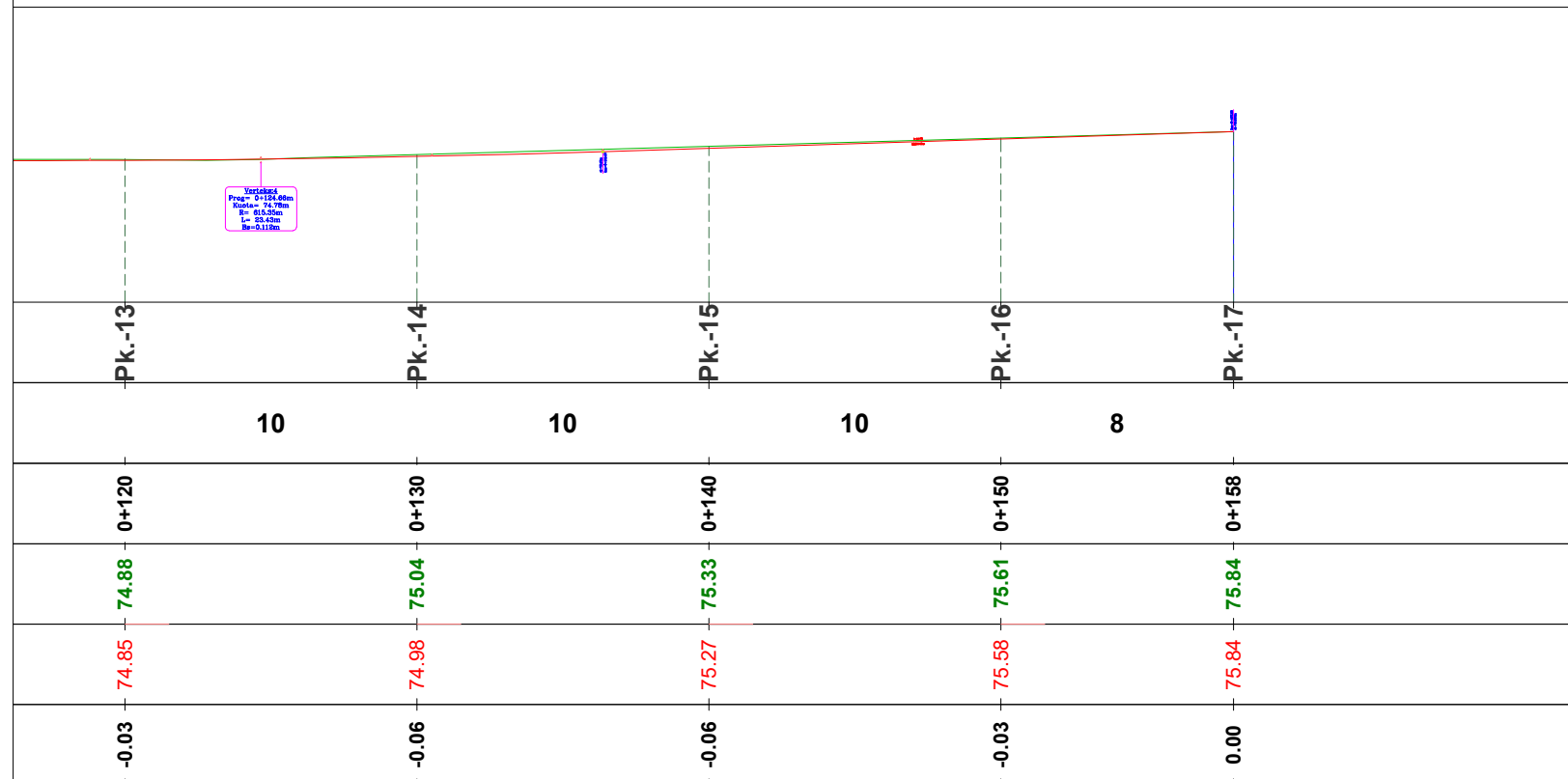

Vertical
Prog= 0+124.00m
Distanc= 24.70m
B= 0.520m
L= 24.43m
W=0.110m

TITULLI I PROJEKTIT

“Rikualifikim Blloku qe Kufizohet nga Rruget "Haxhi Xhuzi" - "Reze Drite" - "Halil Hoxha”

FAZA

PROJEKT ZBATIM

SEKSIONET TERTHORE

EMËRTIMI I FLETËS AKSI 6

SHKALLA 1:100

NUMRI I FLETËS T-71

2024

AUTORITETI KONTRAKTOR:
BASHKIA TIRANË



PROJEKTUESI: "VANTE KONSTRUKSION" SH.P.K. & "FOCUS ARCHITECTURE" SH.P.K.



Km.0+000.00 (Progresivi-1)

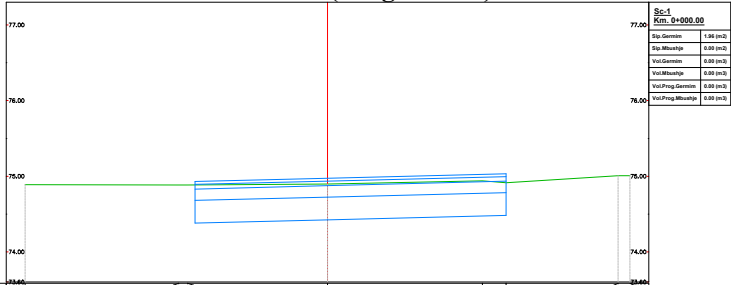

Sc1 Km. 0+000.00	
Sp. Derrim	1.00 (m)
Sp. Mbrojtje	0.00 (m)
Vat. Derrim	0.00 (m)
Vat. Mbrojtje	0.00 (m)
Vat. Prog. Derrim	0.00 (m)
Vat. Prog. Mbrojtje	0.00 (m)

PROJEKTI TERRENI	Kuota	74.99	74.89	74.90	74.94	75.01
	Prog.	-4.00	-1.97	0.00	2.05	3.84
PROJEKTI TERRENI	Kuota		74.93	74.97	75.03	75.01
	Prog.		-1.75	0.00	2.36	4.00

Km.0+020.00 (Progresivi-3)

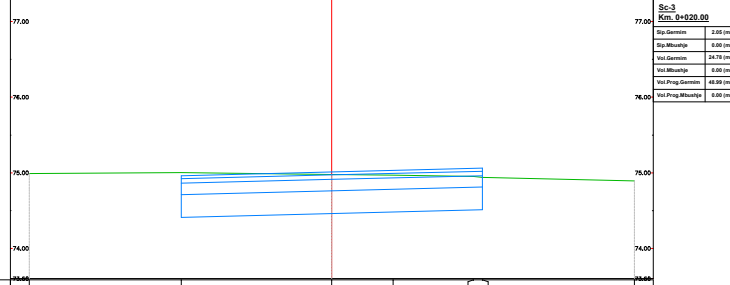

Sc3 Km. 0+020.00	
Sp. Derrim	2.00 (m)
Sp. Mbrojtje	0.00 (m)
Vat. Derrim	24.70 (m)
Vat. Mbrojtje	0.00 (m)
Vat. Prog. Derrim	0.00 (m)
Vat. Prog. Mbrojtje	0.00 (m)

PROJEKTI TERRENI	Kuota	74.99	75.00	74.98	74.97	74.95	74.94	74.89
	Prog.	-4.00	-1.99	0.00	0.81	1.87	1.89	4.00
PROJEKTI TERRENI	Kuota		74.96	75.01		74.95	74.94	
	Prog.		-1.99	0.00		1.99	1.89	

Km.0+010.00 (Progresivi-2)

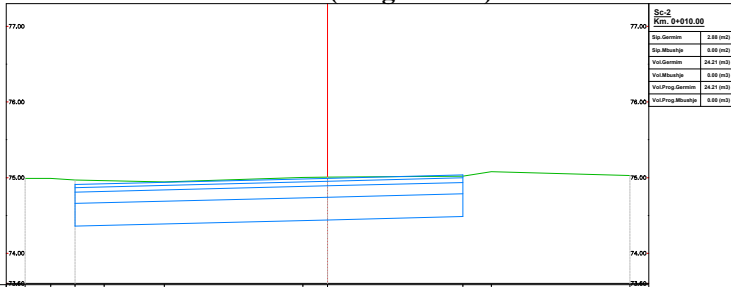

Sc2 Km. 0+010.00	
Sp. Derrim	1.00 (m)
Sp. Mbrojtje	0.00 (m)
Vat. Derrim	24.21 (m)
Vat. Mbrojtje	0.00 (m)
Vat. Prog. Derrim	24.37 (m)
Vat. Prog. Mbrojtje	0.00 (m)

PROJEKTI TERRENI	Kuota	74.99	74.99	74.97	74.96	74.94	75.00	75.01	75.02	75.08	75.03
	Prog.	-4.00	-3.66	-3.34	-2.95	-2.16	-0.32	0.00	1.79	2.17	4.00
PROJEKTI TERRENI	Kuota		74.91				74.99		75.04		
	Prog.		-3.34				0.00		1.79		

Km.0+030.00 (Progresivi-4)

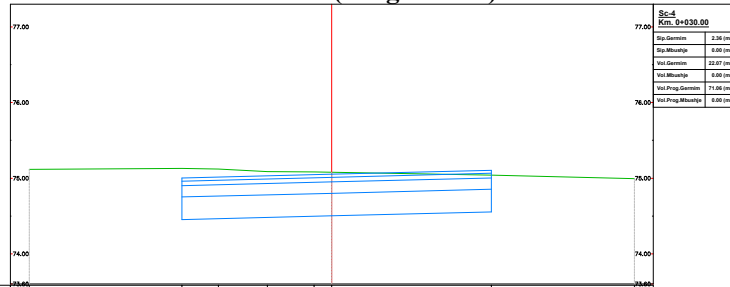

Sc4 Km. 0+030.00	
Sp. Derrim	2.00 (m)
Sp. Mbrojtje	0.00 (m)
Vat. Derrim	22.07 (m)
Vat. Mbrojtje	0.00 (m)
Vat. Prog. Derrim	21.08 (m)
Vat. Prog. Mbrojtje	0.00 (m)

PROJEKTI TERRENI	Kuota	75.12	75.13	75.12	75.09	75.08	75.08	75.04	74.99
	Prog.	-4.00	-1.98	-1.50	-0.85	-0.23	0.00	2.11	4.00
PROJEKTI TERRENI	Kuota		75.00			75.08		75.10	
	Prog.		-1.98			0.00		2.11	

PROJEKTI TERRENI

Km.0+040.00 (Progresivi-5)

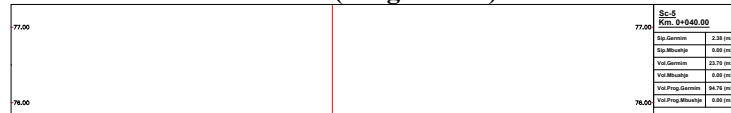

Kuota	75.22	75.19	75.17	75.14	75.11	75.09
Prog.	-4.00	-2.64	-2.02	0.00	-1.96	-4.00
Kuota			75.05	75.10	75.15	
Prog.			-2.02	0.00	2.02	

Sic-5 Km. 0+040.00	
Tipi Gjerme	2.30 (m/s)
Tipi Mbrojtje	0.00 (m/s)
Tipi Gjerme	22.70 (m/s)
Tipi Mbrojtje	0.00 (m/s)
Vali Prog Gjerme	84.76 (m/s)
Vali Prog Mbrojtje	0.00 (m/s)

PROJEKTI TERRENI

Km.0+060.00 (Progresivi-7)

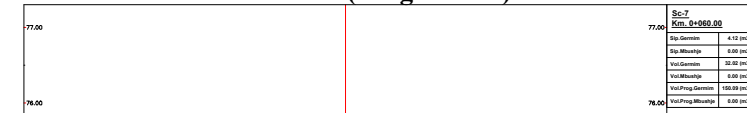

Kuota	75.22	75.17	75.15	75.15	75.15	75.21
Prog.	-4.00	-3.27	-1.70	0.00	1.71	-4.00
Kuota	75.22	75.21	75.21	75.20	75.19	75.18
Prog.	-4.00	-3.07	-2.06	-1.01	0.00	1.01
						2.04
						3.07
						4.00

Sic-7 Km. 0+060.00	
Tipi Gjerme	4.12 (m/s)
Tipi Mbrojtje	0.00 (m/s)
Tipi Gjerme	22.80 (m/s)
Tipi Mbrojtje	0.00 (m/s)
Vali Prog Gjerme	100.00 (m/s)
Vali Prog Mbrojtje	0.00 (m/s)

PROJEKTI TERRENI

Km.0+050.00 (Progresivi-6)

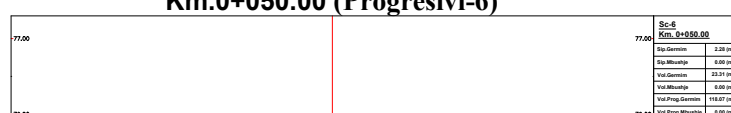

Kuota	75.20	75.16	75.16	75.14	75.12	75.10
Prog.	-4.00	-2.64	-2.23	0.00	1.94	-4.00
Kuota			75.09	75.15	75.20	
Prog.			-2.26	0.00	1.94	
						2.11
						75.13

Sic-6 Km. 0+050.00	
Tipi Gjerme	2.20 (m/s)
Tipi Mbrojtje	0.00 (m/s)
Tipi Gjerme	22.31 (m/s)
Tipi Mbrojtje	0.00 (m/s)
Vali Prog Gjerme	110.07 (m/s)
Vali Prog Mbrojtje	0.00 (m/s)

PROJEKTI TERRENI

Km.0+070.00 (Progresivi-8)

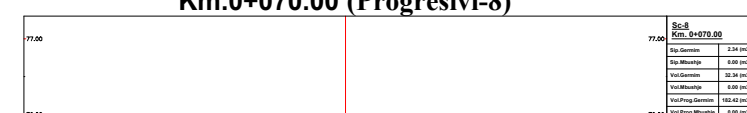

Kuota	75.17	75.13	75.09	75.07	75.06	75.03
Prog.	-4.00	-2.35	0.00	1.06	1.79	-4.00
Kuota		75.24	75.23	75.03	75.17	
Prog.		-3.12	-2.27	-1.62	0.00	1.63
						3.42
						75.02

Sic-8 Km. 0+070.00	
Tipi Gjerme	1.14 (m/s)
Tipi Mbrojtje	0.00 (m/s)
Tipi Gjerme	22.34 (m/s)
Tipi Mbrojtje	0.00 (m/s)
Vali Prog Gjerme	100.42 (m/s)
Vali Prog Mbrojtje	0.00 (m/s)

TITULLI I PROJEKTIT

“Rikualifikim Blloku qe Kufizohet nga Rruget "Haxhi Xhuzi" - "Reze Drite" - "Halil Hoxha”

FAZA

PROJEKT ZBATIM

SEKSIONET TERTHORE

EMËRTIMI I FLETËS **AKSI 6**

SHKALLA **1:100**

NUMRI I FLETËS **T-72**

2024

AUTORITETI KONTRAKTOR:
BASHKIA TIRANË



PROJKTUESI: "VAANTE KONSTRUKSION" SH.P.A. & "FOCUS ARCHITECTURE" SH.P.A.



TITULLI I PROJEKTIT

“Rikualifikim Blloku qe Kufizohet nga Rruget "Haxhi Xhuzi" - "Reze Drite" - "Halil Hoxha”

FAZA

PROJEKT ZBATIM

SEKSIONET TERTHORE

EMËRTIMI I FLETËS **AKSI 6**

SHKALLA **1:100**

NUMRI I FLETËS **T-74**

2024

AUTORITETI KONTRAKTOR:
BASHKIA TIRANË



BASHKIA TIRANË

PROJEKTUESI: "MANTE KONSTRUKSION" SH.P.A. & "FOCUS ARCHITECTURE" SH.P.A.



Km.0+140.00 (Progresivi-15)

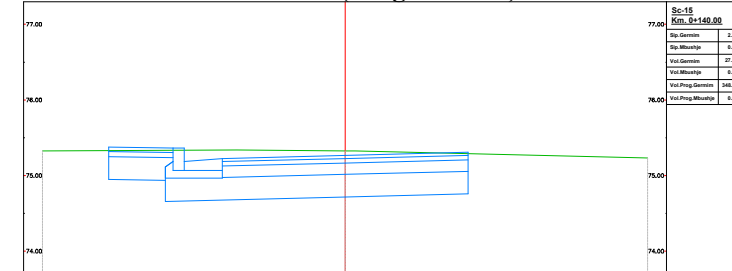

PROJEKTI TERRENI	Kuota	75.33	75.33	75.34	75.33	75.33	75.23
	Prog.	-4.00	-4.00	-1.43	0.00	0.00	4.00
PROJEKTI TERRENI	Kuota	75.38	75.37	75.23	75.27	75.31	
	Prog.	-3.12	-2.27	-1.62	0.00	1.62	

Km.0+120.00 (Progresivi-13)

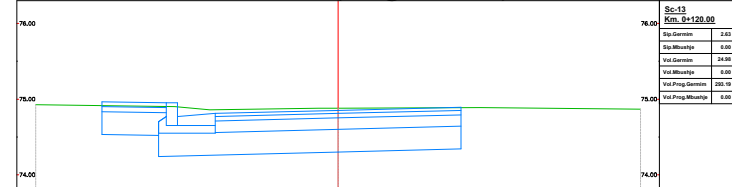

PROJEKTI TERRENI	Kuota	74.93	74.90	74.86	74.88	74.89	74.87
	Prog.	-4.00	-2.16	-1.70	-0.26	1.88	4.00
PROJEKTI TERRENI	Kuota	74.96	74.95	74.81	74.85	74.89	
	Prog.	-3.12	-2.27	-1.62	0.00	1.63	

Km.0+150.00 (Progresivi-16)

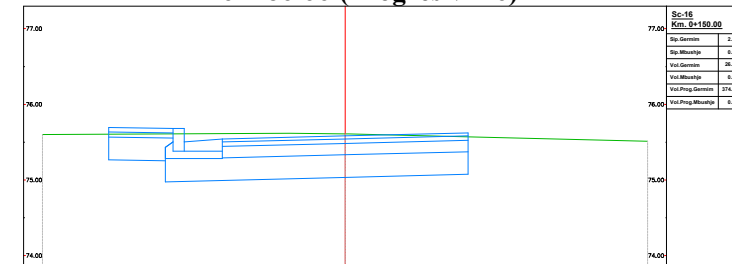

PROJEKTI TERRENI	Kuota	75.60	75.62	75.61	75.51	
	Prog.	-4.00	-0.73	0.00	4.00	
PROJEKTI TERRENI	Kuota	75.70	75.68	75.64	75.62	
	Prog.	-3.12	-2.27	-1.62	0.00	1.62

Km.0+130.00 (Progresivi-14)

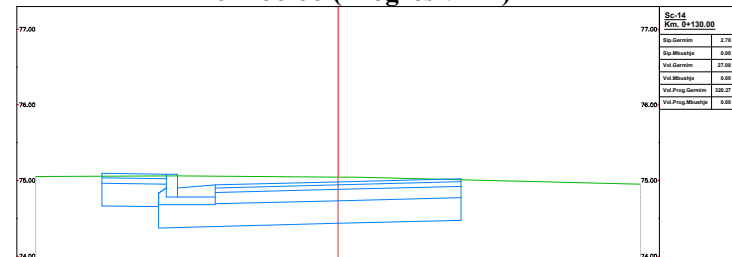

PROJEKTI TERRENI	Kuota	75.05	75.04	75.04	74.95	
	Prog.	-4.00	0.00	0.23	4.00	
PROJEKTI TERRENI	Kuota	75.09	75.08	74.94	75.02	
	Prog.	-3.12	-2.27	-1.62	1.63	

PROJEKTI TERRENI

Km.0+157.96 (Progresivi-17)

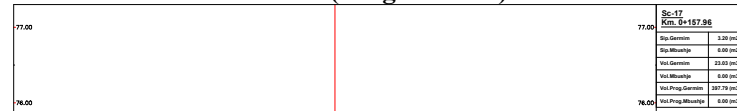

Kuota	75.82	75.84	75.84	75.74
Prog.	-4.00	-0.18	0.00	4.00
Kuota	75.74	75.84	75.88	
Prog.	-4.00	0.00	1.63	

TITULLI I PROJEKTIT

“Rikualifikim Blloku qe Kufizohet nga Rruget "Haxhi Xhuzi" - "Reze Drite" - "Halil Hoxha”

FAZA

PROJEKT ZBATIM

SEKSIONET TERTHORE

EMËRTIMI I FLETËS **AKSI 6**

SHKALLA **1:100**

NUMRI I FLETËS **T-75**

2024

AUTORITETI KONTRAKTOR:
BASHKIA TIRANË



PROJEKTUESI: "MANTE KONSTRUKSION" SH.P.K. & "FOCUS ARCHITECTURE" SH.P.K.



TITULLI I PROJEKTIT

“Rikualifikim Blloku qe Kufizohet nga Rruget "Haxhi Xhuzi" - "Reze Drite" - "Halil Hoxha”

FAZA

PROJEKT ZBATIM

Tabela Volumeve

Progresivi	Sip.Mbushje	Sip.Germim	Vol.Mbushje	Vol.Germim	Vol.Prog.Mbush	Vol.Prog.Germim
0+000.00	0.00	1.96	0.00	0.00	0.00	0.00
0+010.00	0.00	2.88	0.00	24.21	0.00	24.21
0+020.00	0.00	2.05	0.00	24.78	0.00	48.99
0+030.00	0.00	2.36	0.00	22.07	0.00	71.06
0+040.00	0.00	2.38	0.00	23.70	0.00	94.76
0+050.00	0.00	2.28	0.00	23.31	0.00	118.07
0+060.00	0.00	4.12	0.00	32.02	0.00	150.09
0+070.00	0.00	2.34	0.00	32.34	0.00	182.42
0+080.00	0.00	2.40	0.00	23.71	0.00	206.14
0+090.00	0.00	1.88	0.00	21.38	0.00	227.52
0+100.00	0.00	1.95	0.00	19.12	0.00	246.64
0+110.00	0.00	2.36	0.00	21.56	0.00	268.21
0+120.00	0.00	2.63	0.00	24.98	0.00	293.19
0+130.00	0.00	2.78	0.00	27.08	0.00	320.27
0+140.00	0.00	2.77	0.00	27.74	0.00	348.02
0+150.00	0.00	2.58	0.00	26.74	0.00	374.76
0+157.96	0.00	3.20	0.00	23.03	0.00	397.79

TABELA E VOLUMEVE

EMËRTIMI I FLETËS **AKSI 6**

SHKALLA

NUMRI I FLETËS **T-76**

2024

AUTORITETI KONTRAKTOR:
BASHKIA TIRANË



BASHKIA
TIRANË

PROJEKTUESI: "MANTE KONSTRUKSION" SH.P.A. & "FOCUS ARCHITECTURE" SH.P.A.



TITULLI I PROJEKTIT

“Rikualifikim Blloku qe Kufizohet nga Rruget "Haxhi Xhuzi" - "Reze Drite" - "Halil Hoxha”

FAZA

PROJEKT ZBATIM

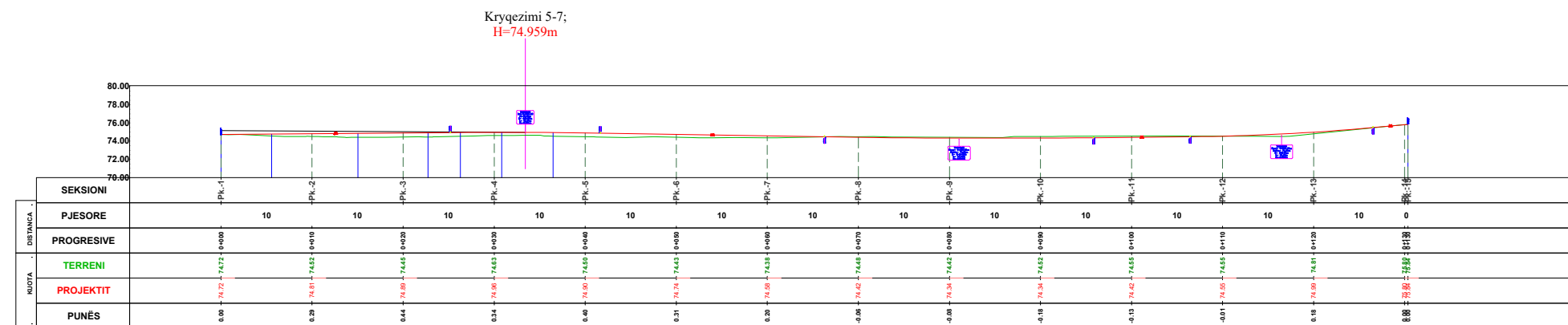

PROFILI GJATESOR

EMËRTIMI I FLETËS AKSI 7

SHKALLA

NUMRI I FLETËS T-77

2024

AUTORITETI KONTRAKTOR:
BASHKIA TIRANË



PROJEKTUESI: "VAANTE KONSTRUKSION" SH.P.K. & "FOCUS ARCHITECTURE" SH.P.K.



TITULLI I PROJEKTIT

“Rikualifikim Blloku qe Kufizohet nga Rruget "Haxhi Xhuzi" - "Reze Drite" - "Halil Hoxha”

FAZA

PROJEKT ZBATIM

Kryqezimi 5-7;
H=74.959m

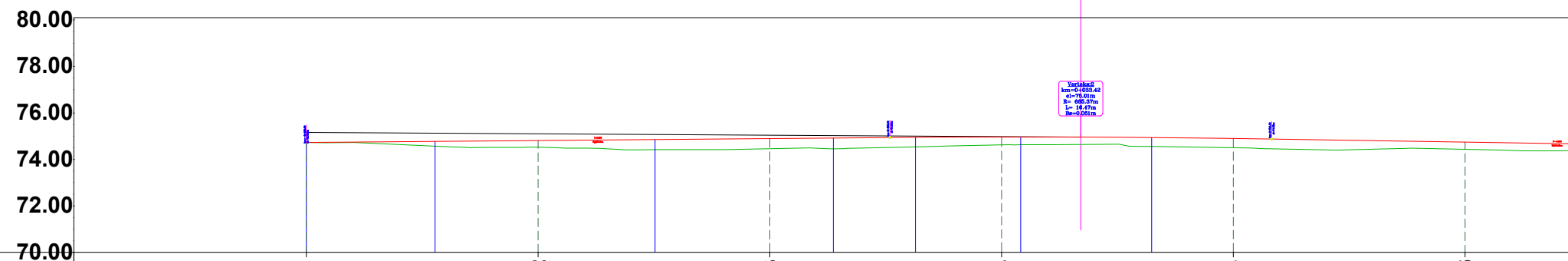

DISTANCA	SEKSIONI	Pk.-1	Pk.-2	Pk.-3	Pk.-4	Pk.-5	Pk.-6
	PJESORE		10	10	10	10	10
PROGRESIVE		0+000	0+010	0+020	0+030	0+040	0+050
KUOTA	TERRENI	74.72	74.52	74.45	74.63	74.50	74.43
	PROJEKTIT	74.72	74.81	74.89	74.96	74.90	74.74
	PUNËS	0.00	0.29	0.44	0.34	0.40	0.31

PROFILI GJATESOR

EMËRTIMI I FLETËS **AKSI 7**

SHKALLA **1:250**

NUMRI I FLETËS **T-78**

2024

AUTORITETI KONTRAKTOR:
BASHKIA TIRANË



PROJEKTUESI: "MANTE KONSTRUKSION" SH.P.K. & "FOCUS ARCHITECTURE" SH.P.K.



TITULLI I PROJEKTIT

“Rikualifikim Blloku qe Kufizohet nga Rruget "Haxhi Xhuzi" - "Reze Drite" - "Halil Hoxha”

FAZA

PROJEKT ZBATIM

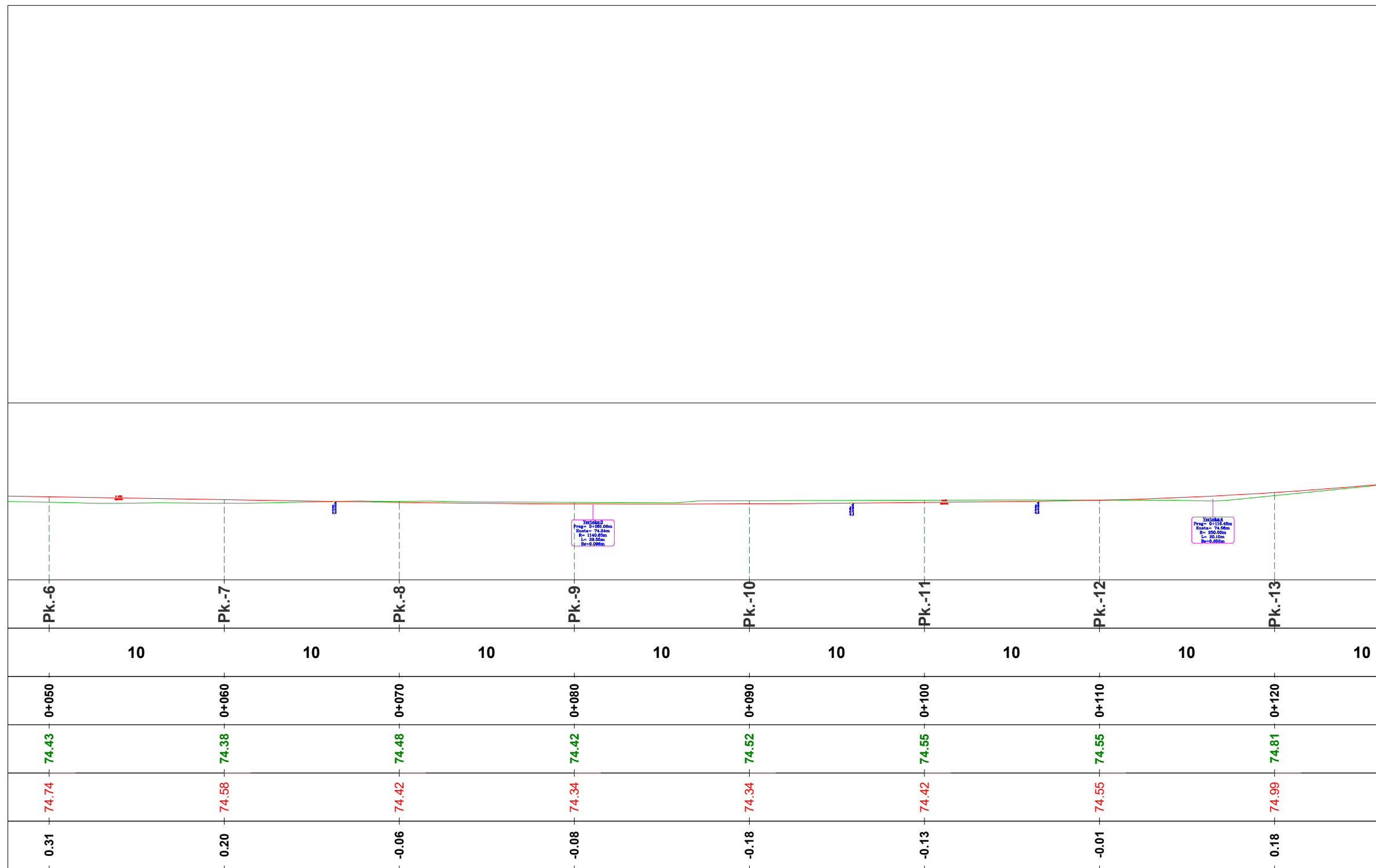

PROFILI GJATESOR

EMERTIMI I FLETËS **AKSI 7**

SHKALLA **1:250**

NUMRI I FLETËS **T-79**

2024

AUTORITETI KONTRAKTOR:
BASHKIA TIRANË



PROJEKTUESI: "MANTE KONSTRUKSION" SH.P.A. & "FOCUS ARCHITECTURE" SH.P.A.



TITULLI I PROJEKTIT

“Rikualifikim Blloku qe Kufizohet nga Rruget "Haxhi Xhuzi" - "Reze Drite" - "Halil Hoxha”

FAZA

PROJEKT ZBATIM

PROFILI GJATESOR

EMËRTIMI I FLETËS **AKSI 7**

SHKALLA **1:250**

NUMRI I FLETËS **T-80**

2024

AUTORITETI KONTRAKTOR:
BASHKIA TIRANË



PROJEKTUESI: "MANTE KONSTRUKSION" SH.P.K. & "FOCUS ARCHITECTURE" SH.P.K.

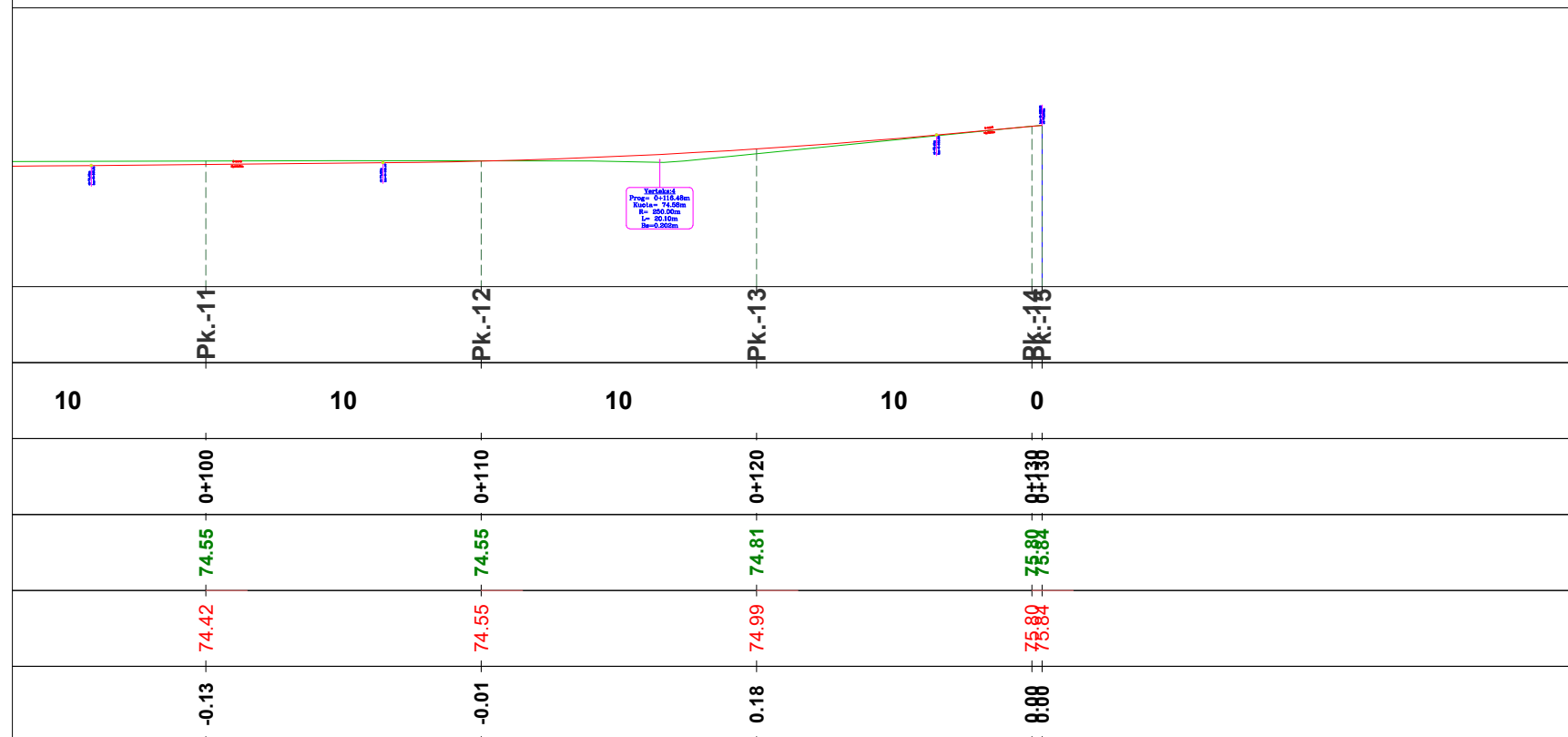

TITULLI I PROJEKTIT

“Rikualifikim Blloku qe Kufizohet nga Rruget "Haxhi Xhuzi" - "Reze Drite" - "Halil Hoxha”

FAZA

PROJEKT ZBATIM

SEKSIONET TERTHORE

EMËRTIMI I FLETËS AKSI 7

SHKALLA 1:100

NUMRI I FLETËS T-81

2024

AUTORITETI KONTRAKTOR:
BASHKIA TIRANË



BASHKIA
TIRANË

PROJEKTUESI: "VAANTE KONSTRUKSION" SH.P.A. & "FOCUS ARCHITECTURE" SH.P.A.



Km.0+000.00 (Progresivi-1)

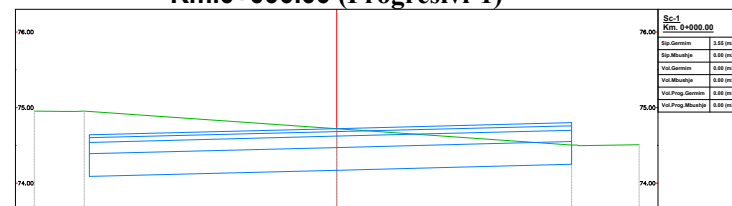

PROJEKTI TERRENI	Kuota	74.95	74.95	74.72	74.50	74.51
	Prog.	-4.00	-3.34	0.00	3.11	4.00
	Kuota		74.64	74.72	74.80	
	Prog.		-3.27	0.00	3.11	

Km.0+020.00 (Progresivi-3)

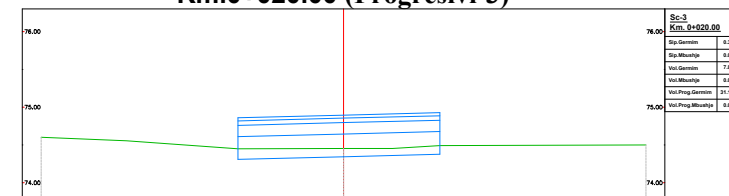

PROJEKTI TERRENI	Kuota	74.60	74.56	74.45	74.45	74.49	74.50
	Prog.	-4.00	-2.87	-1.40	0.00	1.27	4.00
	Kuota			74.86	74.89	74.93	
	Prog.			-1.40	0.00	1.27	

Km.0+010.00 (Progresivi-2)

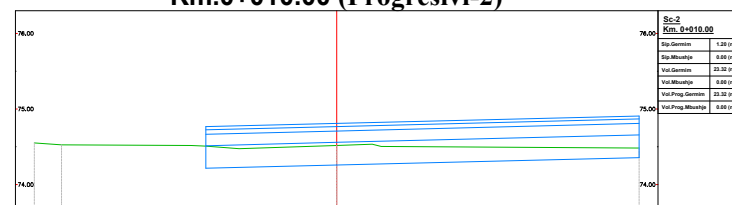

PROJEKTI TERRENI	Kuota	74.55	74.53	74.47	74.52	74.48
	Prog.	-4.00	-3.64	-1.29	0.00	4.00
	Kuota			74.77	74.61	74.91
	Prog.			-1.73	0.00	-4.00

Km.0+030.00 (Progresivi-4)

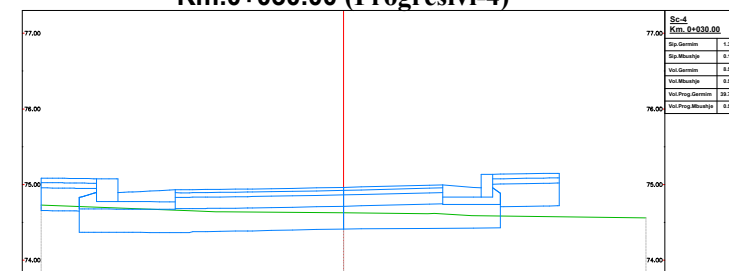

PROJEKTI TERRENI	Kuota	74.73	74.64	74.63	74.62	74.56
	Prog.	-4.00	-1.93	0.00	1.11	4.00
	Kuota	75.09	75.08	74.93	74.94	74.96
	Prog.	-4.00	-3.16	-2.15	-1.07	0.00

PROJEKTI TERRENI

Km.0+040.00 (Progresivi-5)



Kuota	74.56	74.54	74.50	74.49	74.47
Prog.	-4.00	-3.21	0.00	2.05	4.00
Kuota		75.01	74.96	74.90	74.94
Prog.		-3.13	-1.63	0.00	1.62

Sc-5	Km.0+040.00
Sp.Gesim	1.47 (m)
Sp.Mbushje	1.12 (m)
Sp.Gesim	10.87 (m)
Sp.Mbushje	1.60 (m)
Sp.Prog.Gesim	48.79 (m)
Sp.Prog.Mbushje	1.19 (m)

PROJEKTI TERRENI

Km.0+060.00 (Progresivi-7)

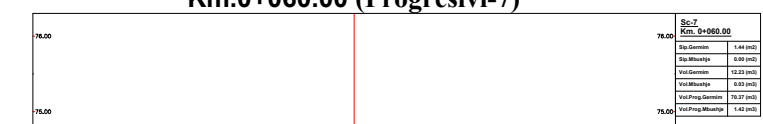

Kuota	74.35	74.33	74.38	74.35
Prog.	-4.00	-2.93	0.00	4.00
Kuota		74.69	74.54	74.56
Prog.		-3.13	-1.63	0.00

Sc-7	Km.0+060.00
Sp.Gesim	1.44 (m)
Sp.Mbushje	0.90 (m)
Sp.Gesim	12.23 (m)
Sp.Mbushje	0.80 (m)
Sp.Prog.Gesim	70.37 (m)
Sp.Prog.Mbushje	1.42 (m)

PROJEKTI TERRENI

Km.0+050.00 (Progresivi-6)

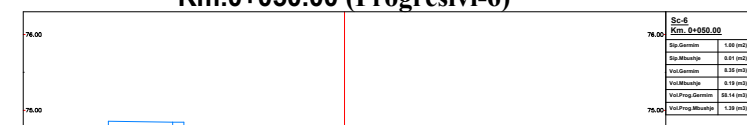

Kuota	74.45	74.42	74.45	74.43	74.41	74.40
Prog.	-4.00	-3.25	-2.09	0.00	1.79	4.00
Kuota		74.85	74.70	74.74	74.78	
Prog.		-3.13	-1.63	0.00	1.63	

Sc-6	Km.0+050.00
Sp.Gesim	1.80 (m)
Sp.Mbushje	1.27 (m)
Sp.Gesim	6.13 (m)
Sp.Mbushje	1.10 (m)
Sp.Prog.Gesim	88.14 (m)
Sp.Prog.Mbushje	1.30 (m)

PROJEKTI TERRENI

Km.0+070.00 (Progresivi-8)

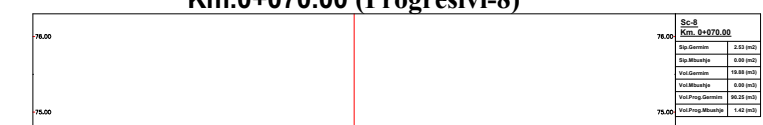

Kuota	74.40	74.38	74.38	74.48	74.46
Prog.	-4.00	-3.26	-1.86	0.00	4.00
Kuota		74.54	74.38	74.42	74.46
Prog.		-3.13	-1.63	0.00	1.63

Sc-8	Km.0+070.00
Sp.Gesim	2.51 (m)
Sp.Mbushje	0.90 (m)
Sp.Gesim	10.80 (m)
Sp.Mbushje	0.90 (m)
Sp.Prog.Gesim	88.25 (m)
Sp.Prog.Mbushje	1.42 (m)

TITULLI I PROJEKTIT

“Rikualifikim Biloku qe Kufizohet nga Rruget "Haxhi Xhuzi" - "Reze Drite" - "Halil Hoxha”

FAZA

PROJEKT ZBATIM

SEKSIONET TERTHORE

EMËRTIMI I FLETËS **AKSI 7**

SHKALLA **1:100**

NUMRI I FLETËS **T-82**

2024

AUTORITETI KONTRAKTOR:
BASHKIA TIRANË



PROJEKTUESI: "MANTE KONSTRUKSION" SH.P.A. & "FOCUS ARCHITECTURE" SH.P.A.



TITULLI I PROJEKTIT

“Rikualifikim Biloku qe Kufizohet nga Rruget "Haxhi Xhuzi" - "Reze Drite" - "Halil Hoxha”

FAZA

PROJEKT ZBATIM

SEKSIONET TERTHORE

EMËRTIMI I FLETËS AKSI 7

SHKALLA 1:100

NUMRI I FLETËS T-83

2024

AUTORITETI KONTRAKTOR:
BASHKIA TIRANË



BASHKIA TIRANË

PROJEKTUESI: "MANTE KONSTRUKSION" SH.P.A. & "FOCUS ARCHITECTURE" SH.P.A.



Km.0+080.00 (Progresivi-9)

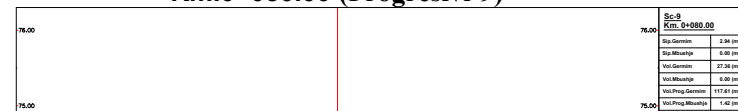

Sc-9 Km. 0+080.00	
Epa Gjerme	1.34 (m)
Epa Mbrojtje	1.30 (m)
Vid Gjerme	27.36 (m)
Vid Mbrojtje	0.30 (m)
Vid Prog Gjerme	117.81 (m)
Vid Prog Mbrojtje	1.41 (m)

PROJEKTI TERRENI

Kuota	74.41	74.40	74.40	74.42	74.51
Prog.	-4.00	-2.36	-1.06	0.00	4.00
Kuota		74.45	74.30	74.34	74.38
Prog.		-3.13	-1.63	0.00	1.63

Km.0+100.00 (Progresivi-11)



Sc-11 Km. 0+100.00	
Epa Gjerme	1.30 (m)
Epa Mbrojtje	0.30 (m)
Vid Gjerme	28.81 (m)
Vid Mbrojtje	0.30 (m)
Vid Prog Gjerme	175.16 (m)
Vid Prog Mbrojtje	1.41 (m)

PROJEKTI TERRENI

Kuota	74.53	74.53	74.55	74.52
Prog.	-4.00	-2.81	0.00	4.00
Kuota		74.54	74.38	74.46
Prog.		-3.13	-1.63	1.63

Km.0+090.00 (Progresivi-10)

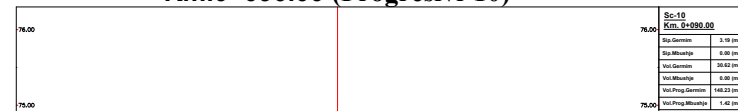

Sc-10 Km. 0+090.00	
Epa Gjerme	1.30 (m)
Epa Mbrojtje	0.30 (m)
Vid Gjerme	29.42 (m)
Vid Mbrojtje	0.30 (m)
Vid Prog Gjerme	148.21 (m)
Vid Prog Mbrojtje	1.41 (m)

PROJEKTI TERRENI

Kuota	74.41	74.40	74.48	74.52	74.56	74.52
Prog.	-4.00	-3.26	-1.13	0.00	1.23	4.00
Kuota		74.45	74.30	74.34	74.38	
Prog.		-3.13	-1.63	0.00	1.63	

Km.0+110.00 (Progresivi-12)

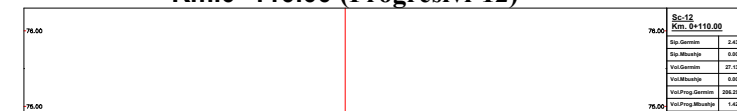

Sc-12 Km. 0+110.00	
Epa Gjerme	2.41 (m)
Epa Mbrojtje	0.30 (m)
Vid Gjerme	27.12 (m)
Vid Mbrojtje	0.30 (m)
Vid Prog Gjerme	208.28 (m)
Vid Prog Mbrojtje	1.41 (m)

PROJEKTI TERRENI

Kuota	74.51	74.51	74.55	74.51
Prog.	-4.00	-3.12	0.00	4.00
Kuota		74.66	74.51	74.59
Prog.		-3.13	-1.63	1.63

Km.0+120.00 (Progresivi-13)

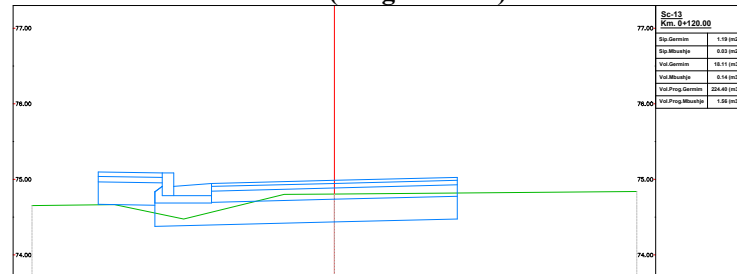

PROJEKTI TERRENI

Kuota	74.65	74.47	74.81	74.84
Prog.	-4.00	-1.99	0.00	4.00
Kuota				
Prog.	-3.13	-1.63	0.00	1.63

Km.0+130.36 (Progresivi-15)

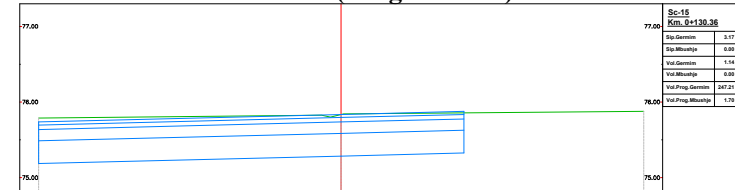

PROJEKTI TERRENI

Kuota	75.79	75.84	75.88
Prog.	-4.00	0.00	4.00
Kuota			
Prog.	-4.00	0.00	1.63

Km.0+130.00 (Progresivi-14)

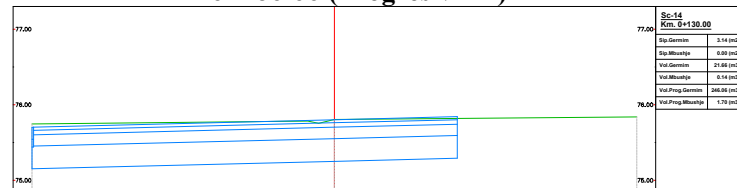

PROJEKTI TERRENI

Kuota	75.75	75.80	75.84
Prog.	-4.00	0.00	4.00
Kuota			
Prog.	-4.00	0.00	-1.63

TITULLI I PROJEKTIT

“Rikualifikim Blloku qe Kufizohet nga Rruget "Haxhi Xhuzi" - "Reze Drite" - "Halil Hoxha”

FAZA

PROJEKT ZBATIM

SEKSIONET TERTHORE

EMËRTIMI I FLETËS **AKSI 7**

SHKALLA **1:100**

NUMRI I FLETËS **T-84**

2024

AUTORITETI KONTRAKTOR:
BASHKIA TIRANË



PROJEKTUESI: "MANTE KONSTRUKSION" SH.P.K. & "FOCUS ARCHITECTURE" SH.P.K.



TITULLI I PROJEKTIT

“Rikualifikim Blloku qe Kufizohet nga Rruget "Haxhi Xhuzi" - "Reze Drite" - "Halil Hoxha”

FAZA

PROJEKT ZBATIM

Tabela Volumeve

Progresivi	Sip.Mbushje	Sip.Germim	Vol.Mbushje	Vol.Germim	Vol.Prog.Mbush	Vol.Prog.Germim
0+000.00	0.00	3.55	0.00	0.00	0.00	0.00
0+010.00	0.00	1.20	0.00	23.32	0.00	23.32
0+020.00	0.00	0.31	0.00	7.86	0.00	31.19
0+030.00	0.10	1.38	0.50	8.54	0.50	39.72
0+040.00	0.03	0.67	0.69	10.07	1.19	49.79
0+050.00	0.01	1.00	0.19	8.35	1.39	58.14
0+060.00	0.00	1.44	0.03	12.23	1.42	70.37
0+070.00	0.00	2.53	0.00	19.88	1.42	90.25
0+080.00	0.00	2.94	0.00	27.36	1.42	117.61
0+090.00	0.00	3.19	0.00	30.62	1.42	148.23
0+100.00	0.00	3.00	0.00	30.93	1.42	179.16
0+110.00	0.00	2.43	0.00	27.13	1.42	206.29
0+120.00	0.03	1.19	0.14	18.11	1.56	224.40
0+130.00	0.00	3.14	0.14	21.66	1.70	246.06
0+130.36	0.00	3.17	0.00	1.14	1.70	247.21

TABELA E VOLUMEVE

EMËRTIMI I FLETËS **AKSI 7**

SHKALLA

NUMRI I FLETËS **T-85**

2024

AUTORITETI KONTRAKTOR:
BASHKIA TIRANË



BASHKIA
TIRANË

PROJEKTUESI: "VANIE KONSTRUKSION" SH.P.A. & "FOCUS ARCHITECTURE" SH.P.A.



TITULLI I PROJEKTIT

“Rikualifikim Blloku qe Kufizohet nga Rruget "Haxhi Xhuzi" - "Reze Drite" - "Halil Hoxha”

FAZA

PROJEKT ZBATIM

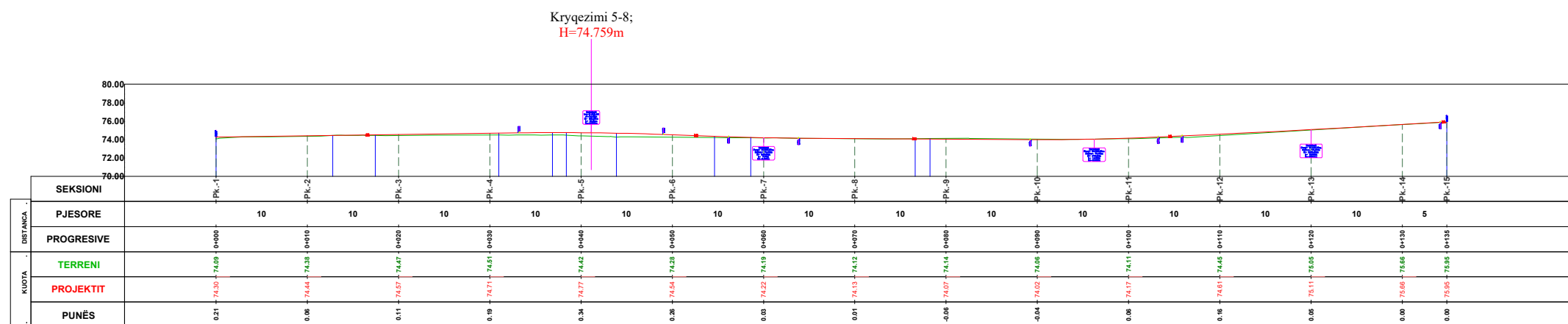

PROFILI GJATESOR

EMËRTIMI I FLETËS **AKSI 8**

SHKALLA

NUMRI I FLETËS **T-86**

2024

AUTORITETI KONTRAKTOR:
BASHKIA TIRANË



PROJEKTUESI: "MANTE KONSTRUKSION" SH.P.K. & "FOCUS ARCHITECTURE" SH.P.K.



TITULLI I PROJEKTIT

“Rikualifikim Blloku qe Kufizohet nga Rruget "Haxhi Xhuzi" - "Reze Drite" - "Halil Hoxha”

FAZA

PROJEKT ZBATIM

Kryqezimi 5-8;
H=74.759m

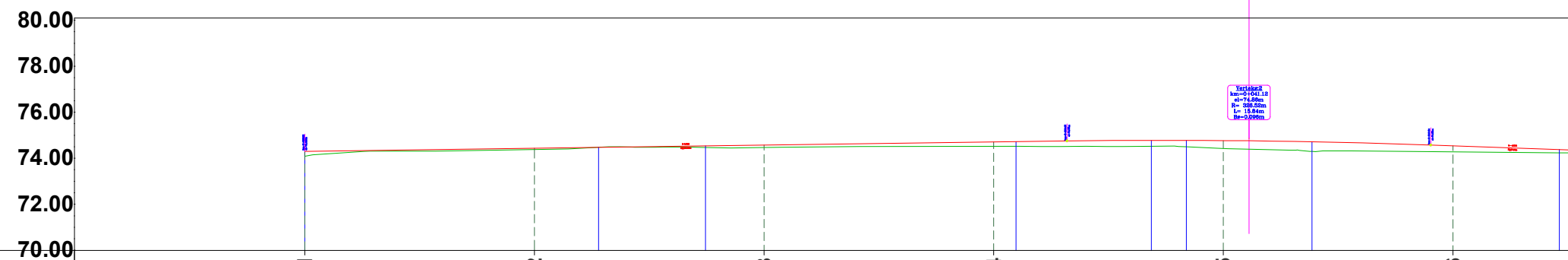

DISTANCA	SEKSIONI	PK.-1	PK.-2	PK.-3	PK.-4	PK.-5	PK.-6
	PJESORE	10	10	10	10	10	10
PROGRESIVE	0+000	0+010	0+020	0+030	0+040	0+050	
KUOTA	TERRENI	74.09	74.38	74.47	74.51	74.42	74.28
	PROJEKTIT	74.30	74.44	74.57	74.71	74.77	74.54
	PUNËS	0.21	0.06	0.11	0.19	0.34	0.26

PROFILI GJATESOR

EMËRTIMI I FLETËS **AKSI 8**

SHKALLA **1:250**

NUMRI I FLETËS **T-87**

2024

AUTORITETI KONTRAKTOR:
BASHKIA TIRANË



PROJEKTUESI: "MANTE KONSTRUKSION" SH.P.A. & "FOCUS ARCHITECTURE" SH.P.A.



TITULLI I PROJEKTIT

“Rikualifikim Blloku qe Kufizohet nga Rruget "Haxhi Xhuzi" - "Reze Drite" - "Halil Hoxha”

FAZA

PROJEKT ZBATIM

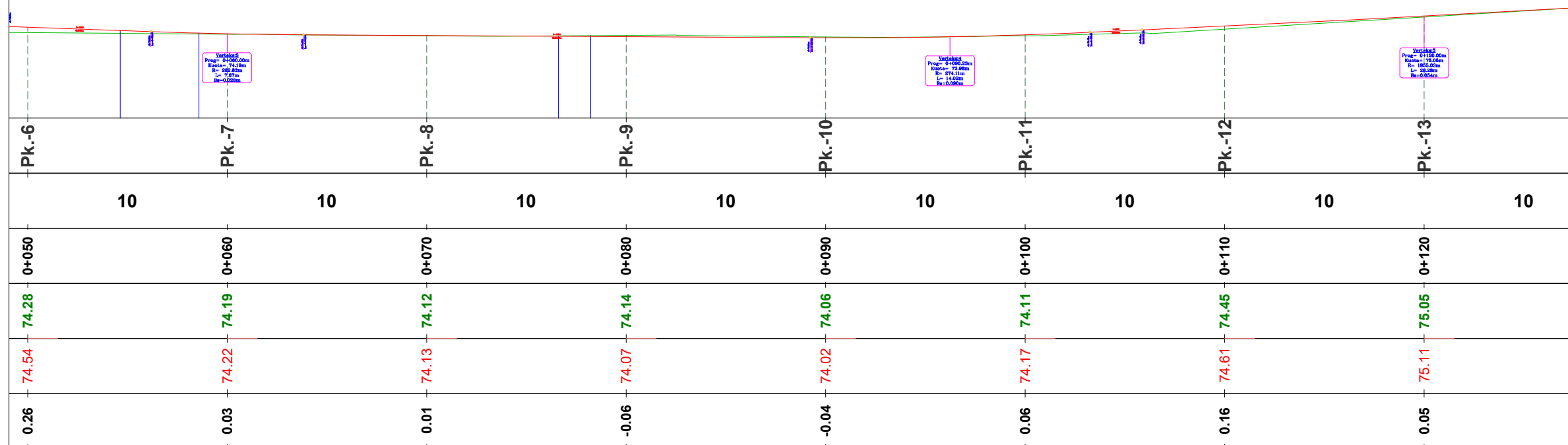

PROFILI GJATESOR

EMËRTIMI I FLETËS **AKSI 8**

SHKALLA **1:250**

NUMRI I FLETËS **T-88**

2024

AUTORITETI KONTRAKTOR:
BASHKIA TIRANË



PROJEKTUESI: "MANTE KONSTRUKSION" SH.P.K. & "FOCUS ARCHITECTURE" SH.P.K.



TITULLI I PROJEKTIT

“Rikualifikim Blloku qe Kufizohet nga Rruget "Haxhi Xhuzi" - "Reze Drite" - "Halil Hoxha”

FAZA

PROJEKT ZBATIM

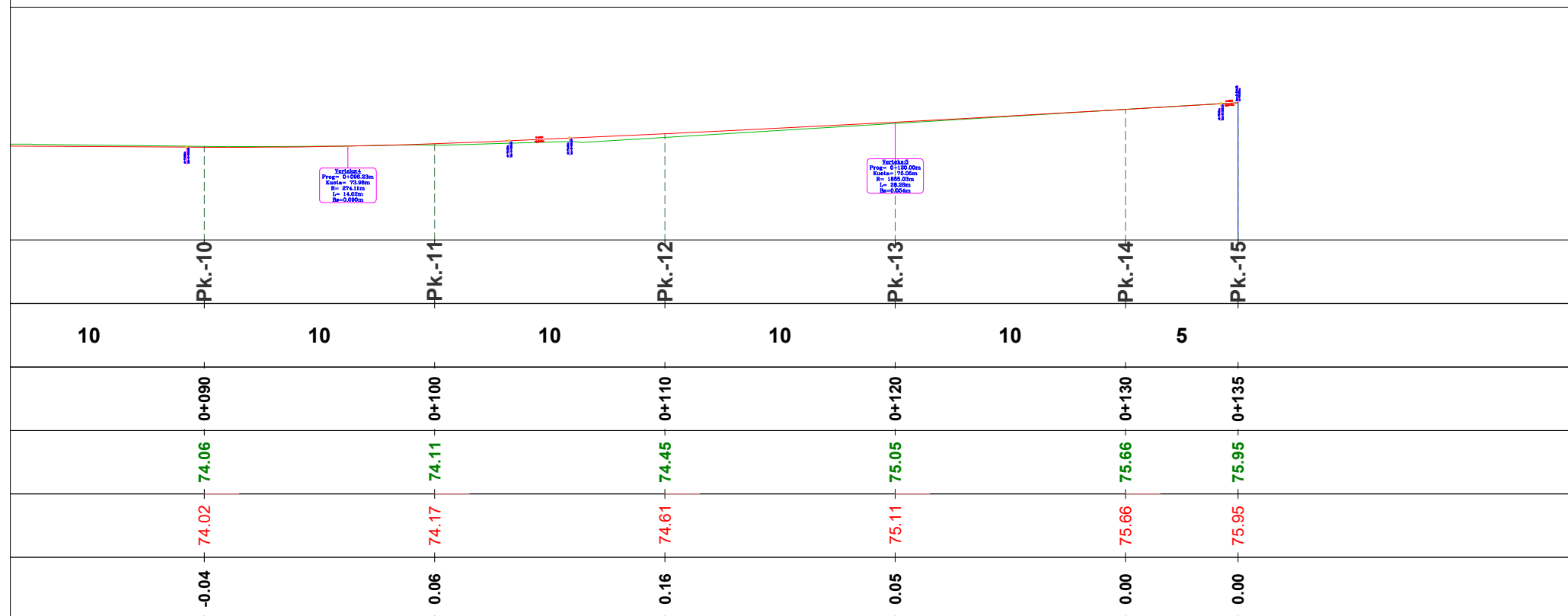

PROFILI GJATESOR

EMËRTIMI I FLETËS **AKSI 8**

SHKALLA **1:250**

NUMRI I FLETËS **T-89**

2024

AUTORITETI KONTRAKTOR:
BASHKIA TIRANË



PROJEKTUESI: "MANTE KONSTRUKSION" SH.P.K. & "FOCUS ARCHITECTURE" SH.P.K.



TITULLI I PROJEKTIT

“Rikualifikim Billoku qe Kufizohet nga Rruget "Haxhi Xhuzi" - "Reze Drite" - "Halil Hoxha”

FAZA

PROJEKT ZBATIM

SEKSIONET TERTHORE

EMËRTIMI I FLETËS AKSI 8

SHKALLA 1:100

NUMRI I FLETËS T-90

2024

AUTORITETI KONTRAKTOR:
BASHKIA TIRANË



PROJEKTUESI: "VANITE KONSTRUKSION" SH.P.A. & "FOCUS ARCHITECTURE" SH.P.A.



Km.0+000.00 (Progresivi-1)

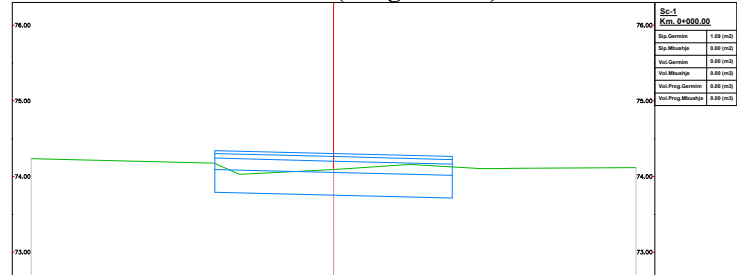

PROJEKTI TERRENI	Kuota	74.23		74.03		74.09		74.16		74.11		74.12
	Prog.	-4.00		-1.24		0.00		1.01		2.17		4.00
	Kuota			74.34		74.30		74.26				
	Prog.			-1.57		0.00		1.57				

Km.0+020.00 (Progresivi-3)

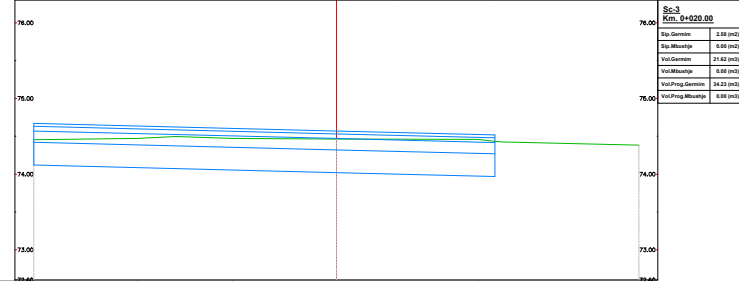

PROJEKTI TERRENI	Kuota	74.45		74.47		74.47		74.47		74.46		74.39
	Prog.	-4.00		-2.64		-1.37		0.00		1.87		4.00
	Kuota			74.67				74.67		74.62		
	Prog.			-4.00		0.00		74.67		2.10		74.62

Km.0+010.00 (Progresivi-2)

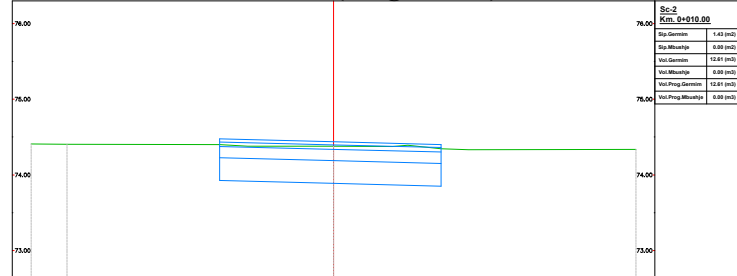

PROJEKTI TERRENI	Kuota	74.41		74.40		74.38		74.38		74.35		74.34
	Prog.	-4.00		-3.53		-1.14		0.00		1.42		4.00
	Kuota			74.48				74.44		74.40		
	Prog.			-1.51		0.00		74.44		1.42		74.40

Km.0+030.00 (Progresivi-4)

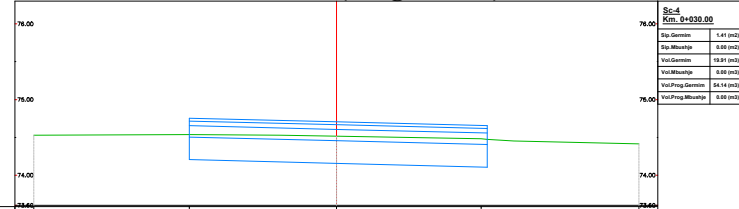

PROJEKTI TERRENI	Kuota	74.63		74.63		74.61		74.48		74.41		
	Prog.	-4.00		-1.95		0.00		-1.91		4.00		
	Kuota			74.75				74.66				
	Prog.			-1.95		0.00		74.71		1.99		74.66

TITULLI I PROJEKTIT

“Rikualifikim Blloku qe Kufizohet nga Rruget "Haxhi Xhuzi" - "Reze Drite" - "Halil Hoxha”

FAZA

PROJEKT ZBATIM

SEKSIONET TERTHORE

EMËRTIMI I FLETËS **AKSI 8**

SHKALLA **1:100**

NUMRI I FLETËS **T-91**

2024

AUTORITETI KONTRAKTOR:
BASHKIA TIRANË



BASHKIA TIRANË

PROJEKTUESI: "MANTE KONSTRUKSION" SH.P.A. & "FOCUS ARCHITECTURE" SH.P.A.



Km.0+060.00 (Progresivi-7)

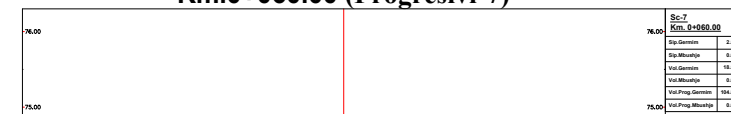

PROJEKTI TERRENI

Kuota	74.20	74.31	74.28	74.19	74.20	74.19
Prog.	-4.00	-3.15	-1.59	0.00	1.47	4.00
Kuota		74.33	74.18	74.22	74.26	
Prog.		-3.13	-1.63	0.00	1.62	

Km.0+040.00 (Progresivi-5)

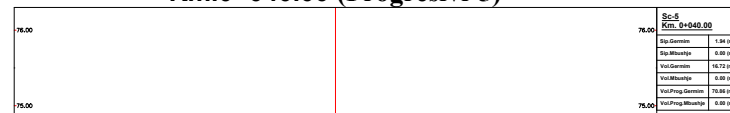

PROJEKTI TERRENI

Kuota	74.36	74.41	74.42	74.45	74.45
Prog.	-4.00	-2.99	0.00	1.69	4.00
Kuota	74.77	74.76	74.75	74.74	74.70
Prog.	-4.00	-3.10	-2.07	1.02	2.02

Km.0+070.00 (Progresivi-8)

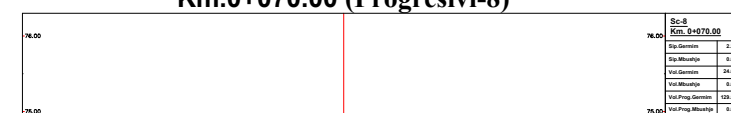

PROJEKTI TERRENI

Kuota	74.09	74.08	74.12	74.12
Prog.	-4.00	-2.53	0.00	4.00
Kuota	74.25	74.09	74.13	74.17
Prog.		-3.12	-1.62	1.63

Km.0+050.00 (Progresivi-6)

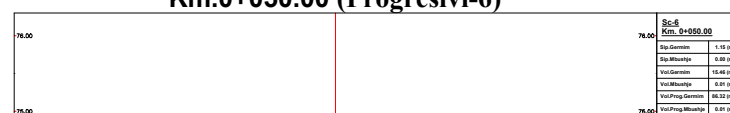

PROJEKTI TERRENI

Kuota	74.22	74.23	74.28	74.29
Prog.	-4.00	-2.63	0.00	4.00
Kuota	74.66	74.50	74.54	74.58
Prog.		-3.13	-1.63	1.62

TITULLI I PROJEKTIT

“Rikualifikim Blloku qe Kufizohet nga Rruget "Haxhi Xhuzi" - "Reze Drite" - "Halil Hoxha”

FAZA

PROJEKT ZBATIM

SEKSIONET TERTHORE

EMËRTIMI I FLETËS **AKSI 8**

SHKALLA **1:100**

NUMRI I FLETËS **T-92**

2024

AUTORITETI KONTRAKTOR:
BASHKIA TIRANË



BASHKIA TIRANË

PROJEKTUESI: "VANTE KONSTRUKSION" SH.P.A. & "FOCUS ARCHITECTURE" SH.P.A.



Km.0+080.00 (Progresivi-9)

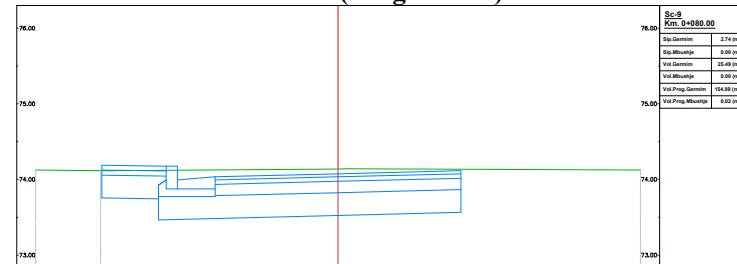

Sec-9 Km. 0+080.00	
Top.Germsi	2.74 (m2)
Top.Mberrape	0.00 (m2)
Vol.Germsi	12.00 (m3)
Vol.Mberrape	0.00 (m3)
Vol.Prog.Germsi	104.99 (m3)
Vol.Prog.Mberrape	0.00 (m3)

PROJEKTI TERRENI

Kuota	74.13	74.12	74.14	74.12
Prog.	-4.00	-2.96	0.00	4.00
Kuota	74.19	74.03	74.07	74.11
Prog.	-3.13	-1.63	0.00	1.62

Km.0+100.00 (Progresivi-11)

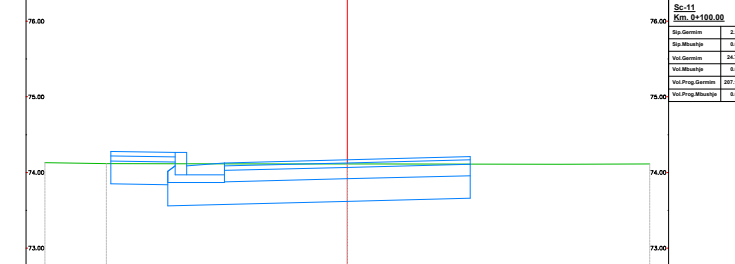

Sec-11 Km. 0+100.00	
Top.Germsi	2.20 (m2)
Top.Mberrape	0.00 (m2)
Vol.Germsi	34.77 (m3)
Vol.Mberrape	0.00 (m3)
Vol.Prog.Germsi	107.74 (m3)
Vol.Prog.Mberrape	0.00 (m3)

PROJEKTI TERRENI

Kuota	74.13	74.12	74.11	74.11	74.11	74.11
Prog.	-4.00	-3.18	-1.01	0.00	2.83	4.00
Kuota	74.23	74.13	74.17	74.21		
Prog.	-3.12	-1.62	0.00	1.63		

Km.0+090.00 (Progresivi-10)

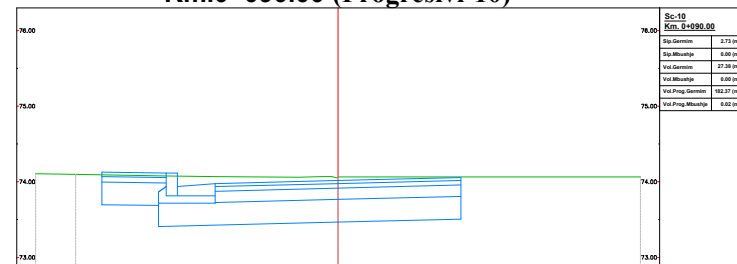

Sec-10 Km. 0+090.00	
Top.Germsi	2.75 (m2)
Top.Mberrape	0.00 (m2)
Vol.Germsi	27.28 (m3)
Vol.Mberrape	0.00 (m3)
Vol.Prog.Germsi	102.27 (m3)
Vol.Prog.Mberrape	0.00 (m3)

PROJEKTI TERRENI

Kuota	74.11	74.10	74.07	74.06	74.07
Prog.	-4.00	-3.47	-1.62	0.00	4.00
Kuota	74.13	73.98	74.02	74.06	
Prog.	-3.13	-1.63	0.00	1.62	

Km.0+110.00 (Progresivi-12)

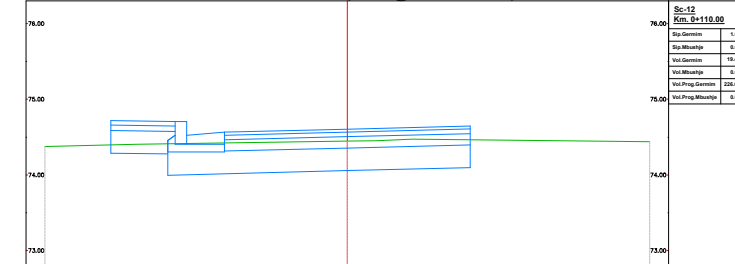

Sec-12 Km. 0+110.00	
Top.Germsi	1.60 (m2)
Top.Mberrape	0.00 (m2)
Vol.Germsi	16.49 (m3)
Vol.Mberrape	0.00 (m3)
Vol.Prog.Germsi	100.83 (m3)
Vol.Prog.Mberrape	0.00 (m3)

PROJEKTI TERRENI

Kuota	74.38	74.40	74.45	74.44
Prog.	-4.00	-2.79	0.00	4.00
Kuota	74.72	74.67	74.61	74.65
Prog.	-3.12	-1.62	0.00	1.63

TITULLI I PROJEKTIT

“Rikualifikim Blloku qe Kufizohet nga Rruget "Haxhi Xhuzi" - "Reze Drite" - "Halil Hoxha”

FAZA

PROJEKT ZBATIM

SEKSIONET TERTHORE

EMËRTIMI I FLETËS **AKSI 8**

SHKALLA **1:100**

NUMRI I FLETËS **T-93**

2024

AUTORITETI KONTRAKTOR:
BASHKIA TIRANË



BASHKIA
TIRANË

PROJEKTUESI: "VAANTE KONSTRUKSION" SH.P.A. & "FOCUS ARCHITECTURE" SH.P.A.



Km.0+120.00 (Progresivi-13)

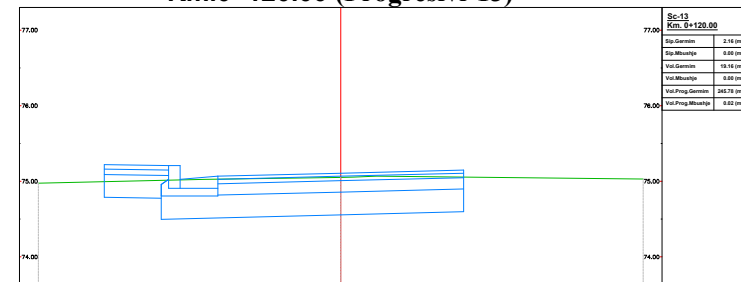

Sic-13 Km. 0+120.00	
Bip.Garimit	2.19 (m)
Bip.Mbrojtje	1.00 (m)
Vat.Garimit	18.16 (m)
Vat.Mbrojtje	0.00 (m)
Vat.Prog.Garimit	240.70 (m)
Vat.Prog.Mbrojtje	0.00 (m)

PROJEKTI TERRENI

Kuota	74.98	75.03	75.05	75.03
Prog.	-4.00	-1.79	0.00	4.00
Kuota		-3.12	-1.62	0.00
Prog.		-3.12	-1.62	0.00

Km.0+134.88 (Progresivi-15)

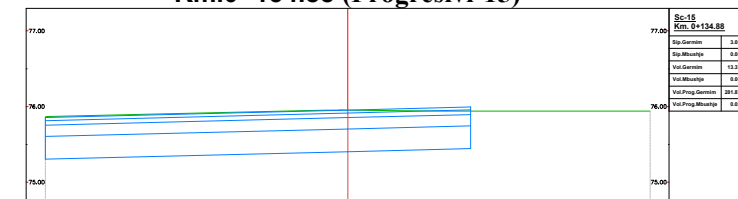

Sic-15 Km. 0+134.88	
Bip.Garimit	0.00 (m)
Bip.Mbrojtje	0.00 (m)
Vat.Garimit	13.07 (m)
Vat.Mbrojtje	0.00 (m)
Vat.Prog.Garimit	240.07 (m)
Vat.Prog.Mbrojtje	0.00 (m)

PROJEKTI TERRENI

Kuota	75.87	75.95	75.94	75.94
Prog.	-4.00	0.00	1.26	4.00
Kuota		-3.12	-1.63	0.00
Prog.		-3.12	-1.63	0.00

Km.0+130.00 (Progresivi-14)

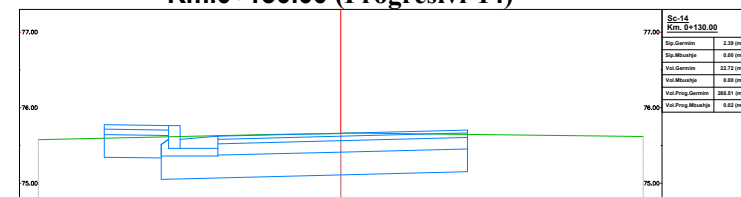

Sic-14 Km. 0+130.00	
Bip.Garimit	2.39 (m)
Bip.Mbrojtje	1.00 (m)
Vat.Garimit	12.70 (m)
Vat.Mbrojtje	0.00 (m)
Vat.Prog.Garimit	240.07 (m)
Vat.Prog.Mbrojtje	0.00 (m)

PROJEKTI TERRENI

Kuota	75.57	75.62	75.66	75.62
Prog.	-4.00	-1.62	0.00	4.00
Kuota		-3.12	-1.68	0.00
Prog.		-3.12	-1.68	0.00

TITULLI I PROJEKTIT

“Rikualifikim Blloku qe Kufizohet nga Rruget "Haxhi Xhuzi" - "Reze Drite" - "Halil Hoxha”

FAZA

PROJEKT ZBATIM

Tabela Volumeve

Progresivi	Sip.Mbushje	Sip.Germim	Vol.Mbushje	Vol.Germim	Vol.Prog.Mbush	Vol.Prog.Germim
0+000.00	0.00	1.09	0.00	0.00	0.00	0.00
0+010.00	0.00	1.43	0.00	12.61	0.00	12.61
0+020.00	0.00	2.58	0.00	21.62	0.00	34.23
0+030.00	0.00	1.41	0.00	19.91	0.00	54.14
0+040.00	0.00	1.94	0.00	16.72	0.00	70.86
0+050.00	0.00	1.15	0.01	15.46	0.01	86.32
0+060.00	0.00	2.57	0.01	18.56	0.02	104.88
0+070.00	0.00	2.35	0.00	24.62	0.02	129.50
0+080.00	0.00	2.74	0.00	25.49	0.02	154.99
0+090.00	0.00	2.73	0.00	27.38	0.02	182.37
0+100.00	0.00	2.22	0.00	24.77	0.02	207.14
0+110.00	0.00	1.68	0.00	19.49	0.02	226.62
0+120.00	0.00	2.16	0.00	19.16	0.02	245.78
0+130.00	0.00	2.39	0.00	22.72	0.02	268.51
0+134.88	0.00	3.08	0.00	13.37	0.02	281.87

TABELA E VOLUMEVE

EMËRTIMI I FLETËS **AKSI 8**

SHKALLA

NUMRI I FLETËS **T-94**

2024

AUTORITETI KONTRAKTOR:
BASHKIA TIRANË



BASHKIA
TIRANË

PROJEKTUESI: "MANTE KONSTRUKSION" SH.P.A. & "FOCUS ARCHITECTURE" SH.P.A.



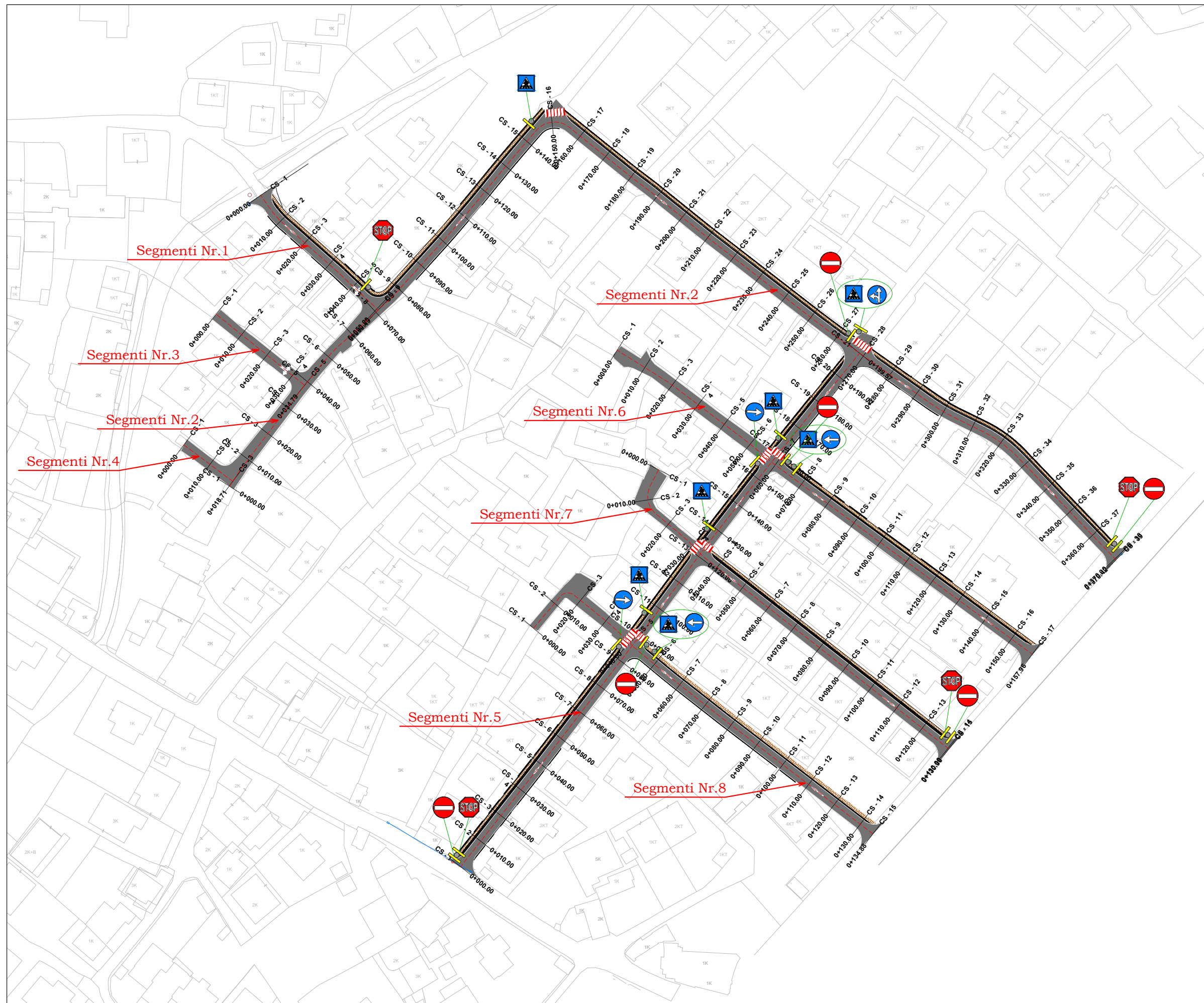

TITULLI I PROJEKTIT

“Rikualifikim Blloku qe Kufizohet nga Rruget "Haxhi Xhuzi" - "Reze Drite" - "Halil Hoxha”

FAZA

PROJEKT ZBATIM

LEGJENDA

- SIPERFACE ME ASFALT
- KUNETË
- TROTUAR
- MUR I RI
- VIJAT PER KALIM KEMBESORËSH

PLANIMETRIA E SINJALISTIKËS

EMËRTIMI I FLETËS

SHKALLA

NUMRI I FLETËS

T-95

2024

AUTORITETI KONTRAKTOR:
BASHKIA TIRANË



PROJEKTUESI: "VANITE KONSTRUKSION" SH.P.A. & "FOCUS ARCHITECTURE" SH.P.A.



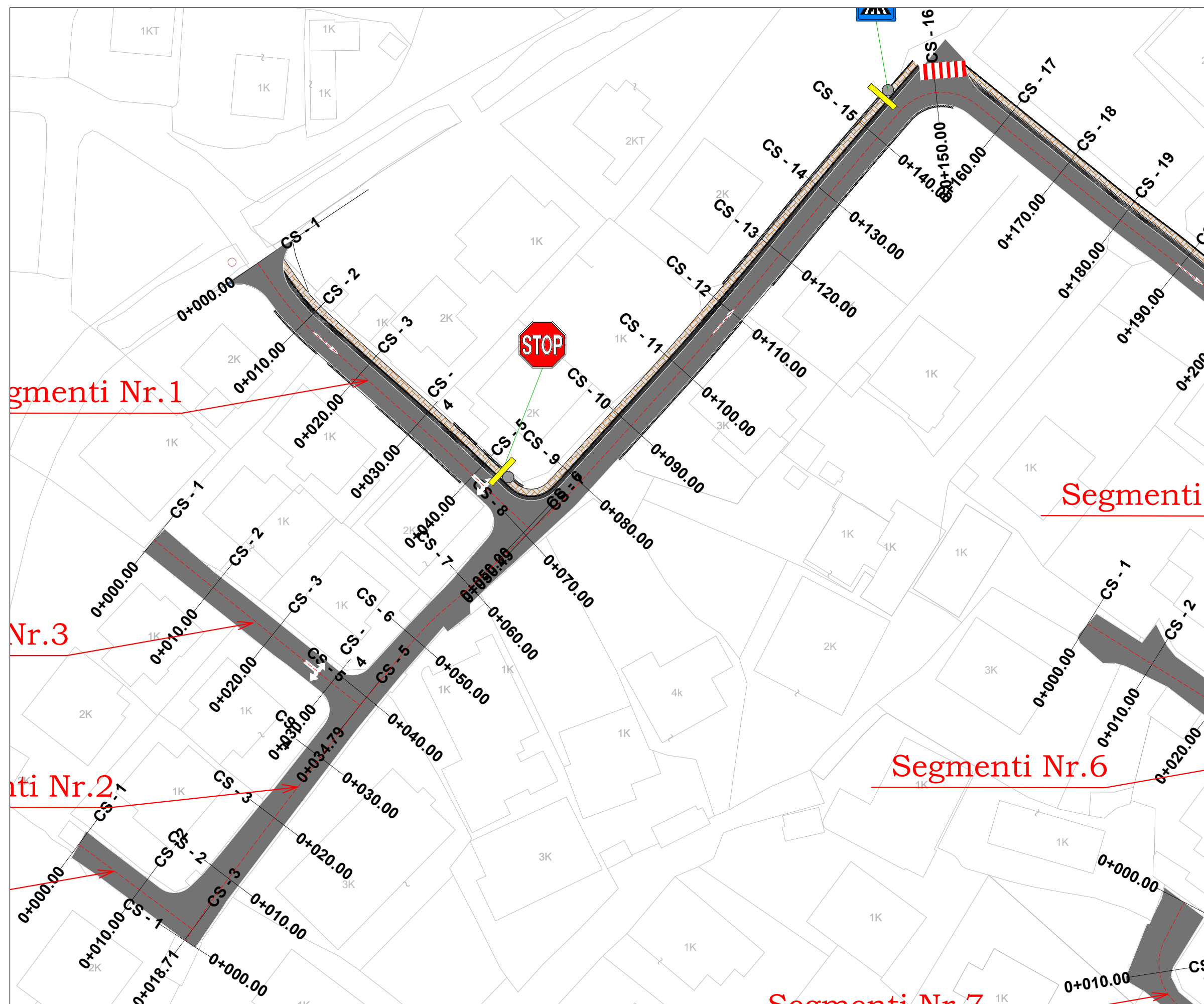

TITULLI I PROJEKTIT

“Rikualifikim Blloku qe Kufizohet nga Rruget "Haxhi Xhuzi" - "Reze Drite" - "Halil Hoxha”

FAZA
PROJEKT ZBATIM

LEGJENDA

	SIPERFACE ME ASFALT
	KUNETË
	TROTUAR
	MUR I RI
	VIJAT PER KALIM KEMBESORËSH

PLANIMETRIA E SINJALISTIKËS

EMËRTIMI I FLETËS **Aksi 1, 2, 3 & 4**
 SHKALLA **1:500**
 NUMRI I FLETËS **T-96**

2024

AUTORITETI KONTRAKTOR:
 BASHKIA TIRANË



PROJEKTUESI: "VAIANTE KONSTRUKSION" SH.P.A. & "FOCUS ARCHITECTURE" SH.P.A.



Segmenti Nr.1

Nr.3

Segmenti Nr.2

Segmenti

Segmenti Nr.6

Segmenti Nr.7

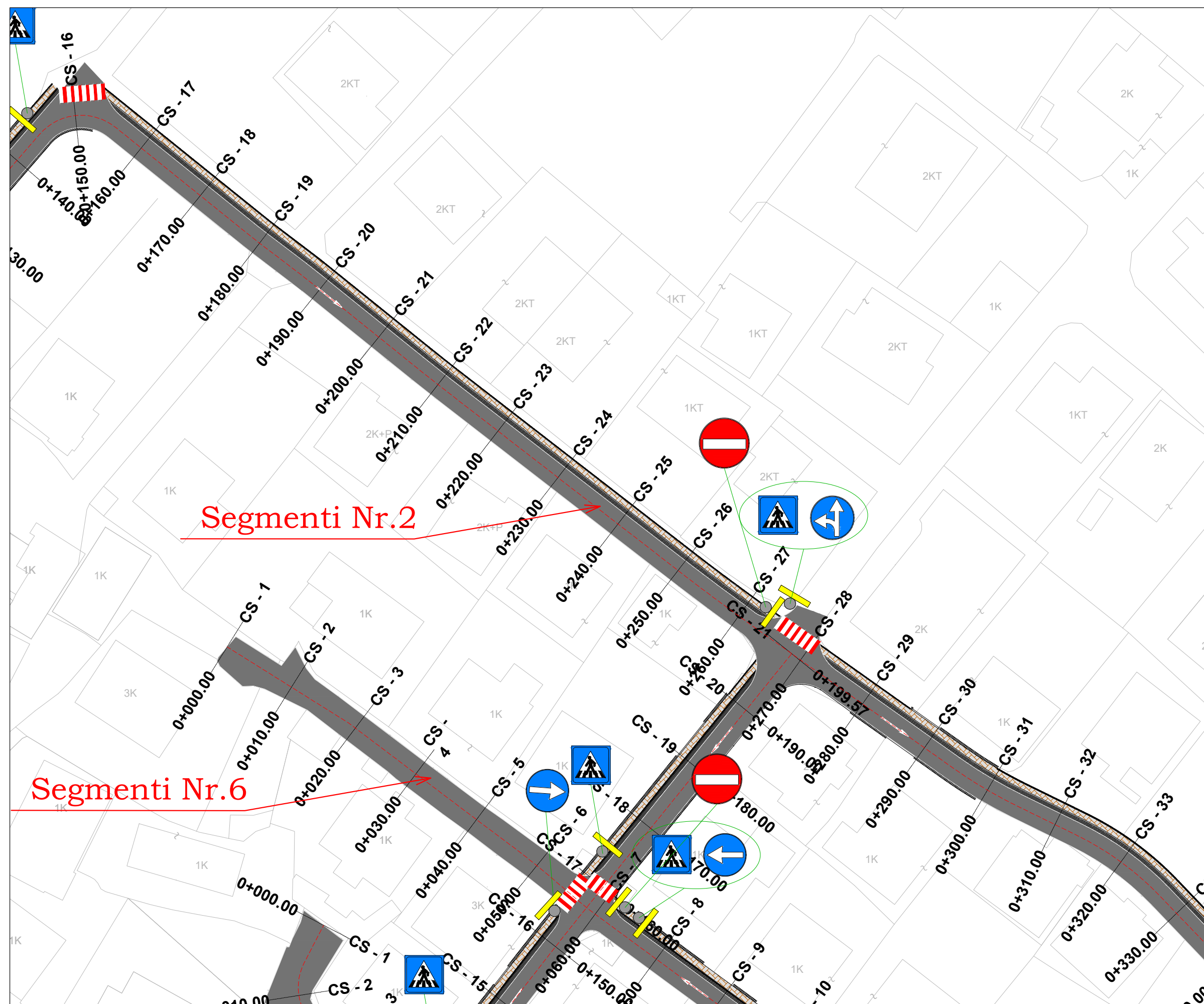

TITULLI I PROJEKTIT

“Rikualifikim Blloku qe Kufizohet nga Rruget "Haxhi Xhuzi" - "Reze Drite" - "Halil Hoxha”

FAZA
PROJEKT ZBATIM

LEGJENDA

-  SIPERFAQE ME ASFALT
-  KUNETË
-  TROTUAR
-  MUR I RI
-  VIJAT PER KALIM KEMBESORËSH

PLANIMETRIA E SINJALISTIKËS

EMËRTIMI I FLETËS **Aksi 2**

SHKALLA **1:500**

NUMRI I FLETËS **T-97**

2024

AUTORITETI KONTRAKTOR:
BASHKIA TIRANË



PROJEKTUESI: "VAANTE KONSTRUKSION" SH.P.A. & "FOCUS ARCHITECTURE" SH.P.A.



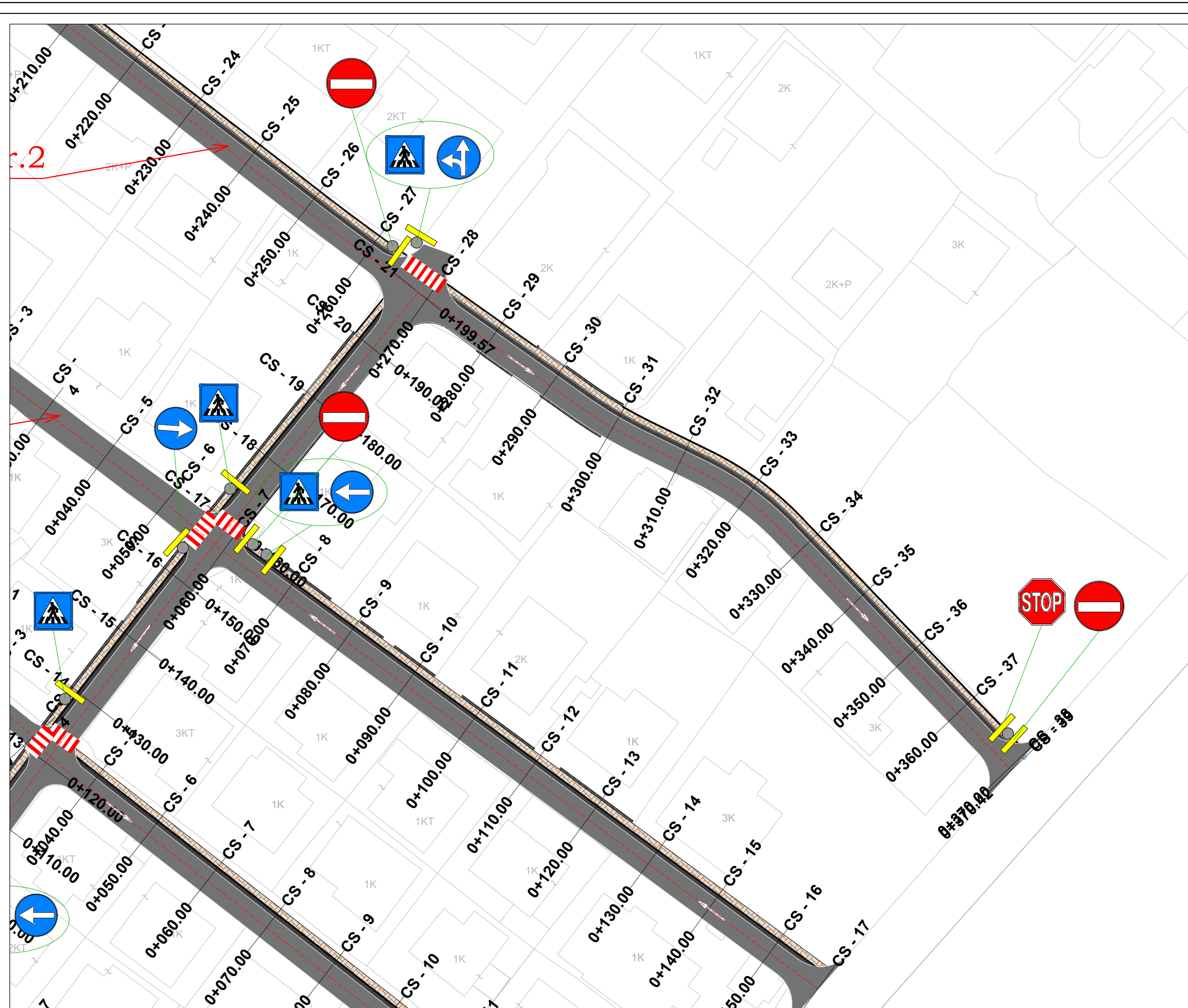

TITULLI I PROJEKTIT

“Rikualifikim Blloku qe Kufizohet nga Rruget "Haxhi Xhuzi" - "Reze Drite" - "Halil Hoxha”

FAZA
PROJEKT ZBATIM

LEGJENDA

	SIPERFACE ME ASFALT
	KUNETË
	TROTUAR
	MUR I RI
	VIJAT PER KALIM KEMBESORËSH

PLANIMETRIA E SINJALISTIKËS

EMËRTIMI I FLETËS	Aksi 2
SHKALLA	1:500
NUMRI I FLETËS	T-98
2024	

AUTORITETI KONTRAKTOR:
 BASHKIA TIRANË



PROJEKTUESI: "VANTE KONSTRUKSION" SH.P.A. & "FOCUS ARCHITECTURE" SH.P.A.



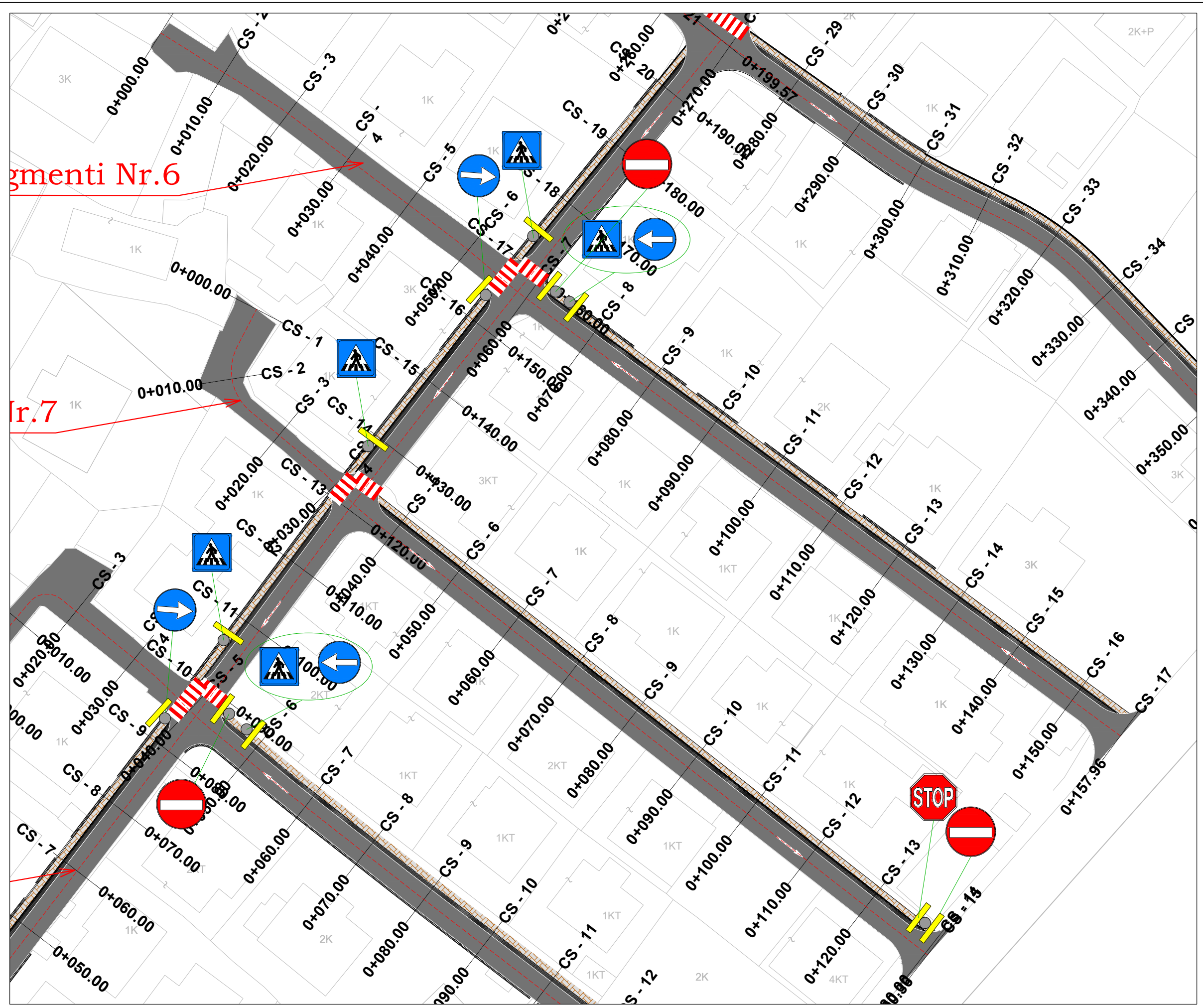

Segmenti Nr.6

Segmenti Nr.7

TITULLI I PROJEKTIT

“Rikualifikim Blloku qe Kufizohet nga Rruget "Haxhi Xhuzi" - "Reze Drite" - "Halil Hoxha”

FAZA
PROJEKT ZBATIM

LEGJENDA

	SIPERFAQE ME ASFALT
	KUNETË
	TROTUAR
	MUR I RI
	VIJAT PER KALIM KEMBESORËSH

PLANIMETRIA E SINJALISTIKËS

EMËRTIMI I FLETËS	Aksi 6 & 7
SHKALLA	1:500
NUMRI I FLETËS	T-99
	2024

AUTORITETI KONTRAKTOR:
BASHKIA TIRANË



PROJEKTUESI: "VAANTE KONSTRUKSION" SH.P.A. & "FOCUS ARCHITECTURE" SH.P.A.



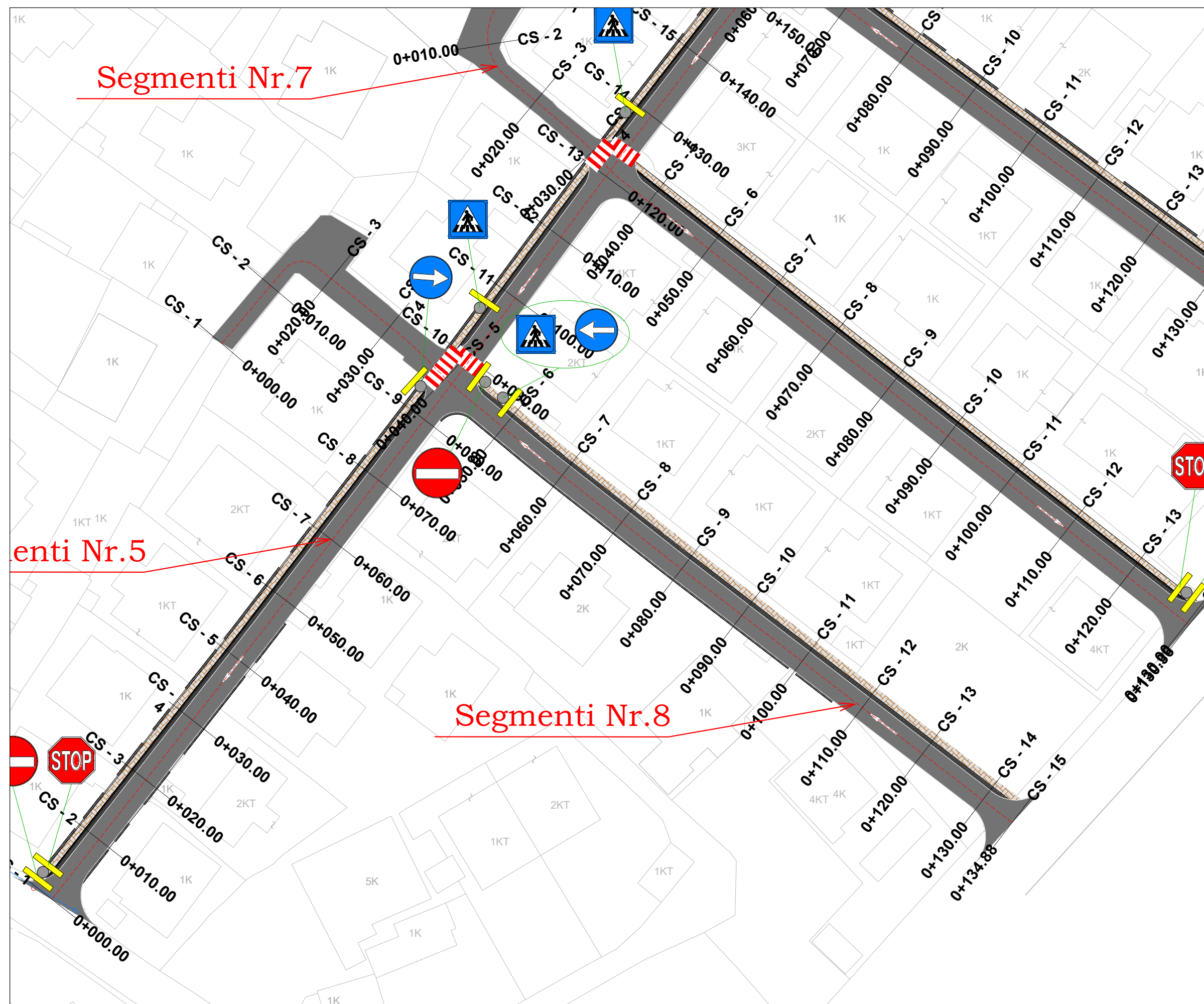

TITULLI I PROJEKTIT

“Rikualifikim Blloku qe Kufizohet nga Rruget "Haxhi Xhuzi" - "Reze Drite" - "Halil Hoxha”

FAZA
PROJEKT ZBATIM

LEGJENDA

- SIPERFACE ME ASFALT
- KUNETË
- TROTUAR
- MUR I RI
- VIJAT PER KALIM KËMBËSORËSH

PLANIMETRIA E SINJALISTIKËS

EMËRTIMI I FLETËS **Aksi 8**
 SHKALLA **1:500**
 NUMRI I FLETËS **T-100**
 2024

AUTORITETI KONTRAKTOR:
 BASHKIA TIRANË

PROJEKTUESI: "VAANTE KONSTRUKSION" SH.P.A. & "FOCUS ARCHITECTURE" SH.P.A.

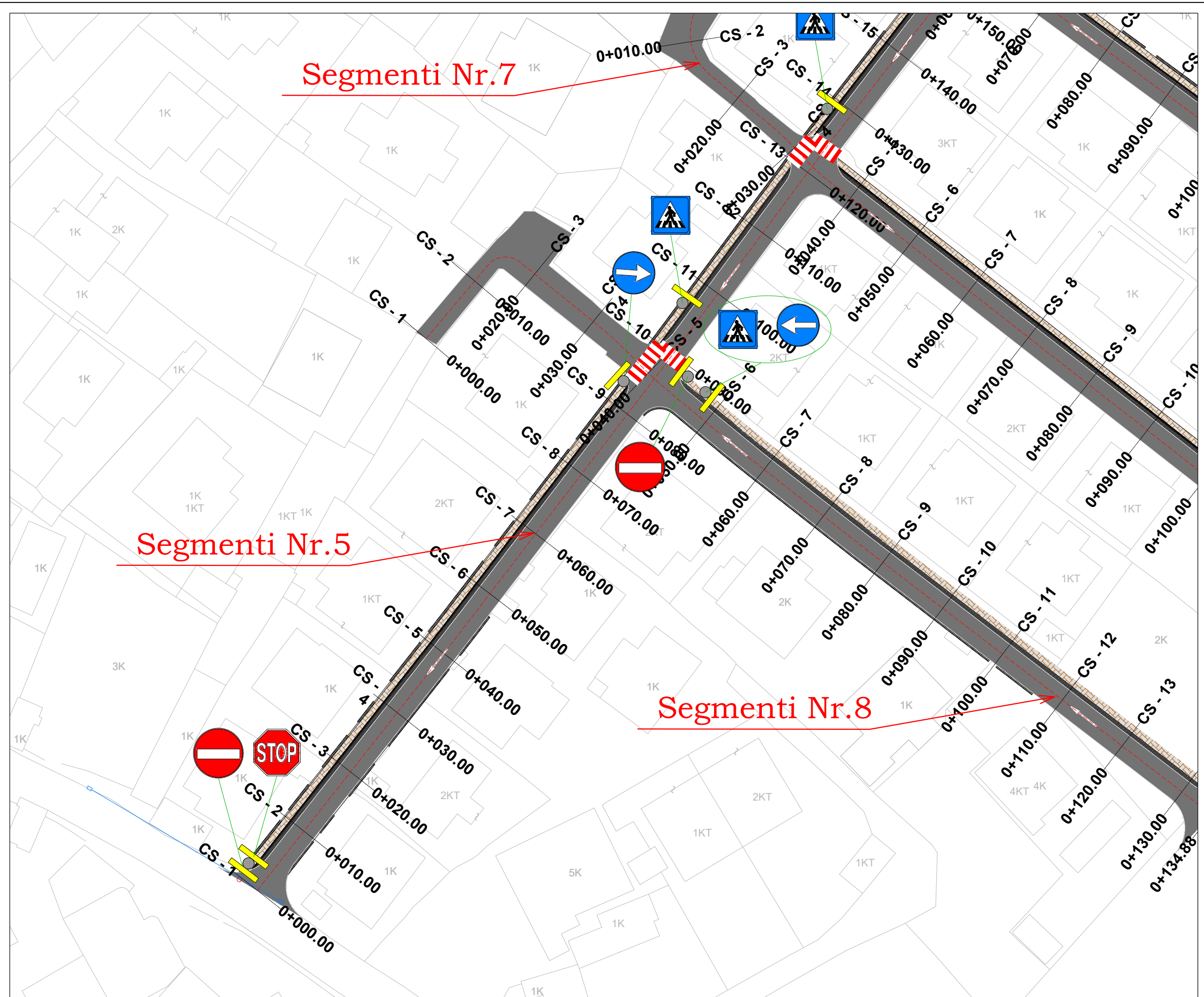

TITULLI I PROJEKTIT

“Rikualifikim Blloku qe Kufizohet nga Rruget "Haxhi Xhuzi" - "Reze Drite" - "Halil Hoxha”

FAZA
PROJEKT ZBATIM

LEGJENDA

	SIPERFAQE ME ASFALT
	KUNETË
	TROTUAR
	MUR I RI
	VIJAT PER KALIM KEMBESORËSH

PLANIMETRIA E SINJALISTIKËS

EMËRTIMI I FLETËS **Aksi 5**
 SHKALLA **1:500**
 NUMRI I FLETËS **T-101**
 2024

AUTORITETI KONTRAKTOR:
 BASHKIA TIRANË



PROJEKTUESI: "VAANTE KONSTRUKSION" SH.P.A. & "FOCUS ARCHITECTURE" SH.P.A.

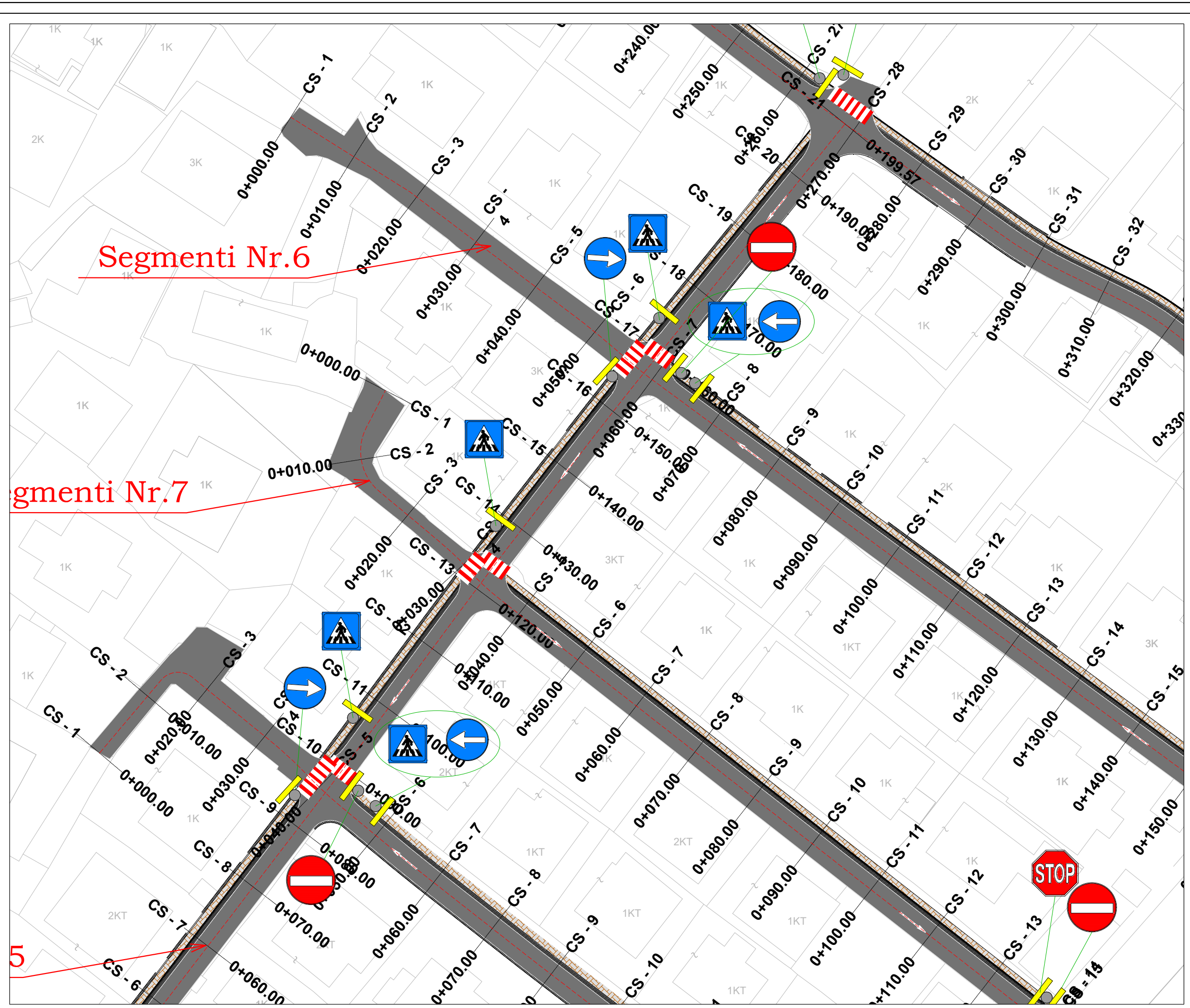

TITULLI I PROJEKTIT

“Rikualifikim Blloku qe Kufizohet nga Rruget "Haxhi Xhuzi" - "Reze Drite" - "Halil Hoxha”

FAZA
PROJEKT ZBATIM

LEGJENDA

- SIPERFACE ME ASFALT
- KUNETË
- TROTUAR
- MUR I RI
- VIJAT PER KALIM KEMBESORËSH

PLANIMETRIA E SINJALISTIKËS

EMËRTIMI I FLETËS **Aksi 5**
 SHKALLA **1:500**
 NUMRI I FLETËS **T-102**
 2024

AUTORITETI KONTRAKTOR:
 BASHKIA TIRANË



PROJETUESI: "VAANTE KONSTRUKSION" SH.P.A. & "FOCUS ARCHITETURE" SH.P.A.



MENYRA E VENDOSJES SE TABELAVE RRUGORE

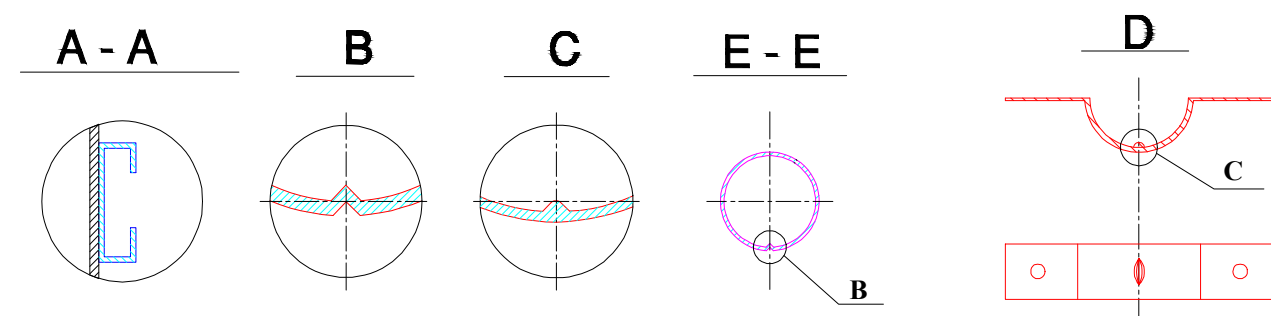
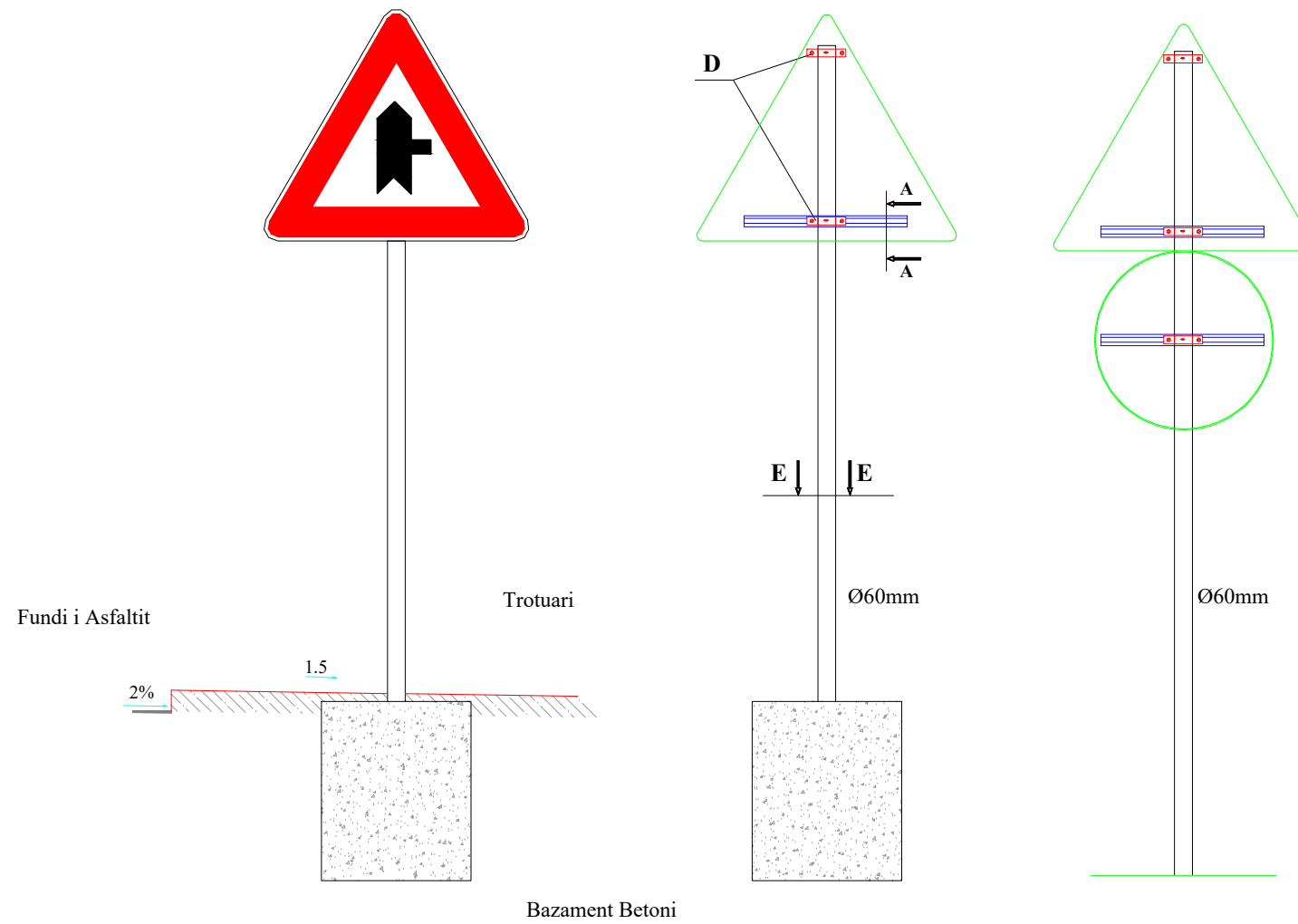

TITULLI I PROJEKTIT

“Rikualifikim Blloku qe Kufizohet nga Rruget "Haxhi Xhuzi" - "Reze Drite" - "Halil Hoxha”

FAZA

PROJEKT ZBATIM

DETAJET E SINJALISTIKËS

EMËRTIMI I FLETËS

SHKALLA

NUMRI I FLETËS

T-103

2024

AUTORITETI KONTRAKTOR:
BASHKIA TIRANË



PROJEKTUESI: "MANTE KONSTRUKSION" SH.P.A. & "FOCUS ARCHITECTURE" SH.P.A.



SHENJAT NDALUESE

Kufizim maksimal i shpejtësisë



Ndalim parakalimi



Fundi i kufizimit të shpejtësisë



SINJALET E RREZIKUT

Kthesë



Vendkalim kembësorësh



SINJALET E PERPARESISE

Kryqëzim me të drejtë perparësie



Ndalim parakalimi

Fundi i kufizimit të shpejtësisë

Ndal dhe jep perparësi

E drejtë perparësie

Sinjalet E Drejtimit

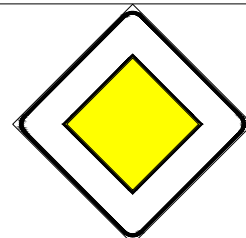

PERMASAT E SHENJAVE RRUGORE

Shenje kuadratike

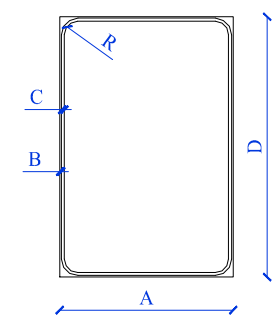

A	B	C	D	R
65	0.4	0.8	95	3

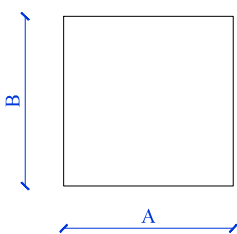

A	B
60	60

Modular i shenjave trekëndore

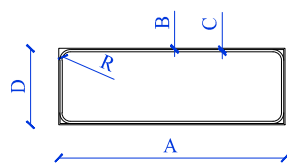

A	B	C	D	R
80	0.4	0.8	27	3

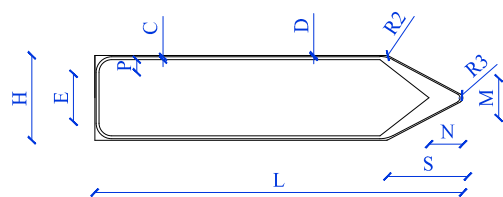

C	D	E	H	L	M
1	0.5	17	30	130	14
N	R1	R2	R3	P	M
12	6	10	1.5	5	28.5

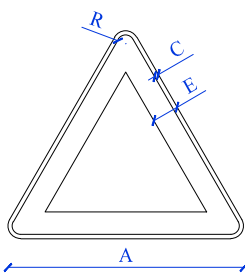

A	C	E	R
90	1.5	8	4.5

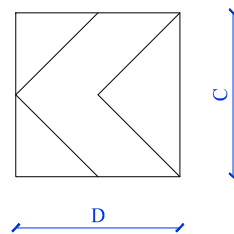

C	D
Dim vogel	60
	60

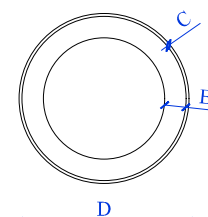

C	D	E
1	60	7.5

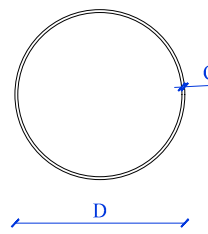

C	D
Dim vogel	1
	60
	0.8
	40

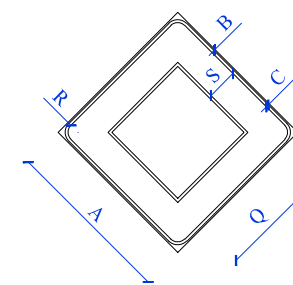

A	B	C	Q	R	S
60	0.5	1	40	3.5	1.1

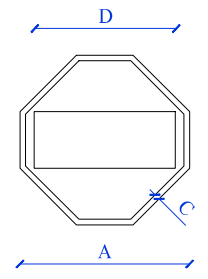

A	B	C	D
Dim vogel	90	30	3
	60	20	2
			75
			50

TITULLI I PROJEKTIT

"Rikualifikim Blloku qe Kufizohet nga Rruget "Haxhi Xhuzi" - "Reze Drite" - "Halil Hoxha"

FAZA

PROJEKT ZBATIM

DETAJET E SINJALISTIKËS

EMËRTIMI I FLETËS

SHKALLA

NUMRI I FLETËS

T-104

2024

AUTORITETI KONTRAKTOR:
BASHKIA TIRANË



PROJEKTUESI: "VANTE KONSTRUKSION" SH.P.A. & "FOCUS ARCHITECTURE" SH.P.A.



DIMENSIONET E SHIGJETAVE TE DREJTIMIT TE LEVIZJES

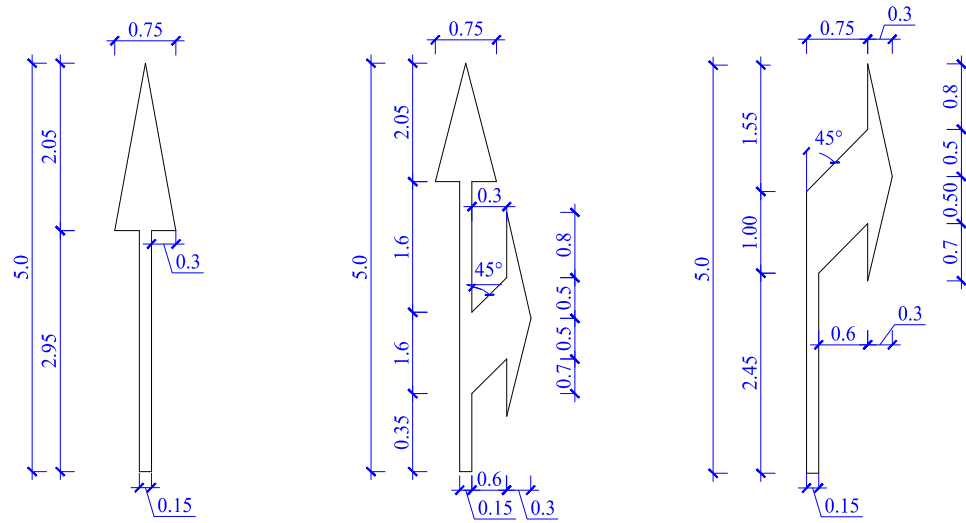

KALIMET E KEMBESOREVE

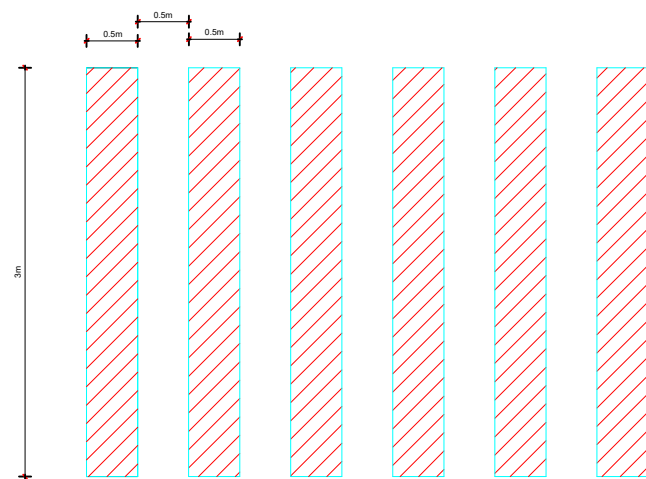

TIPET E VIZIMEVE TE RRUGES

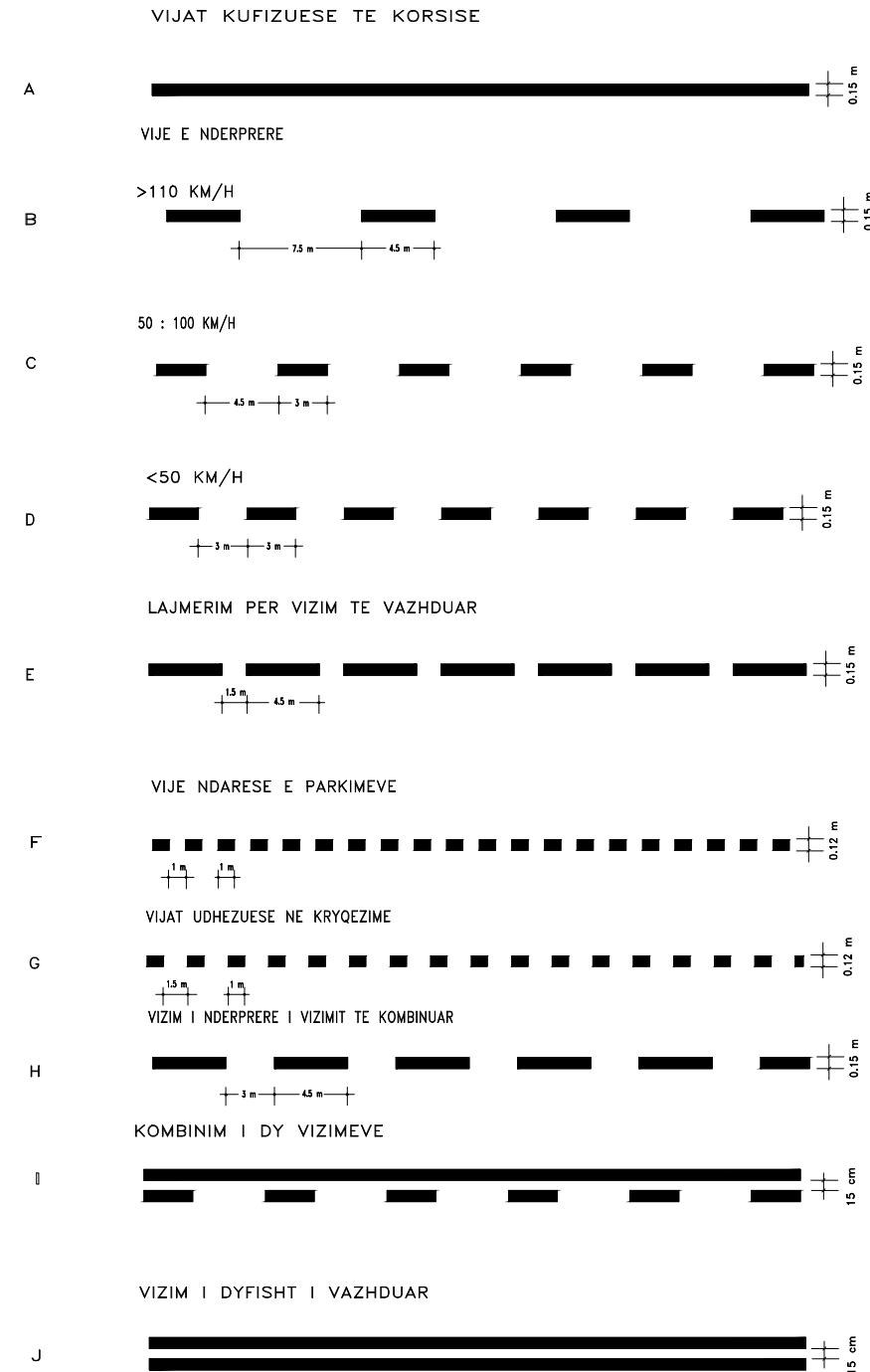

TITULLI I PROJEKTIT

“Rikualifikim Blloku qe Kufizohet nga Rruget "Haxhi Xhuzi" - "Reze Drite" - "Halil Hoxha”

FAZA

PROJEKT ZBATIM

DETAJET E SINJALISTIKËS

EMËRTIMI I FLETËS

SHKALLA

NUMRI I FLETËS

T-105

2024

AUTORITETI KONTRAKTOR:
BASHKIA TIRANË



PROJEKTUESI: "VAANTE KONSTRUKSION" SH.P.K. & "FOCUS ARCHITECTURE" SH.P.K.

