



MIRATOHET
KRYETAR
z.Andis SALLA

REPUBLIKA E SHQIPËRISË
BASHKIA CËRRIK

PROJEKT ZBATIMI

OBJEKTI:STUDIM, PROJEKTIM I RRUGEVE RURALE NE NJ.A SHALES

Nenobjekti:Rikonstruksioni i rruges Lazarec, Fshati Licaj



Projektues: **ZetaKonsult sh.p.k**

Address:Rr."Myrteza Topi",Nd 18, Hyrja 7, Ap 38, TIRANE

Cel:+355 (0)69 33 52 077

e-mail:zetakonsultshpk@gmail.com

TIRANE 2022

AZHORNIMI TOPOGRAFIK SH 1:1000



LEGJENDE:

- RRUGE ME ASFALT
- RRUGE EKZISTUESE
- MURE RRETHUES
- MATJET TOPOGRAFIKE
- TOMBINO EKZISTUESE
- OBJEKT
- SHTYLLE ELEKTRIKE
- RRETHIM
- URE

INVESTITOR
BASHKIA ÇËRRIK



ZetaKonsult sh.p.k
 Address:Rr."Myrteza Topi",Nd 18, Hyrja 7, Ap 38, TIRANE
 Cel: +355 (0)69 33 52 077
 e-mail:zetakonsultshpk@gmail.com



EMERTIMI I OBJEKTIT:
 STUDIM, PROJEKTIM I RRUGEVE RURALE NE NJ.A SHALES
Rikonstruksioni i rruges Lazarec, Fshati Licaj

FAZA E PROJEKTIT :PROJEKT ZBATIMI

EMERTESA E FLETES:
 AZHORNIMI TOPOGRAFIK

SHKALLA Shk:1/1000 FLETA 01

DREJTOR PROJEKTI: Ing. Flutura DURO
 Inxh.Ndert.Flutura Duro
 Inxh.Ndert.Lorenc HOXHA

Dt. ___/___/2022

FORMATI A3

AZHORNIMI TOPOGRAFIK SH 1:1000

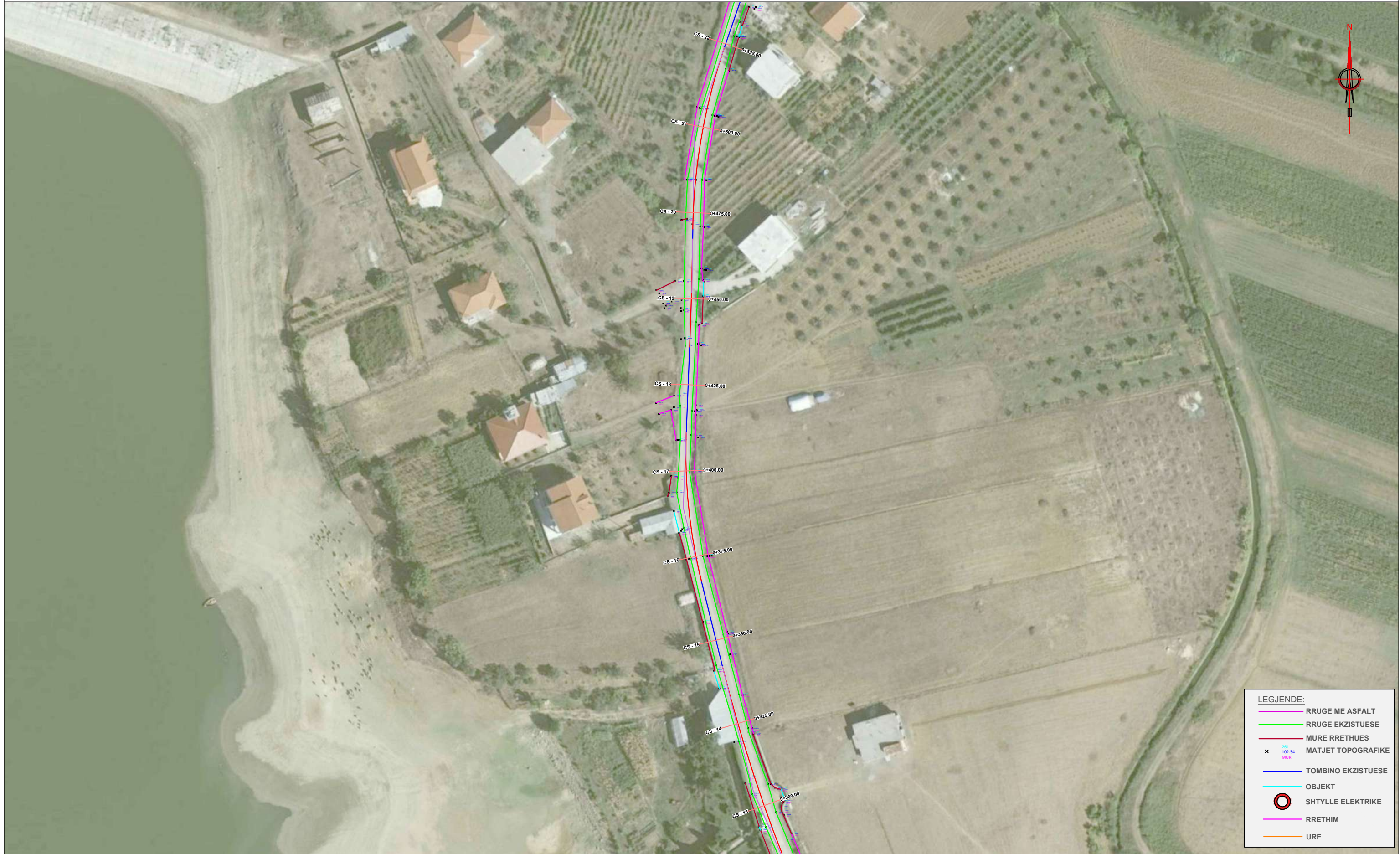

LEGJENDE:

	RRUGE ME ASFALT
	RRUGE EKZISTUESE
	MURE RRETHUES
	MATJET TOPOGRAFIKE
	TOMBINO EKZISTUESE
	OBJEKT
	SHTYLLE ELEKTRIKE
	RRETHIM
	URE

INVESTITOR
BASHKIA ÇËRRIK



ZetaKonsult sh.p.k
 Address:Rr."Myrteza Topi",Nd 18, Hyrja 7, Ap 38, TIRANE
 Cel: +355 (0)69 33 52 077
 e-mail:zetakonsultshpk@gmail.com



EMERTIMI I OBJEKTIT:
 STUDIM, PROJEKTIM I RRUGEVE RURALE NE NJ.A SHALES
 Rikonstruksioni i rruges Lazarec, Fshati Licaj

FAZA E PROJEKTIT :PROJEKT ZBATIMI

EMERTESA E FLETES:
 AZHORNIMI TOPOGRAFIK

SHKALLA Shk:1/1000 FLETA 02

DREJTOR PROJEKTI: Ing. Flutura DURO
 Inxh.Ndert.Flutura Duro
 Inxh.Ndert.Lorenc HOXHA

Dt ___/___/2022

FORMATI A3

AZHORNIMI TOPOGRAFIK SH 1:1000



LEGJENDE:

- RRUGE ME ASFALT
- RRUGE EKZISTUESE
- MURE RRETHUES
- x MATJET TOPOGRAFIKE
- TOMBINO EKZISTUESE
- OBJEKT
- SHTYLLE ELEKTRIKE
- RRETHIM
- URE

INVESTITOR
BASHKIA ÇËRRIK



ZetaKonsult sh.p.k
 Address:Rr."Myrteza Topi",Nd 18, Hyrja 7, Ap 38, TIRANE
 Cel: +355 (0)69 33 52 077
 e-mail:zetakonsultshpk@gmail.com



EMERTIMI I OBJEKTIT:
 STUDIM, PROJEKTIM I RRUGEVE RURALE NE NJ.A SHALES
 Rikonstruksioni i rruges Lazarec, Fshati Licaj

FAZA E PROJEKTIT :PROJEKT ZBATIMI

EMERTESA E FLETES:
 AZHORNIMI TOPOGRAFIK

SHKALLA Shk:1/1000 FLETA 03

DREJTOR PROJEKTI: Ing. Flutura DURO
 Inxh.Ndert.Flutura Duro
 Inxh.Ndert.Lorenc HOXHA

Dt ___/___/2022

FORMATI A3

AZHORNIMI TOPOGRAFIK SH 1:1000



LEGJENDE:

	RRUGE ME ASFALT
	RRUGE EKZISTUESE
	MURE RRETHUES
	MATJET TOPOGRAFIKE
	TOMBINO EKZISTUESE
	OBJEKT
	SHTYLLE ELEKTRIKE
	RRETHIM
	URE

INVESTITOR
BASHKIA ÇËRRIK



ZetaKonsult sh.p.k
 Address:Rr."Myrteza Topi",Nd 18, Hyrja 7, Ap 38, TIRANE
 Cel: +355 (0)69 33 52 077
 e-mail:zetakonsultshpk@gmail.com



EMERTIMI I OBJEKTIT:
 STUDIM, PROJEKTIM I RRUGEVE RURALE NE NJ.A SHALES
 Rikonstruksioni i rruges Lazarec, Fshati Licaj

FAZA E PROJEKTIT :PROJEKT ZBATIMI

EMERTESA E FLETES:
 AZHORNIMI TOPOGRAFIK

SHKALLA Shk:1/1000 FLETA 04

DREJTOR PROJEKTI: Ing. Flutura DURO
 Inxh.Ndert.Flutura Duro
 Inxh.Ndert.Lorenc HOXHA

Dt ___/___/2022

FORMATI A3

AZHORNIMI TOPOGRAFIK SH 1:1000



LEGJENDE:

	RRUGE ME ASFALT
	RRUGE EKZISTUESE
	MURE RRETHUES
	MATJET TOPOGRAFIKE
	TOMBINO EKZISTUESE
	OBJEKT
	SHTYLLE ELEKTRIKE
	RRETHIM
	URE

INVESTITOR
BASHKIA ÇËRRÏK



ZetaKonsult sh.p.k
 Address:Rr."Myrteza Topi",Nd 18, Hyrja 7, Ap 38, TIRANE
 Cel: +355 (0)69 33 52 077
 e-mail:zetakonsultshpk@gmail.com



EMERTIMI I OBJEKTIT:
 STUDIM, PROJEKTIM I RRUGEVE RURALE NE NJ.A SHALES
 Rikonstruksioni i rruges Lazarec, Fshati Licaj

FAZA E PROJEKTIT :PROJEKT ZBATIMI

EMERTESA E FLETES:
 AZHORNIMI TOPOGRAFIK

SHKALLA Shk:1/1000 FLETA 05

DREJTOR PROJEKTI: Ing. Flutura DURO
 Inxh.Ndert.Flutura Duro
 Inxh.Ndert.Lorenc HOXHA

Dt ___/___/2022

FORMATI A3

AZHORNIMI TOPOGRAFIK SH 1:1000



LEGJENDE:

- RRUGE ME ASFALT
- RRUGE EKZISTUESE
- MURE RRETHUES
- x MATJET TOPOGRAFIKE
- TOMBINO EKZISTUESE
- OBJEKT
- SHTYLLE ELEKTRIKE
- RRETHIM
- URE

INVESTITOR
BASHKIA ÇËRRIK



ZetaKonsult sh.p.k
 Address:Rr."Myrteza Topi",Nd 18, Hyrja 7, Ap 38, TIRANE
 Cel: +355 (0)69 33 52 077
 e-mail:zetakonsultshpk@gmail.com



EMERTIMI I OBJEKTIT:
 STUDIM, PROJEKTIM I RRUGEVE RURALE NE NJ.A SHALES
 Rikonstruksioni i rruges Lazarec, Fshati Licaj

FAZA E PROJEKTIT :PROJEKT ZBATIMI

EMERTESA E FLETES:
 AZHORNIMI TOPOGRAFIK

SHKALLA Shk:1/1000 FLETA 06

DREJTOR PROJEKTI: Ing. Flutura DURO
 Inxh.Ndert.Flutura Duro
 Inxh.Ndert.Lorenc HOXHA

Dt ___/___/2022

FORMATI A3

HOROGRAFIA E RRUGES SH 1:2500



INVESTITOR
BASHKIA ÇËRRIK



ZetaKonsult sh.p.k

Address:Rr."Myrteza Topi",Nd 18, Hyrja 7, Ap 38, TIRANE

Cel:+355 (0)69 33 52 077

e-mail:zetakonsultshpk@gmail.com



EMERTIMI I OBJEKTIT:
STUDIM, PROJEKTIM I RRUGEVE RURALE NE NJ.A SHALES
Rikonstruksioni i rruges Lazarec, Fshati Licaj

FAZA E PROJEKTIT :PROJEKT ZBATIMI

EMERTESA E FLETES:
HOROGRAFIA E RRUGES

SHKALLA Shk:1/2500

FLETA 01

DREJTOR PROJEKTI: Ing. Flutura DURO

Inxh.Ndert.Flutura Duro
Inxh.Ndert.Lorenc HOXHA

Dt ___/___/2022

FORMATI A3

PLANIMETRIA E RRUGES SH 1:500

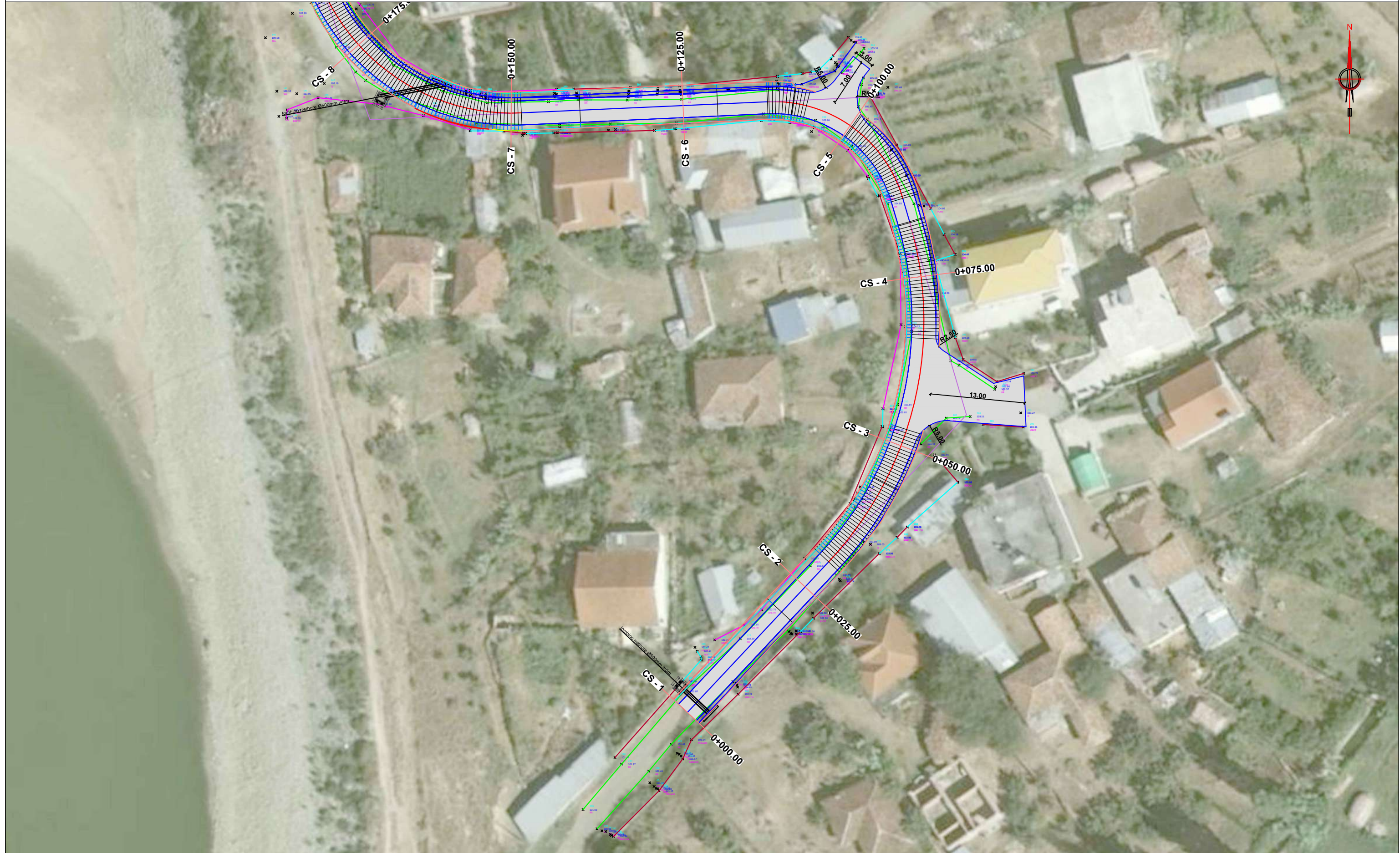

INVESTITOR
BASHKIA ÇËRRIK



ZetaKonsult sh.p.k

Address:Rr."Myrteza Topi",Nd 18, Hyrja 7, Ap 38, TIRANE

Cel:+355 (0)69 33 52 077

e-mail:zetakonsultshpk@gmail.com



EMERTIMI I OBJEKTIT:
STUDIM, PROJEKTIM I RRUGEVE RURALE NE NJ.A SHALES
Rikonstruksioni i rruges Lazarec, Fshati Licaj

FAZA E PROJEKTIT :PROJEKT ZBATIMI

EMERTESA E FLETES:
PLANIMETRIA E RRUGES

SHKALLA Shk:1/500

FLETA 02

DREJTOR PROJEKTI: Ing. Flutura DURO

Inxh.Ndert.Flutura Duro
Inxh.Ndert.Lorenc HOXHA

Dt ___/___/2022

FORMATI A3

PLANIMETRIA E RRUGES SH 1:500



INVESTITOR
BASHKIA ÇËRRIK



ZetaKonsult sh.p.k
 Address:Rr."Myrteza Topi",Nd 18, Hyrja 7, Ap 38, TIRANE
 Cel:+355 (0)69 33 52 077
 e-mail:zetakonsultshpk@gmail.com



EMERTIMI I OBJEKTIT:
 STUDIM, PROJEKTIM I RRUGEVE RURALE NE NJ.A SHALES
 Rikonstruksioni i rruges Lazarec, Fshati Licaj

FAZA E PROJEKTIT :PROJEKT ZBATIMI

EMERTESA E FLETES:
 PLANIMETRIA E RRUGES

SHKALLA Shk:1/500 FLETA 03

DREJTOR PROJEKTI: Ing. Flutura DURO
 Inxh.Ndert.Flutura Duro
 Inxh.Ndert.Lorenc HOXHA

Dt ___/___/2022

FORMATI A3

PLANIMETRIA E RRUGES SH 1:500

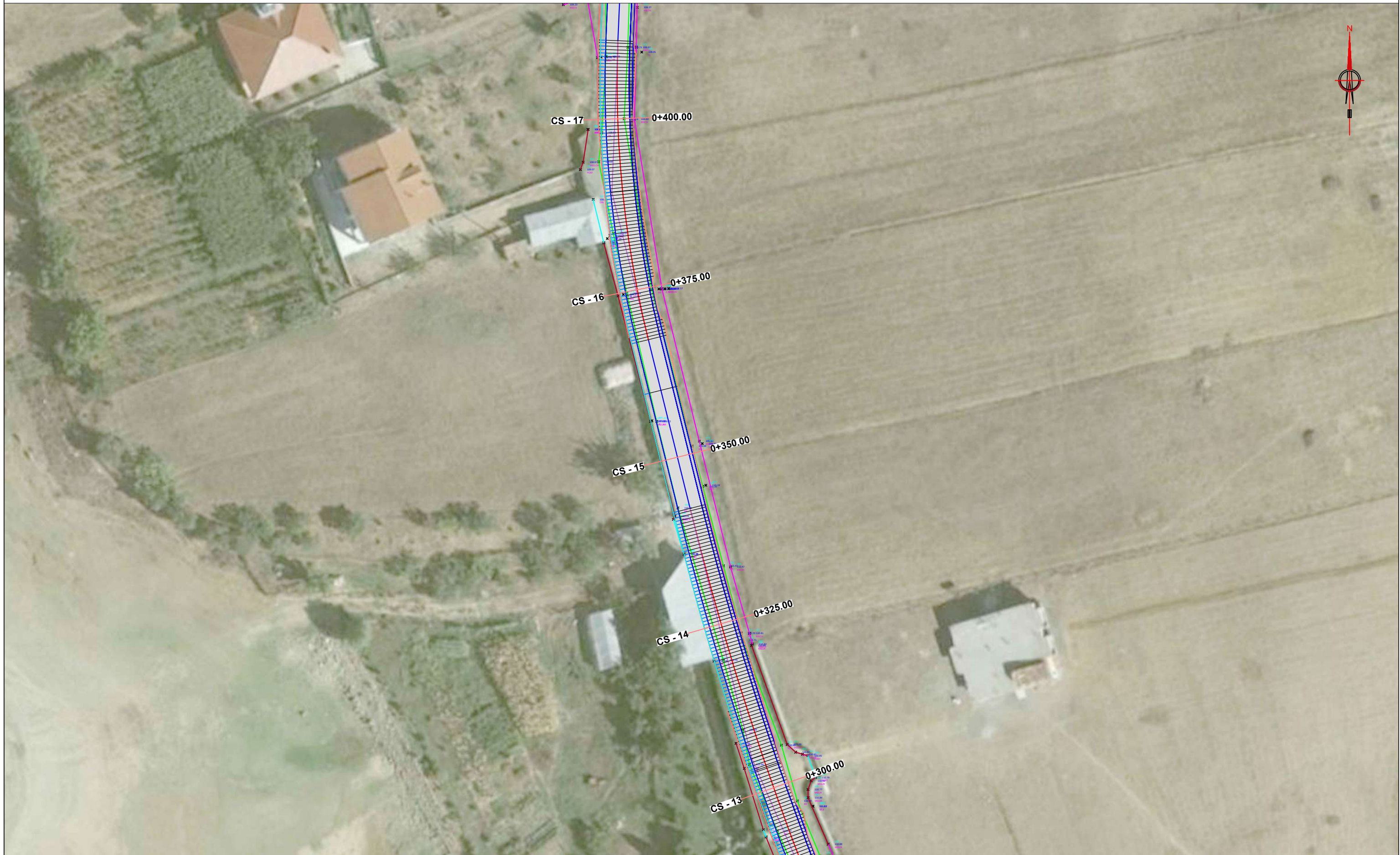

INVESTITOR
BASHKIA ÇËRRIK



ZetaKonsult sh.p.k

Address:Rr."Myrteza Topi",Nd 18, Hyrja 7, Ap 38, TIRANE

Cel:+355 (0)69 33 52 077

e-mail:zetakonsultshpk@gmail.com



EMERTIMI I OBJEKTIT:
STUDIM, PROJEKTIM I RRUGEVE RURALE NE NJ.A SHALES
Rikonstruksioni i rruges Lazarec, Fshati Licaj

FAZA E PROJEKTIT :PROJEKT ZBATIMI

EMERTESA E FLETES:
PLANIMETRIA E RRUGES

SHKALLA Shk:1/500

FLETA 04

DREJTOR PROJEKTI: Ing. Flutura DURO

Inxh.Ndert.Flutura Duro
Inxh.Ndert.Lorenc HOXHA

Dt ___/___/2022

FORMATI A3

PLANIMETRIA E RRUGES SH 1:500



INVESTITOR
BASHKIA ÇËRRÏK



ZetaKonsult sh.p.k

Address:Rr."Myrteza Topi",Nd 18, Hyrja 7, Ap 38, TIRANE

Cel:+355 (0)69 33 52 077

e-mail:zetakonsultshpk@gmail.com



EMERTIMI I OBJEKTIT:
STUDIM, PROJEKTIM I RRUGEVE RURALE NE NJ.A SHALES
Rikonstruksioni i rruges Lazarec, Fshati Licaj

FAZA E PROJEKTIT :PROJEKT ZBATIMI

EMERTESA E FLETES:
PLANIMETRIA E RRUGES

SHKALLA Shk:1/500

FLETA 05

DREJTOR PROJEKTI: Ing. Flutura DURO

Inxh.Ndert.Flutura Duro
Inxh.Ndert.Lorenc HOXHA

Dt ___/___/2022

FORMATI A3

PLANIMETRIA E RRUGES SH 1:500



INVESTITOR
BASHKIA ÇËRRIK



ZetaKonsult sh.p.k

Address:Rr."Myrteza Topi",Nd 18, Hyrja 7, Ap 38, TIRANE

Cel:+355 (0)69 33 52 077

e-mail:zetakonsultshpk@gmail.com



EMERTIMI I OBJEKTIT:
STUDIM, PROJEKTIM I RRUGEVE RURALE NE NJ.A SHALES
Rikonstruksioni i rruges Lazarec, Fshati Licaj

FAZA E PROJEKTIT :PROJEKT ZBATIMI

EMERTESA E FLETES:
PLANIMETRIA E RRUGES

SHKALLA Shk:1/500

FLETA 06

DREJTOR PROJEKTI: Ing. Flutura DURO

Inxh.Ndert.Flutura Duro
Inxh.Ndert.Lorenc HOXHA

Dt ___/___/2022

FORMATI A3

PLANIMETRIA E RRUGES SH 1:500



INVESTITOR
BASHKIA ÇËRRIK



ZetaKonsult sh.p.k

Address:Rr."Myrteza Topi",Nd 18, Hyrja 7, Ap 38, TIRANE

Cel:+355 (0)69 33 52 077

e-mail:zetakonsultshpk@gmail.com



EMERTIMI I OBJEKTIT:
STUDIM, PROJEKTIM I RRUGEVE RURALE NE NJ.A SHALES
Rikonstruksioni i rruges Lazarec, Fshati Licaj

FAZA E PROJEKTIT :PROJEKT ZBATIMI

EMERTESA E FLETES:
PLANIMETRIA E RRUGES

SHKALLA Shk:1/500

FLETA 07

DREJTOR PROJEKTI: Ing. Flutura DURO

Inxh.Ndert.Flutura Duro
Inxh.Ndert.Lorenc HOXHA

Dt ___/___/2022

FORMATI A3

PLANIMETRIA E RRUGES SH 1:500



INVESTITOR
BASHKIA ÇËRRIK



ZetaKonsult sh.p.k

Address:Rr."Myrteza Topi",Nd 18, Hyrja 7, Ap 38, TIRANE

Cel:+355 (0)69 33 52 077

e-mail:zetakonsultshpk@gmail.com



EMERTIMI I OBJEKTIT:
STUDIM, PROJEKTIM I RRUGEVE RURALE NE NJ.A SHALES
Rikonstruksioni i rruges Lazarec, Fshati Licaj

FAZA E PROJEKTIT :PROJEKT ZBATIMI

EMERTESA E FLETES:
PLANIMETRIA E RRUGES

SHKALLA Shk:1/500

FLETA 08

DREJTOR PROJEKTI: Ing. Flutura DURO

Inxh.Ndert.Flutura Duro
Inxh.Ndert.Lorenc HOXHA

Dt ___/___/2022

FORMATI A3

PLANIMETRIA E RRUGES SH 1:500



INVESTITOR
BASHKIA ÇËRRIK



ZetaKonsult sh.p.k

Address:Rr."Myrteza Topi",Nd 18, Hyrja 7, Ap 38, TIRANE

Cel: +355 (0)69 33 52 077

e-mail:zetakonsultshpk@gmail.com



EMERTIMI I OBJEKTIT:
STUDIM, PROJEKTIM I RRUGEVE RURALE NE NJ.A SHALES
Rikonstruksioni i rruges Lazarec, Fshati Licaj

FAZA E PROJEKTIT :PROJEKT ZBATIMI

EMERTESA E FLETES:
PLANIMETRIA E RRUGES

SHKALLA Shk:1/500

FLETA 09

DREJTOR PROJEKTI: Ing. Flutura DURO

Inxh.Ndert.Flutura Duro
Inxh.Ndert.Lorenc HOXHA

Dt ___/___/2022

FORMATI A3

PLANIMETRIA E RRUGES SH 1:500



INVESTITOR
BASHKIA ÇËRRIK



ZetaKonsult sh.p.k

Address:Rr."Myrteza Topi",Nd 18, Hyrja 7, Ap 38, TIRANE

Cel:+355 (0)69 33 52 077

e-mail:zetakonsultshpk@gmail.com



EMERTIMI I OBJEKTIT:
STUDIM, PROJEKTIM I RRUGEVE RURALE NE NJ.A SHALES
Rikonstruksioni i rruges Lazarec, Fshati Licaj

FAZA E PROJEKTIT :PROJEKT ZBATIMI

EMERTESA E FLETES:
PLANIMETRIA E RRUGES

SHKALLA Shk:1/500

FLETA 10

DREJTOR PROJEKTI: Ing. Flutura DURO

Inxh.Ndert.Flutura Duro
Inxh.Ndert.Lorenc HOXHA

Dt ___/___/2022

FORMATI A3

PLANIMETRIA E RRUGES SH 1:500

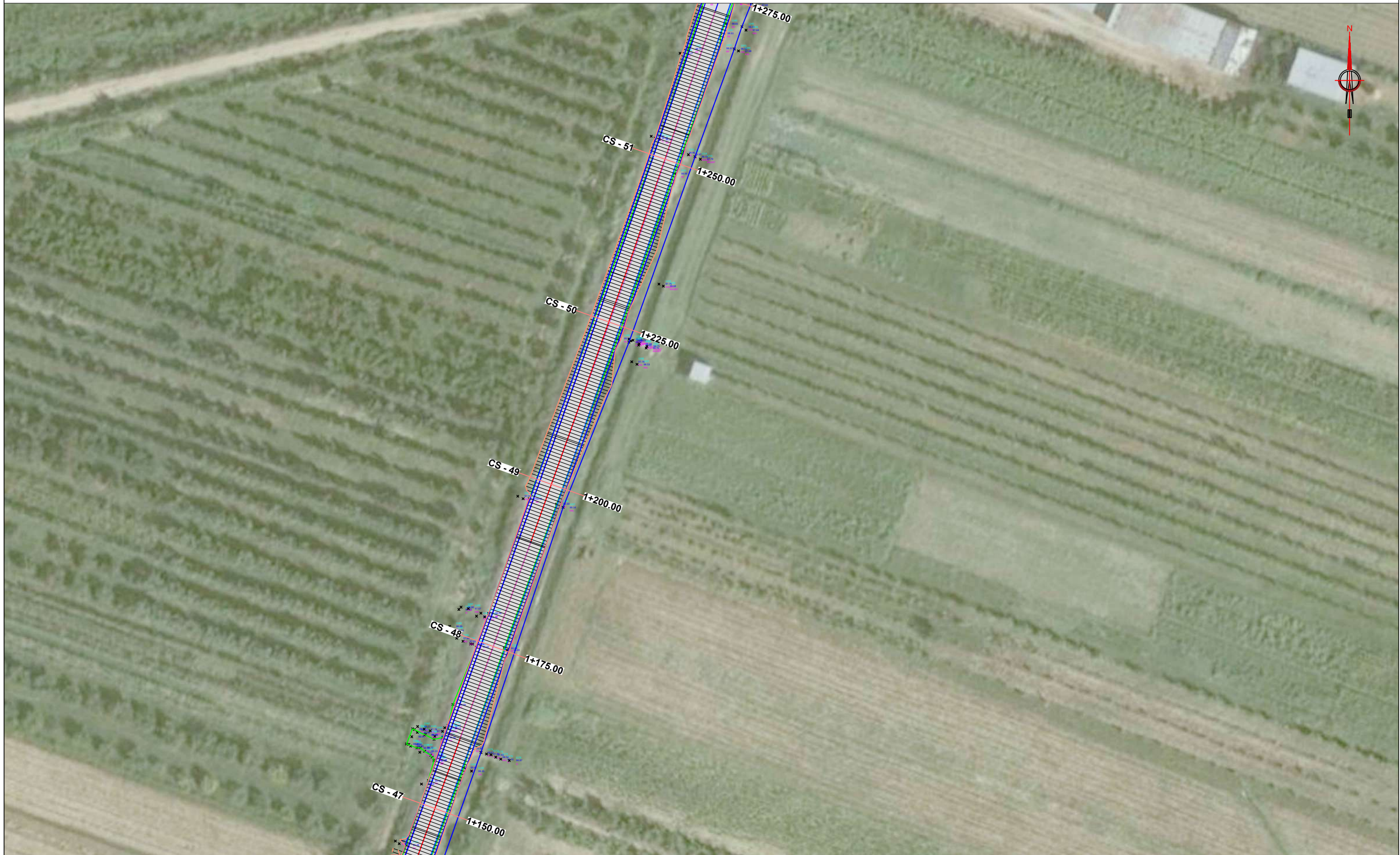

INVESTITOR
BASHKIA ÇËRRIK



ZetaKonsult sh.p.k

Address:Rr."Myrteza Topi",Nd 18, Hyrja 7, Ap 38, TIRANE

Cel:+355 (0)69 33 52 077

e-mail:zetakonsultshpk@gmail.com



EMERTIMI I OBJEKTIT:
STUDIM, PROJEKTIM I RRUGEVE RURALE NE NJ.A SHALES
Rikonstruksioni i rruges Lazarec, Fshati Licaj

FAZA E PROJEKTIT :PROJEKT ZBATIMI

EMERTESA E FLETES:
PLANIMETRIA E RRUGES

SHKALLA Shk:1/500

FLETA 11

DREJTOR PROJEKTI: Ing. Flutura DURO

Inxh.Ndert.Flutura Duro
Inxh.Ndert.Lorenc HOXHA

Dt ___/___/2022

FORMATI A3

PLANIMETRIA E RRUGES SH 1:500



INVESTITOR BASHKIA ÇËRRIK 	ZetaKonsult sh.p.k Address:Rr."Myrteza Topi",Nd 18, Hyrja 7, Ap 38, TIRANE Cel: +355 (0)69 33 52 077 e-mail:zetakonsultshpk@gmail.com 	EMERTIMI I OBJEKTIT: STUDIM, PROJEKTIM I RRUGEVE RURALE NE NJ.A SHALES Rikonstruksioni i rruges Lazarec, Fshati Licaj		EMERTESA E FLETES: PLANIMETRIA E RRUGES		DREJTOR PROJEKTI: Ing. Flutura DURO		Dt ___/___/2022
		FAZA E PROJEKTIT :PROJEKT ZBATIMI		SHKALLA Shk:1/500	FLETA 12	Inxh.Ndert.Flutura Duro Inxh.Ndert.Lorenc HOXHA		FORMATI A3

PLANIMETRIA E RRUGES SH 1:500



INVESTITOR
BASHKIA ÇËRRIK



ZetaKonsult sh.p.k

Address:Rr."Myrteza Topi",Nd 18, Hyrja 7, Ap 38, TIRANE

Cel:+355 (0)69 33 52 077

e-mail:zetakonsultshpk@gmail.com



EMERTIMI I OBJEKTIT:
STUDIM, PROJEKTIM I RRUGEVE RURALE NE NJ.A SHALES
Rikonstruksioni i rruges Lazarec, Fshati Licaj

FAZA E PROJEKTIT :PROJEKT ZBATIMI

EMERTESA E FLETES:
PLANIMETRIA E RRUGES

SHKALLA Shk:1/500

FLETA 13

DREJTOR PROJEKTI: Ing. Flutura DURO

Inxh.Ndert.Flutura Duro
Inxh.Ndert.Lorenc HOXHA

Dt ___/___/2022

FORMATI A3

PROFILI GJATESOR

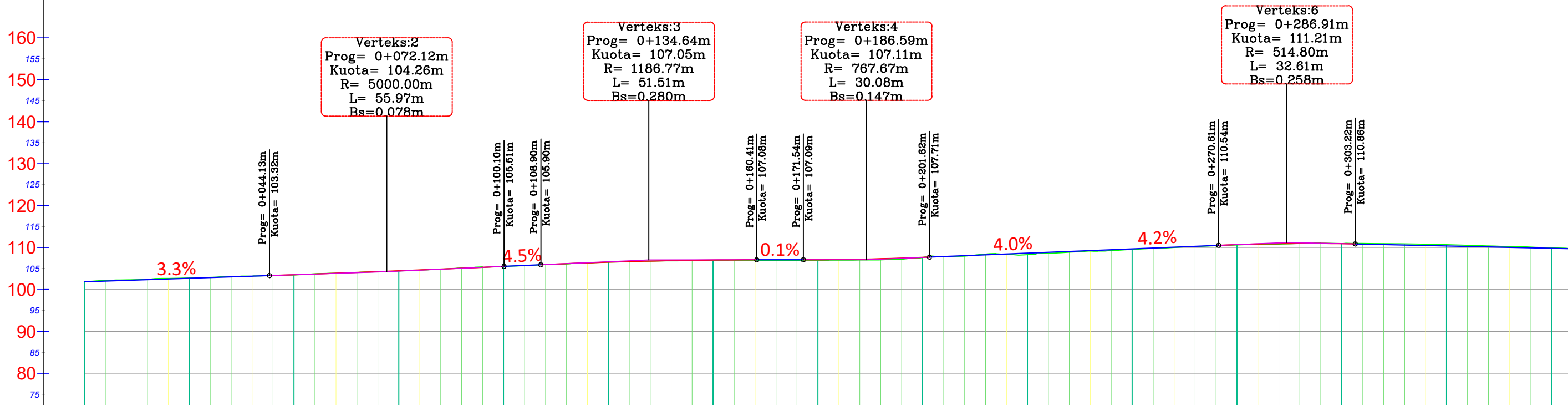

NR I PRERJES	CS - 1	CS - 2	CS - 3	CS - 4	CS - 5	CS - 6	CS - 7	CS - 8	CS - 9	CS - 10	CS - 11	CS - 12	CS - 13	CS - 14	CS - 15									
DIST. PJESORE	25.0 m	25.0 m	25.0 m	25.0 m	25.0 m	25.0 m	25.0 m	25.0 m	25.0 m	25.0 m	25.0 m	25.0 m	25.0 m	25.0 m	25.0 m									
DIST. PROGRESIVE	0+000	0+025	0+050	0+075	0+100	0+125	0+150	0+175	0+200	0+225	0+250	0+275	0+300	0+325	0+350									
KUOTA TOKES	101.84	102.75	103.47	104.42	105.52	106.51	106.92	106.97	107.64	108.30	109.54	110.61	110.95	110.70	109.95									
KUOTA PROJEKTIT	101.85	102.68	103.52	104.45	105.50	106.51	107.02	107.10	107.65	108.66	109.68	110.70	110.92	110.38	109.84									
KUOTA PUNES	0.01	-0.07	0.05	0.03	-0.02	0.00	0.10	0.13	0.01	0.36	0.13	0.09	-0.03	-0.31	-0.11									
GJEO. VERTIKALE	L=44.13 i=3.34%		R=5000.00 K=55.97		L=8.79 i=4.46%		R=1186.77 K=51.51		L=11.14 i=0.12%		R=767.67 K=30.08		L=39.92 i=4.04%		L=29.07 i=4.16%		R=514.80 K=32.61							
GJEO. HORIZONTALE	L=30.00		φ = 59°33'54" L=53.17 R=51.14		L=3.52		φ = 76°11'34" L=26.05 R=19.59		L=35.78		φ = 72°32'01" L=37.99 R=30.01		L=7.29		φ = 11°05'22" L=39.53 R=204.24		L=1.90 φ = 14°40'07" L=12.98 R=50.71		L=19.51		φ = 9°44'14" L=74.62 R=439.05		L=2	
Kilometrazhi																								

INVESTITOR
BASHKIA ÇËRRIK



ZetaKonsult sh.p.k
 Address:Rr."Myrteza Topi",Nd 18, Hyrja 7, Ap 38, TIRANE
 Cel: +355 (0)69 33 52 077
 e-mail: zetakonsultshpk@gmail.com



EMERTIMI I OBJEKTIT:
 STUDIM, PROJEKTIM I RRUGEVE RURALE NE NJ.A SHALES
Rikonstruksioni i rruges Lazarec, Fshati Licaj

FAZA E PROJEKTIT :PROJEKT ZBATIMI

EMERTESA E FLETES:
 PROFILI GJATESOR

SHKALLA Shk:1/1000 FLETA 01

DREJTOR PROJEKTI: Ing. Flutura DURO

Inxh.Ndert.Flutura Duro
Inxh.Ndert.Lorenc HOXHA

Dt. ___/___/2022

FORMATI A3

PROFILI GJATESOR

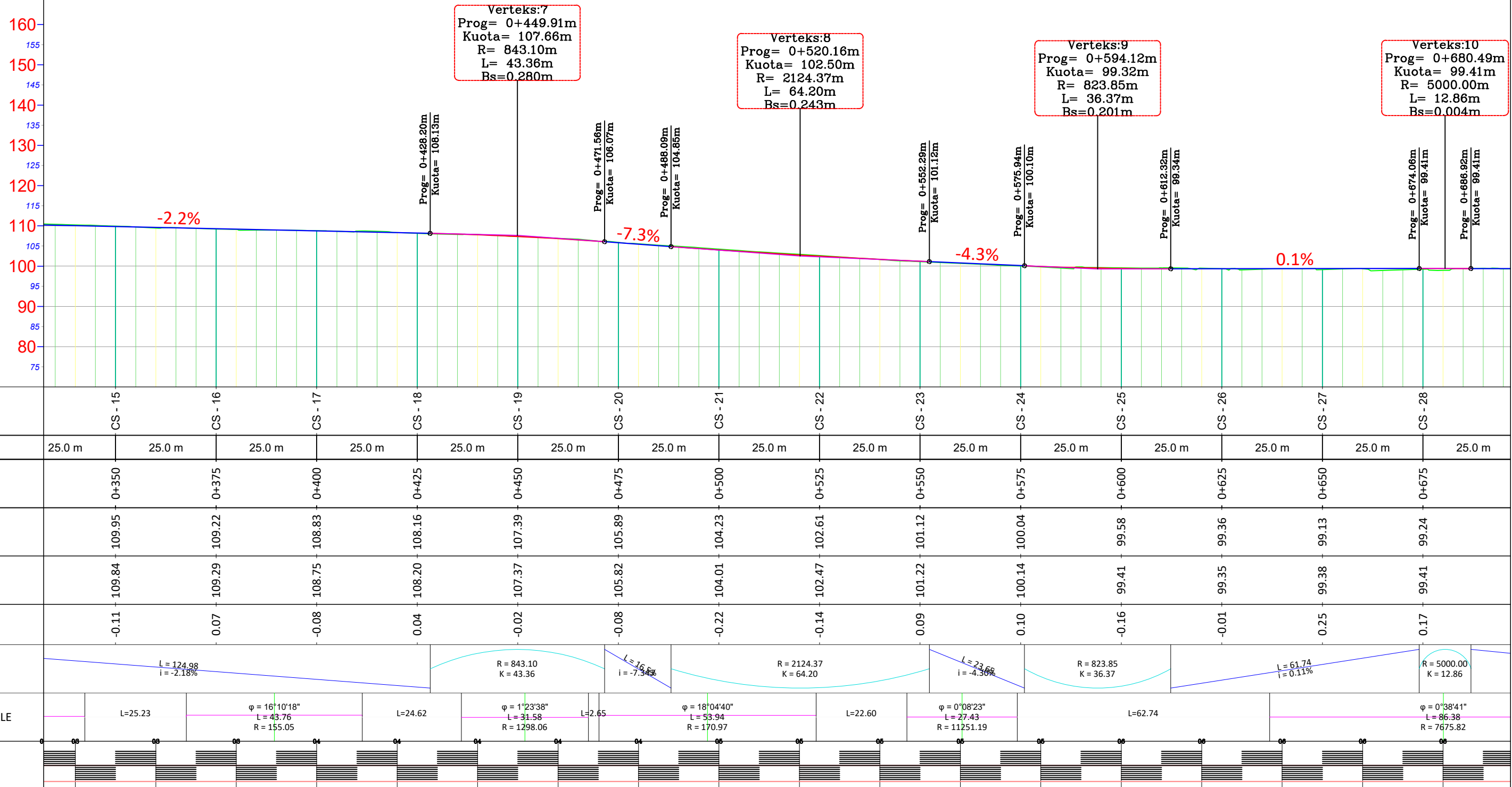

NR I PRERJES	CS - 15	CS - 16	CS - 17	CS - 18	CS - 19	CS - 20	CS - 21	CS - 22	CS - 23	CS - 24	CS - 25	CS - 26	CS - 27	CS - 28				
DIST. PJESORE	25.0 m	25.0 m	25.0 m	25.0 m	25.0 m	25.0 m	25.0 m	25.0 m	25.0 m	25.0 m	25.0 m	25.0 m	25.0 m	25.0 m				
DIST. PROGRESIVE	0+350	0+375	0+400	0+425	0+450	0+475	0+500	0+525	0+550	0+575	0+600	0+625	0+650	0+675				
KUOTA TOKES	109.95	109.22	108.83	108.16	107.39	105.89	104.23	102.61	101.12	100.04	99.58	99.36	99.13	99.24				
KUOTA PROJEKTIT	109.84	109.29	108.75	108.20	107.37	105.82	104.01	102.47	101.22	100.14	99.41	99.35	99.38	99.41				
KUOTA PUNES	-0.11	0.07	-0.08	0.04	-0.02	-0.08	-0.22	-0.14	0.09	0.10	-0.16	-0.01	0.25	0.17				
GJEO. VERTIKALE	L=124.98 i=-2.18%		R=843.10 K=43.36			L=16.48 i=-7.34%		R=2124.37 K=64.20			L=23.68 i=-4.36%		R=823.85 K=36.37		L=61.74 i=0.11%	R=5000.00 K=12.86		
GJEO. HORIZONTALE	L=25.23		φ = 16°10'18" L=43.76 R=155.05		L=24.62		φ = 1°23'38" L=31.58 R=1298.06		L=2.65		φ = 18°04'40" L=53.94 R=170.97		L=22.60		φ = 0°08'23" L=27.43 R=11251.19		L=62.74	φ = 0°38'41" L=86.38 R=7675.82
Kilometrazhi	[Scale bar showing 0 to 100m intervals]																	

INVESTITOR
BASHKIA ÇËRRIK



ZetaKonsult sh.p.k
 Address:Rr."Myrteza Topi",Nd 18, Hyrja 7, Ap 38, TIRANE
 Cel:+355 (0)69 33 52 077
 e-mail:zetakonsultshpk@gmail.com



EMERTIMI I OBJEKTIT:
 STUDIM, PROJEKTIM I RRUGEVE RURALE NE NJ.A SHALES
Rikonstruksioni i rruges Lazarec, Fshati Licaj

FAZA E PROJEKTIT :PROJEKT ZBATIMI

EMERTESA E FLETES:
 PROFILI GJATESOR

SHKALLA Shk:1/1000 FLETA 02

DREJTOR PROJEKTI: Ing. Flutura DURO

Inxh.Ndert.Flutura Duro
Inxh.Ndert.Lorenc HOXHA

Dt: ___/___/2022

FORMATI A3

PROFILI GJATESOR

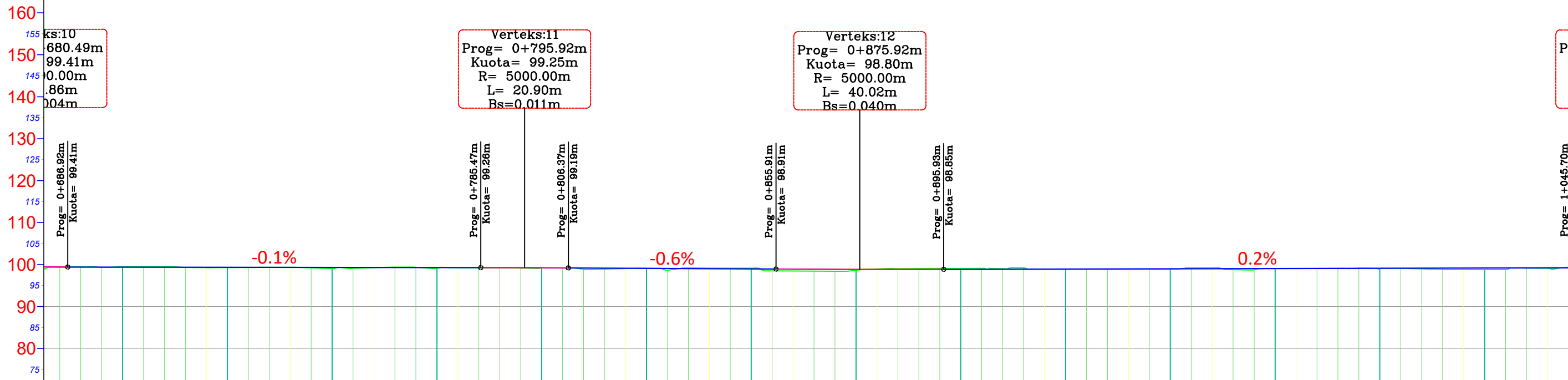

NR I PRERJES	CS - 29		CS - 30		CS - 31		CS - 32		CS - 33		CS - 34		CS - 35		CS - 36		CS - 37		CS - 38		CS - 39		CS - 40		CS - 41		CS - 42			
DIST. PJESORE	25.0 m	25.0 m	25.0 m	25.0 m	25.0 m	25.0 m	25.0 m	25.0 m	25.0 m	25.0 m	25.0 m	25.0 m	25.0 m	25.0 m	25.0 m	25.0 m	25.0 m	25.0 m	25.0 m	25.0 m	25.0 m	25.0 m	25.0 m	25.0 m	25.0 m	25.0 m	25.0 m	25.0 m		
DIST. PROGRESIVE	0+700	0+725	0+750	0+775	0+800	0+825	0+850	0+875	0+900	0+925	0+950	0+975	1+000	1+025	1+050	1+075	1+100	1+125	1+150	1+175	1+200	1+225	1+250	1+275	1+300	1+325	1+350	1+375		
KUOTA TOKES	99.53	99.26	99.00	99.06	99.20	99.11	99.15	98.62	99.06	98.89	98.87	99.03	98.99	98.81	99.39	99.35	99.32	99.28	99.22	99.09	98.95	98.84	98.86	98.92	98.98	99.04	99.10	99.16		
KUOTA PROJEKTIT	99.39	99.35	99.32	99.28	99.22	99.09	98.95	98.84	98.86	98.92	98.98	99.04	99.10	99.16	99.39	99.35	99.32	99.28	99.22	99.09	98.95	98.84	98.86	98.92	98.98	99.04	99.10	99.16		
KUOTA PUNES	-0.14	0.10	0.31	0.22	0.03	-0.02	-0.20	0.22	-0.21	0.03	0.11	0.01	0.11	0.35	-0.14	0.10	0.31	0.22	0.03	-0.02	-0.20	0.22	-0.21	0.03	0.11	0.01	0.11	0.35		
GJEO. VERTIKALE	L=98.55 i=-0.14%		R=5000.00 K=20.90		L=49.54 i=-0.56%		R=5000.00 K=40.02		L=149.77 i=0.24%																					
GJEO. HORIZONTALE	L=0.05		φ=0°05'00" L=114.40 R=78762.51		L=66.28		φ=0°00'47" L=22.60 R=99830.97		L=46.72		φ=0°18'12" L=82.78 R=15633.06																			
Kilometrazhi	[Bar chart showing stationing from 0 to 1+375]																													

INVESTITOR
BASHKIA ÇERRIK



ZetaKonsult sh.p.k
 Address:Rr."Myrteza Topi",Nd 18, Hyrja 7, Ap 38, TIRANE
 Cel:+355 (0)69 33 52 077
 e-mail:zetakonsultshpk@gmail.com



EMERTIMI I OBJEKTIT:
 STUDIM, PROJEKTIM I RRUGEVE RURALE NE NJ.A SHALES
 Rikonstruksioni i rruges Lazarec, Fshati Licaj

FAZA E PROJEKTIT :PROJEKT ZBATIMI

EMERTESA E FLETES:
 PROFILI GJATESOR

SHKALLA Shk:1/1000 FLETA 03

DREJTOR PROJEKTI: Ing. Flutura DURO

Inxh.Ndert.Flutura Duro
Inxh.Ndert.Lorenc HOXHA

Dt: ___/___/2022

FORMATI A3

PROFILI GJATESOR

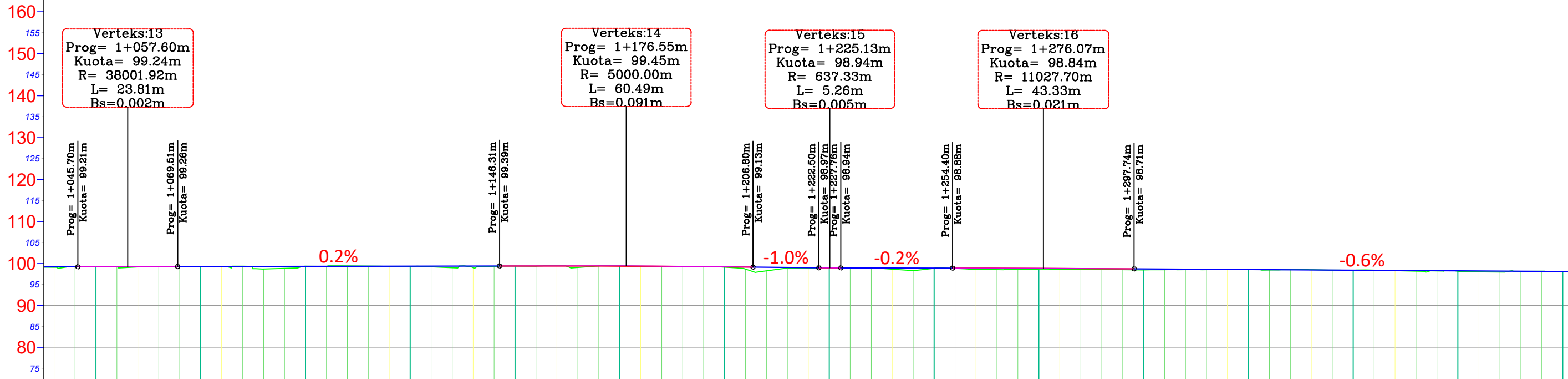

NR I PRERJES	CS - 43	CS - 44	CS - 45	CS - 46	CS - 47	CS - 48	CS - 49	CS - 50	CS - 51	CS - 52	CS - 53	CS - 54	CS - 55	CS - 56	CS - 57			
DIST. PJESORE	0 m	25.0 m	25.0 m	25.0 m	25.0 m	25.0 m	25.0 m	25.0 m	25.0 m	25.0 m	25.0 m	25.0 m	25.0 m	25.0 m	25.0 m			
DIST. PROGRESIVE	1+050	1+075	1+100	1+125	1+150	1+175	1+200	1+225	1+250	1+275	1+300	1+325	1+350	1+375	1+400			
KUOTA TOKES	99.25	99.20	99.33	99.27	99.36	99.46	99.12	98.94	98.82	98.67	98.47	98.57	98.31	98.14	98.00			
KUOTA PROJEKTIT	99.22	99.27	99.31	99.35	99.40	99.36	99.20	98.95	98.89	98.82	98.69	98.54	98.39	98.24	98.09			
KUOTA PUNES	-0.04	0.07	-0.02	0.09	0.03	-0.10	0.07	0.01	0.07	0.15	0.23	-0.02	0.09	0.10	0.09			
GJEO. VERTIKALE	R = 38001.92 K = 23.81		L = 76.80 i = 0.18%			R = 5000.00 K = 60.49		L = 15.26 i = -1.03%		R = 637.33 K = 5.26		L = 26.66 i = -0.21%		R = 11027.70 K = 43.33		L = 108.84 i = -0.60%		
GJEO. HORIZONTALE	L=44.04		φ = 0°01'02" L = 8.52 R = 28296.65		L=21.95		φ = 0°05'56" L = 60.39 R = 34960.19		L=0.17		φ = 1°11'16" L = 81.51 R = 3931.94		L=2.42 φ = 46°15'36" L = 10.67 R = 13.21		L=31.22		φ = 0°48'50" L = 54.41 R = 3830.21	
Kilometrazhi	[Scale bar from 0 to 14 km]																	

INVESTITOR
BASHKIA ÇËRRIK



ZetaKonsult sh.p.k
 Address:Rr."Myrteza Topi",Nd 18, Hyrja 7, Ap 38, TIRANE
 Cel: +355 (0)69 33 52 077
 e-mail:zetakonsultshpk@gmail.com



EMERTIMI I OBJEKTIT:
 STUDIM, PROJEKTIM I RRUGEVE RURALE NE NJ.A SHALES

Rikonstruksioni i rruges Lazarec, Fshati Licaj

FAZA E PROJEKTIT :PROJEKT ZBATIMI

EMERTESA E FLETES:
 PROFILI GJATESOR

SHKALLA Shk:1/1000 FLETA 04

DREJTOR PROJEKTI: Ing. Flutura DURO

Inxh.Ndert.Flutura Duro
Inxh.Ndert.Lorenc HOXHA

Dt. ___/___/2022

FORMATI A3

PROFILI GJATESOR

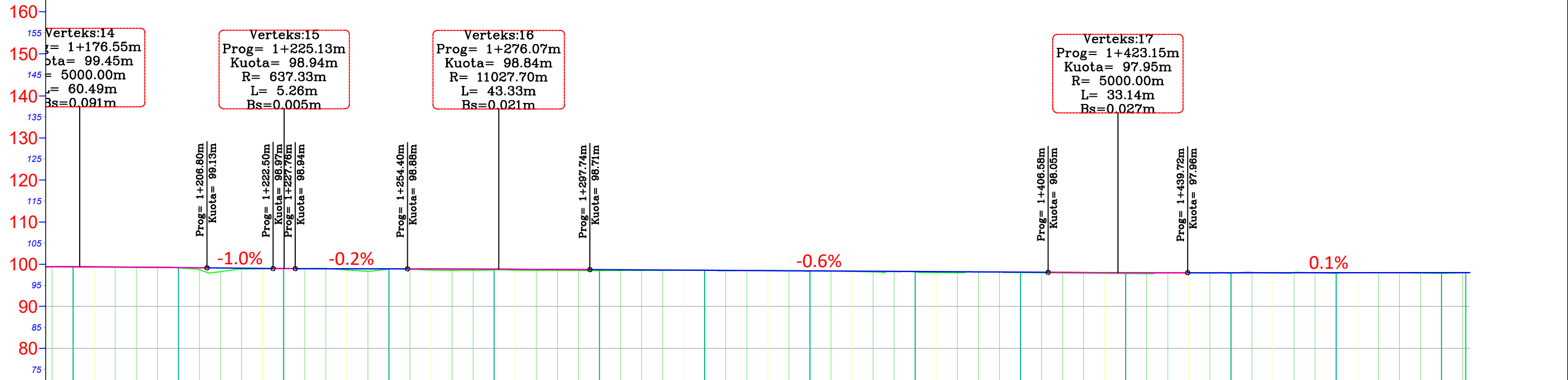

NR I PRERJES	CS - 48	CS - 49	CS - 50	CS - 51	CS - 52	CS - 53	CS - 54	CS - 55	CS - 56	CS - 57	CS - 58	CS - 59	CS - 60	CS - 61	CS - 62
DIST. PJESORE	25.0 m	25.0 m	25.0 m	25.0 m	25.0 m	25.0 m	25.0 m	25.0 m	25.0 m	25.0 m	25.0 m	25.0 m	25.0 m	25.0 m	5.8 m
DIST. PROGRESIVE	1+175	1+200	1+225	1+250	1+275	1+300	1+325	1+350	1+375	1+400	1+425	1+450	1+475	1+500	1+506
KUOTA TOKES	99.46	99.12	98.94	98.82	98.67	98.47	98.57	98.31	98.14	98.00	97.80	97.87	97.85	97.84	97.98
KUOTA PROJEKTIT	99.36	99.20	98.95	98.89	98.82	98.69	98.54	98.39	98.24	98.09	97.98	97.97	97.99	98.00	98.00
KUOTA PUNES	-0.10	0.07	0.01	0.07	0.15	0.23	-0.02	0.09	0.10	0.09	0.18	0.10	0.14	0.16	0.03
GJEO. VERTIKALE	R = 5000.00 K = 60.49	L = 15.55 i = -1.03%	R = 637.33 K = 5.26	L = 26.66 i = -0.21%	R = 11027.70 K = 43.33	L = 108.84 i = -0.60%	R = 5000.00 K = 33.14	L = 67.00 i = 0.06%							
GJEO. HORIZONTALE	L=0.17	φ = 1°11'16" L=81.51 R=3931.94	φ = 46°15'36" L=10.67 R=13.21	L=2.72	L=31.22	φ = 0°48'50" L=54.41 R=3830.21	L=87.38	φ = 7°48'43" L=32.95 R=241.65	L=14.97						
Kilometrazhi															

INVESTITOR
BASHKIA ÇËRRIK



ZetaKonsult sh.p.k
 Address:Rr."Myrteza Topi",Nd 18, Hyrja 7, Ap 38, TIRANE
 Cel: +355 (0)69 33 52 077
 e-mail:zetakonsultshpk@gmail.com



EMERTIMI I OBJEKTIT:
 STUDIM, PROJEKTIM I RRUGEVE RURALE NE NJ.A SHALES
Rikonstruksioni i rruges Lazarec, Fshati Licaj

FAZA E PROJEKTIT :PROJEKT ZBATIMI

EMERTESA E FLETES:
 PROFILI GJATESOR

SHKALLA Shk:1/1000 FLETA 05

DREJTOR PROJEKTI: Ing. Flutura DURO

Inxh.Ndert.Flutura Duro
Inxh.Ndert.Lorenc HOXHA

Dt. ___/___/2022

FORMATI A3

PROFILAT TERTHORE TIP SHK. 1:50

Profil Tip 1
Km 0+000.00 - 0+106.00
Km 0+225.00 - 0+450.00

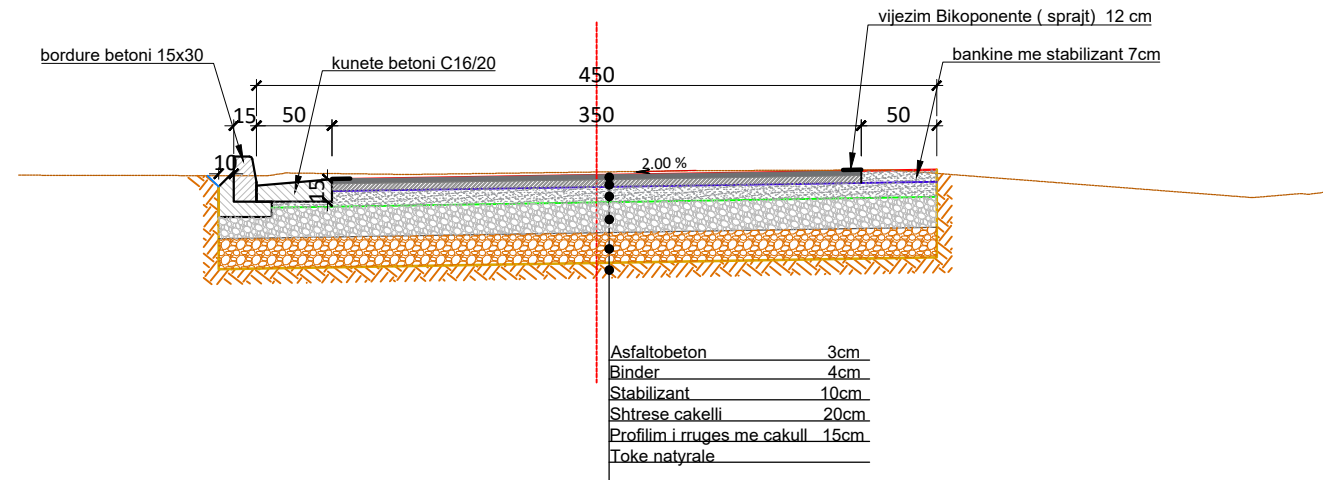

Profil Tip 2
Km 0+106.00 - 0+160.00

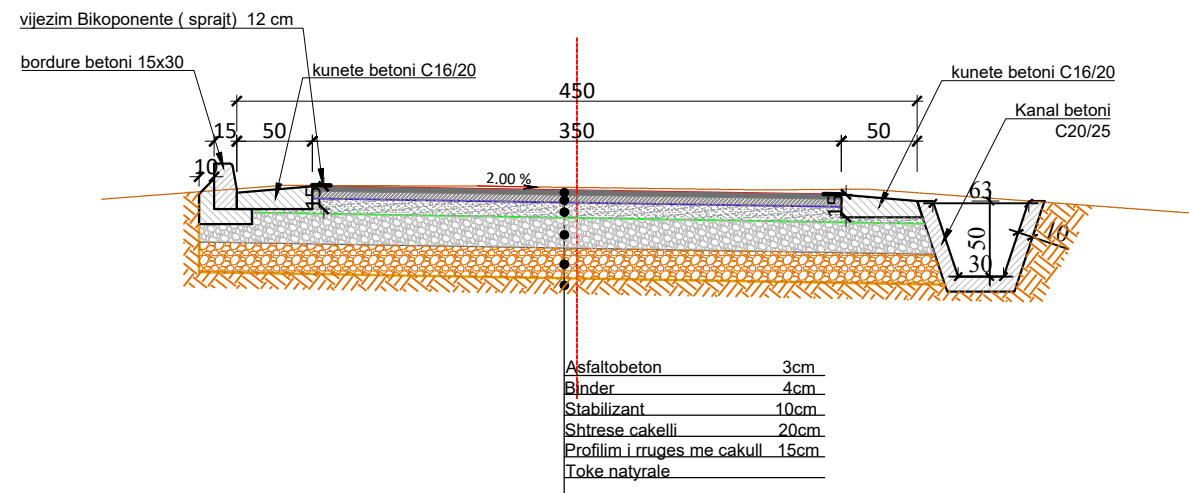

INVESTITOR
BASHKIA ÇËRRIK



ZetaKonsult sh.p.k

Address:Rr."Myrteza Topi",Nd 18, Hyrja 7, Ap 38, TIRANE

Cel: +355 (0)69 33 52 077

e-mail:zetakonsultshpk@gmail.com



EMERTIMI I OBJEKTIT:
STUDIM, PROJEKTIM I RRUGEVE RURALE NE NJ.A SHALES
Rikonstruksioni i rruges Lazarec, Fshati Licaj

FAZA E PROJEKTIT :PROJEKT ZBATIMI

EMERTESA E FLETES:
PROFILAT TERTHORE TIP

SHKALLA Shk:1/50

FLETA 01

DREJTOR PROJEKTI: Ing. Flutura DURO

Inxh.Ndert.Flutura Duro
Inxh.Ndert.Lorenc HOXHA

Dt ___/___/2022

FORMATI A3

PROFILAT TERTHORE TIP

SHK. 1:50

Profil Tip 3

Km 0+160.00 - 0+225.00
Km 0+450.00 - 0+557.00

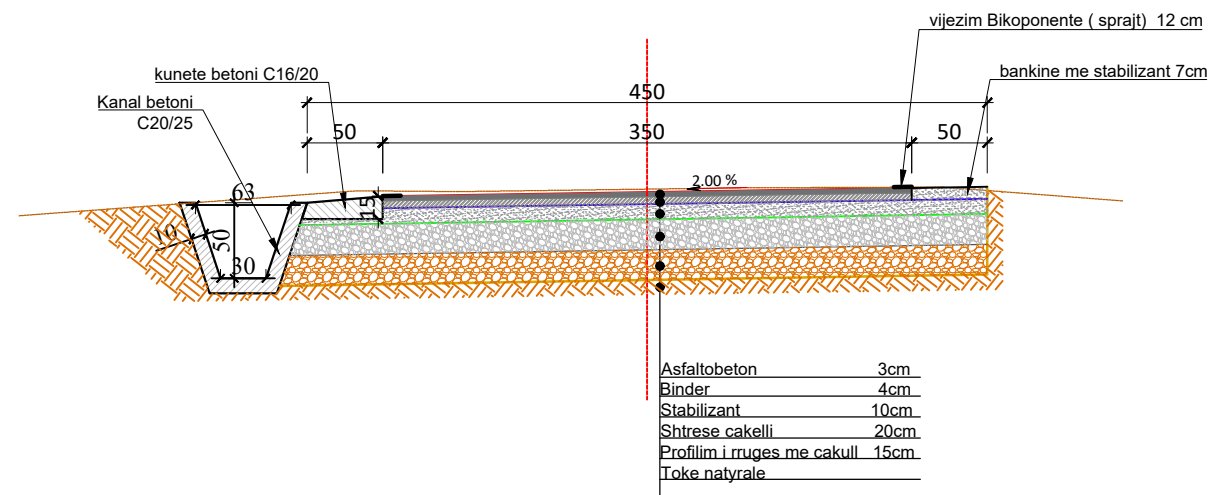

Profil Tip 4

Km 0+557.00 - 1+506.00

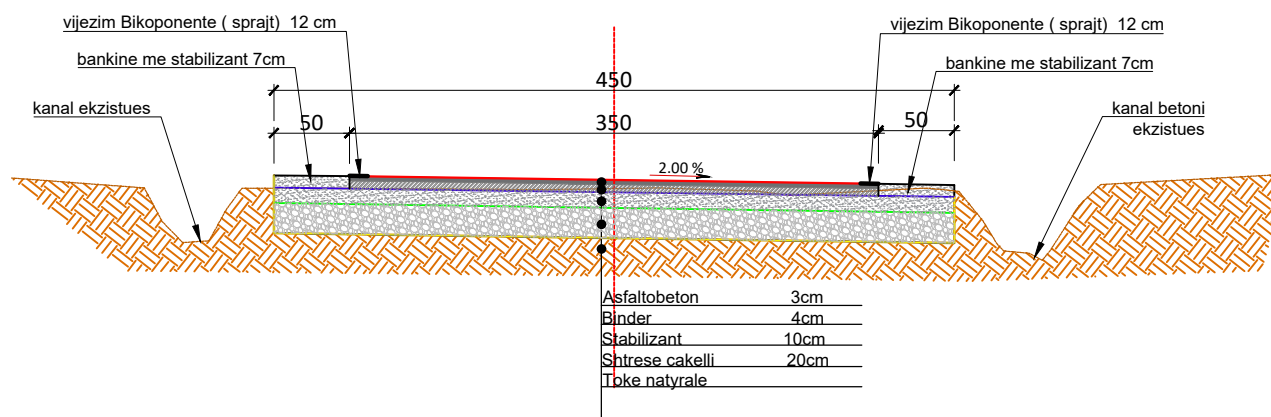

INVESTITOR
BASHKIA CËRRIK



ZetaKonsult sh.p.k

Address:Rr."Myrteza Topi",Nd 18, Hyrja 7, Ap 38, TIRANE
Cel:+355 (0)69 33 52 077
e-mail:zetakonsultshpk@gmail.com



EMERTIMI I OBJEKTIT:
STUDIM, PROJEKTIM I RRUGEVE RURALE NE NJ.A SHALES
Rikonstruksioni i rruges Lazarec, Fshati Licaj

FAZA E PROJEKTIT :PROJEKT ZBATIMI

EMERTESA E FLETES:
PROFILAT TERTHORE TIP

SHKALLA Shk:1/50

FLETA 02

DREJTOR PROJEKTI: Ing. Flutura DURO

Inxh.Ndert.Flutura Duro
Inxh.Ndert.Lorenc HOXHA

Dt ___/___/2022

FORMATI A3

PROFILAT TERTHORE TIP SHK. 1:50

Profil Tip 5
degezimet

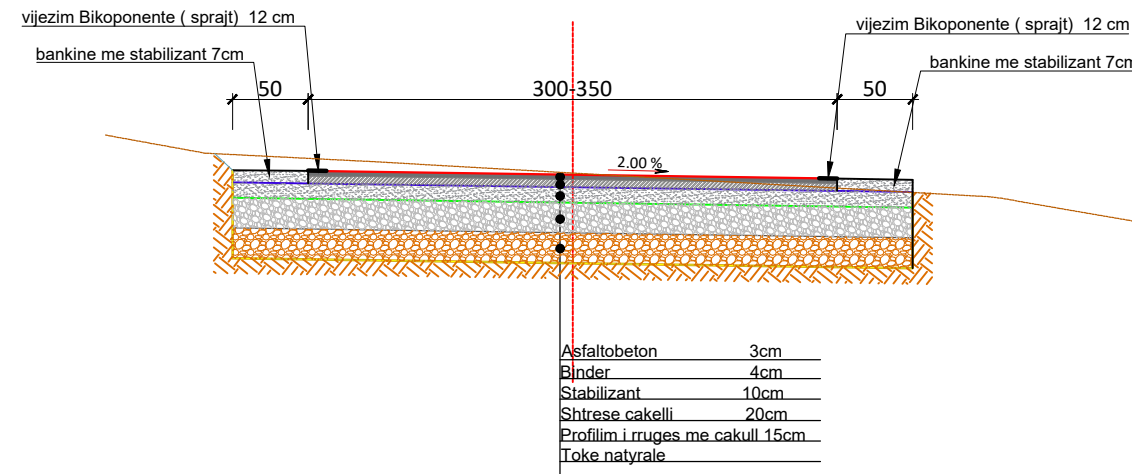

INVESTITOR
BASHKIA ÇËRRIK



ZetaKonsult sh.p.k

Address:Rr."Myrteza Topi",Nd 18, Hyrja 7, Ap 38, TIRANE

Cel: +355 (0)69 33 52 077

e-mail:zetakonsultshpk@gmail.com



EMERTIMI I OBJEKTIT:

STUDIM, PROJEKTIM I RRUGEVE RURALE NE NJ.A SHALES

Rikonstruksioni i rruges Lazarec, Fshati Licaj

FAZA E PROJEKTIT :PROJEKT ZBATIMI

EMERTESA E FLETES:
PROFILAT TERTHORE TIP

SHKALLA Shk:1/50

FLETA 03

DREJTOR PROJEKTI: Ing. Flutura DURO

Inxh.Ndert.Flutura Duro
Inxh.Ndert.Lorenc HOXHA

Dt ___/___/2022

FORMATI A3

PROFILAT TERTHORE PROGRESIV SH 1:100

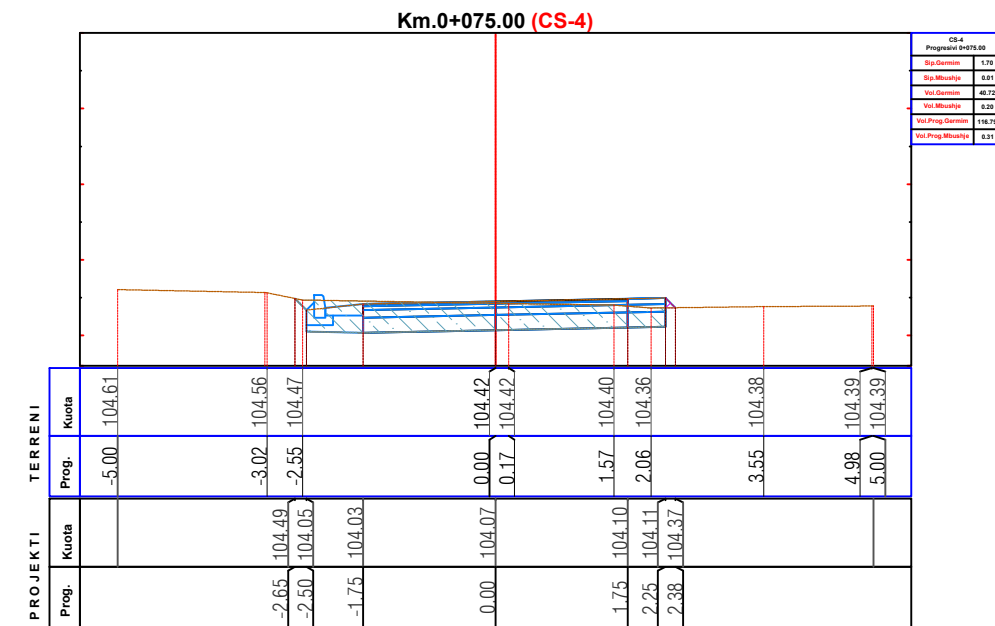
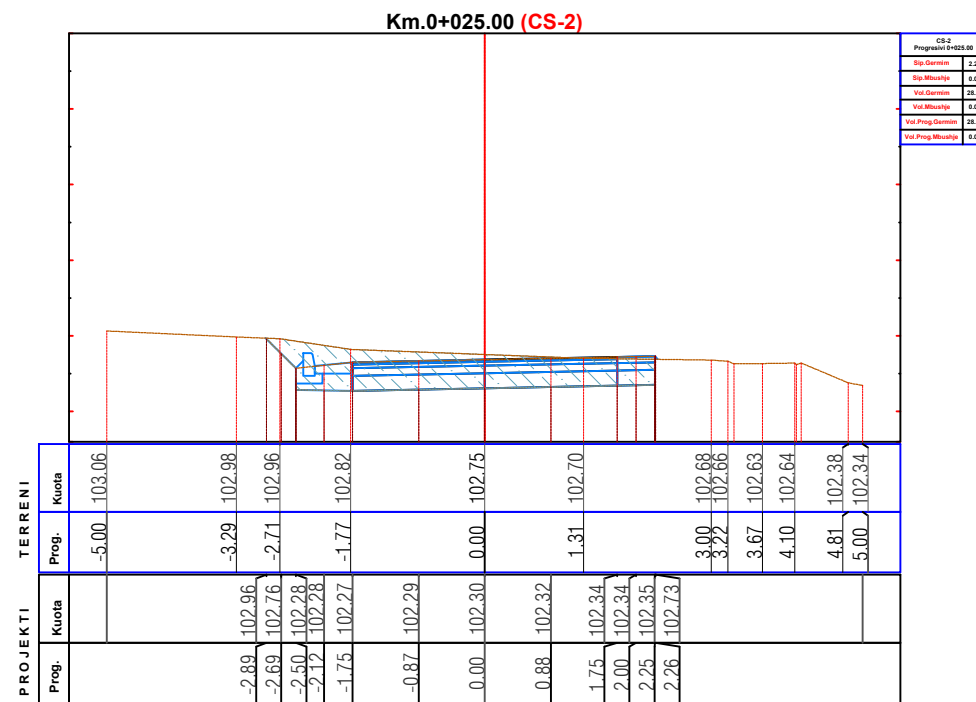
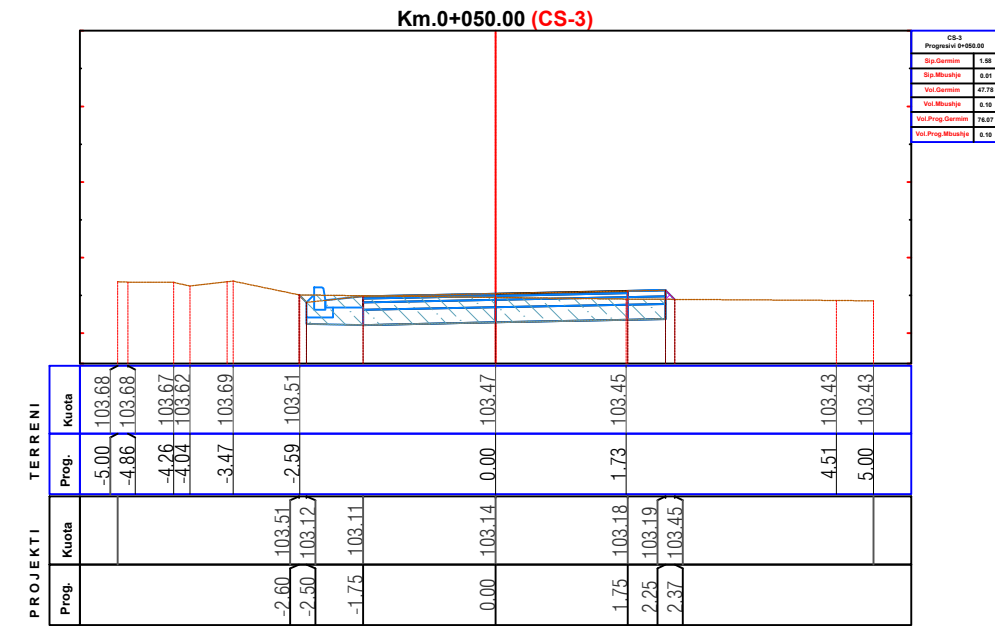
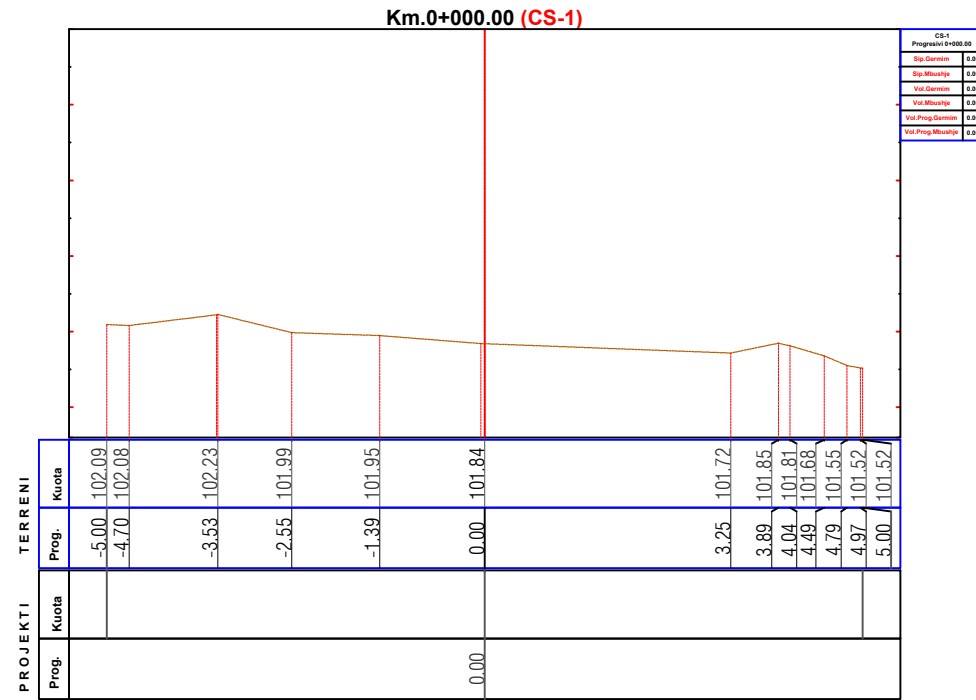

INVESTITOR
BASHKIA ÇËRRIK



ZetaKonsult sh.p.k

Address: Rr. "Myrteza Topi", Nd 18, Hyrja 7, Ap 38, TIRANE

Cel: +355 (0)69 33 52 077

e-mail: zetakonsultshpk@gmail.com



EMERTIMI I OBJEKTIT:
STUDIM, PROJEKTIM I RRUGEVE RURALE NE NJ.A SHALES

Rikonstruksioni i rruges Lazarec, Fshati Licaj

FAZA E PROJEKTIT : PROJEKT ZBATIMI

EMERTESA E FLETES:
PROFILAT TERTHORE PROGRESIV

SHKALLA Shk: 1/100

FLETA 01

DREJTOR PROJEKTI: Ing. Flutura DURO

Inxh. Ndert. Flutura Duro
Inxh. Ndert. Lorenc HOXHA

Dt ___/___/2022

FORMATI A3

PROFILAT TERTHORE PROGRESIV SH 1:100

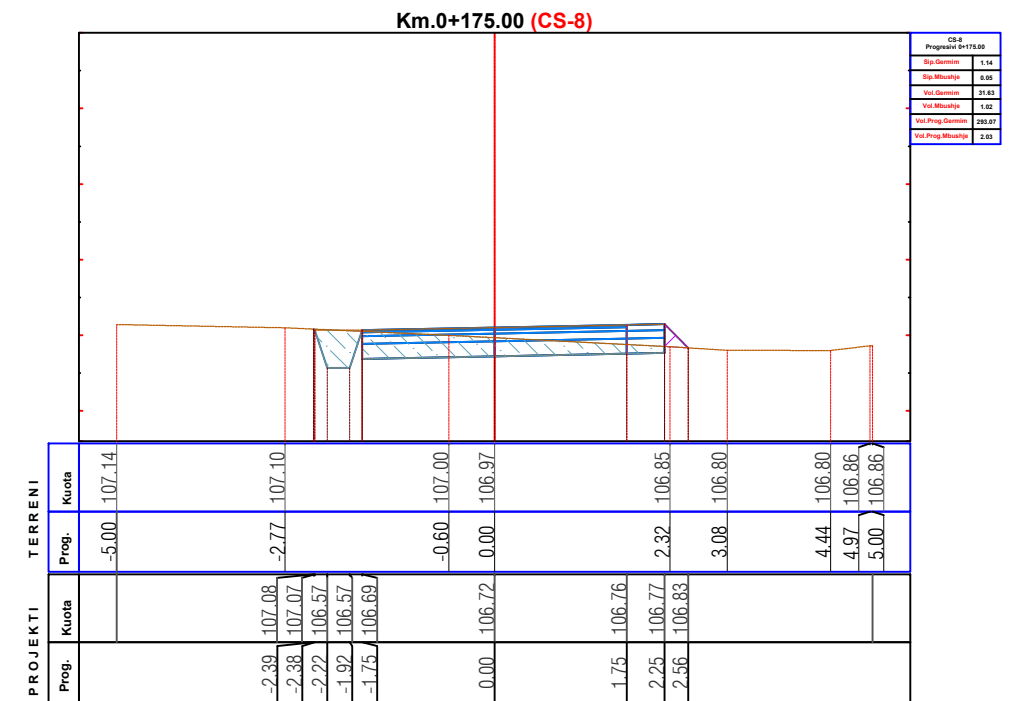
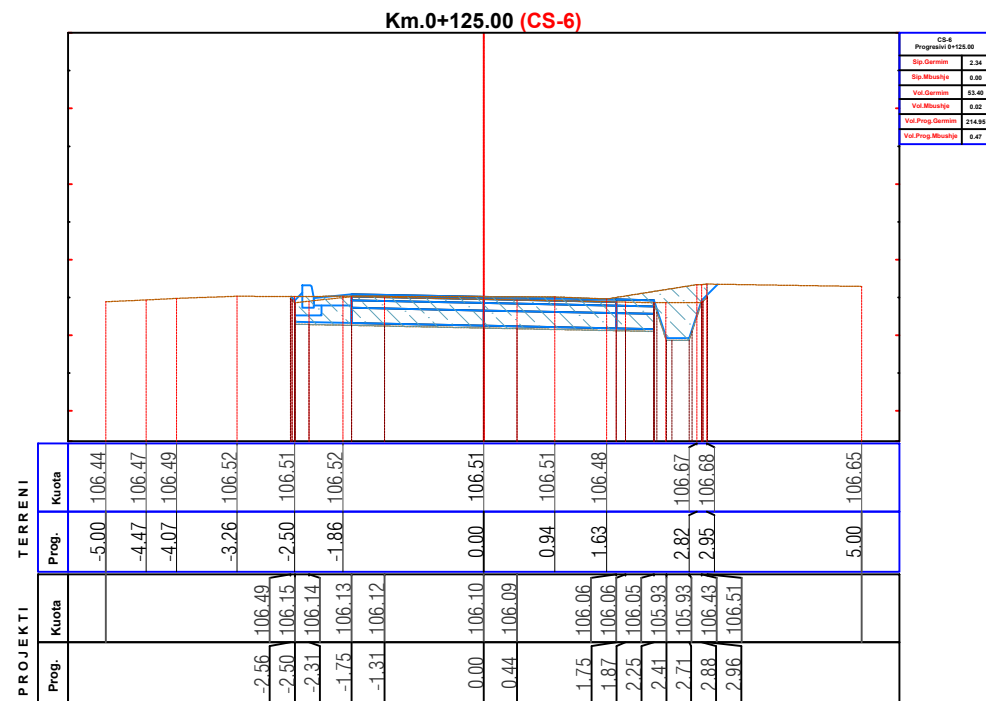
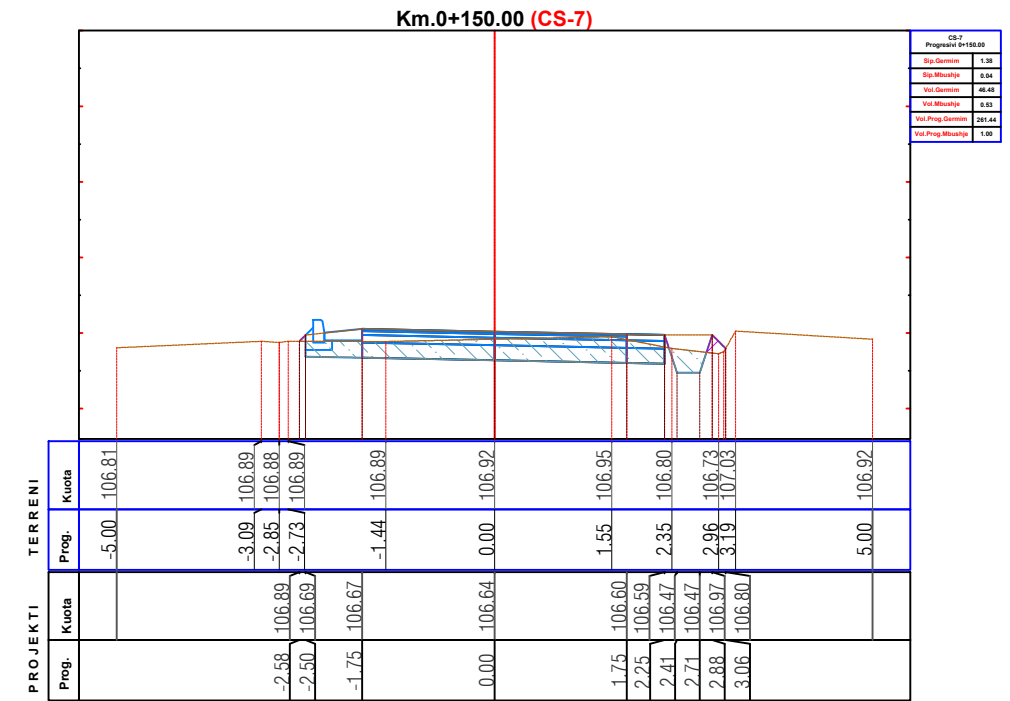
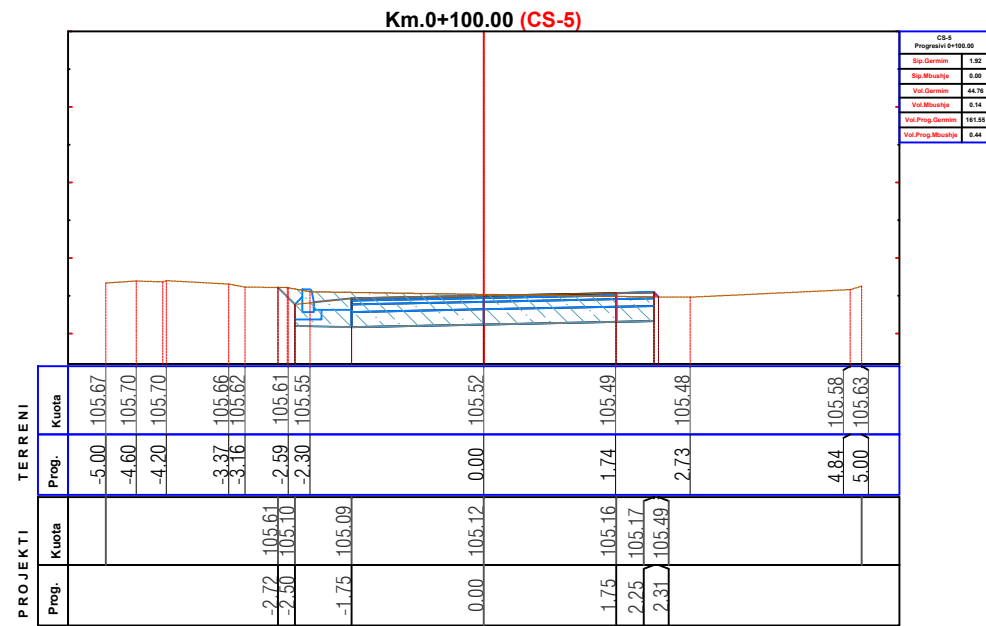

INVESTITOR
BASHKIA ÇËRRIK



ZetaKonsult sh.p.k

Address:Rr."Myrteza Topi",Nd 18, Hyrja 7, Ap 38, TIRANE

Cel: +355 (0)69 33 52 077

e-mail:zetakonsultshpk@gmail.com



EMERTIMI I OBJEKTIT:
STUDIM, PROJEKTIM I RRUGEVE RURALE NE NJ.A SHALES

Rikonstruksioni i rruges Lazarec, Fshati Licaj

FAZA E PROJEKTIT :PROJEKT ZBATIMI

EMERTESA E FLETES:
PROFILAT TERTHORE PROGRESIV

SHKALLA Shk:1/100

FLETA 02

DREJTOR PROJEKTI: Ing. Flutura DURO

Inxh.Ndert.Flutura Duro
Inxh.Ndert.Lorenc HOXHA

Dt ___/___/2022

FORMATI A3

PROFILAT TERTHORE PROGRESIV SH 1:100

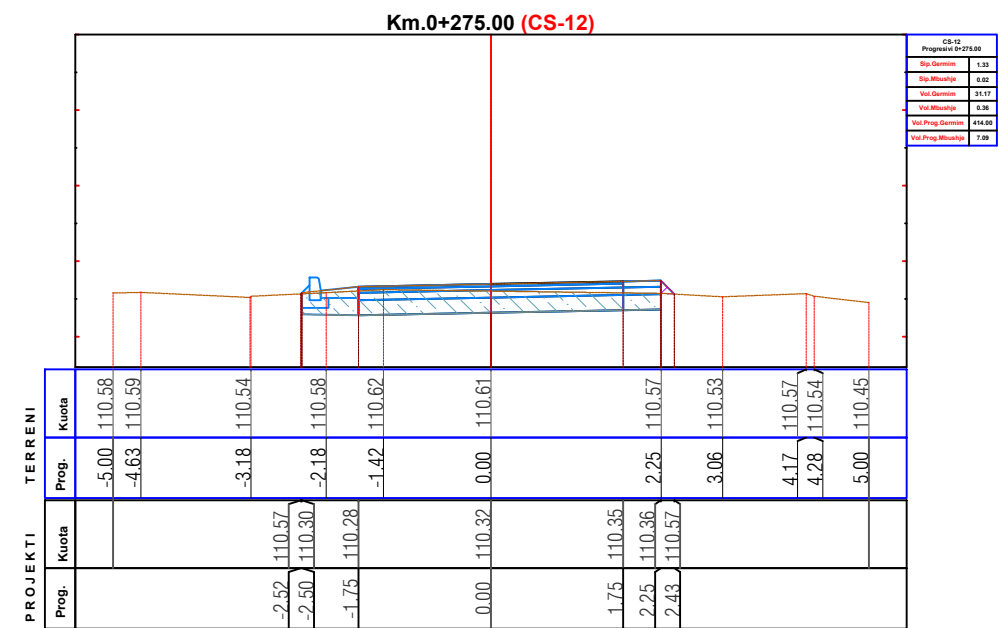
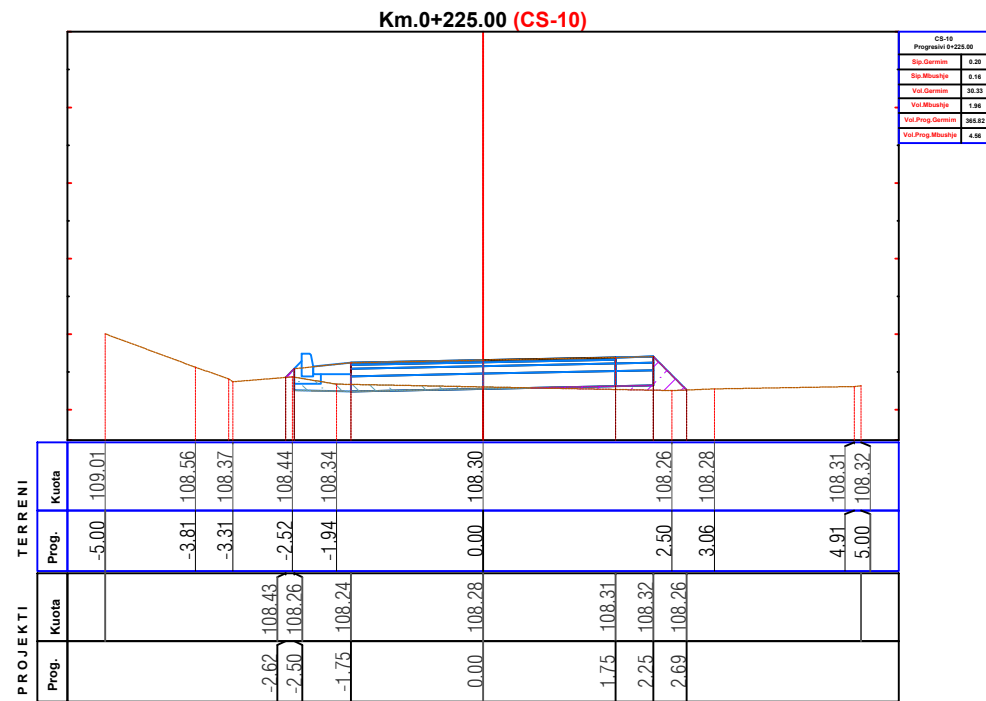
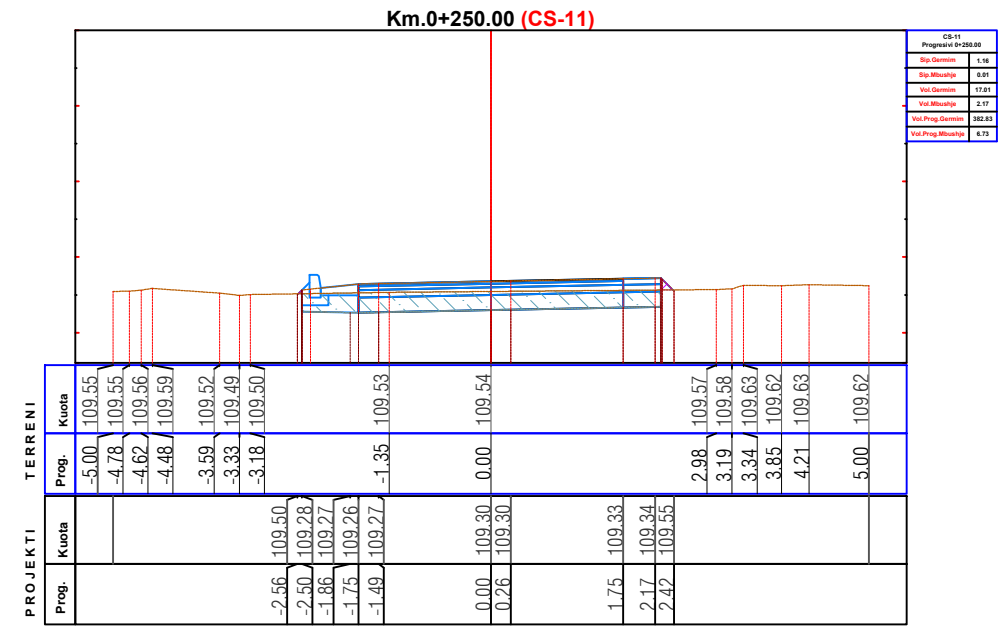
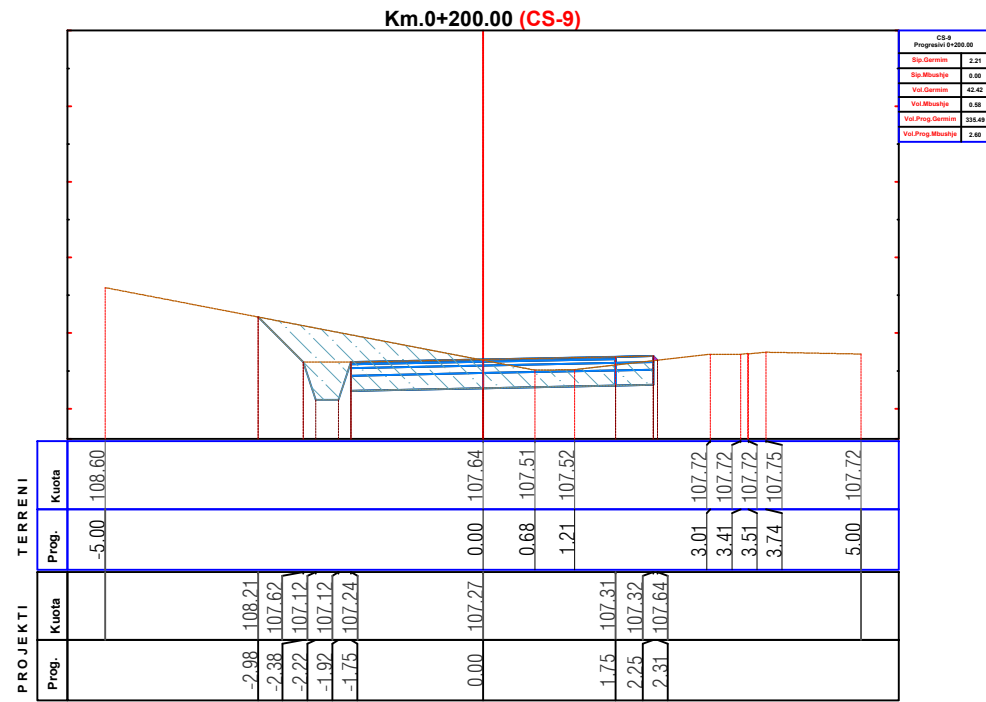

INVESTITOR
BASHKIA ÇËRRIK



ZetaKonsult sh.p.k

Address:Rr."Myrteza Topi",Nd 18, Hyrja 7, Ap 38, TIRANE

Cel: +355 (0)69 33 52 077

e-mail:zetakonsultshpk@gmail.com



EMERTIMI I OBJEKTIT:
STUDIM, PROJEKTIM I RRUGEVE RURALE NE NJ.A SHALES

Rikonstruksioni i rruges Lazarec, Fshati Licaj

FAZA E PROJEKTIT :PROJEKT ZBATIMI

EMERTESA E FLETES:
PROFILAT TERTHORE PROGRESIV

SHKALLA Shk:1/100

FLETA 03

DREJTOR PROJEKTI: Ing. Flutura DURO

Inxh.Ndert.Flutura Duro
Inxh.Ndert.Lorenc HOXHA

Dt ___/___/2022

FORMATI A3

PROFILAT TERTHORE PROGRESIV SH 1:100

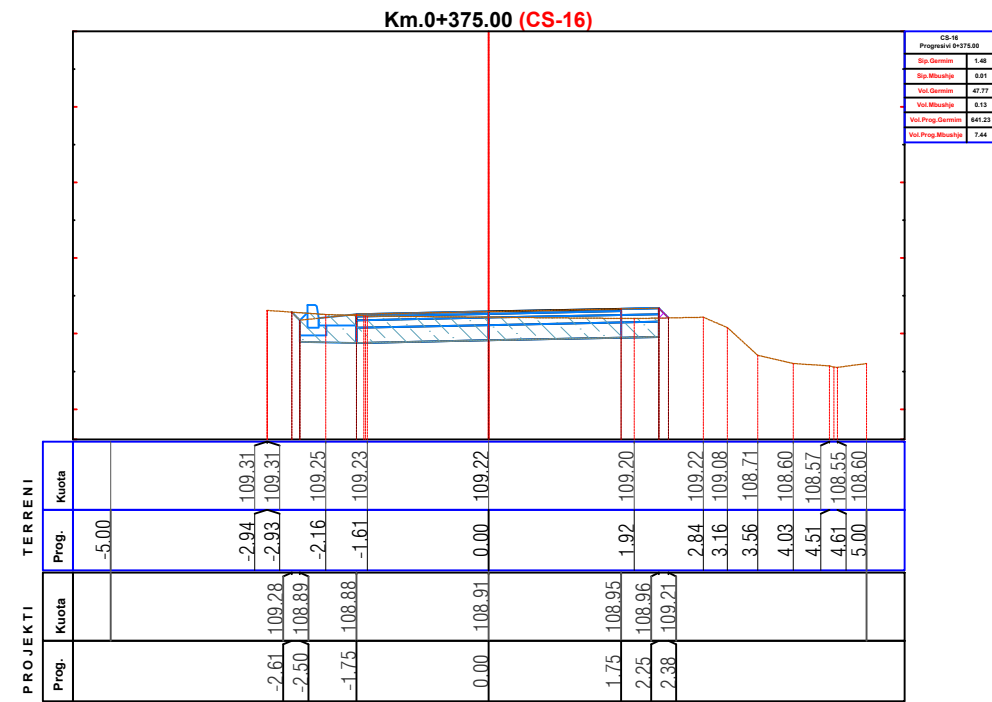
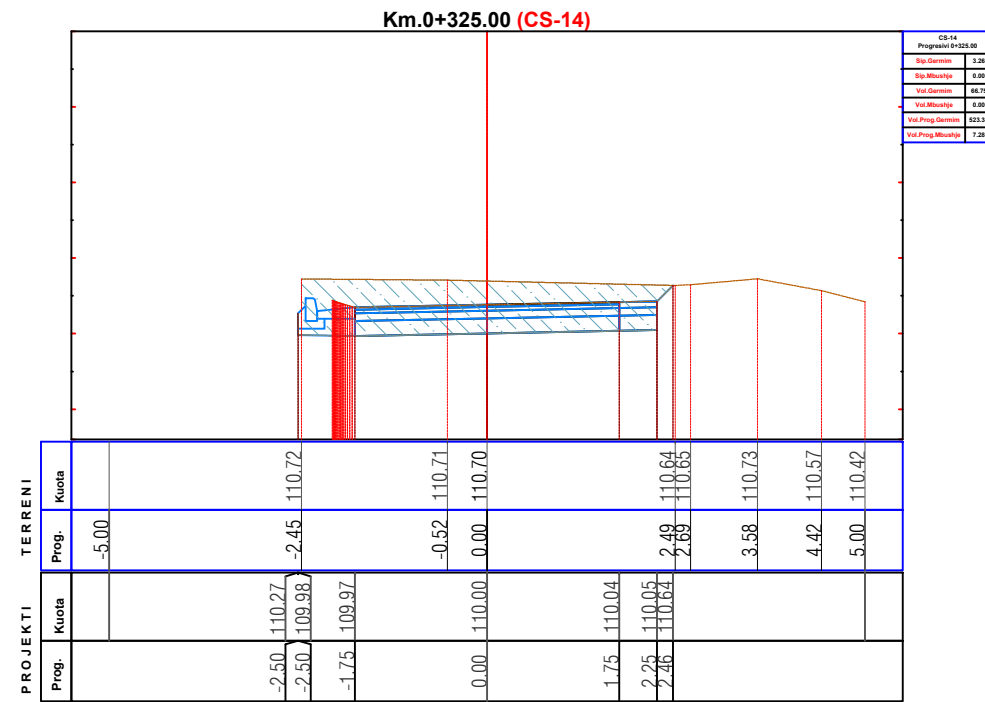
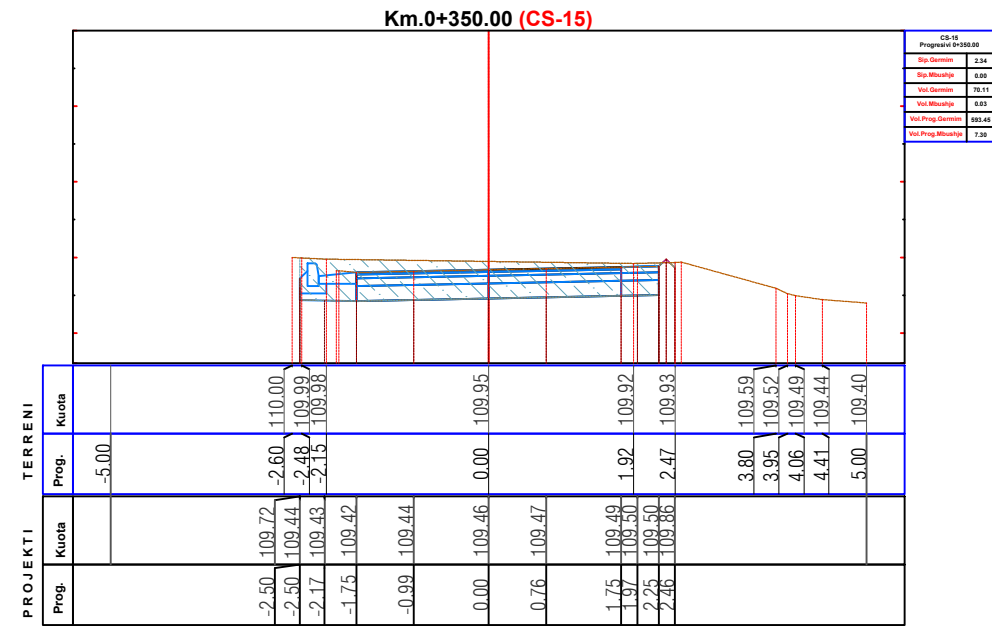
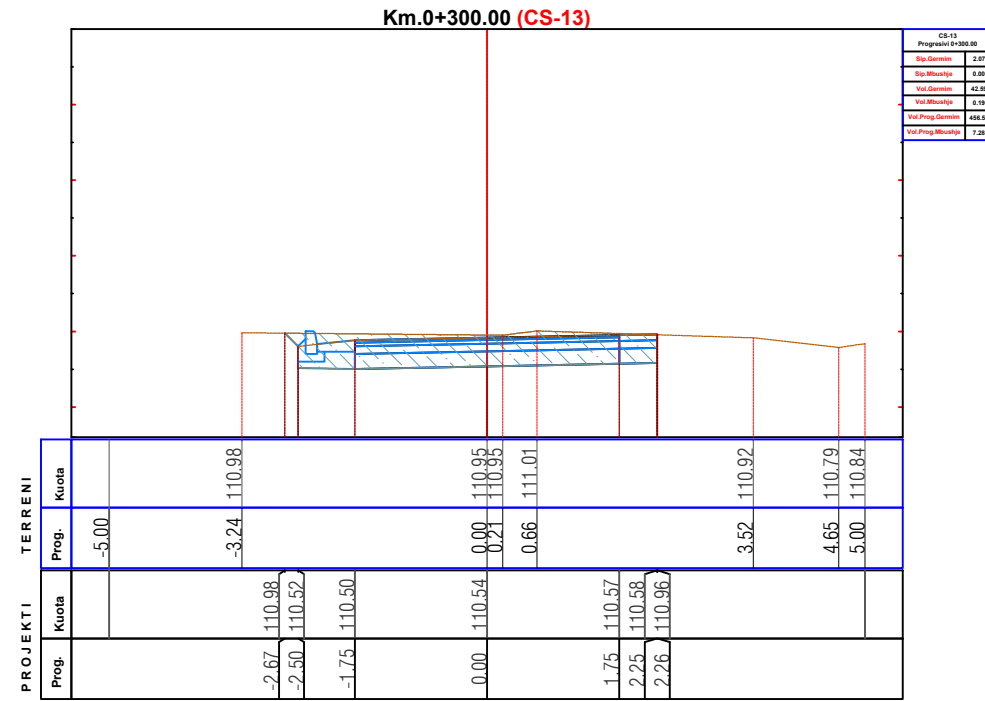

INVESTITOR
BASHKIA ÇËRRIK



ZetaKonsult sh.p.k

Address:Rr."Myrteza Topi",Nd 18, Hyrja 7, Ap 38, TIRANE

Cel: +355 (0)69 33 52 077

e-mail:zetakonsultshpk@gmail.com



EMERTIMI I OBJEKTIT:
STUDIM, PROJEKTIM I RRUGEVE RURALE NE NJ.A SHALES

Rikonstruksioni i rruges Lazarec, Fshati Licaj

FAZA E PROJEKTIT :PROJEKT ZBATIMI

EMERTESA E FLETES:
PROFILAT TERTHORE PROGRESIV

SHKALLA Shk:1/100

FLETA 04

DREJTOR PROJEKTI: Ing. Flutura DURO

Inxh.Ndert.Flutura Duro
Inxh.Ndert.Lorenc HOXHA

Dt ___/___/2022

FORMATI A3

PROFILAT TERTHORE PROGRESIV SH 1:100

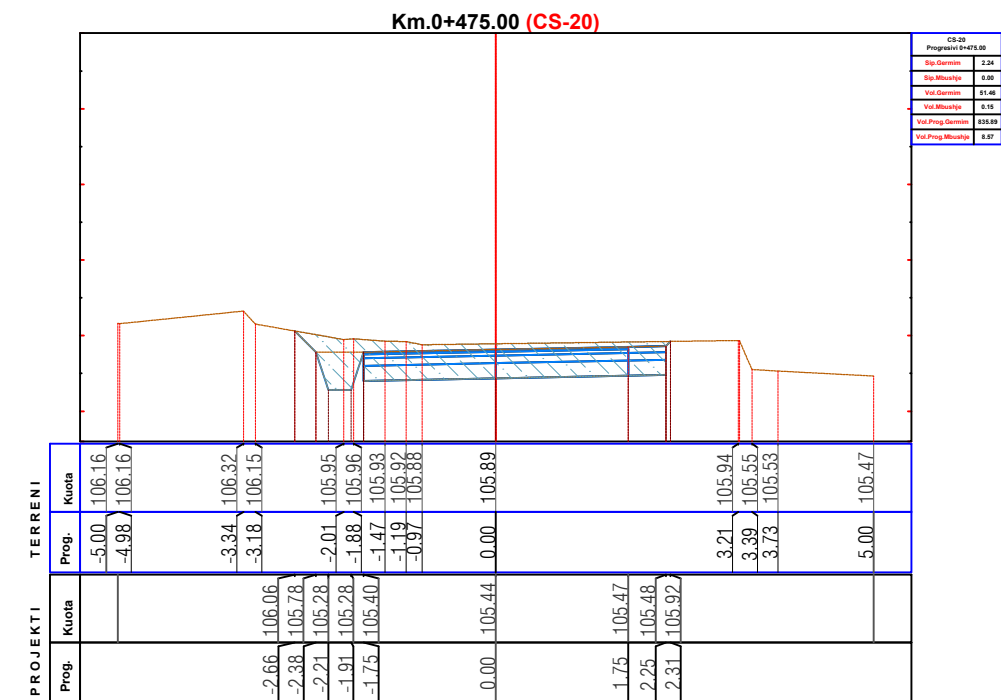
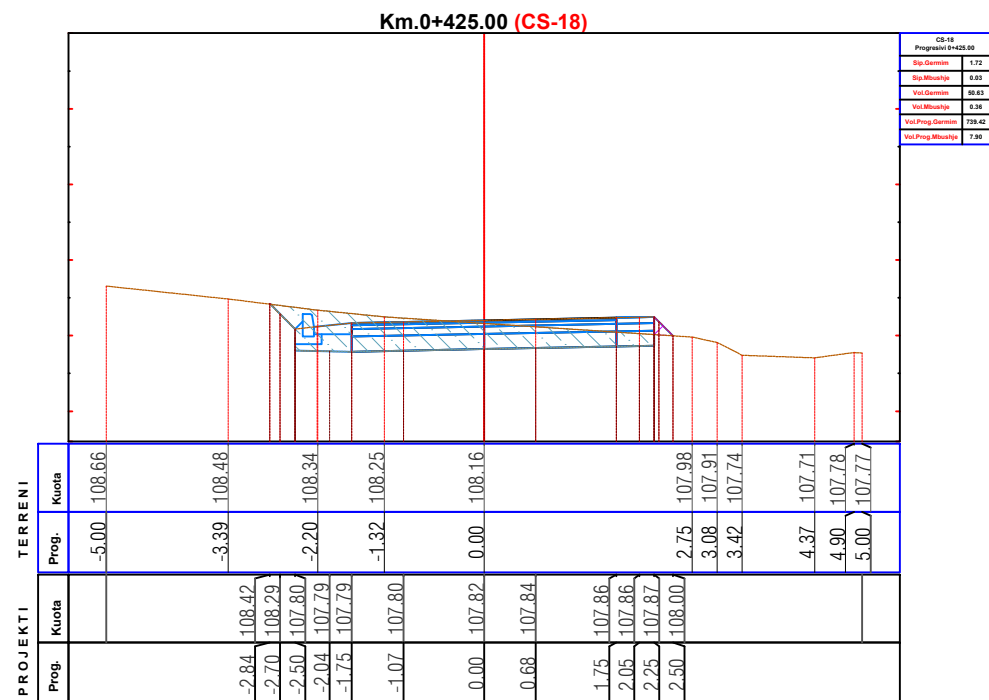
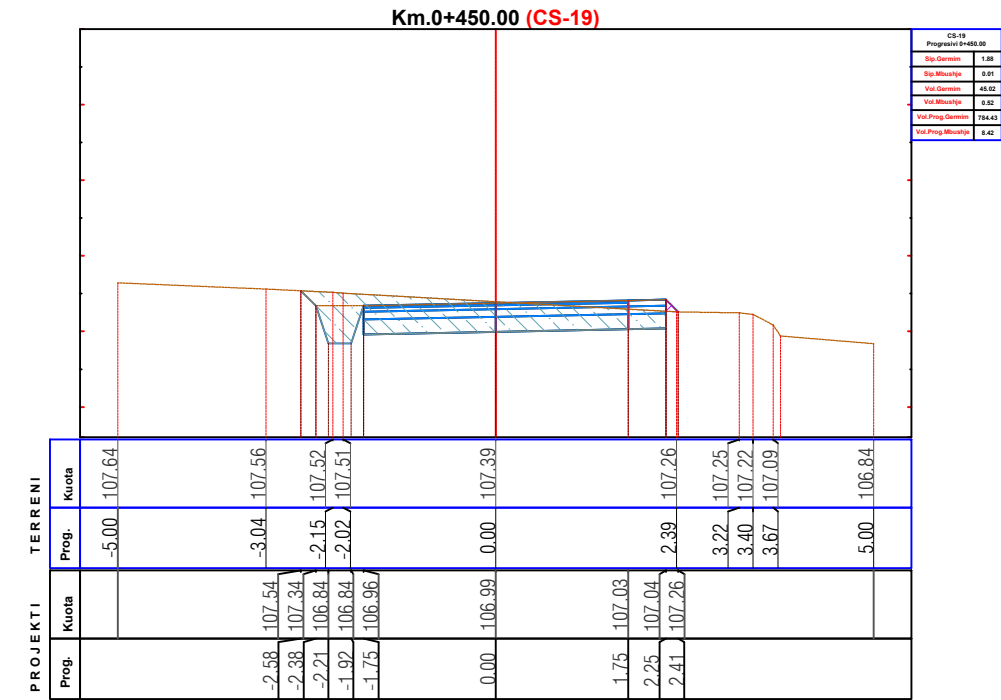
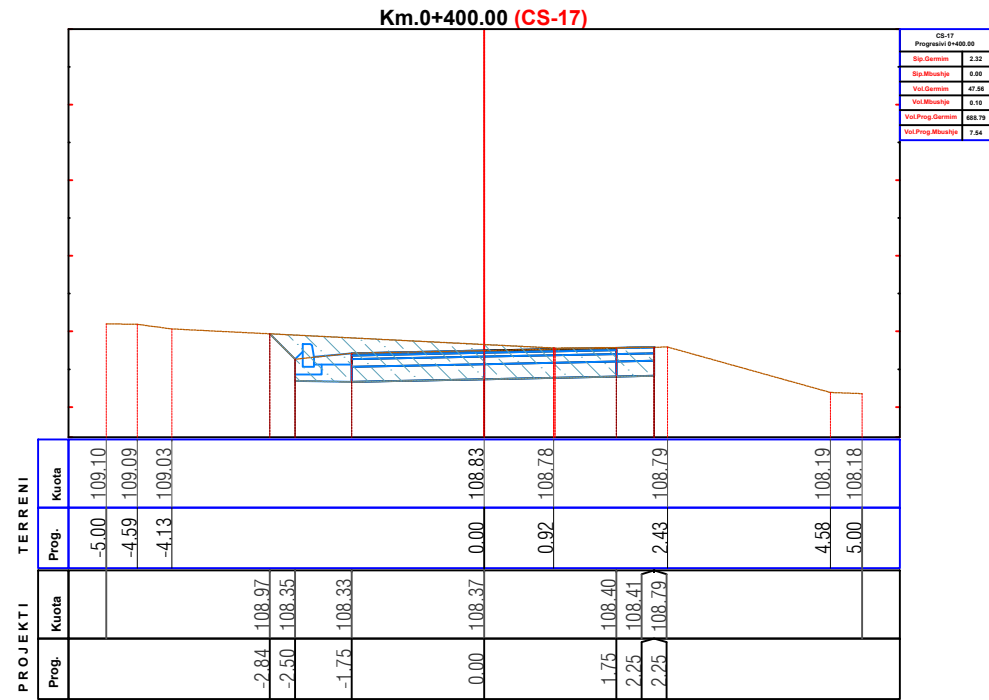

INVESTITOR
BASHKIA ÇËRRIK



ZetaKonsult sh.p.k

Address:Rr."Myrteza Topi",Nd 18, Hyrja 7, Ap 38, TIRANE

Cel: +355 (0)69 33 52 077

e-mail:zetakonsultshpk@gmail.com



EMERTIMI I OBJEKTIT:
STUDIM, PROJEKTIM I RRUGEVE RURALE NE NJ.A SHALES

Rikonstruksioni i rruges Lazarec, Fshati Licaj

FAZA E PROJEKTIT :PROJEKT ZBATIMI

EMERTESA E FLETES:
PROFILAT TERTHORE PROGRESIV

SHKALLA Shk:1/100

FLETA 05

DREJTOR PROJEKTI: Ing. Flutura DURO

Inxh.Ndert.Flutura Duro
Inxh.Ndert.Lorenc HOXHA

Dt ___/___/2022

FORMATI A3

PROFILAT TERTHORE PROGRESIV SH 1:100

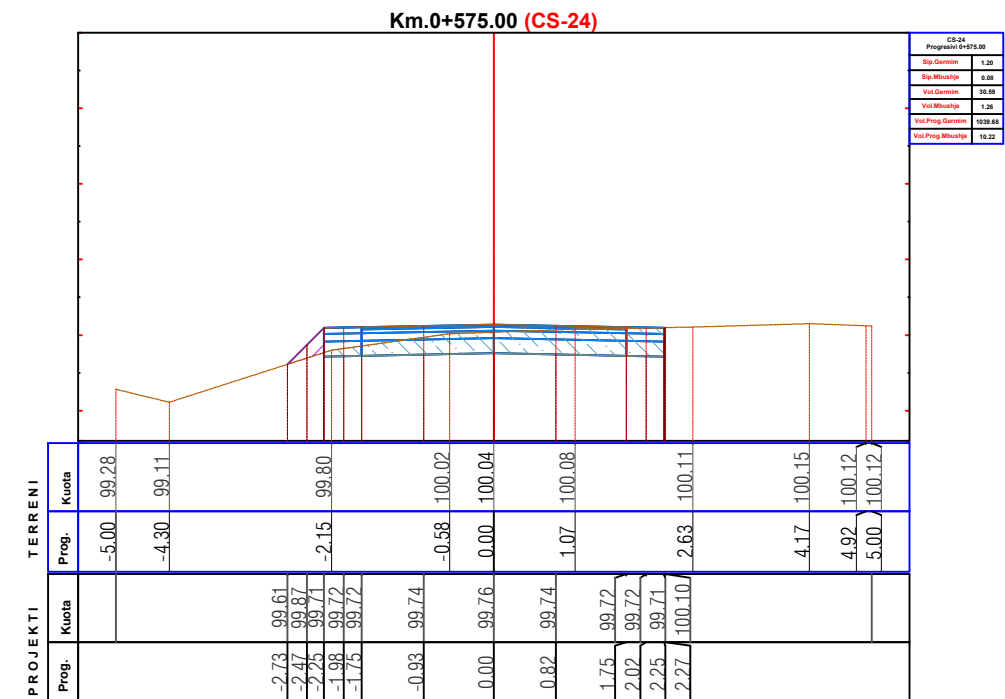
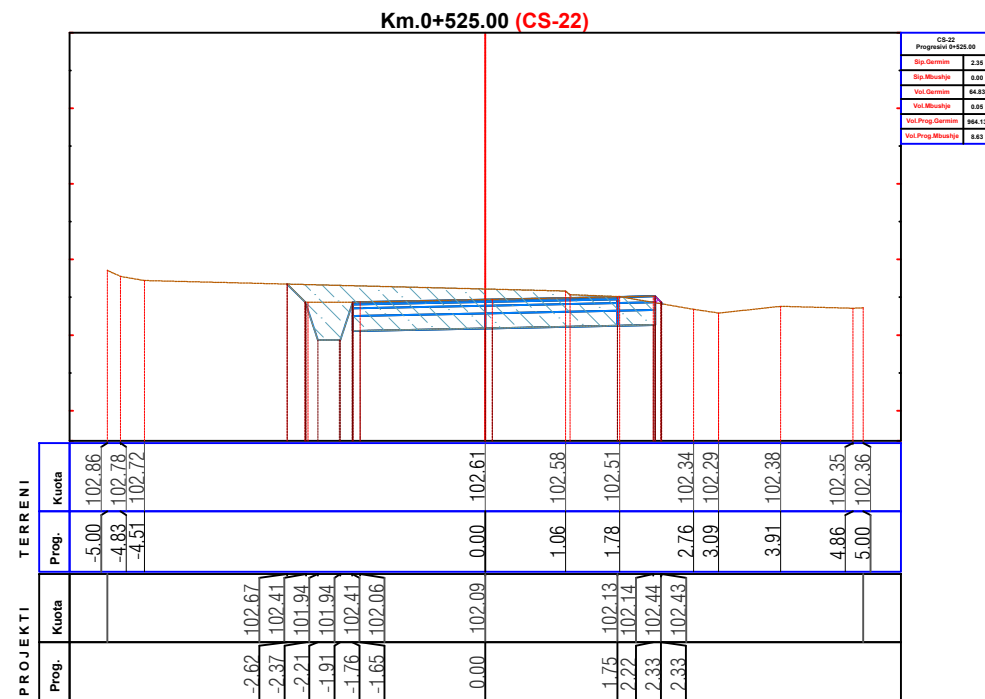
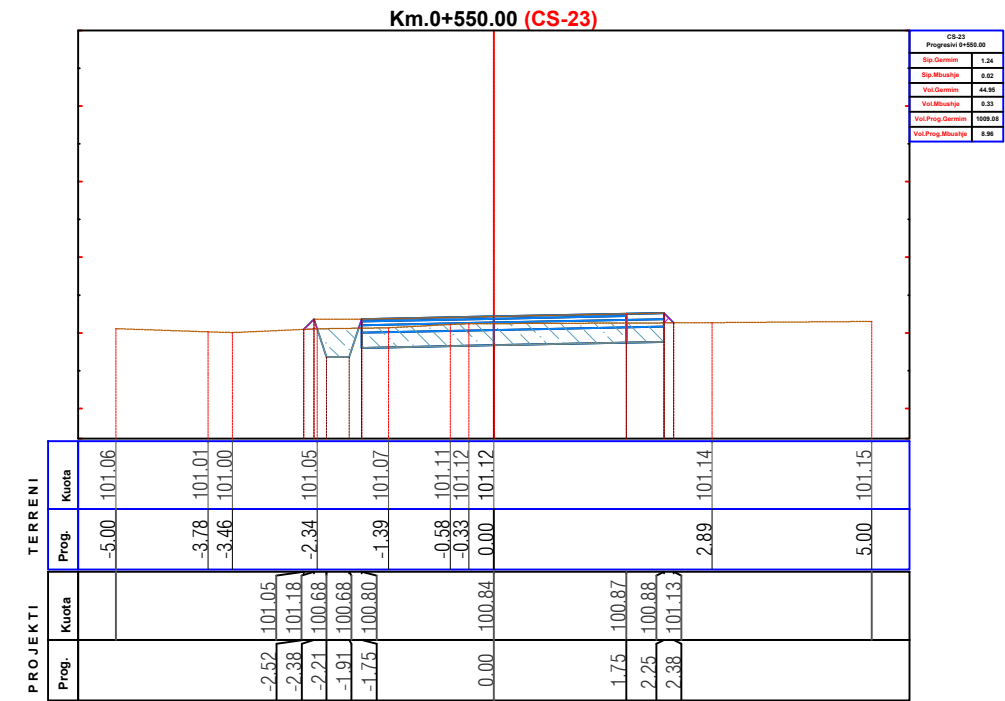
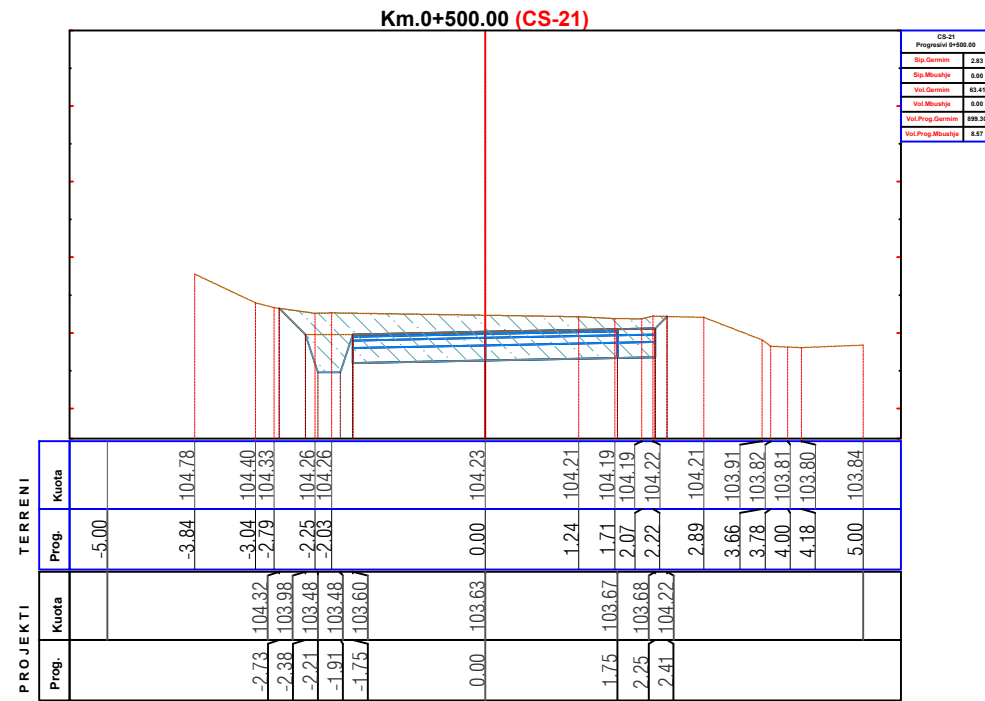

INVESTITOR
BASHKIA ÇËRRIK



ZetaKonsult sh.p.k

Address:Rr."Myrteza Topi",Nd 18, Hyrja 7, Ap 38, TIRANE

Cel: +355 (0)69 33 52 077

e-mail:zetakonsultshpk@gmail.com



EMERTIMI I OBJEKTIT:
STUDIM, PROJEKTIM I RRUGEVE RURALE NE NJ.A SHALES
Rikonstruksioni i rruges Lazarec, Fshati Licaj

FAZA E PROJEKTIT :PROJEKT ZBATIMI

EMERTESA E FLETES:
PROFILAT TERTHORE PROGRESIV

SHKALLA Shk:1/100

FLETA 06

DREJTOR PROJEKTI: Ing. Flutura DURO

Inxh.Ndert.Flutura Duro
Inxh.Ndert.Lorenc HOXHA

Dt ___/___/2022

FORMATI A3

PROFILAT TERTHORE PROGRESIV SH 1:100

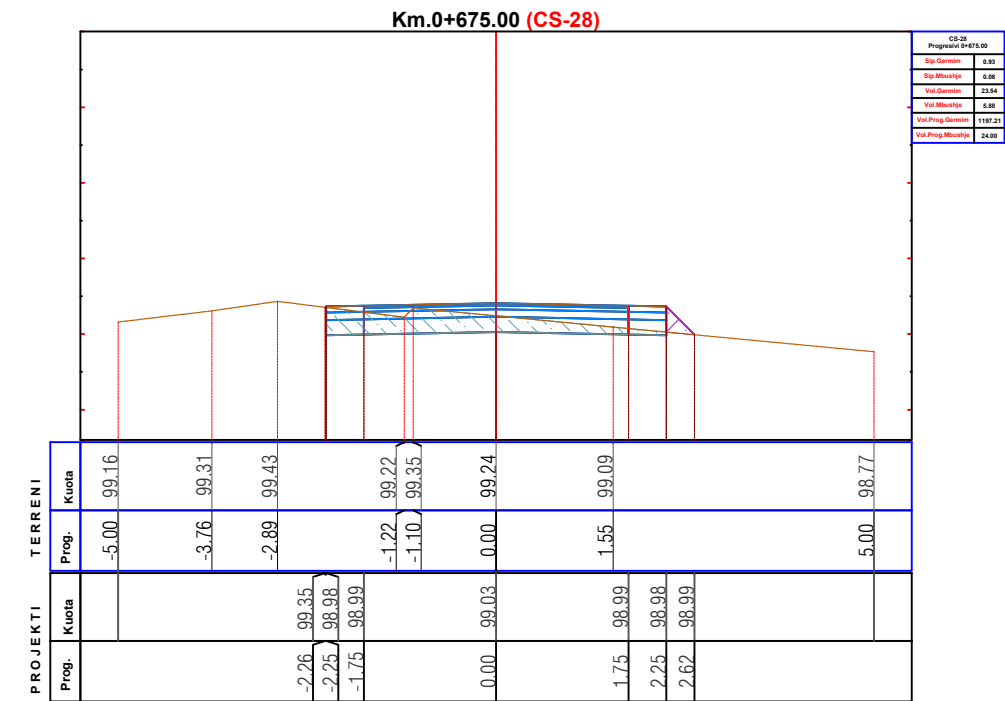
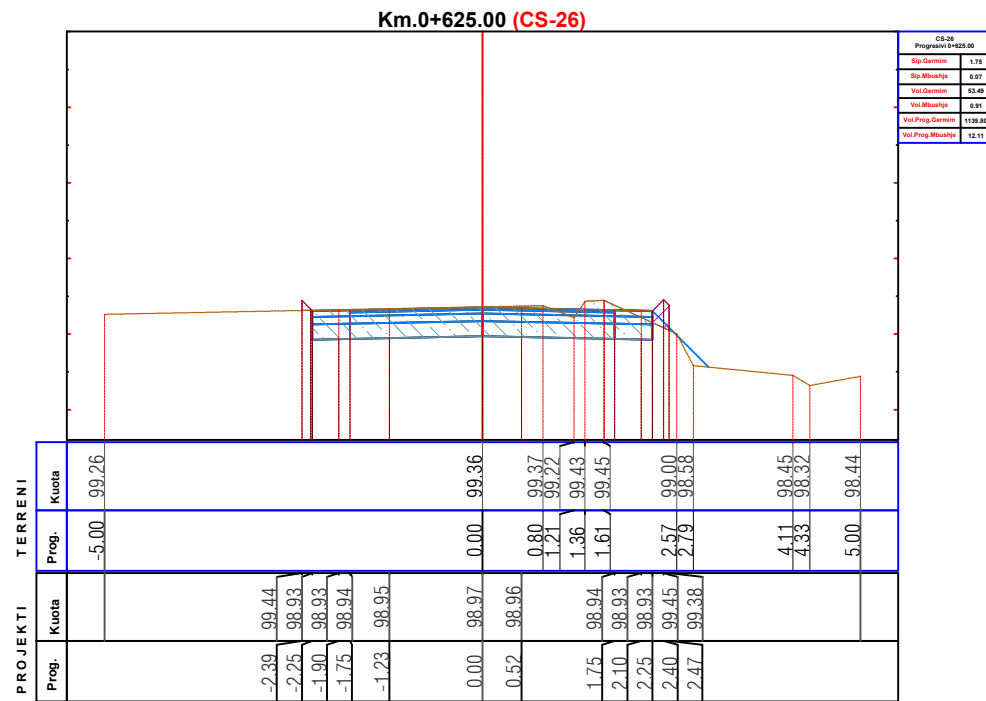
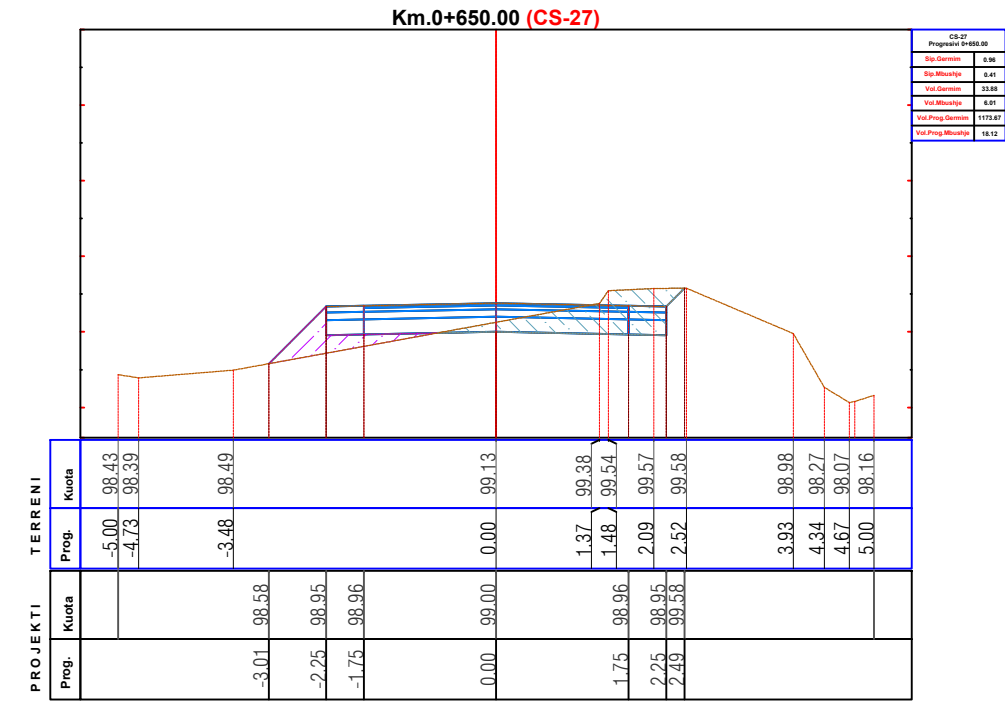
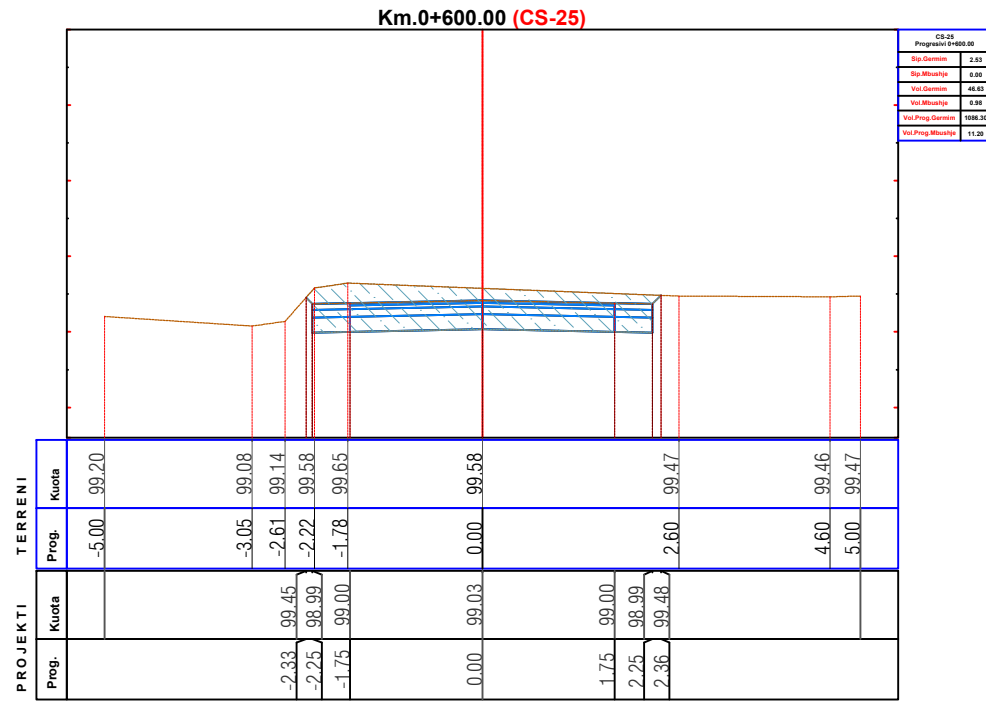

ZetaKonsult sh.p.k
 Address:Rr."Myrteza Topi",Nd 18, Hyrja 7, Ap 38, TIRANE
 Cel:+355 (0)69 33 52 077
 e-mail:zetakonsultshpk@gmail.com



EMERTIMI I OBJEKTIT:
 STUDIM, PROJEKTIM I RRUGEVE RURALE NE NJ.A SHALES
Rikonstruksioni i rruges Lazarec, Fshati Licaj
 FAZA E PROJEKTIT :PROJEKT ZBATIMI

EMERTESA E FLETES:
 PROFILAT TERTHORE PROGRESIV
 SHKALLA Shk:1/100 FLETA 07

DREJTOR PROJEKTI: Ing. Flutura DURO
 Inxh.Ndert.Flutura Duro
 Inxh.Ndert.Lorenc HOXHA

Dt ___/___/2022

FORMATI A3

PROFILAT TERTHORE PROGRESIV SH 1:100

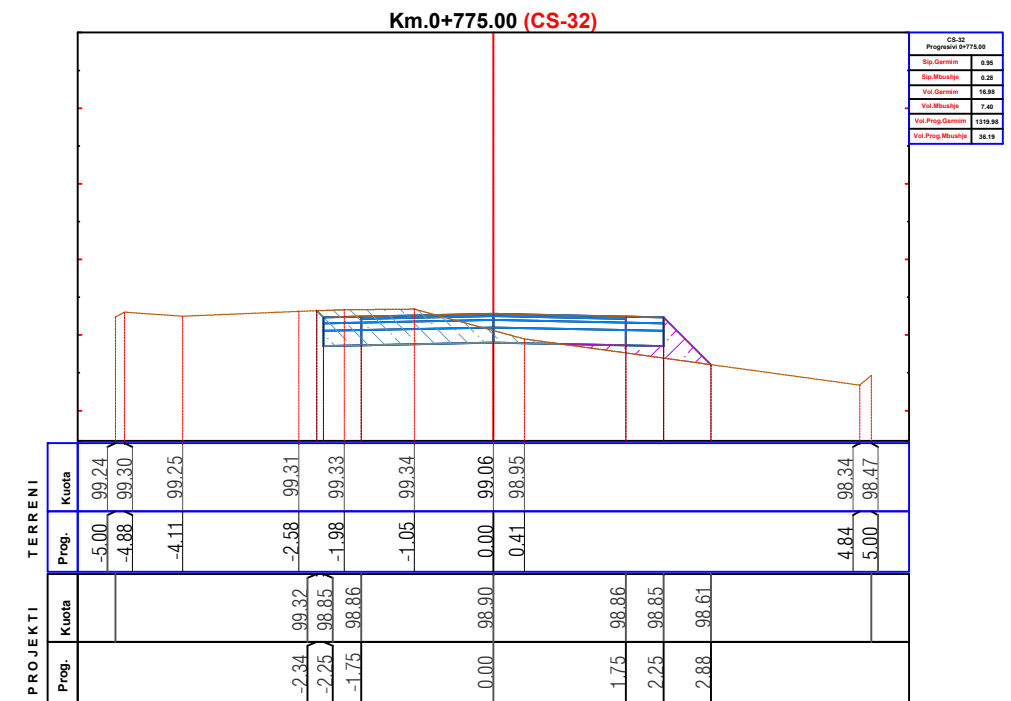
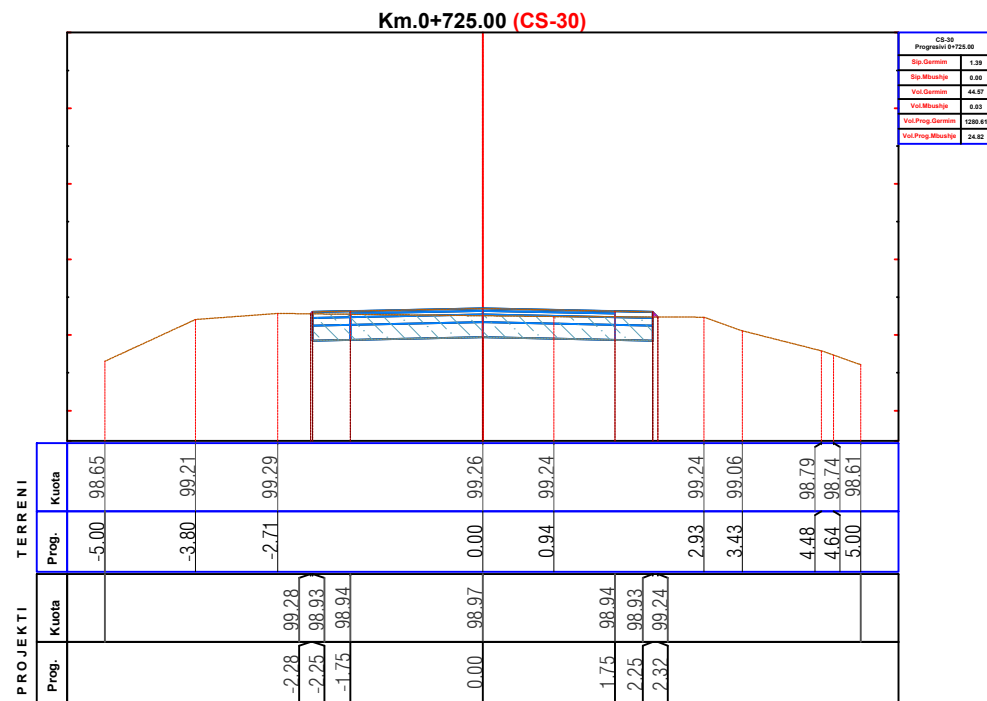
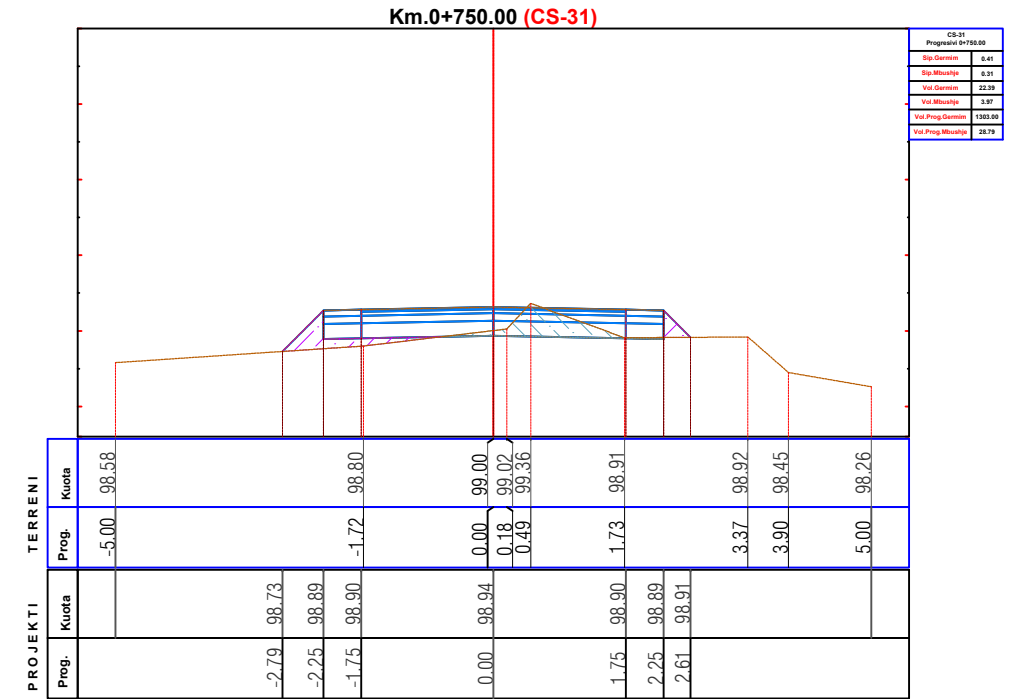
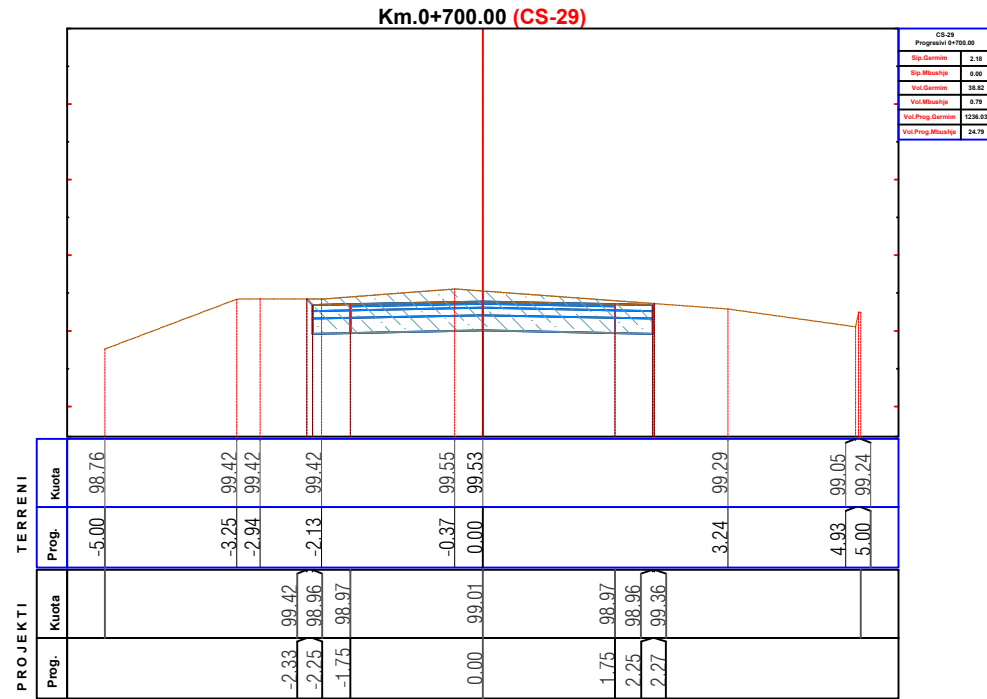

INVESTITOR
BASHKIA ÇËRRIK



ZetaKonsult sh.p.k

Address:Rr."Myrteza Topi",Nd 18, Hyrja 7, Ap 38, TIRANE

Cel: +355 (0)69 33 52 077

e-mail:zetakonsultshpk@gmail.com



EMERTIMI I OBJEKTIT:
STUDIM, PROJEKTIM I RRUGEVE RURALE NE NJ.A SHALES
Rikonstruksioni i rruges Lazarec, Fshati Licaj

FAZA E PROJEKTIT :PROJEKT ZBATIMI

EMERTESA E FLETES:
PROFILAT TERTHORE PROGRESIV

SHKALLA Shk:1/100

FLETA 08

DREJTOR PROJEKTI: Ing. Flutura DURO

Inxh.Ndert.Flutura Duro
Inxh.Ndert.Lorenc HOXHA

Dt ___/___/2022

FORMATI A3

PROFILAT TERTHORE PROGRESIV SH 1:100

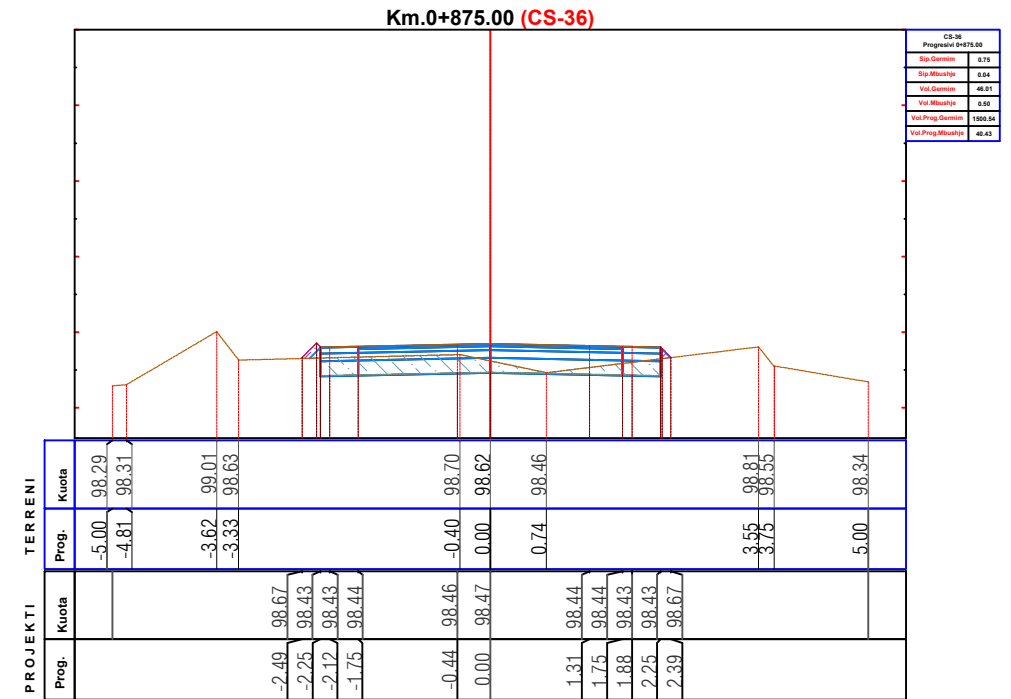
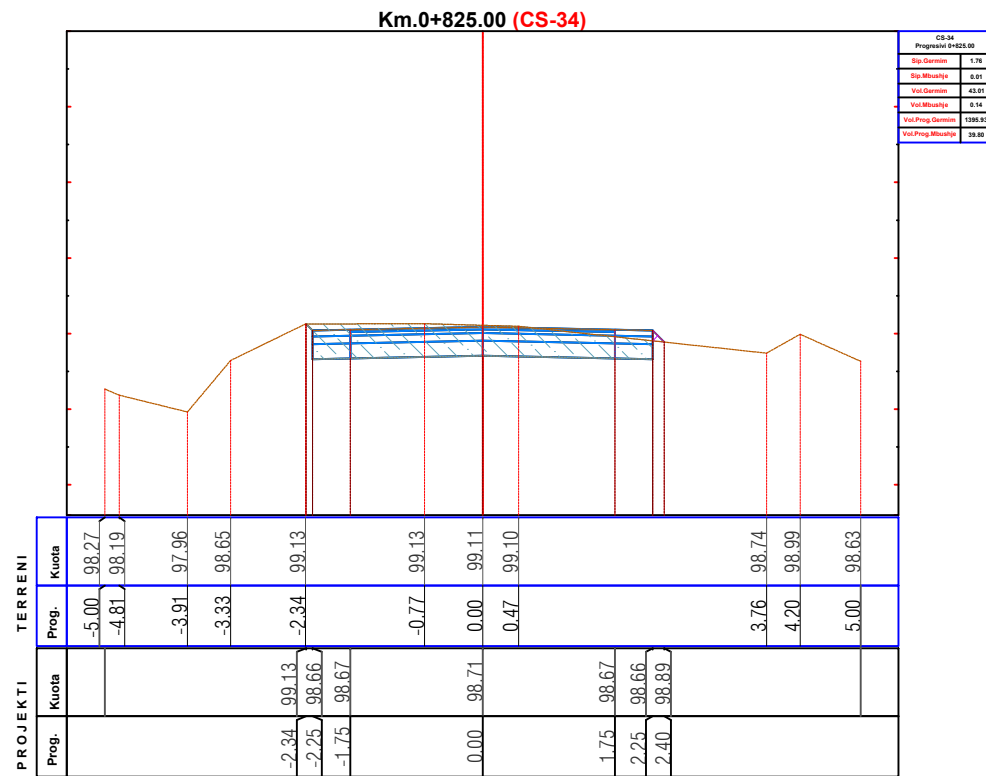
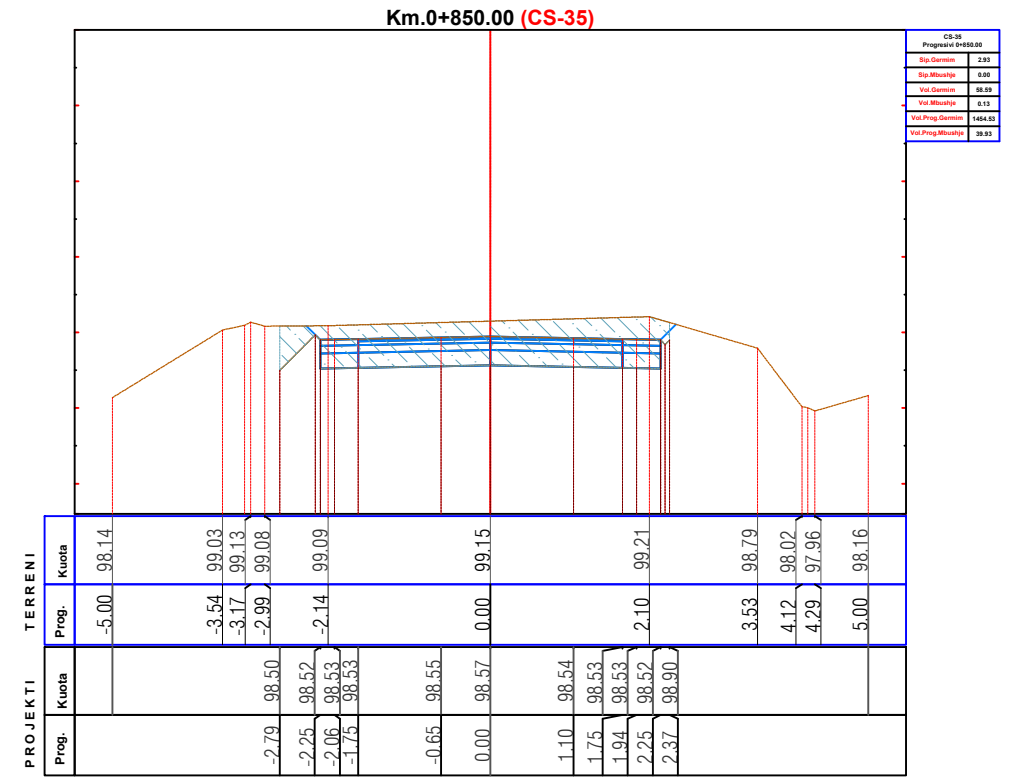
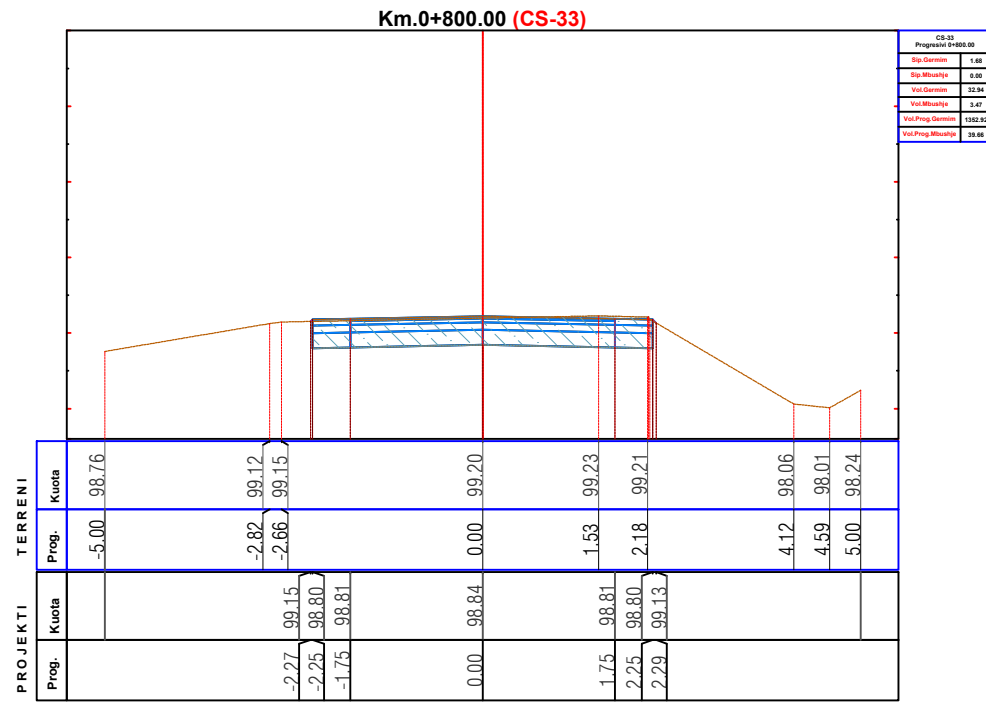

INVESTITOR
BASHKIA ÇËRRIK



ZetaKonsult sh.p.k

Address:Rr."Myrteza Topi",Nd 18, Hyrja 7, Ap 38, TIRANE

Cel:+355 (0)69 33 52 077

e-mail:zetakonsultshpk@gmail.com



EMERTIMI I OBJEKTIT:
STUDIM, PROJEKTIM I RRUGEVE RURALE NE NJ.A SHALES
Rikonstruksioni i rruges Lazarec, Fshati Licaj

FAZA E PROJEKTIT :PROJEKT ZBATIMI

EMERTESA E FLETES:
PROFILAT TERTHORE PROGRESIV

SHKALLA Shk:1/100

FLETA 09

DREJTOR PROJEKTI: Ing. Flutura DURO

Inxh.Ndert.Flutura Duro
Inxh.Ndert.Lorenc HOXHA

Dt ___/___/2022

FORMATI A3

PROFILAT TERTHORE PROGRESIV SH 1:100

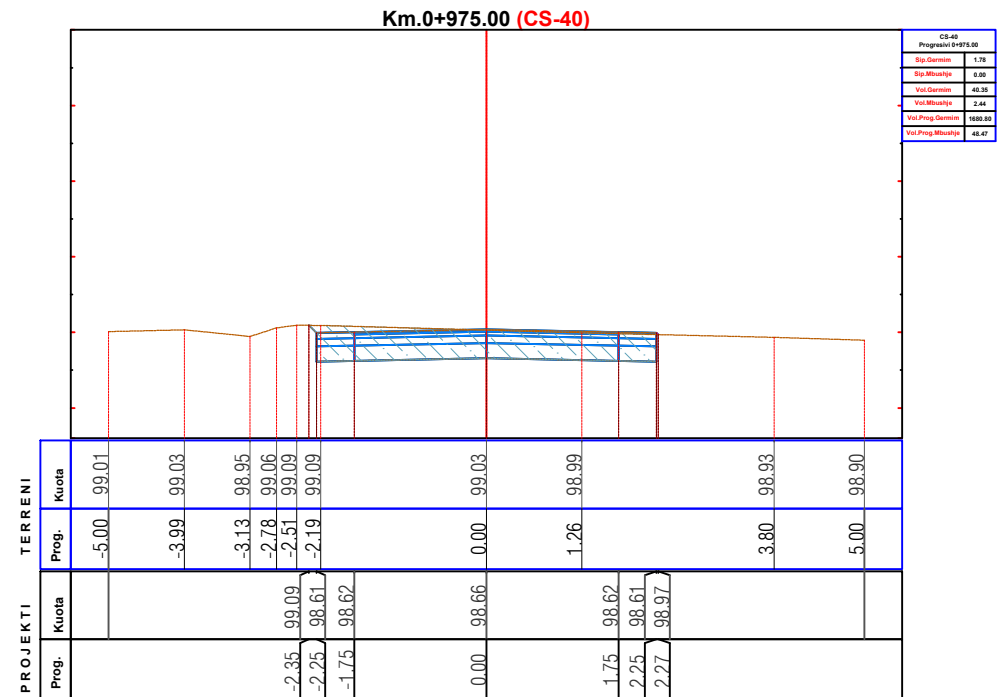
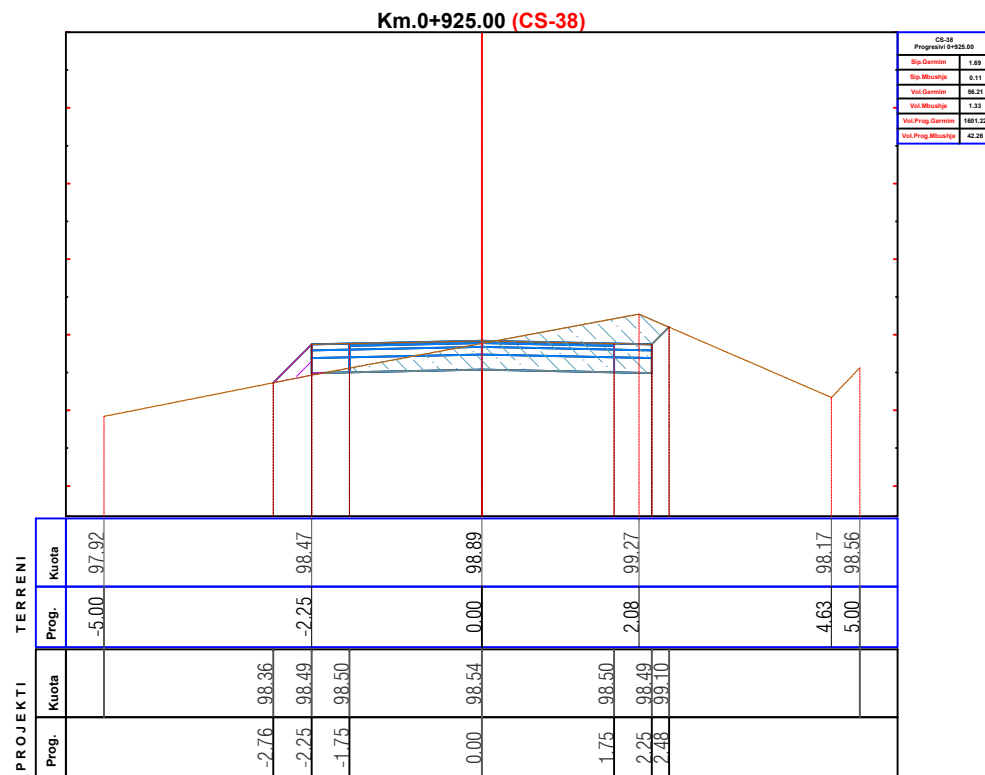
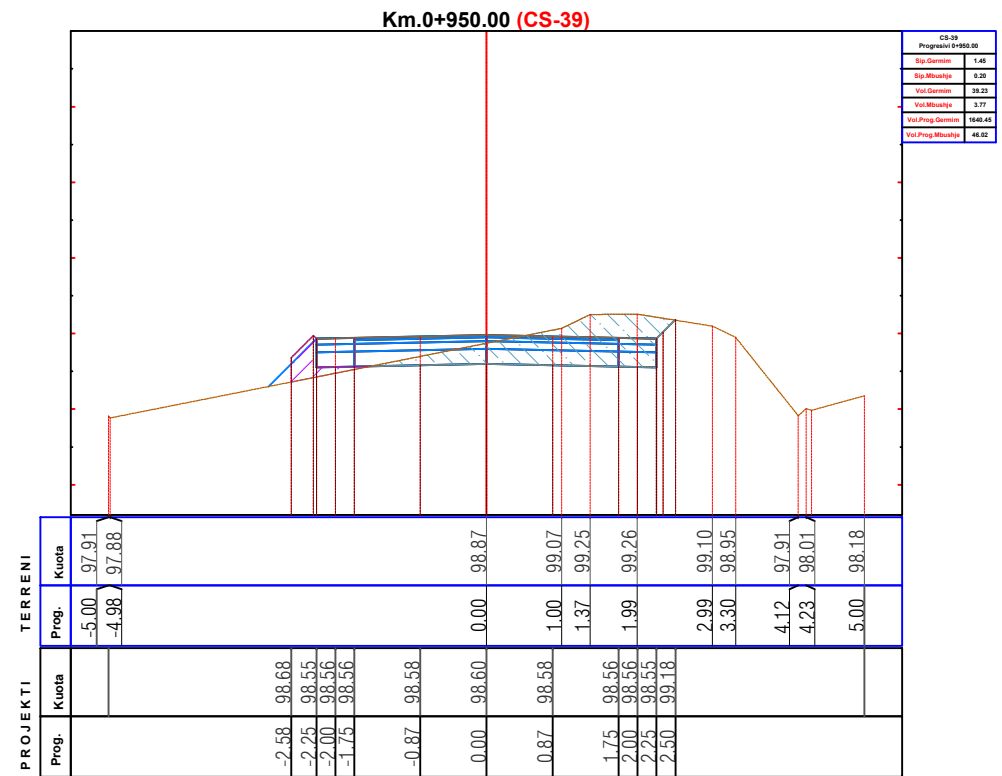
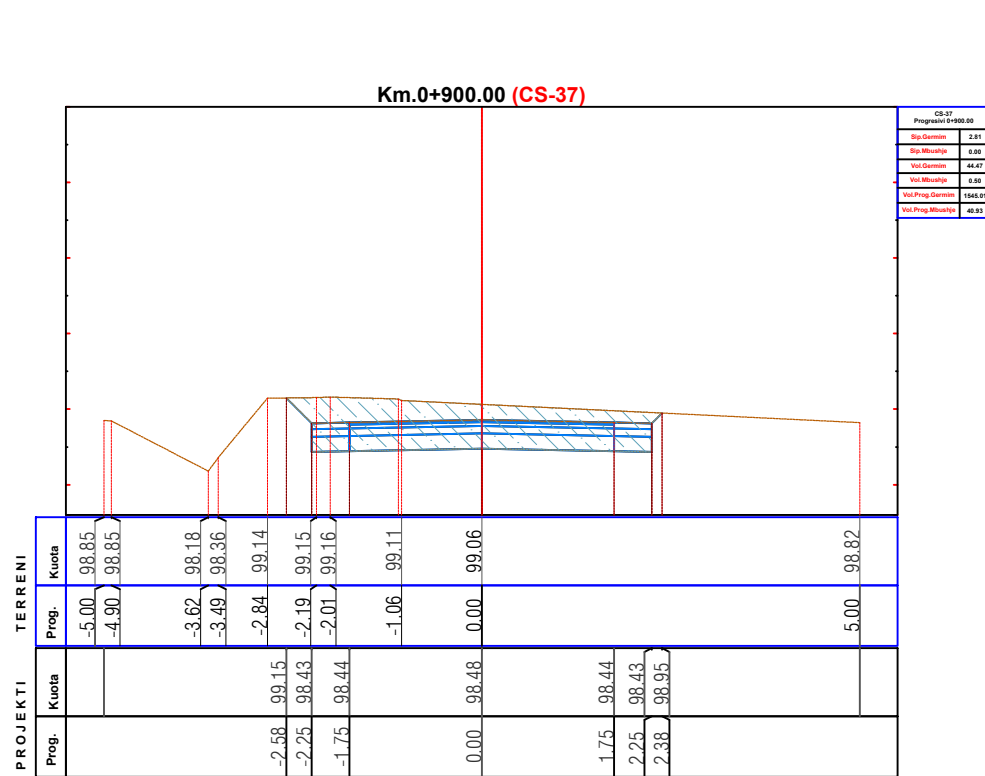

ZetaKonsult sh.p.k
 Address:Rr."Myrteza Topi",Nd 18, Hyrja 7, Ap 38, TIRANE
 Cel:+355 (0)69 33 52 077
 e-mail:zetakonsultshpk@gmail.com



EMERTIMI I OBJEKTIT:
 STUDIM, PROJEKTIM I RRUGEVE RURALE NE NJ.A SHALES
Rikonstruksioni i rruges Lazarec, Fshati Licaj

FAZA E PROJEKTIT :PROJEKT ZBATIMI

EMERTESA E FLETES:
 PROFILAT TERTHORE PROGRESIV

SHKALLA Shk:1/100 FLETA 10

DREJTOR PROJEKTI: Ing. Flutura DURO
 Inxh.Ndert.Flutura Duro
 Inxh.Ndert.Lorenc HOXHA

Dt___/___/2022

FORMATI A3

PROFILAT TERTHORE PROGRESIV SH 1:100

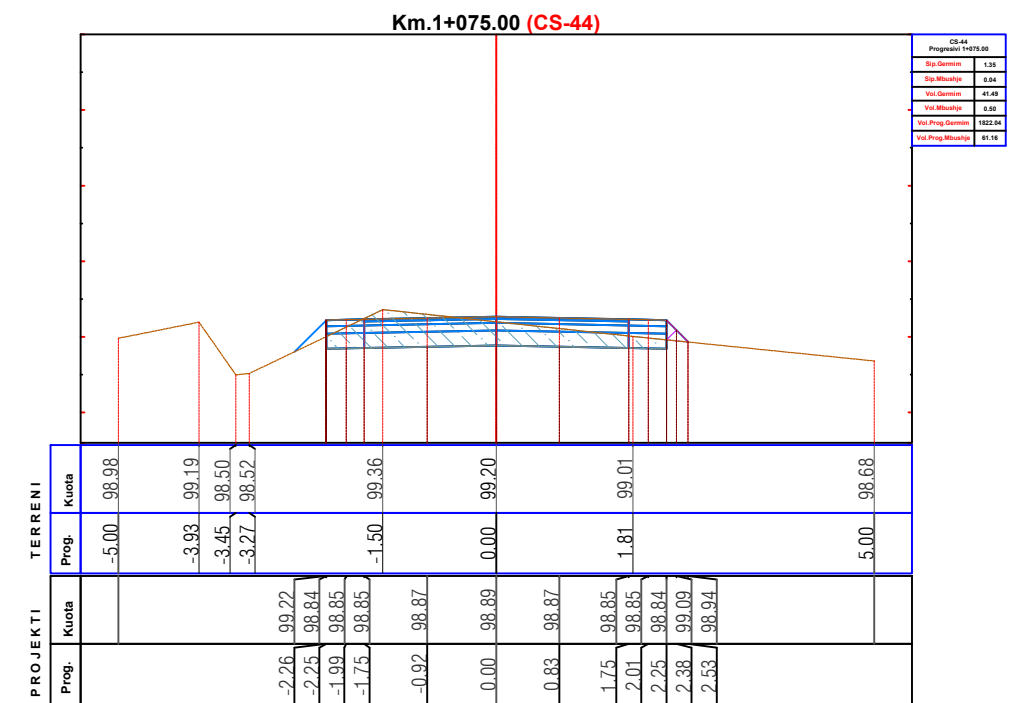
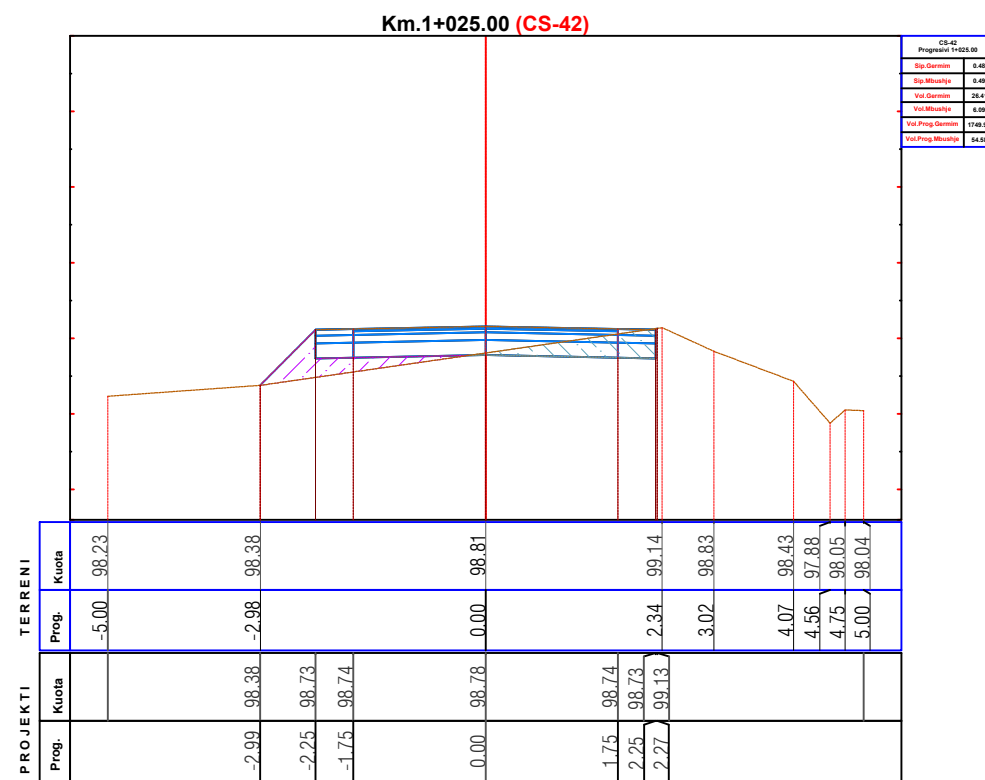
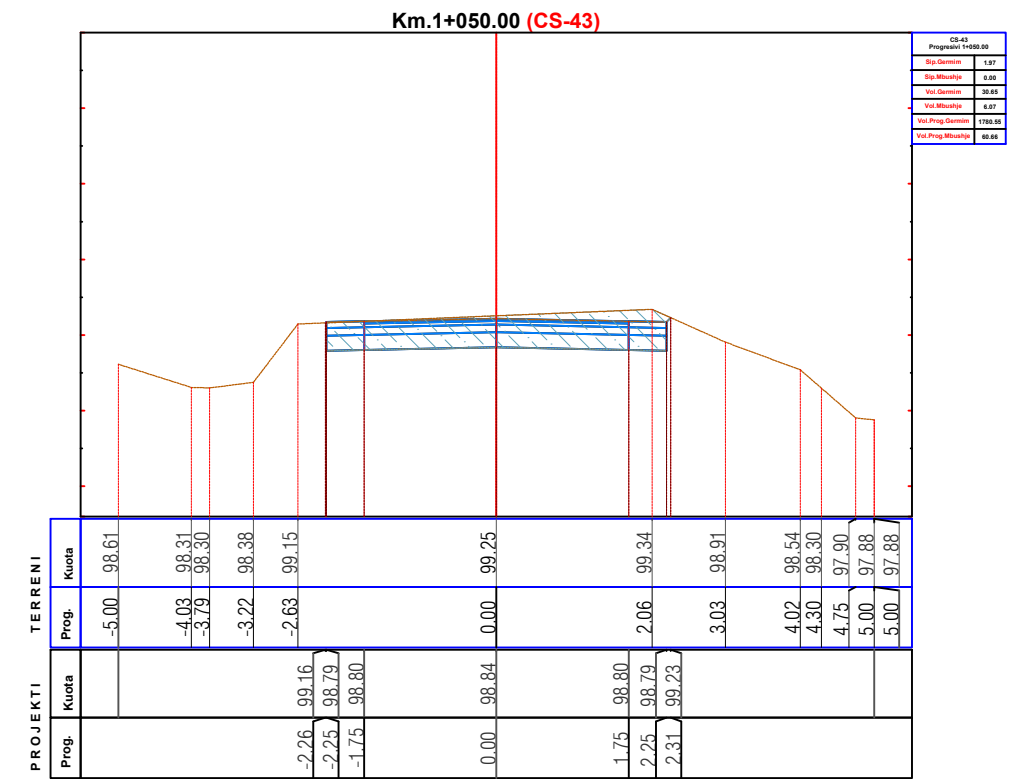
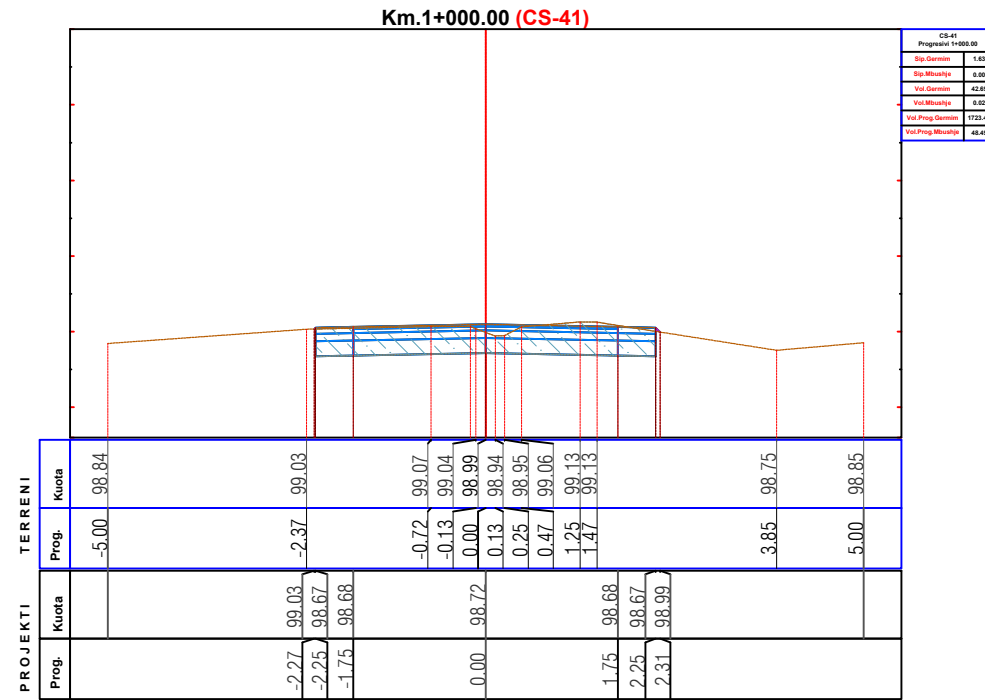

INVESTITOR
BASHKIA ÇËRRIK



ZetaKonsult sh.p.k

Address:Rr."Myrteza Topi",Nd 18, Hyrja 7, Ap 38, TIRANE

Cel: +355 (0)69 33 52 077

e-mail:zetakonsultshpk@gmail.com



EMERTIMI I OBJEKTIT:
STUDIM, PROJEKTIM I RRUGEVE RURALE NE NJ.A SHALES
Rikonstruksioni i rruges Lazarec, Fshati Licaj

FAZA E PROJEKTIT :PROJEKT ZBATIMI

EMERTESA E FLETES:
PROFILAT TERTHORE PROGRESIV

SHKALLA Shk:1/100

FLETA 11

DREJTOR PROJEKTI: Ing. Flutura DURO

Inxh.Ndert.Flutura Duro
Inxh.Ndert.Lorenc HOXHA

Dt ___/___/2022

FORMATI A3

PROFILAT TERTHORE PROGRESIV SH 1:100

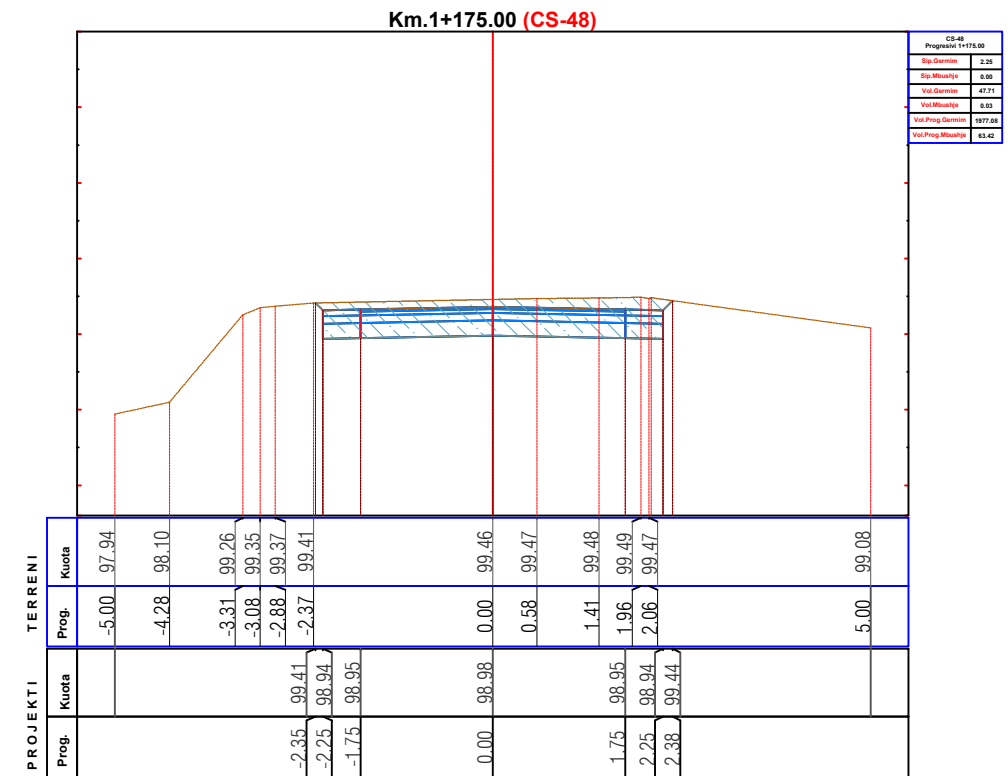
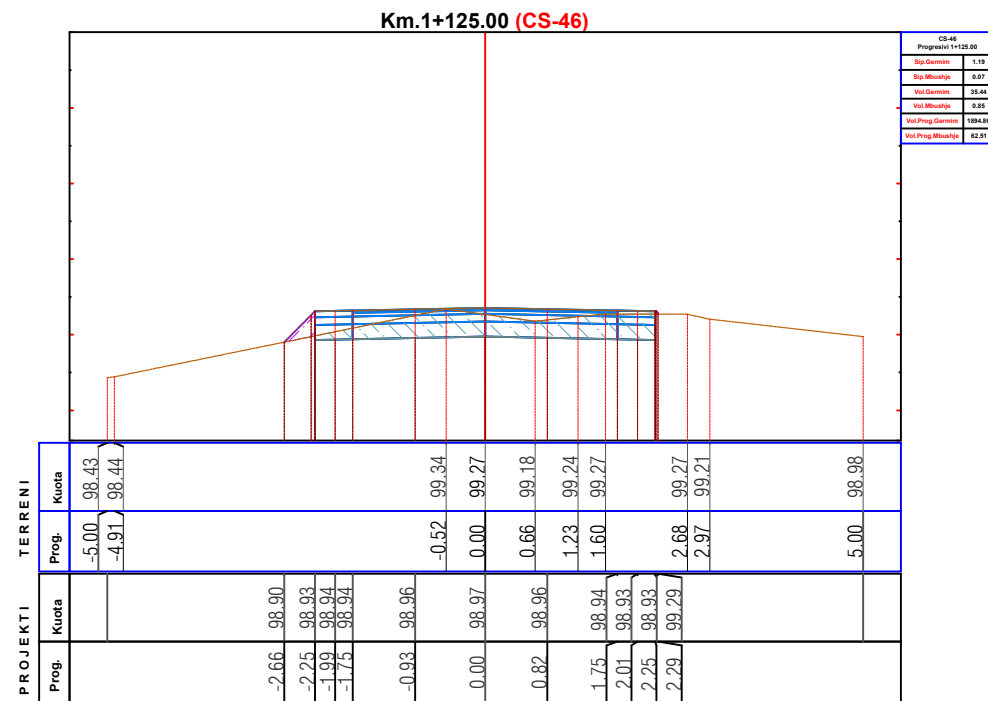
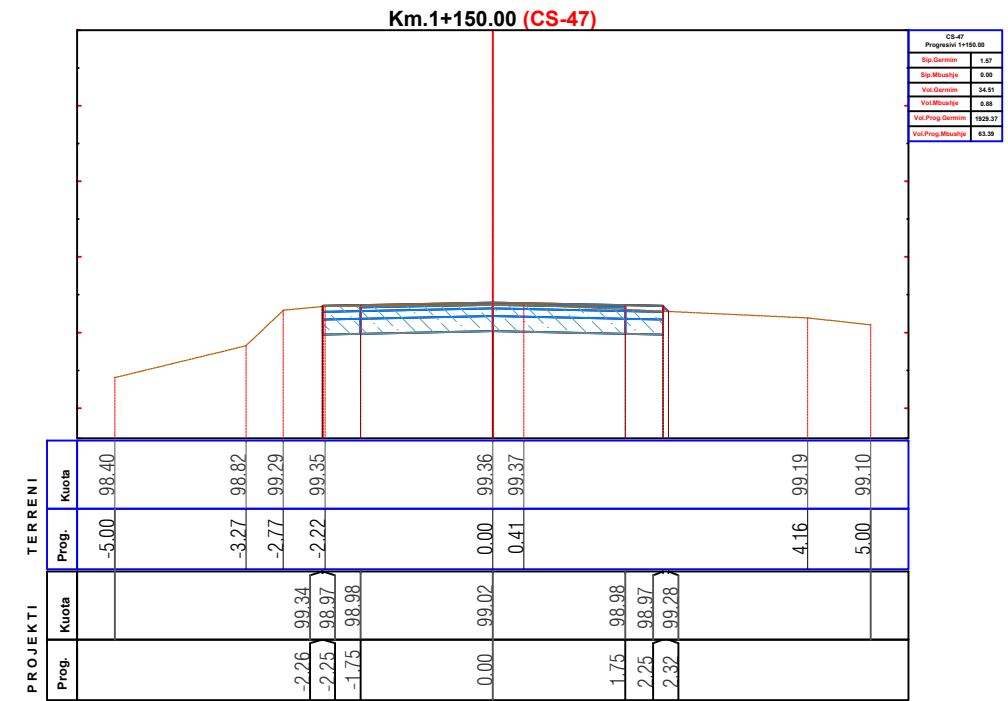
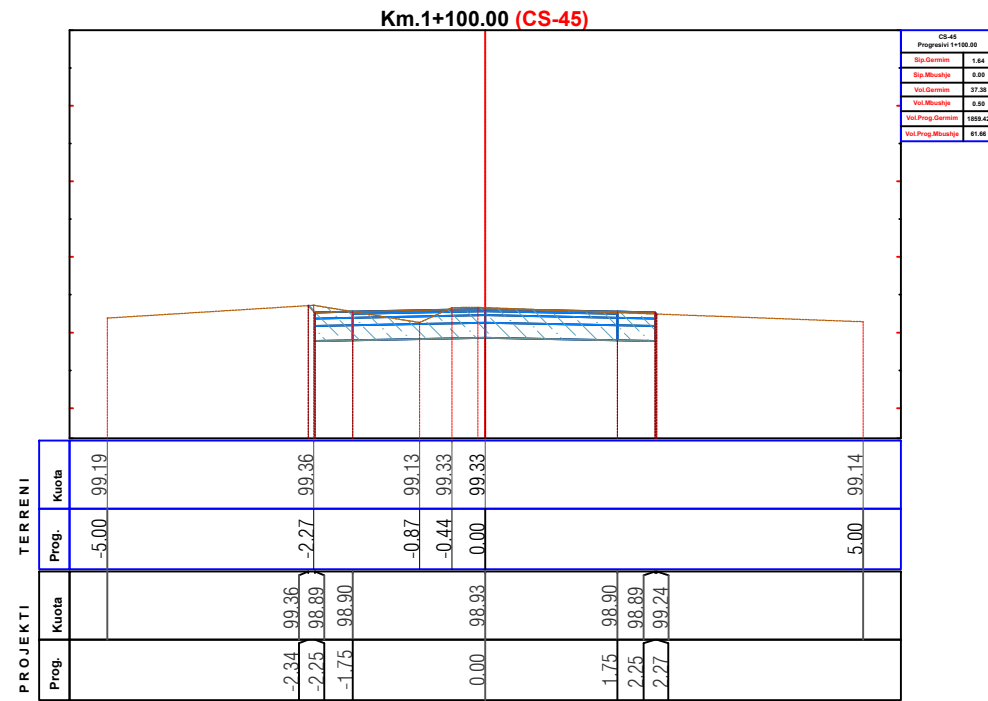

INVESTITOR
BASHKIA ÇËRRIK



ZetaKonsult sh.p.k

Address:Rr."Myrteza Topi",Nd 18, Hyrja 7, Ap 38, TIRANE

Cel: +355 (0)69 33 52 077

e-mail:zetakonsultshpk@gmail.com



EMERTIMI I OBJEKTIT:
STUDIM, PROJEKTIM I RRUGEVE RURALE NE NJ.A SHALES
Rikonstruksioni i rruges Lazarec, Fshati Licaj

FAZA E PROJEKTIT :PROJEKT ZBATIMI

EMERTESA E FLETES:
PROFILAT TERTHORE PROGRESIV

SHKALLA Shk:1/100

FLETA 12

DREJTOR PROJEKTI: Ing. Flutura DURO

Inxh.Ndert.Flutura Duro
Inxh.Ndert.Lorenc HOXHA

Dt ___/___/2022

FORMATI A3

PROFILAT TERTHORE PROGRESIV SH 1:100

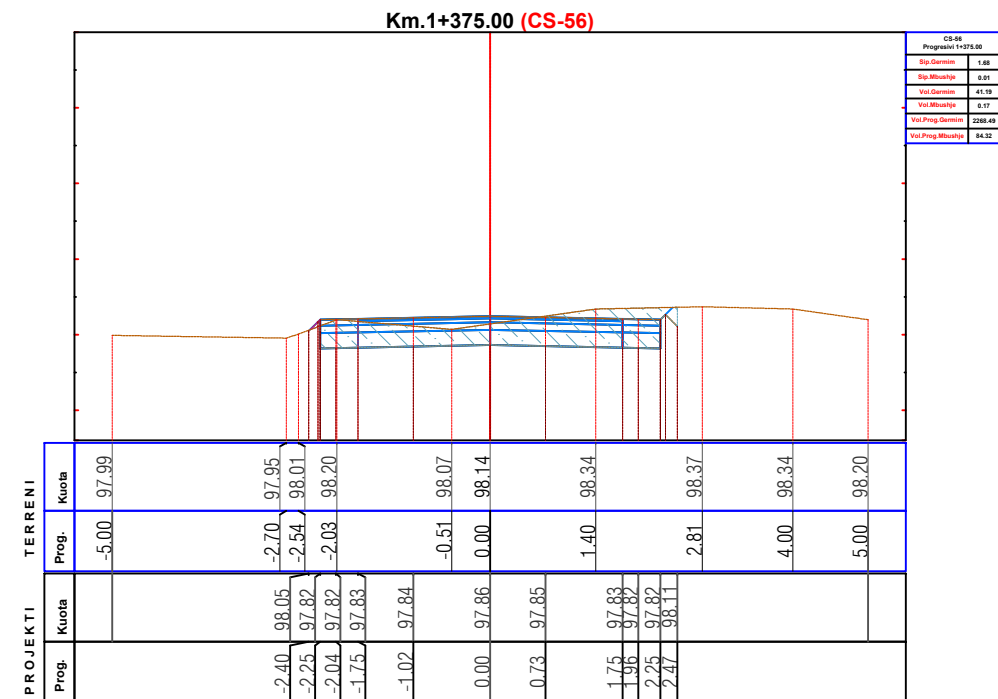
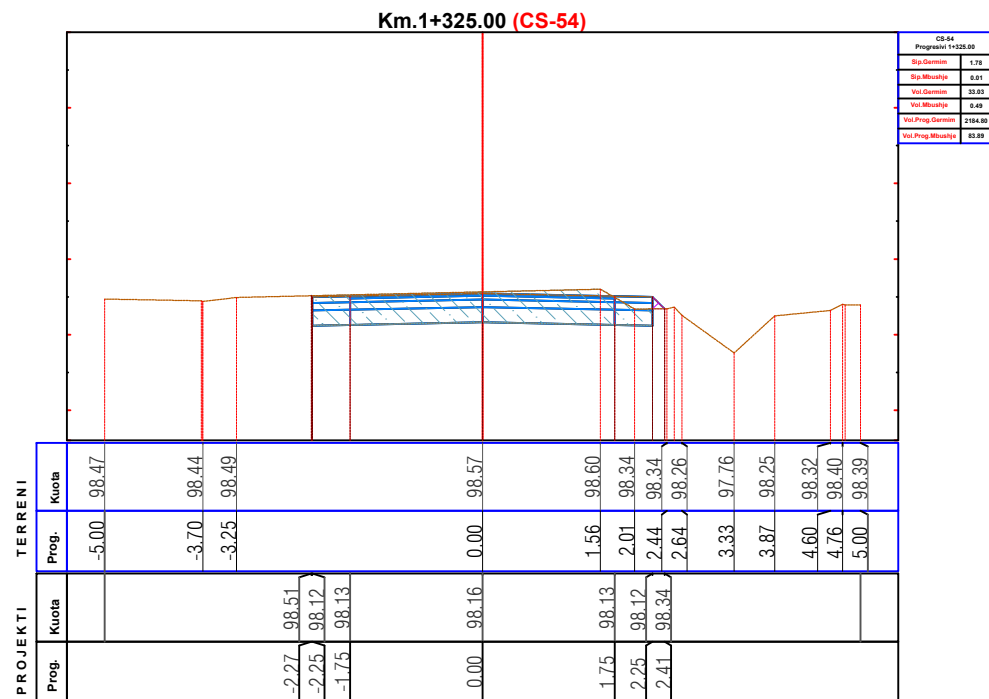
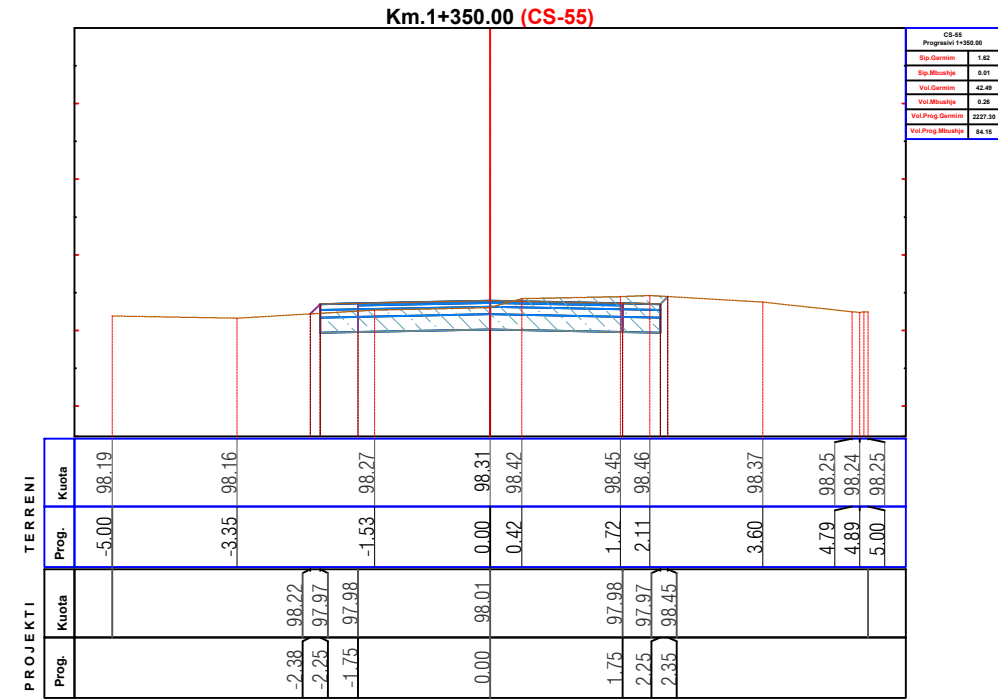
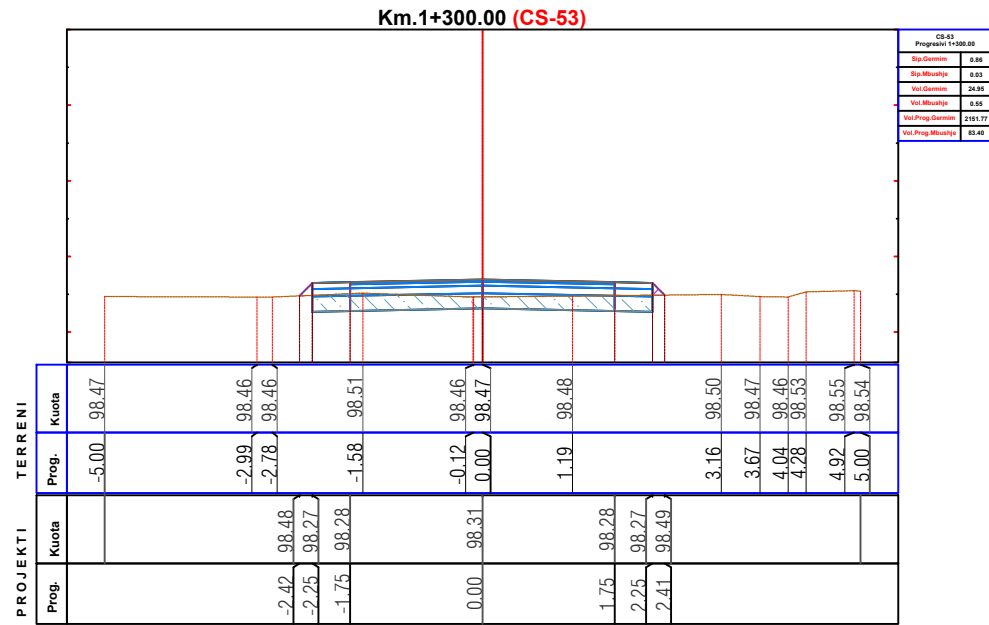

INVESTITOR
BASHKIA ÇËRRIK



ZetaKonsult sh.p.k

Address:Rr."Myrteza Topi",Nd 18, Hyrja 7, Ap 38, TIRANE

Cel: +355 (0)69 33 52 077

e-mail:zetakonsultshpk@gmail.com



EMERTIMI I OBJEKTIT:
STUDIM, PROJEKTIM I RRUGEVE RURALE NE NJ.A SHALES
Rikonstruksioni i rruges Lazarec, Fshati Licaj

FAZA E PROJEKTIT :PROJEKT ZBATIMI

EMERTESA E FLETES:
PROFILAT TERTHORE PROGRESIV

SHKALLA Shk:1/100

FLETA 14

DREJTOR PROJEKTI: Ing. Flutura DURO

Inxh.Ndert.Flutura Duro
Inxh.Ndert.Lorenc HOXHA

Dt ___/___/2022

FORMATI A3

PROFILAT TERTHORE PROGRESIV SH 1:100

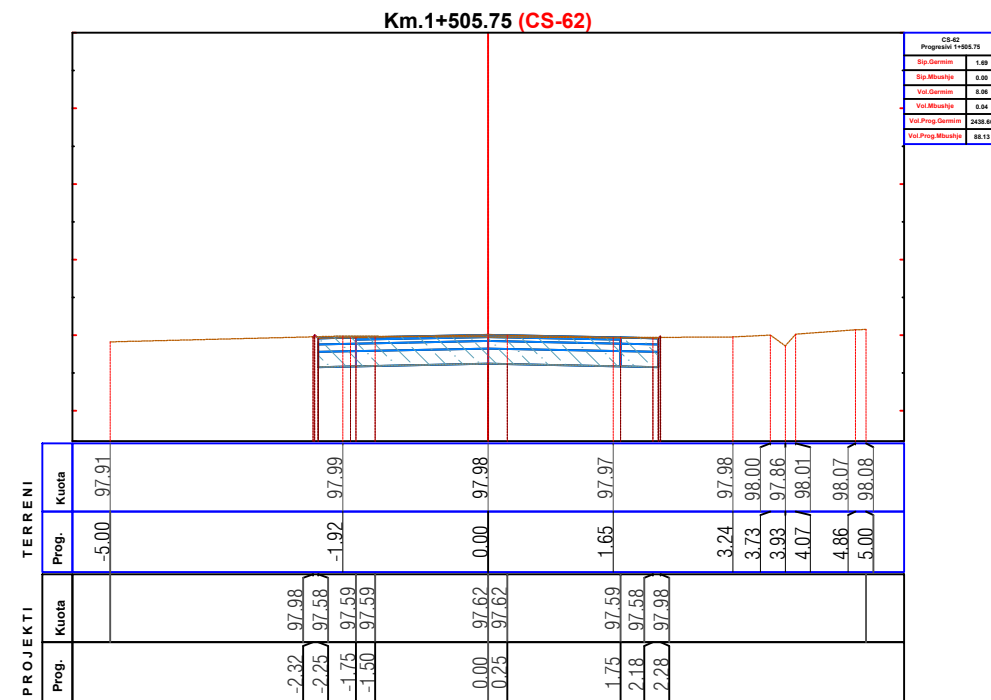
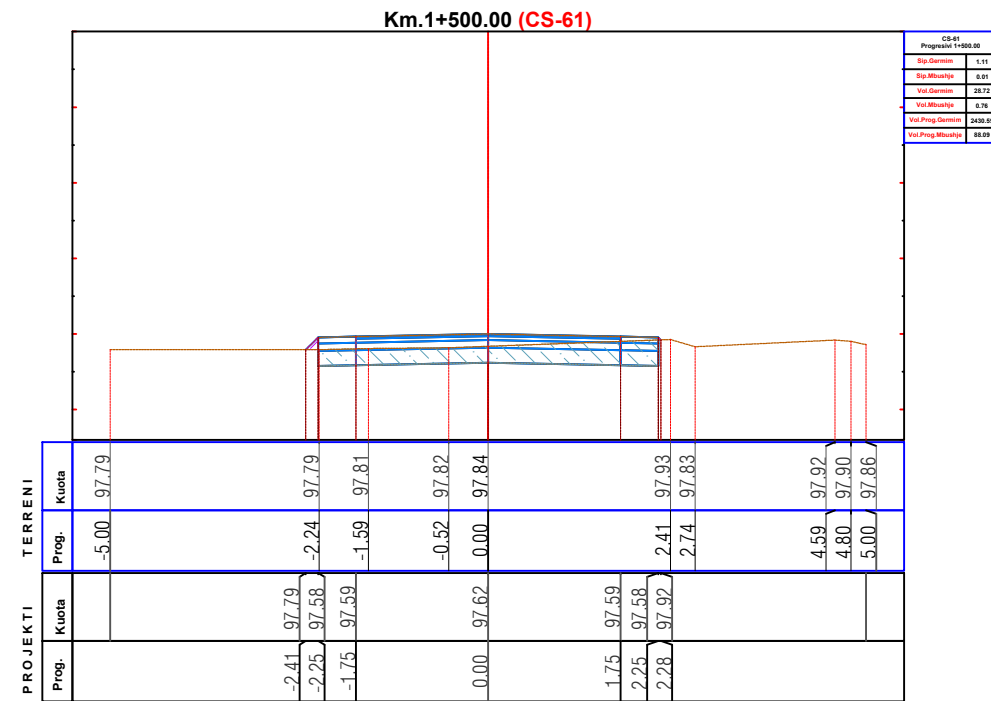

INVESTITOR
BASHKIA ÇËRRIK



ZetaKonsult sh.p.k

Address:Rr."Myrteza Topi",Nd 18, Hyrja 7, Ap 38, TIRANE

Cel:+355 (0)69 33 52 077

e-mail:zetakonsultshpk@gmail.com



EMERTIMI I OBJEKTIT:
STUDIM, PROJEKTIM I RRUGEVE RURALE NE NJ.A SHALES
Rikonstruksioni i rruges Lazarec, Fshati Licaj

FAZA E PROJEKTIT :PROJEKT ZBATIMI

EMERTESA E FLETES:
PROFILAT TERTHORE PROGRESIV

SHKALLA Shk:1/100

FLETA 16

DREJTOR PROJEKTI: Ing. Flutura DURO

Inxh.Ndert.Flutura Duro
Inxh.Ndert.Lorenc HOXHA

Dt ___/___/2022

FORMATI A3

PRERJE GJATESORE E TOMBINOS

SH. 1:50

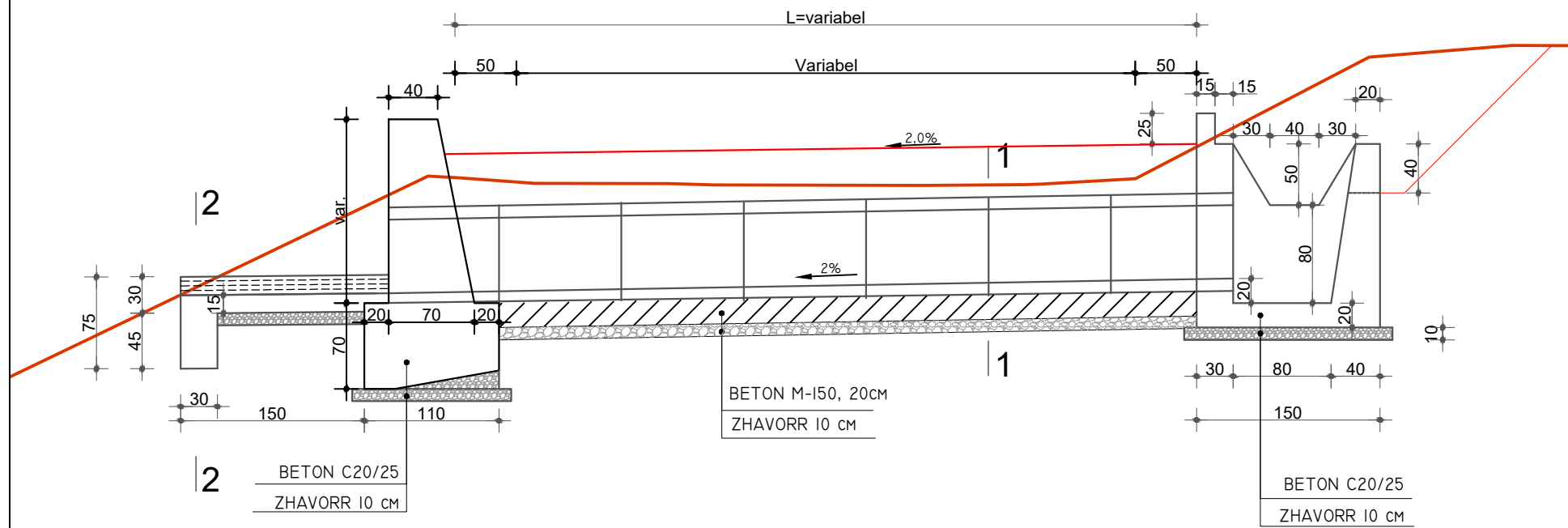

Prerje 1-1

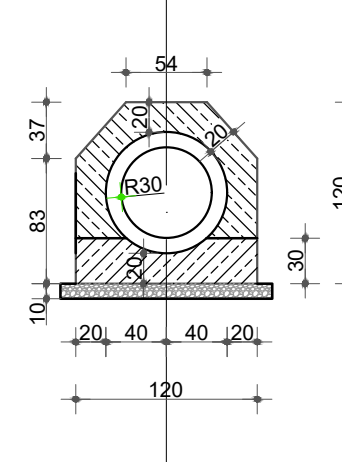

Prerje 2-2

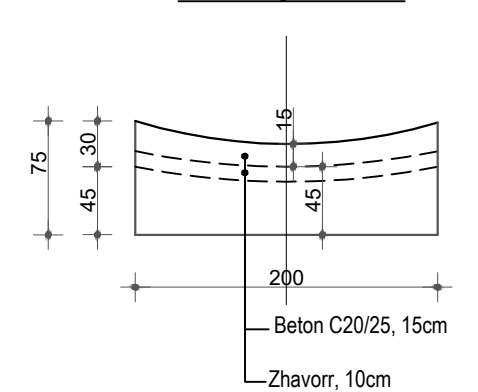

KONSTRUKSION I ZBULUAR

SH. 1:50

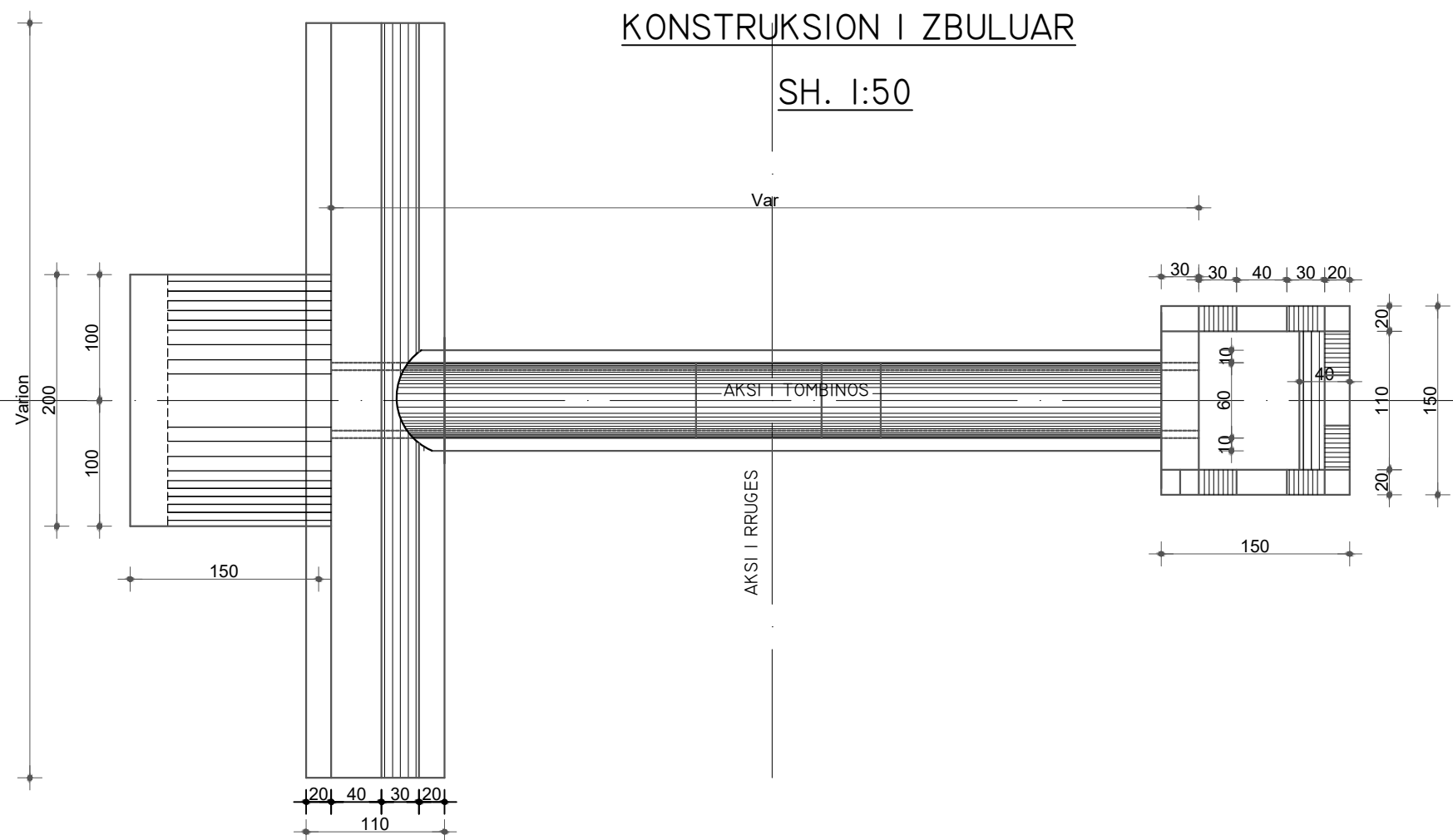

PAMJA E PORTALIT

SH. 1:50

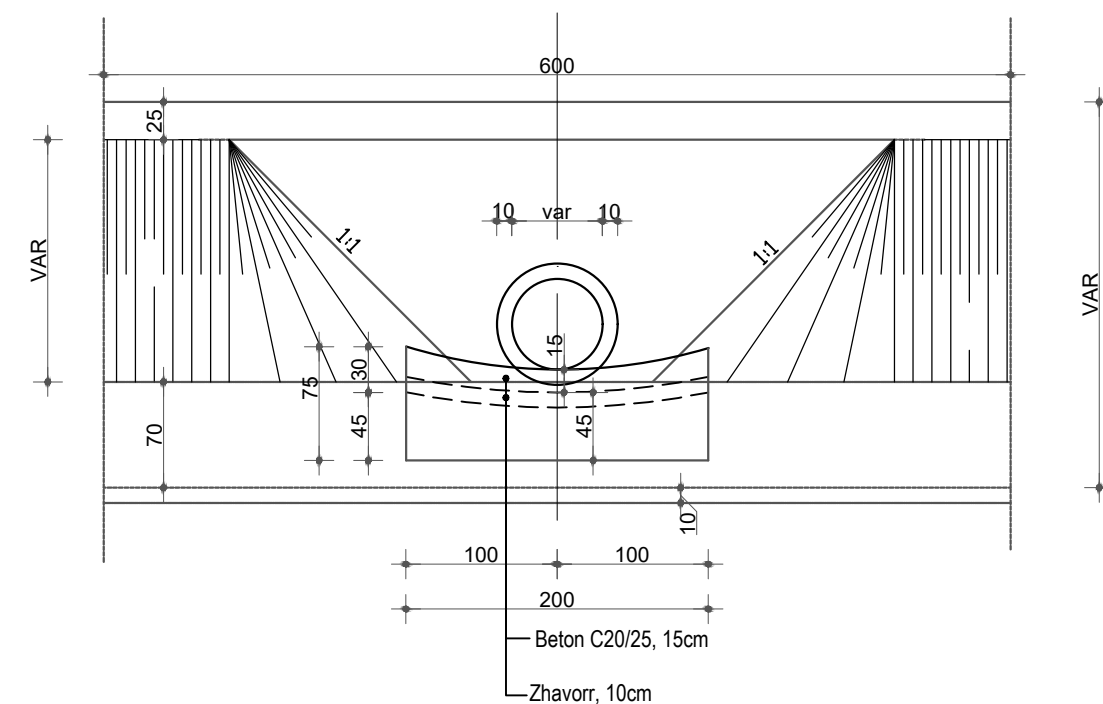

INVESTITOR
BASHKIA ÇËRRIK



ZetaKonsult sh.p.k

Address:Rr."Myrteza Topi",Nd 18, Hyrja 7, Ap 38, TIRANE

Cel: +355 (0)69 33 52 077

e-mail:zetakonsultshpk@gmail.com



EMERTIMI I OBJEKTIT:
STUDIM, PROJEKTIM I RRUGEVE RURALE NE NJ.A SHALES
Rikonstruksioni i rruges Lazarec, Fshati Licaj

FAZA E PROJEKTIT :PROJEKT ZBATIMI

EMERTESA E FLETES:
Tombino rrethore dn500mm

SHKALLA Shk:1/50

FLETA 1

DREJTOR PROJEKTI: Ing. Flutura DURO

Inxh.Ndert.Flutura Duro
Inxh.Ndert.Lorenc HOXHA

Dt ___/___/2022

FORMATI A3