



Bashkia Rroshkovec

# OBJEKTE ASFALTIMI I RRUGËVE TË BRENDESHME NË LAGJET E BASHKISË RROSKOVEC (RRUGA BAKALLARET)



Projekti:  
ASFALTIMI I RRUGËVE TË BRENDESHME NË  
LAGJET E BASHKISË RROSKOVEC

Grupi i Projektimit:  
Ingj. Gëzim Hoxha  
Ingj. Erald Hoxha  
Ingj. Edmond Kallaku

Grupi i PZSHIT:  
Inxhinjeri Hoxha

Titull i fletës:  
WWW.PWU

Datë: 06/02/2023  
Shtetë: SHqipëria

Fletë Nr. 00

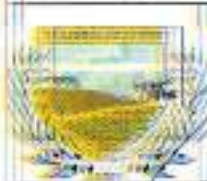

Ministria e Bujqësisë, Pyllësisë dhe Zhvillimit Rural  
 Ministri: **Edi Rama**  
 Zëvendës Ministri: **Ilir Meta**



Projektet:  
**ANALIZATIM I RRUGËS ME TË BRINDËSHMËNË  
 NË BASHKËTËRRITOREN SHKËRRIZ**

Grupi i Projektimit:  
 Inxhinj. Ektor Hoxha  
 Inxhinj. Evis Haxhi  
 Inxhinj. Edmond Krasniqi

Komiteti i PRZHT:  
 Enxhinj. Haxhi

Titullfjete:  
**ZENJENJ I PROJEKTIT (DOKUMENTI  
 ZHT15)**

Dëre:  
 Shkallë

15/12/2023

Titull i Dokumentit:





REPUBLIKA E SHQIPËRIE  
Ministria e Transportit dhe Infrastruktura  
Kryeministria

Projekti:  
KONSTRUKIMI I RRUGËS E TË BERRËSSHME NË  
LINDJE TË KRAJINËS FROKUMEC

Grupi i Përgjithshëm:  
Zhgj. Enxhel Hoxha  
Zhgj. Tahir Haxhiu  
Zhgj. Elidon Krasniqi

Titulli i Rezantit:  
Emërtimi i Projektit

Titulli i Fletës:  
PILANIMETRIA E PËRREGJITUR NË

Dhate: 05/02/2023  
Shtetë: SHqipëria

Fletës Nr:  
03

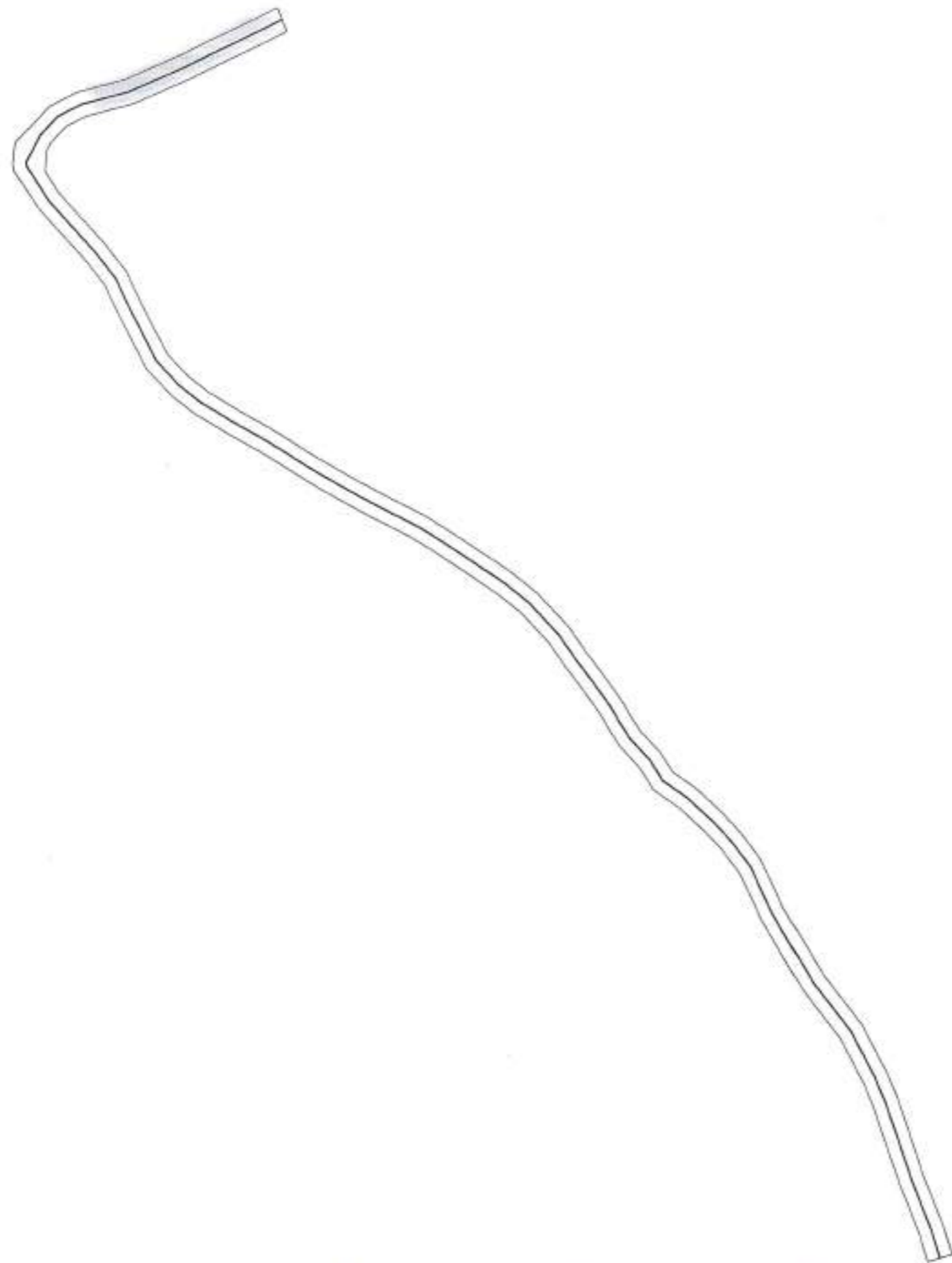

Prapshiteti : KONSTRUKTIVI I RREZERVUARIT TË FERRITIT SHKËMBOR LIVELLET E RREZERVUARIT TË RREZERVUARIT	Grupi i Propozimit : Inxhinjeri i Rrezeve Inxhinjeri i Nivelimit Inxhinjeri i Rrezeve / Konstruksion	Shprehës : Inxhinjeri i Rrezeve	Titulli i Rrezeve : KONSTRUKTIVI I RREZERVUARIT TË RREZERVUARIT	Dieta : 08/12/2023	Shprehës : 04
--	---	------------------------------------	--	-----------------------	------------------

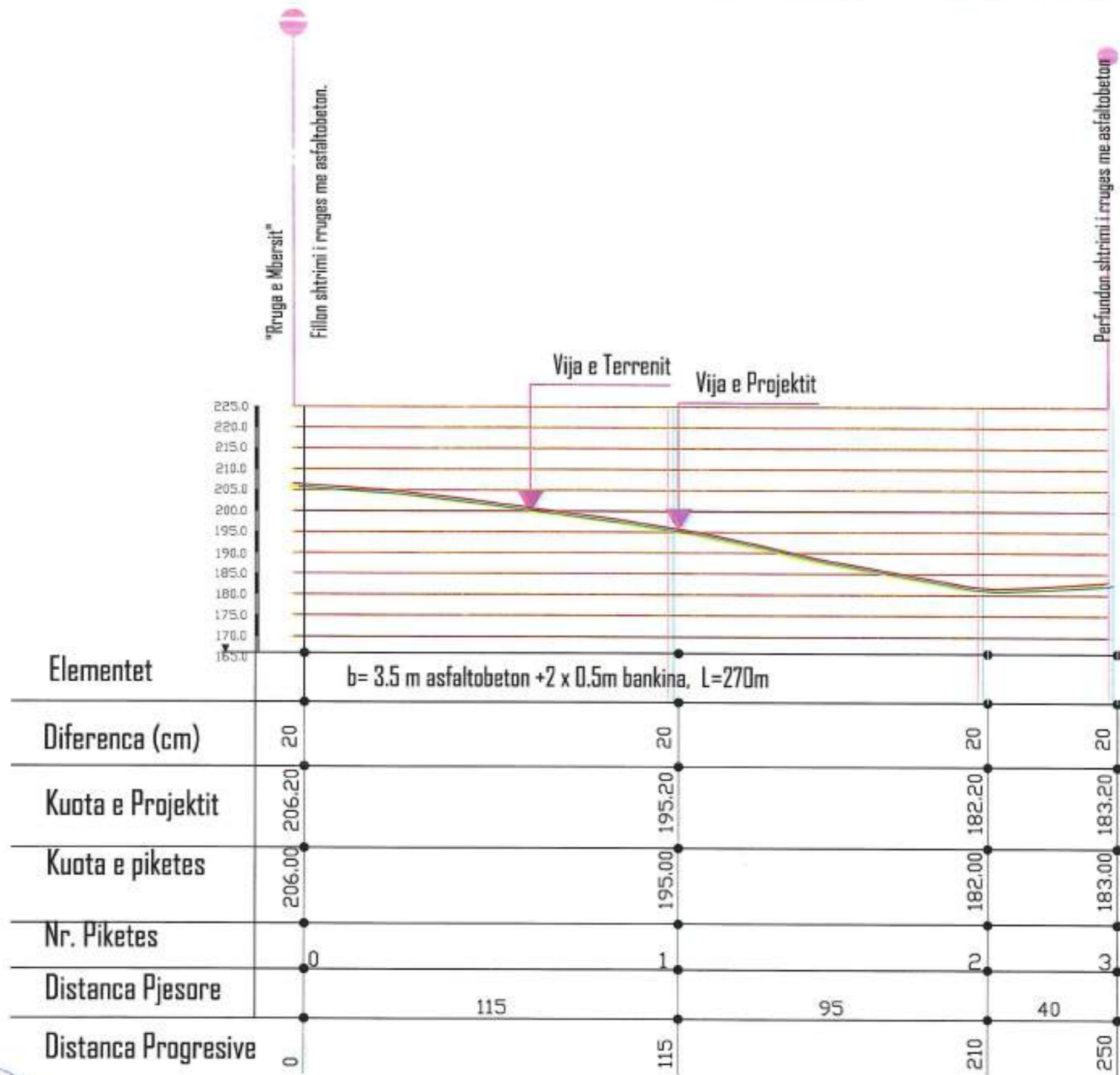

Projekti :  
**ANSHALIMI I RRUJES VEËTE BREVDES NAFITË**  
**LANALLET E BREVDES NAFITË**

Grupi i Projektimit :  
 Inzh. Ferit Hoxha  
 Inzh. Zvezda Hoxha  
 Inzh. Zvezda Hoxha

Udhëton : **PRZANI**  
 Inzh. Hoxha

Titulli i poste :  
**PRORRIETAR I PUNËS**

Data : **18/10/2023**  
 Shtetë : **SHQIPËRI**

Filalet : **4/3/1r**  
**05**

**PROFILI TIP RRUGA "BAKALLARET"**

**PRERJA E MURIT**

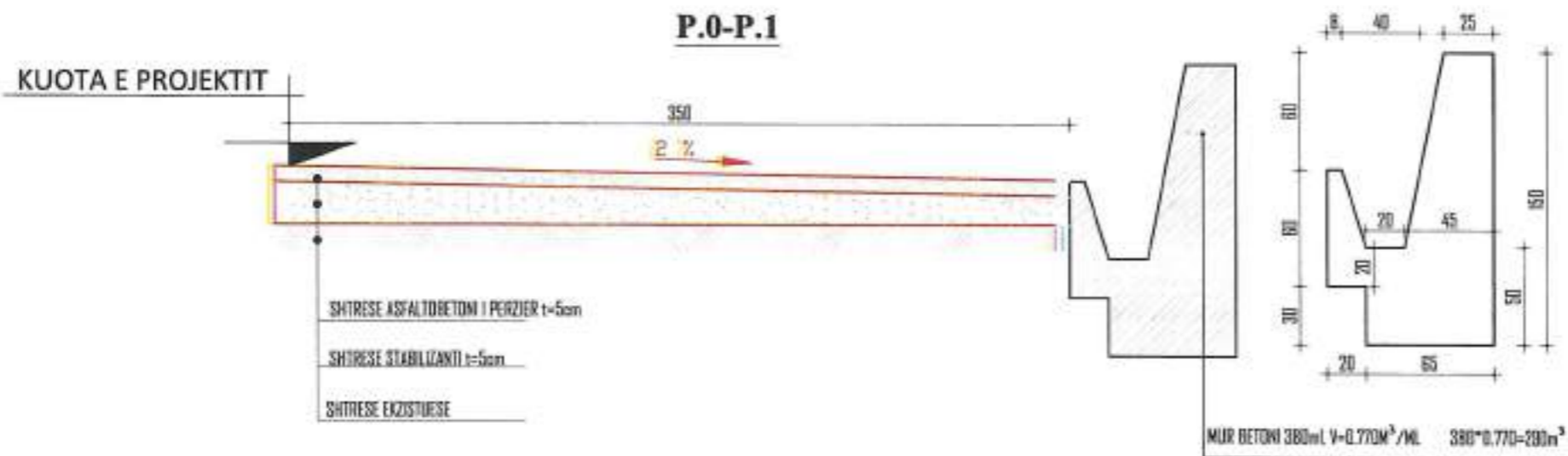

**PROFILI TIP P.1-P.2**

**RRUGA "Bakallaret"**

**PRERJA E MURIT**

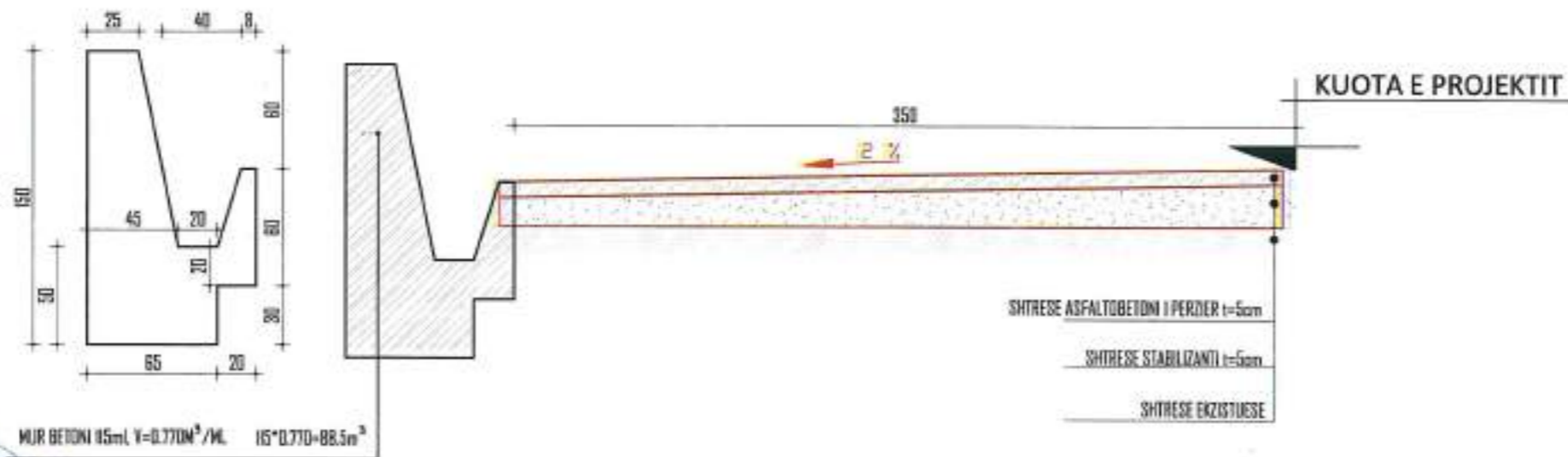

Ministria e Transportit dhe Infrastruktura  
Drejtoria e Përgjithshme e Rrugëve

Projekti:  
RRETHIMI I RRUGËVE E BARRANDESHMARE  
NË QYLLIN E BARRANDESHMARE

Grupi i Projektimit:  
Ingg. Elina Hoxha  
Ingg. Cvet Hoxha  
Ingg. Edlira Numanj

Drejtori i RRETHIMIT:  
Ingg. Elina Hoxha

Titulli i detyrës:  
PRORIENTIM I TIPIT I RRUGËS

Datë: 08/10/2023  
Shtetësi:

Fila e 43/44  
**06**

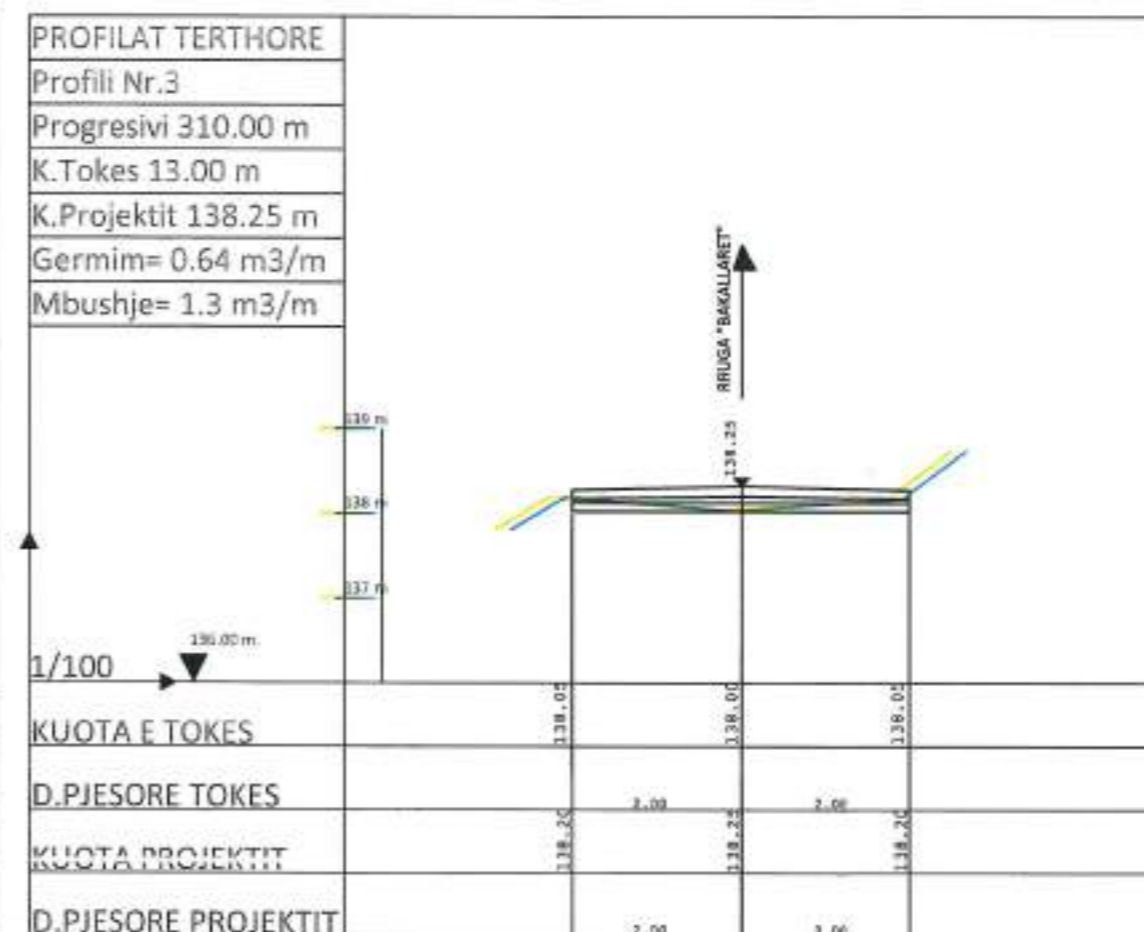
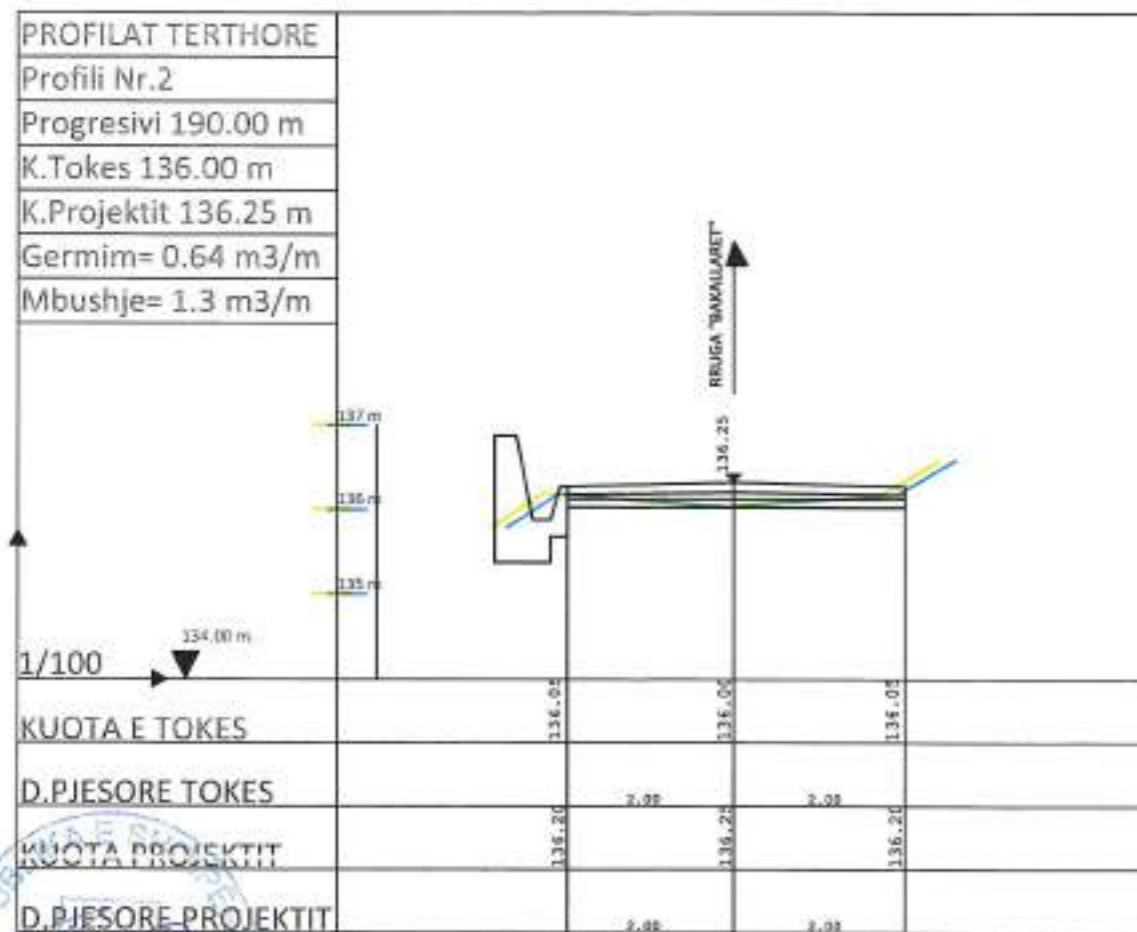
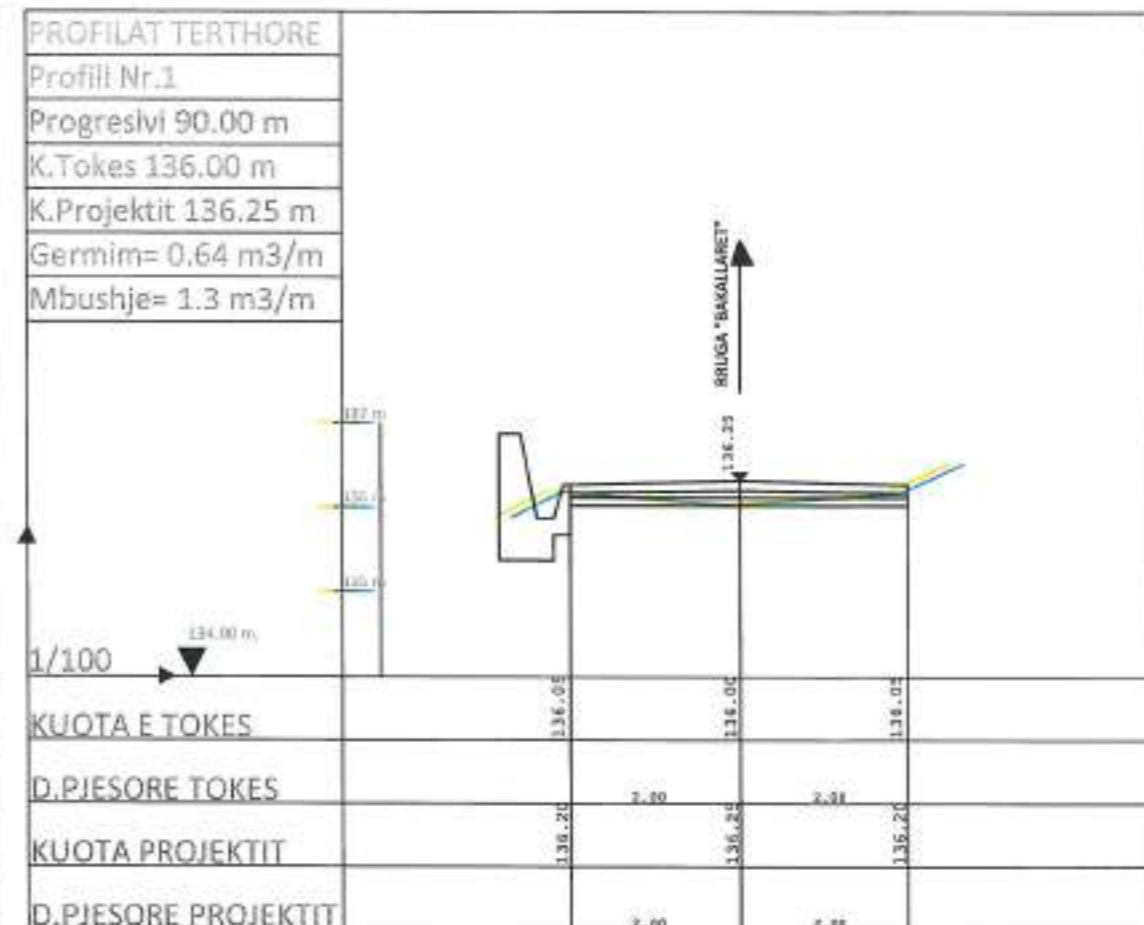
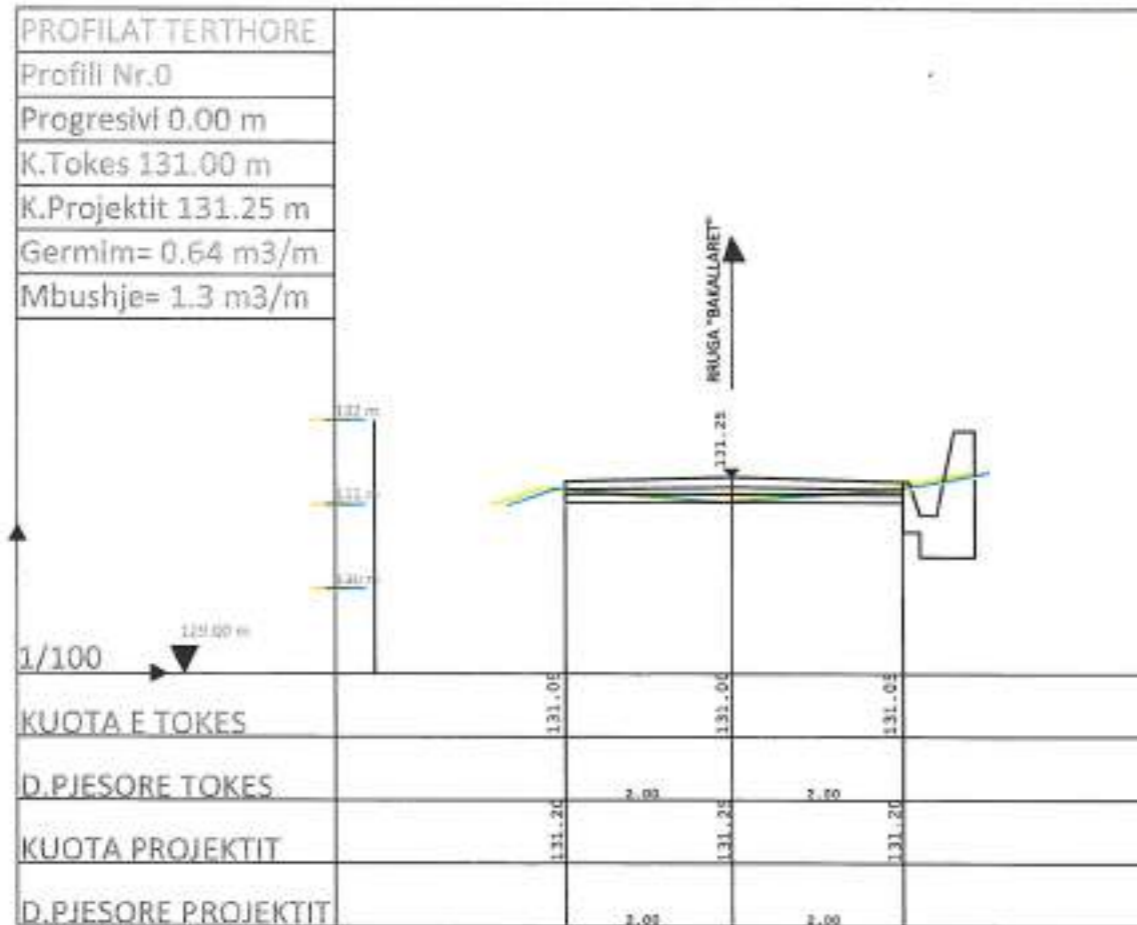

Projetti i...  
 Ministria e Transportit dhe Infrastruktura  
 Detyra: ...

Projekti:  
 RIKONSTRUKTIVIMI I RRUGES...  
 DREJTORI I...  
 INZHENERI I...  
 INZHENERI I...

Grupi i Projektimit:  
 Inz. ...  
 Inz. ...  
 Inz. ...

Drejtori i...  
 Inz. ...

Titulli i...  
 PROFILI TERTHORE I RRUGES

Detyra:  
 005/22/2023

Filet e...



**PLANIMETRIA E TOMBINOS**

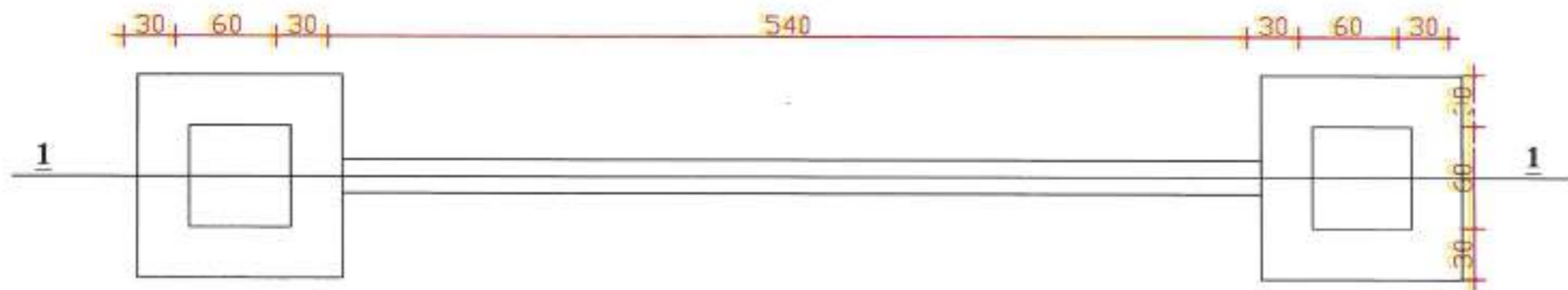

**DETAJE TE MURIT**

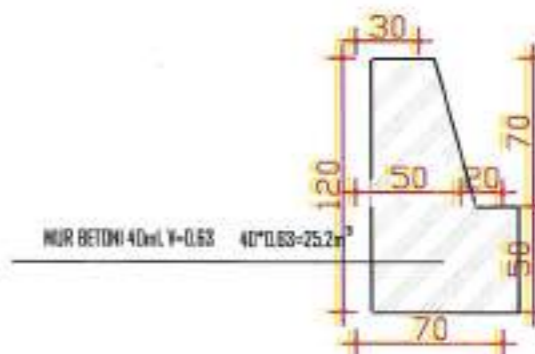

**PRERJA 1-1**

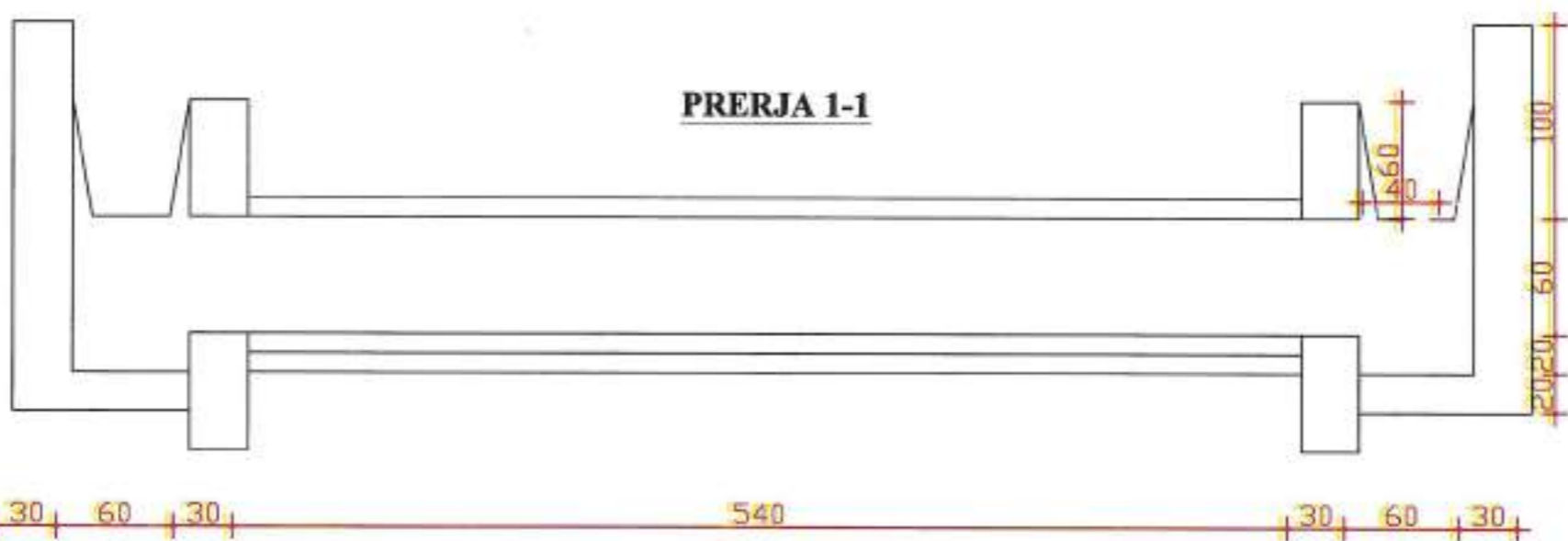

Projektuar nga:  
**INSTITUTI QENOR I PLANIMIT DHE INZHINIERISME**  
**MINISTRI E TRANSPORTIT DHE INFRASTRUKTURES**

Grupi i Projektimit:  
 Inzh. Enton Hoxha  
 Inzh. Evard Hoxha  
 Inzh. Edmond Hoxha

Udhëheqës i Projektit:  
**Enton Hoxha**

Titull i funksionit:  
**INZHINIER**

Datë: **05/02/2023**  
 Skala: **1:1**

Fletë nr: **4/3**  
**08**



Bashkia e Roskovec

# OBJEKTE: ASFALTIMI I RRUGËVE TË BRENDESHME NË LAGJET E BASHKISË ROSKOVEC (RRUGA SPAHIUT+HAZZAJVE)

	Emri i Projektit: <b>Bashkia e Roskovec</b> Adresa: <b>Washington</b>	Propozimet: <b>ASFALTIMI I RRUGËVE TË BRENDESHME NË LAGJET E BASHKISË ROSKOVEC</b>	Ekzpoziti / Propozitorit i: Emri: <b>Enver Hoxha</b> Adresa: <b>Enver Hoxha</b> Nr. i Kontaktit: <b>077 428 88 88</b>	Drejtuesi / PRZANT: <b>Enver Hoxha</b>	Titulli i Funksionit: <b>WAZIRI</b>	Data: <b>15.02.2023</b> Shtypja:	ID i Dokumentit: <b>4034</b>	
--	--	---	--	---	--	--	---------------------------------	--



naziza



Azərbaycan Respublikası  
 Milli Məclis  
 Azərbaycan Respublikası  
 Milli Məclis

Fərganə :  
 AZERBAIJAN REPUBLICAN TERRITORYAL  
 MANAGEMENT AND CONSTRUCTION

Direktor / Fərganə :  
 Mərkəz / Fərganə :  
 Mərkəz / Fərganə :  
 Mərkəz / Fərganə :

Direktor / FƏRQƏ :  
 Mərkəz / Fərganə :

Təvəllüfiyete :  
 ZƏRƏFƏNİN FƏRQƏLƏRİ (QƏRƏFƏNİN  
 ZƏRƏFƏ)

Qərar	08.02.2023
Səhifə	





Proiect: **REALIZAREA TRASEULUI DE TRANSPORT PUBLIC LOCAL ÎN COMUNA ROSUȘI, RAIONUL CĂLĂRAȘI**

Grupul de proiectare: **PROIECTA**  
 Ing. Elena Moldovan  
 Ing. Sorinel Mălina  
 Ing. Zoltan Nemes

Comitetul de proiectare: **PROIECTA**  
 Comisia de proiectare

Titlul fișei: **REALIZAREA TRASEULUI DE TRANSPORT PUBLIC LOCAL ÎN COMUNA ROSUȘI, RAIONUL CĂLĂRAȘI**  
**REZUMATUL PROIECTULUI**

Etapa: **PROIECTAREA**

Data: **05.10.2023**

Fișă nr. **4/3** Nr. **12**



REPUBLIKA E SHQIPËRIE  
Ministria e Transportit dhe Infrastruktura  
Kryetari: *[Signature]*

**Projekti:**  
KONSTRUKTIVITETI I RRUGËS ME REKONSTRUKCIM NË  
LAKUNDET E BASHKISËS E VËRSHINJEC

**Grupi i Përgjeshëm:**  
Kryetari: *[Signature]*  
Anëtarë: *[Signature]*  
Anëtarë: *[Signature]*

**Drejtori i RRUGËT:**  
*[Signature]*

**Titulli i fletës:**  
PRAKTIKUMI I PËRZEMBEJES

**Dite:**  
**Shkruar:**

**05/02/2023**

**Fletë nr. 03**



Propozimet:  
 Rindërtimi dhe mirëmbajtja e rrugës  
 Mënyrën e punës:



Projektet:  
 RINDËRTIMI DHE MIRËMBAJTJA E RRUGËS  
 MËNYRËN E PUNËS:

Ligjimi i Projektimit:  
 Ligji i Rindërtimit  
 Ligji i Mirëmbajtjes  
 Ligji i Rindërtimit dhe Mirëmbajtjes

*[Handwritten signature]*

Ligjimi i Punës:  
 Rindërtimi dhe Mirëmbajtja

*[Handwritten signature]*

Titulli i fletës:  
 RINDËRTIMI DHE MIRËMBAJTJA E RRUGËS

IDenti:  
 SShkallë:

05/10/2023

Fletë Nr. 04

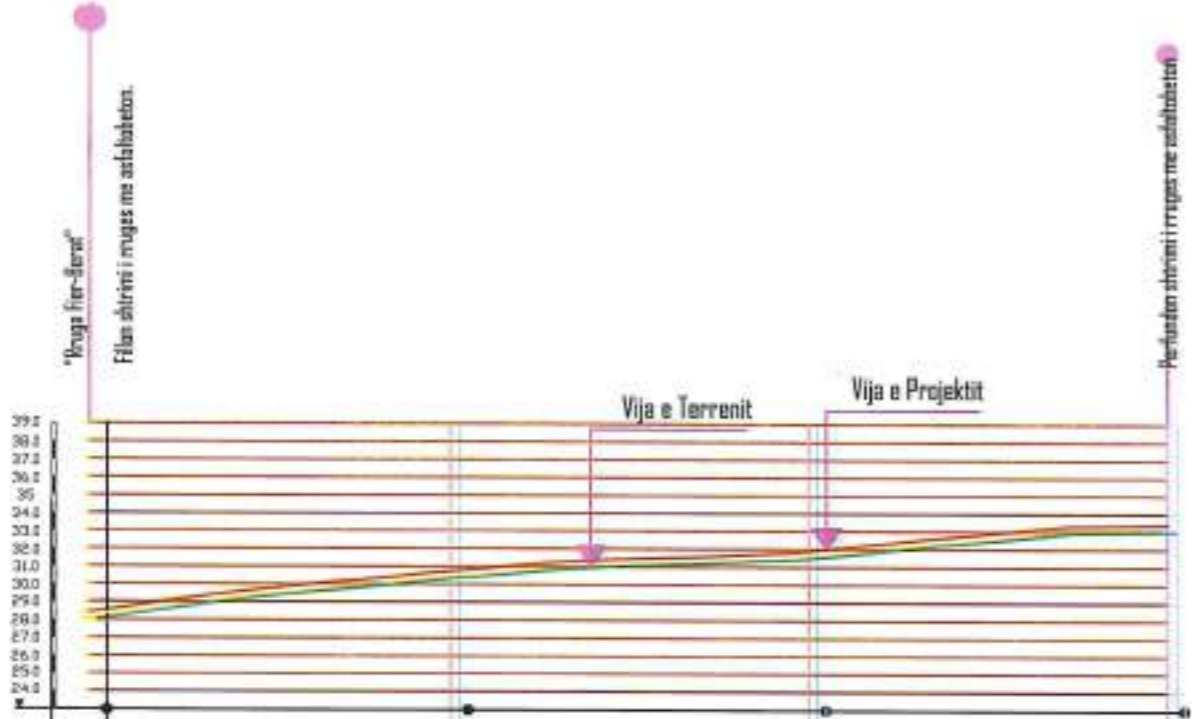

Elementet	b= 4 m asfaltobeton +2 x 0.5m bankina, L=270m			
Diferenca (cm)	10	10	10	10
Kuota e Projektit	28.10	30.10	31.60	32.10
Kuota e piketes	28.00	30.00	31.50	32.00
Nr. Piketes	0	1	2	3
Distanca Pjesore	0	100	100	100
Distanca Progressive	0	100	200	300

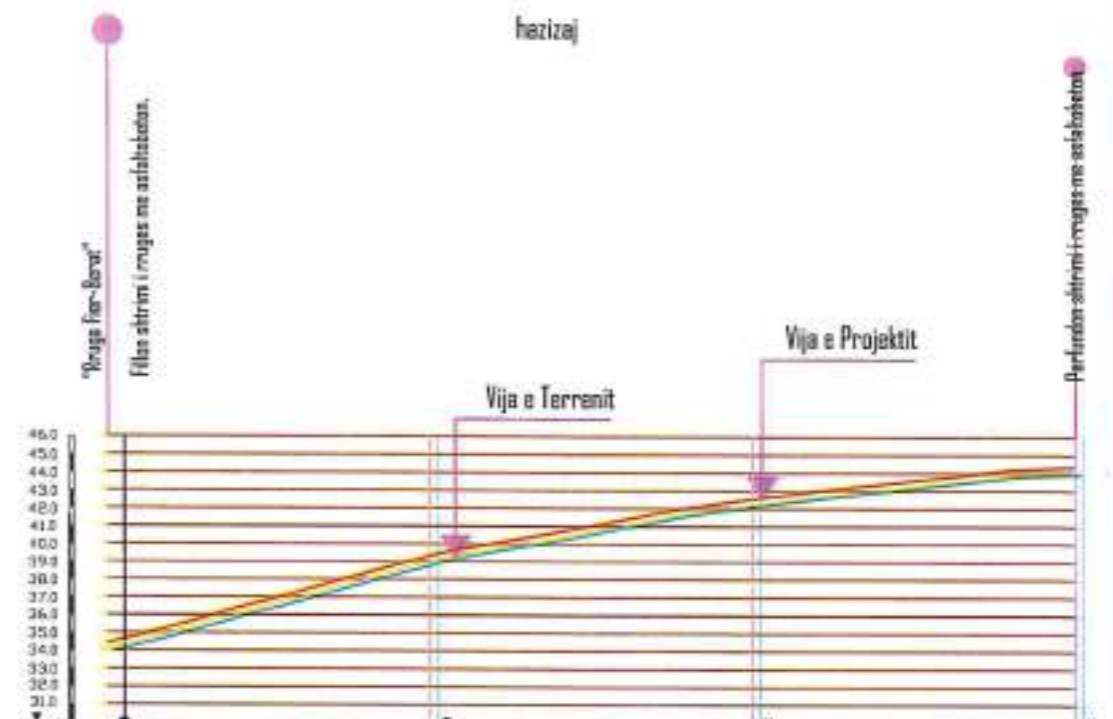

Elementet	b= 4 m asfaltobeton +2 x 0.5m bankina, L=270m			
Diferenca (cm)	10	10	10	10
Kuota e Projektit	34.10	39.10	42.10	44.10
Kuota e piketes	34.00	39.00	42.00	44.00
Nr. Piketes	0	1	2	3
Distanca Pjesore	0	90	90	90
Distanca Progressive	0	90	180	270



Promositor:  
 DASHKURIA E TRANSPORTIT  
 (Marrato)  
 Kuvendi i Ministrave

Projektant:  
 INSTITUTI I INZHINIERIS SE TRANSPORTIT  
 (Marrat)

Grupi i Projektimit:  
 Inzh. Enxhel Hoxha  
 Inzh. Evrel Hasani  
 Inzh. Edlir Kallmeti

Udhëheqës i Projektit:  
 Enxhel Hoxha

Titull i funksionit:  
 PROFIL I GJATËSOR I RRUGES

Skema:  
 SB/14/11/1

Fishtë Nr.  
 05

# PROFILI TIP P.0-P.3

## RRUGA " Hazizajve dhe Spahiut"

KUOTA E PROJEKTIT

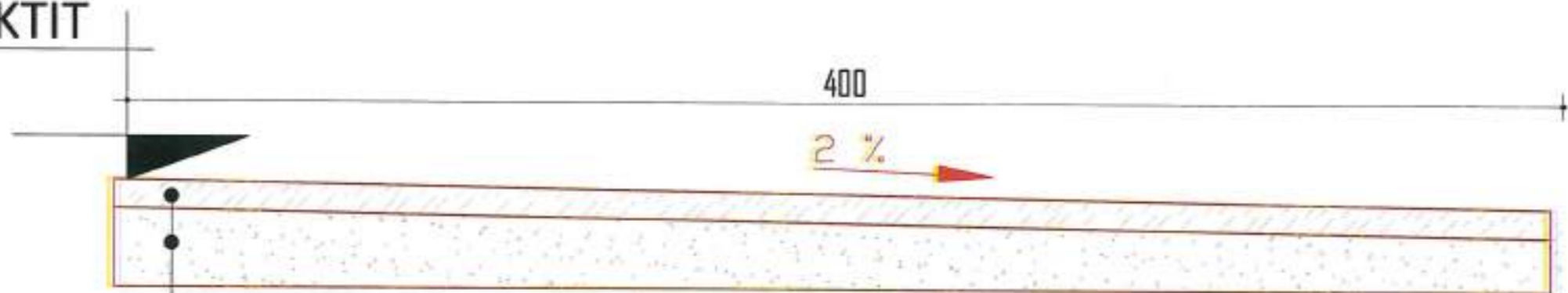

SHTRESE ASFALTOBETONI I PERZIER t=5cm

SHTRESE STABILIZANTI t=5cm

SHTRESE EKZISTUESE



Ministria e Transportit dhe Infrastruktura  
Drektorati i Përgjithshëm i Rrugëve

Projekti: RRETHOFTJA E RRUGES BAZET E BERRANDE SHANENË  
KOMUNA E BERRANDE QARKU I DIBRËS

Grupi i Projektimit:  
Inzh. Emin Hoxha  
Inzh. Karel Blatka  
Inzh. Edona Krasniqi

Drejtori i P.R.P.T.:  
Inzh. Hoxha

Titulli i titullit:  
PROJEKTI I RRUGËS

Datë:  
Shtator

16/02/2023

Fila: 03/04  
06



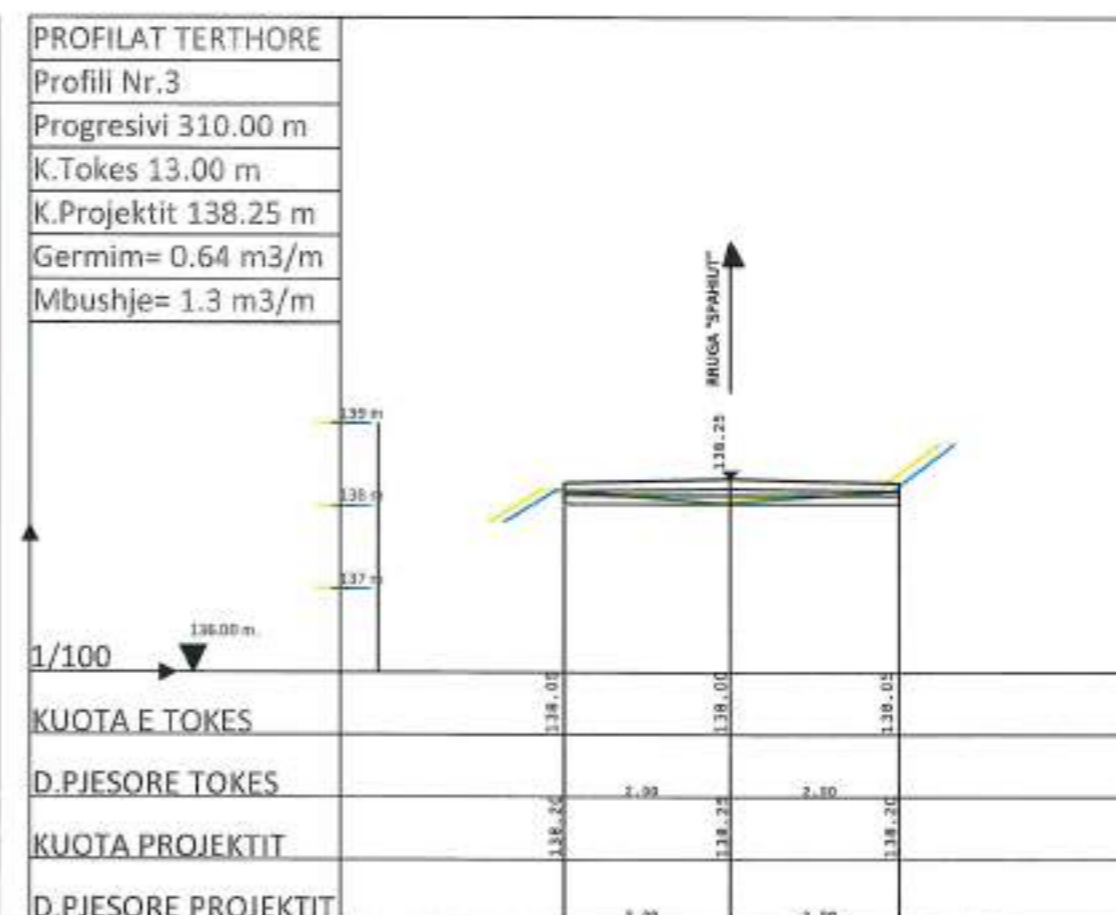
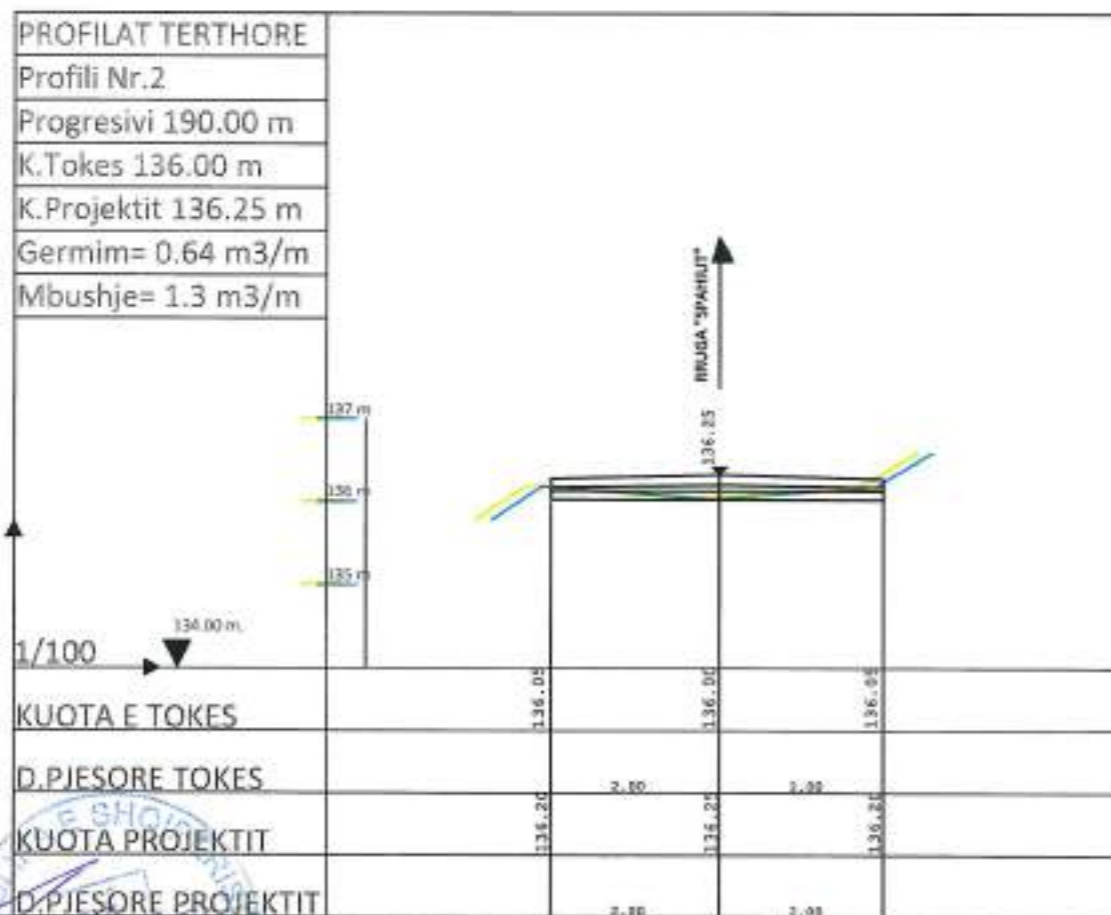
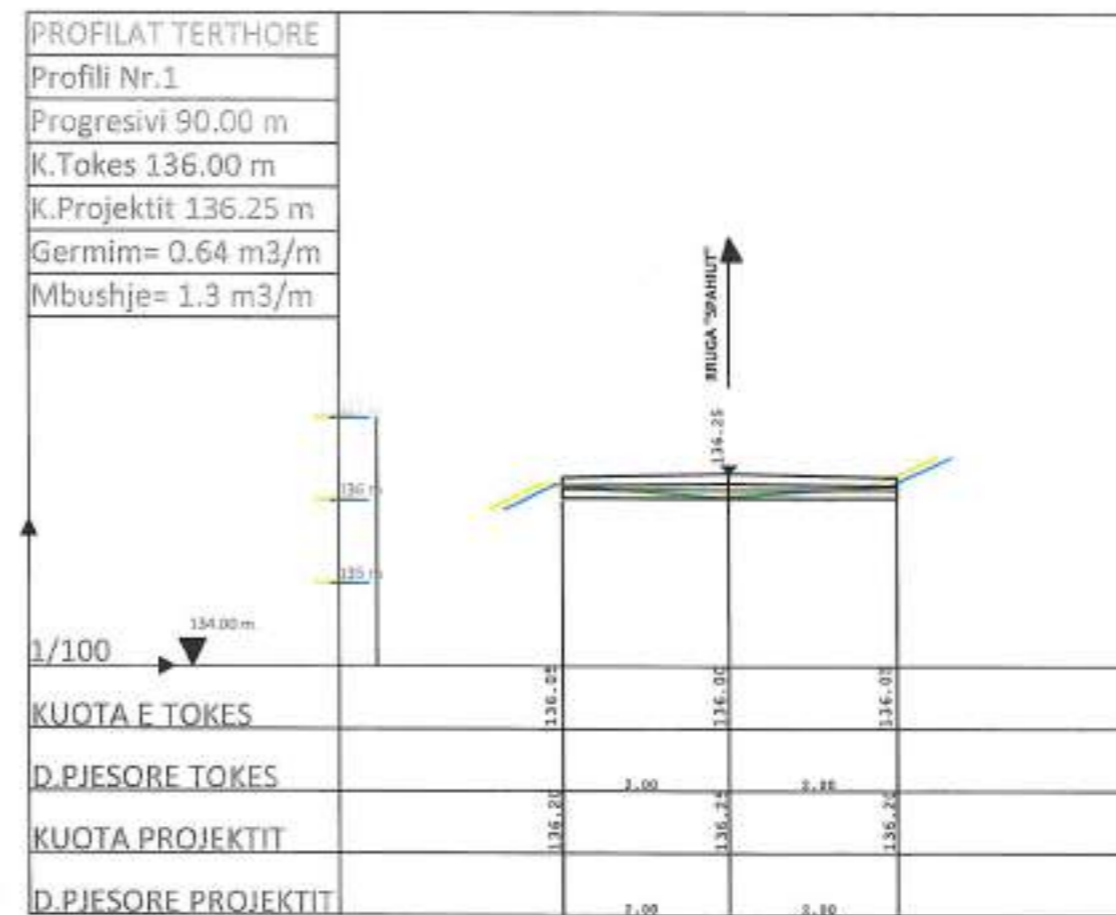
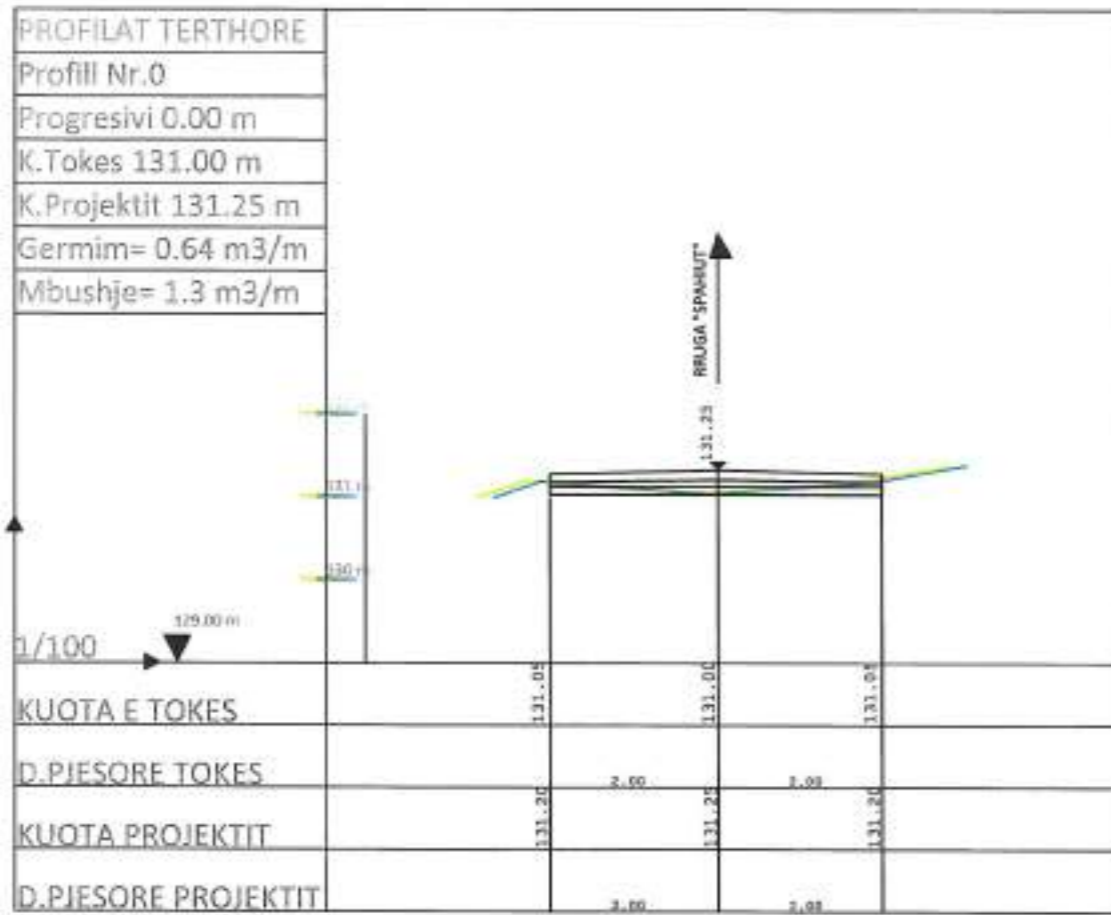

Projetti:  
 Bashkia e Kavajes  
 Ministri  
 Kuvendi

Projekt:  
 RRETHI I RRUGES E FERROSSHARRNE  
 LANDET E HARRONIS PRONKONJEC

Grupi Projektimit:  
 Inzh. Ferim Hodja  
 Inzh. Selim Haxhi  
 Inzh. Edmond Krasni

Dirigjtor: PEZANIT:  
 Inzh. Hodja

Titull i fakte:  
 PROFILAT TERTHORE E RRUGES

Data: 08/02/2023  
 Shtypja



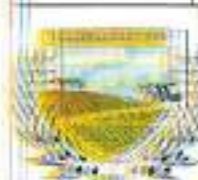
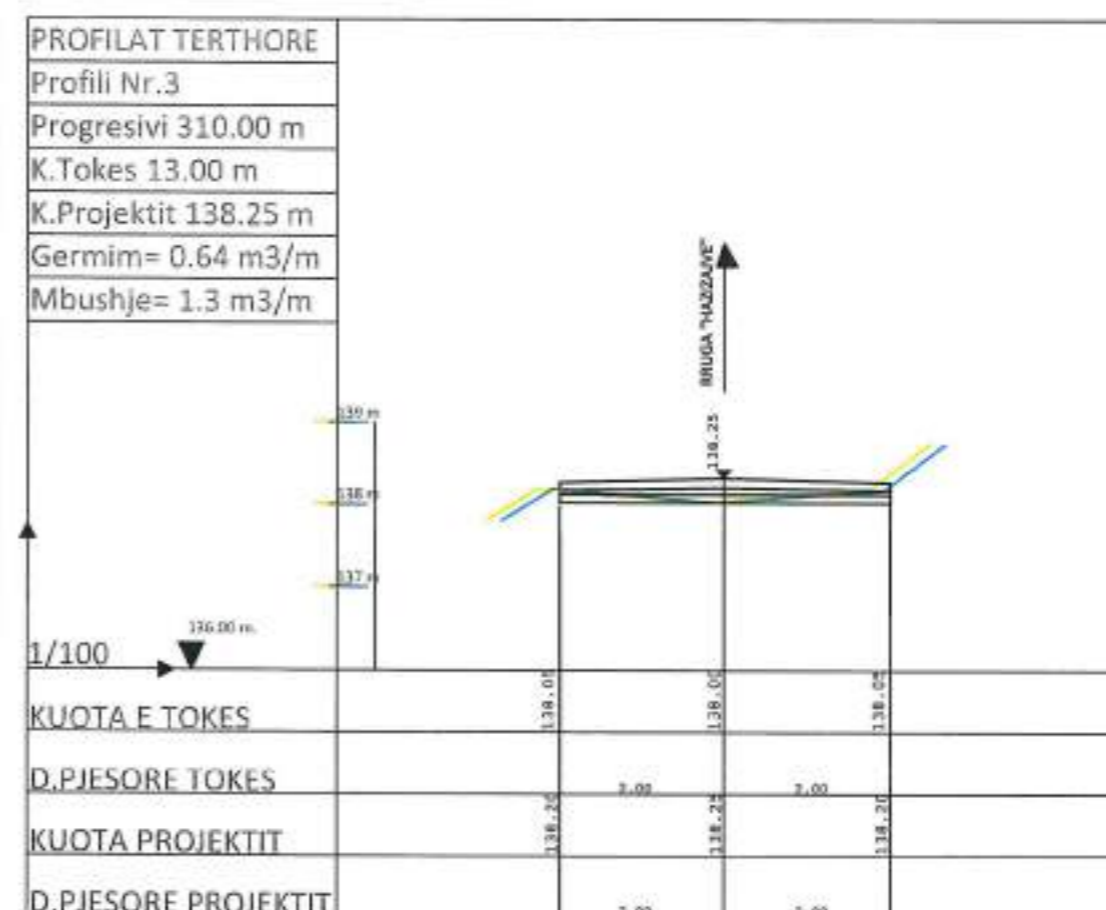
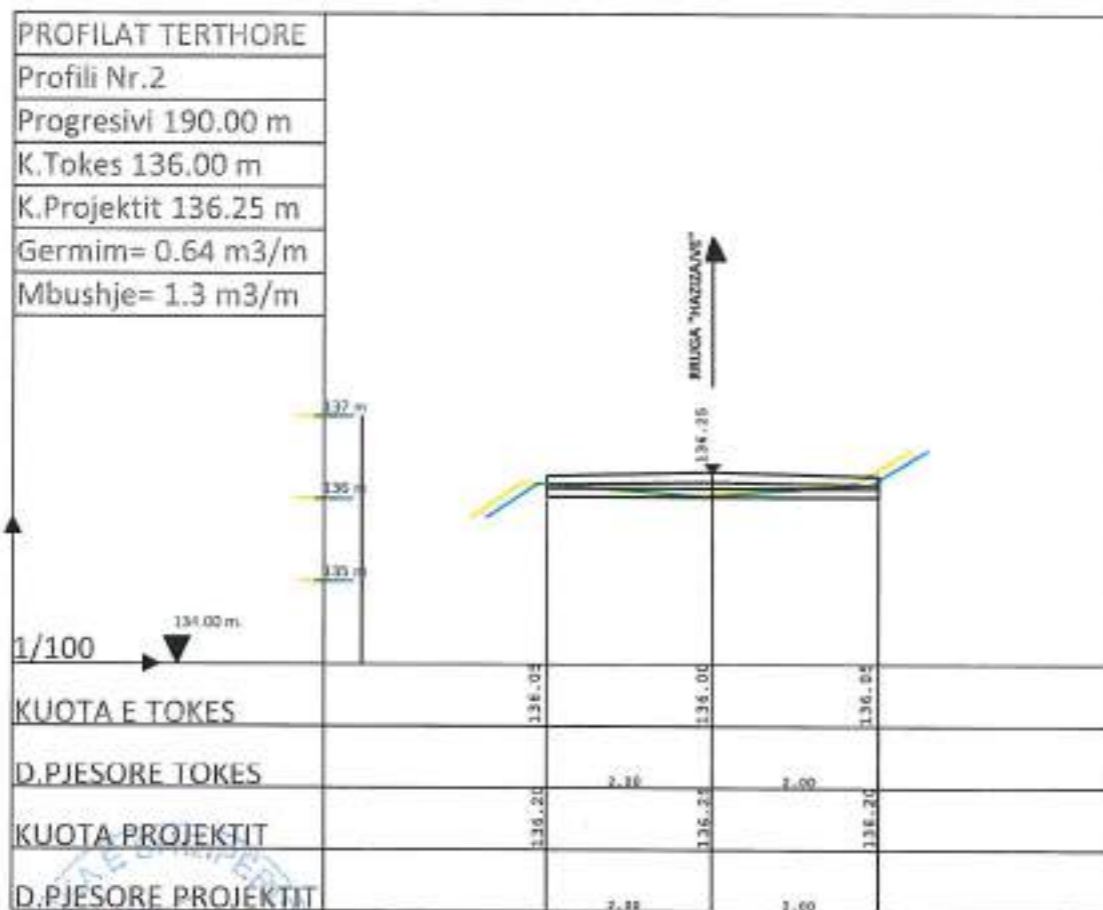
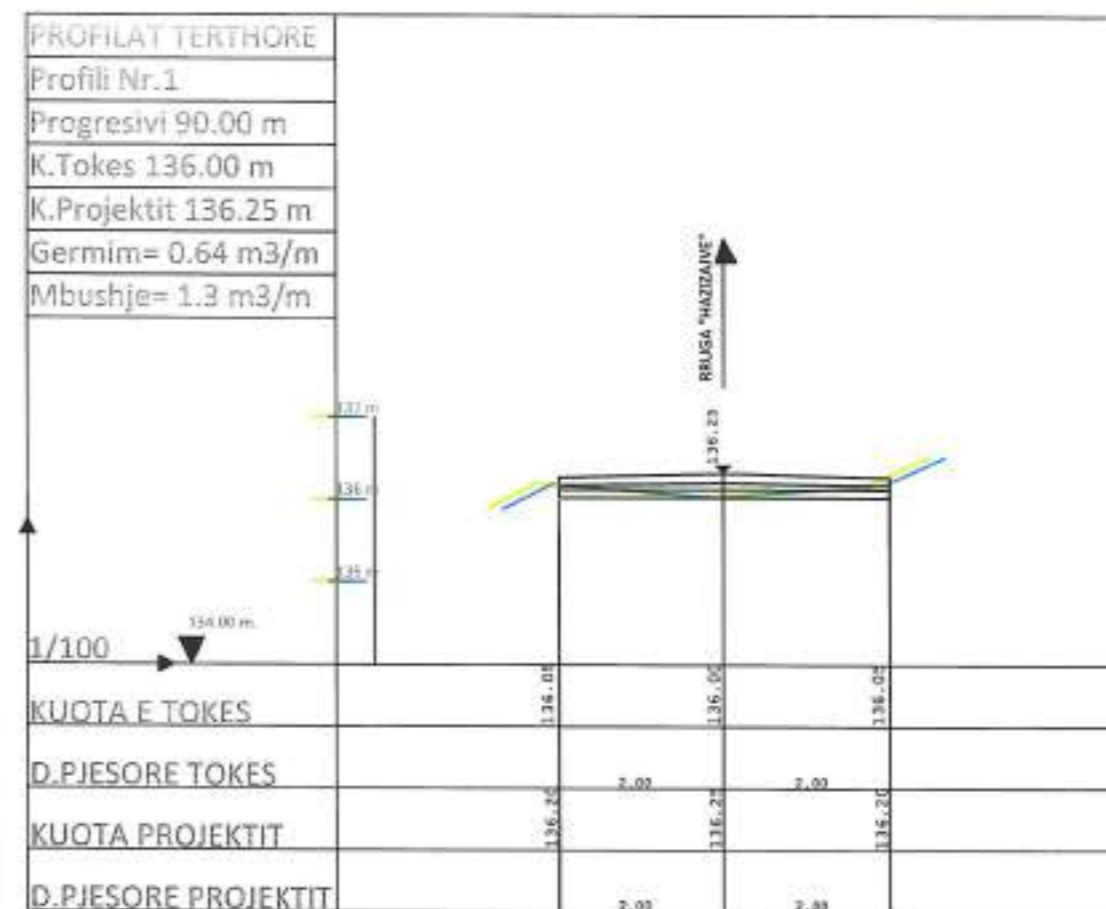
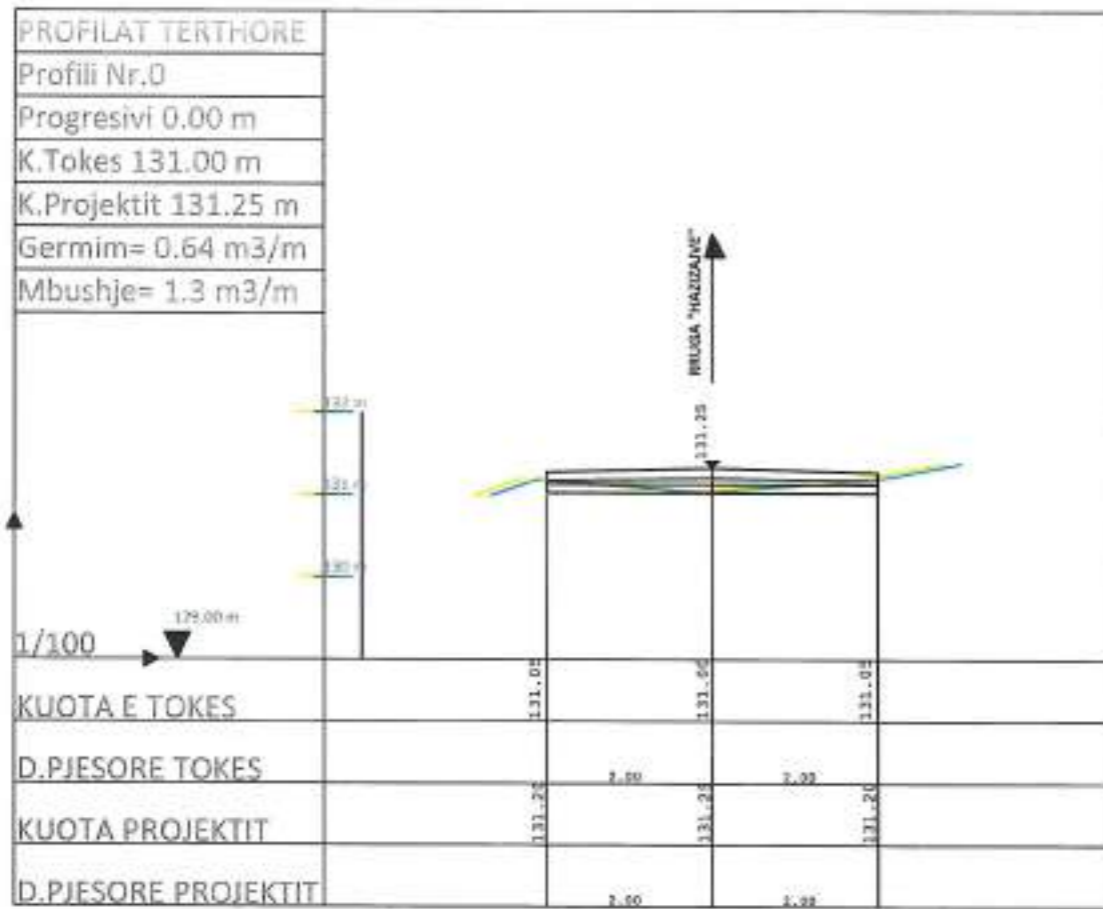

Ministria e Transportit dhe Infrastruktura  
 Detyra e Përgjithshme  
 Minsitri  
 Kuvendi i Ministrave

Projekt:  
**ANALIZA E NEVESHIMIT DHE REKONSTRUKCIONE**  
**TE BRITIMIT DHE BASHKIMIT TE RREZES**

Grupi i Përgjegjësor:  
 Inzh. Ester Hoxha  
 Inzh. Evrel Mëdina  
 Inzh. Edmond Kollçaku

Grupi i Përzgjedhur:  
 Inzh. Ester Hoxha

Titulli i Detyrës:  
**PROFILAT TERTHORE TE BRUGES**

Dhete  
 Shtetë

05/02/2023

Fleta 43 Nr.





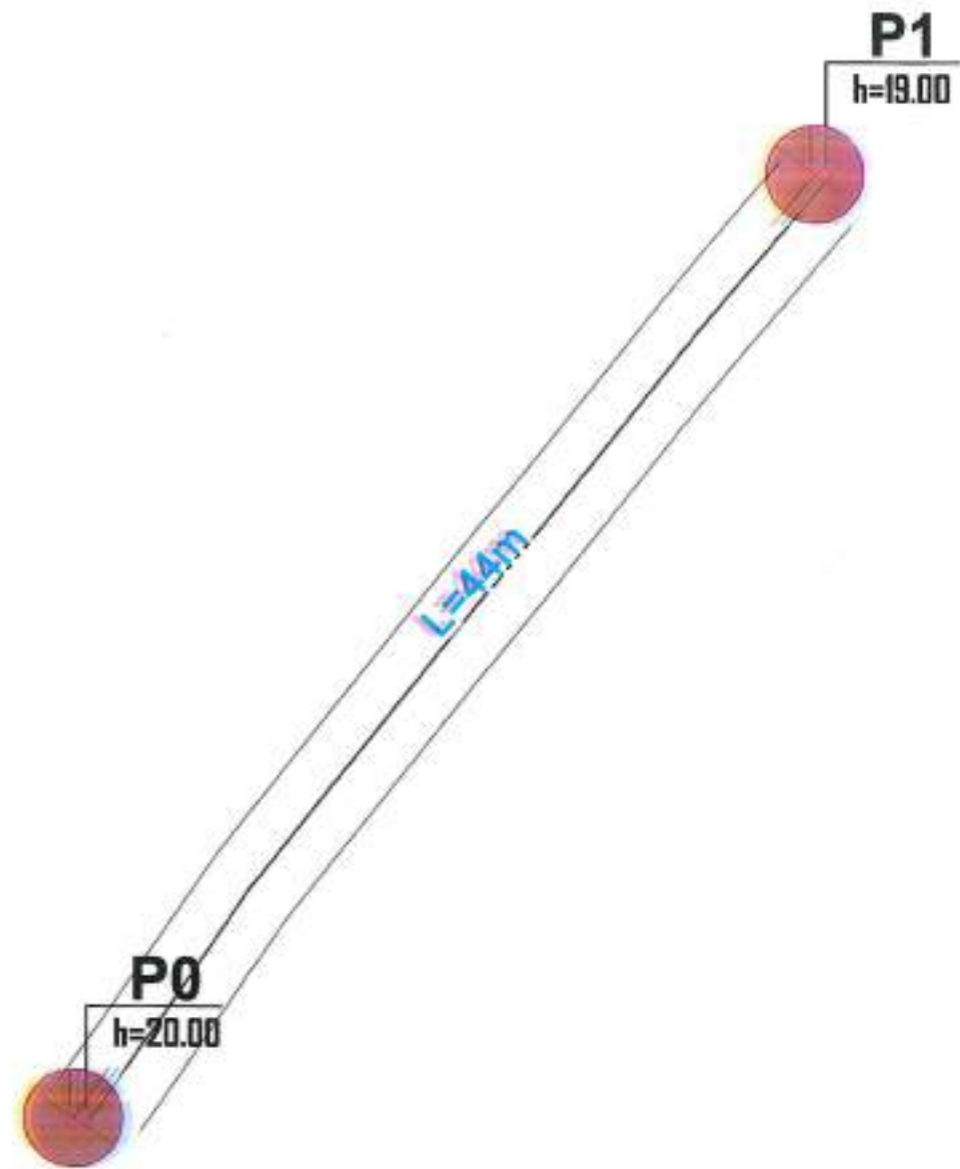
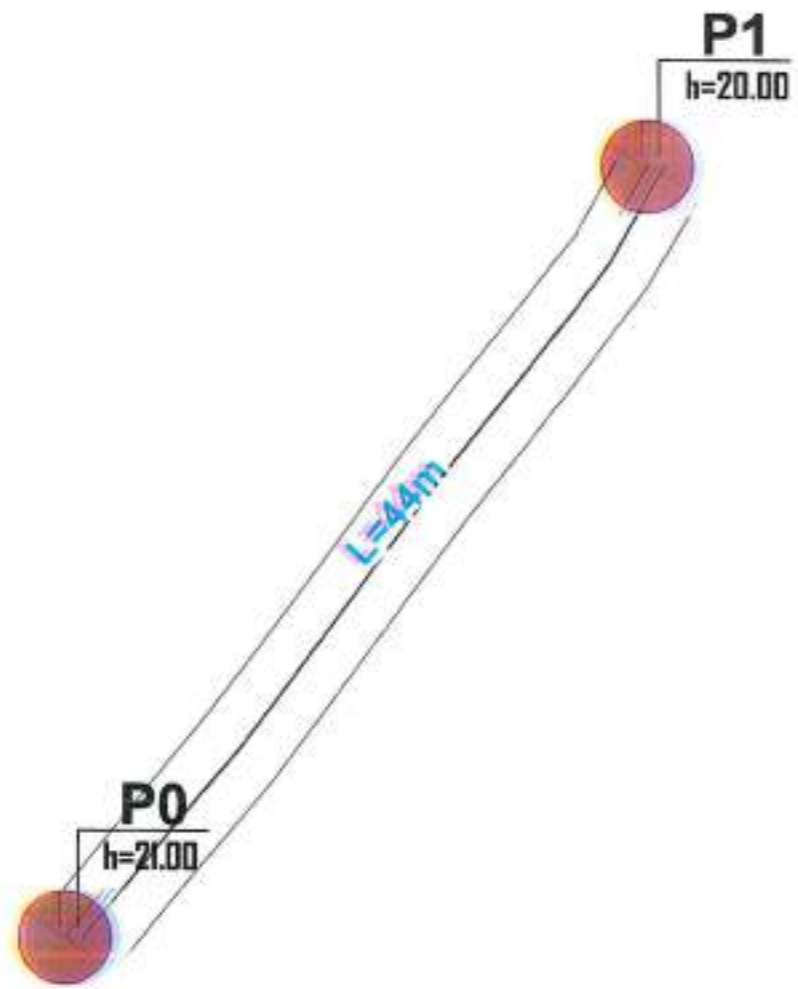

	Projekti: <b>ASFAKTI I RRELLIVE E RRONDESHWAZNE          NAGJETE E BASHKISE KRONIMEC</b>	Grupi i Prgjetimit: Ingg. Ferit Hoxha Ingg. Ervil Hoxha Ingg. Edisson Hoxha	Grupi i ZBAT.: Ingg. Ferit Hoxha	Titulli i faze: <b>PRALIMI I PLANIMIT E EMBLIDHES          E RRZOSHISE</b>	Data: <b>18.12.2023</b>	Faza/ Nr: <b>02</b>
					Shprehja: 	



Widyaiswara  
Balai Kajian dan Penelitian  
Pusat  
Kebijakan dan Strategi  
Kebijakan dan Strategi  
Kebijakan dan Strategi

Proyek :  
ANALISIS PERUBAHAN TERBUKTI DAN  
MENDUKUNG KEBERKEMBANGAN

Tim Pengantar :  
Widyaiswara  
Widyaiswara  
Widyaiswara

Tim Pengantar :  
Widyaiswara  
Widyaiswara

Tahun :  
2023

Revisi :  
1

Tanggal :  
15/10/2023

Halaman :  
13



Republika e Shqipërisë  
Ministria e Transportit dhe Infrastruktura  
Drejtoria e Përgjithshme e Rregullimit dhe  
Kontrollimit të Transportit

Projektet :  
KONSTRUKIMI I RREZESËVE TË FERROKARRIÇANORËVE  
NË RREZËT E RREZESËVE TË FERROKARRIÇANORËVE

Grupi i Projektimit :  
Inggj. Enver Hoxha  
Inggj. Besnik Hoxha  
Inggj. Edmond Kallulli

Grupi i Përzgjedhjes :  
Enver Hoxha

Titulli i fletës :  
PRAKTIKUMI I PËRZGJEDHJES

Dhënia :  
Shtetli

05/10/2023

Fleta 43 Nr  
04

## Refat Çepele

## Dyli Çepele

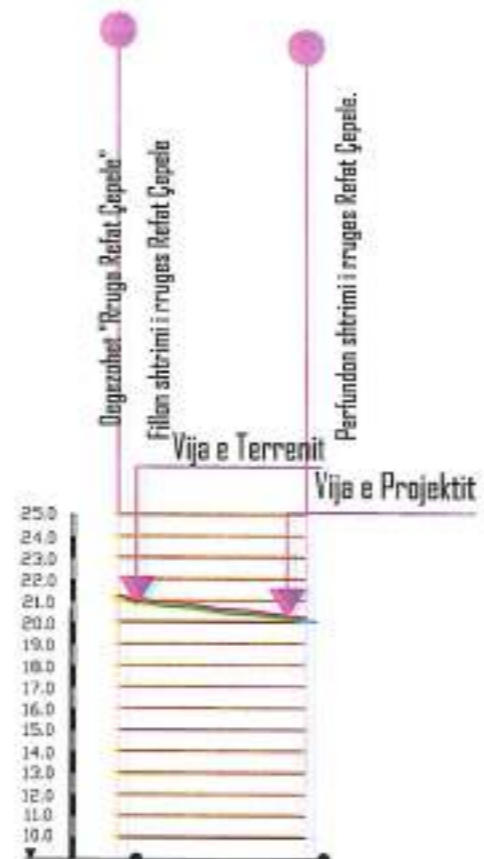

Elementet  $b = 5 \text{ m asfaltbeton} + 2 \times 0.5 \text{ m kurbeta} + 2 \times 1.5 \text{ m trotuaire}, L = 50 \text{ m}$

Diferenca (cm)	10	10
Kuota e Projektit	21.10	20.10
Kuota e piketes	21.00	20.00
Nr. Piketes	0	1
Distanca Pjesore		44
Distanca Progressive	0	24

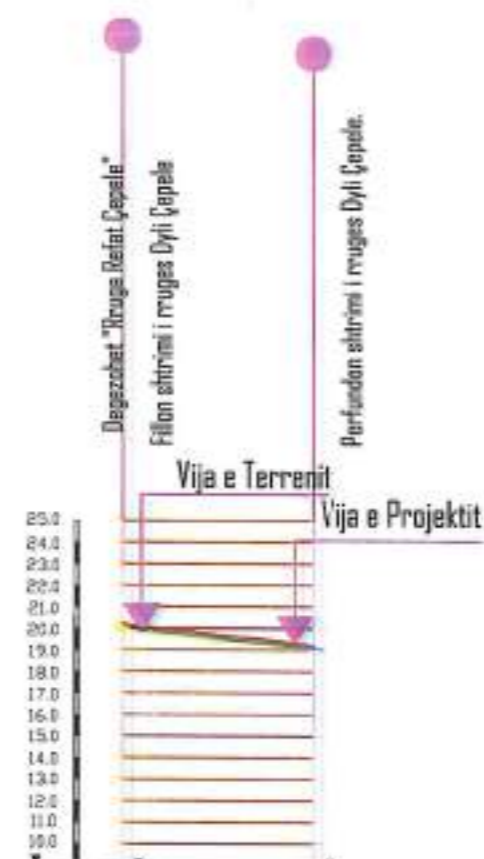

Elementet  $b = 5 \text{ m asfaltbeton} + 2 \times 0.5 \text{ m kurbeta} + 2 \times 1.5 \text{ m trotuaire}, L = 50 \text{ m}$

Diferenca (cm)	10	10
Kuota e Projektit	20.10	19.10
Kuota e piketes	20.00	19.00
Nr. Piketes	0	1
Distanca Pjesore		44
Distanca Progressive	0	24



# PROFILI TIP P.0-P.1

## RRUGA " Dyli dhe Refat Çepele"

KUOTA E PROJEKTIT

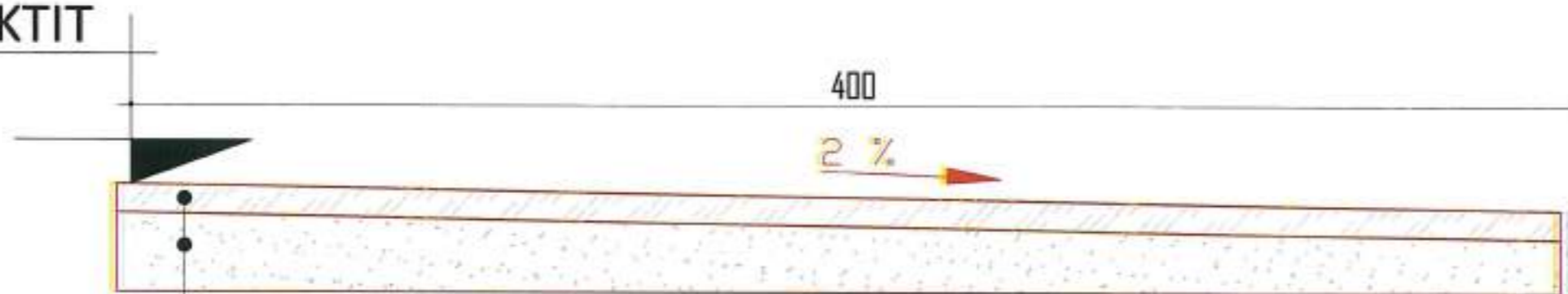

SHTRESE ASFALTOBETONI I PERZIER t=5cm

SHTRESE STABILIZANTI t=5cm

SHTRESE EKZISTUESE



Ministria e Transportit dhe Infrastruktura  
 Detyra e Përgjithshme  
 Detyra e Përgjithshme

Projekti:  
 RRUGA "DYLI DHE REFAT ÇEPELE" NË QARKUN E DIBRËS

Grupi i Përgjithshëm:  
 Inxhinjieri i Rrugëve  
 Inxhinjieri i Kullave  
 Inxhinjieri i Hidraulikës

Grupi i Përgjithshëm:  
 Inxhinjieri i Rrugëve

Titulli i detyrës:  
 PROFILI TIP I RRUGËS

Drejtuesi:  
 Shtetësi

Titulli i detyrës:  
 06

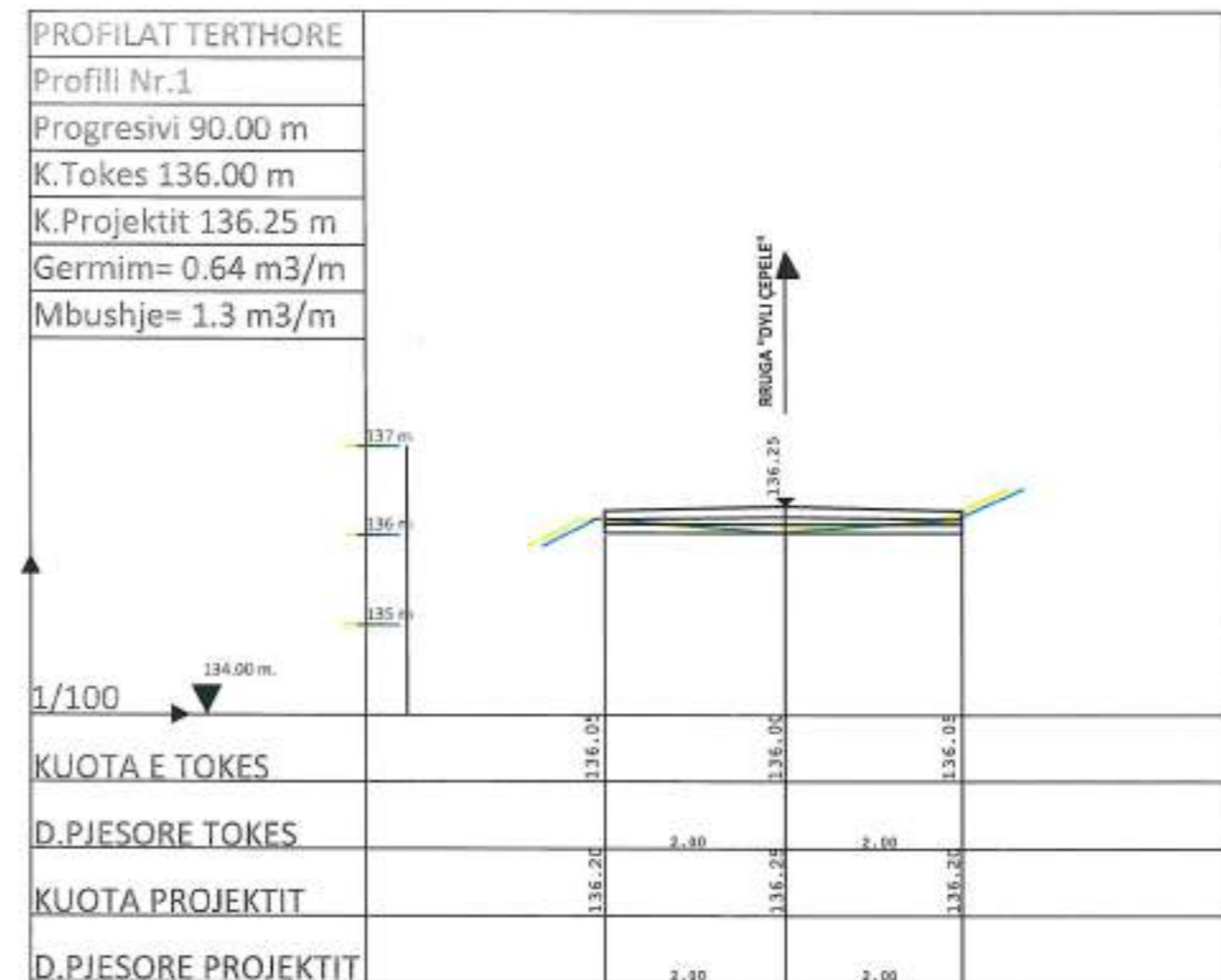
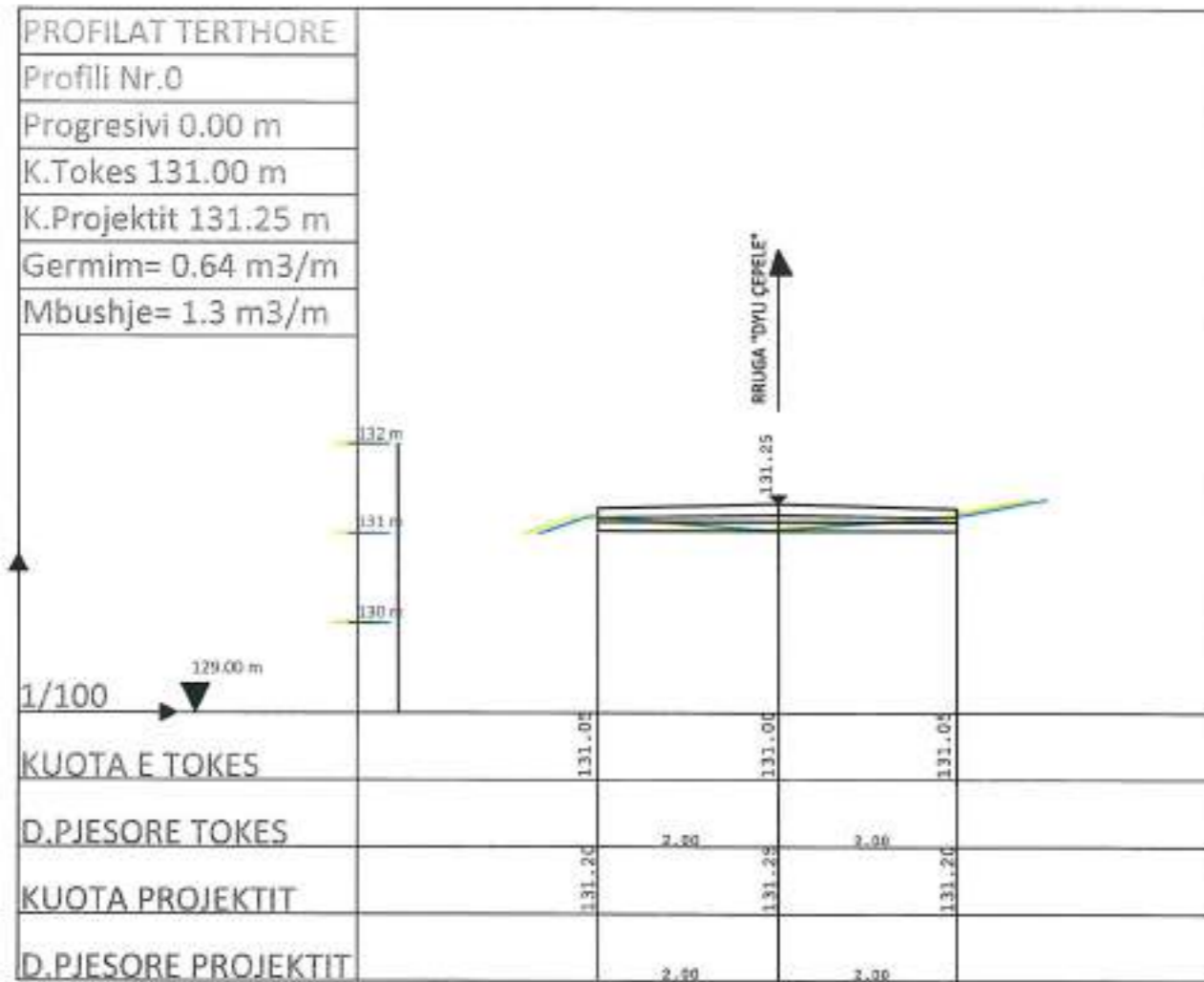

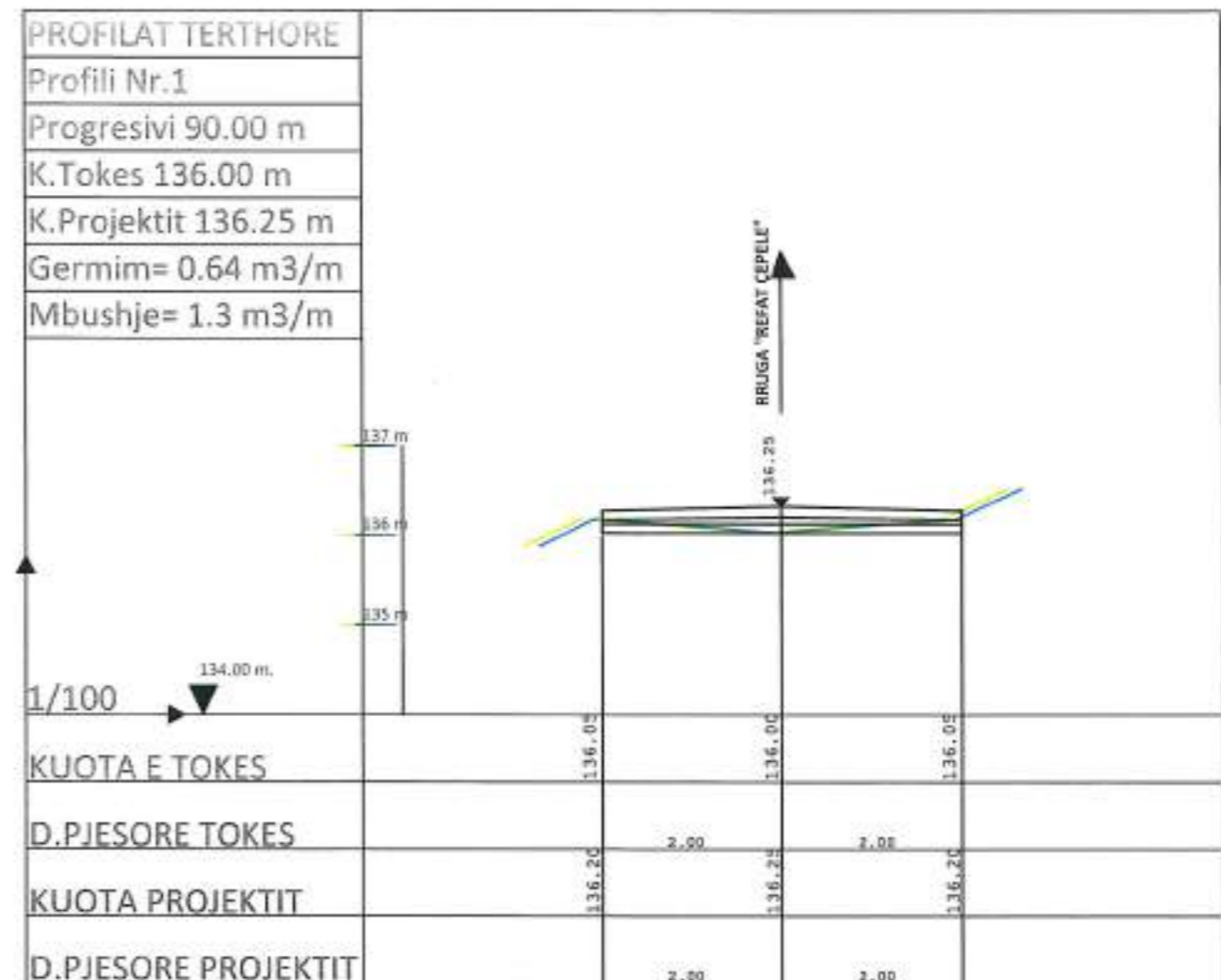
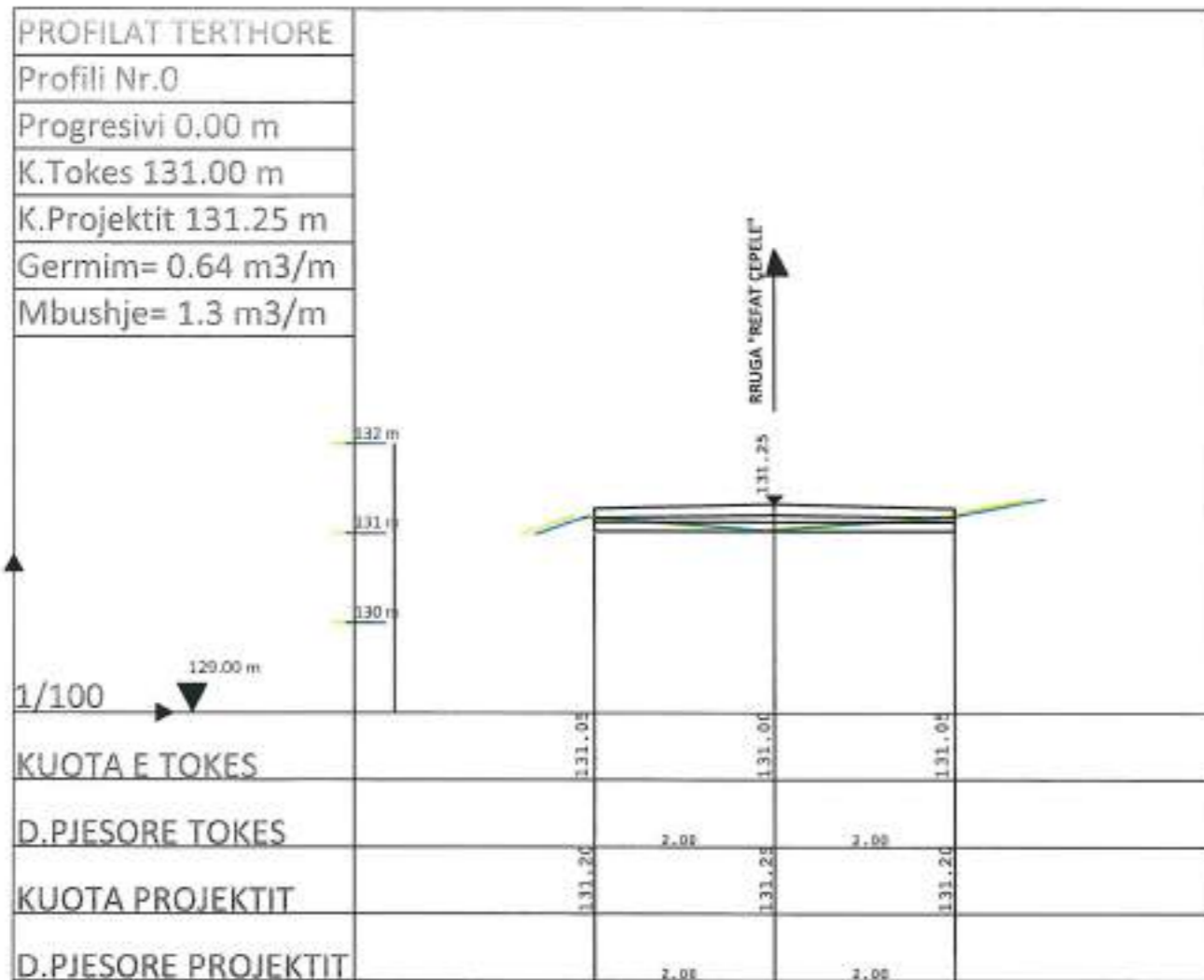

Projekt: **WASHOTM/IRRI/IG/ME/TE/RRONDESH/MA/NE/**  
**LINDJET/TE/BA/SHKIS/TE/RO/ND/KE/Ç/**

Grupi i Projektimit:  
 Inxh. Enxhoni Kodra  
 Inxh. Evrel Metka  
 Inxh. Edlisoni Komari

Drejtes: **REZATI**  
 Enxh. Metka

Titull i fete: **PROFILAT TERTHORE TE RRUGES**

Date: **05.02.2023**  
 Shkollë:

Flete 43/47



Republika e Kosovës

# OBJEKTE ASFALTIMI I RRUGËVE TË BRENDESHME NË LAGJET E BASHKISË ROSKOVEC (RRUGA ARDILE KAÇELI-RIZA AĞAÇI)



Ministria e Punëve  
Publike dhe Transportit  
Ministria e Punëve  
Publike dhe Transportit  
Ministria e Punëve  
Publike dhe Transportit

Projekt:  
ASFALTIMI I RRUGËVE TË BRENDESHME NË  
LAGJET E BASHKISË ROSKOVEC

Grupi i Projektimit:  
Inxh. Eriton Hoxha  
Inxh. Erald Hoxha  
Inxh. Edmond Komari

Grupi i Përzgjedhjes:  
Eriton Hoxha

Titulli i fletës:  
KONTRAKTI

Fleta:

005/10/2023

SShënim:

Fletë: 4/3 Nr.



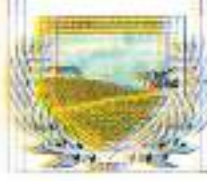
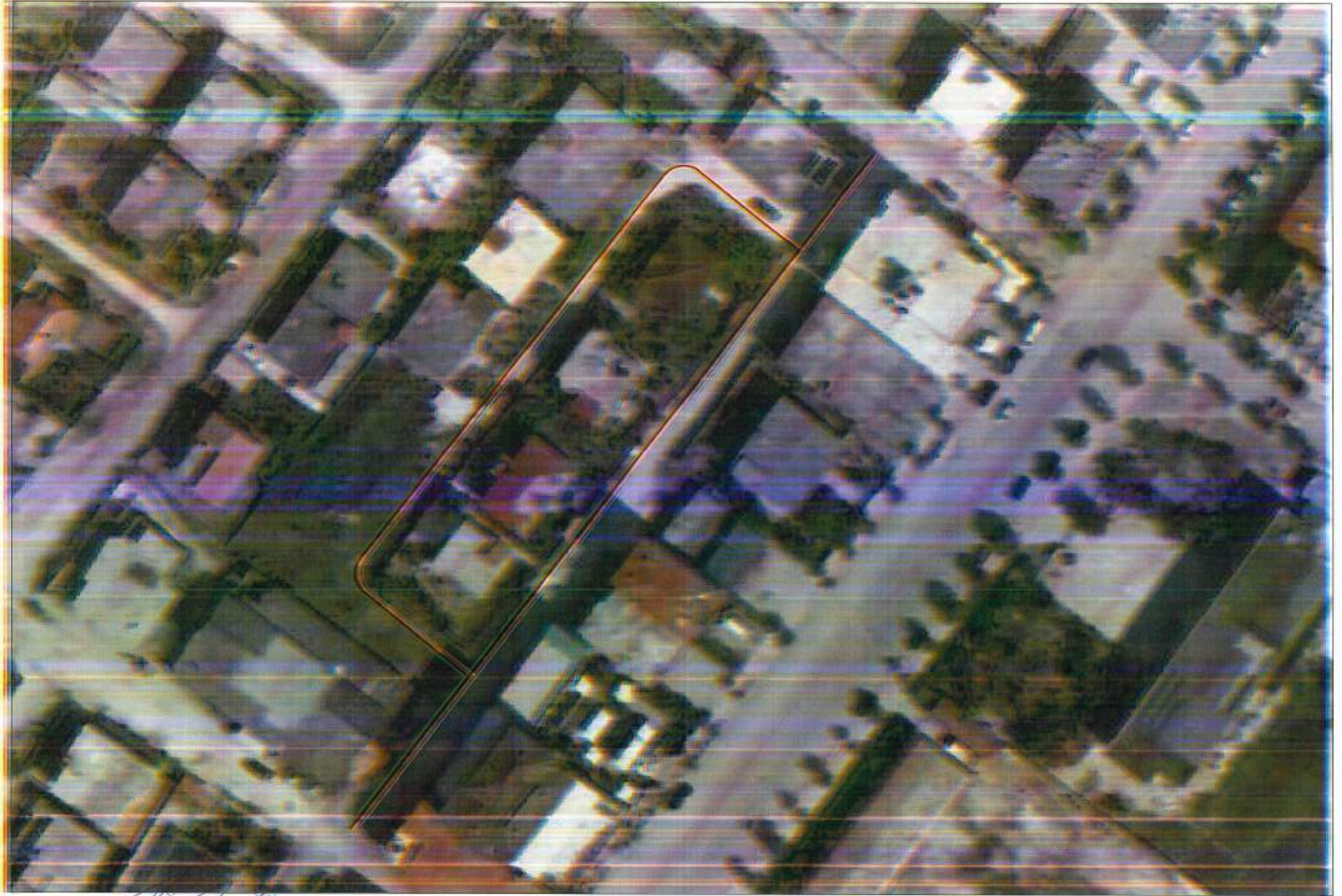

Հանրապետության  
 Կառավարություն  
 Կառավարության  
 Կենտրոնի  
 Վերականգնման  
 Կենտրոն

Մարզիկի  
 Մարզիկի  
 Մարզիկի  
 Մարզիկի  
 Մարզիկի

Հանրապետության  
 Կառավարություն  
 Կառավարության  
 Կենտրոնի  
 Վերականգնման  
 Կենտրոն

Հանրապետության  
 Կառավարություն  
 Կառավարության  
 Կենտրոնի  
 Վերականգնման  
 Կենտրոն

Հանրապետության  
 Կառավարություն  
 Կառավարության  
 Կենտրոնի  
 Վերականգնման  
 Կենտրոն

Հանրապետության  
 Կառավարություն  
 Կառավարության  
 Կենտրոնի  
 Վերականգնման  
 Կենտրոն

Հանրապետության  
 Կառավարություն  
 Կառավարության  
 Կենտրոնի  
 Վերականգնման  
 Կենտրոն

Հանրապետության  
 Կառավարություն  
 Կառավարության  
 Կենտրոնի  
 Վերականգնման  
 Կենտրոն

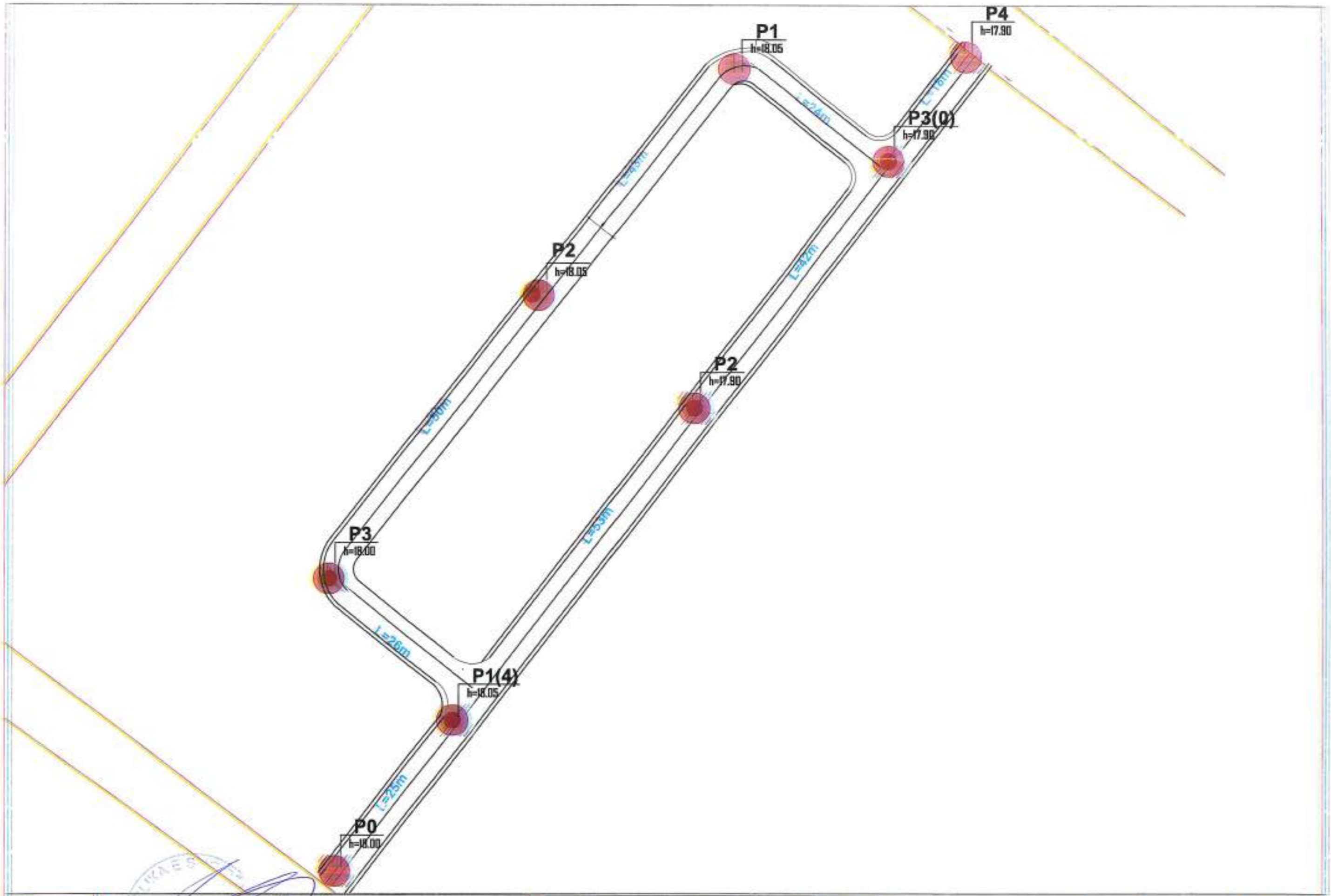

 Felügyeleti Helyettes Miniszter Kivonat:	Projekt: A SZÉKESVÁROSI ÉRTÉKELÉSI ÉS TERVEZÉSI MUNKÁK ELJÁRÁSÁNAK LEZÁRÁSA	Célcsoport / Projektterület: Helyi önkormányzatok Községi önkormányzatok Megyei önkormányzatok	Előzetes / Előzetes: Előzetes	Tervezői / Tervezői: PÉNZMŰVÉSZETI ÉS TERVEZÉSI ÉRTÉKELÉSI	Dátum: 2023.02.27	Tervezői / Tervezői: PÉNZMŰVÉSZETI ÉS TERVEZÉSI ÉRTÉKELÉSI
					Száma:	



Հանրային  
Բաժնիկ Բաժնեգր  
Հանրային Կազմակերպություն



Մասնագիտացված:

ՀԱՅԱՍՏԱՆԻ ՀԱՆՐԱՊԵՏՈՒԹՅԱՆ  
ԱՆՈՒՅՑԻ ԵՎ ԿԱՏԱՆՈՒԹՅԱՆ  
ԲԵՐՈՍԿԱՆՈՒԹՅԱՆ ԲԵՐՈՍԿԱՆՈՒԹՅԱՆ

Ստորագրող/Մասնագետ:

Վրչ. Շիրինի Խոսեան  
Վրչ. Շահին Խոսեան  
Վրչ. Մանուկ (Կոնստ.)

*(Handwritten signatures)*

Ստորագրող/Մասնագետ:

Վրչ. Մանուկ (Կոնստ.)

Տնօրեն/Մասնագետ:

Վրչ. Մանուկ (Կոնստ.)

Տնօրեն

05/10/2023

Տնօրեն

Տնօրեն/Մասնագետ:

03

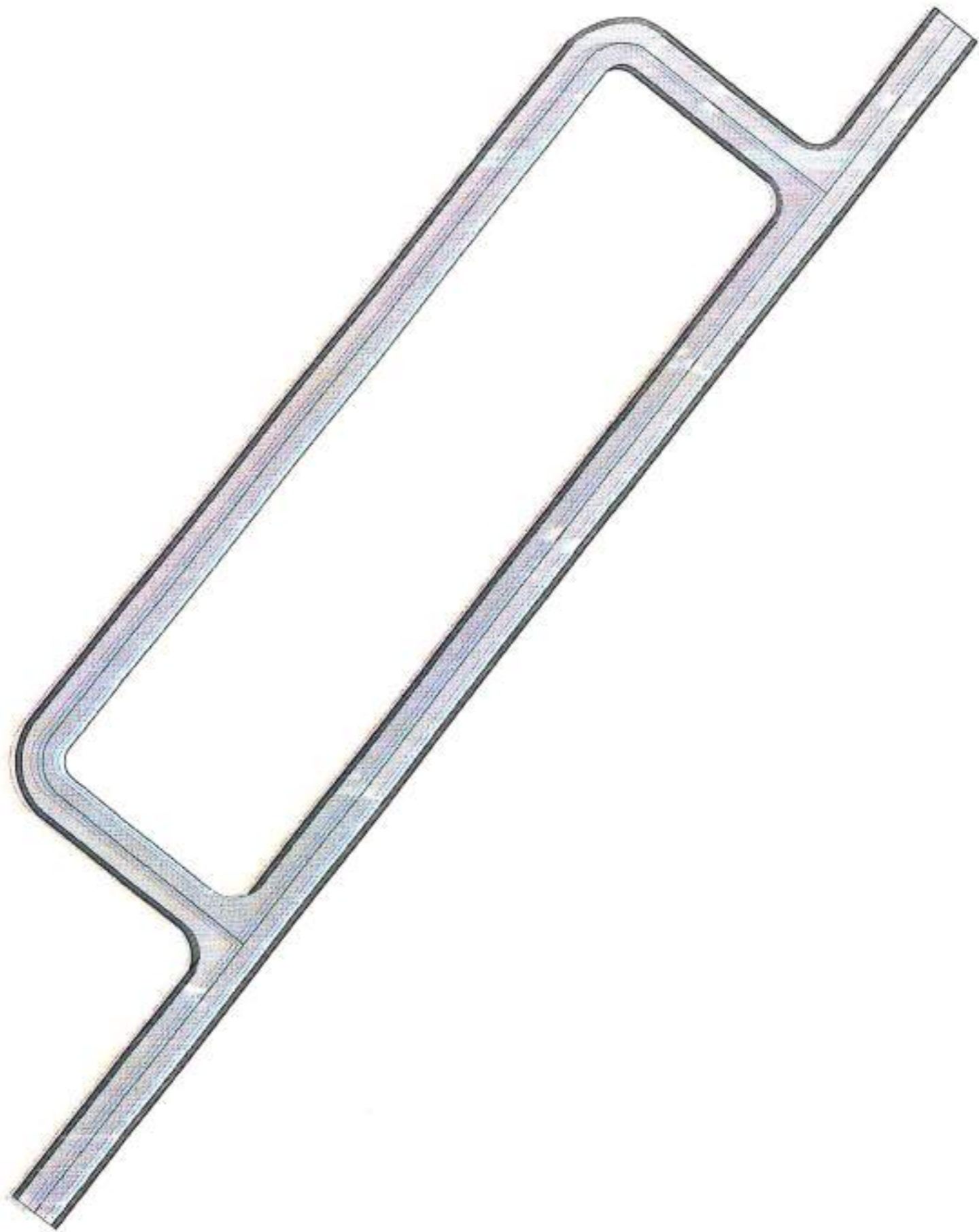

Emrosites:  
Bashkia e Durrësit  
Ministria e Kulturës  
Kryetari: *[Signature]*



Projekt:  
KASHTANIM I RRUGËVE TË BARRANDESMARINË  
LANDET E PËRANWERRIA E PËRGJITHSHME

Grupi i Përgjegjës:  
Z. Enxhin Hoxha  
Z. Enxhin Hoxha  
Z. Enxhin Hoxha

Drejtori i PZSHIT:  
Enxhin Hoxha

Titulli i detyrës:  
PËRANWERRIA E PËRGJITHSHME

Detyrë:  
Shërbëtor

Data: 06/10/2023

Filetë 4/3 Nr.  
04



# Riza Agaci

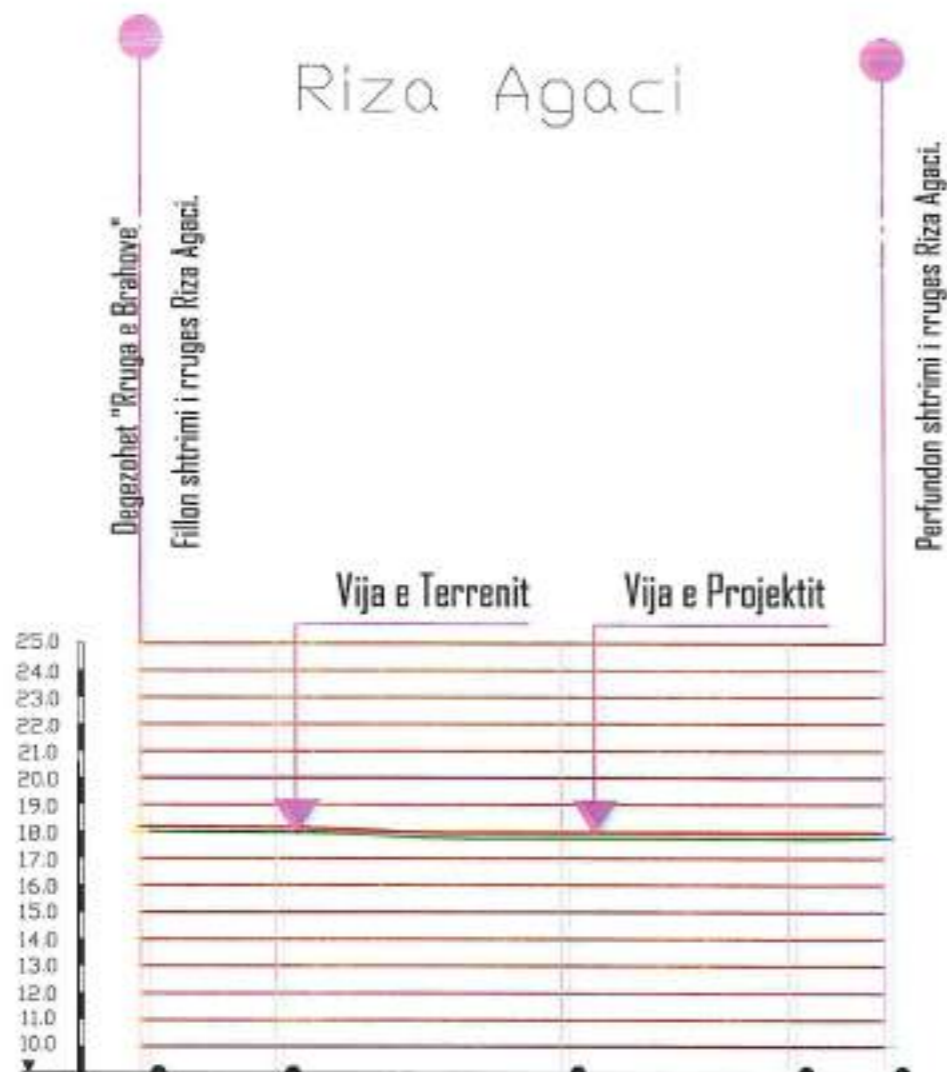

Elementet	b= 5 m asfaltobeton +2 x 0,5m kuneta + 2 x 1,5 m trotuare , L=50 m				
Diferenca (cm)	28	28	28	28	28
Kuota e Projektit	18.28	18.33	18.18	18.18	18.18
Kuota e piketes	18.00	18.05	17.90	17.90	17.90
Nr. Piketes	0	1	2	3	4
Distanca Pjesore		25	53	42	20
Distanca Progressive	0	25	78	120	140

# Arqile Kaceli

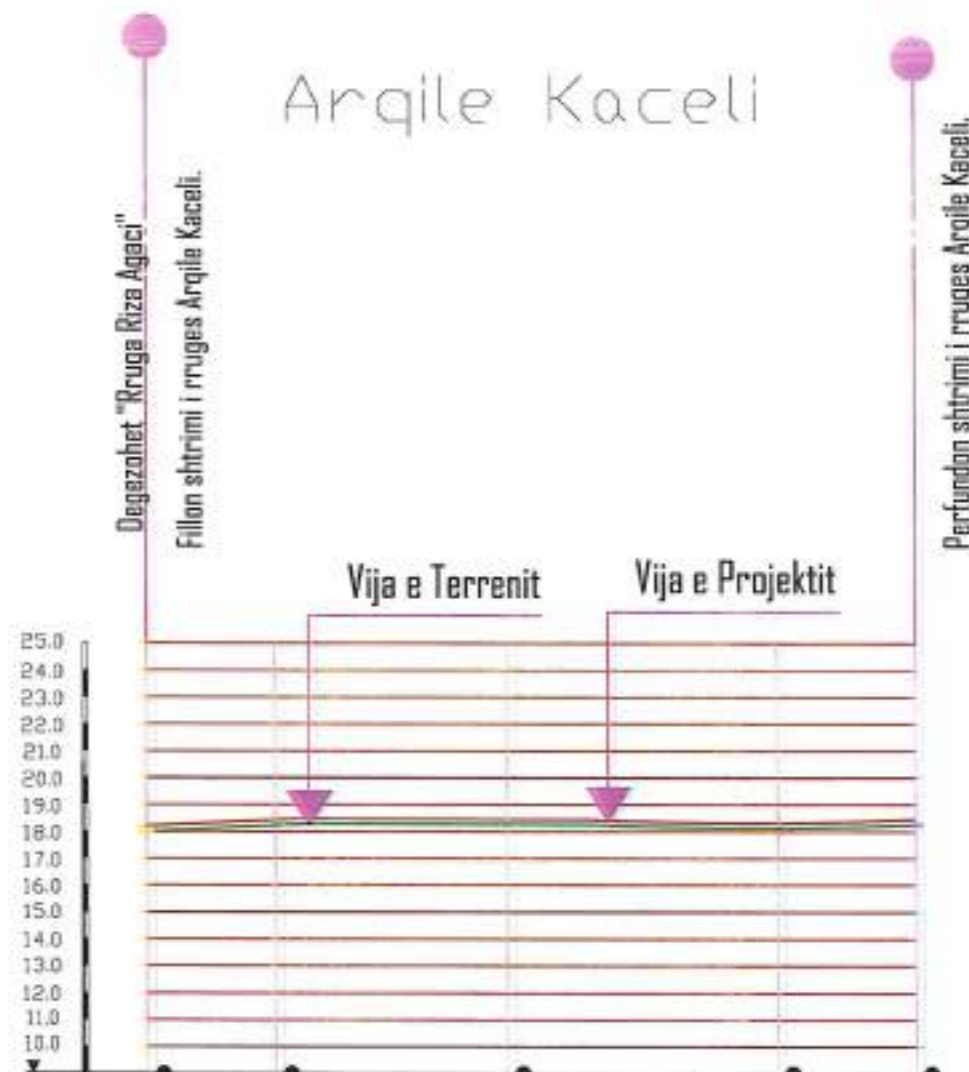

Elementet	b= 5 m asfaltobeton +2 x 0,5m kuneta + 2 x 1,5 m trotuare , L=50 m				
Diferenca (cm)	28	28	28	28	28
Kuota e Projektit	18.28	18.33	18.33	18.18	18.33
Kuota e piketes	18.00	18.05	18.05	17.90	18.05
Nr. Piketes	0	1	2	3	4
Distanca Pjesore		24	43	50	26
Distanca Progressive	0	24	67	117	137



Ministria e Transportit dhe Infrastruktura  
 Bashkia e Prizrenit  
 Miratim dhe Kuvend

Projektant:  
 INZHINIERI I RRUGAVE DHE TRANSPORTIT  
 INZHINIERI I RRUGAVE DHE TRANSPORTIT

Grupi i Projektimit:  
 Inzh. Enxhel Haxhiu  
 Inzh. Enxhel Haxhiu  
 Inzh. Enxhel Haxhiu

Udhëheqës i Projektit:  
 Enxhel Haxhiu

Titulli i Projektit:  
 PRORIEGJIM I RRUGES

Data:  
 05.10.2023

Fleta: 03 Nr.  
 05

# PROFILI TIP P.1-P.4

## RRUGA " ARQILE KAÇELI"

KUOTA E PROJEKTIT

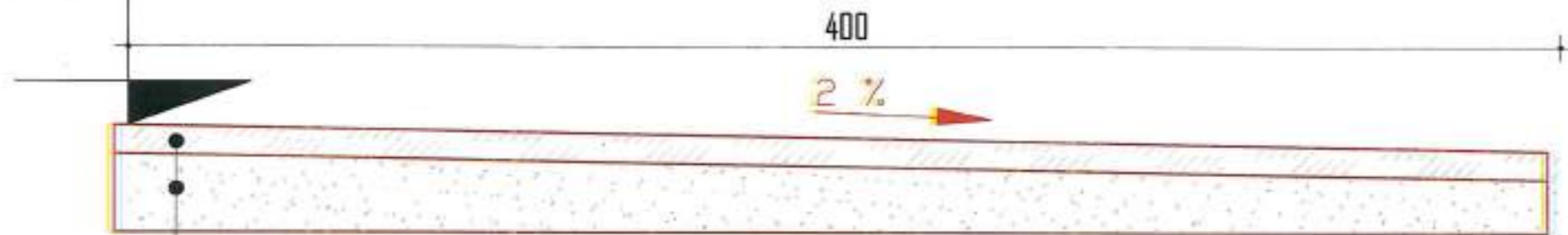

SHTRESE ASFALTOBETONI I PERZIER t=5cm

SHTRESE STABILIZANTI t=5cm

SHTRESE EKZISTUESE

	Republika e Shqipërisë Ministria e Transportit dhe Infrastruktura Dytë Detyrues	Projekti: <b>REKONSTRUKTIONI I RRUGËS "ARQILE KAÇELI" NË QYLLIN "KALIBRE" NË BASHKIËN E DIBRËS</b>	Grupi i Projektimit: <b>INSTITUTI I INJENIERISË DHE ARKITEKTURËS</b> Inxhinjeri i Projektit: <b>[Signature]</b>	Drejtori i PZSHTT: <b>[Signature]</b> Inxhinjeri i Projektit: <b>[Signature]</b>	Titulli i Fietë: <b>PROFILI TIP I RRUGËS</b>	Fletë: <b>06</b>	Fletë e 483/1 Nr. <b>06</b>
	Shtetëria: _____ Emri i Fietë: _____						

PROFILAT TERTHORE  
 Profili Nr.0  
 Progresivi 0.00 m  
 K.Tokes 131.00 m  
 K.Projektit 131.25 m  
 Germim= 0.64 m3/m  
 Mbushje= 1.3 m3/m



KUOTA E TOKES	131.00	131.00	131.00
D.PJESORE TOKES	2.38	2.00	2.00
KUOTA PROJEKTIT	131.25	131.25	131.25
D.PJESORE PROJEKTIT	2.38	2.00	2.00

PROFILAT TERTHORE  
 Profili Nr.1  
 Progresivi 90.00 m  
 K.Tokes 136.00 m  
 K.Projektit 136.25 m  
 Germim= 0.64 m3/m  
 Mbushje= 1.3 m3/m

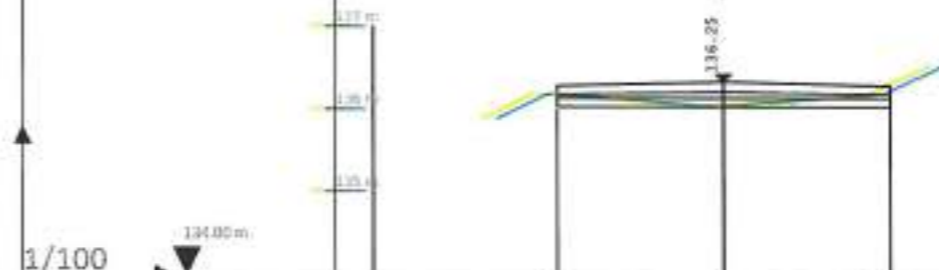

KUOTA E TOKES	136.00	136.00	136.00
D.PJESORE TOKES	2.00	2.00	2.00
KUOTA PROJEKTIT	136.25	136.25	136.25
D.PJESORE PROJEKTIT	2.00	2.00	2.00

PROFILAT TERTHORE  
 Profili Nr.2  
 Progresivi 190.00 m  
 K.Tokes 136.00 m  
 K.Projektit 136.25 m  
 Germim= 0.64 m3/m  
 Mbushje= 1.3 m3/m

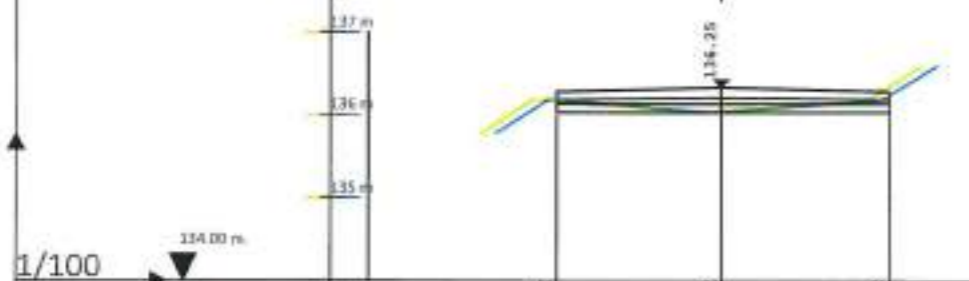

KUOTA E TOKES	136.00	136.00	136.00
D.PJESORE TOKES	2.38	2.00	2.00
KUOTA PROJEKTIT	136.25	136.25	136.25
D.PJESORE PROJEKTIT	2.38	2.00	2.00



Prosesites:  
 Ministria e Transportit dhe Infrastrukturae  
 D. Pjesore e Transportit dhe Infrastrukturae

Projekt:  
 RIKONSTRUKTIONE E RRUGES DHE TERSHORE E  
 RRUGES DHE TERSHORE E RRUGES

Grupi i Projektimit:  
 Inzh. Shkurti Hoxha  
 Inzh. Evrel Hoxha  
 Inzh. Edmond Hoxha

Directori i PZSHIT:  
 Inzh. Shkurti Hoxha

Titull i ofrimit:  
 PROFILI I TERTHORE E RRUGES

Librete  
 Shkollor

30.02.2023

Fleta 434r

PROFILAT TERTHORE  
 Profili Nr.3  
 Progresivi 310.00 m  
 K.Tokes 13.00 m  
 K.Projektit 138.25 m  
 Germim= 0.64 m3/m  
 Mbushje= 1.3 m3/m

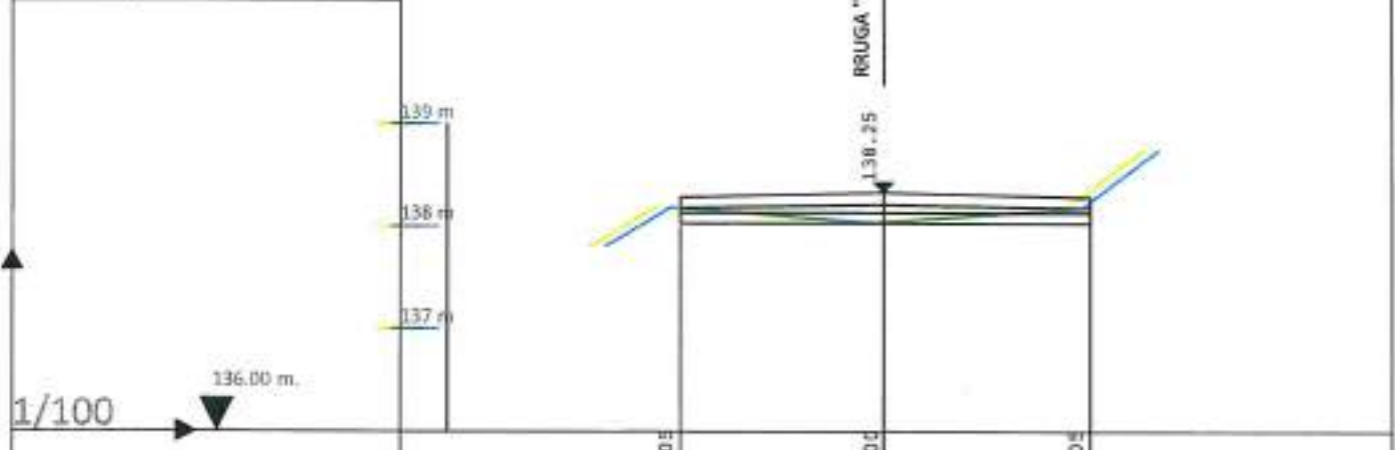

KUOTA E TOKES	138.05	138.00	138.05
D.PJESORE TOKES	2.00	2.00	
KUOTA PROJEKTIT	138.20	138.25	138.20
D.PJESORE PROJEKTIT	2.00	2.00	

PROFILAT TERTHORE  
 Profili Nr.4  
 Progresivi 390.00 m  
 K.Tokes 147.00 m  
 K.Projektit 147.25 m  
 Germim= 0.64 m3/m  
 Mbushje= 1.3 m3/m

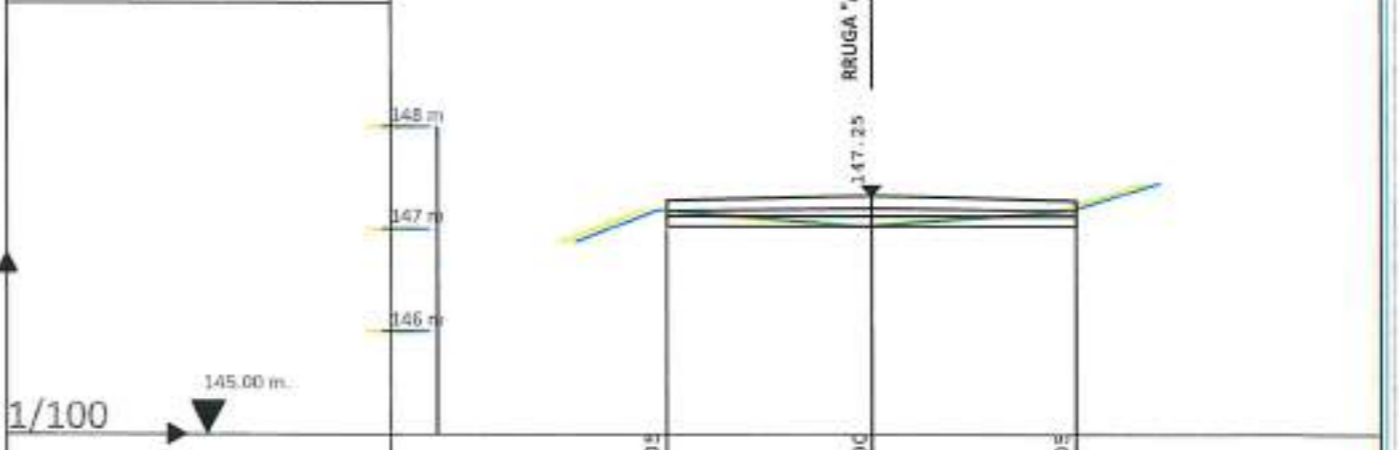

KUOTA E TOKES	147.05	147.00	147.05
D.PJESORE TOKES	2.00	2.90	
KUOTA PROJEKTIT	147.20	147.25	147.20
D.PJESORE PROJEKTIT	2.00	2.90	

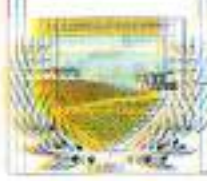

Ministria e Transportit dhe Infrastruktura  
 Detyra e Përgjithshme  
 Detyra e Përgjithshme

Projekt:  
 RRETHI I DIBRIT  
 RRETHI I DIBRIT

Grupi i Projektimit:  
 Inzh. Besnik Hoxha  
 Inzh. Erald Hoxha  
 Inzh. Eridon Krasniqi

Shënim: PZ/2023  
 Shënim: PZ/2023

Titulli i titullit:  
 PROFILAT TERTHORE

Datë: 08/10/2023  
 Shënim:

Fillore 43 Nr.

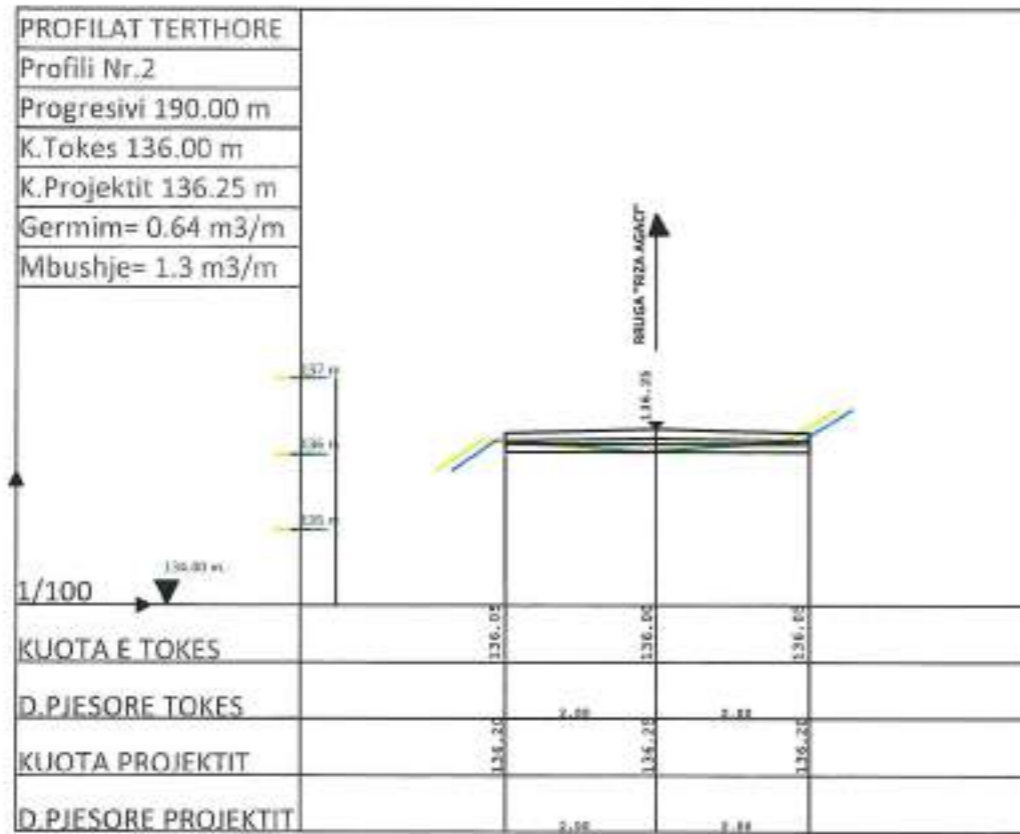
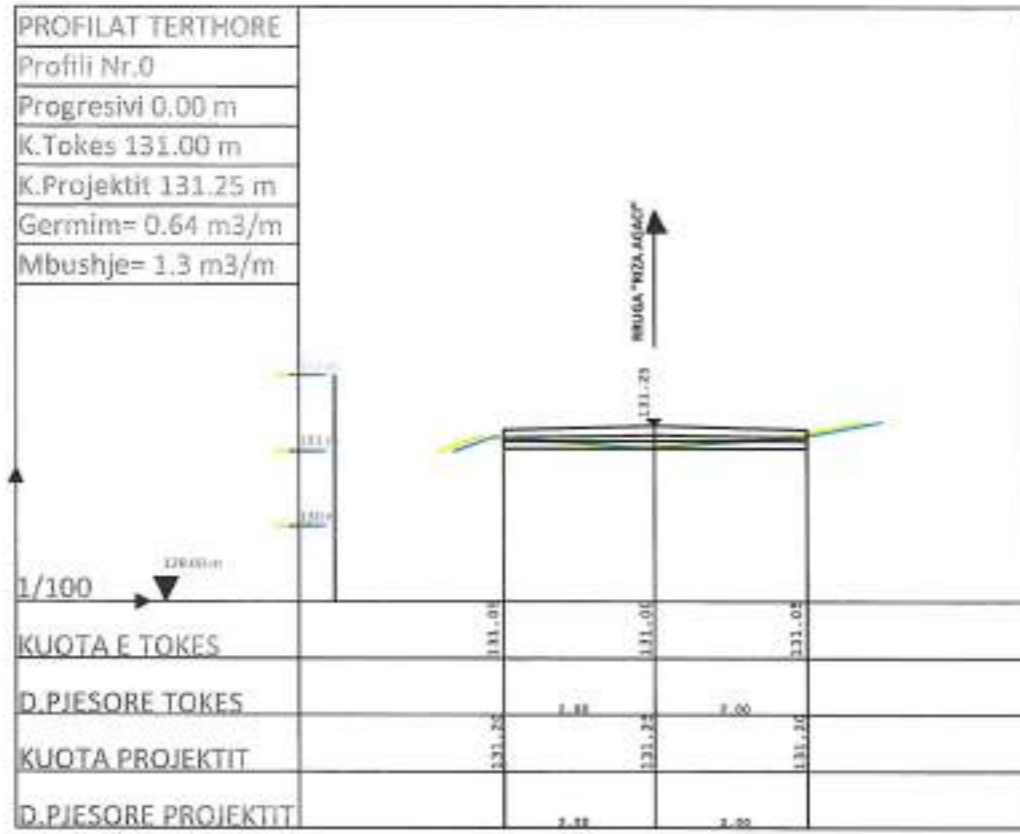

Ministria e Transportit dhe Infrastruktura  
 Ministri: *[Signature]*  
 Kryetar: *[Signature]*

Projekt:  
 RRETHI I TIRANES  
 RRETHI I TIRANES

Grupi i Projektimit:  
 Inzh. *[Signature]*  
 Inzh. *[Signature]*  
 Inzh. *[Signature]*

Udhëheqës i Projektit:  
*[Signature]*

Titull i detyrës:  
 PROROGJETA E TRAZA AGACI

Datë:  
 05/02/2023

05/02/2023

Titull i detyrës:

**PROFILAT TERTHORE**  
 Profili Nr.3  
 Progresivi 310.00 m  
 K.Tokes 13.00 m  
 K.Projektit 138.25 m  
 Germim= 0.64 m<sup>3</sup>/m  
 Mbushje= 1.3 m<sup>3</sup>/m

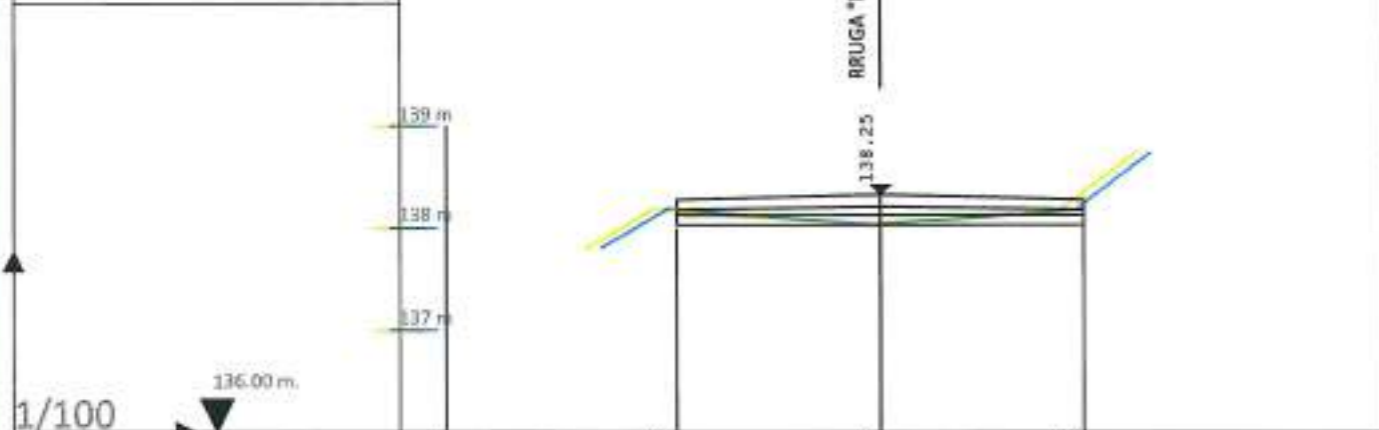

KUOTA E TOKES	138.05	138.05	138.05
D.PJESORE TOKES	2.00	2.00	2.00
KUOTA PROJEKTIT	138.25	138.25	138.25
D.PJESORE PROJEKTIT	2.00	2.00	2.00

**PROFILAT TERTHORE**  
 Profili Nr.4  
 Progresivi 390.00 m  
 K.Tokes 147.00 m  
 K.Projektit 147.25 m  
 Germim= 0.64 m<sup>3</sup>/m  
 Mbushje= 1.3 m<sup>3</sup>/m

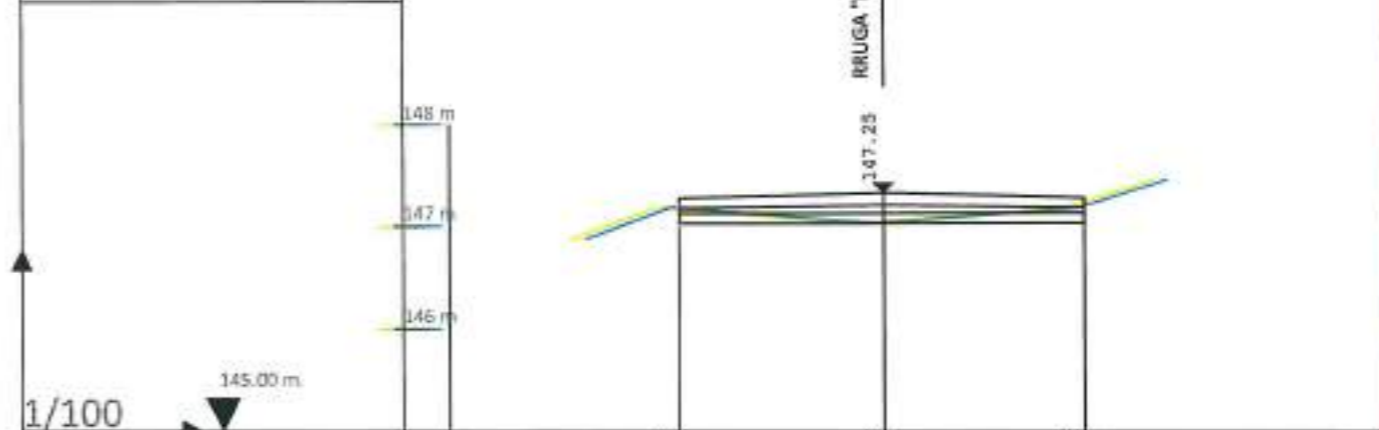

KUOTA E TOKES	147.05	147.05	147.05
D.PJESORE TOKES	2.00	2.00	2.00
KUOTA PROJEKTIT	147.25	147.25	147.25
D.PJESORE PROJEKTIT	2.00	2.00	2.00



Ministria e Transportit dhe Infrastruktura  
 Detyra e Përgjithshme

Projekt:  
 RRETHI I RRUGËVE TË BASHKËPËRITIMIT

Grupi i Projektimit:  
 Inzh. Ferit Hoxha  
 Inzh. Tahir Hoxha  
 Inzh. Edmond Kumbi

Drejtor i PZSHIT:  
 Ferit Hoxha

Titulli i fletës:  
 PROFILI TERTHORE I RRUGËS

Dite:  
 Shtetëria:

Data: 05/10/2023

Fletës: 4/3 Nr.



Republika e Kosovës

# OBJEKTE ASFALTIMI I RRUGËVE TË BRENDESHME NË LAGJET E BASHKISË ROSKOVEC (RRUGA RUKALLARET)

	<p>Republika e Kosovës Ministria e Transportit dhe Infrastruktura</p>	<p>Projekt: ASFALTIMI I RRUGËVE TË BRENDESHME NË LAGJET E BASHKISË ROSKOVEC</p>	<p>Grupi i Projektimit: Inzh. Shkëlqim Hoxha Inzh. Shkëlqim Hoxha Inzh. Edmond Hoxha</p>	<p>Engjeteri: Inzh. Shkëlqim Hoxha</p>	<p>Tërbulluesi: KAPAKU</p>	Udhëto:	10/10/2023	Finanço:	AKS/10
						SS/Inzh. Hoxha			



 <p>Ministerstwo Rolnictwa i Rolnictwa Kraju</p>	<p>Projekt:</p> <p>WZKŁADANIE I REALIZACJA ZADANIA W ZAKRESIE WYKONANIA PRAC PROJEKTYWY</p>	<p>Grupa Projektowa:</p> <p>Województwo Łódzkie Urząd Województwa Łódzkiego Urząd Marszałkowski Województwa Łódzkiego</p>	<p>Wykonawca:</p> <p>Instytut Inżynierów i Architektów</p>	<p>Adres:</p> <p>22-000 WIELICHA (ul. Główna 10)</p>	<p>Dotyczy:</p> <p>22-000 WIELICHA (ul. Główna 10)</p>	<p>Data:</p> <p>2023</p>	<p>Strona 1 z 1</p>
					<p>Wieliczka</p>	<p>2023</p>	



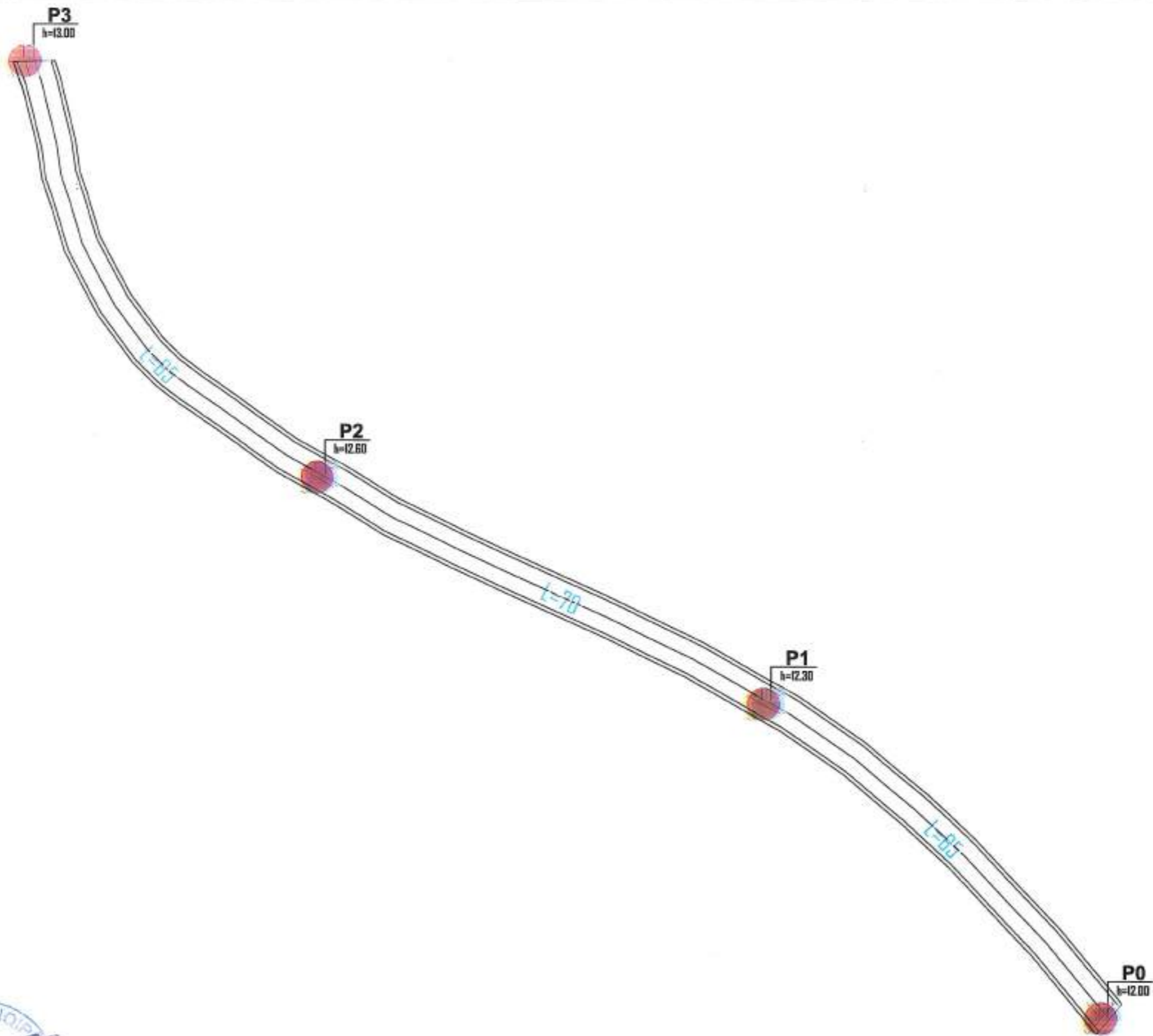

Republika e Shqipërisë  
 Ministria e Transportit dhe Infrastruktura  
 Detyrueshë

Projekt: **REKONSTRUKTIONI I RRUGËS NË BARRAZHINË**  
**UNIKUT TË BARRAZHINË**

Grupi i Propozimit: *[Signature]*  
 Grupi i Ekuilibrit: *[Signature]*  
 Grupi i Kalkulimit: *[Signature]*

Grupi i PZSHIT: *[Signature]*  
 Grupi i Kalkulimit: *[Signature]*

Titulli i Titullit: **PROJEKTI I REKONSTRUKTIMIT TË RRUGËS NË BARRAZHINË**  
**UNIKUT TË BARRAZHINË**

Data: **08.10.2023**  
 Shtetë:

Nr. i Dokumentit: **423/Kr.**  
**02**

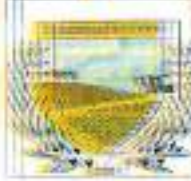

#Prep sites  
 #Resilient Communities  
 #Munoz  
 #Kusap  
 #National Office of Technical Services

#Project:  
 #SANTO NINO RIVER REHABILITATION PROJECT  
 #LUGAY, BANGAL, ROSARIO

#Group / #Project Unit:  
 #Eng. Enrico B. Babilon  
 #Eng. David B. Babilon  
 #Eng. Edson B. Babilon

#Project: #E-ZACT:  
 #Enrico B. Babilon

#Title Office:  
 #NATIONAL OFFICE OF TECHNICAL SERVICES

#Date  
 #SS/Date

#Date: 08/22/2023

#Sheet: 03

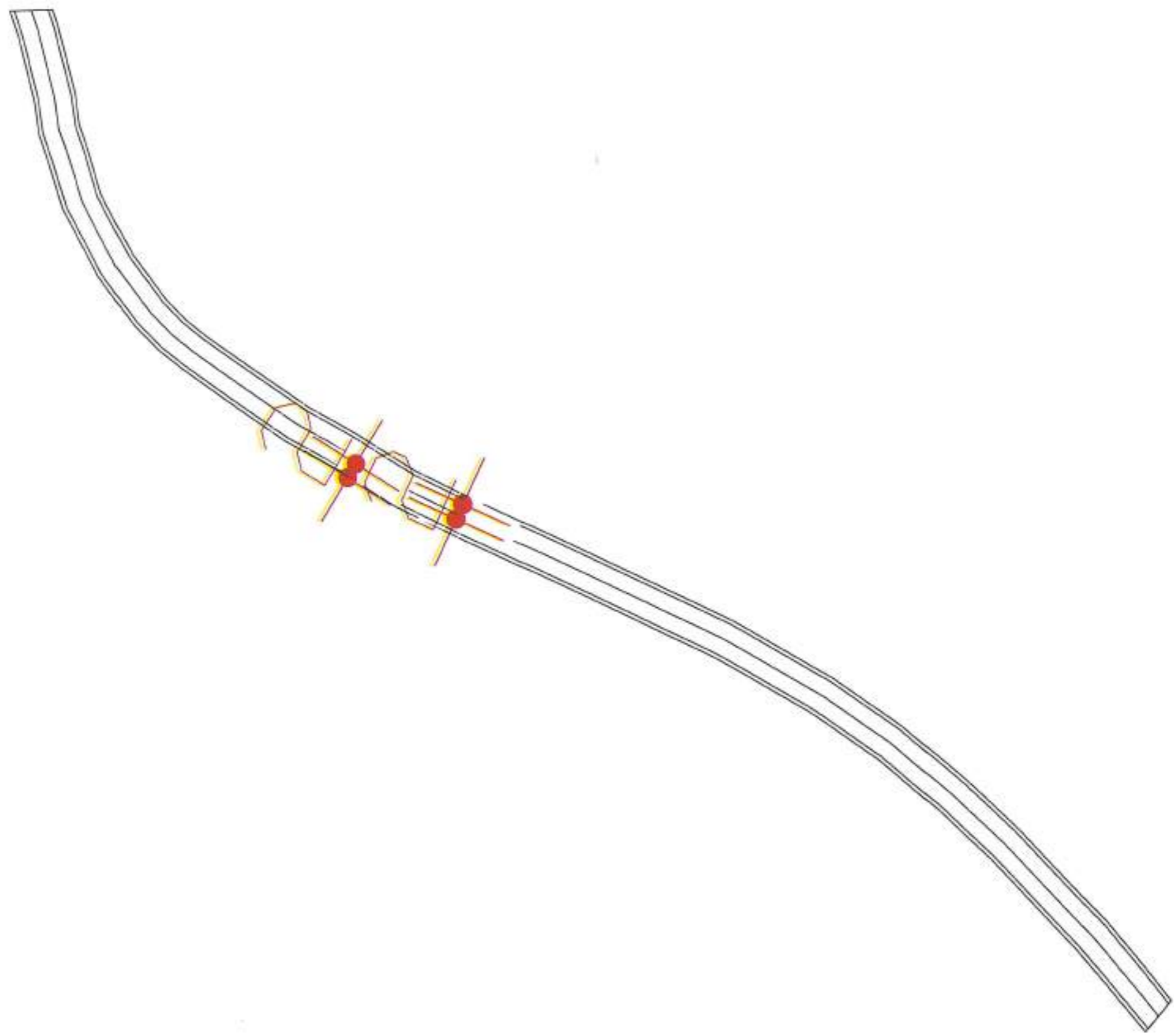

Ministria e Transportit dhe Infrastruktura  
 Drektori i Përgjithshëm

Projekti:  
 RINDRITJA E RREZES DORZIT  
 NË QARKUN DORZIT

Grupi i Përgjegjësimit:  
 Inzh. Shkëlqim Mëhilli  
 Inzh. Valdet Mëhilli  
 Inzh. Shkëlqim Mëhilli

Drejtori: HAZHET  
 Emri i Autorit

Titulli i detyrës:  
 DREKTOR I PËRGJITHSHËM

Drejtoria  
 Shtetli

Dati: 15/12/2023

Fila e 434  
 04

# PROFILI GJATESOR

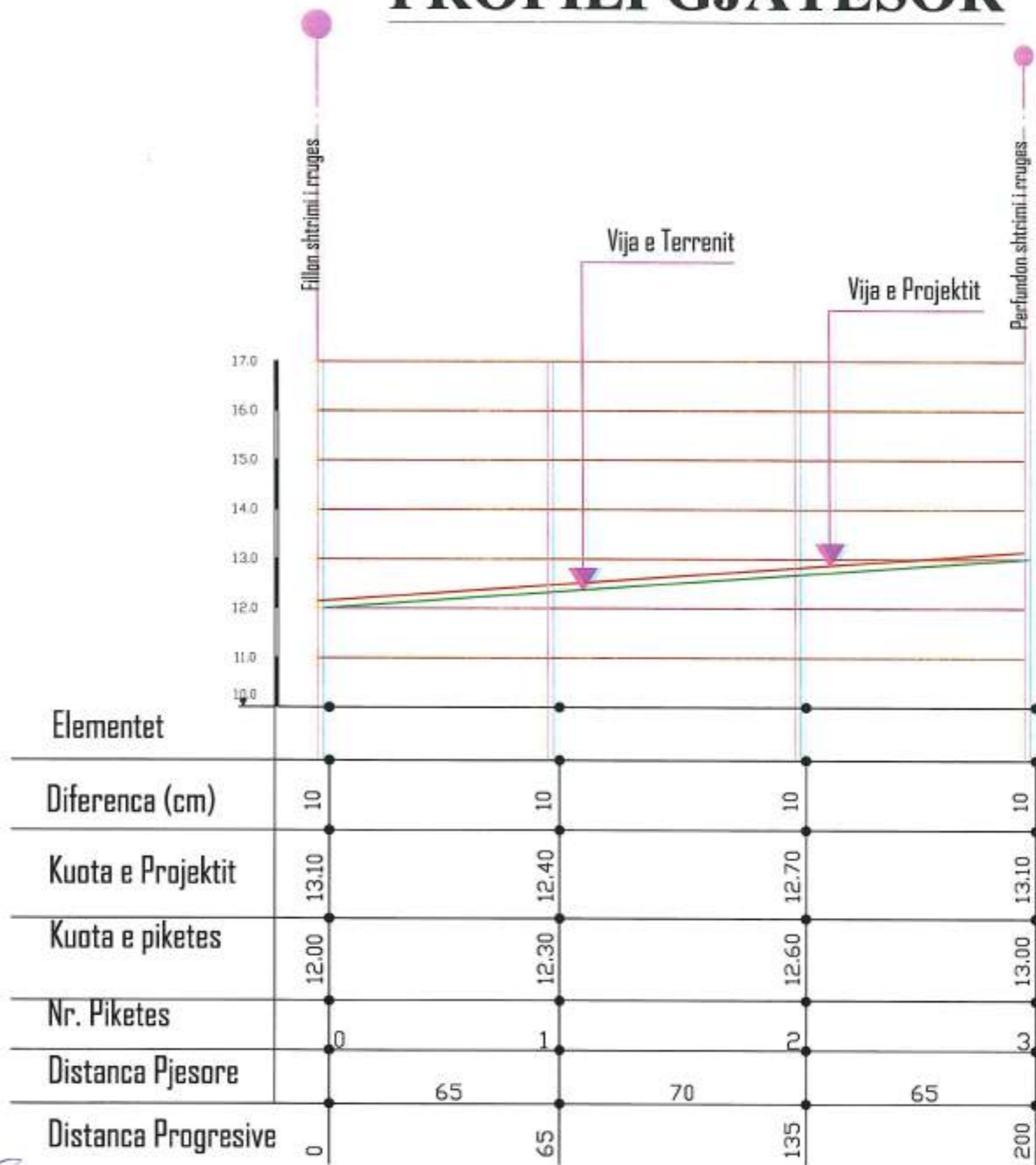

Projekt: **REKONSTRUKTURA E RRUGES NË BARRAZHËN E BARRAZHËS**  
**MAJLLET E BARRAZHËS E BARRAZHËS**

Grupi i Projektimit:  
 Inxh. Tahir Alibonani  
 Inxh. Saim Haxhiu  
 Inxh. Tahir Alibonani

Drejtori i Zërit:  
 Enxh. Haxhi

Titulli i titullit:  
**PROFILI GJATESOR I RRUGES**

Datë: **12/12/2023**  
 Shtatori

Fila e 05

# PROFILI TIP RRUGA "RUKALLARET"

## P.0-P.3

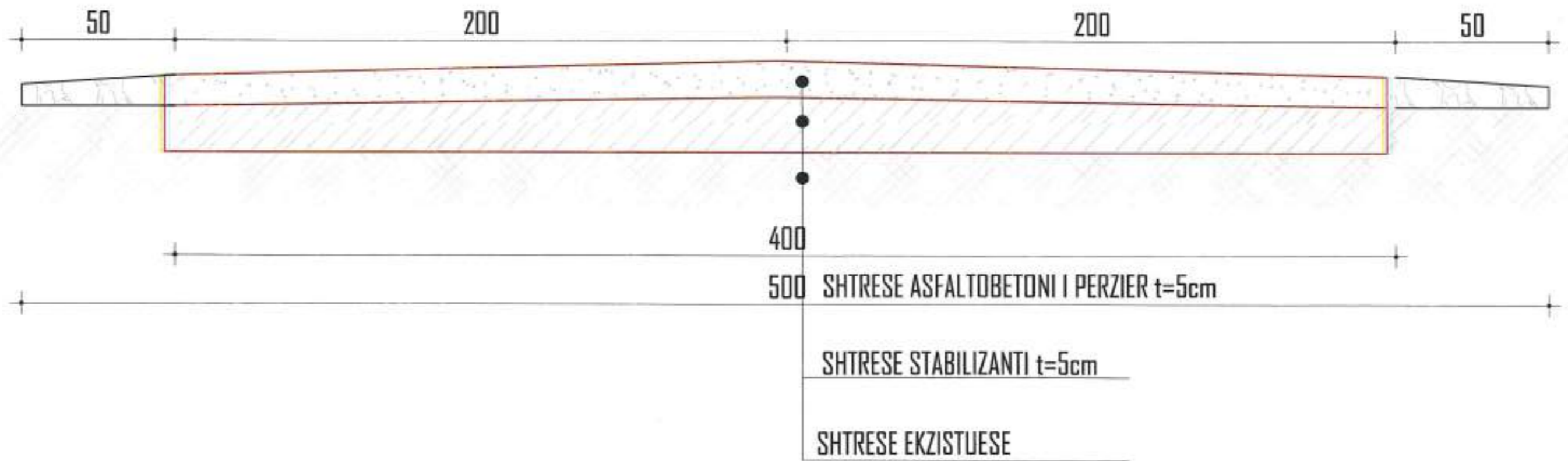

Ministria e Infrastrukturës dhe Transportit  
Drejtoria e Përgjithshme e Rrugëve  
Kryeqyteti i Tiranës

Projekti:  
ANALIZIM I RREZESIT TË BIRANISHTËS  
LINDJEJE TË BIRANISHTËS RREZESIT

Ekzistuesi / Përgjegjësi i punës:  
Inxhinjieri / Përgjegjësi i punës:  
Inxhinjieri / Përgjegjësi i punës:  
Inxhinjieri / Përgjegjësi i punës:

Drejtori: HAZHETI  
Inxhinjieri / Përgjegjësi i punës:

Vendi i punës:  
PRERULLI TËPËR RREZESIT

Drejtori:  
Shtetësi:

Drejtori: 01/10/2023

Fletënumeri: 06

PROFILAT TERTHORE  
 Profili Nr.0  
 Progresivi 0.00 m  
 K.Tokes 131.00 m  
 K.Projektit 131.25 m  
 Germim= 0.64 m3/m  
 Mbushje= 1.3 m3/m

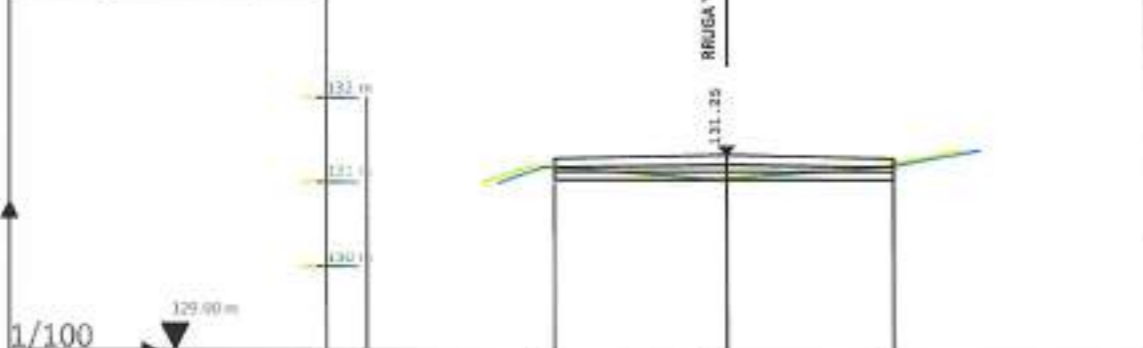

KUOTA E TOKES	131.00	131.00	131.00
D.PJESORE TOKES	2.00	2.00	2.00
KUOTA PROJEKTIT	131.25	131.25	131.25
D.PJESORE PROJEKTIT	2.00	2.00	2.00

PROFILAT TERTHORE  
 Profili Nr.1  
 Progresivi 90.00 m  
 K.Tokes 136.00 m  
 K.Projektit 136.25 m  
 Germim= 0.64 m3/m  
 Mbushje= 1.3 m3/m

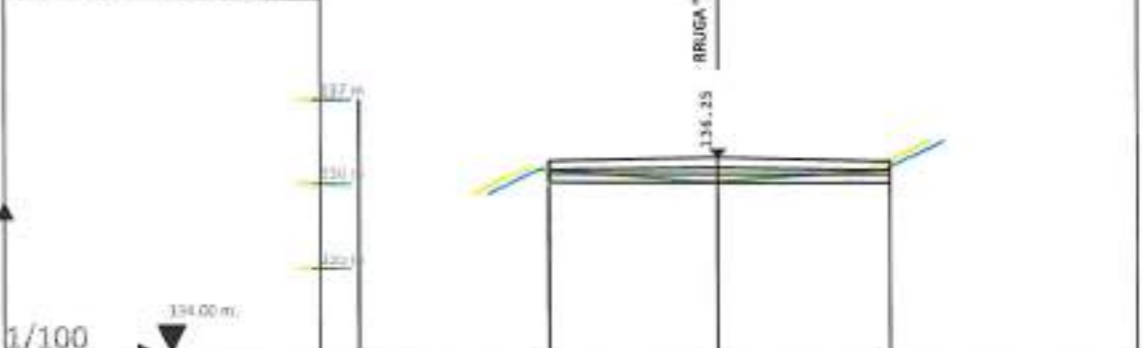

KUOTA E TOKES	136.00	136.00	136.00
D.PJESORE TOKES	2.00	2.00	2.00
KUOTA PROJEKTIT	136.25	136.25	136.25
D.PJESORE PROJEKTIT	2.00	2.00	2.00

PROFILAT TERTHORE  
 Profili Nr.2  
 Progresivi 190.00 m  
 K.Tokes 136.00 m  
 K.Projektit 136.25 m  
 Germim= 0.64 m3/m  
 Mbushje= 1.3 m3/m

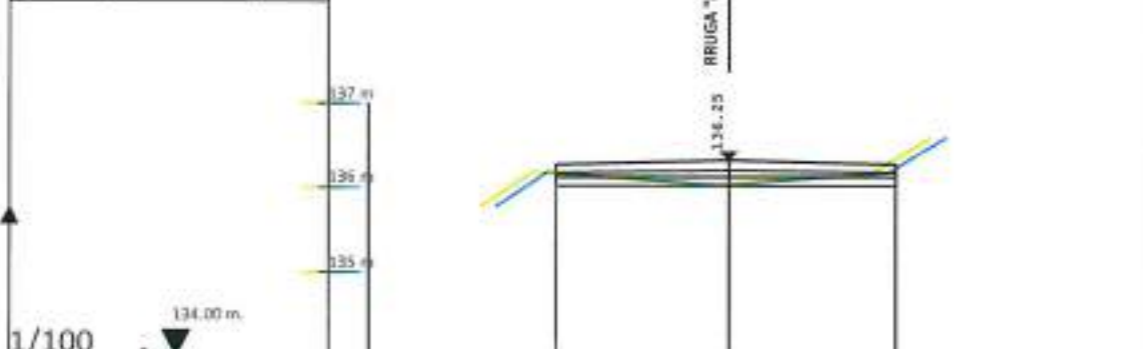

KUOTA E TOKES	136.00	136.00	136.00
D.PJESORE TOKES	2.00	2.00	2.00
KUOTA PROJEKTIT	136.25	136.25	136.25
D.PJESORE PROJEKTIT	2.00	2.00	2.00

PROFILAT TERTHORE  
 Profili Nr.3  
 Progresivi 310.00 m  
 K.Tokes 138.00 m  
 K.Projektit 138.25 m  
 Germim= 0.64 m3/m  
 Mbushje= 1.3 m3/m

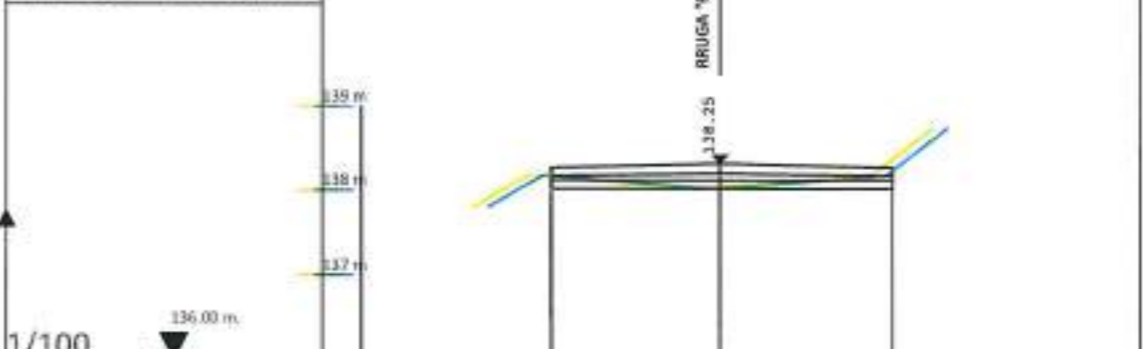

KUOTA E TOKES	138.00	138.00	138.00
D.PJESORE TOKES	2.00	2.00	2.00
KUOTA PROJEKTIT	138.25	138.25	138.25
D.PJESORE PROJEKTIT	2.00	2.00	2.00



Himnosja e Shqipërisë  
 Ministria e Transportit dhe Infrastruktura  
 Drejtoria e Përgjithshme të Rrugëve  
 Kuvendi i Ministrave

Projekt:  
 RRETHI I DUKAGJIT  
 RRETHI I BIRANIS  
 RRETHI I BIRANIS

Grupi i Projektimit:  
 Inzh. Shkëlzen Hoxha  
 Inzh. Ardit Hoxha  
 Inzh. Edmond Hoxha

Emetimi i Projektit:  
 Inzh. Shkëlzen Hoxha

Titulli i Titrit:  
 PROFILAT TERTHORE TE RRUGES

Data:  
 05.07.2023

05.07.2023

Firma e Shprehur



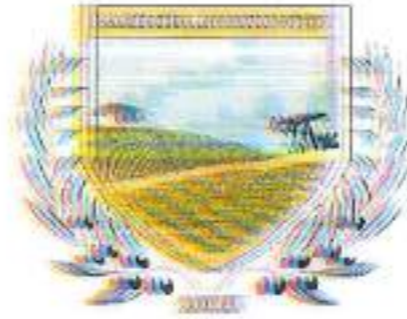

Republika e Shqipërisë

# OBJEKTI: ASFALTIMI I RRUGËVE TË BRENDESHME NË LAGJET E BASHKISË ROSKOVEC (RRUGA BUZALLARET+DOKSANET)



Ministria e Punëve  
Publike dhe Transportit  
Kryeministria



Projekti:

ASFALTIMI I RRUGËVE TË BRENDESHME NË  
LAGJET E BASHKISË ROSKOVEC

Elizbete P. Pajtimiri

Ministria e Punëve  
Publike dhe Transportit  
Kryeministria

Elizbete P. Pajtimiri

Ministria e Punëve  
Publike dhe Transportit  
Kryeministria

10/10/2023

10/10/2023

10/10/2023

10/10/2023

10/10/2023

10/10/2023



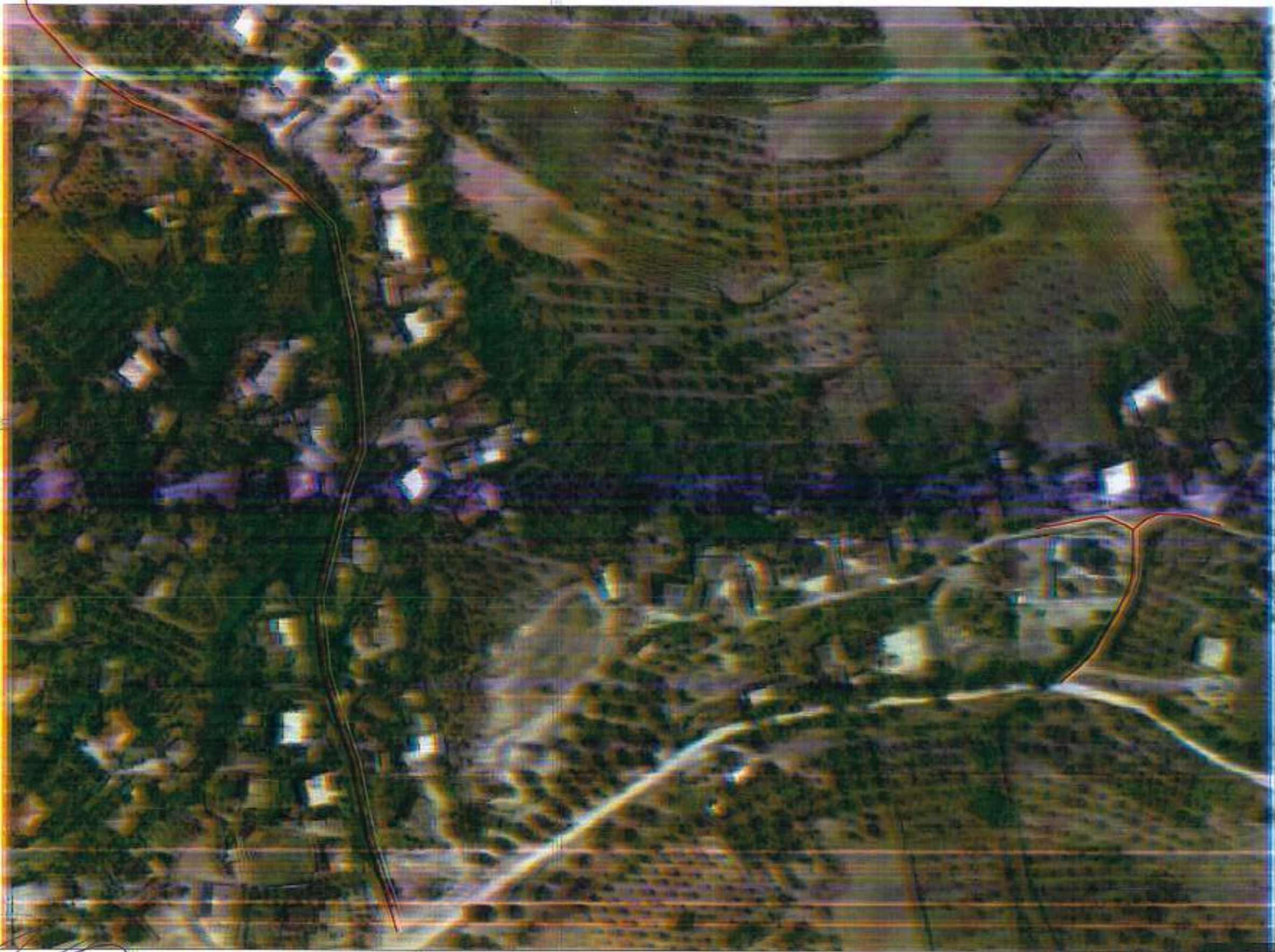

© NUIKazems



Հանրապետության  
 Կառավարություն  
 Կառավարության  
 Կառավարության

Մարզիկ :  
 ԱՐՄՏԱԿԱՆ ԻՐԱԿԱՆԱԿԱՆ ԵՐԱՐԱՆՈՒՄՆԵՐԻ  
 ԼՈՎԵԼԻ ԵՐԱՐԱՆՈՒՄՆԵՐԻ ԴՐՈՍԿԱՊԵՆ

Գերագույն Գործադիր օրենսդրություն :  
 Կողմից Երևանի Կոմիտեի  
 Կողմից Երևանի Կոմիտեի  
 Կողմից Երևանի Կոմիտեի

Երևանի Կոմիտեի  
 Երևանի Կոմիտեի

Կառավարություն :  
 ՀՀ ԿԱՌԱՎԱՐՈՒԹՅԱՆ ԿԱՌԱՎԱՐՈՒԹՅԱՆ  
 ԿԱՌԱՎԱՐՈՒԹՅԱՆ

Երևան  
 ՏՏԻՎԱԿԱՆ

ՄԱՐԿԱ  
 10510222023

Կառավարություն



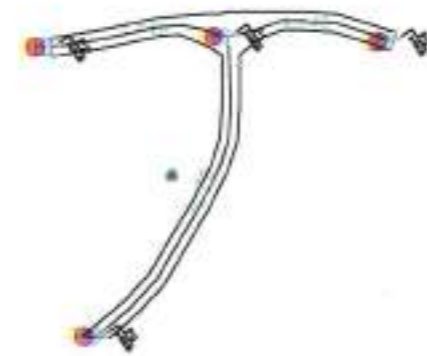

Republika e Shqipërisë  
 Ministria e Transportit dhe Infrastruktura  
 Detyrueshmëri

Projekt: **REKONSTRUKTIONI I RREZES SHTETËRE  
 DHE RREZES KOMUNALE**

Klienti: **INSTITUTI I PLANIMIT TERRITORIAL  
 DHE URBANOR**

Klienti: **INSTITUTI I PLANIMIT TERRITORIAL  
 DHE URBANOR**

Titulli i planit: **PLANI I RREZES SHTETËRE  
 DHE RREZES KOMUNALE**

Qyteti:  
 Shkallë:

Data: **15/10/2023**

Fletë: **12**

3. Nullwert

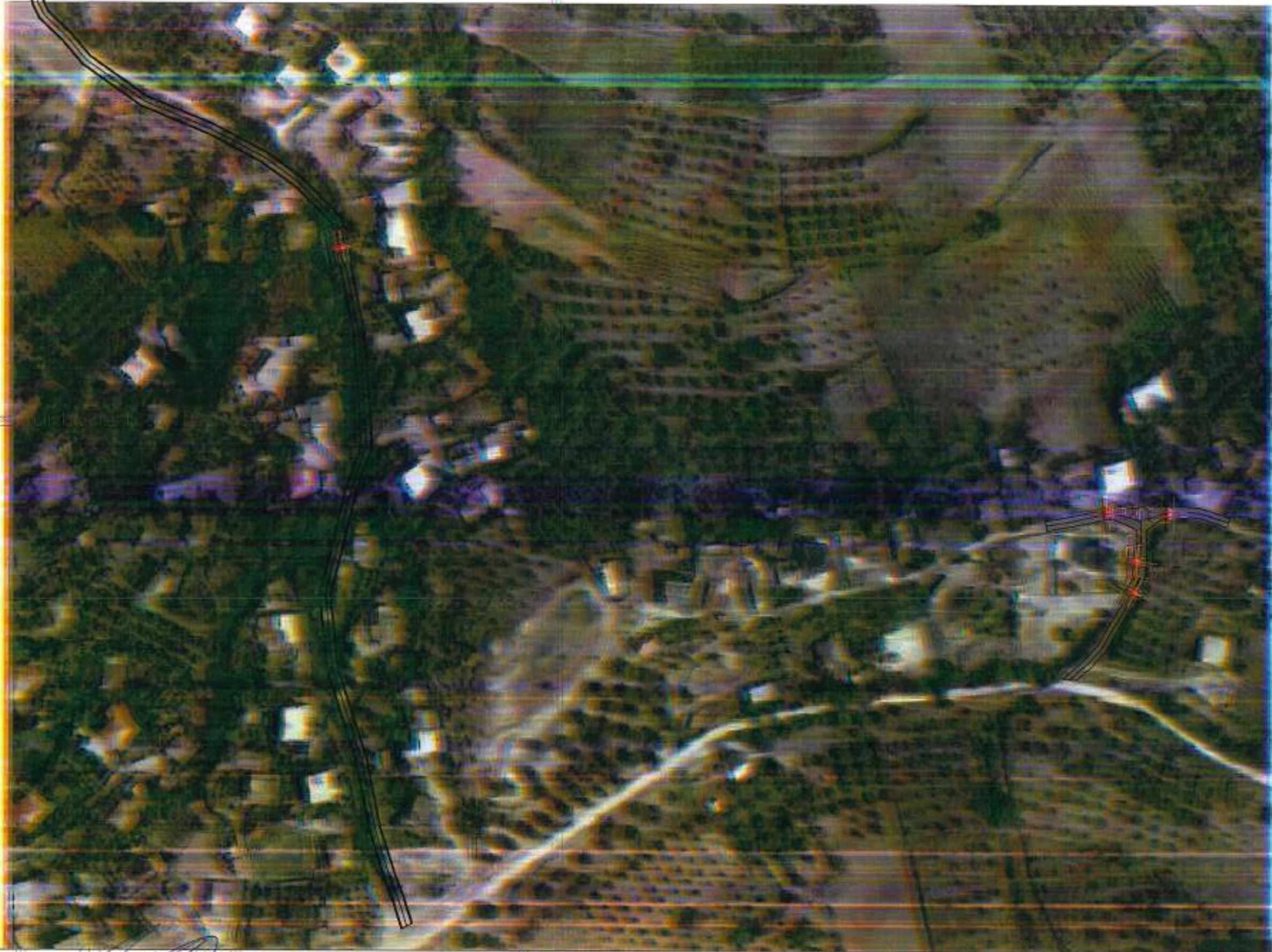

Promotions  
 Ministerium  
 für  
 Wirtschaft, Energie  
 und Klimaschutz

Projekt:  
 ASKANIENWIRTSCHAFTS-  
 ENTWICKLUNGSPROJEKT  
 BRANDENBURG

Gruppe / Projektname:  
 ASKANIENWIRTSCHAFTS-  
 ENTWICKLUNGSPROJEKT  
 BRANDENBURG

Betreiber / ANTRAG:  
 ASKANIENWIRTSCHAFTS-  
 ENTWICKLUNGSPROJEKT  
 BRANDENBURG

Trassenlinie:  
 ASKANIENWIRTSCHAFTS-  
 ENTWICKLUNGSPROJEKT  
 BRANDENBURG

Datum: 08/02/2023  
 Skizze:

Folio 03 von 03

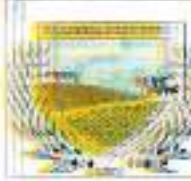
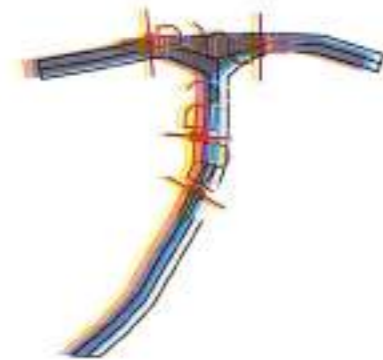
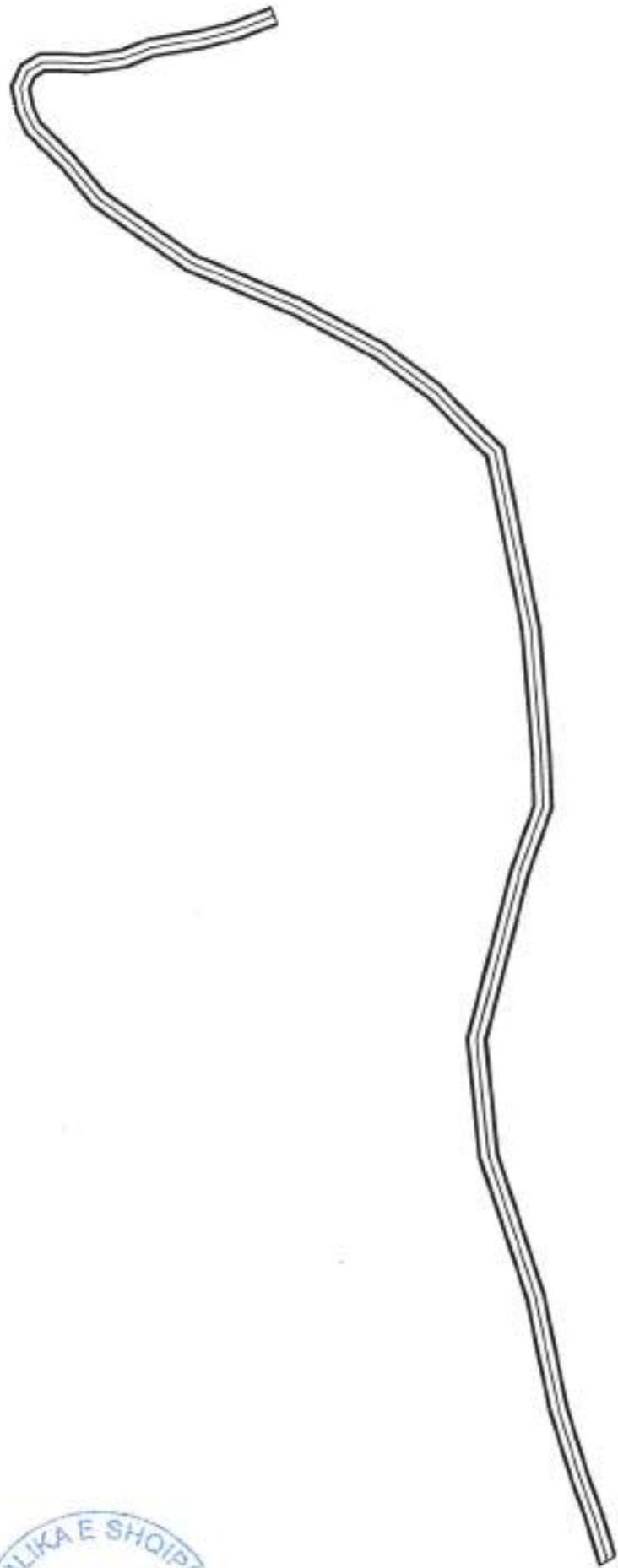

Republika e Shqipërisë  
Ministria e Transportit dhe Infrastruktura  
Kryetari i Komitetit të Përbashkët



Projekti:  
ANALIZIM I RILINDIMIT E BARRAZHIMIT  
LINDIMIT E BARRAZHIMIT

Grupi i Projektimit:  
Inzh. Et'hem Hoxha  
Inzh. Fehmi Hoxha  
Inzh. Edmond Kallulli

Organizimi:  
Instituti Kombëtar

Titulli i Kartës:  
PLANIMETRIA E PËRÇLITSHMËRIE

Data: 05/02/2023  
Shënimet:

Titulli i Kartës:  
04

# PROFILI GJATESOR

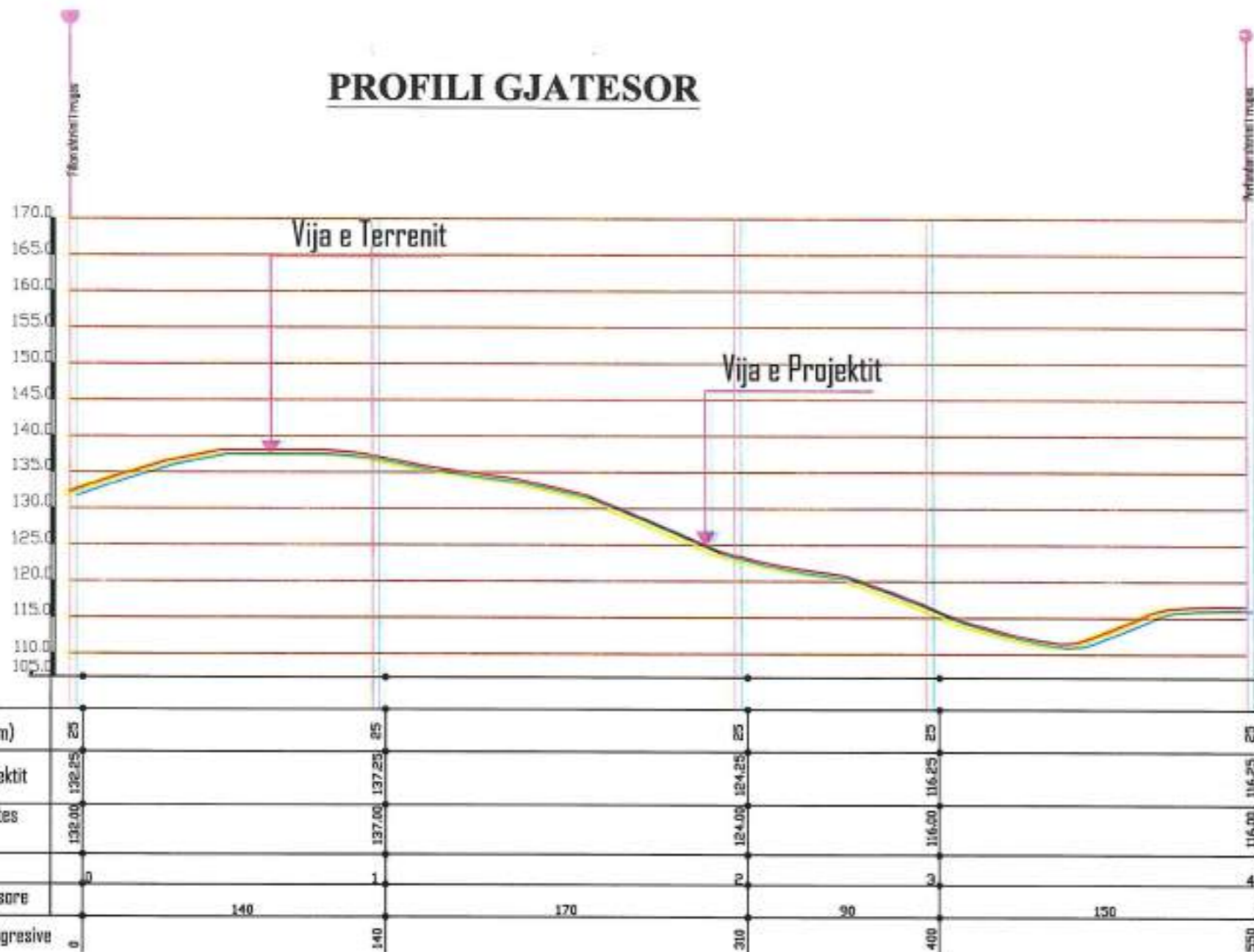

# PROFILI GJATESOR "DOKSANET"

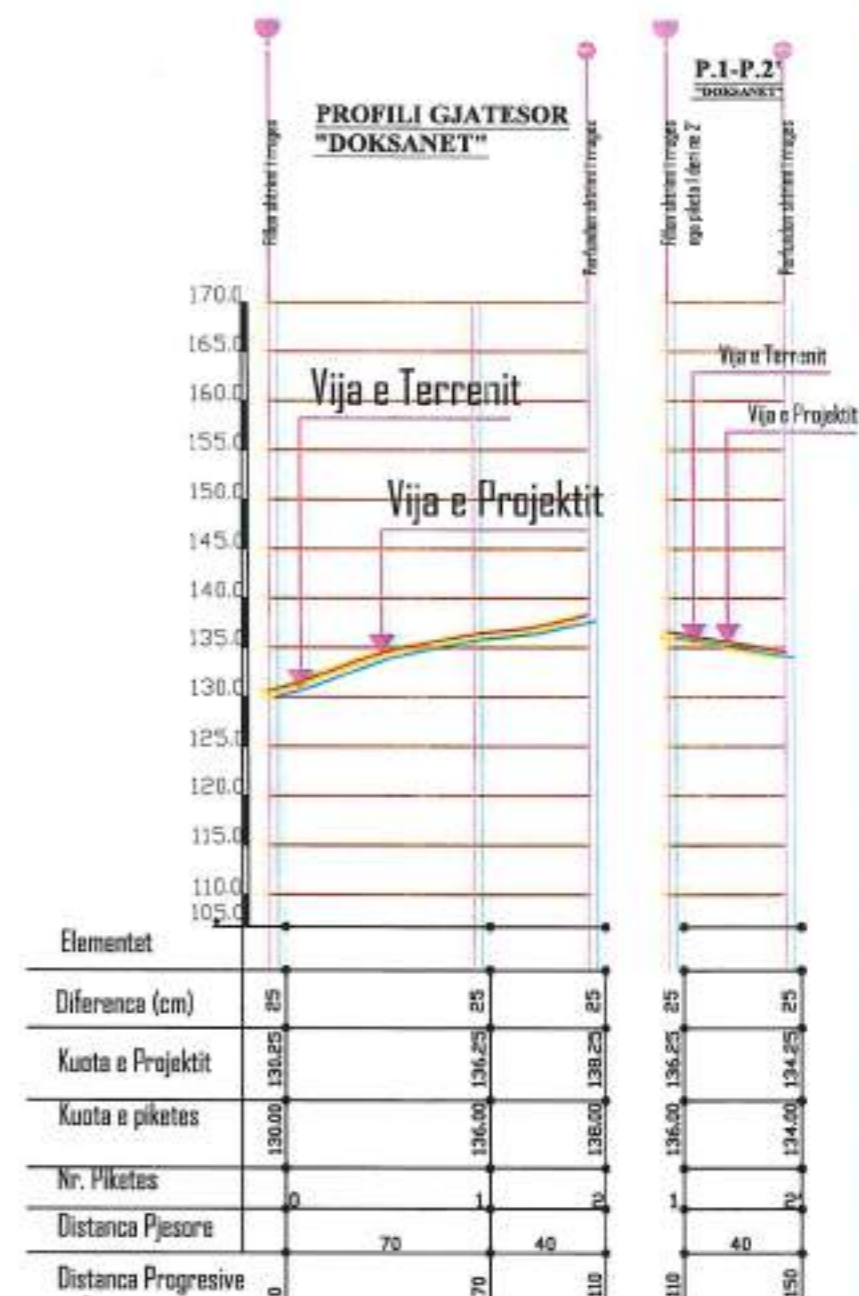

# P.1-P.2 "DOKSANET"

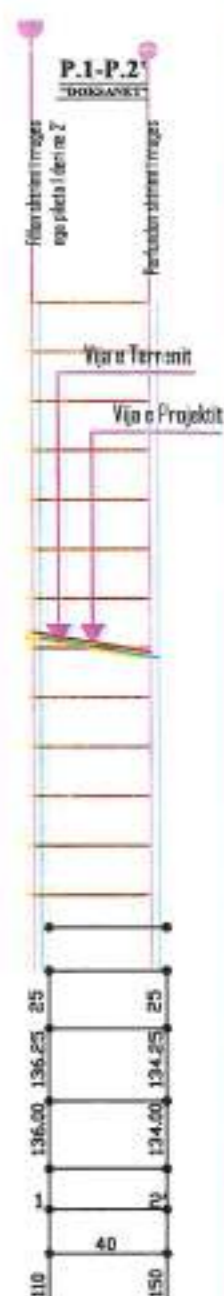

Ministria e Transportit dhe Infrastruktura  
 Bashkia e Durrës  
 Mincato  
 Kryetari

Projekt:  
 RINDOZIMI I RRUGËVE TË RINDOZSHMËNE  
 NAGJET E BASHKISË DOKSANET

Grupi i Projektimit:  
 Inxh. Erion Hoxha  
 Inxh. Ardit Mulla  
 Inxh. Edhisoni (Kryetar)

Udhëzuesi i Projektit:  
 Enxhida Hoxha

Titulli i Fiutë:  
 PROFILI GJATESOR I RRUGËS

Datë:  
 05/10/2023

Fila Nr. 05

## PROFILI TIP RRUGA "BUZALLARET"

### P.0-P.3

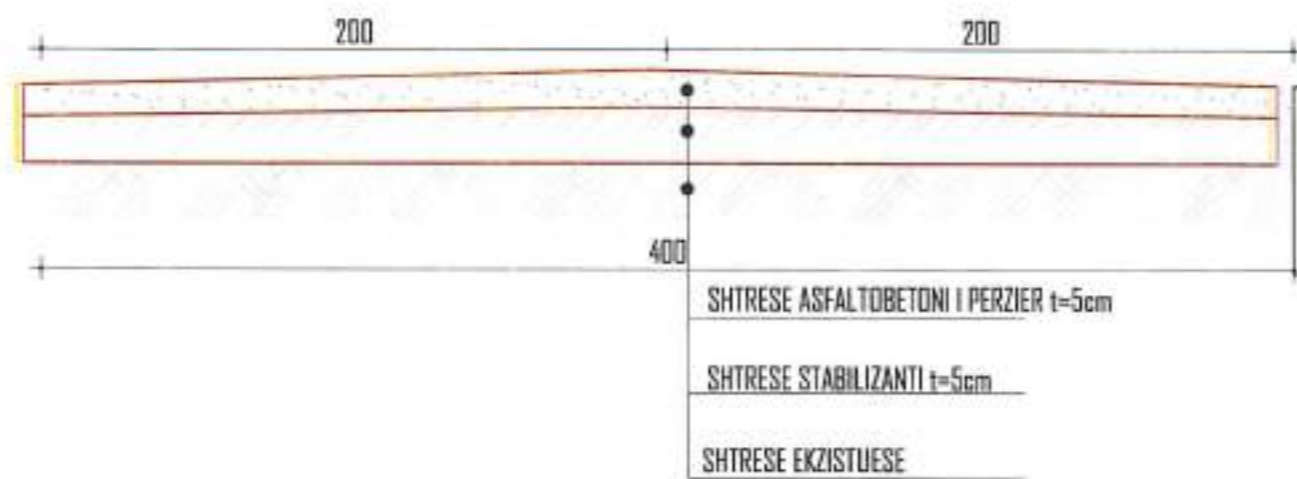

## PRERJA E MURIT

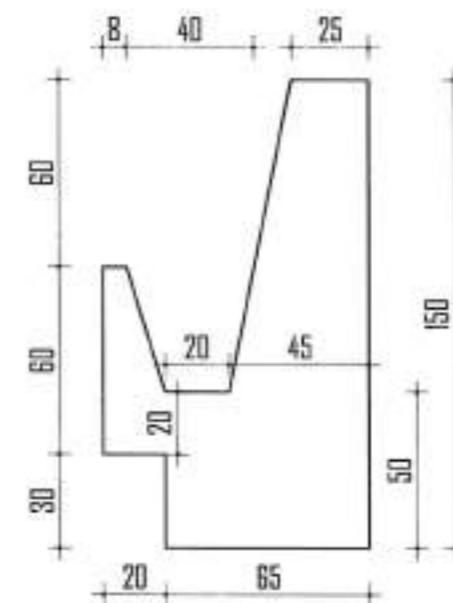

MUR BETONI 380ml, V=0.770m<sup>3</sup>/ML 380\*0.770=290m<sup>3</sup>

## PROFILI TIP RRUGA "BUZALLARET"

### P.3-P.4

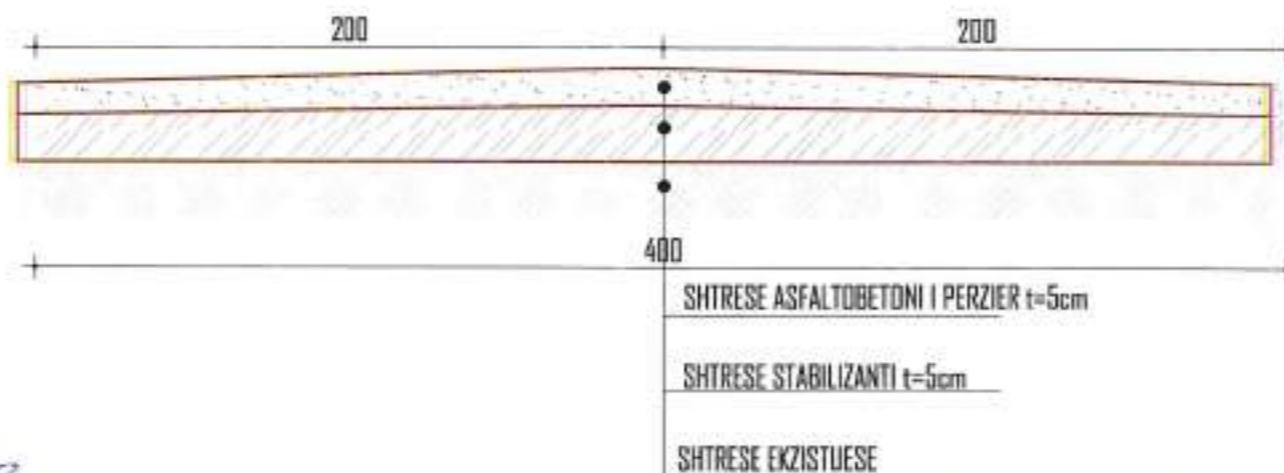

Ministria e Punëve  
Publike dhe Transportit  
Ministria e Energjitikës  
dhe Nivellimit

Projekt:

REKONSTRUKTIVIMI I RRUGËS PËR BIRNËDISHMARRËNE  
DHE NIVELIMI I RRUGËS PËR BIRNËDISHMARRËNE

Grupi i Përgjegjësimit:

Grupi i Përgjegjësimit  
Grupi i Përgjegjësimit  
Grupi i Përgjegjësimit  
Grupi i Përgjegjësimit

Udhëzuesi i Projektit:

Udhëzuesi i Projektit  
Udhëzuesi i Projektit

Titulli i Titullit:

PROFILI TIP RRUGËS

Titulli i Titullit  
Titulli i Titullit

11/15/2022/00223

Titulli i Titullit

06



PROFILAT TERTHORE  
 Profili Nr.0  
 Progresivi 0.00 m  
 K.Tokes 132.00 m  
 K.Projektit 132.25 m  
 Germim= 0.64 m3/m  
 Mbushje= 1.3 m3/m

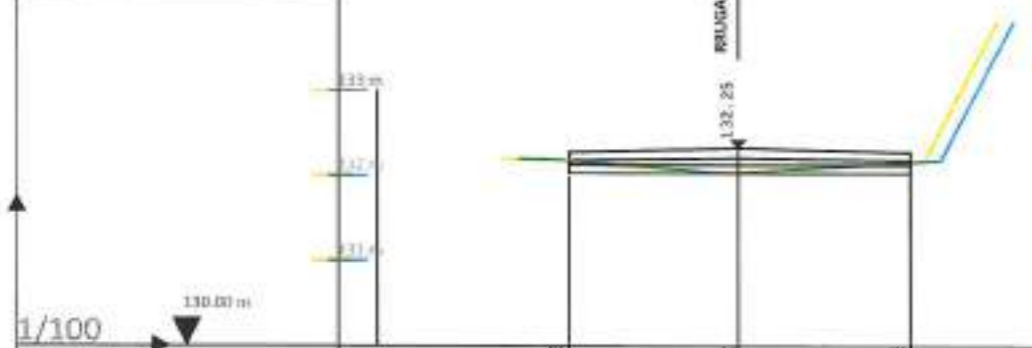

KUOTA E TOKES	132.00	132.00	132.00
D.PJESORE TOKES	2.00	2.00	2.00
KUOTA PROJEKTIT	132.25	132.25	132.25
D.PJESORE PROJEKTIT	2.00	2.00	2.00

PROFILAT TERTHORE  
 Profili Nr.1  
 Progresivi 140.00 m  
 K.Tokes 137.00 m  
 K.Projektit 137.25 m  
 Germim= 0.64 m3/m  
 Mbushje= 1.3 m3/m

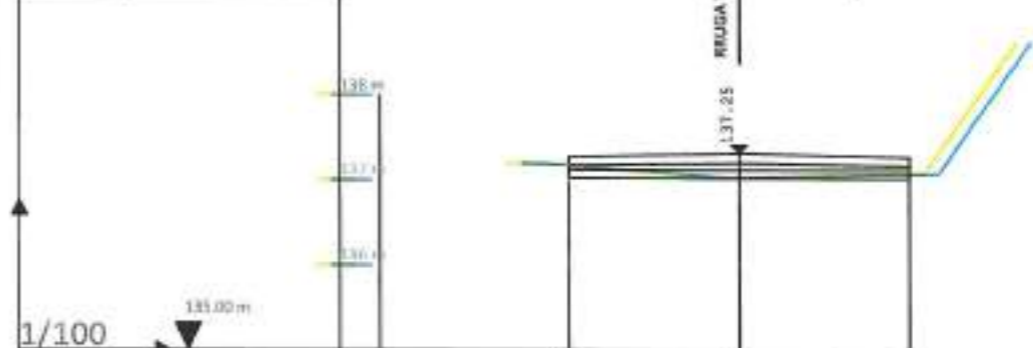

KUOTA E TOKES	137.00	137.00	137.00
D.PJESORE TOKES	2.00	2.00	2.00
KUOTA PROJEKTIT	137.25	137.25	137.25
D.PJESORE PROJEKTIT	2.00	2.00	2.00

PROFILAT TERTHORE  
 Profili Nr.2  
 Progresivi 310.00 m  
 K.Tokes 124.00 m  
 K.Projektit 124.25 m  
 Germim= 0.64 m3/m  
 Mbushje= 1.3 m3/m

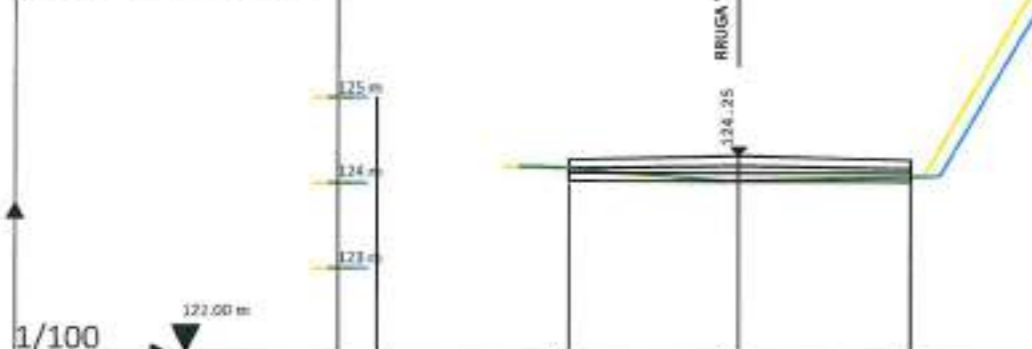

KUOTA E TOKES	124.00	124.00	124.00
D.PJESORE TOKES	2.00	2.00	2.00
KUOTA PROJEKTIT	124.25	124.25	124.25
D.PJESORE PROJEKTIT	2.00	2.00	2.00



Projetti i  
 Rruges  
 M. K. K. K.  
 M. K. K. K.

Projekti:  
 RRETTUESIA E RRUGES  
 DHE REKONSTRUKCIONI  
 I RRUGES

Grupi i Projektit:  
 Inxhinjeri i Tokes  
 Inxhinjeri i Projektit  
 Inxhinjeri i Rruges

Udhetar:  
 Inxhinjeri i Tokes

Titulli i Titullit:  
 PROFILAT TERTHORE E RRUGES

Date: 06/10/2023  
 Shtetli:

Filote: 03/11/2023

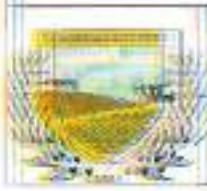
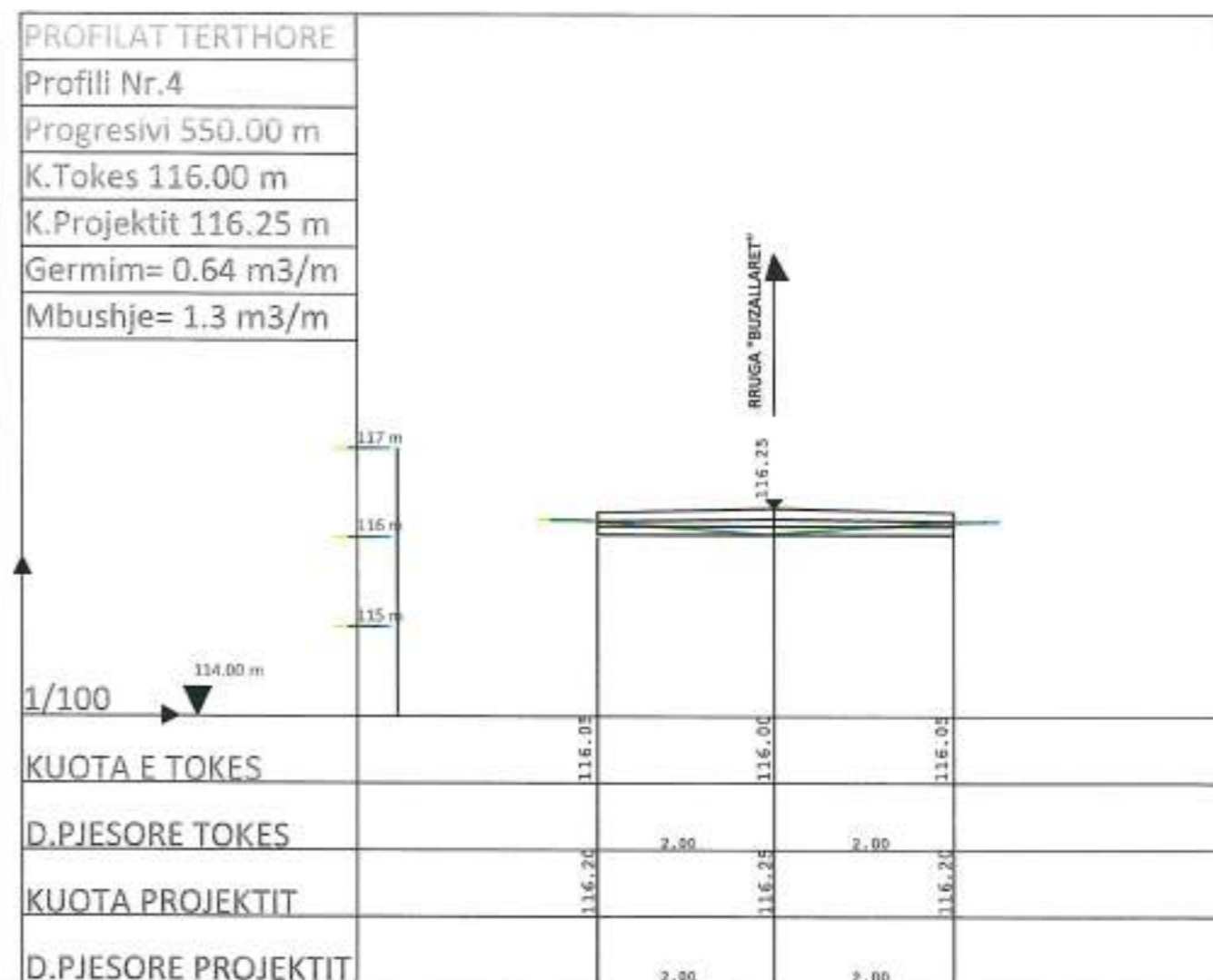
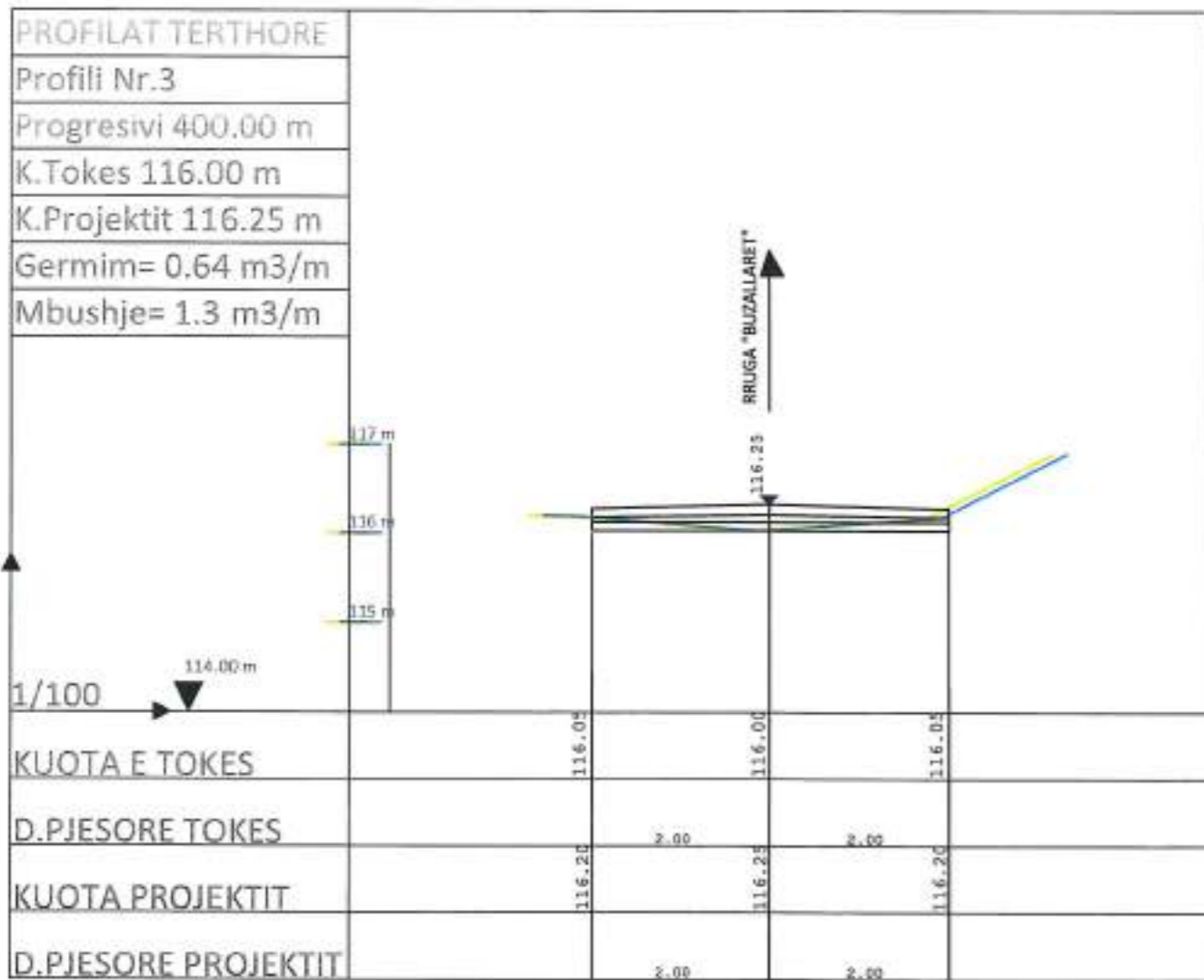

Emri i Emrit  
 Emri i Emrit  
 Emri i Emrit

Projekt:  
 RREZHA E RRUGORË DHE RRUGËSHARRË  
 LANGJET E BASHKËSIË RRONDE

Grupi i Projektimit:  
 Emri i Emrit  
 Emri i Emrit  
 Emri i Emrit

Grupi i Projektimit:  
 Emri i Emrit  
 Emri i Emrit

Titulli i Titullit:  
 PROFILI TERTHORE I RRUGËS

Emri i Emrit  
 Emri i Emrit  
 Emri i Emrit

Emri i Emrit  
 Emri i Emrit





PROFILAT TERTHORE  
 Profili Nr.0  
 Progresivi 0.00 m  
 K.Tokes 130.00 m  
 K.Projektit 130.25 m  
 Germim= 0.64 m3/m  
 Mbushje= 1.3 m3/m

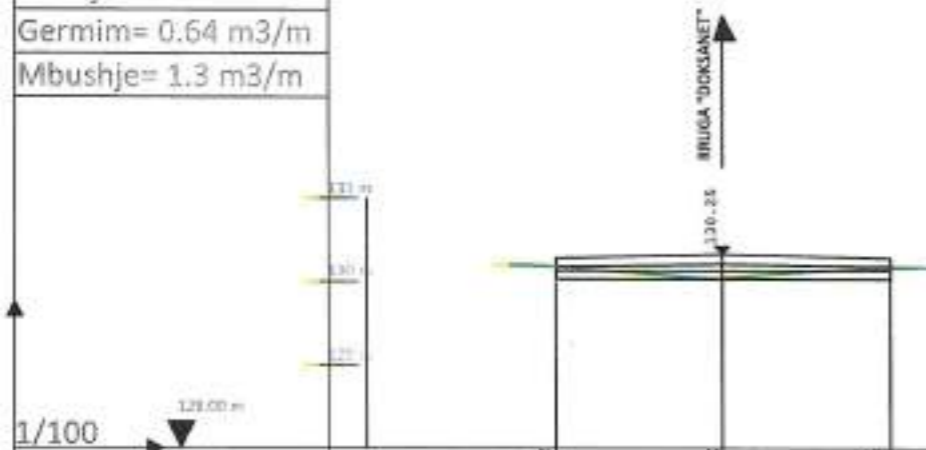

KUOTA E TOKES

D.PJESORE TOKES

KUOTA PROJEKTIT

D.PJESORE PROJEKTIT

130.00	130.00	130.05
2.00	2.00	2.00
130.25	130.25	130.25
2.00	2.00	2.00

PROFILAT TERTHORE  
 Profili Nr.1  
 Progresivi 70.00 m  
 K.Tokes 136.00 m  
 K.Projektit 136.25 m  
 Germim= 0.64 m3/m  
 Mbushje= 1.3 m3/m

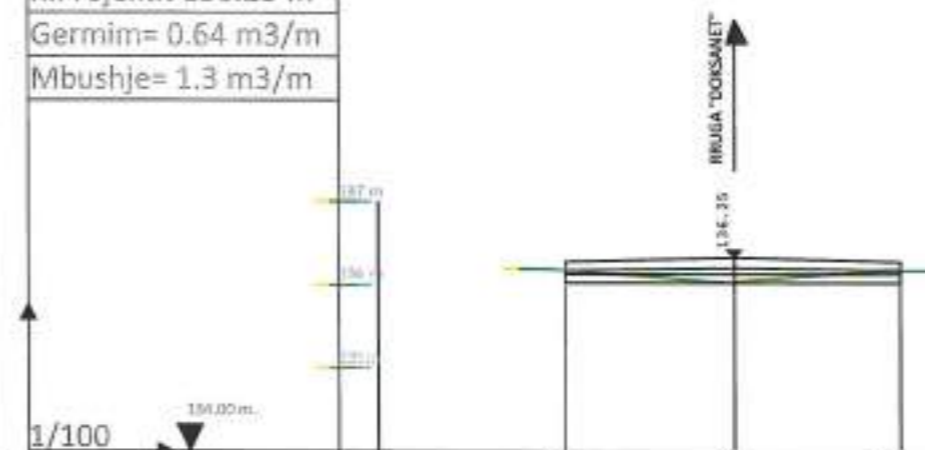

KUOTA E TOKES

D.PJESORE TOKES

KUOTA PROJEKTIT

D.PJESORE PROJEKTIT

136.00	136.00	136.05
2.00	2.00	2.00
136.25	136.25	136.25
2.00	2.00	2.00

PROFILAT TERTHORE  
 Profili Nr.2  
 Progresivi 110.00 m  
 K.Tokes 138.00 m  
 K.Projektit 138.25 m  
 Germim= 0.64 m3/m  
 Mbushje= 1.3 m3/m

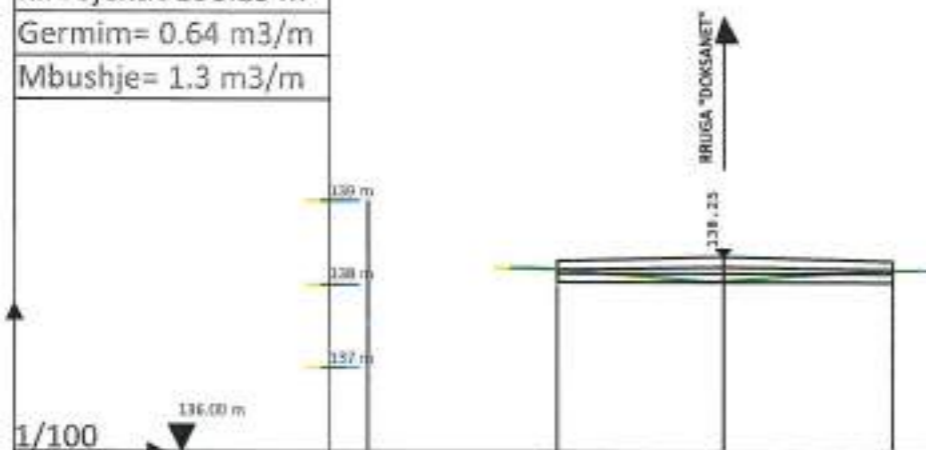

KUOTA E TOKES

D.PJESORE TOKES

KUOTA PROJEKTIT

D.PJESORE PROJEKTIT

138.00	138.00	138.05
2.00	2.00	2.00
138.25	138.25	138.25
2.00	2.00	2.00

PROFILAT TERTHORE  
 Profili Nr.2'  
 Progresivi 150.00 m  
 K.Tokes 134.00 m  
 K.Projektit 134.25 m  
 Germim= 0.64 m3/m  
 Mbushje= 1.3 m3/m

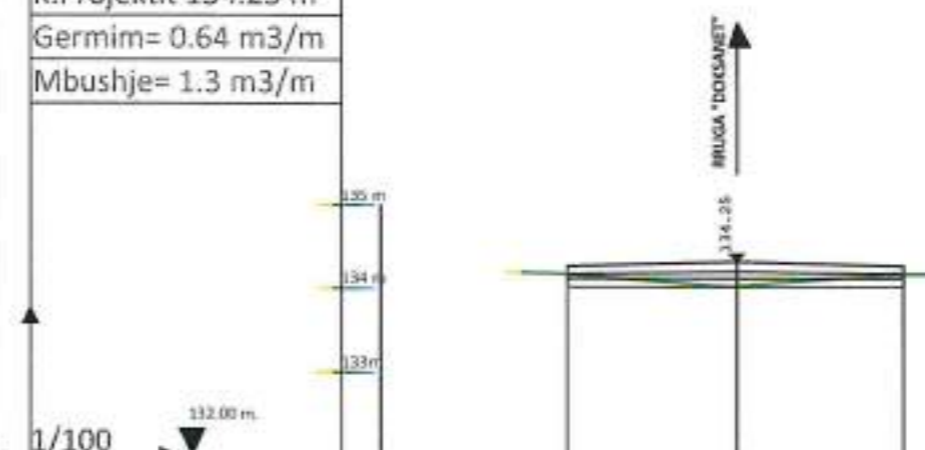

KUOTA E TOKES

D.PJESORE TOKES

KUOTA PROJEKTIT

D.PJESORE PROJEKTIT

134.00	134.00	134.05
2.00	2.00	2.00
134.25	134.25	134.25
2.00	2.00	2.00



Ministria e Transportit dhe Infrastruktura  
 DREKTORATI QENDRORE I VEPRIMEVE  
 SHKALLËZIMESH  
 DREKTOR: [Signature]

Projekt:  
 [Signature]

Grupi i Projektimit:  
 [Signature]

Grupi i Dizajnit:  
 [Signature]

Titulli i detyrës:  
 PROFILAT TERTHORE E VEPRIMEVE

Detyra:  
 Shtetlika

105102/0023

10



Republika e Kosovës

# OBJEKTE ASFALTIMI I RRUGËVE TË BRENDËSHME NË LAGJET E BASHKISË ROSKOVEC (RRUGA DORTAJ)

	Prokurorja e Përgjithshme Bashkia e Roskovec Komuna e Roskovec	Projekt: ASFALTIMI I RRUGËVE TË BRENDESMANIE NË LAGJET E BASHKISË ROSKOVEC	Grupi i Përgjithshëm: Komiteti i Përbashkët Komiteti i Përbashkët Komiteti i Përbashkët	Komiteti i Përbashkët Komiteti i Përbashkët	Titull i fletës: (KOPAKU)	Dato: Shtetbërës	(15/02/2023)	Titull i fletës: 
--	--	--	--	--	------------------------------	---------------------	--------------	----------------------

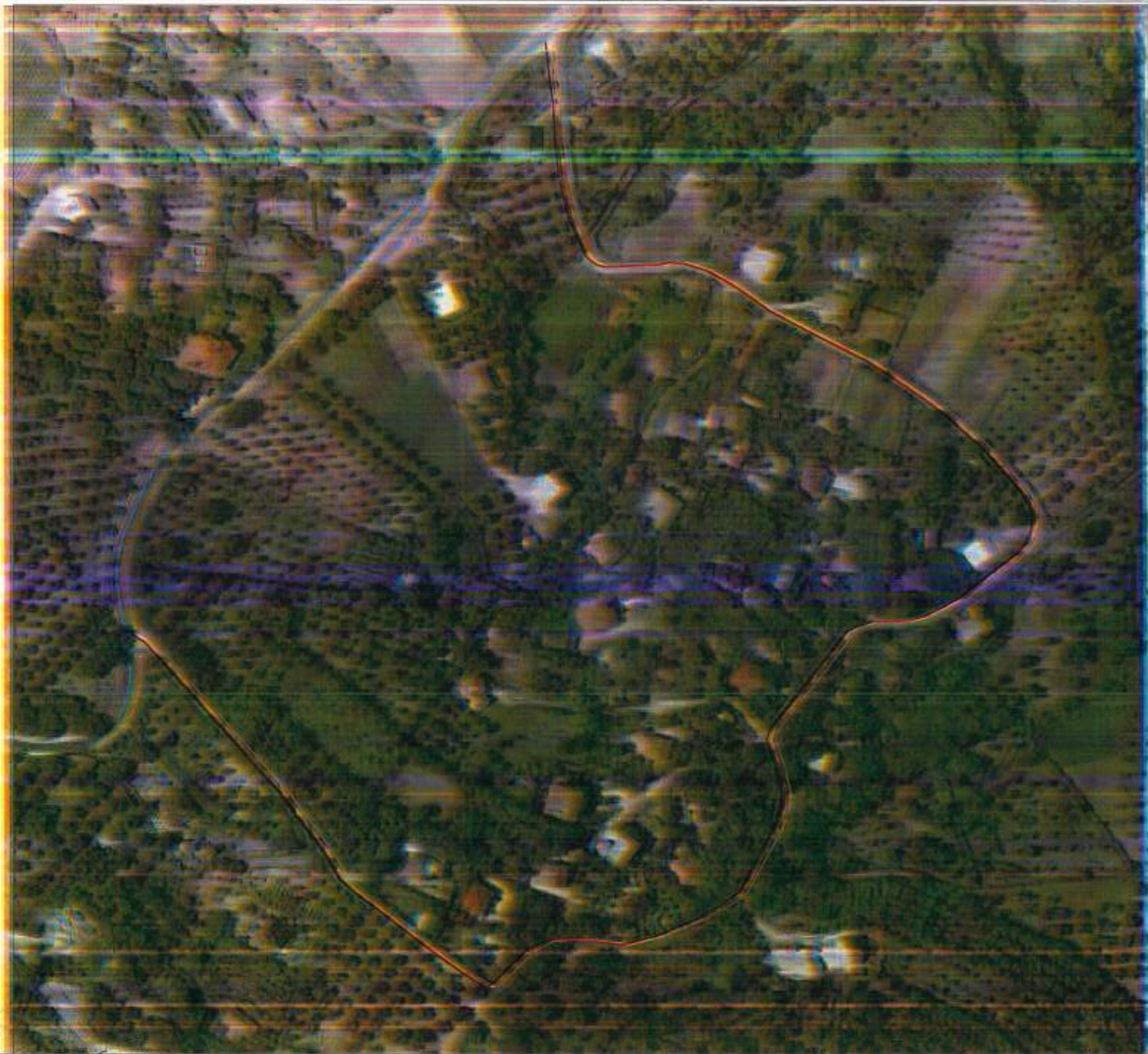

Հանրապետության  
Բնակավայրի Կոնսերվացիայի  
Կենտրոնի  
Պաշտոնատեղի

Մարզիկ :  
ԱՐՄԱՎԻՐԻ ՄԱՐԶԻ ԱՐՄԱՎԻՐԻ ԵՐԵՎԱՆԻ ՄԱՐԶԻ  
ՄԱՐԶԻ ԵՐԱՍՄԱՍԻՍԻ ԵՐԵՎԱՆԻ ԿԱՄԵՏ

Երաժիշտի Մարզկենտրոն :  
Մարզիկի Երաժիշտի  
Մարզիկի Երաժիշտի  
Մարզիկի Երաժիշտի

Երաժիշտի Մարզկենտրոն :  
Երաժիշտի Մարզիկի

Մարզիկի :  
ՀՀ ԿՐԹԱԿՆԵՐԱԿԱՆ ԿՐԹԱԿՆԵՐԱԿԱՆ  
ՄԱՐԶԻ

Երաժիշտի  
Մարզիկի

15.02.2023

Երաժիշտի Մարզիկի

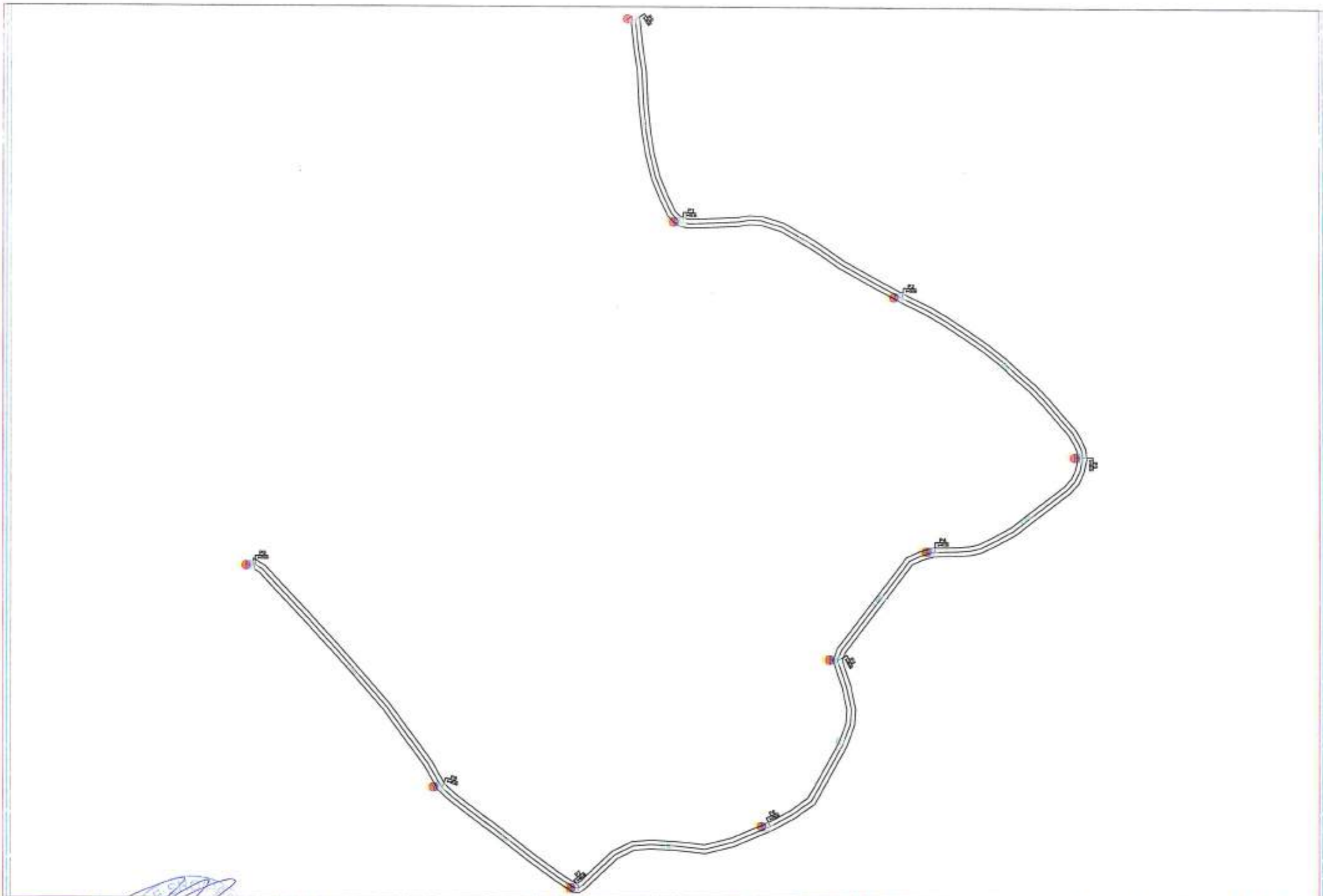

	<p>ՀՀ Մարտիտի Բնակիչ Բաժնետեր Մարտիտ Կոնստրուկտիվ Կառուցման Կենտրոն</p>	<p>Մարտիտի : /ԱՆՏՀԱԼԵՄ ԿՈՆՍՏՐԱԿՏԻՆԻ ԵՒ ԲՆԱԿԻՇՄԱՐԻՏԻ/</p>	<p>Հիմնարկի Մարտիտի : /Կոնստրուկտիվ Կառուցման Կենտրոն/</p>	<p>Մարտիտի : /Կոնստրուկտիվ Կառուցման Կենտրոն/</p>	<p>Մարտիտի : /ՀԱՆՐԱՊԵՏՈՒԹՅԱՆ ԿՈՆՍՏՐԱԿՏԻՎ ԿԱՌԱՐԱԿՈՒՄԻ ՄԱՐՏԻՏԻ/</p>	<p>Մարտիտի : /ՀԱՆՐԱՊԵՏՈՒԹՅԱՆ ԿՈՆՍՏՐԱԿՏԻՎ ԿԱՌԱՐԱԿՈՒՄԻ ՄԱՐՏԻՏԻ/</p>	<p>Մարտիտի : /ՀԱՆՐԱՊԵՏՈՒԹՅԱՆ ԿՈՆՍՏՐԱԿՏԻՎ ԿԱՌԱՐԱԿՈՒՄԻ ՄԱՐՏԻՏԻ/</p>	<p>Մարտիտի : /ՀԱՆՐԱՊԵՏՈՒԹՅԱՆ ԿՈՆՍՏՐԱԿՏԻՎ ԿԱՌԱՐԱԿՈՒՄԻ ՄԱՐՏԻՏԻ/</p>
---	---	--	--	---	---	---	---	---

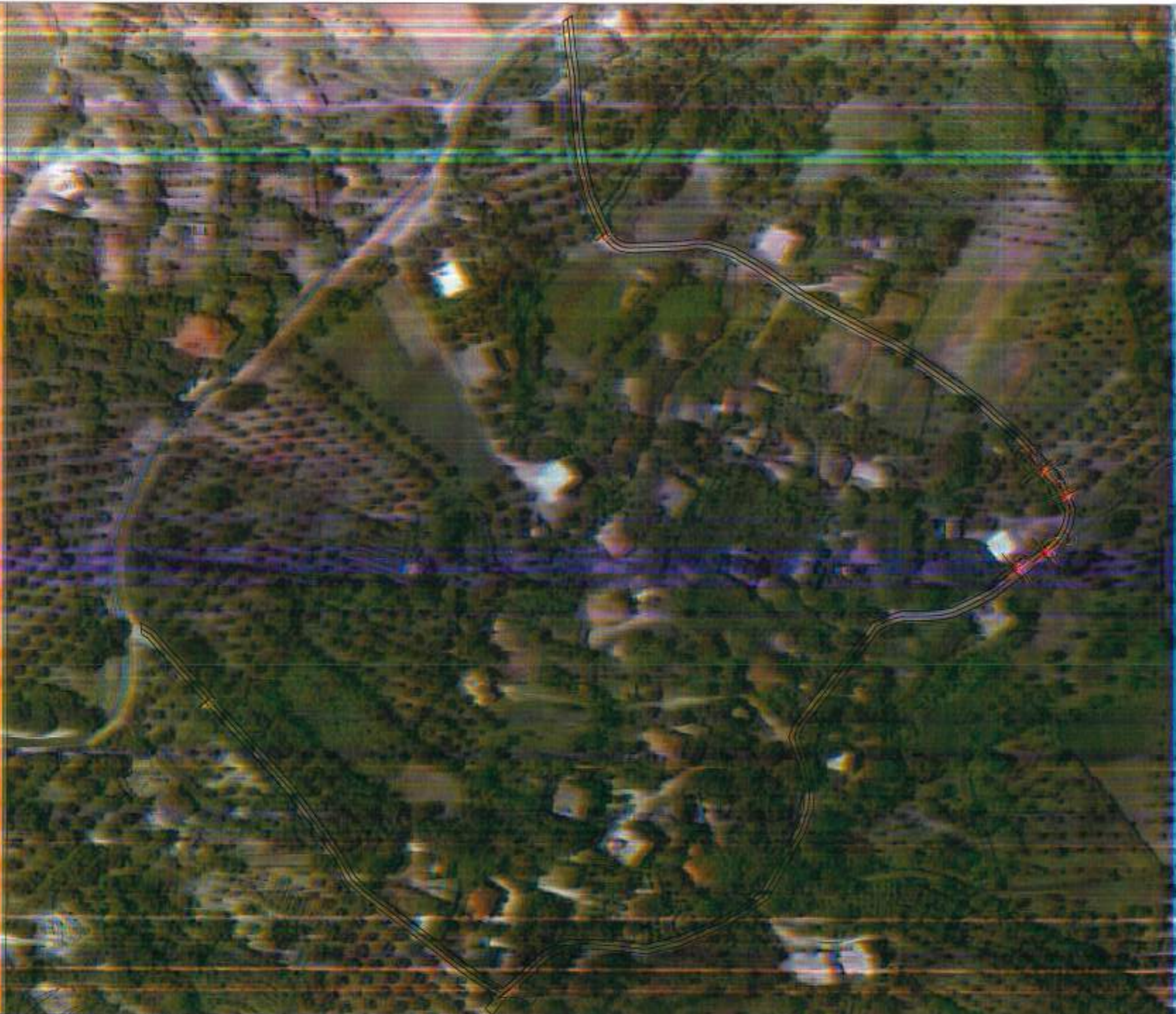

Ministerium für  
Landwirtschaft, Forsten und  
Ruralentwicklung  
Baden-Württemberg

Projekt:  
ANSAULTMIRRIEGWEI Æ BRUNDESMAIENE  
LANGBET Æ WISWIKS Æ RUDOLMEE

Geoppl. Projektterrit.:  
Folgg: Æ Interim Æ Beobachtung  
Folgg: Æ General Æ Beobachtung  
Folgg: Æ Beobachtung Æ (Kommune)

Bezirke: Æ ZZZ Æ  
Einzels: Æ Æ

Titel Æ Æ Æ  
FOLKWWERRVA Æ PERGJITHEISWWE

Beate  
SS Æ Æ Æ

Titel Æ Æ Æ  
03



 	Projekti: <b>ANALIZIMI I RRIETVE TË RRINDESHMEVE          NË VILLIET E PARRANISË E RINDOMIT</b>	Grupi i Projektimit: Inzh. Entel Mekezi Inzh. Evard Mekezi Inzh. Edisson Mekezi	Organizimi: Inzh. Mekezi	Titulli i titrit: <b>PLANIMETRIAL I PËRREGJITSHMË</b>	Data: 06/02/2023	Titulli i autorit: <b>04</b>
	SShtetli					

# PROFILI GJATESOR

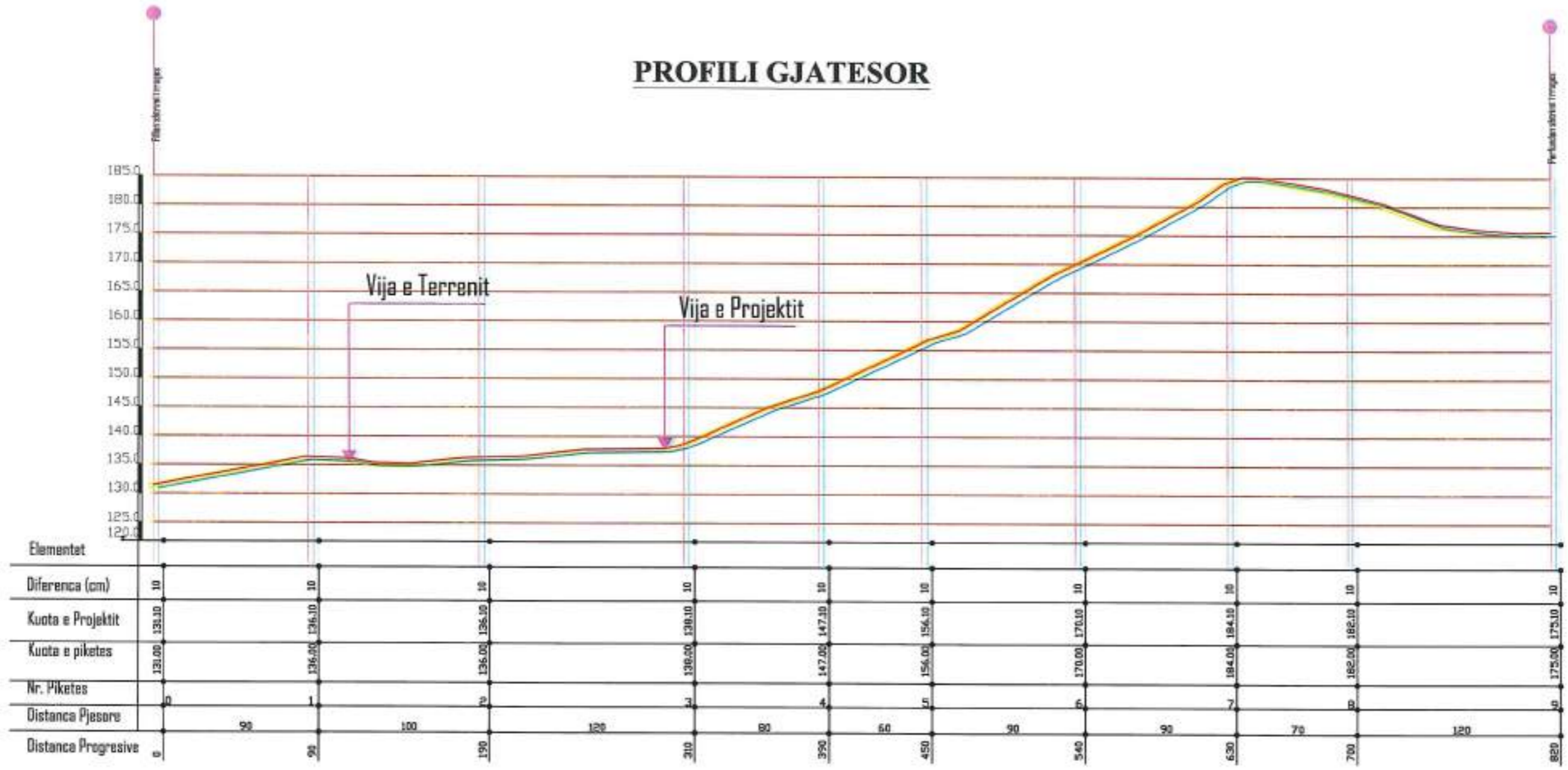

**Ministria e Transportit dhe Infrastruktura**  
 DREKTORATI QENDRORE I VEPRIMEVE  
 SHKALLA E PËRZEMBEJES  
 SHKALLA E PËRZEMBEJES

Projekt: **REKONSTRUKTIONE DHE RINDRUESHME NE**  
**LANGLITTE E BASHKISE RROGICAVE**

Grupi i Projektimit:  
 Inzh. Ferit Hoxha  
 Inzh. Evrel Hoxha  
 Inzh. Eldiseri Krasni

Drejtori i PZSHIT:  
**Ermon Hoxha**

Titulli i fletës:  
**PROFILI GJATESOR I RRUGES**

Dite:  
 Shkalla:

Data: **05.10.2023**

Fletë Nr. **05**

# PROFILI TIP RRUGA "DORTAJ"

## P.0-P.9

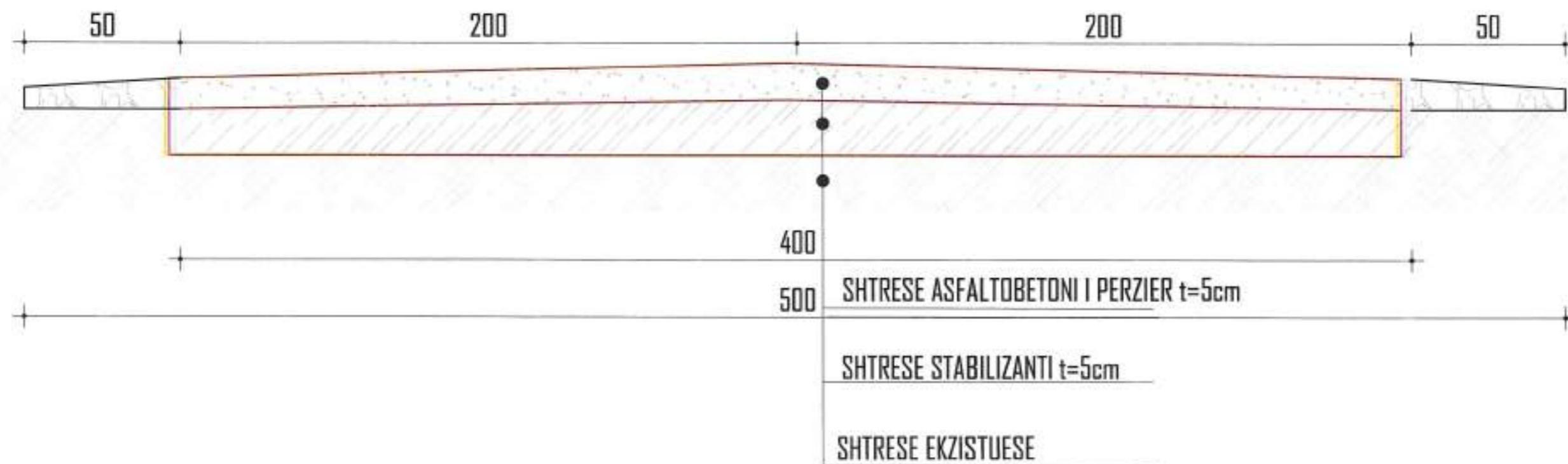

Projekti:  
 RIKONSTRUKTIVIMI I RRUGËVE PËR TËRRIKUNDESI SHKALLËRE  
 NË QYLLIÇE E BARRANË PËR TËRRIKUNDESI SHKALLËRE

Elizbete P. Prizreni  
 Elza Prizreni  
 Elza Prizreni  
 Elza Prizreni

Elza Prizreni  
 Elza Prizreni

Titull i ri:  
 PROFILI TIP RRUGËS

Data: 19/10/2023  
 Shkalla:

Fletë Nr. 06



PROFILAT TERTHORE  
 Profili Nr.0  
 Progresivi 0.00 m  
 K.Tokes 131.00 m  
 K.Projektit 131.25 m  
 Germim= 0.64 m3/m  
 Mbushje= 1.3 m3/m

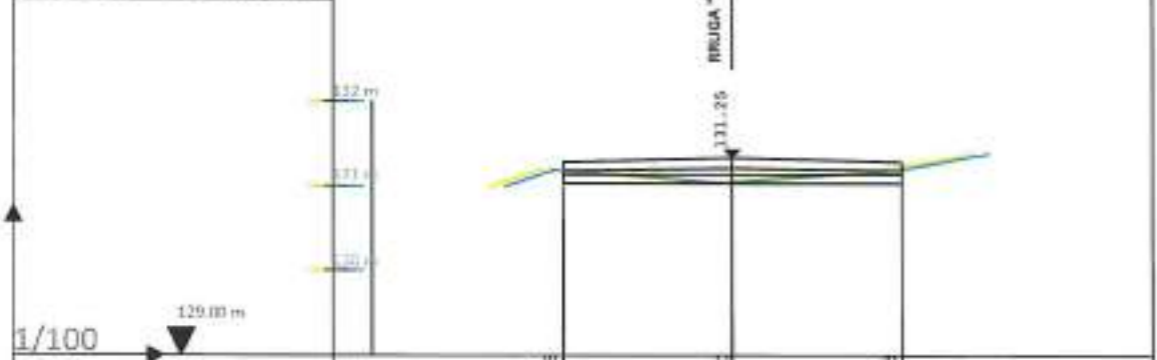

KUOTA E TOKES	131.05	131.00	131.05
D.PJESORE TOKES	131.20	2.80	2.80
KUOTA PROJEKTIT	131.20	131.25	131.20
D.PJESORE PROJEKTIT	2.80	2.00	

PROFILAT TERTHORE  
 Profili Nr.1  
 Progresivi 90.00 m  
 K.Tokes 136.00 m  
 K.Projektit 136.25 m  
 Germim= 0.64 m3/m  
 Mbushje= 1.3 m3/m

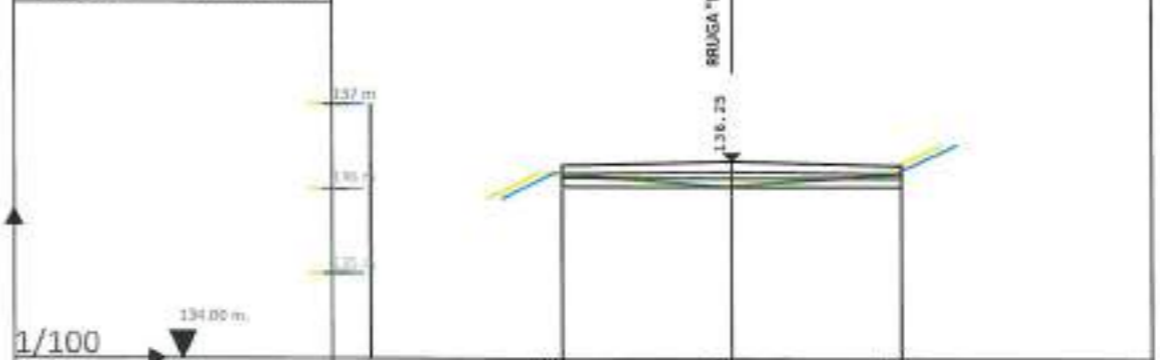

KUOTA E TOKES	136.05	136.00	136.05
D.PJESORE TOKES	136.20	2.80	2.80
KUOTA PROJEKTIT	136.20	136.25	136.20
D.PJESORE PROJEKTIT	2.80	2.80	

PROFILAT TERTHORE  
 Profili Nr.2  
 Progresivi 190.00 m  
 K.Tokes 136.00 m  
 K.Projektit 136.25 m  
 Germim= 0.64 m3/m  
 Mbushje= 1.3 m3/m

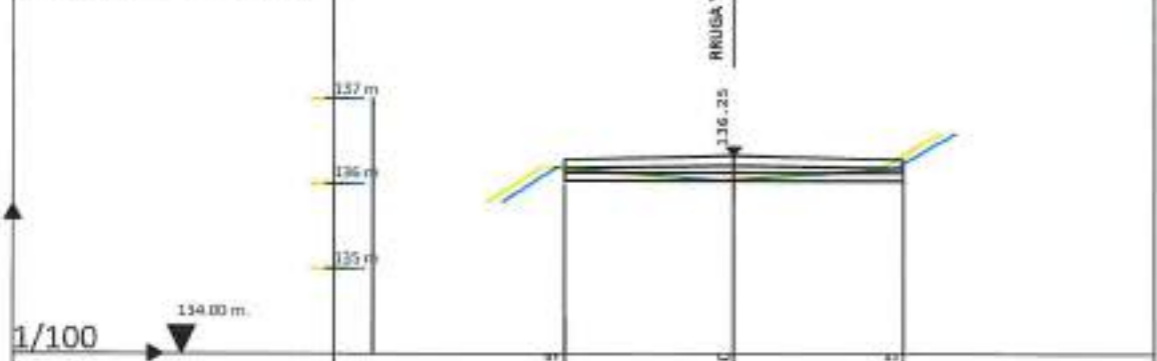

KUOTA E TOKES	136.05	136.00	136.05
D.PJESORE TOKES	136.20	2.80	2.80
KUOTA PROJEKTIT	136.20	136.25	136.20
D.PJESORE PROJEKTIT	2.80	2.80	

PROFILAT TERTHORE  
 Profili Nr.3  
 Progresivi 310.00 m  
 K.Tokes 13.00 m  
 K.Projektit 138.25 m  
 Germim= 0.64 m3/m  
 Mbushje= 1.3 m3/m

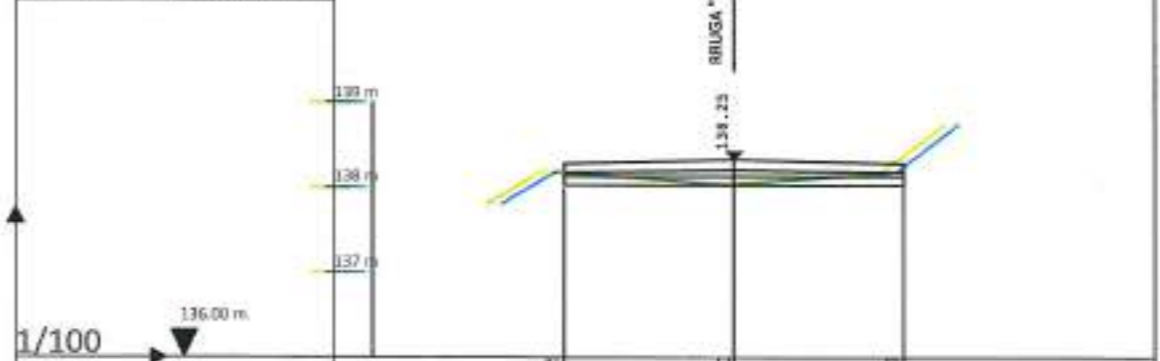

KUOTA E TOKES	138.05	138.00	138.05
D.PJESORE TOKES	138.20	2.80	2.80
KUOTA PROJEKTIT	138.20	138.25	138.20
D.PJESORE PROJEKTIT	2.80	2.80	

PROFILAT TERTHORE  
 Profili Nr.4  
 Progresivi 390.00 m  
 K.Tokes 147.00 m  
 K.Projektit 147.25 m  
 Germim= 0.64 m3/m  
 Mbushje= 1.3 m3/m

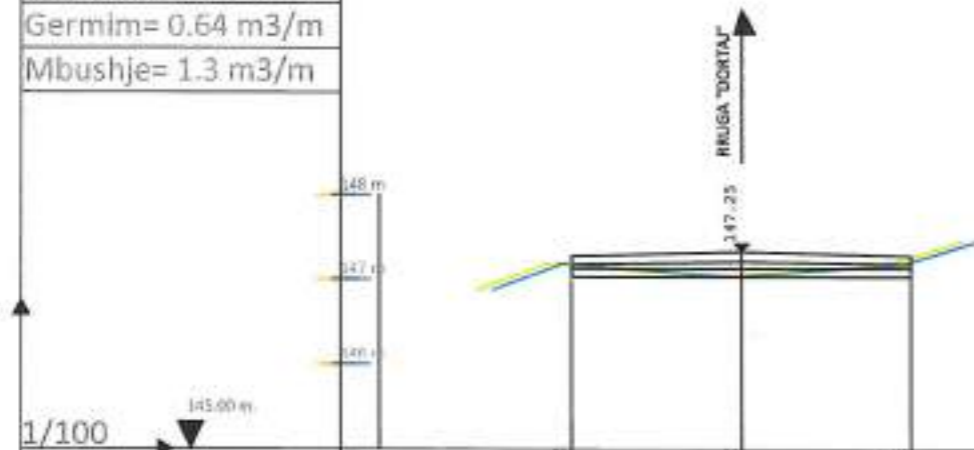

1/100  
 145.00 m

PROFILAT TERTHORE  
 Profili Nr.5  
 Progresivi 450.00 m  
 K.Tokes 156.00 m  
 K.Projektit 156.25 m  
 Germim= 0.64 m3/m  
 Mbushje= 1.3 m3/m

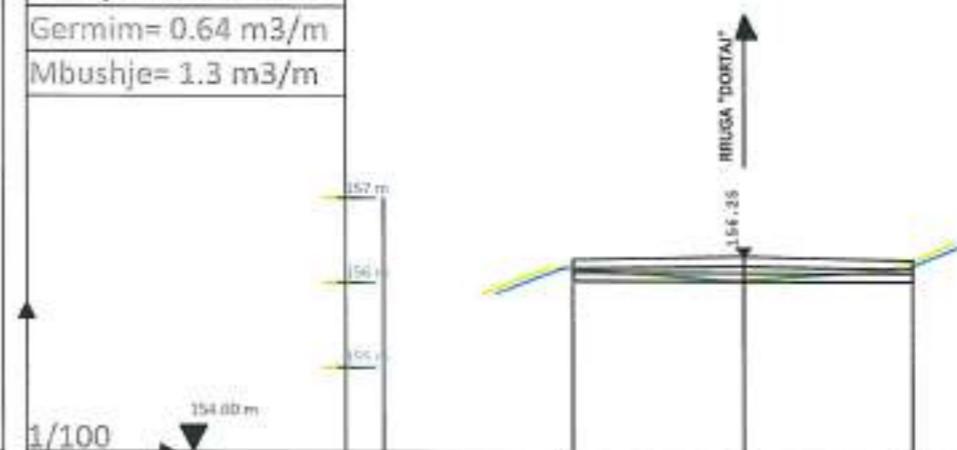

1/100  
 154.00 m

PROFILAT TERTHORE  
 Profili Nr.6  
 Progresivi 540.00 m  
 K.Tokes 170.00 m  
 K.Projektit 170.25 m  
 Germim= 0.64 m3/m  
 Mbushje= 1.3 m3/m

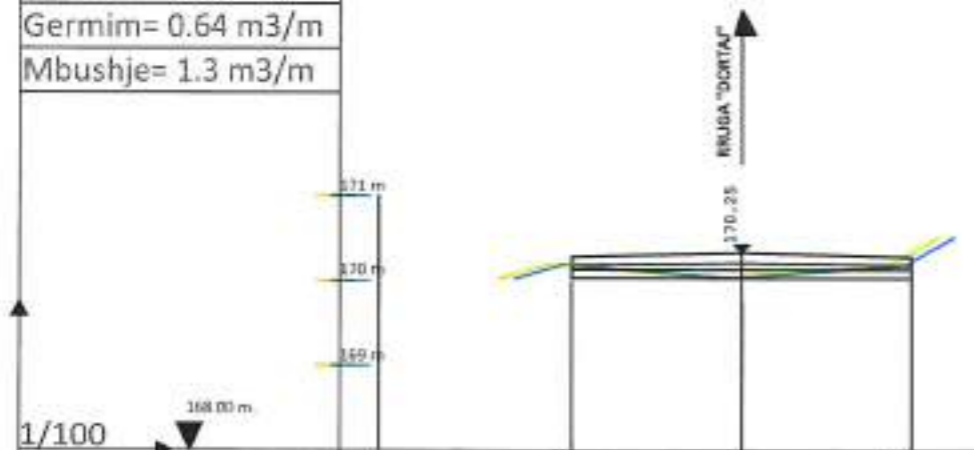

1/100  
 168.00 m

PROFILAT TERTHORE  
 Profili Nr.7  
 Progresivi 630.00 m  
 K.Tokes 184.00 m  
 K.Projektit 184.25 m  
 Germim= 0.64 m3/m  
 Mbushje= 1.3 m3/m

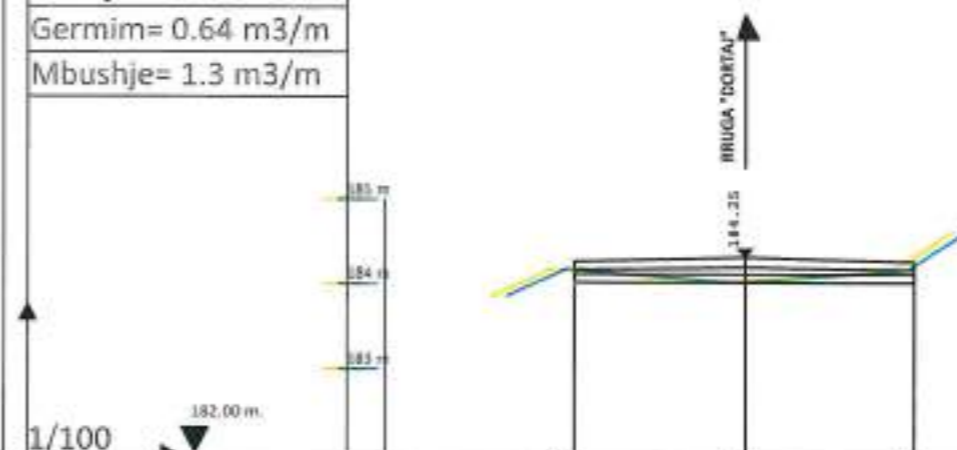

1/100  
 182.00 m



Ministria e Transportit dhe Infrastruktura  
 Detyra e Përgjithshme  
 Ministri  
 Kujdesi i Përgjithshëm

Projekti :  
 RINDRIM I RRUGËVE TË BASHKËSHMËNE  
 NË QYLLIÇE TË BASHKËSHMËNE TË RINDRIMIT

Grupi i Projektit :  
 Inxhinjeri i Rrugëve  
 Inxhinjeri i Nivelimit  
 Inxhinjeri i Kalkulimit

Grupi i Përgjithshëm :  
 Inxhinjeri i Rrugëve  
 Inxhinjeri i Nivelimit

Titulli i detyrës :  
 PROFILI TË RRUGËVE TË RINDRIMIT

Detyra :  
 08/2023

Dati :  
 08/2023

Shifra e detyrës :  
 08

**PROFILAT TERTHORE**

Profili Nr.8

Progresivi 700.00 m

K.Tokes 182.00 m

K.Projektit 182.25 m

Germim= 0.64 m<sup>3</sup>/m

Mbushje= 1.3 m<sup>3</sup>/m

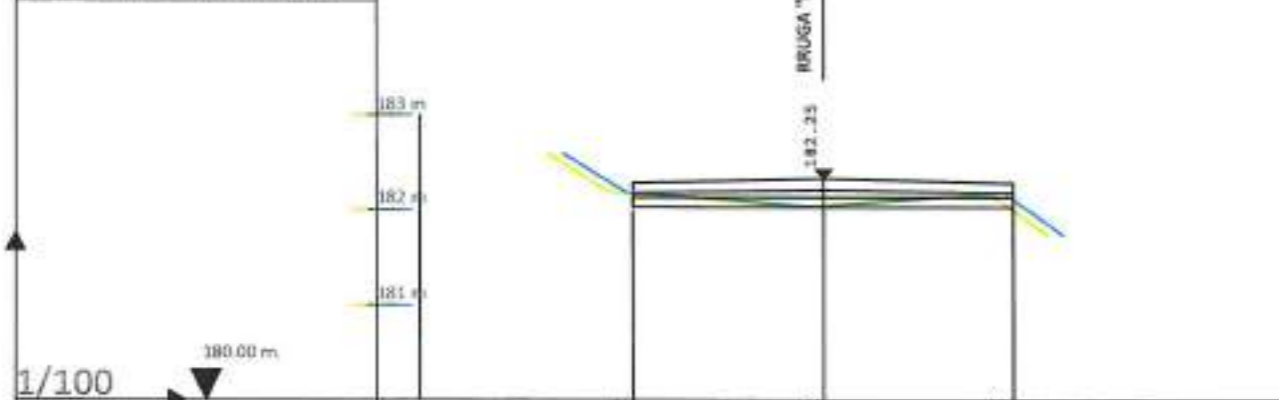

KUOTA E TOKES

D.PJESORE TOKES

KUOTA PROJEKTIT

D.PJESORE PROJEKTIT

182.00	182.00	182.05
2.00	2.00	
182.20	182.25	182.20
2.00	2.00	

**PROFILAT TERTHORE**

Profili Nr.9

Progresivi 820.00 m

K.Tokes 175.00 m

K.Projektit 175.25 m

Germim= 0.64 m<sup>3</sup>/m

Mbushje= 1.3 m<sup>3</sup>/m

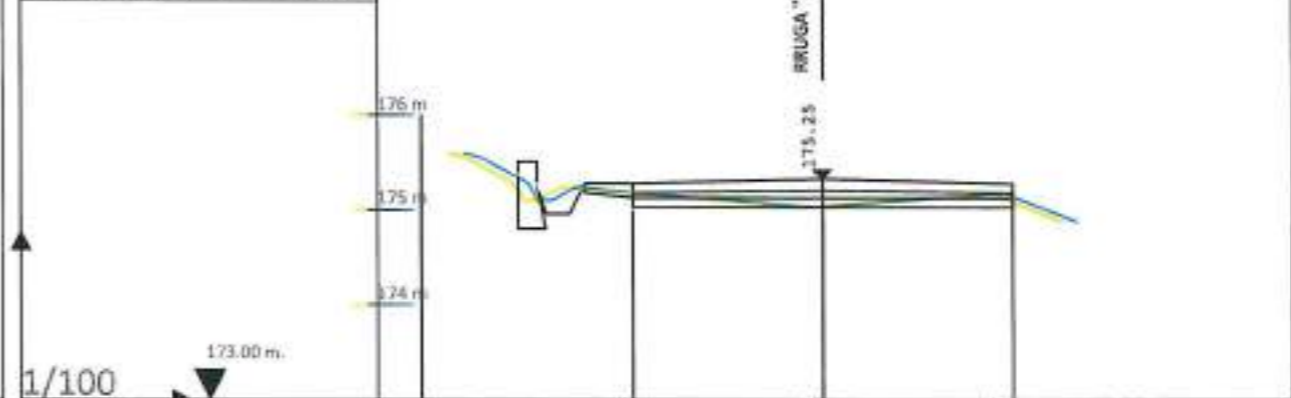

KUOTA E TOKES

D.PJESORE TOKES

KUOTA PROJEKTIT

D.PJESORE PROJEKTIT

175.00	175.00	175.05
2.00	2.00	
175.20	175.25	175.20
2.00	2.00	



Projekti:  
**ASOCIATI I RRUGËVE TË BRITANISMAJERË**  
**IAKUMIT TË BARRAZHËS TË PËRSHKËMBËT**

Grupi i Projektonimit:  
 Inxh. Zhanë Hoxha  
 Inxh. Kresha  
 Inxh. Edona Hoxha

Grupi i Përzgjedhjes:  
 Inxh. Edona Hoxha

Titulli i fletës:  
**PROFILAT TERTHORE TË RRUGËS**

Tërësi: 105/02/2023  
 Shtetësi:



Bashkia e Roskovec

# OBJEKTE: ASFALTIM I RRUGËVE TË BRENDËSHME NË LAGJET E BASHKISË ROSKOVEC (RRUGA CJEPEVE)



Pranuesit  
Bashkia e Roskovec  
Ministria e Punëve  
Publike dhe Transportit



Projekti:

ASFALTIM I RRUGËVE TË BRENDËSHME NË  
LAGJET E BASHKISË ROSKOVEC

Grupi i Projektimit:

Ministria e Punëve  
Publike dhe Transportit  
Ministria e Punëve  
Publike dhe Transportit

*(Handwritten signatures)*

Organizimi i Punëve:

Bashkia e Roskovec

*(Handwritten signature)*

Titulli i Kartës:

PROJEKTI

Libri

15/10/2023

Shënimet

Fletë 43/4r



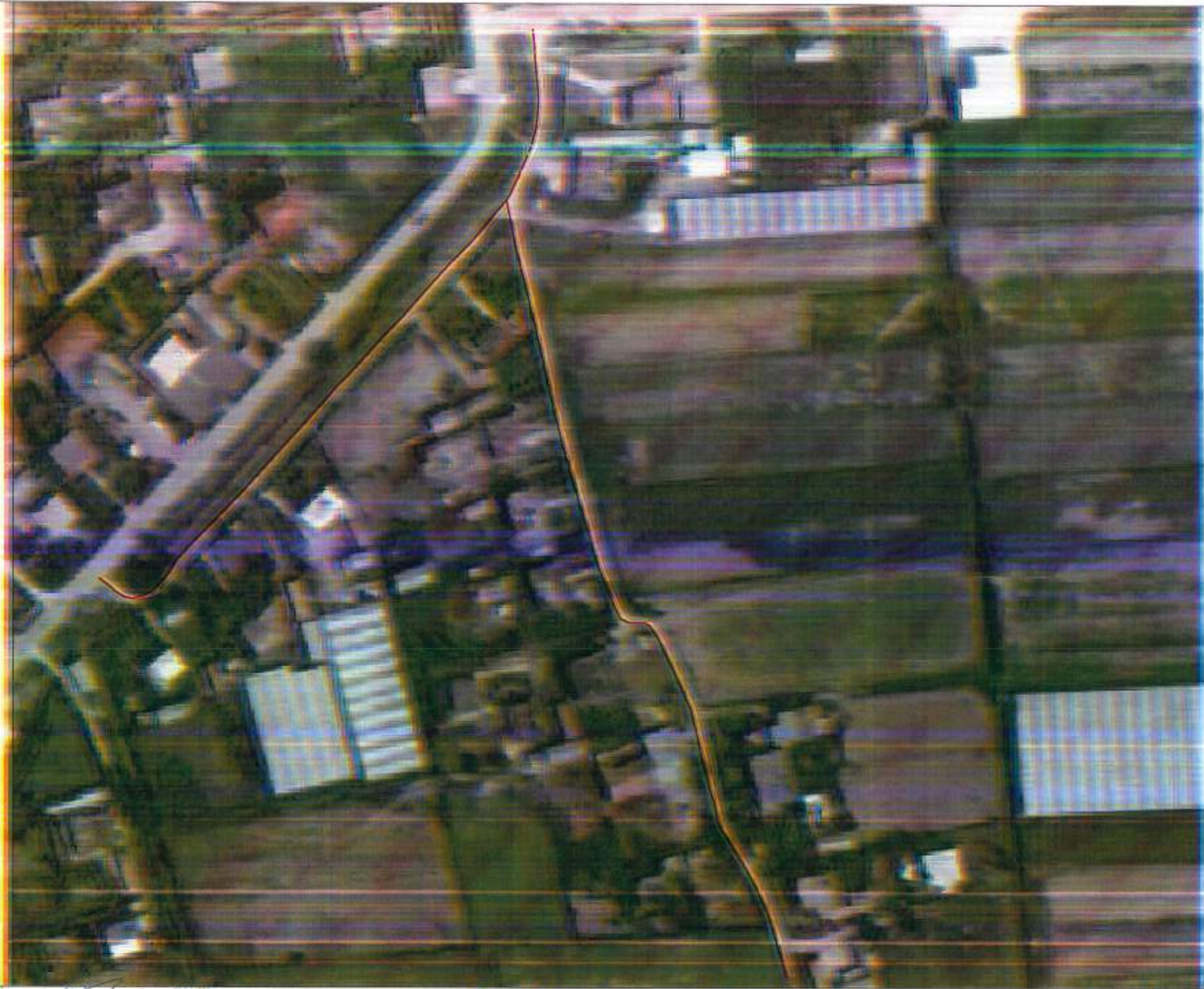

Հանրային Կառավարման  
Կենտրոն  
ՀԱՅԱՍՏԱՆԻ ՀԱՆՐԱՊԵՏՈՒԹՅԱՆ  
ԿԱՌԱՎԱՐՄԱՆ ԿԵՆՏՐՈՆ

Մարզիկի  
Համայնքի  
ՀԱՄԱՅՆՔԱԿԱՆ ԿԱՌԱՎԱՐՄԱՆ ԿԵՆՏՐՈՆ

Համայնքի ղեկավար  
Կարգապահ  
Կարգապահ

Համայնքի ղեկավար  
Կարգապահ

Տվյալների  
ՀԱՄԱՅՆՔԱԿԱՆ ԿԱՌԱՎԱՐՄԱՆ ԿԵՆՏՐՈՆ

Երևան

09/10/2023

Գրանցում

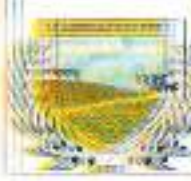
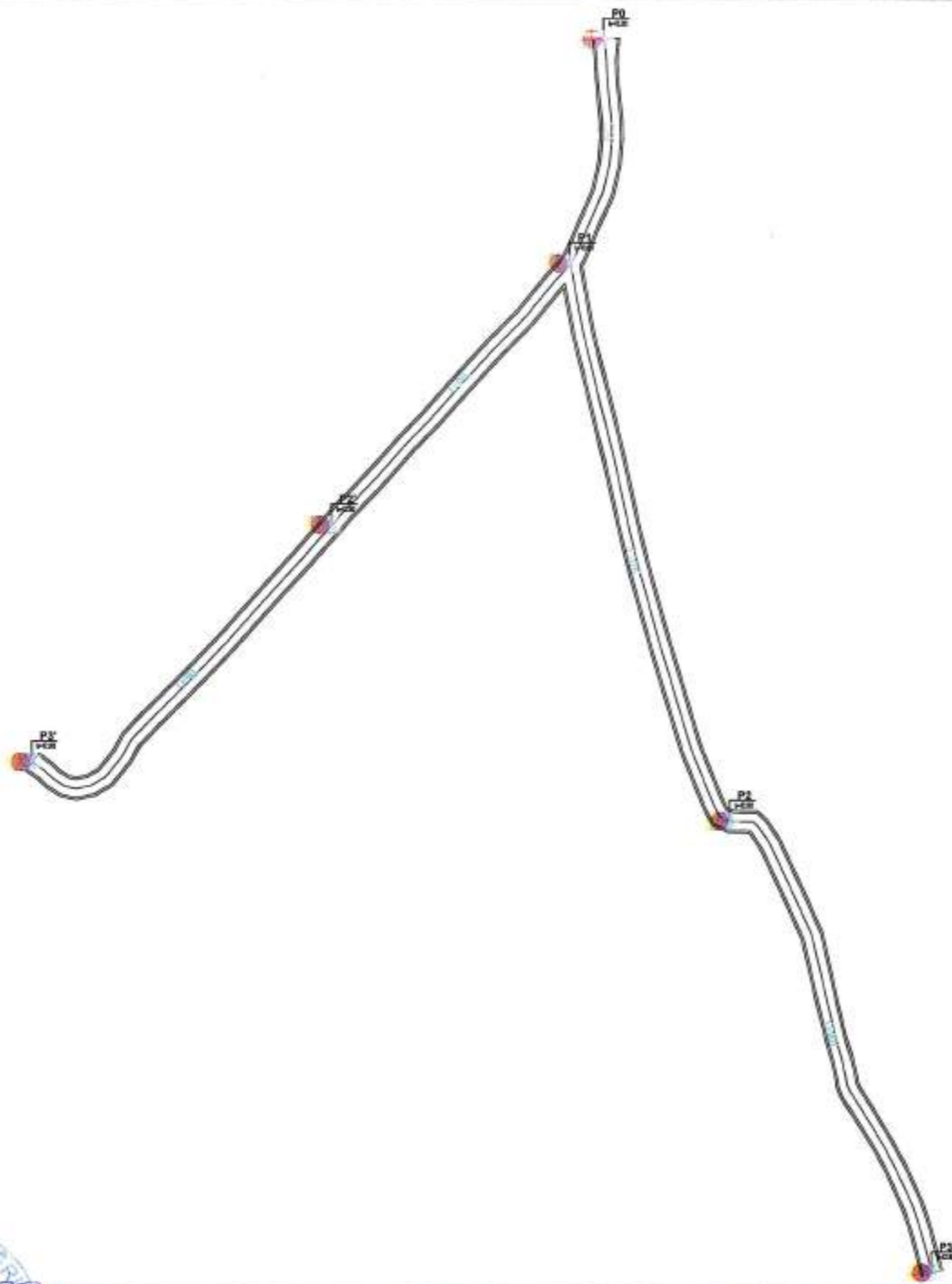

Republika e Shqipërisë  
 Ministria e Transportit dhe Infrastruktura  
 Dytë Detyrues

Projekt: **ANALIZA E NEVESHIMIT DHE BASHKIMET E BASHKIMET**  
**LANDET E BASHKIMIT DHE BASHKIMET**

Grupi i Përgjegjësorit:  
 Inzh. Ferit Hoxha  
 Inzh. Ferit Hoxha  
 Inzh. Ferit Hoxha

Inzh. Ferit Hoxha  
 Inzh. Ferit Hoxha

Titulli i Kështjës:  
**PRANIMI I PLANIT DHE TË PËRMBUES**  
**PRANIMI DHE**

Data:  
 Shtetëria:

05/02/2023

Nr. i Kartës: 02

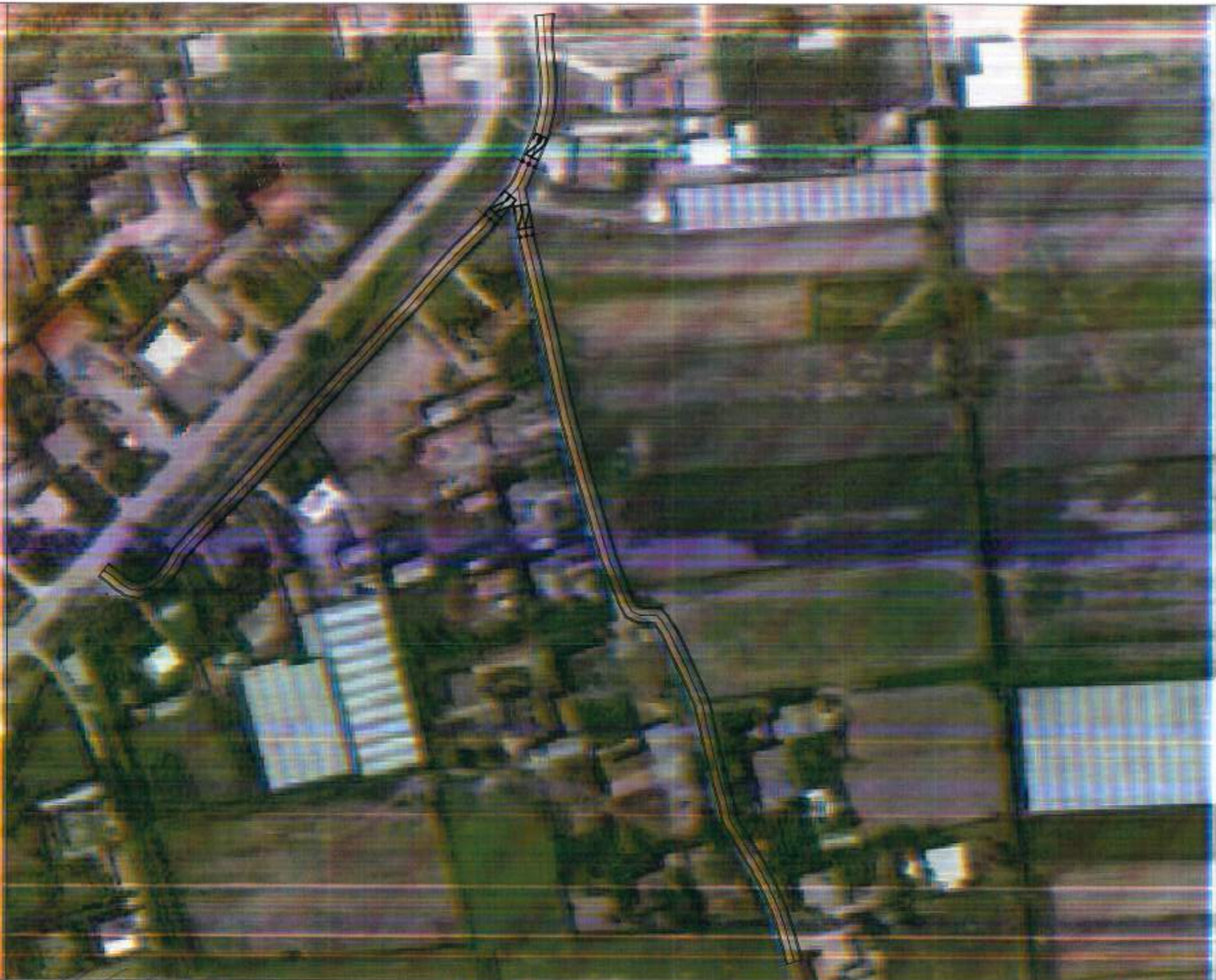

Profession:  
Amtsleiter  
Name: *[Handwritten Name]*

Projekt:  
ANSAUTUM RUDOLPHSBERG  
MILLET ERWISSEN

Gruppe / Projekt:  
*[Handwritten Signature]*

Objekt:  
*[Handwritten Signature]*

Titel:  
ANSAUTUM RUDOLPHSBERG

Blatt:  
SS 1/1

Datum: 10/22/2023

Blatt: 03



Ministerstwo  
 Transportu i  
 Infrastruktury  
 ul. Rakowiecka 17/19  
 00-811 Warszawa

Projekt:  
 WYKONANIE PRAC PROJEKTOWYCH  
 W ZAKRESIE PRAC PROJEKTOWYCH  
 W ZAKRESIE PRAC PROJEKTOWYCH

Etap: PRAC PROJEKTOWYCH  
 Nazwa: *[Handwritten]*  
 Adres: *[Handwritten]*  
 Inwestor: *[Handwritten]*

Nazwa: *[Handwritten]*  
 Adres: *[Handwritten]*

Tytuł: *[Handwritten]*  
 Nazwa: *[Handwritten]*

Data:  
 Skala:

05.10.2023

Kolor: 04





# PROFILI TIP RRUGA E "CJEPEVE"

## P.0-P.3 DHE P.1-P.3'

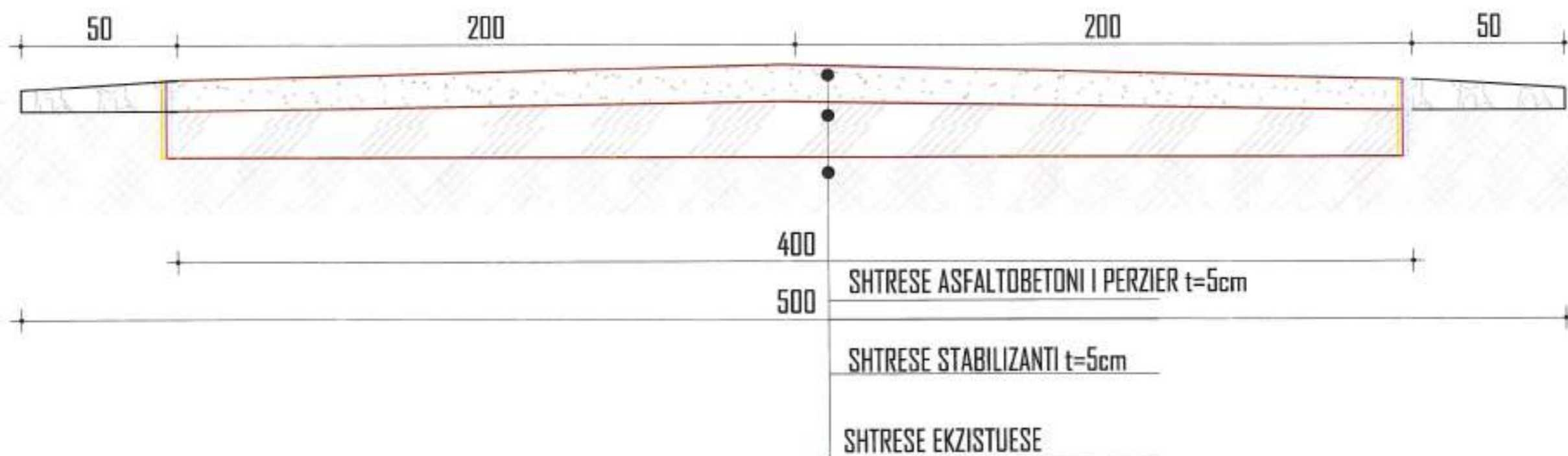

Ministria e Transportit dhe Infrastruktura  
 Bashkia e Durrësit  
 Miratim dhe Kuvend

Projekti:  
 RIKONSTRUKTIVIMI I RRUGËS P.0-P.3 DHE P.1-P.3' NË BARRAZHËN SMARINË  
 NË QYLLIN E BARRAZHËS NË QYLLIN E DËLLIÇKËS

Grupi i P.F. Projektimit:  
 Inxh. Enxhin Hoxha  
 Inxh. Enxhin Hoxha  
 Inxh. Enxhin Hoxha

Grupi i P.F. Zbatimit:  
 Enxhin Hoxha

Titulli i kësaj: **PROFILI TIP I RRUGËS**

Eletë:  
 Shtetli

19/02/2023

Fletë/434 Nr.  
**06**

PROFILAT TERTHORE  
 Profili Nr.0  
 Progresivi 0.00 m  
 K.Tokes 13.00 m  
 K.Projektit 13.25 m  
 Germim= 0.64 m3/m  
 Mbushje= 1.3 m3/m

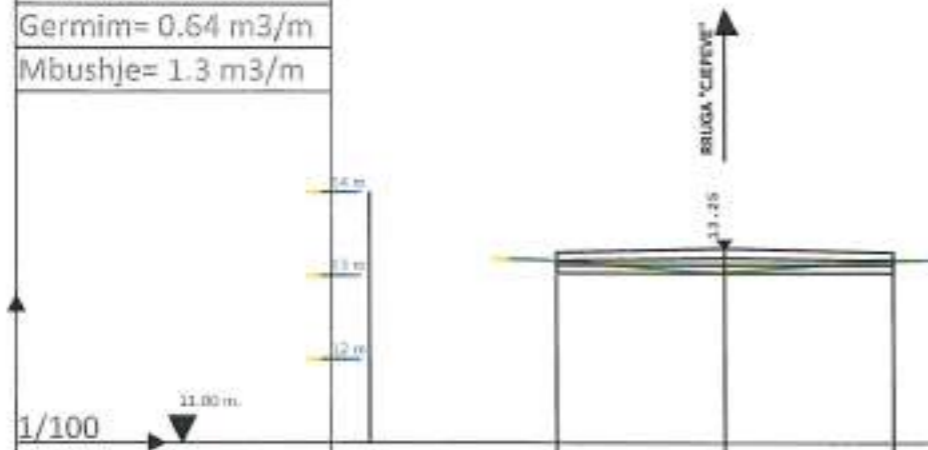

KUOTA E TOKES	13.05	13.00	13.05
D.PJESORE TOKES	2.00	2.00	2.00
KUOTA PROJEKTIT	13.20	13.25	13.30
D.PJESORE PROJEKTIT	2.15	2.00	2.00

PROFILAT TERTHORE  
 Profili Nr.1  
 Progresivi 55.00 m  
 K.Tokes 13.00 m  
 K.Projektit 13.25 m  
 Germim= 0.64 m3/m  
 Mbushje= 1.3 m3/m

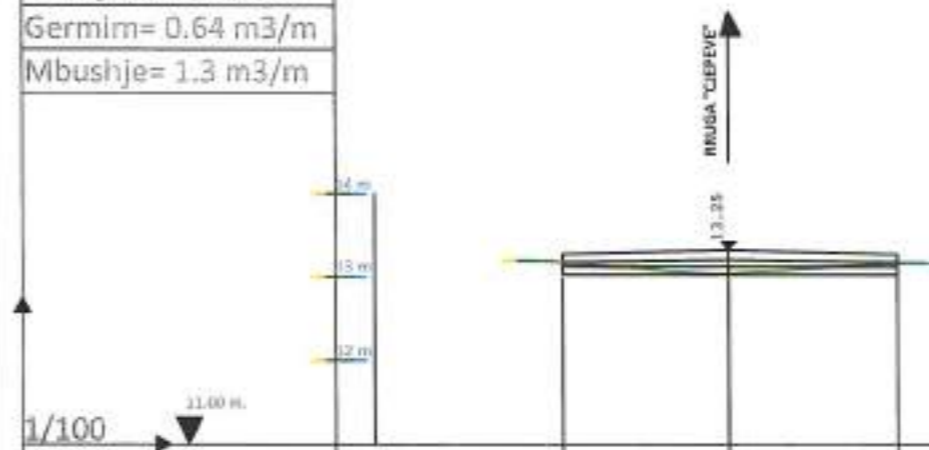

KUOTA E TOKES	13.05	13.00	13.05
D.PJESORE TOKES	2.00	2.00	2.00
KUOTA PROJEKTIT	13.20	13.25	13.30
D.PJESORE PROJEKTIT	2.15	2.00	2.15

PROFILAT TERTHORE  
 Profili Nr.2  
 Progresivi 180.00 m  
 K.Tokes 12.90 m  
 K.Projektit 13.15 m  
 Germim= 0.64 m3/m  
 Mbushje= 1.3 m3/m

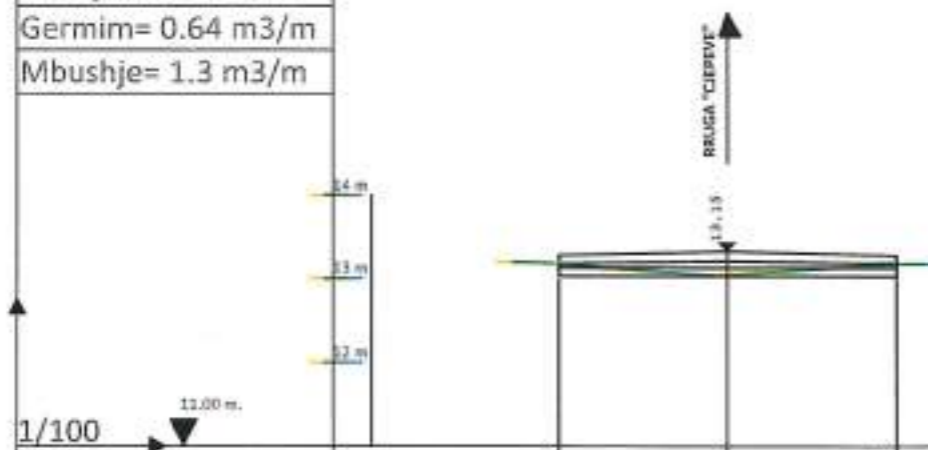

KUOTA E TOKES	12.95	12.90	12.95
D.PJESORE TOKES	2.00	2.00	2.00
KUOTA PROJEKTIT	13.10	13.15	13.20
D.PJESORE PROJEKTIT	2.15	2.00	2.00

PROFILAT TERTHORE  
 Profili Nr.3  
 Progresivi 320.00 m  
 K.Tokes 12.80 m  
 K.Projektit 13.05 m  
 Germim= 0.64 m3/m  
 Mbushje= 1.3 m3/m

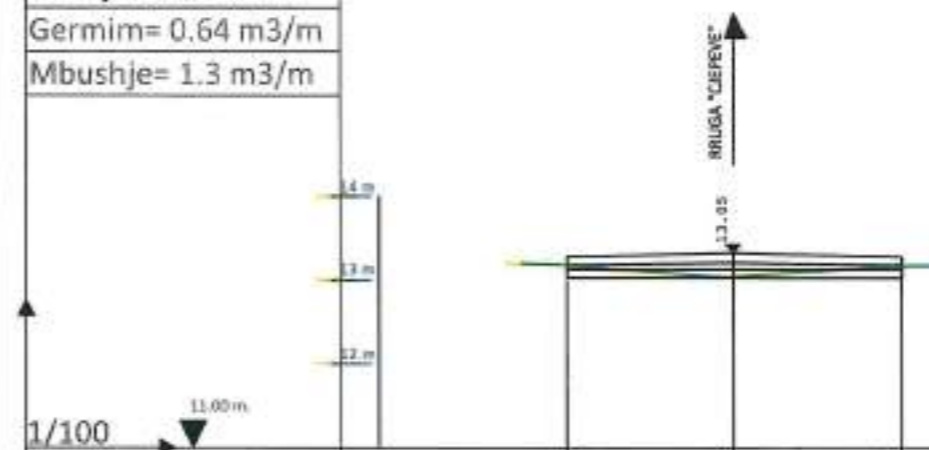

KUOTA E TOKES	12.95	12.80	12.95
D.PJESORE TOKES	2.00	2.00	2.00
KUOTA PROJEKTIT	13.00	13.05	13.10
D.PJESORE PROJEKTIT	2.15	2.00	2.00

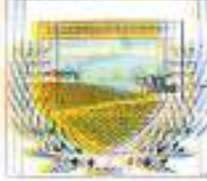

Ministria e Transportit dhe Infrastruktura  
 Detyra e Përgjithshme  
 Detyra e Përgjithshme

Projekt:  
 RREZAT E RRUGËVE TË BASHKUVAJTE  
 NË QYTETIN E DIBRËS

Grupi i Projektimit:  
 Inzh. G. Basha  
 Inzh. S. Basha  
 Inzh. E. Basha

Grupi i Përzgjedhjes:  
 Inzh. Basha

Titulli i Detyrës:  
 PROFILAT TERTHORE TË RRUGËS

Detyra  
 Shtesë

07.07.2023

Primeri 453 Nr.

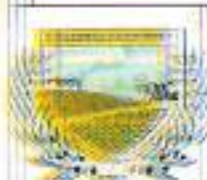
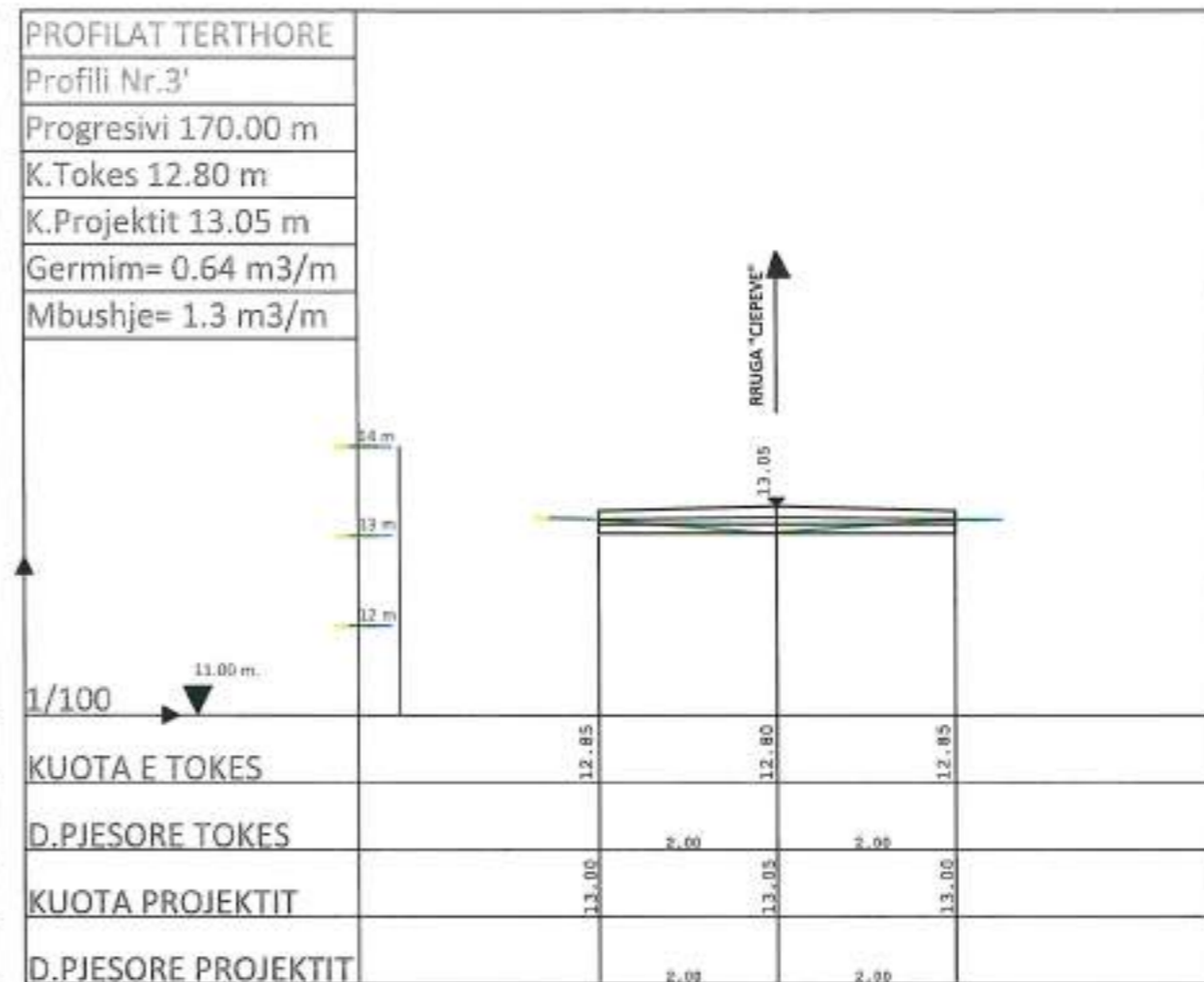
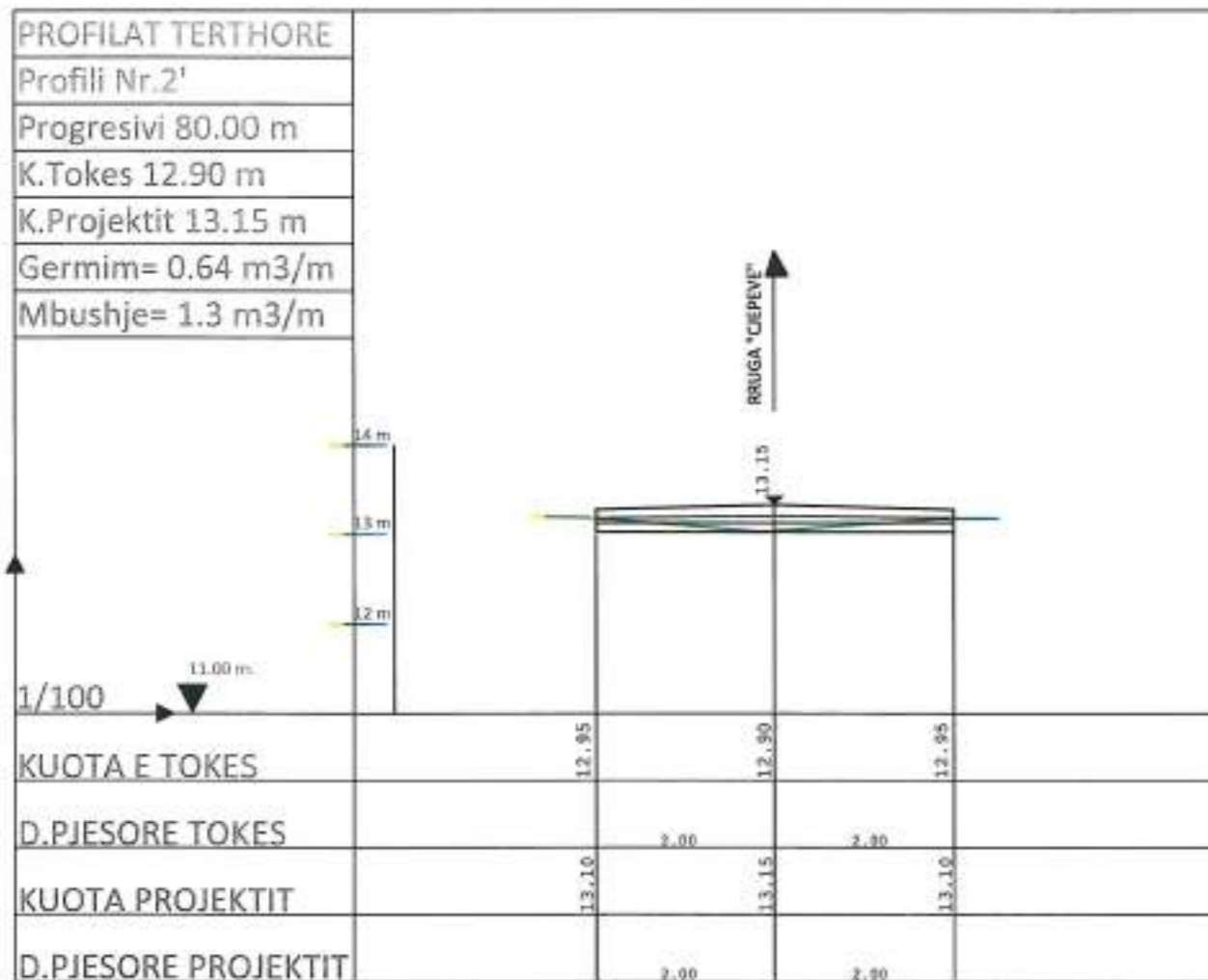

Republika e Shqipërisë  
 Ministria e Transportit dhe Infrastruktura  
 Detyrueshëm

Projektet:  
 AVISPAJTI I RRUGËVE TË BRINDËS MATE NË  
 LINDJE TË BASHKISË FROSKUMEL

Ekzpozitor/Projektuesi:  
 Inzh. Shkëlzen Hoxha  
 Inzh. Evis Hoxha  
 Inzh. Edmond Hoxha

Drejtori/PRZHEK:  
 Enxhela Hoxha

Titulli i detyrës:  
 PROFILI TERTHORE I RRUGËS

Ditë:  
 Shtetë

05.02.2023

Firma/MBW:



Republika e Kosovës

# OBJEKTE ASFALTIMI I RRUGËVE TË BRENDESHME NË LAGJET E BASHKISË ROSKOVEC (RRUGA E ARGJINATURES)

 Emri i bashkisë: <b>Bashkia e Roskovec</b> Miri i: Kryetari: <b>Mirëza Haxhiu</b>	Projekti: <b>ASFALTIMI I RRUGËVE TË BRENDESHME NË LAGJET E BASHKISË ROSKOVEC</b>	Grupi i Përgjegjësimit: Zëvendësuesi i bashkisë: Zëvendësuesi i bashkisë: Zëvendësuesi i bashkisë:	Organizimi: <b>HEZBETI</b> Emri i bashkisë:	Titulli i detyrës: <b>KRYEPANU</b>	Dëbete:	<b>05/10/2023</b>	Titulli i detyrës: 
					CSH-Heqja:		

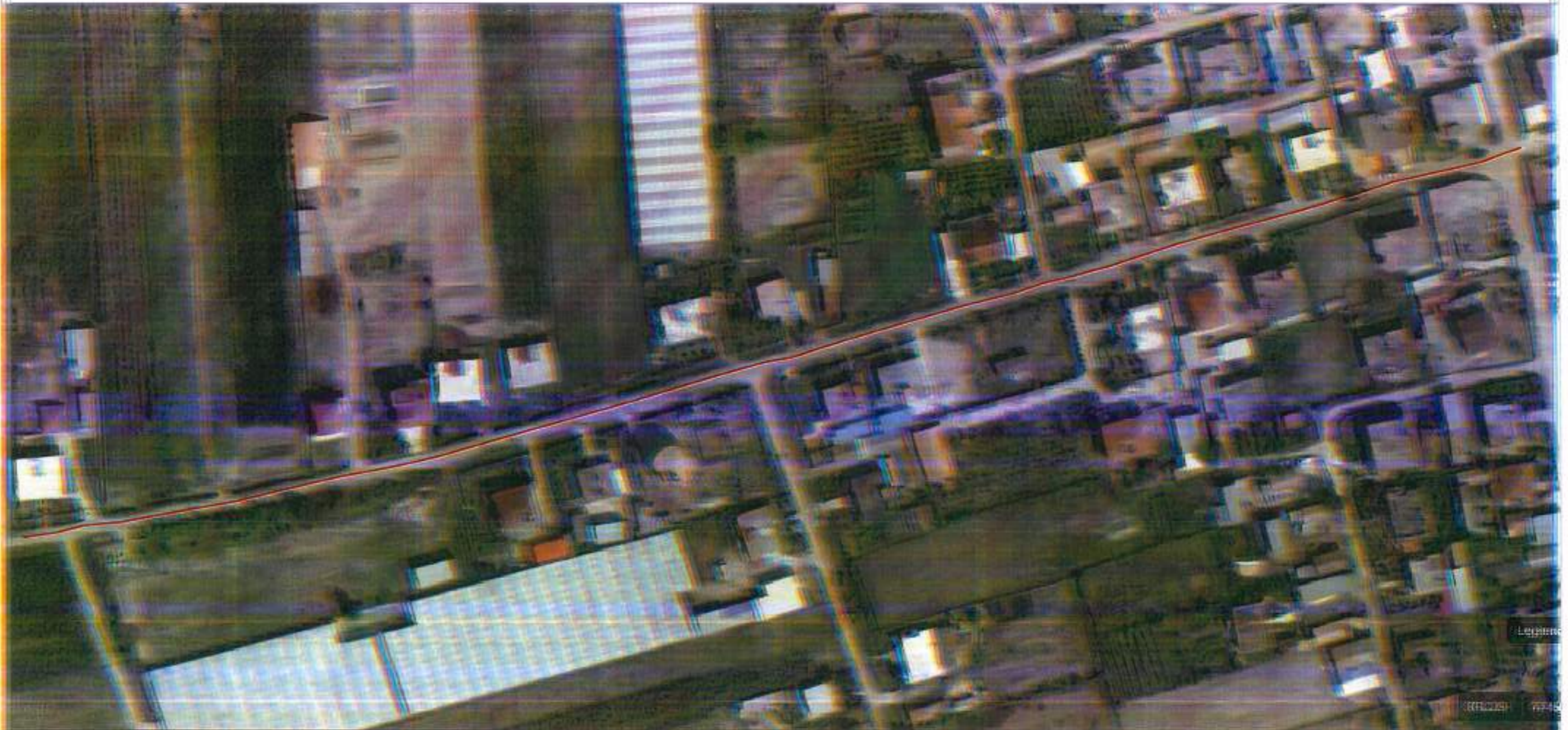

Հանրային  
Բնակարանային  
Վարչություն  
Հանրային Կառուցման  
Կոմիտեի Կենտրոն



Ստորագրող:  
ՀԱՅԱՍՏԱՆԻ ՀԱՆՐԱՊԵՏՈՒԹՅԱՆ ԿՈՆՍՏՐԱԿՏԻ ՎԵՐԱԿԱՆՈՒՄԻ ԿՈՄԻՏԵ

Երևանի քաղաքի  
Վարչական շրջանի  
Հանրային կառուցման  
կոմիտեի Կենտրոն

Ստորագրող:  
Կոմիտեի Կենտրոն

Տվյալների կոդ:  
ՀՀ ԿՈՆՍՏՐԱԿՏԻ ՎԵՐԱԿԱՆՈՒՄԻ ԿՈՄԻՏԵ

Ստորագրող:  
ՀՀ ԿՈՆՍՏՐԱԿՏԻ ՎԵՐԱԿԱՆՈՒՄԻ ԿՈՄԻՏԵ

Տվյալների կոդ:  
ՀՀ ԿՈՆՍՏՐԱԿՏԻ ՎԵՐԱԿԱՆՈՒՄԻ ԿՈՄԻՏԵ

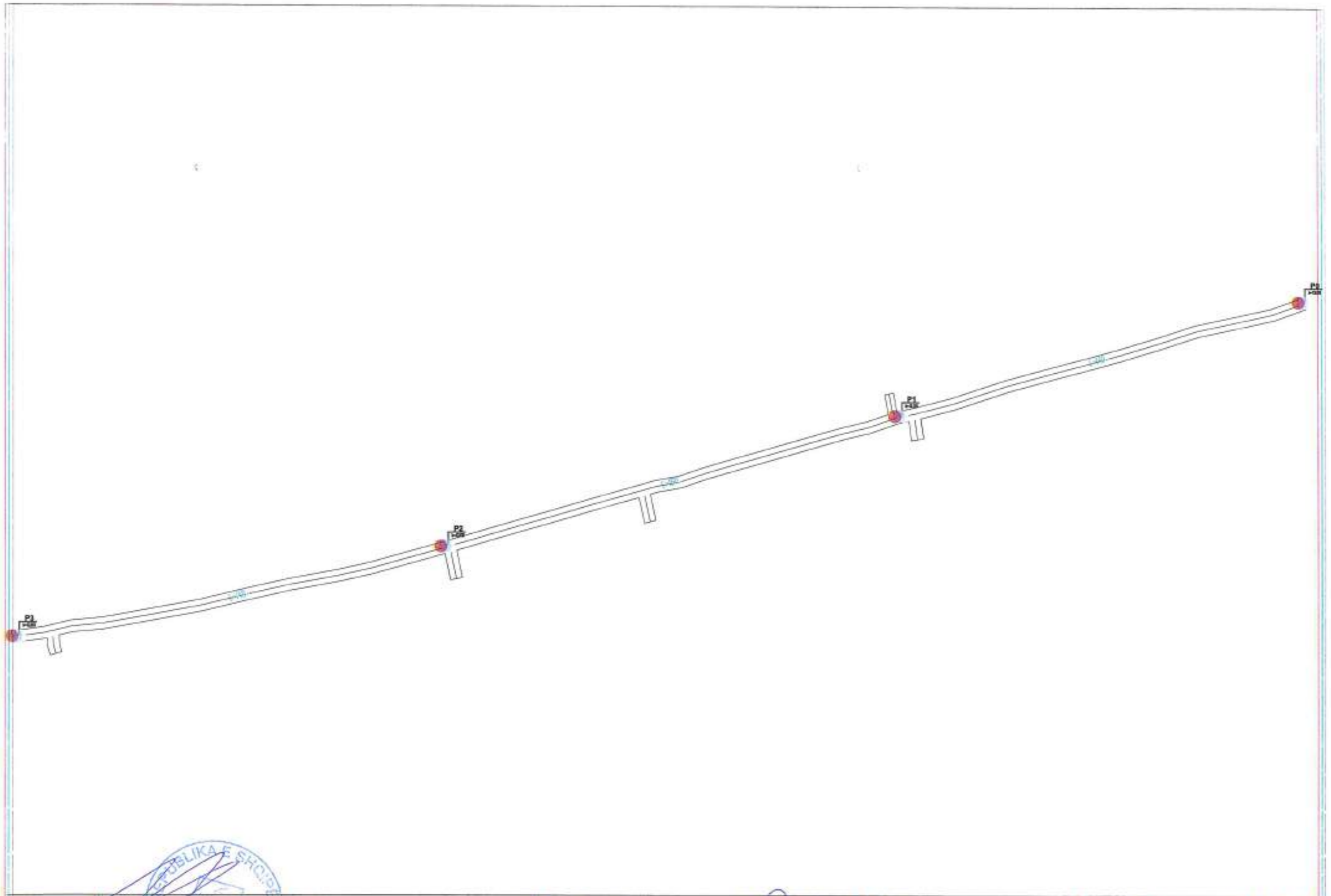

Ministria e Transportit dhe Infrastruktura  
 Detyrueshë e Transportit dhe Infrastruktura  
 Ministri  
 Kryeministri

Projekt:  
 VËRSHTIMAT E PUNËSIMIT DHE EMBELISHTIMIT  
 LANDET E HAPËSISË E REZONANCËS

Grupi i Përgjegjës:  
 Inxhinjeri i Transportit  
 Inxhinjeri i Kështjellës  
 Inxhinjeri i Kështjellës

Grupi i PËRZAHITË:  
 Inxhinjeri i Kështjellës

Titull i Kështjellës:  
 PËRZAHITË I PUNËSIMIT DHE EMBELISHTIMIT  
 E REZONANCËS

Data:  
 Shtator

15.02.2023

Firma: [Signature]

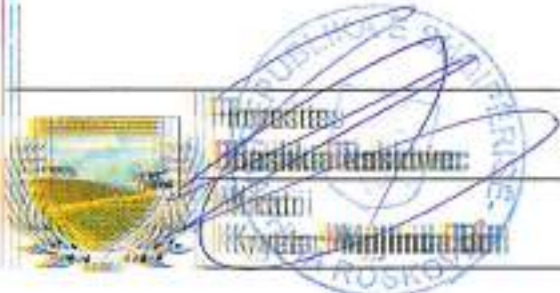
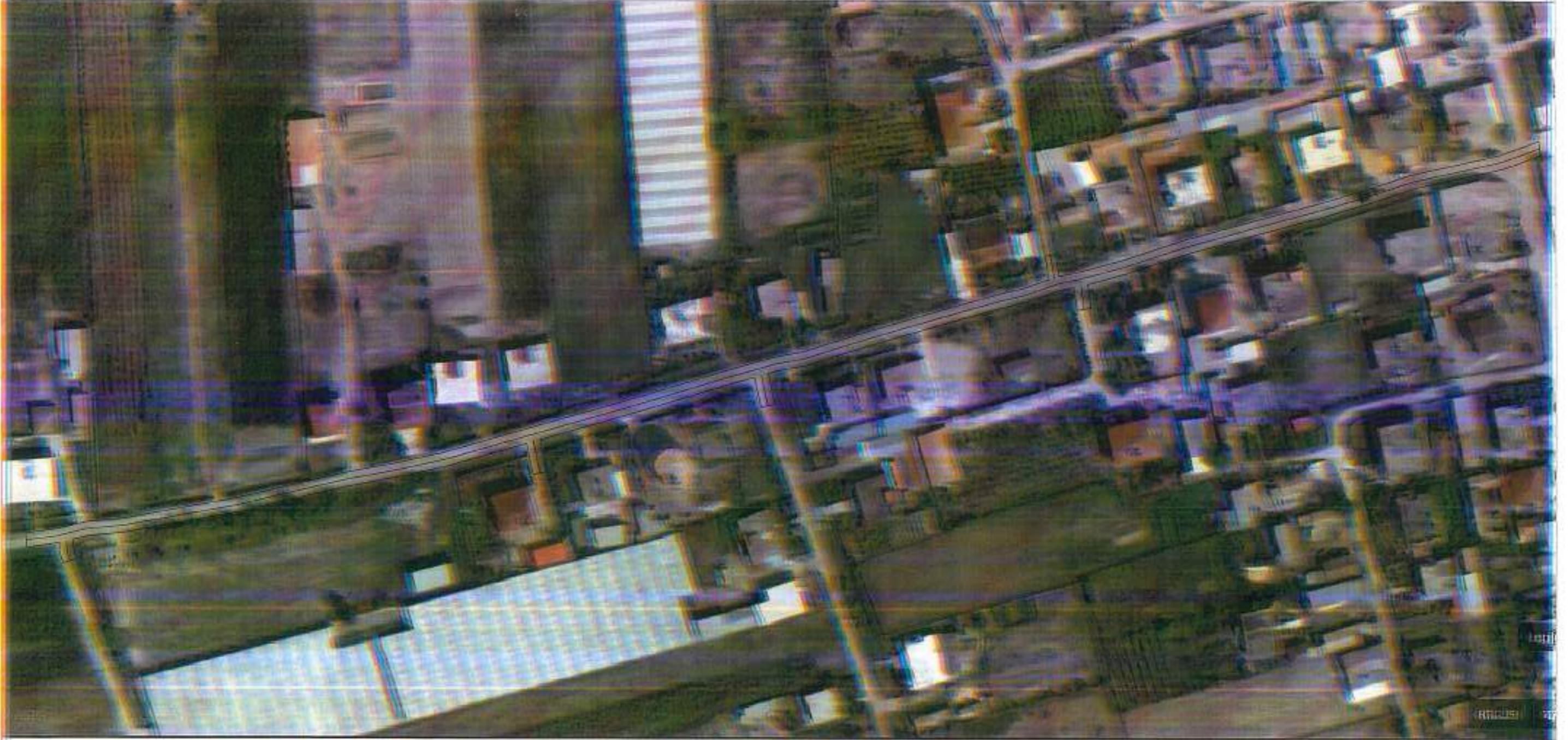

Projekt:  
 VÝSTAVBA ROLNÍHO VEŘEJNÉHO  
 MÍSTNOSTI VE VEŘEJNÉ MÍSTNOSTI

Účastníci projektu:  
 Ústav zemědělské ekonomiky  
 a informací  
 Ústav zemědělské ekonomiky  
 a informací

Účastníci projektu:  
 Ústav zemědělské ekonomiky  
 a informací

Titulní list:  
 PRÁVNÍ ÚSTAV VEŘEJNÉ SPRÁVY

Číslo:	005/02/0023
SSJ číslo:	

Číslo listu:  
 03



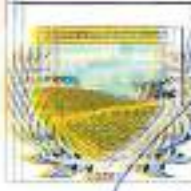
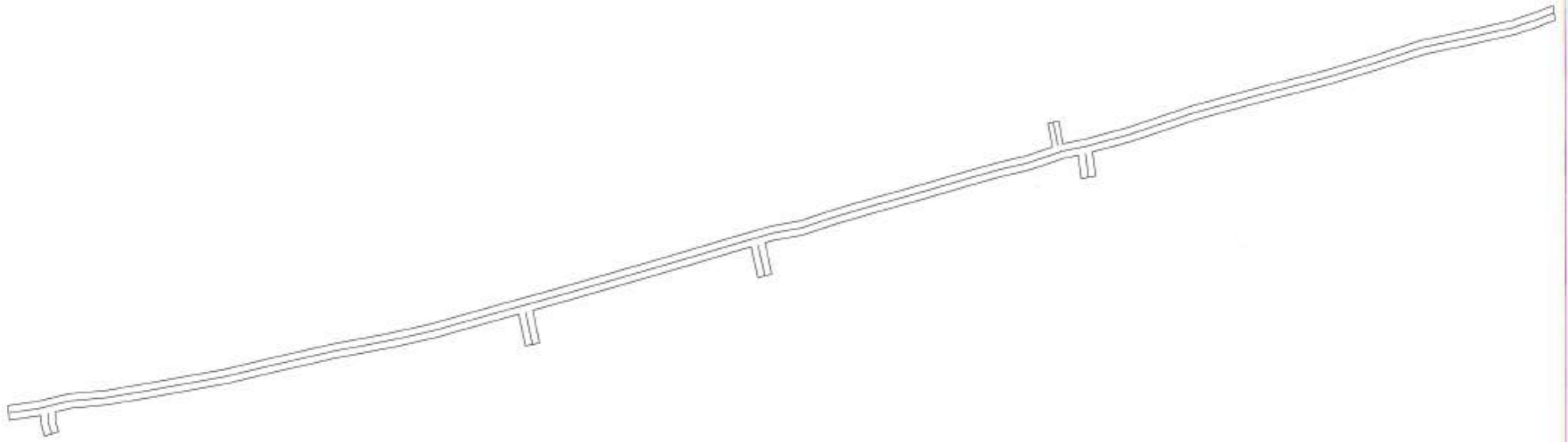

Հանրապետության  
 Կոմսիտեի Կենտրոն  
 Մարտի  
 Կոմսիտեի Մայրամաս  
 Երևան

Մոտոցիկլային  
 Կատարողի Կրթության  
 Կենտրոն

Գծաշարի և Մոտոցիկլային  
 Կրթության Կենտրոնի  
 Կրթական Մասնաճյուղի  
 Կրթական Մասնաճյուղի

Կրթության Կենտրոնի  
 Կրթական Մասնաճյուղի

Մոտոցիկլային  
 Կատարողի Կրթության  
 Կենտրոնի Կրթական  
 Մասնաճյուղի

Մեթոդ  
 Ստուգում

05/02/2023

Գծաշարի  
 04

# PROFILI GJATESOR

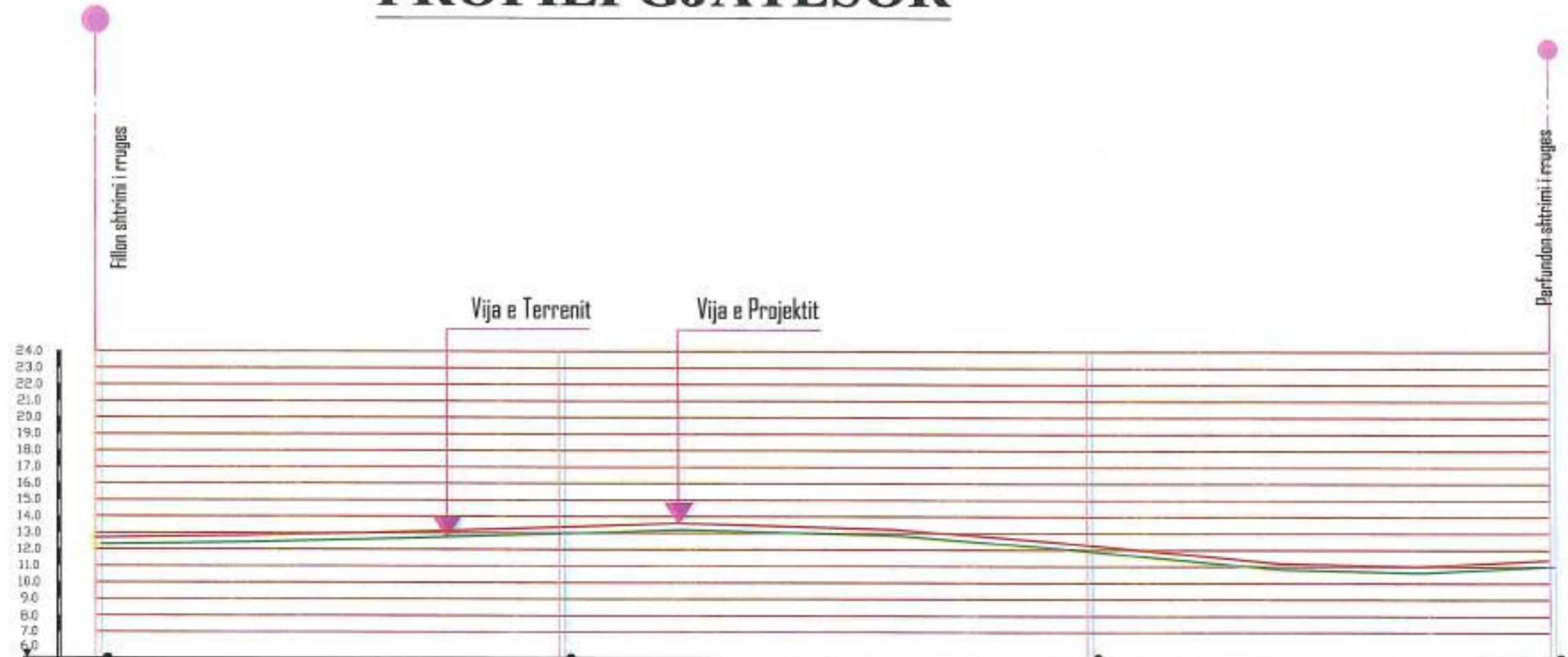

Elementet								
Diferenca (cm)	10		10		10		10	
Kuota e Projektit	12.60		13.10		12.10		11.10	
Kuota e piketes	12.50		13.00		12.00		11.00	
Nr. Piketes	0		1		2		3	
Distanca Pjesore		140		160		140		
Distanca Progressive	0	140		300		440		



Projektet:  
 ASFAKIMI I RRUGES NË BIRANISHTEN  
 NË QYLLIN E BIRANISHTES

Grupi i Përgjigjetarët:  
 Inxhinjeri i Rrugëve  
 Inxhinjeri i Hidraulikës  
 Inxhinjeri i Elektricitetit

Drejtori i PZSHIT:  
 [Signature]

Titulli i Riçetes:  
 PROFILI GJATESOR I RRUGES

Data: 05.10.2023  
 Shënime:

Fletës/45 Nr.  
05

# PROFILI TIP RRUGA E "ARGJINATURES"

## P.0-P.3

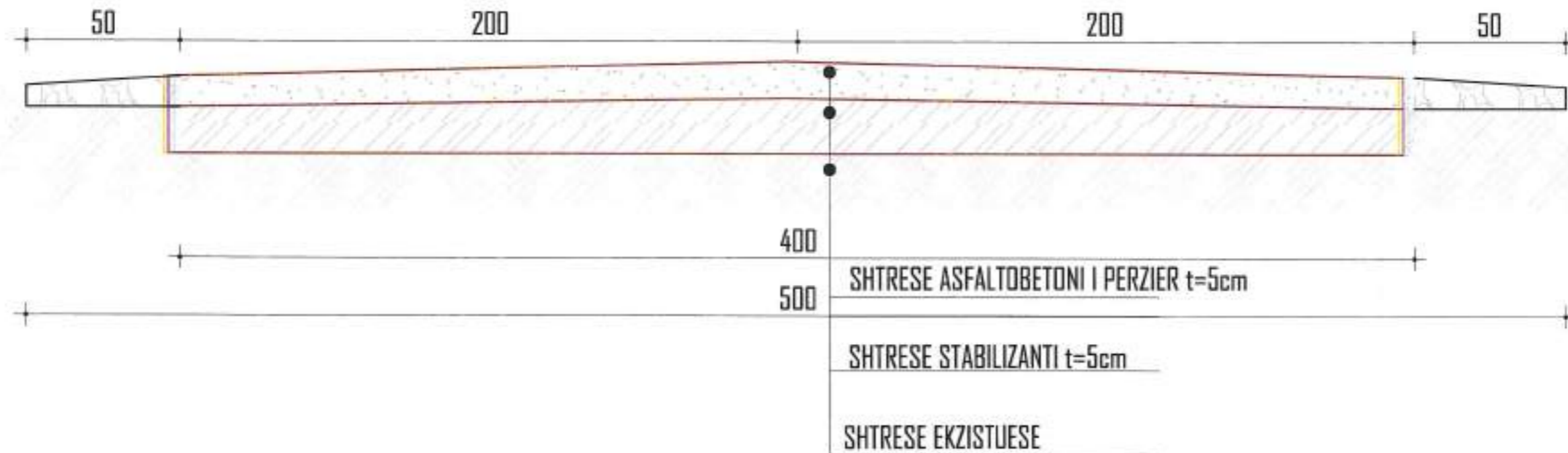

Projekti:  
**ASFALTIMI RRUGËVE DHE TËRRINDËSMEVE  
 NË QYLLIN E BASHKISË REZISKUMEC**

Emri i Projektit:  
 Emri i Autorit:  
 Emri i Komitetit:  
 Emri i Komitetit:

Emri i Autorit:  
 Emri i Komitetit:

Titulli i Titrit:  
**PROFILI TIP I RRUGËS**

Data: 06/10/2023  
 SS: [Blank]

Shënimi: 06

PROFILAT TERTHORE  
 Profili Nr.0  
 Progresivi 0.00 m  
 K.Tokes 131.00 m  
 K.Projektit 131.25 m  
 Germim= 0.64 m3/m  
 Mbushje= 1.3 m3/m



KUOTA E TOKES	131.05	131.00	131.05
D.PJESORE TOKES	2.00	2.00	2.00
KUOTA PROJEKTIT	131.20	131.25	131.20
D.PJESORE PROJEKTIT	2.00	2.00	2.00

PROFILAT TERTHORE  
 Profili Nr.1  
 Progresivi 90.00 m  
 K.Tokes 136.00 m  
 K.Projektit 136.25 m  
 Germim= 0.64 m3/m  
 Mbushje= 1.3 m3/m

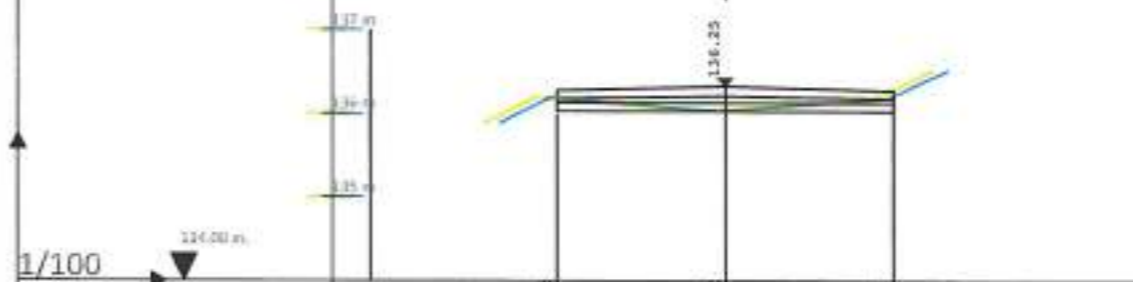

KUOTA E TOKES	136.05	136.00	136.05
D.PJESORE TOKES	2.00	2.00	2.00
KUOTA PROJEKTIT	136.20	136.25	136.20
D.PJESORE PROJEKTIT	2.00	2.00	2.00

PROFILAT TERTHORE  
 Profili Nr.2  
 Progresivi 190.00 m  
 K.Tokes 136.00 m  
 K.Projektit 136.25 m  
 Germim= 0.64 m3/m  
 Mbushje= 1.3 m3/m

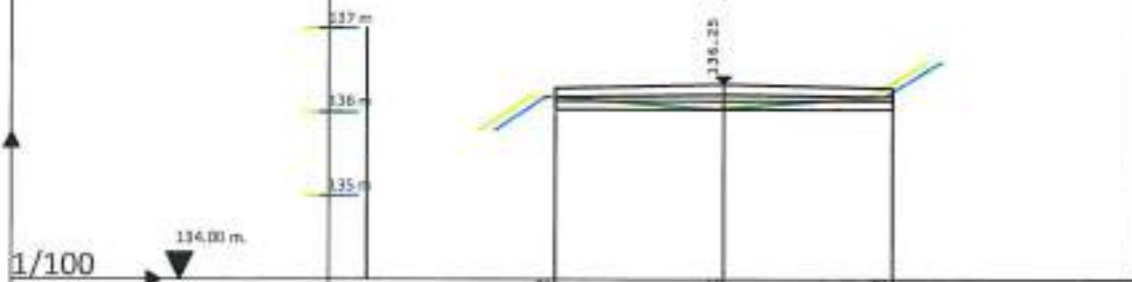

KUOTA E TOKES	136.05	136.00	136.05
D.PJESORE TOKES	2.00	2.00	2.00
KUOTA PROJEKTIT	136.20	136.25	136.20
D.PJESORE PROJEKTIT	2.00	2.00	2.00

PROFILAT TERTHORE  
 Profili Nr.3  
 Progresivi 310.00 m  
 K.Tokes 138.00 m  
 K.Projektit 138.25 m  
 Germim= 0.64 m3/m  
 Mbushje= 1.3 m3/m

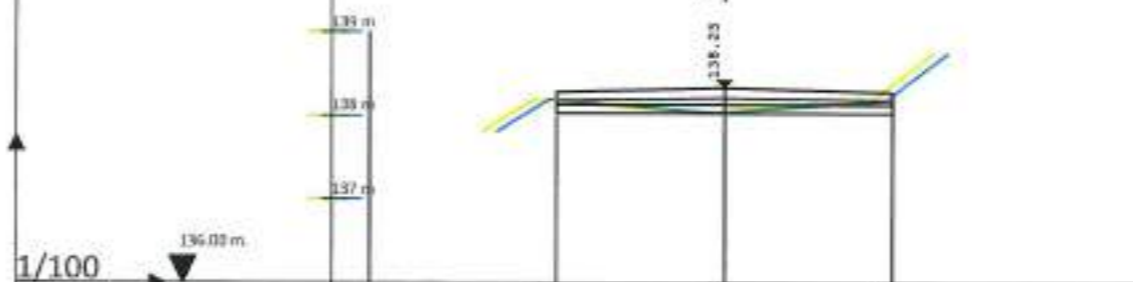

KUOTA E TOKES	138.05	138.00	138.05
D.PJESORE TOKES	2.00	2.00	2.00
KUOTA PROJEKTIT	138.20	138.25	138.20
D.PJESORE PROJEKTIT	2.00	2.00	2.00



Ministria e Transportit dhe Infrastruktura  
 Detyruesi i Transportit dhe Infrastruktura  
 Tiranë

Projekt:  
 RRETHIMI I RRUGËVE DHE PËRMBUESHËNË  
 NË BASHKËTËRRESHINË E BASHKISË  
 DREKËZIT

Grupi i Projektimit:  
 Inzh. E. Basha  
 Inzh. T. Basha  
 Inzh. E. Basha (Kryetar)

Grupi i Projektimit:  
 Inzh. E. Basha  
 Inzh. T. Basha

Titulli i detyrës:  
 PROJEKTI I RRETHIMIT DHE PËRMBUESHËNË

Të bërë  
 Shtator

18.09.2023

Titulli i detyrës:  
 Inzh. E. Basha