

Porositës:

**Bashkia Malësia e Madhe**

# SISTEMIM ASFALTIM RRUGA KOPLIK SIPERM-LUIS

**Autor** "NOVATECH STUDIO "SHPK



**ADMIN ING. EMIL NOVA**

**Grupi projektimit:**

ING. NDERTIMI	Mimoza TOMCO
ARKITEKT	Gerta NOVA
ING. HIDROTEKNIK	Klodjan NDOJ
ING. HIDROTEKNIK	Kostandin NOVA
ING. GJEOLGJIK	Antonia BAZHDARI

## PROJEKT ZBATIMI

**JANAR 2023**

Vula

# HOROGRAFIA SH. 1:5000



Porositës:

**Bashkia Malësia e Madhe**

Titulli i Projektit

**SISTEMIM ASFALTIM  
RRUGA KOPLIK SIPERM-LUIS**

Faza

**PROJEKT ZBATIMI**

Vula

Autor

"NOVATECH STUDIO "SHPK



**ADMIN ING. EMIL NOVA**

Grupi projektimit:

ING. NDERTIMI	Mimoza TOMCO
ARKITEKT	Gerta NOVA
ING. HIDROTEKNIK	Klodjan NDQJ
ING. HIDROTEKNIK	Kostandin NOVA
ING. GJEOLGJIK	Antonela BAZHDARI

Vula

Kapitulli

**PROJEKTI ARKITEKTONIK**

Titulli i Vizatimit

HOROGRAFIA

Realizuar **JANAR 2023** Shkalla **1:5000**



Emërtimi i Fletës

**A 1 - 01**

# PLANIMETRI E GJENDJES EKZISTUESE SH. 1:500



## LEGJENDË

-  Aksi i Rrugës
-  Rilevimi Topografik (KUOTA)
-  Rilevimi Topografik (IZOIPSE)

Porositës:

Bashkia Malësia e Madhe

Titulli i Projektit

SISTEMIM ASFALTIM  
RRUGA KOPLIK SIPERM-LUIS

Faza

PROJEKT ZBATIMI

Vula

Autor "NOVATECH STUDIO "SHPK



Grupi projektimit:

ING. NDERTIMI	Mimoza TOMCO
ARKITEKT	Gerta NOVA
ING. HIDROTEKNIK	Klodjan NDQJ
ING. HIDROTEKNIK	Kostandin NOVA
ING. GJEOLGJIK	Antonela BAZHDARI

Vula

Kapitulli

PROJEKTI ARKITEKTONIK

Titulli i Vizatimit

PLANIMETRI E GJENDJES EKZISTUESE

Realizuar **JANAR 2023** Shkalla **1:500**



Emërtimi i Fletës

**A 1 - 02**

# PLANIMETRI E GJENDJES EKZISTUESE SH. 1:500



## LEGJENDË

-  Aksi i Rrugës
-  Rilevimi Topografik (KUOTA)
-  Rilevimi Topografik (IZOIPSE)

Porositës:

Bashkia Malësia e Madhe

Titulli i Projektit

SISTEMIM ASFALTIM  
RRUGA KOPLIK SIPERM-LUIS

Faza

PROJEKT ZBATIMI

Vula

Autor "NOVATECH STUDIO "SHPK



ADMIN ING. EMIL NOVA

Grupi projektimit:

ING. NDERTIMI	Mimoza TOMCO
ARKITEKT	Gerta NOVA
ING. HIDROTEKNIK	Klodjan NDQJ
ING. HIDROTEKNIK	Kostandin NOVA
ING. GJEOLGJIK	Antonela BAZHDARI

Vula

Kapitulli

PROJEKTI ARKITEKTONIK

Titulli i Vizatimit

PLANIMETRI E GJENDJES EKZISTUESE



Realizuar **JANAR 2023** Shkalla **1:500**

Emërtimi i Fletës  
**A 1 - 03**

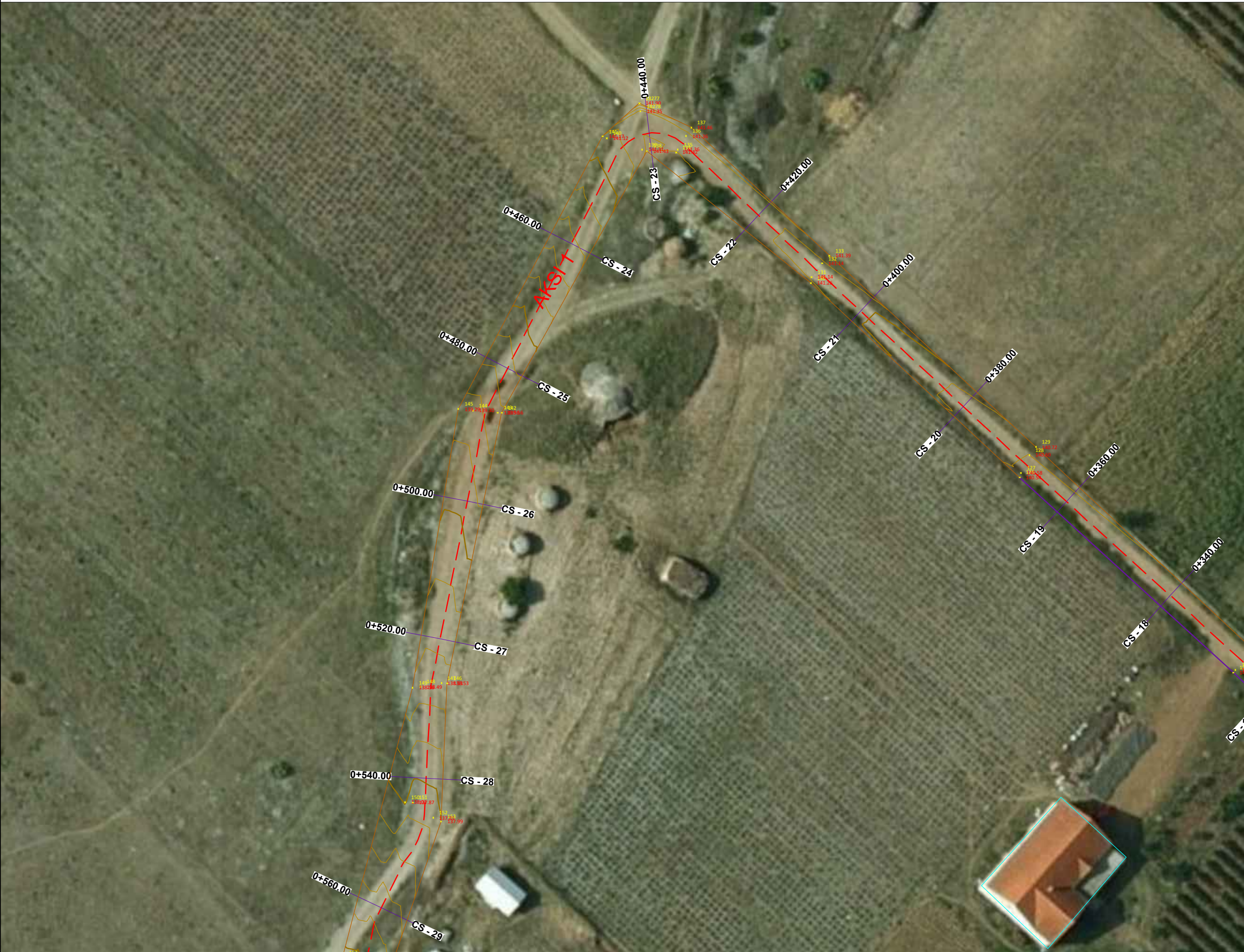
# PLANIMETRI E GJENDJES EKZISTUESE SH. 1:500



## LEGJENDË

-  Aksi i Rrugës
-  Rilevimi Topografik (KUOTA)
-  Rilevimi Topografik (IZOIPSE)

Porositës:

Bashkia Malësia e Madhe

Titulli i Projektit

SISTEMIM ASFALTIM  
RRUGA KOPLIK SIPERM-LUIS

Faza

PROJEKT ZBATIMI

Vula

Autor "NOVATECH STUDIO "SHPK



Grupi projektimit:

ING. NDERTIMI	Mimoza TOMCO
ARKITEKT	Gerta NOVA
ING. HIDROTEKNIK	Klodjan NDQJ
ING. HIDROTEKNIK	Kostandin NOVA
ING. GJEOLGJIK	Antonela BAZHDARI

Vula

Kapitulli

PROJEKTI ARKITEKTONIK

Titulli i Vizatimit



PLANIMETRI E GJENDJES EKZISTUESE

Realizuar **JANAR 2023** Shkalla **1:500**

Emërtimi i Fletës  
**A 1 - 04**

# PLANIMETRI E GJENDJES EKZISTUESE SH. 1:500

## LEGJENDË

-  Aksi i Rrugës
-  Rilevimi Topografik (KUOTA)
-  Rilevimi Topografik (IZOIPSE)

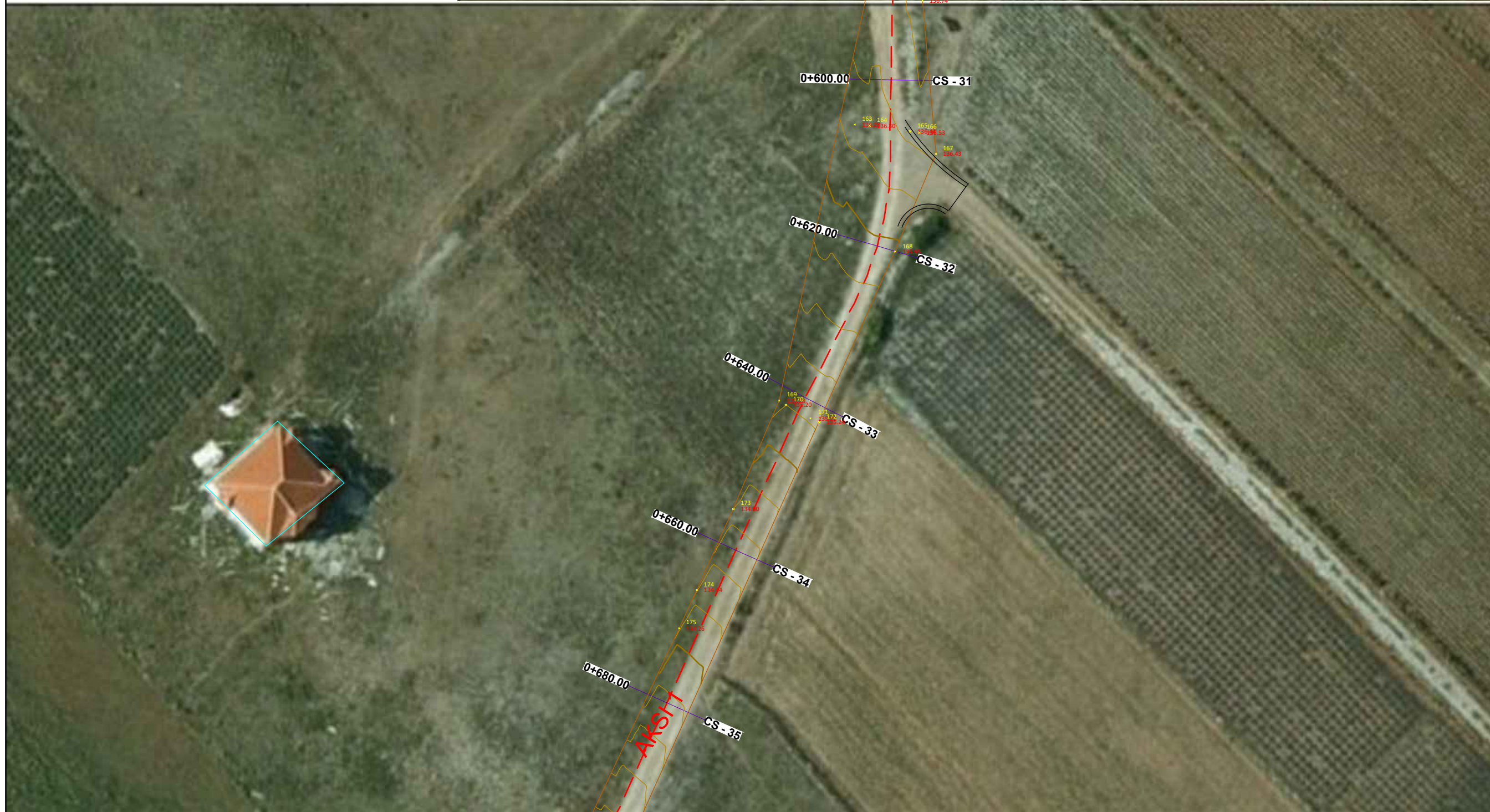

Porositës:

Bashkia Malësia e Madhe

Titulli i Projektit

SISTEMIM ASFALTIM  
RRUGA KOPLIK SIPERM-LUIS

Faza

PROJEKT ZBATIMI

Vula

Autor

"NOVATECH STUDIO "SHPK

ADMIN ING. EMIL NOVA

Grupi projektimit:

ING. NDERTIMI	Mimoza TOMCO
ARKITEKT	Gerta NOVA
ING. HIDROTEKNIK	Klodjan NDQJ
ING. HIDROTEKNIK	Kostandin NOVA
ING. GJEOLGJIK	Antonela BAZHDARI

Vula

Kapitulli

PROJEKTI ARKITEKTONIK

Titulli i Vizatimit

PLANIMETRI E GJENDJES EKZISTUESE

Realizuar **JANAR 2023** Shkalla **1:500**



Emërtimi i Fletës

**A 1 - 05**

# PLANIMETRI E GJENDJES EKZISTUESE SH. 1:500



## LEGJENDË

-  Aksi i Rrugës
-  Rilevimi Topografik (KUOTA)
-  Rilevimi Topografik (IZOIPSE)

### Porositës:

Bashkia Malësia e Madhe

### Titulli i Projektit

SISTEMIM ASFALTIM  
RRUGA KOPLIK SIPERM-LUIS

### Faza

PROJEKT ZBATIMI

### Vula

Autor "NOVATECH STUDIO "SHPK



### Grupi projektimit:

ING. NDERTIMI	Mimoza TOMCO
ARKITEKT	Gerta NOVA
ING. HIDROTEKNIK	Klodjan NDQJ
ING. HIDROTEKNIK	Kostandin NOVA
ING. GJEOLGJIK	Antonela BAZHDARI

### Vula

### Kapitulli

PROJEKTI ARKITEKTONIK

### Titulli i Vizatimit

PLANIMETRI E GJENDJES EKZISTUESE

Realizuar **JANAR 2023** | Shkalla **1:500**



Emërtimi i Fletës

**A 1 - 06**

# PLANIMETRI E GJENDJES EKZISTUESE SH. 1:500



## LEGJENDË

-  Aksi i Rrugës
-  Rilevimi Topografik (KUOTA)
-  Rilevimi Topografik (IZOIPSE)

Porositës:

Bashkia Malësia e Madhe

Titulli i Projektit

SISTEMIM ASFALTIM  
RRUGA KOPLIK SIPERM-LUIS

Faza

PROJEKT ZBATIMI

Vula

Autor "NOVATECH STUDIO "SHPK



ADMIN ING. EMIL NOVA

Grupi projektimit:

ING. NDERTIMI	Mimoza TOMCO
ARKITEKT	Gerta NOVA
ING. HIDROTEKNIK	Klodjan NDQJ
ING. HIDROTEKNIK	Kostandin NOVA
ING. GJEOLOGJIK	Antonela BAZHDARI

Vula

Kapitulli

PROJEKTI ARKITEKTONIK

Titulli i Vizatimit

PLANIMETRI E GJENDJES EKZISTUESE

Realizuar **JANAR 2023** Shkalla **1:500**



Emërtimi i Fletës

**A 1 - 07**



# PLANIMETRI E GJENDJES EKZISTUESE SH. 1:500

## LEGJENDË

-  Aksi i Rrugës
-  Rilevimi Topografik (KUOTA)
-  Rilevimi Topografik (IZOIPSE)

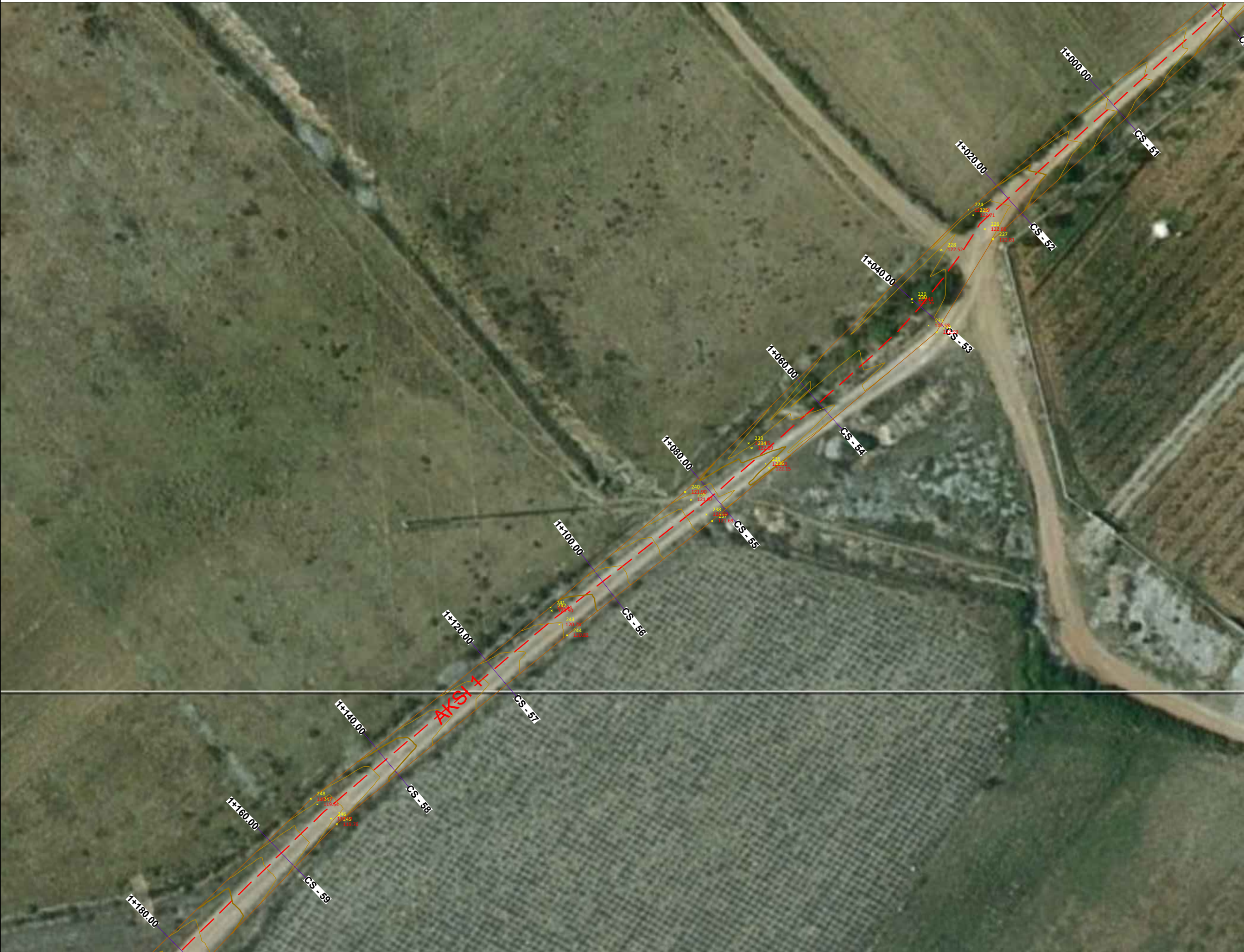

Porositës:  
**Bashkia Malësia e Madhe**

Titulli i Projektit  
**SISTEMIM ASFALTIM  
RRUGA KOPLIK SIPERM-LUIS**

Faza  
**PROJEKT ZBATIMI**

Vula  
Autor "NOVATECH STUDIO "SHPK"  
  
ADMIN ING. EMIL NOVA

Grupi projektimit:

ING. NDERTIMI	Mimoza TOMCO
ARKITEKT	Gerta NOVA
ING. HIDROTEKNIK	Klodjan NDQJ
ING. HIDROTEKNIK	Kostandin NOVA
ING. GJEOLGJIK	Antonela BAZHDARI

Kapitulli  
**PROJEKTI ARKITEKTONIK**



Titulli i Vizatimit  
PLANIMETRI E GJENDJES EKZISTUESE

Realizuar <b>JANAR 2023</b>	Shkalla <b>1:500</b>
--------------------------------	-------------------------

Emërtimi i Fletës  
**A 1 - 08**

# PLANIMETRI E GJENDJES EKZISTUESE SH. 1:500

## LEGJENDË

-  Aksi i Rrugës
-  Rilevimi Topografik (KUOTA)
-  Rilevimi Topografik (IZOIPSE)



**Porositës:**  
Bashkia Malësia e Madhe

**Titulli i Projektit**  
SISTEMIM ASFALTIM  
RRUGA KOPLIK SIPERM-LUIS

**Faza**  
PROJEKT ZBATIMI

**Vula**  
**Autor** "NOVATECH STUDIO "SHPK  
ADMIN ING. EMIL NOVA

**Grupi projektimit:**

ING. NDERTIMI	Mimoza TOMCO
ARKITEKT	Gerta NOVA
ING. HIDROTEKNIK	Klodjan NDQJ
ING. HIDROTEKNIK	Kostandin NOVA
ING. GJEOLGJIK	Antonela BAZHDARI

**Kapitulli**  
PROJEKTI ARKITEKTONIK



**Titulli i Vizatimit**  
PLANIMETRI E GJENDJES EKZISTUESE

Realizuar **JANAR 2023** | **Shkalla** 1:500

Emërtimi i Fletës  
**A 1 - 09**

# PLANIMETRI E GJENDJES EKZISTUESE SH. 1:500

## LEGJENDË

-  Aksi i Rrugës
-  Rilevimi Topografik (KUOTA)
-  Rilevimi Topografik (IZOIPSE)



Porositës:

Bashkia Malësia e Madhe

Titulli i Projektit

SISTEMIM ASFALTIM  
RRUGA KOPLIK SIPERM-LUIS

Faza

PROJEKT ZBATIMI

Vula

Autor "NOVATECH STUDIO "SHPK



Grupi projektimit:

ING. NDERTIMI	Mimoza TOMCO
ARKITEKT	Gerta NOVA
ING. HIDROTEKNIK	Klodjan NDQJ
ING. HIDROTEKNIK	Kostandin NOVA
ING. GJEOLGJIK	Antonela BAZHDARI

Vula

Kapitulli

PROJEKTI ARKITEKTONIK

Titulli i Vizatimit

PLANIMETRI E GJENDJES EKZISTUESE

Realizuar JANAR 2023 Shkalla 1:500

Emërtimi i Fletës

A 1 - 10

# PLANIMETRI E GJENDJES EKZISTUESE SH. 1:500



### Legjenda

- Shtresë Bazë
- Rendi 1 (Kufiri Tokësor)

## LEGJENDË

- Aksi i Rrugës
- Rilevimi Topografik (KUOTA)
- Rilevimi Topografik (IZOIPSE)

Porositës:

Bashkia Malësia e Madhe

Titulli i Projektit

SISTEMIM ASFALTIM  
RRUGA KOPLIK SIPERM-LUIS

Faza

PROJEKT ZBATIMI

Vula

Autor "NOVATECH STUDIO "SHPK



Grupi projektimit:

ING. NDERTIMI	Mimoza TOMCO
ARKITEKT	Gerta NOVA
ING. HIDROTEKNIK	Klodjan NDQJ
ING. HIDROTEKNIK	Kostandin NOVA
ING. GJEOLGJIK	Antonela BAZHDARI

Vula

Kapitulli

PROJEKTI ARKITEKTONIK

Titulli i Vizatimit

PLANIMETRI E GJENDJES EKZISTUESE

Realizuar **JANAR 2023** Shkalla **1:500**



Emërtimi i Fletës

**A 1 - 11**

# PLANIMETRI E GJENDJES EKZISTUESE SH. 1:500



## LEGJENDË

-  Aksi i Rrugës
-  Rilevimi Topografik (KUOTA)
-  Rilevimi Topografik (IZOIPSE)

Porositës:

**Bashkia Malësia e Madhe**

Titulli i Projektit

**SISTEMIM ASFALTIM  
RRUGA KOPLIK SIPERM-LUIS**

Faza

**PROJEKT ZBATIMI**

Vula

Autor

"NOVATECH STUDIO "SHPK  
ADMIN ING. EMIL NOVA

Grupi projektimit:

ING. NDERTIMI	Mimoza TOMCO
ARKITEKT	Gerta NOVA
ING. HIDROTEKNIK	Klodjan NDQJ
ING. HIDROTEKNIK	Kostandin NOVA
ING. GJEOLOGJIK	Antonela BAZHDARI

Vula

Kapitulli

**PROJEKTI ARKITEKTONIK**

Titulli i Vizatimit



PLANIMETRI E GJENDJES EKZISTUESE

Realizuar	<b>JANAR 2023</b>	Shkalla	<b>1:500</b>
-----------	-------------------	---------	--------------

Emërtimi i Fletës  
**A 1 - 12**

# PLANIMETRI E GJENDJES EKZISTUESE SH. 1:500

## LEGJENDË

-  Aksi i Rrugës
-  Rilevimi Topografik (KUOTA)
-  Rilevimi Topografik (IZOIPSE)

Porositës:

Bashkia Malësia e Madhe

Titulli i Projektit

SISTEMIM ASFALTIM  
RRUGA KOPLIK SIPERM-LUIS

Faza

PROJEKT ZBATIMI

Vula

Autor "NOVATECH STUDIO "SHPK



Grupi projektimit:

ING. NDERTIMI	Mimoza TOMCO
ARKITEKT	Gerta NOVA
ING. HIDROTEKNIK	Klodjan NDQJ
ING. HIDROTEKNIK	Kostandin NOVA
ING. GJEOLGJIK	Antonela BAZHDARI

Vula

Kapitulli

PROJEKTI ARKITEKTONIK

Titulli i Vizatimit

PLANIMETRI E GJENDJES EKZISTUESE

Realizuar **JANAR 2023** Shkalla **1:500**

Emërtimi i Fletës

**A 1 - 13**



PLANIMETRI SH. 1:250

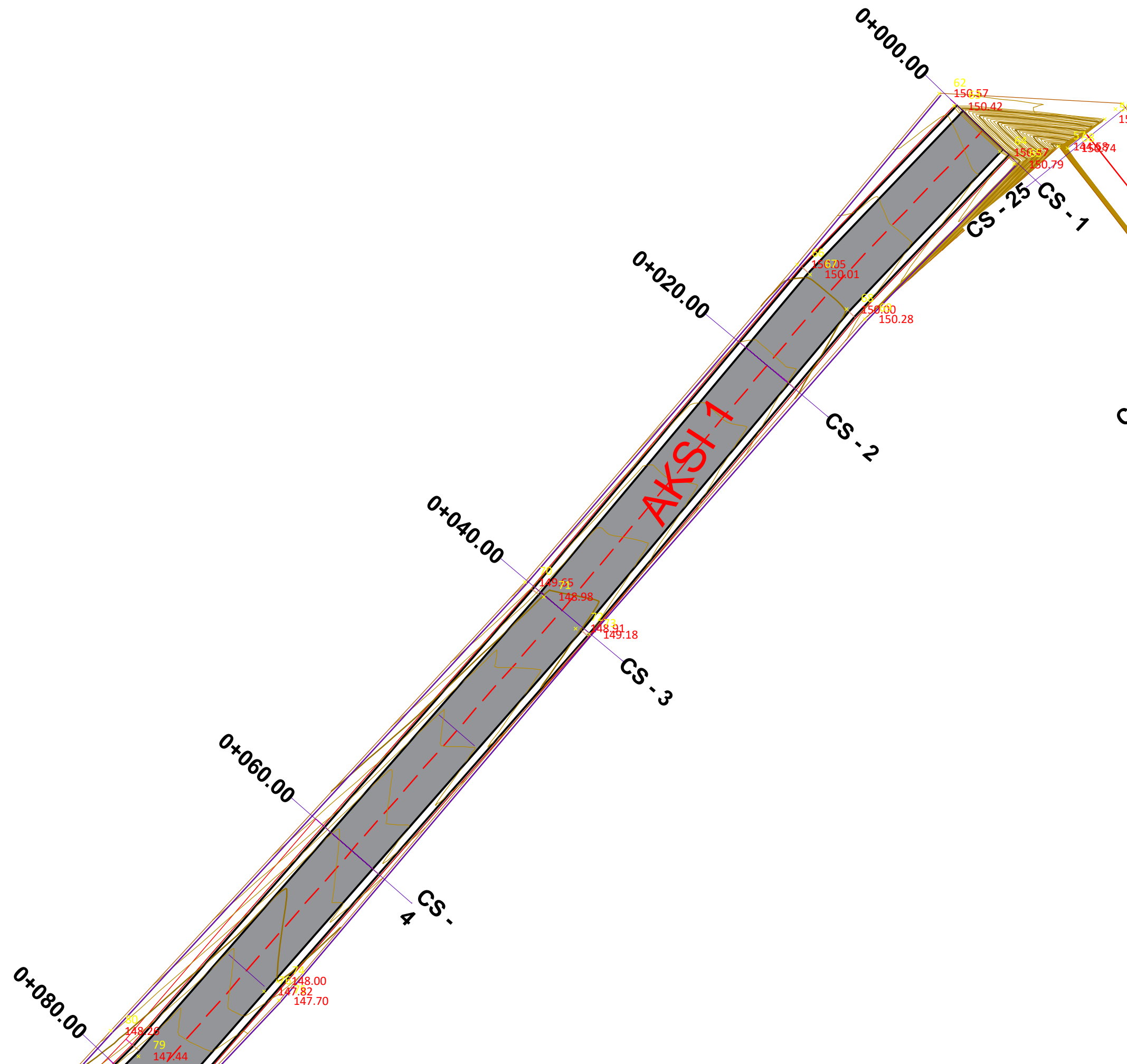

LEGJENDË

- Aksi i Rrugës
- Rilevimi Topografik (KUOTA)
- Rilevimi Topografik (IZOIPSE)
- Asfaltobeton
- Bankine
- Bankine betoni
- Mure Ekzistuese

Porositës:

Bashkia Malësia e Madhe

Titulli i Projektit

SISTEMIM ASFALTIM  
RRUGA KOPLIK SIPERM-LUIS

Faza

PROJEKT ZBATIMI

Vula

Autor

"NOVATECH STUDIO "SHPK



ADMIN ING. EMIL NOVA

Grupi projektimit:

ING. NDERTIMI	Mimoza TOMCO
ARKITEKT	Gerta NOVA
ING. HIDROTEKNIK	Klodjan NDQJ
ING. HIDROTEKNIK	Kostandin NOVA
ING. GJEOLGJIK	Antonela BAZHDARI

Vula

Kapitulli

PROJEKTI ARKITEKTONIK

Titulli i Vizatimit

PLANIMETRI

Realizuar **JANAR 2023** | Shkalla **1:250**

Emërtimi i Fletës

**A 1 - 14**

# PLANIMETRI SH. 1:250

## LEGJENDË

-  Aksi i Rrugës
-  Rilevimi Topografik (KUOTA)
-  Rilevimi Topografik (IZOIPSE)
-  Asfaltobeton
-  Bankine
-  Bankine betoni
-  Mure Ekzistuese

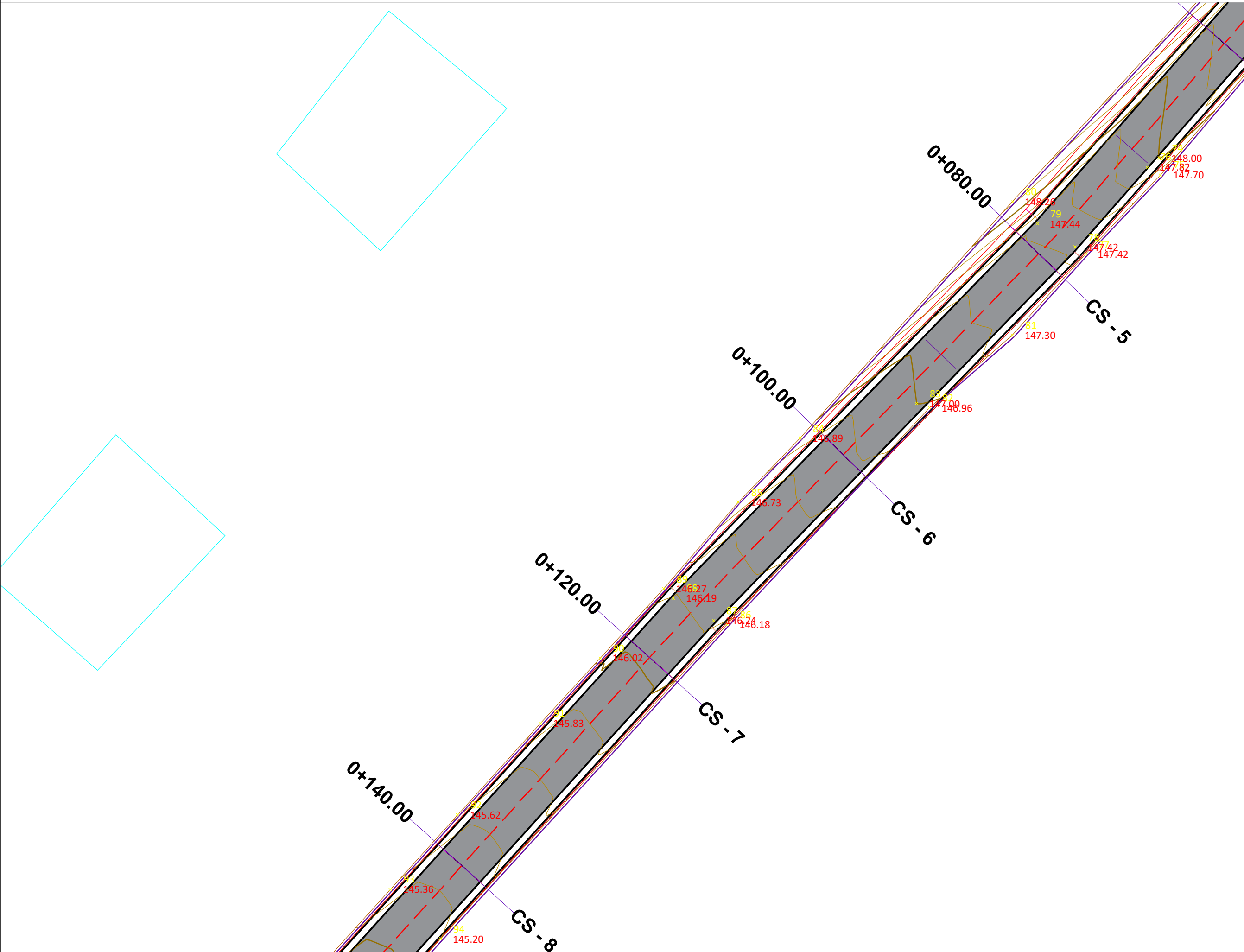

Porositës:

**Bashkia Malësia e Madhe**

Titulli i Projektit

**SISTEMIM ASFALTIM  
RRUGA KOPLIK SIPERM-LUIS**

Faza

**PROJEKT ZBATIMI**

Vula

Autor "NOVATECH STUDIO "SHPK



Grupi projektimit:

ING. NDERTIMI	Mimoza TOMCO
ARKITEKT	Gerta NOVA
ING. HIDROTEKNIK	Klodjan NDOJ
ING. HIDROTEKNIK	Kostandin NOVA
ING. GJEOLGJIK	Antonela BAZHDARI

Vula

Kapitulli

**PROJEKTI ARKITEKTONIK**

Titulli i Vizatimit

PLANIMETRI

Realizuar **JANAR 2023** Shkalla **1:250**

Emërtimi i Fletës

**A 1 - 15**



PLANIMETRI SH. 1:250



LEGJENDË

- Aksi i Rrugës
- Rilevimi Topografik (KUOTA)
- Rilevimi Topografik (IZOIPSE)
- Asfaltobeton
- Bankine
- Bankine betoni
- Mure Ekzistuese

Porositës:

Bashkia Malësia e Madhe

Titulli i Projektit

SISTEMIM ASFALTIM  
RRUGA KOPLIK SIPERM-LUIS

Faza

PROJEKT ZBATIMI

Vula

Autor "NOVATECH STUDIO "SHPK



ADMIN ING. EMIL NOVA

Grupi projektimit:

ING. NDERTIMI	Mimoza TOMCO
ARKITEKT	Gerta NOVA
ING. HIDROTEKNIK	Klodjan NDQJ
ING. HIDROTEKNIK	Kostandin NOVA
ING. GJEOLGJIK	Antonela BAZHDARI

Vula

Kapitulli

PROJEKTI ARKITEKTONIK

Titulli i Vizatimit

PLANIMETRI

Realizuar **JANAR 2023** | Shkalla **1:250**

Emërtimi i Fletës

**A 1 - 16**

# PLANIMETRI SH. 1:250

## LEGJENDË

-  Aksi i Rrugës
-  Rilevimi Topografik (KUOTA)
-  Rilevimi Topografik (IZOIPSE)
-  Asfaltobeton
-  Bankine
-  Bankine betoni
-  Mure Ekzistuese

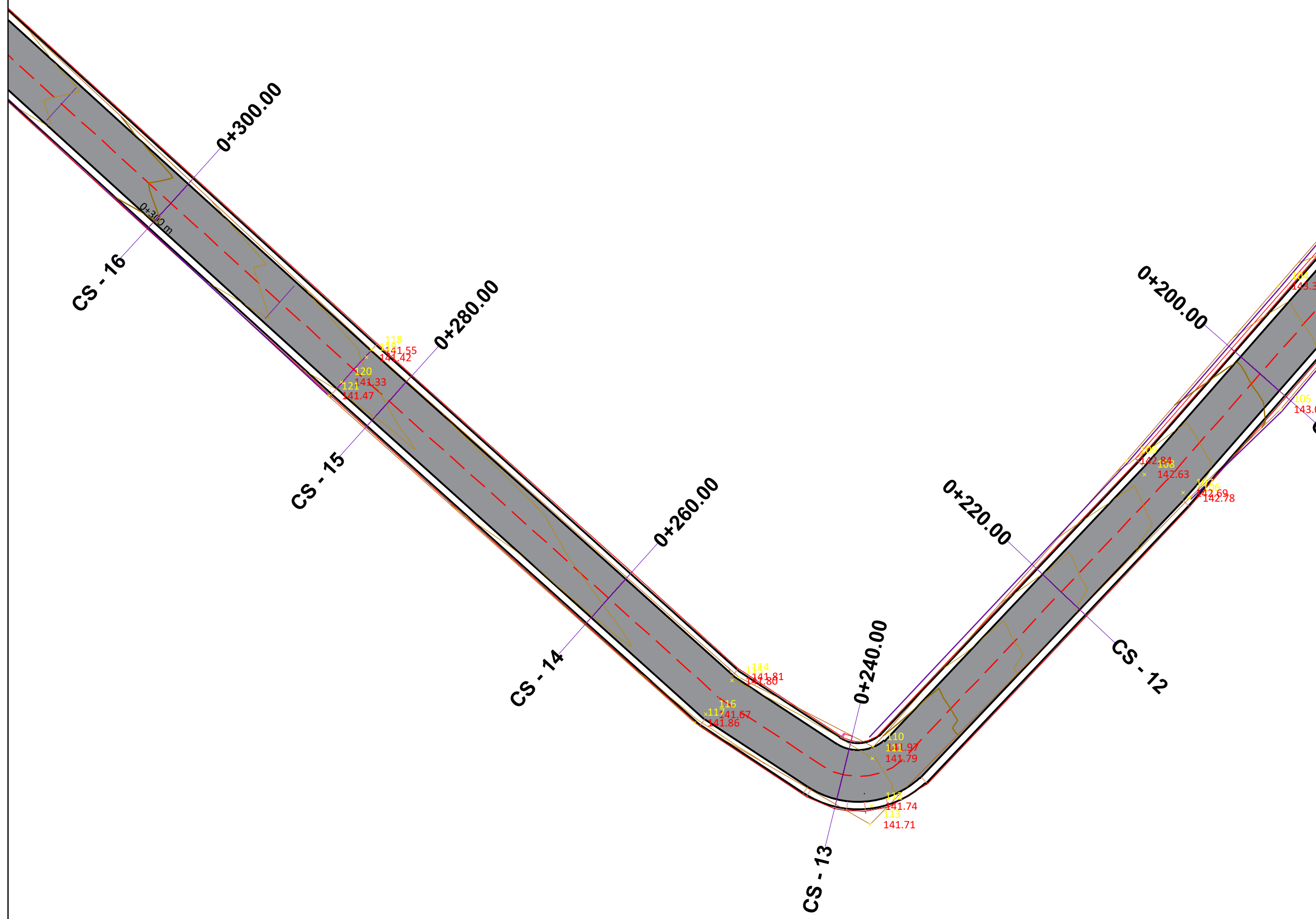

<b>Porositës:</b>	
<b>Bashkia Malësia e Madhe</b>	
<b>Titulli i Projektit</b>	
<b>SISTEMIM ASFALTIM RRUGA KOPLIK SIPERM-LUIS</b>	
<b>Faza</b>	
<b>PROJEKT ZBATIMI</b>	
<b>Vula</b>	
<b>Autor</b>	
"NOVATECH STUDIO "SHPK  ADMIN ING. EMIL NOVA	
<b>Grupi projektimit:</b>	
ING. NDERTIMI	Mimoza TOMCO
ARKITEKT	Gerta NOVA
ING. HIDROTEKNIK	Klodjan NDOJ
ING. HIDROTEKNIK	Kostandin NOVA
ING. GJEOLGJIK	Antonela BAZHDARI
<b>Vula</b>	
<b>Kapitulli</b>	
<b>PROJEKTI ARKITEKTONIK</b>	
<b>Titulli i Vizatimit</b>	
PLANIMETRI	
Realizuar	Shkalla
<b>JANAR 2023</b>	<b>1:250</b>
Emërtimi i Fletës	
<b>A 1 - 17</b>	

# PLANIMETRI SH. 1:250

## LEGJENDË

-  Aksi i Rrugës
-  Rilevimi Topografik (KUOTA)
-  Rilevimi Topografik (IZOIPSE)
-  Asfaltobeton
-  Bankine
-  Bankine betoni
-  Mure Ekzistuese

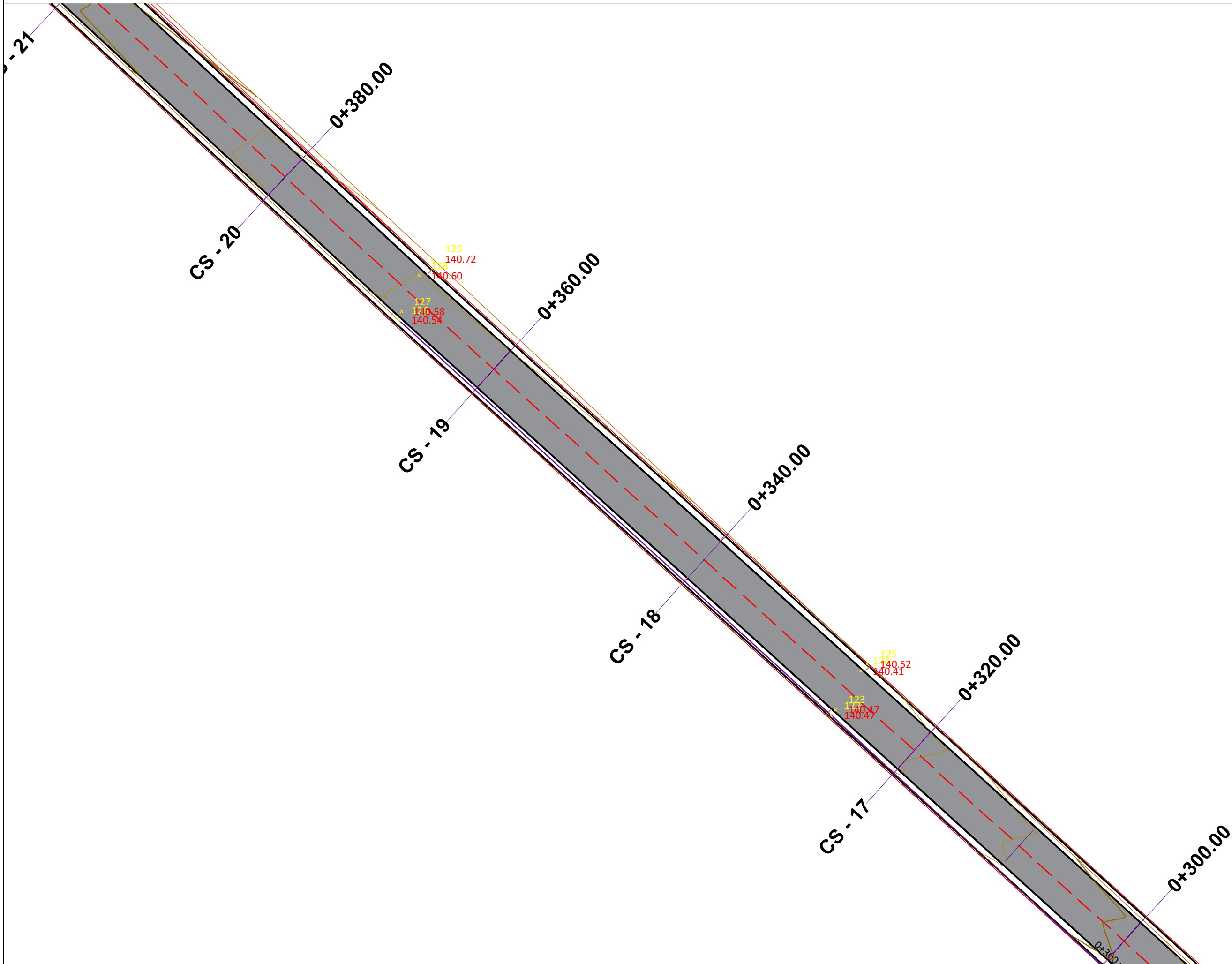

<b>Porositës:</b>	
<b>Bashkia Malësia e Madhe</b>	
<b>Titulli i Projektit</b>	
<b>SISTEMIM ASFALTIM RRUGA KOPLIK SIPERM-LUIS</b>	
<b>Faza</b>	
<b>PROJEKT ZBATIMI</b>	
<b>Vula</b>	
<b>Autor</b>	
"NOVATECH STUDIO "SHPK  ADMIN ING. EMIL NOVA	
<b>Grupi projektimit:</b>	
ING. NDERTIMI	Mimoza TOMCO
ARKITEKT	Gerta NOVA
ING. HIDROTEKNIK	Klodjan NDQJ
ING. HIDROTEKNIK	Kostandin NOVA
ING. GJEOLOGJIK	Antonela BAZHDARI
<b>Vula</b>	
<b>Kapitulli</b>	
<b>PROJEKTI ARKITEKTONIK</b>	
<b>Titulli i Vizatimit</b>	
PLANIMETRI	
Realizuar	Shkalla
<b>JANAR 2023</b>	<b>1:250</b>
Emërtimi i Fletës	
<b>A 1 - 18</b>	



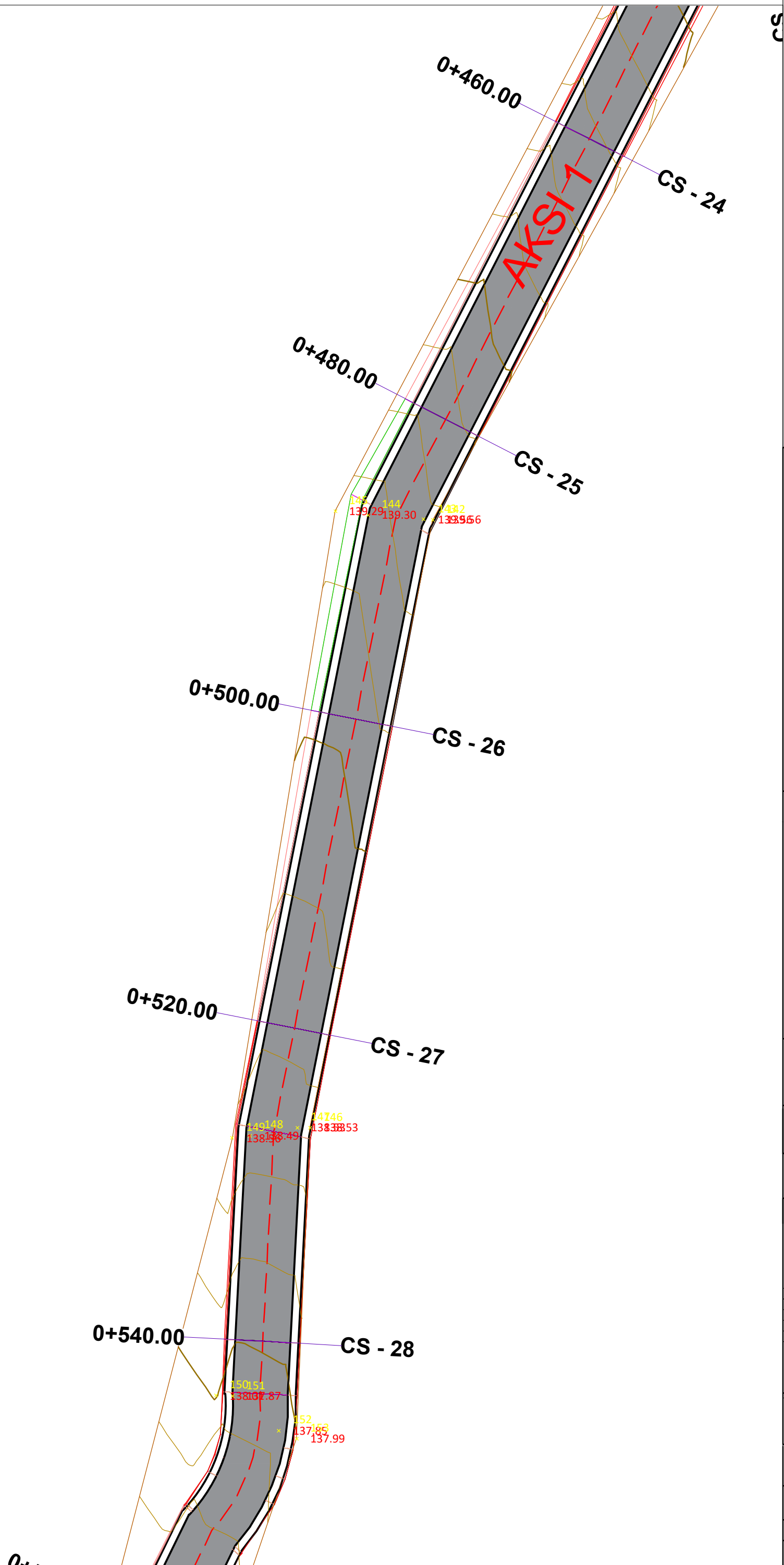

**LEGJENDË**

	Aksi i Rugës
	Rilevimi Topografik (KUOTA)
	Rilevimi Topografik (IZOIPSE)
	Asfaltobeton
	Bankine
	Bankine betoni
	Mure Ekzistuese
	Ndertesa Ekzistuese

Porositës:  
**Bashkia Malësia e Madhe**

Titulli i Projektit  
**SISTEMIM ASFALTIM RRUGA KOPLIK SIPERM -LUIS**

Faza  
**PROJEKT ZBATIMI**

Vula  
Autor: "NOVATECH STUDIO "SHPK"  
  
ADMIN ING. EMIL NOVA

Grupi projektimit:

ING. NDERTIMI	Mimoza TOMCO
ARKITEKT	Gerla NOVA
ING. HIDROTEKNIK	Klodjon NDDJ
ING. HIDROTEKNIK	Kostandin NOVA
ING. GJEOLGJIK	Antoneia BAZHDARI

Vula

Kapitulli  
**PROJEKTI ARKITEKTONIK**

Titulli i Vizatimit  
PLANIMETRIA

Realizuar <b>JANAR 2023</b>	Shkalla <b>1:250</b>
--------------------------------	-------------------------

Emërtimi i Fletës  
**A 1 - 20**

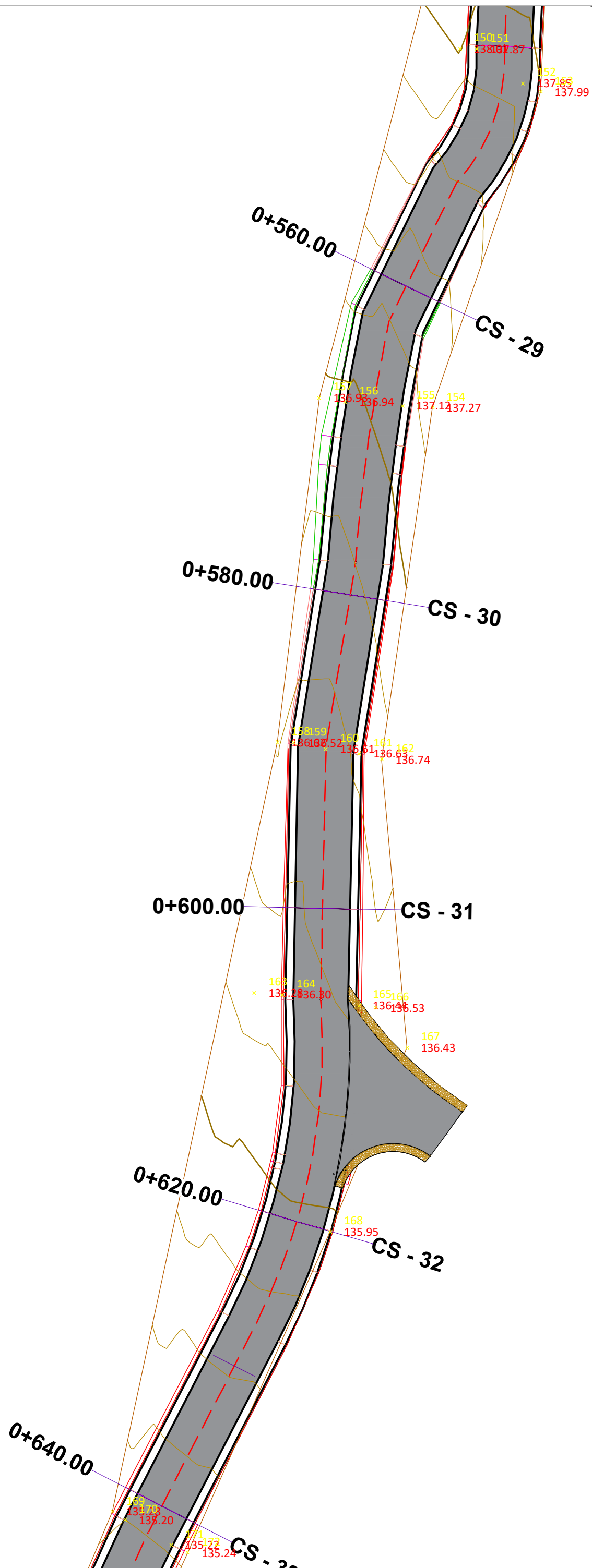

LEGJENDË

- Aksi i Rugës
- Rilevimi Topografik (KUOTA)
- Rilevimi Topografik (IZOIPSE)
- Asfaltobeton
- Bankine
- Bankine betoni
- Mure Ekzistuese
- Ndertesa Ekzistuese

Porositës:

Bashkia Malësia e Madhe

Titulli i Projektit

SISTEMIM ASFALTIM  
RRUGA KOPLIK SIPERM -LUIS

Faza

PROJEKT ZBATIMI

Vula

Autor "NOVATECH STUDIO "SHPK

ADMIN ING. EMIL NOVA

Grupi projektimit:

ING. NDERTIMI	Mimoza TOMCO
ARKITEKT	Gerla NOVA
ING. HIDROTEKNIK	Klodjan NDDJ
ING. HIDROTEKNIK	Kostandin NOVA
ING. GJEOLGJIK	Antoneia BAZHDARI

Vula

Kapitulli

PROJEKTI ARKITEKTONIK

Titulli i Vizatimit

PLANIMETRIA

Realizuar JANAR 2023

Shkalla 1:250

Emërtimi i Fletës

A 1 - 21

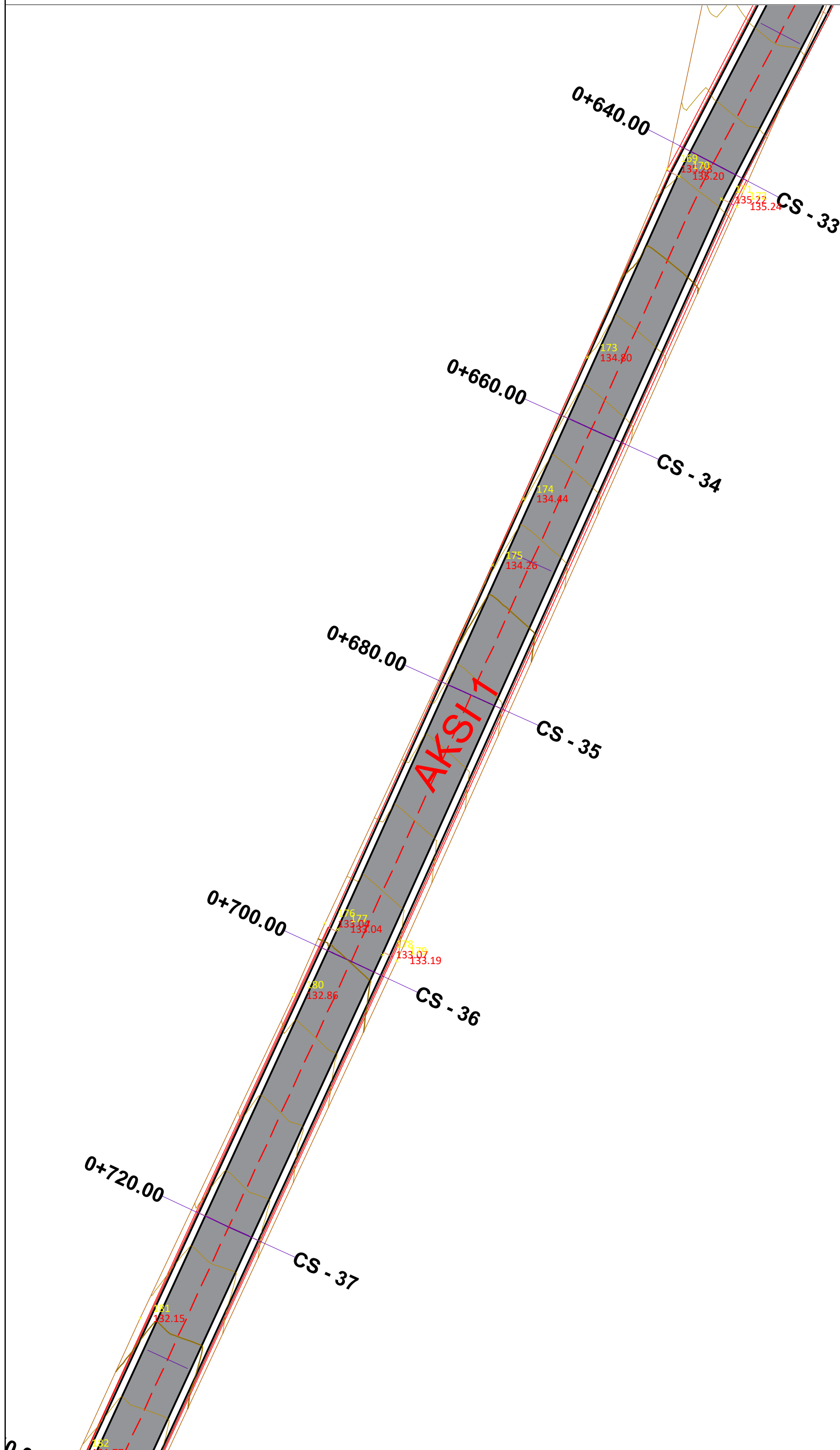

LEGJENDË

	Aksi i Rrugës
	Rilevimi Topografik (KUOTA)
	Rilevimi Topografik (IZOIPSE)
	Asfaltobeton
	Bankine
	Bankine betoni
	Mure Ekzistuese
	Ndertesa Ekzistuese

Porositës:  
**Bashkia Malësia e Madhe**

Titulli i Projektit  
**SISTEMIM ASFALTIM RRUGA KOPLIK SIPERM -LUIS**

Faza  
**PROJEKT ZBATIMI**

Vula  
Autor "NOVATECH STUDIO "SHPK"  
  
ADMIN ING. EMIL NOVA

Grupi projektimit:

ING. NDERTIMI	Mimoza TOMCO
ARKITEKT	Gerla NOVA
ING. HIDROTEKNIK	Klodjan NDDJ
ING. HIDROTEKNIK	Kostandin NOVA
ING. GJEOLGJIK	Antoneia BAZHDARI

Vula  
Kapitulli  
**PROJEKTI ARKITEKTONIK**

Titulli i Vizatimit  
PLANIMETRIA

Realizuar **JANAR 2023** Shkalla **1:250**  
Emërtimi i Fletës  
**A 1 - 22**

PLANIMETRIA SH. 1:250

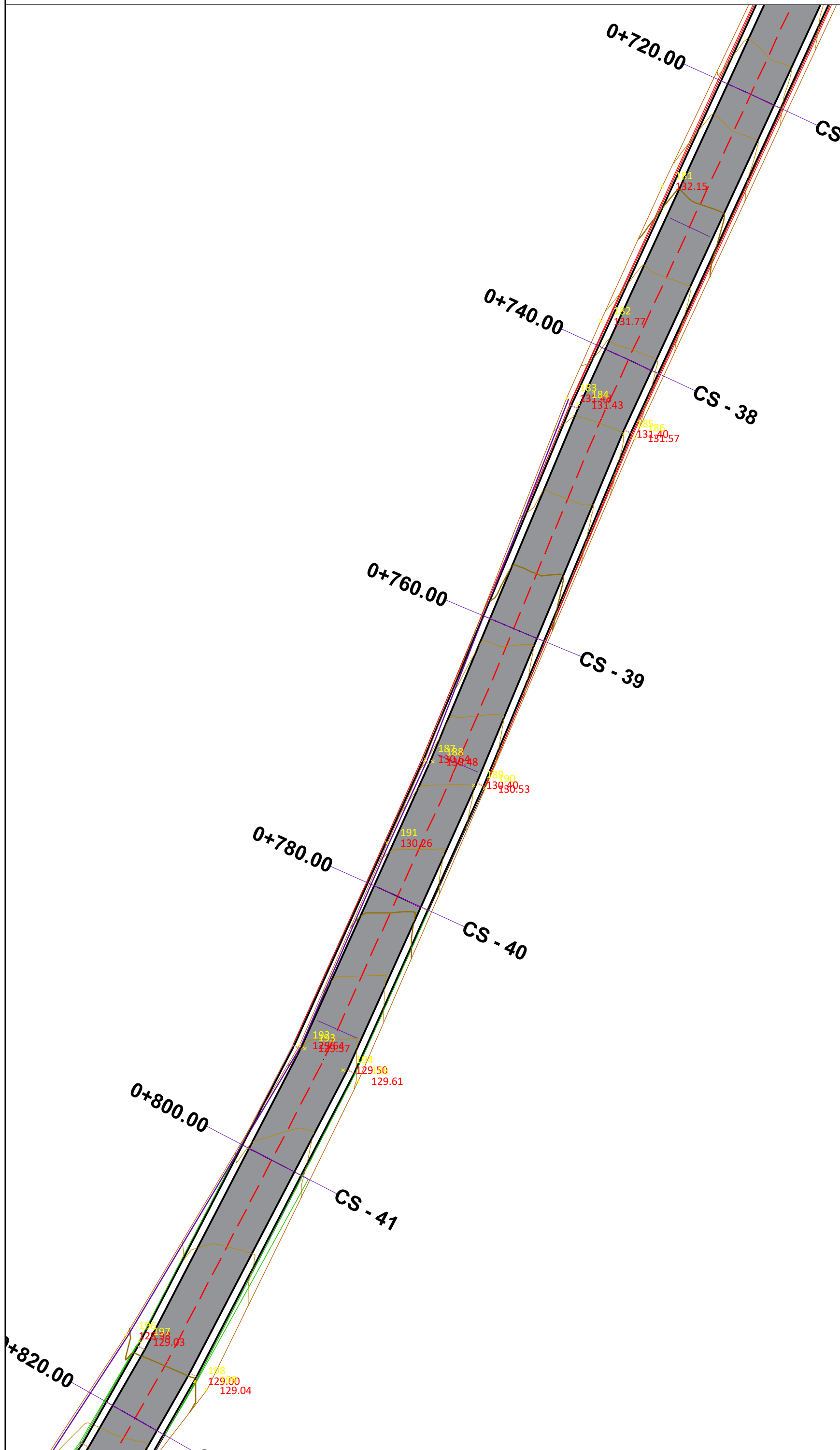

LEGJENDË

- Aksi i Rugës
- Rilevimi Topografik (KUOTA)
- Rilevimi Topografik (IZOIPSE)
- Asfaltobeton
- Bankine
- Bankine betoni
- Mure Ekzistuese
- Ndertesa Ekzistuese

Porositës:

Bashkia Malësia e Madhe

Titulli i Projektit

SISTEMIM ASFALTIM  
RRUGA KOPLIK SIPERM -LUIS

Faza

PROJEKT ZBATIMI

Vula

Autor "NOVATECH STUDIO "SHPK

ADMIN ING. EMIL NOVA

Grupi projektimit:

ING. NDERTIMI	Mimoza TOMCO
ARKITEKT	Gerla NOVA
ING. HIDROTEKNIK	Klodjan NDDJ
ING. HIDROTEKNIK	Kostandin NOVA
ING. GJEOLGJIK	Antoneia BAZHDARI

Vula

Kapitulli

PROJEKTI ARKITEKTONIK

Titulli i Vizatimit

PLANIMETRIA

Realizuar  
**JANAR 2023**

Shkalla  
**1:250**

Emërtimi i Fletës

**A 1 - 23**



PLANIMETRIA SH. 1:250



LEGJENDË

- Aksi i Rugës
- Rilevimi Topografik (KUOTA)
- Rilevimi Topografik (IZOIPSE)
- Asfaltobeton
- Bankine
- Bankine betoni
- Mure Ekzistuese
- Ndertesa Ekzistuese

Porositës:

Bashkia Malësia e Madhe

Titulli i Projektit

SISTEMIM ASFALTIM  
RRUGA KOPLIK SIPERM -LUIS

Faza

PROJEKT ZBATIMI

Vula

Autor "NOVATECH STUDIO "SHPK

  
ADMIN ING. EMIL NOVA

Grupi projektimit:

ING. NDERTIMI	Mimoza TOMCO
ARKITEKT	Gerla NOVA
ING. HIDROTEKNIK	Klodjan NDDJ
ING. HIDROTEKNIK	Kostandin NOVA
ING. GJEOLGJIK	Antoneia BAZHDARI

Vula

Kapitulli

PROJEKTI ARKITEKTONIK

Titulli i Vizatimit

PLANIMETRIA

Realizuar  
**JANAR 2023**

Shkalla  
**1:250**

Emërtimi i Fletës

**A 1 - 24**

# PLANIMETRI SH. 1:250



## LEGJENDË

- Aksi i Rrugës
- Rilevimi Topografik (KUOTA)
- Rilevimi Topografik (IZOIPSE)
- Asfaltobeton
- Bankine
- Bankine betoni
- Mure Ekzistuese

### Porositës:

Bashkia Malësia e Madhe

### Titulli i Projektit

SISTEMIM ASFALTIM  
RRUGA KOPLIK SIPERM-LUIS

### Faza

PROJEKT ZBATIMI

### Vula

Autor "NOVATECH STUDIO "SHPK

ADMIN ING. EMIL NOVA

### Grupi projektimit:

ING. NDERTIMI	Mimoza TOMCO
ARKITEKT	Gerta NOVA
ING. HIDROTEKNIK	Klodjan NDOJ
ING. HIDROTEKNIK	Kostandin NOVA
ING. GJEOLGJIK	Antonela BAZHDARI

### Vula

### Kapitulli

PROJEKTI ARKITEKTONIK

### Titulli i Vizatimit

PLANIMETRI

Realizuar	JANAR 2023	Shkalla	1:250
-----------	------------	---------	-------

Emërtimi i Fletës

**A 1 - 25**

PLANIMETRI SH. 1:250

LEGJENDË

-  Aksi i Rrugës
-  Rilevimi Topografik (KUOTA)
-  Rilevimi Topografik (IZOIPSE)
-  Asfaltbeton
-  Bankine
-  Bankine betoni
-  Mure Ekzistuese

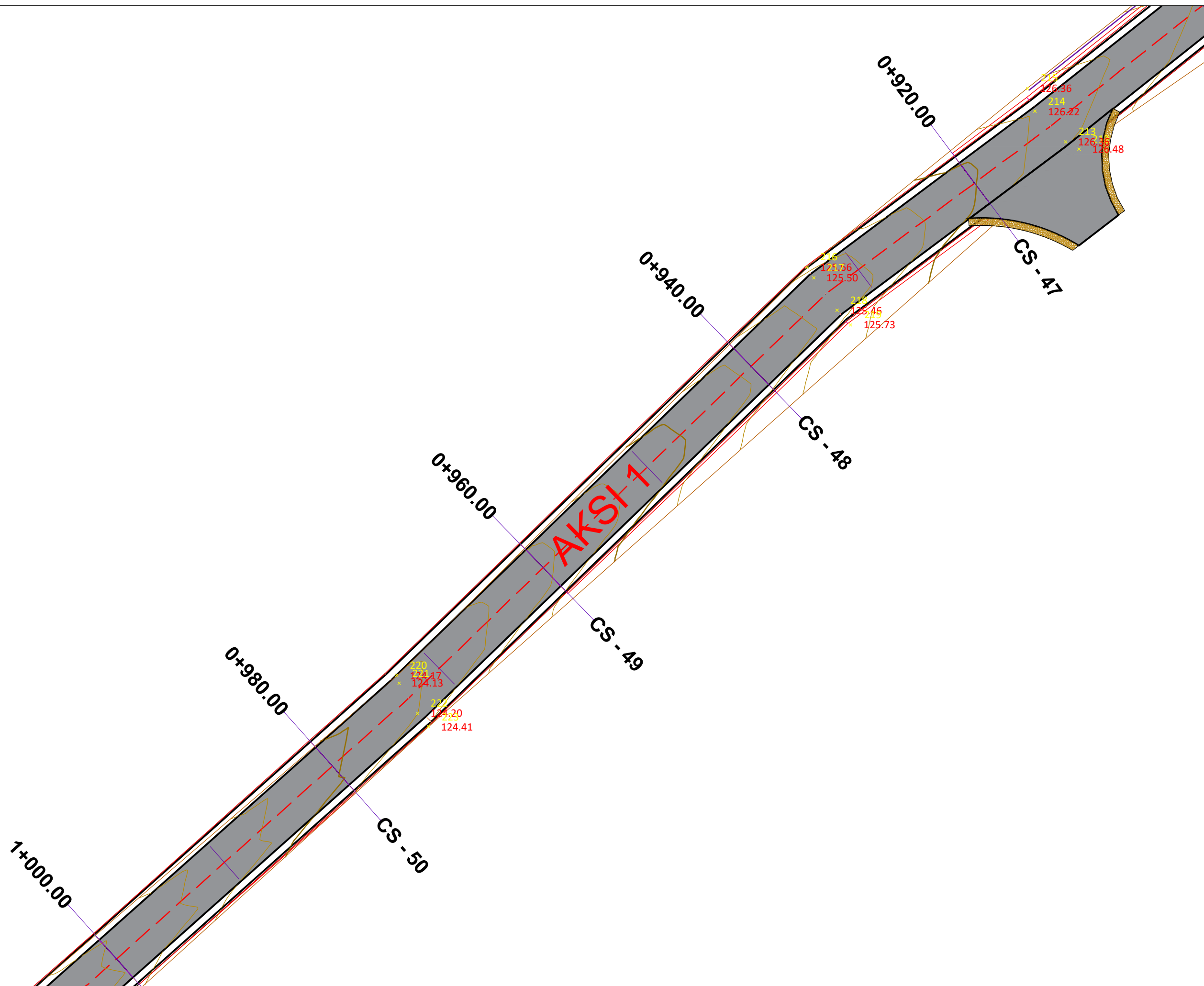

Porositës:  
**Bashkia Malësia e Madhe**

Titulli i Projektit  
**SISTEMIM ASFALTIM  
RRUGA KOPLIK SIPERM-LUIS**

Faza  
**PROJEKT ZBATIMI**

Vula  
Autor "NOVATECH STUDIO "SHPK"  
  
ADMIN ING. EMIL NOVA

Grupi projektimit:  

ING. NDERTIMI	Mimoza TOMCO
ARKITEKT	Gerta NOVA
ING. HIDROTEKNIK	Klodjan NDQJ
ING. HIDROTEKNIK	Kostandin NOVA
ING. GJEOLGJIK	Antonela BAZHDARI

Kapitulli  
**PROJEKTI ARKITEKTONIK**

Titulli i Vizatimit  
PLANIMETRI

Realizuar <b>JANAR 2023</b>	Shkalla <b>1:250</b>
--------------------------------	-------------------------

Emërtimi i Fletës  
**A 1 - 26**

# PLANIMETRI SH. 1:250

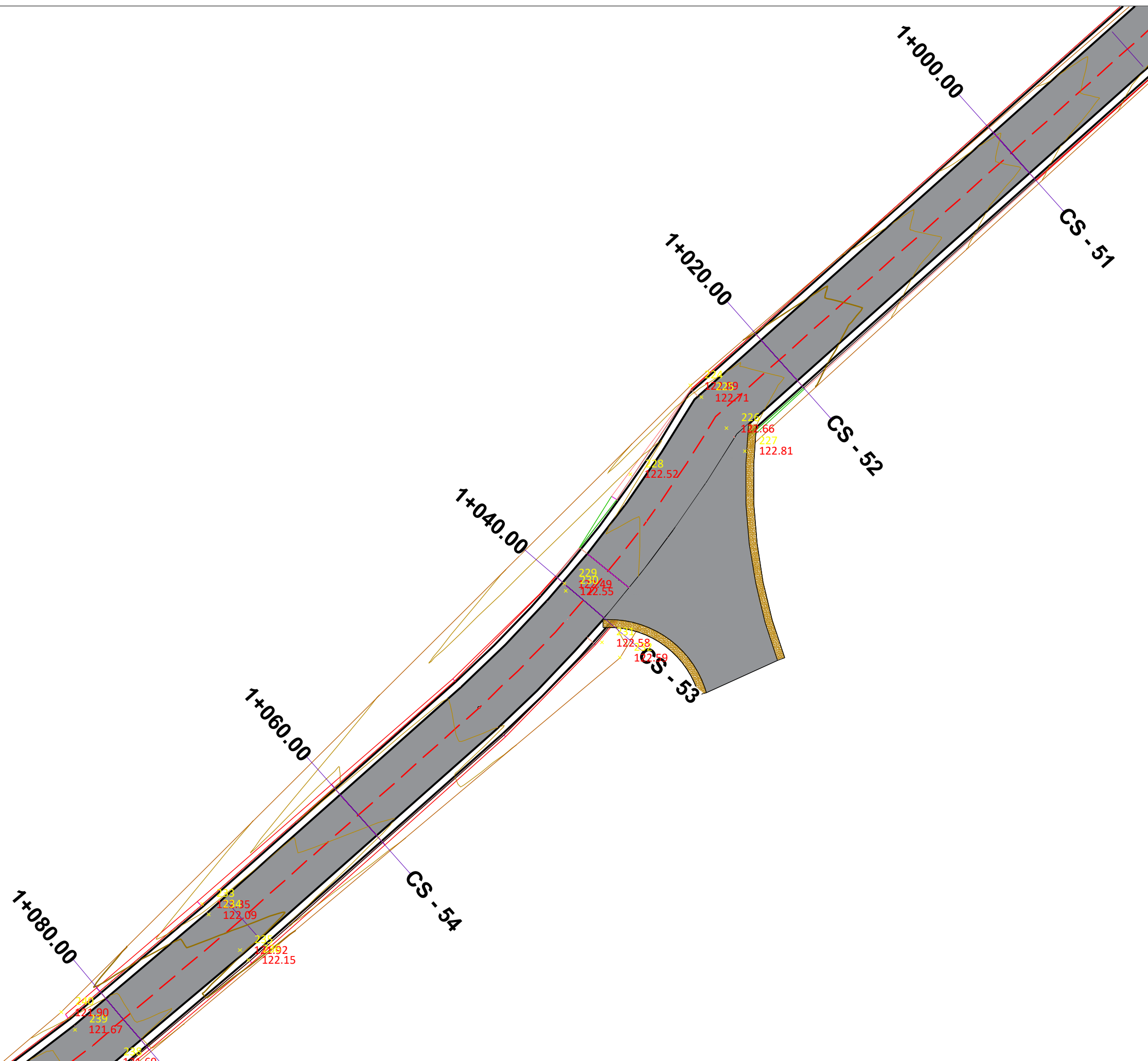

## LEGJENDË

- Aksi i Rrugës
- Rilevimi Topografik (KUOTA)
- Rilevimi Topografik (IZOIPSE)
- Asfaltobeton
- Bankine
- Bankine betoni
- Mure Ekzistuese

### Porositës:

Bashkia Malësia e Madhe

### Titulli i Projektit

SISTEMIM ASFALTIM  
RRUGA KOPLIK SIPERM-LUIS

### Faza

PROJEKT ZBATIMI

### Vula

Autor "NOVATECH STUDIO "SHPK

ADMIN ING. EMIL NOVA

### Grupi projektimit:

ING. NDERTIMI	Mimoza TOMCO
ARKITEKT	Gerta NOVA
ING. HIDROTEKNIK	Klodjan NDQJ
ING. HIDROTEKNIK	Kostandin NOVA
ING. GJEOLGJIK	Antonela BAZHDARI

### Vula

### Kapitulli

PROJEKTI ARKITEKTONIK

### Titulli i Vizatimit

PLANIMETRI

Realizuar **JANAR 2023** Shkalla **1:250**

Emërtimi i Fletës

**A 1 - 27**

PLANIMETRI SH. 1:250

LEGJENDË

-  Aksi i Rrugës
-  Rilevimi Topografik (KUOTA)
-  Rilevimi Topografik (IZOIPSE)
-  Asfaltobeton
-  Bankine
-  Bankine betoni
-  Mure Ekzistuese

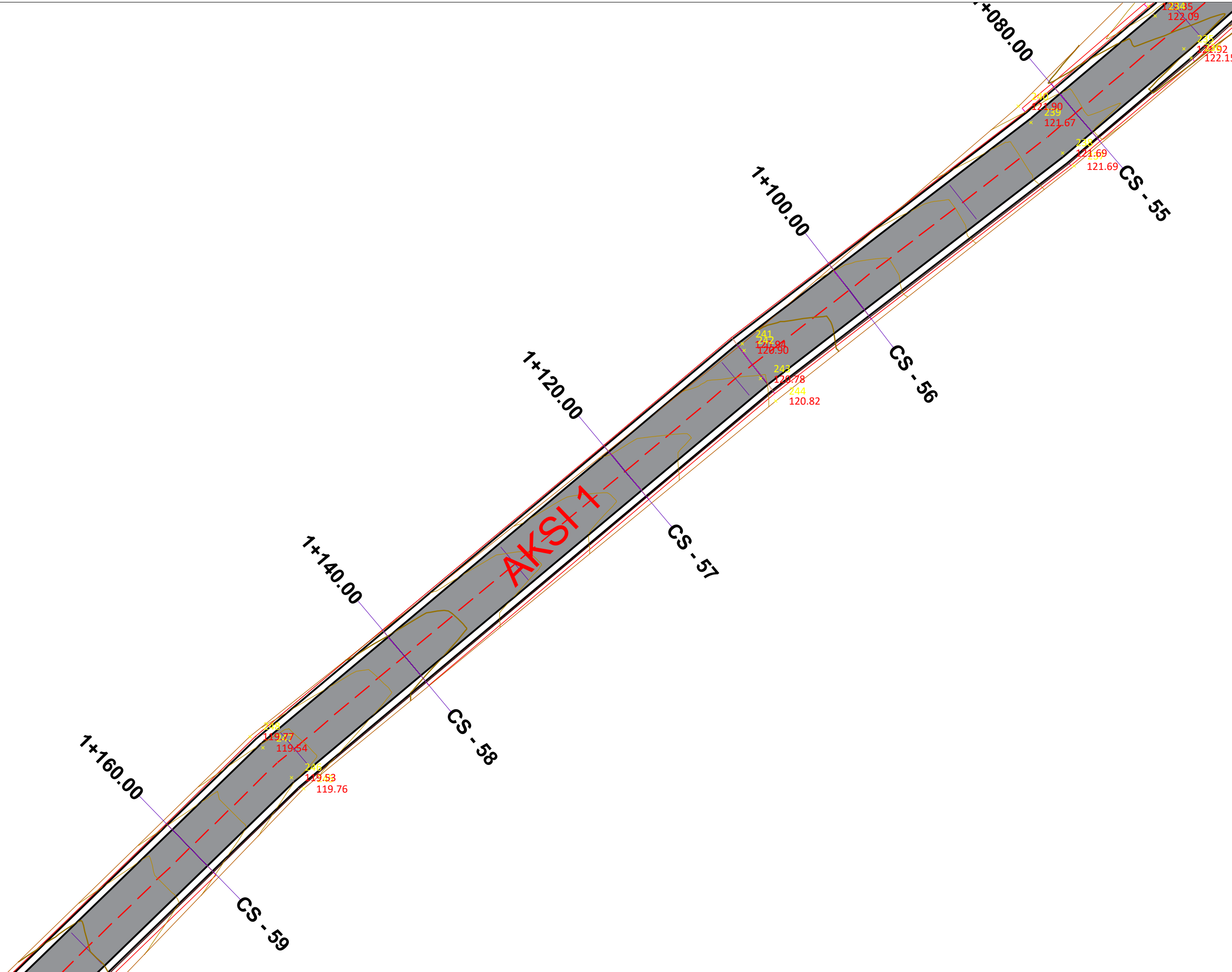

Porositës:

Bashkia Malësia e Madhe

Titulli i Projektit

SISTEMIM ASFALTIM  
RRUGA KOPLIK SIPERM-LUIS

Faza

PROJEKT ZBATIMI

Vula

Autor

"NOVATECH STUDIO "SHPK  
ADMIN ING. EMIL NOVA

Grupi projektimit:

ING. NDERTIMI	Mimoza TOMCO
ARKITEKT	Gerta NOVA
ING. HIDROTEKNIK	Klodjan NDQJ
ING. HIDROTEKNIK	Kostandin NOVA
ING. GJEOLGJIK	Antonela BAZHDARI

Vula

Kapitulli

PROJEKTI ARKITEKTONIK

Titulli i Vizatimit

PLANIMETRI

Realizuar

JANAR 2023 Shkalla 1:250

Emërtimi i Fletës

A 1 - 28

# PLANIMETRI SH. 1:250

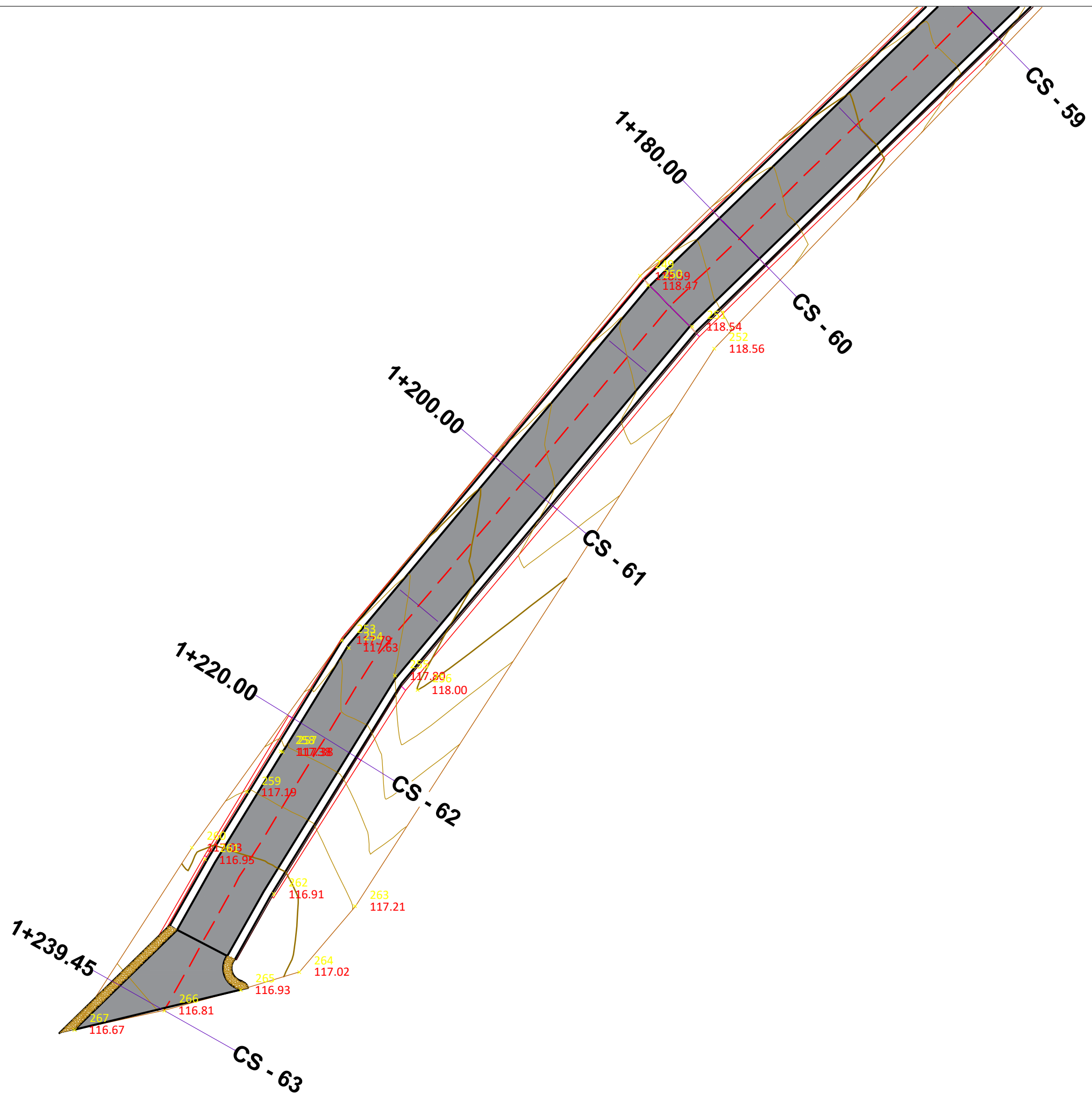

## LEGJENDË

- Aksi i Rrugës
- Rilevimi Topografik (KUOTA)
- Rilevimi Topografik (IZOIPSE)
- Asfaltobeton
- Bankine
- Bankine betoni
- Mure Ekzistuese

### Porositës:

Bashkia Malësia e Madhe

### Titulli i Projektit

SISTEMIM ASFALTIM  
RRUGA KOPLIK SIPERM-LUIS

### Faza

PROJEKT ZBATIMI

### Vula

Autor "NOVATECH STUDIO "SHPK

ADMIN ING. EMIL NOVA

### Grupi projektimit:

ING. NDERTIMI	Mimoza TOMCO
ARKITEKT	Gerta NOVA
ING. HIDROTEKNIK	Klodjan NDQJ
ING. HIDROTEKNIK	Kostandin NOVA
ING. GJEOLGJIK	Antonela BAZHDARI

### Vula

### Kapitulli

PROJEKTI ARKITEKTONIK

### Titulli i Vizatimit

PLANIMETRI

Realizuar	JANAR 2023	Shkalla	1:250
-----------	------------	---------	-------

Emërtimi i Fletës

**A 1 - 29**

PLANIMETRI - AKSI II SH. 1:250

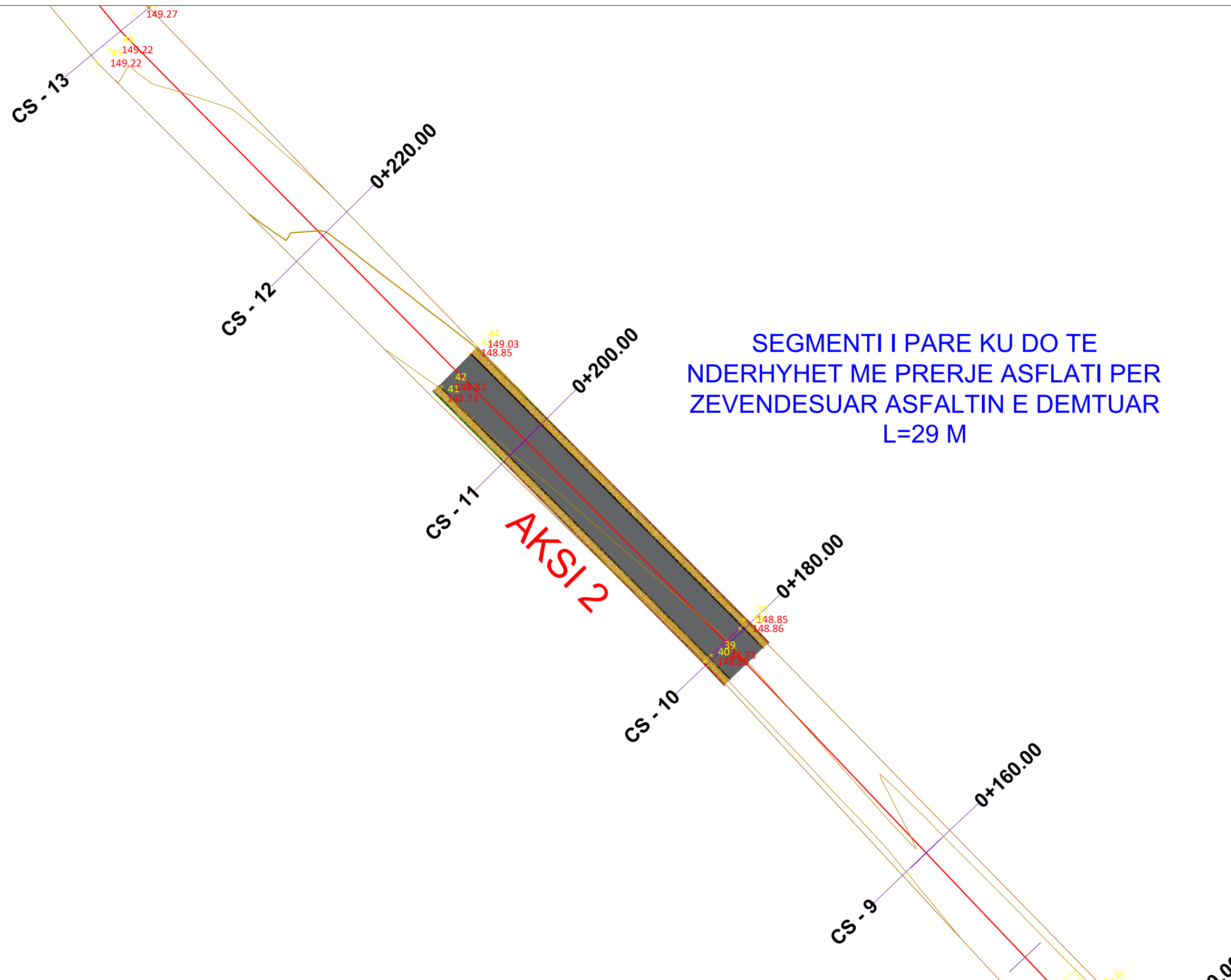

LEGJENDË

- Aksi i Rrugës
- Rilevimi Topografik (KUOTA)
- Rilevimi Topografik (IZOIPSE)
- Asfaltobeton
- Bankine
- Bankine betoni
- Mure Ekzistuese

Porositës:

Bashkia Malësia e Madhe

Titulli i Projektit

SISTEMIM ASFALTIM  
RRUGA KOPLIK SIPERM-LUIS

Faza

PROJEKT ZBATIMI

Vula

Autor "NOVATECH STUDIO "SHPK



Grupi projektimit:

ING. NDERTIMI	Mimoza TOMCO
ARKITEKT	Gerta NOVA
ING. HIDROTEKNIK	Klodjan NDQJ
ING. HIDROTEKNIK	Kostandin NOVA
ING. GJEOLOGJIK	Antonela BAZHDARI

Vula

Kapitulli

PROJEKTI ARKITEKTONIK

Titulli i Vizatimit

PLANIMETRI - AKSI II

Realizuar **JANAR 2023** | Shkalla **1:250**

Emërtimi i Fletës

**A 1 - 30**

PLANIMETRI - AKSI II SH. 1:250

CS-

CS-7 0+120.00

CS-6 0+100.00

AKSI 2

CS-5 0+080.00

CS-4 0+060.00

0+040.00

SEGMENTI II KU DO TE NDERHYHET ME PRERJE ASFLATI PER ZEVENDESUAR ASFALTIN E DENTUAR L= 72 M

LEGJENDË

-  Aksi i Rrugës
-  Rilevimi Topografik (KUOTA)
-  Rilevimi Topografik (IZOIPSE)
-  Asfaltobeton
-  Bankine
-  Bankine betoni
-  Mure Ekzistuese

Porositës:

Bashkia Malësia e Madhe

Titulli i Projektit

SISTEMIM ASFALTIM RRUGA KOPLIK SIPERM-LUIS

Faza

PROJEKT ZBATIMI

Vula

Autor "NOVATECH STUDIO "SHPK

ADMIN ING. EMIL NOVA

Grupi projektimit:

ING. NDERTIMI	Mimoza TOMCO
ARKITEKT	Gerta NOVA
ING. HIDROTEKNIK	Klodjan NDQJ
ING. HIDROTEKNIK	Kostandin NOVA
ING. GJEOLGJIK	Antonela BAZHDARI

Vula

Kapitulli

PROJEKTI ARKITEKTONIK

Titulli i Vizatimit

PLANIMETRI - AKSI II

Realizuar JANAR 2023 Shkalla 1:250

Emërtimi i Fletës

A 1 - 31



PLANIMETRI - AKSI II SH. 1:250

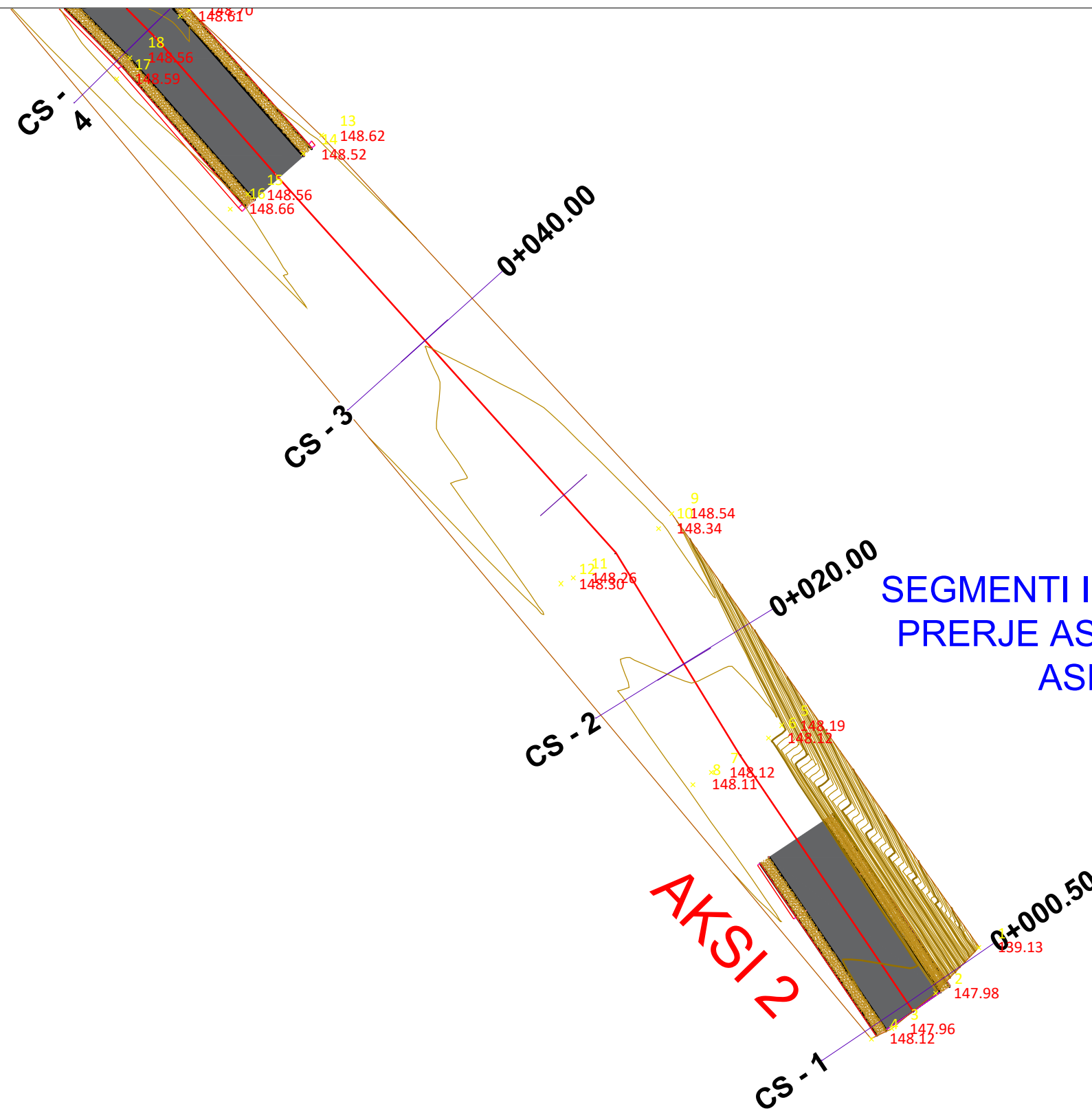

SEGMENTI III KU DO TE NDERHYHET ME PRERJE ASFLATI PER ZEVENDESUAR ASFALTIN E DEMTUAR L= 10 M

LEGJENDË

- Aksi i Rrugës
- Rilevimi Topografik (KUOTA)
- Rilevimi Topografik (IZOIPSE)
- Asfaltobeton
- Bankine
- Bankine betoni
- Mure Ekzistuese

Porositës:

Bashkia Malësia e Madhe

Titulli i Projektit

SISTEMIM ASFALTIM RRUGA KOPLIK SIPERM-LUIS

Faza

PROJEKT ZBATIMI

Vula

Autor "NOVATECH STUDIO "SHPK

ADMIN ING. EMIL NOVA

Grupi projektimit:

ING. NDERTIMI	Mimoza TOMCO
ARKITEKT	Gerta NOVA
ING. HIDROTEKNIK	Klodjan NDQJ
ING. HIDROTEKNIK	Kostandin NOVA
ING. GJEOLGJIK	Antonela BAZHDARI

Vula

Kapitulli

PROJEKTI ARKITEKTONIK

Titulli i Vizatimit

PLANIMETRI - AKSI II

Realizuar	JANAR 2023	Shkalla	1:250
-----------	------------	---------	-------

Emërtimi i Fletës



A 1 - 32

# PROFILI GJATESOR AKSI 1

SH - H 1:1000

SH - V 1:100

## LEGJENDË

-  Vija e tokes
-  Vija e projektit

### Porositës:

Bashkia Malësia e Madhe

### Titulli i Projektit

SISTEMIM ASFALTIM  
RRUGA KOPLIK SIPERM-LUIS

### Faza

PROJEKT ZBATIMI

### Vula

Autor "NOVATECH STUDIO "SHPK



### Grupi projektimit:

ING. NDERTIMI	Mimoza TOMCO
ARKITEKT	Gerta NOVA
ING. HIDROTEKNIK	Klodjan NDOJ
ING. HIDROTEKNIK	Kostandin NOVA
ING. GJEOLGJIK	Antonela BAZHDARI



NR I PRERJES	CS - 1	CS - 2	CS - 3	CS - 4	CS - 5	CS - 6	CS - 7	CS - 8	CS - 9	CS - 10	CS - 11	CS - 12	CS - 13	CS - 14	CS - 15	CS - 16
KUOTA TOKES	150.00	149.77	148.95	148.26	147.38	146.76	146.04	145.29	144.56	143.78	143.03	142.35	141.74	141.63	141.41	141.04
KUOTA PROJEKTIT	150.00	149.77	148.95	148.26	147.38	146.56	145.87	145.18	144.50	143.81	143.12	142.43	141.74	141.58	141.43	141.04
KUOTA PUNES	0.00	0.46	0.33	0.33	0.13	0.20	0.17	0.11	0.07	-0.02	-0.09	-0.09	0.00	0.04	-0.02	-0.33
DIST PJESORE	10.00	20.00	20.00	20.00	20.00	20.00	20.00	20.00	20.00	20.00	20.00	20.00	20.00	20.00	20.00	20.00
DIST PROGRESIVE	0+000	0+020	0+040	0+060	0+080	0+100	0+120	0+140	0+160	0+180	0+200	0+220	0+240	0+260	0+280	0+300

### Vula

### Kapitulli

PROJEKTI ARKITEKTONIK

### Titulli i Vizatimit

PROFILI GJATESOR AKSI I

Realizuar **JANAR 2023** | Shkallë SH-H 1:1000  
Emërtimi i Fletës | SH-V 1: 100



**A 1 - 33**

# PROFILI GJATESOR AKSI 1

SH - H 1:1000

SH - V 1:100

## LEGJENDË

-  Vija e tokes
-  Vija e projektit

### Porositës:

Bashkia Malësia e Madhe

### Titulli i Projektit

SISTEMIM ASFALTIM  
RRUGA KOPLIK SIPERM-LUIS

### Faza

PROJEKT ZBATIMI

### Vula

Autor "NOVATECH STUDIO "SHPK



ADMIN ING. EMIL NOVA

### Grupi projektimit:

ING. NDERTIMI	Mimozë TOMCO
ARKITEKT	Gerta NOVA
ING. HIDROTEKNIK	Klodjan NDOJ
ING. HIDROTEKNIK	Kostandin NOVA
ING. GJEEOLOGJIK	Antonela BAZHDARI

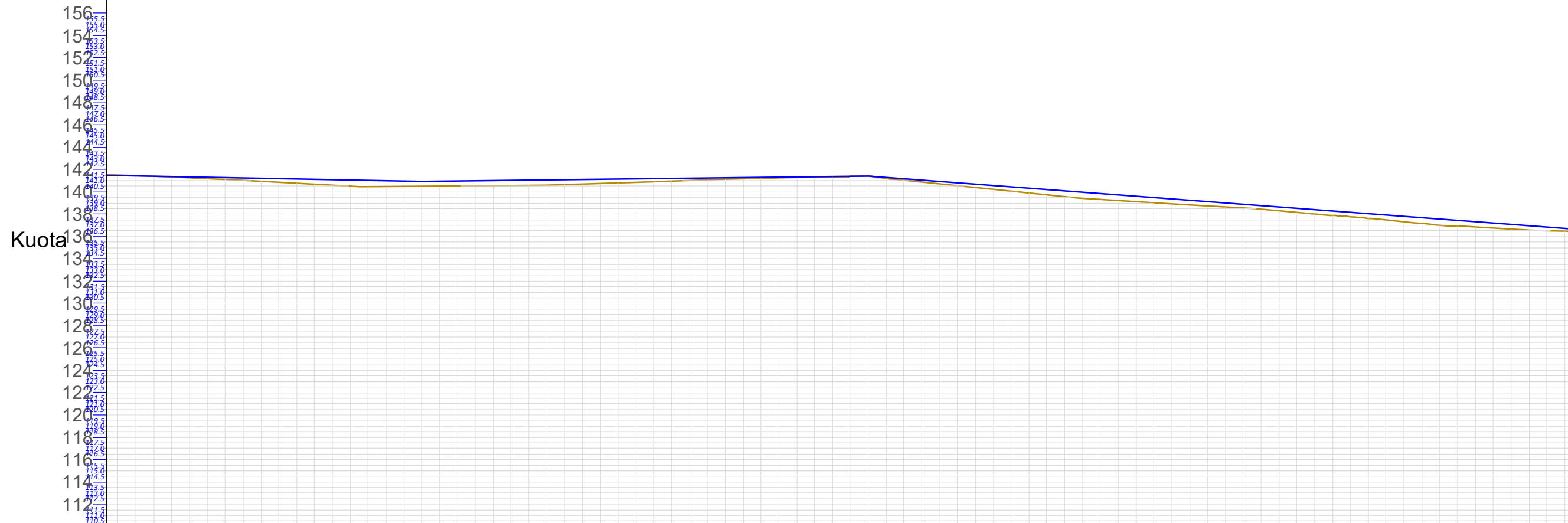

NR I PRERJES	CS - 15	CS - 16	CS - 17	CS - 18	CS - 19	CS - 20	CS - 21	CS - 22	CS - 23	CS - 24	CS - 25	CS - 26	CS - 27	CS - 28	CS - 29	CS - 30
KUOTA TOKES	141.41	141.04	140.58	140.48	140.55	140.75	141.02	141.24	141.39	140.56	139.73	139.09	138.64	138.03	137.30	136.75
KUOTA PROJEKTI	141.43	141.04	141.11	140.95	141.04	141.13	141.21	141.30	141.39	140.79	140.19	139.59	138.98	138.38	137.78	137.18
KUOTA PUNES	-0.02	-0.23	-0.52	-0.47	-0.49	-0.37	-0.19	-0.07	0.00	-0.23	-0.46	-0.49	-0.34	-0.36	-0.48	-0.42
DIST PJESORE	0+280	0+300	0+320	0+340	0+360	0+380	0+400	0+420	0+440	0+460	0+480	0+500	0+520	0+540	0+560	0+580
DIST PROGRESIVE	0+280	0+300	0+320	0+340	0+360	0+380	0+400	0+420	0+440	0+460	0+480	0+500	0+520	0+540	0+560	0+580

### Vula

### Kapitulli

PROJEKTI ARKITEKTONIK

### Titulli i Vizatimit

PROFILI GJATESOR AKSI I



Realizuar JANAR 2023 Shkalla SH-H 1:1000  
Emërtimi i Fletës SH-V 1: 100

# PROFILI GJATESOR AKSI 1

SH - H 1:1000

SH - V 1:100

## LEGJENDË

-  Vija e tokes
-  Vija e projektit

### Porositës:

Bashkia Malësia e Madhe

### Titulli i Projektit

SISTEMIM ASFALTIM  
RRUGA KOPLIK SIPERM-LUIS

### Faza

PROJEKT ZBATIMI

### Vula

Autor "NOVATECH STUDIO "SHPK



ADMIN ING. EMIL NOVA

### Grupi projektimit:

ING. NDERTIMI	Mimozë TOMCO
ARKITEKT	Gerta NOVA
ING. HIDROTEKNIK	Klodjan NDOJ
ING. HIDROTEKNIK	Kostandin NOVA
ING. GJEOLGJIK	Antonela BAZHDARI

### Vula

### Kapitulli

PROJEKTI ARKITEKTONIK

### Titulli i Vizatimit

PROFILI GJATESOR AKSI I

Realizuar **JANAR 2023** Shkallë SH-H 1:1000  
SH-V 1: 100

Emërtimi i Fletës

**A 1 - 35**

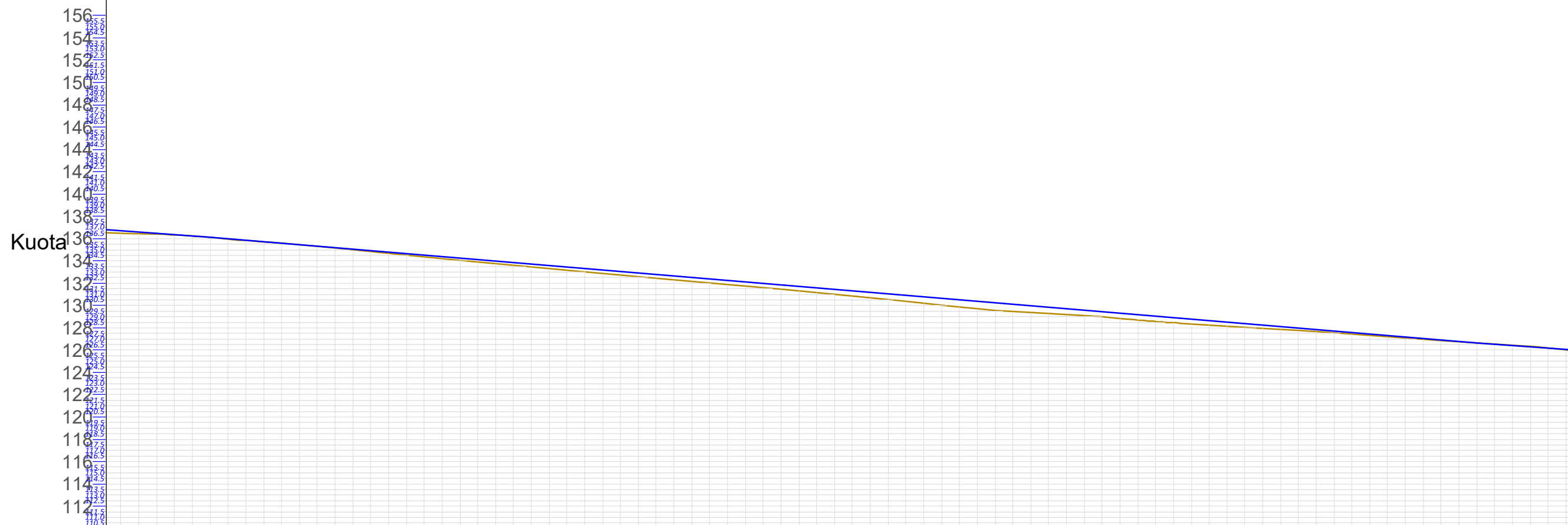



NR I PRERJES	CS - 31	CS - 32	CS - 33	CS - 34	CS - 35	CS - 36	CS - 37	CS - 38	CS - 39	CS - 40	CS - 41	CS - 42	CS - 43	CS - 44	CS - 45	CS - 46	CS - 47
KUOTA TOKES	136.44	135.96	135.28	134.52	133.76	133.00	132.30	131.58	130.85	130.05	129.35	128.86	128.27	127.75	127.19	126.63	126.63
KUOTA PROJEKTI	136.58	135.96	135.28	134.52	133.96	133.30	132.63	131.96	131.30	130.63	129.97	129.30	128.63	127.97	127.30	126.63	126.63
KUOTA PUNES	-0.13	0.00	-0.02	-0.11	-0.20	-0.29	-0.33	-0.39	-0.45	-0.58	-0.62	-0.44	-0.37	-0.22	-0.11	0.00	-0.10
DIST PJESORE		20.00	20.00	20.00	20.00	20.00	20.00	20.00	20.00	20.00	20.00	20.00	20.00	20.00	20.00	20.00	20.00
DIST PROGRESIVE	0+600	0+620	0+640	0+660	0+680	0+700	0+720	0+740	0+760	0+780	0+800	0+820	0+840	0+860	0+880	0+900	0+920

# PROFILI GJATESOR AKSI 1

SH - H 1:1000

SH - V 1:100

## LEGJENDË

-  Vija e tokes
-  Vija e projektit

### Porositës:

Bashkia Malësia e Madhe

### Titulli i Projektit

SISTEMIM ASFALTIM  
RRUGA KOPLIK SIPERM-LUIS

### Faza

PROJEKT ZBATIMI

### Vula

Autor "NOVATECH STUDIO "SHPK



### Grupi projektimit:

ING. NDERTIMI	Mimozë TOMCO
ARKITEKT	Gerta NOVA
ING. HIDROTEKNIK	Klodjan NDOJ
ING. HIDROTEKNIK	Kostandin NOVA
ING. GJEOLOGJIK	Antonela BAZHDARI

### Vula

### Kapitulli

PROJEKTI ARKITEKTONIK

### Titulli i Vizatimit

PROFILI GJATESOR AKSI I

Realizuar **JANAR 2023** Shkalla SH-H 1:1000  
SH-V 1: 100

Emërtimi i Fletës

**A 1 - 36**

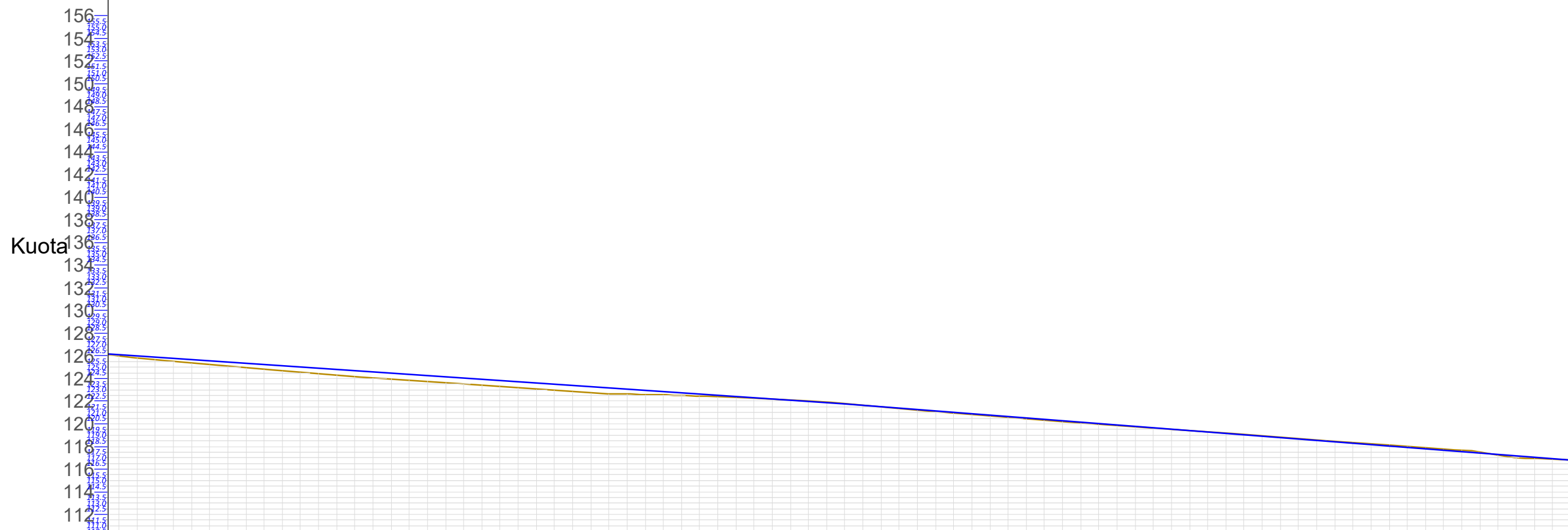

NR I PRERJES	CS - 47	CS - 48	CS - 49	CS - 50	CS - 51	CS - 52	CS - 53	CS - 54	CS - 55	CS - 56	CS - 57	CS - 58	CS - 59	CS - 60	CS - 61	CS - 62	CS - 63
KUOTA TOKES	126.10 + 125.99	125.24	124.57	123.84	123.03	122.24	121.57	120.86	120.18	121.09	120.48	119.87	119.29	118.69	118.14	117.49	
KUOTA PROJEKTI	126.10	125.56	125.02	124.48	123.94	123.40	122.86	122.32	121.78	121.15	120.53	119.91	119.28	118.66	118.04	117.42	
KUOTA PUNES	-0.10	-0.32	-0.45	-0.50	-0.51	-0.56	-0.29	-0.06	0.00	-0.06	-0.05	-0.04	0.00	0.03	0.10	0.08	
DIST PJESORE		20.00	20.00	20.00	20.00	20.00	20.00	20.00	20.00	20.00	20.00	20.00	20.00	20.00	20.00	20.00	
DIST PROGRESIVE	0+020	0+040	0+060	0+080	1+000	1+020	1+040	1+060	1+080	1+100	1+120	1+140	1+160	1+180	1+200	1+220	1+240





# PROFILI TERTHOR TIP SH 1:100

PROFILI TIP 1 PG CS-0 - CS - 63

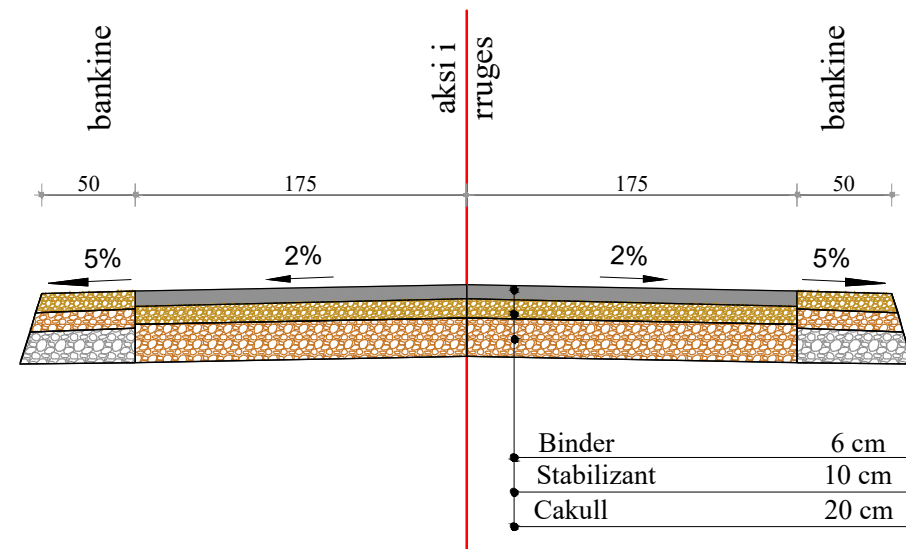

PROFILI TIP 2 NE AKSIN 2  
PG CS-0 - CS 0+10 m : PG CS-3+10.5 m -  
CS 7+2.5 m : PG CS-9+18 m- CS-11+7 m

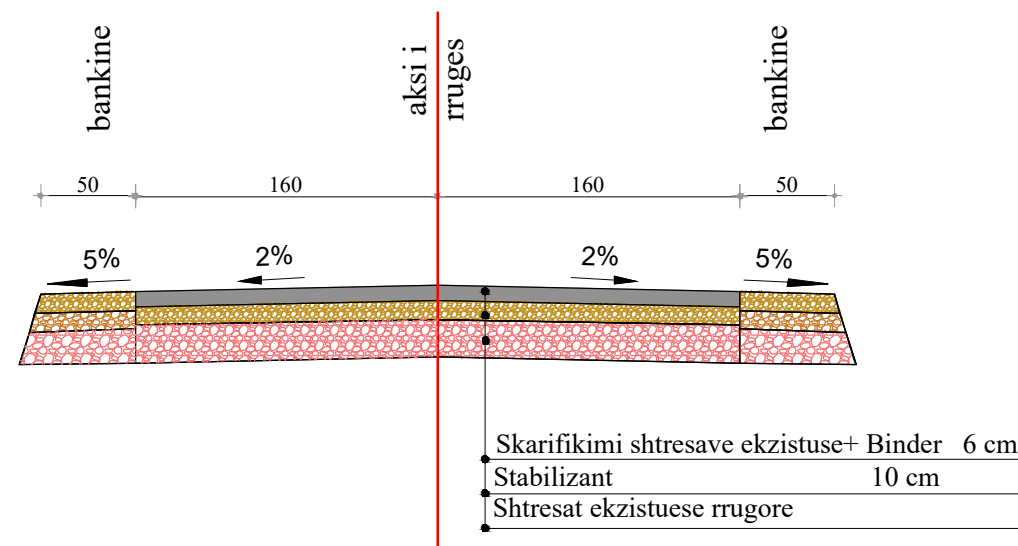

Porositës:

Bashkia Malësia e Madhe

Titulli i Projektit

SISTEMIM ASFALTIM  
RRUGA KOPLIK SIPERM-LUIS

Faza

PROJEKT ZBATIMI

Vula

Autor "NOVATECH STUDIO "SHPK

ADMIN ING. EMIL NOVA

Grupi projektimit:

ING. NDERTIMI	Mimoza TOMCO
ARKITEKT	Gerta NOVA
ING. HIDROTEKNIK	Klodjan NDQJ
ING. HIDROTEKNIK	Kostandin NOVA
ING. GJEOLGJIK	Antonela BAZHDARI

Vula

Kapitulli

PROJEKTI ARKITEKTONIK

Titulli i Vizatimit

PROFILA TIP

Realizuar **JANAR 2023** Shkalla **1:1000**

Emërtimi i Fletës

**A 1 - 39**



# PROFILI TERTHOR SH 1:100

## LEGJENDË

 Siperfaqe germimi

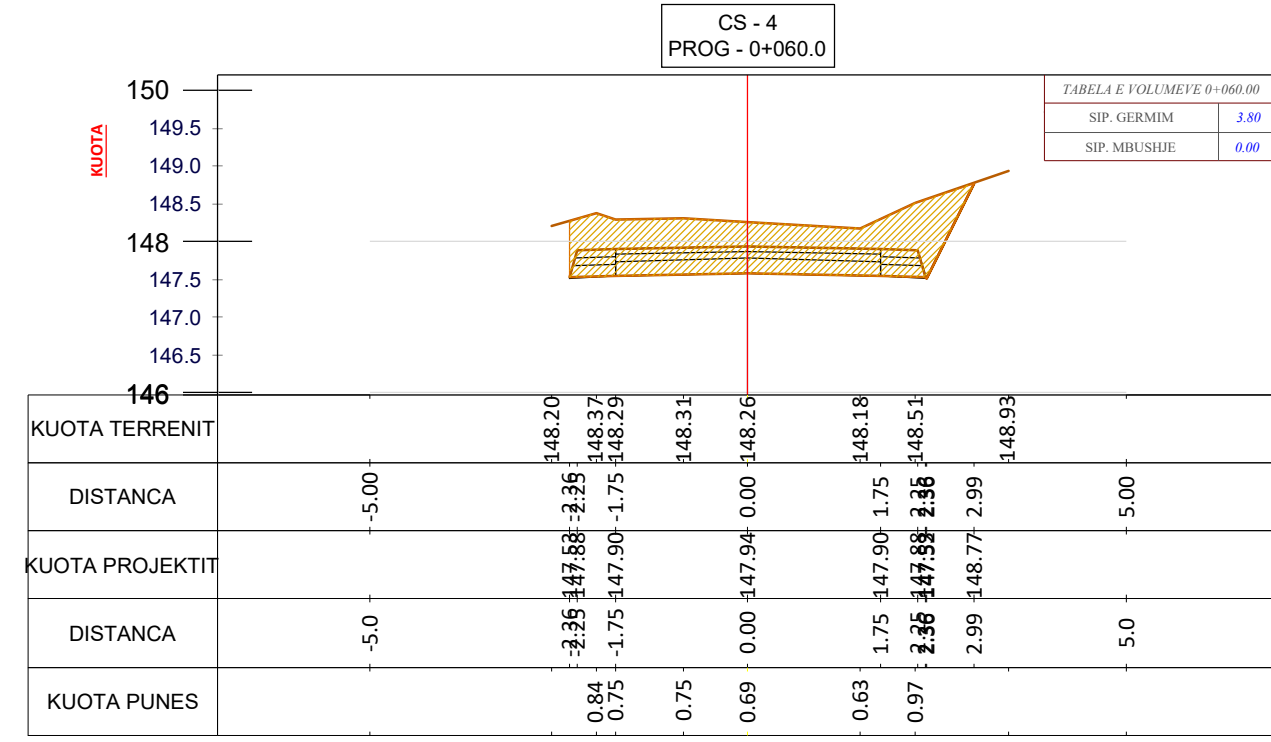
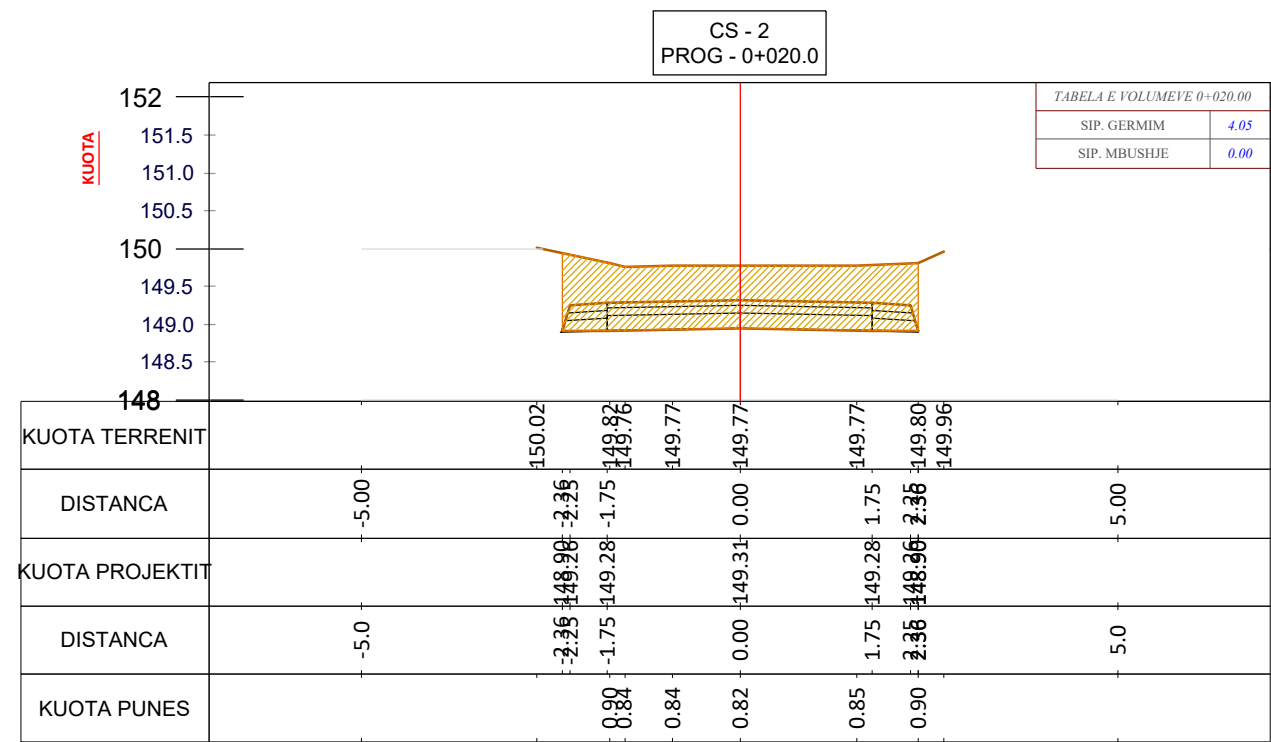
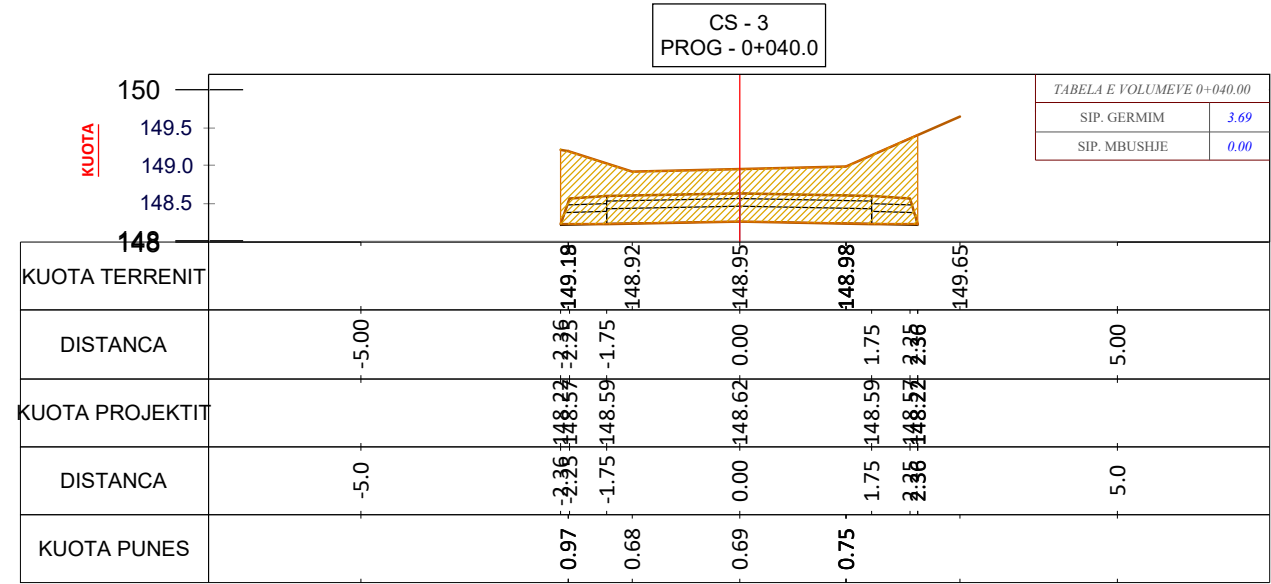
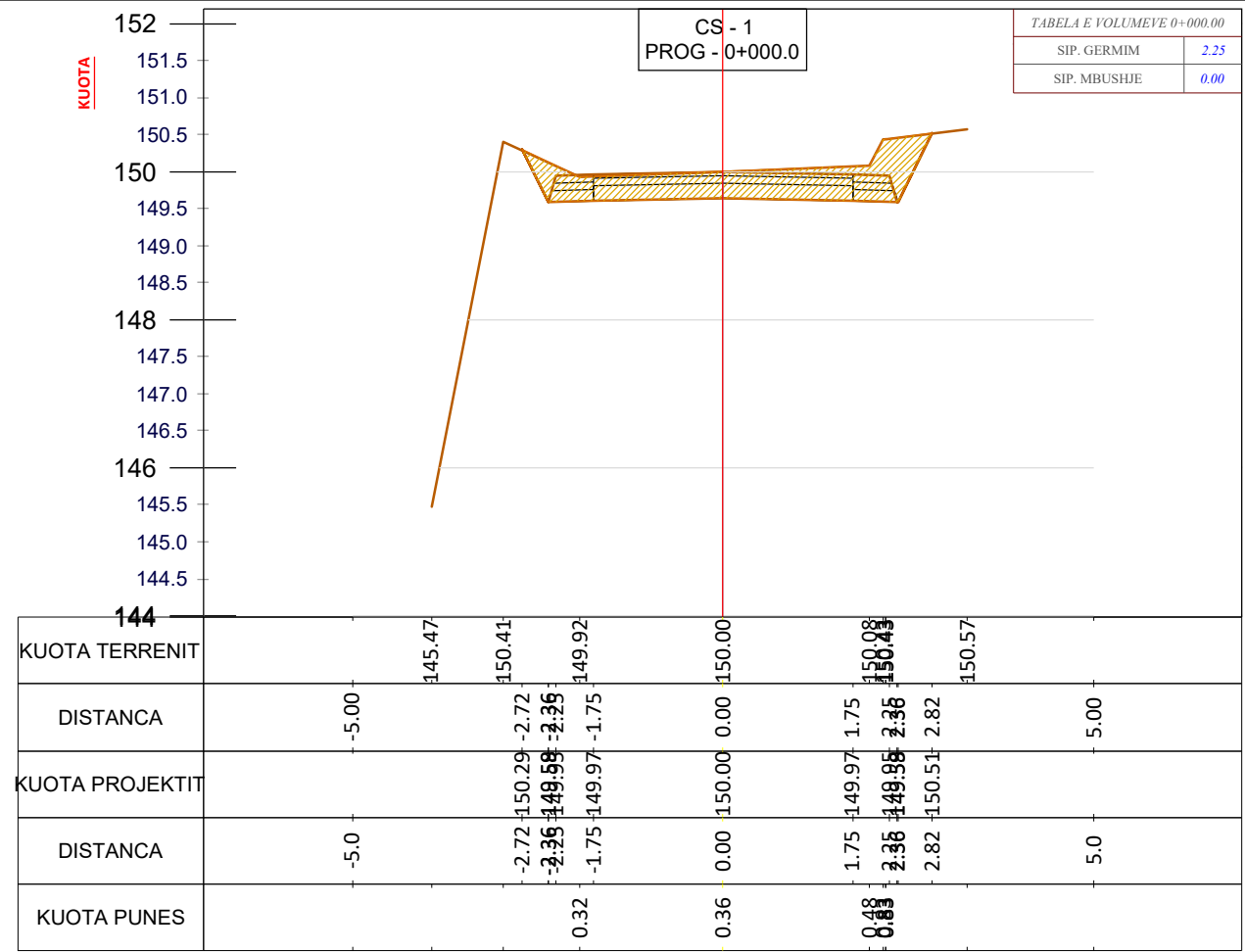

Porositës:  
**Bashkia Malësia e Madhe**

Titulli i Projektit  
**SISTEMIM ASFALTIM  
RRUGA KOPLIK SIPERM-LUIS**

Faza  
**PROJEKT ZBATIMI**

Vula  
Autor "NOVATECH STUDIO "SHPK"  
  
ADMIN ING. EMIL NOVA

Grupi projektimit:  
ING. NDERTIMI MIMOZA TOMCO  
ARKITEKT GERTE NOVA  
ING. HIDROTEKNIK KLADJAN NDOJ  
ING. HIDROTEKNIK KOSTANDIN NOVA  
ING. GJEOLGJIK ANTONELA BAZHDARI

Kapitulli  
**PROJEKTI ARKITEKTONIK**

Titulli i Vizatimit  
PROFILA TERTHOR

Realizuar **JANAR 2023** Shkalla **1:100**

Emërtimi i Fletës  
**A 1 - 40**

# PROFILI TERTHOR SH 1:100

## LEGJENDË

 Siperfaqe germimi

CS - 5  
PROG - 0+080.0

SIP. GERMIM	2.75
SIP. MBUSHJE	0.00

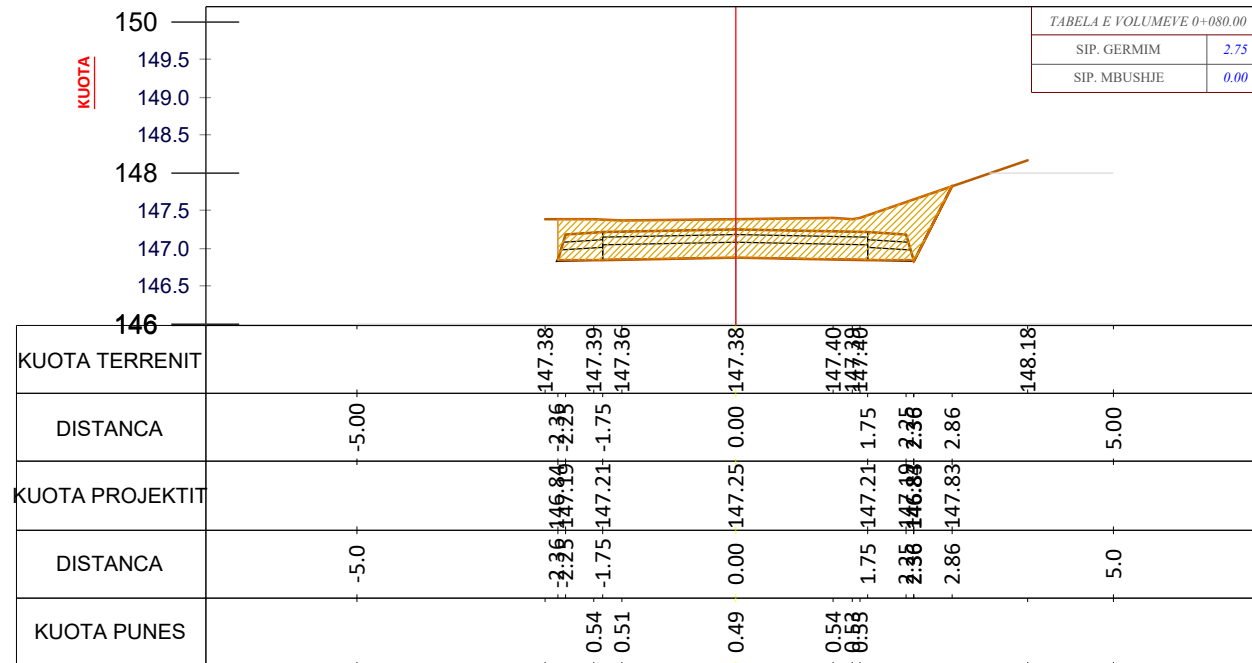

CS - 7  
PROG - 0+120.0

SIP. GERMIM	2.62
SIP. MBUSHJE	0.00

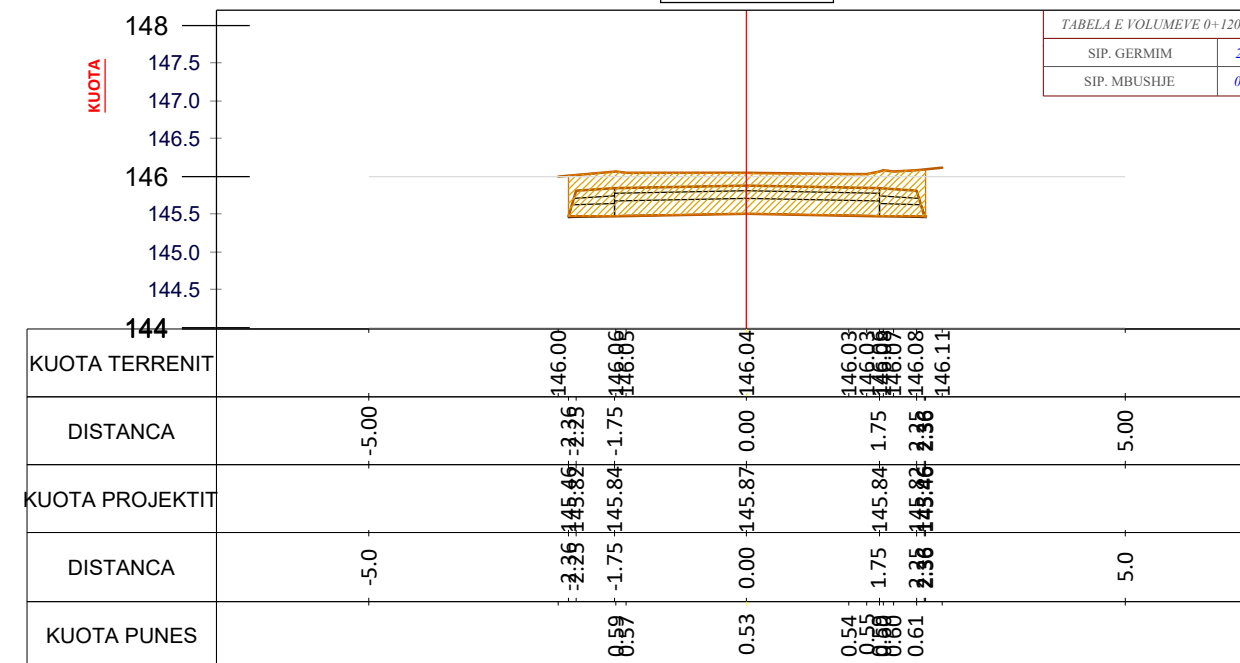

CS - 6  
PROG - 0+100.0

SIP. GERMIM	2.84
SIP. MBUSHJE	0.00

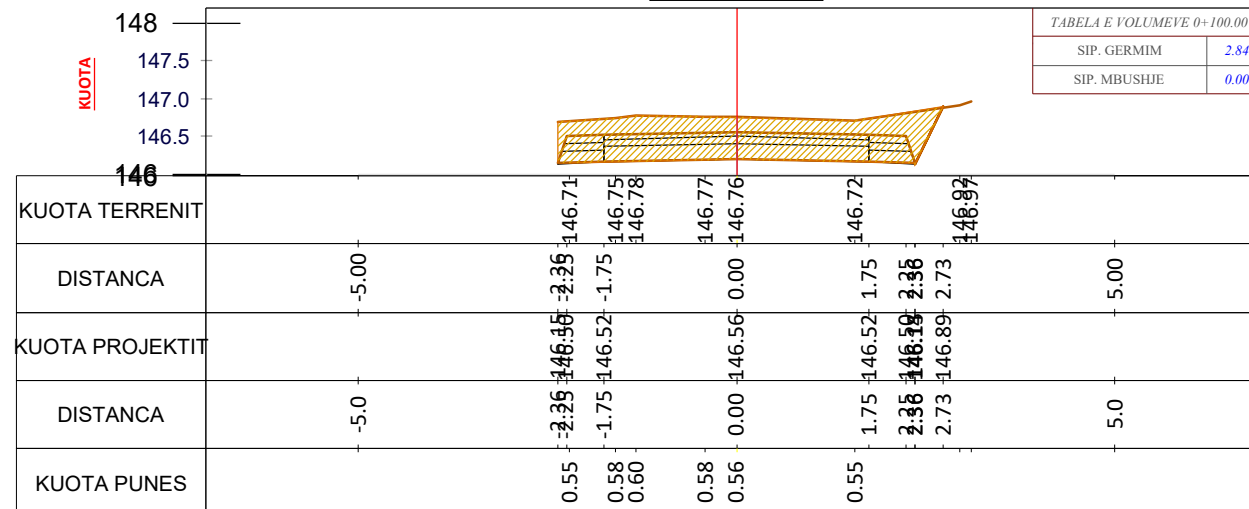

CS - 8  
PROG - 0+140.0

SIP. GERMIM	2.44
SIP. MBUSHJE	0.00

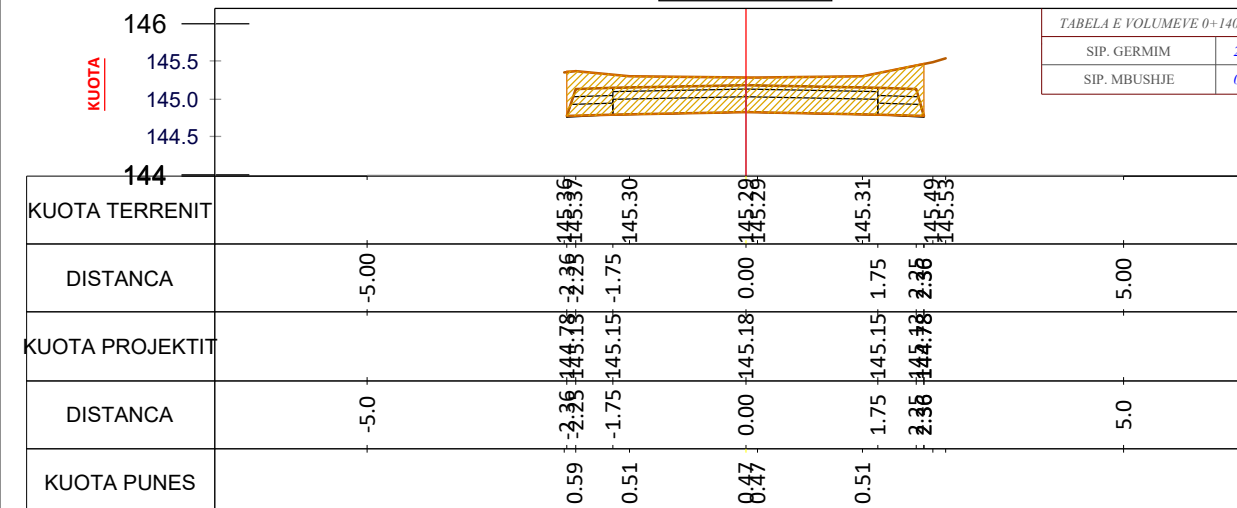

Porositës:

Bashkia Malësia e Madhe

Titulli i Projektit

SISTEMIM ASFALTIM  
RRUGA KOPLIK SIPERM-LUIS

Faza

PROJEKT ZBATIMI

Vula

Autor "NOVATECH STUDIO "SHPK



Grupi projektimit:

ING. NDERTIMI MIMOZA TOMCO  
ARKITEKT GERTA NOVA  
ING. HIDROTEKNIK KLADJAN NDOJ  
ING. HIDROTEKNIK KOSTANDIN NOVA  
ING. GJEOLGJIK ANTONELA BAZHDARI

Vula

Kapitulli

PROJEKTI ARKITEKTONIK

Titulli i Vizatimit

PROFILA TERTHOR

Realizuar JANAR 2023

Shkalla 1:100

Emërtimi i Fletës

A 1 - 41



# PROFILI TERTHOR SH 1:100

## LEGJENDË

 Siperfaqe germimi

CS - 13  
PROG - 0+240.0

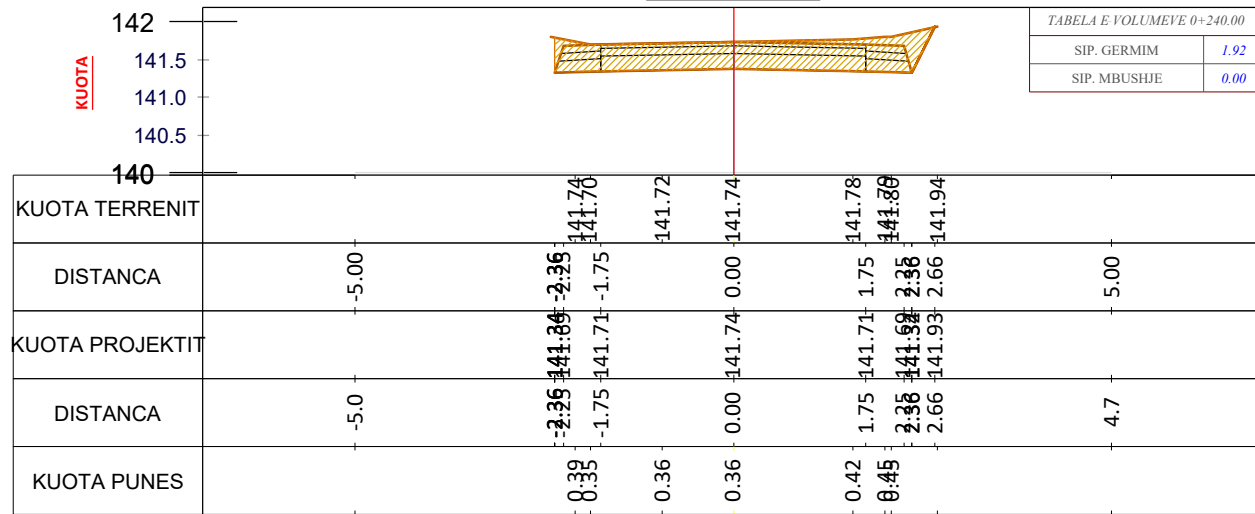

CS - 15  
PROG - 0+280.0

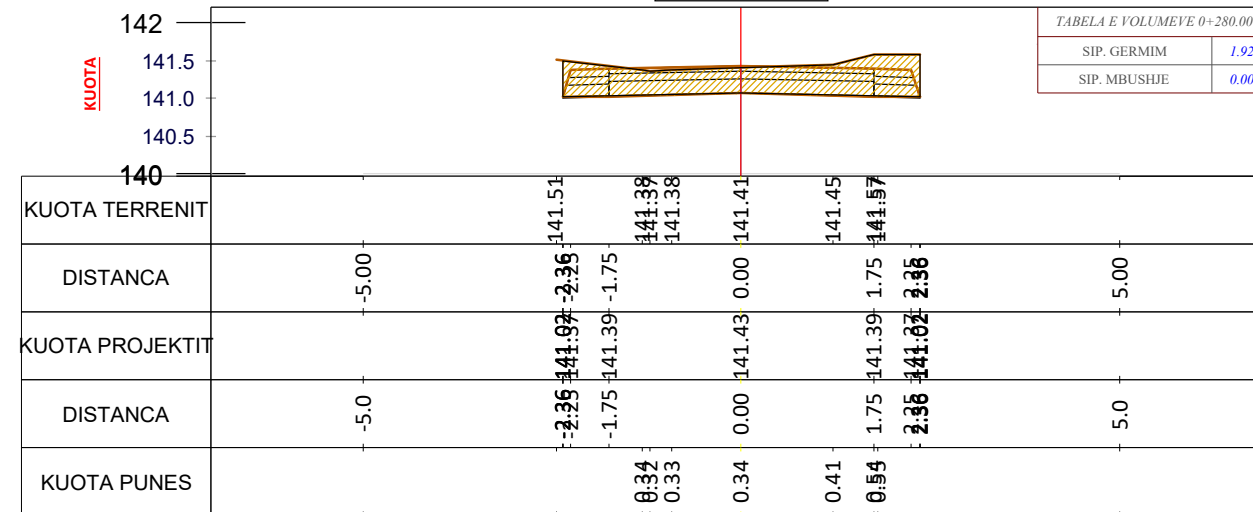

CS - 14  
PROG - 0+260.0

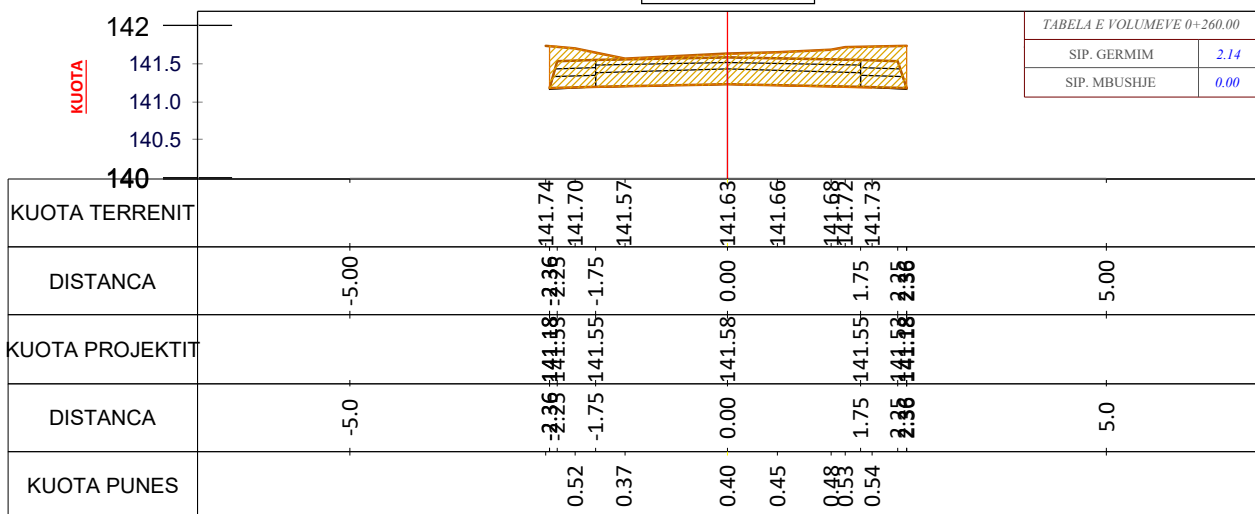

CS - 16  
PROG - 0+300.0

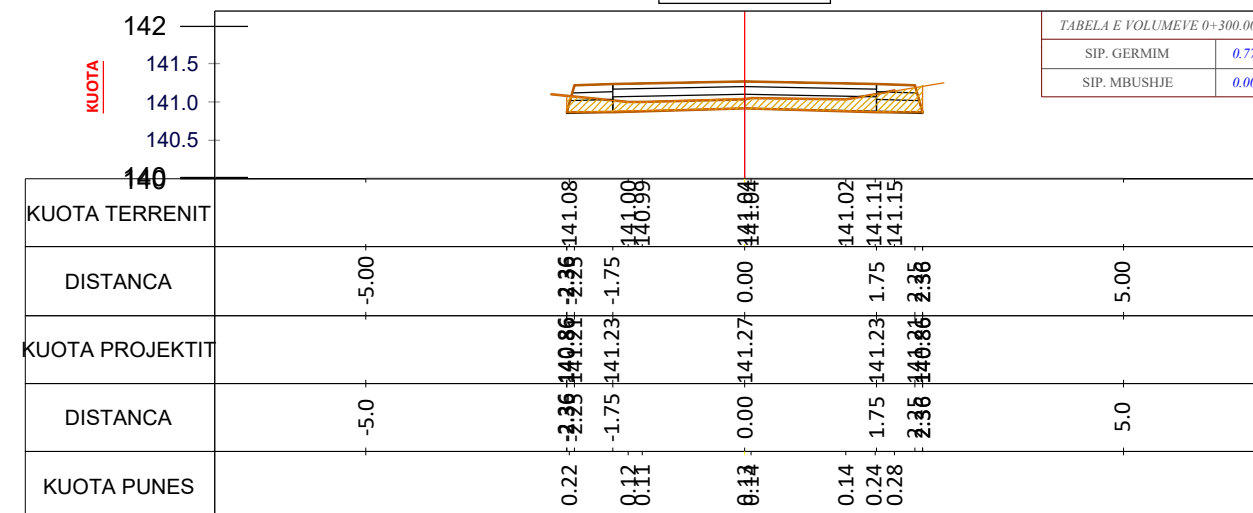

Porositës:

Bashkia Malësia e Madhe

Titulli i Projektit

SISTEMIM ASFALTIM  
RRUGA KOPLIK SIPERM-LUIS

Faza

PROJEKT ZBATIMI

Vula

Autor

"NOVATECH STUDIO "SHPK

  
ADMIN ING. EMIL NOVA

Grupi projektimit:

ING. NDERTIMI MIMOZA TOMCO  
ARKITEKT GERTE NOVA  
ING. HIDROTEKNIK KLADJAN NDOJ  
ING. HIDROTEKNIK KOSTANDIN NOVA  
ING. GJEOLGJIK ANTONELA BAZHDARI

Vula

Kapitulli

PROJEKTI ARKITEKTONIK

Titulli i Vizatimit

PROFILA TERTHOR

Realizuar JANAR 2023

Shkalla 1:100

Emërtimi i Fletës

A 1 - 43

# PROFILI TERTHOR SH 1:100

## LEGJENDË

 Siperfaqe germimi

CS - 17  
PROG - 0+320.0

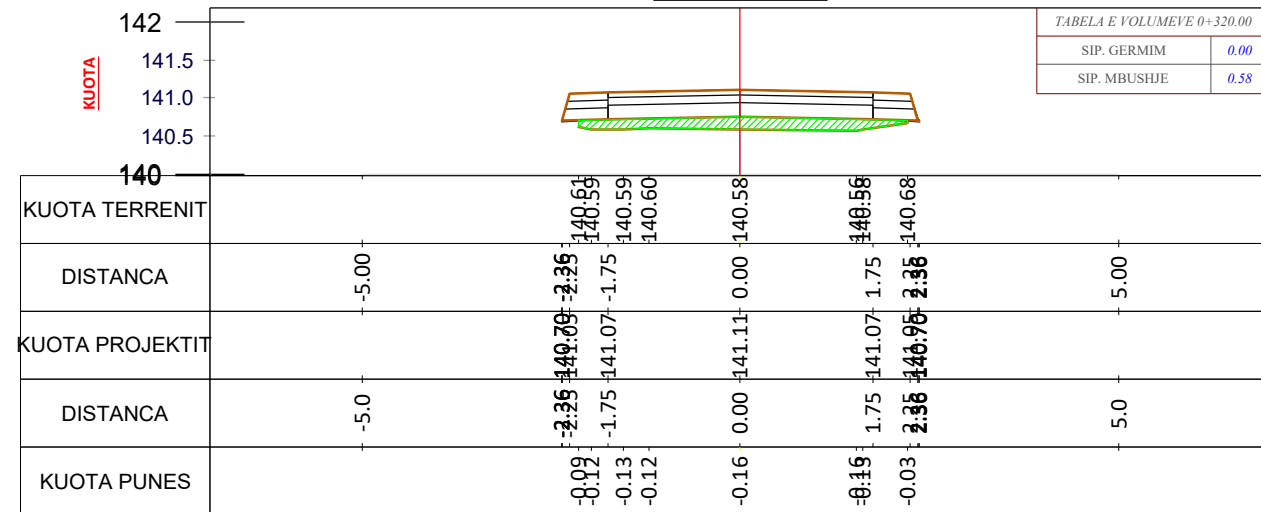

CS - 19  
PROG - 0+360.0

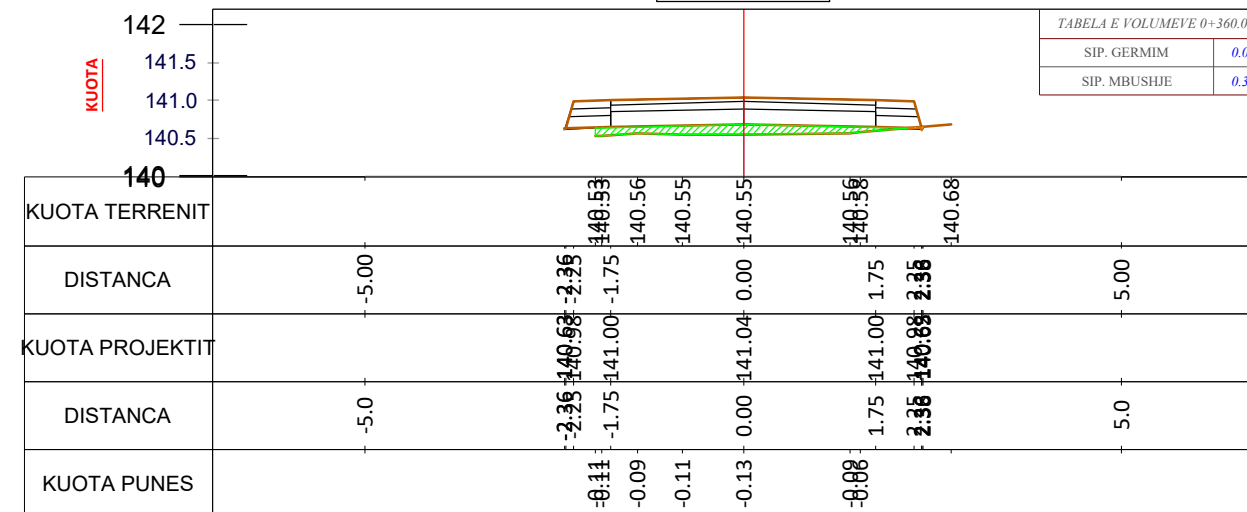

CS - 18  
PROG - 0+340.0

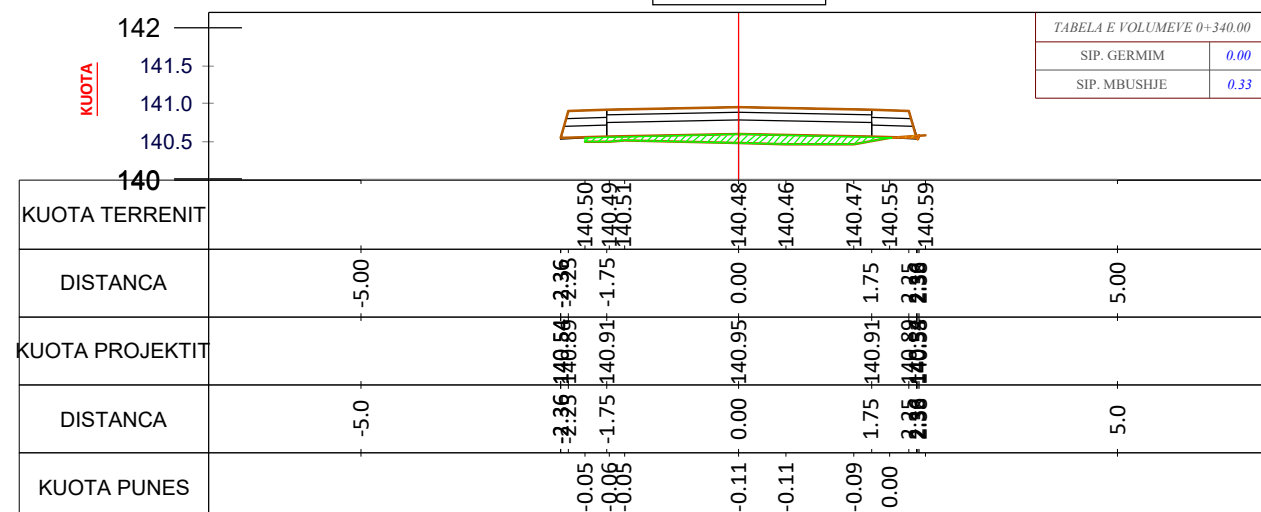

CS - 20  
PROG - 0+380.0

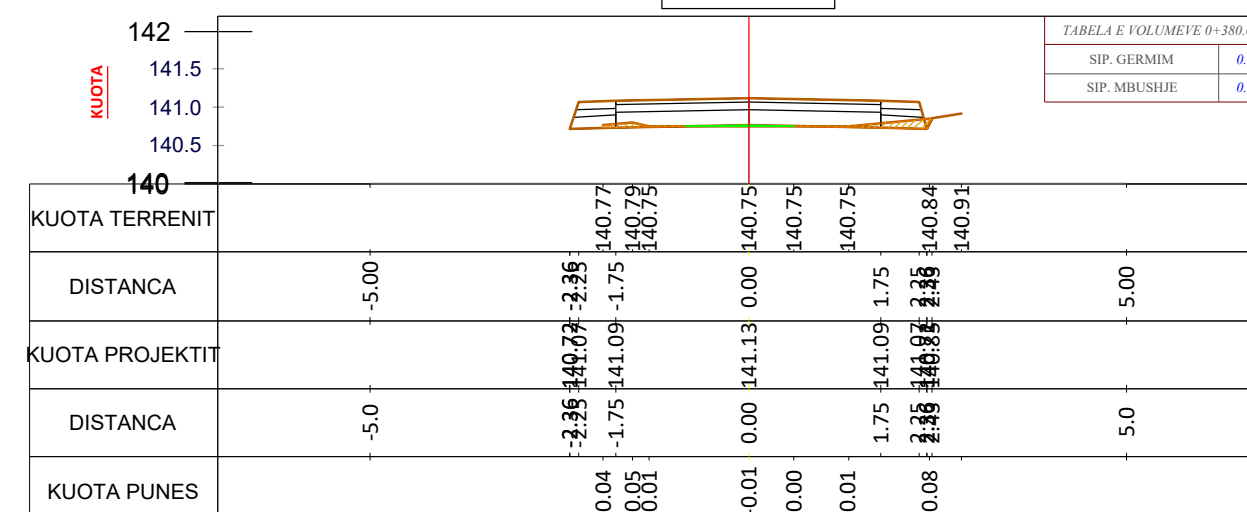

Porositës:

Bashkia Malësia e Madhe

Titulli i Projektit

SISTEMIM ASFALTIM  
RRUGA KOPLIK SIPERM-LUIS

Faza

PROJEKT ZBATIMI

Vula

Autor "NOVATECH STUDIO "SHPK



Grupi projektimit:

ING. NDERTIMI	Mimoza TOMCO
ARKITEKT	Gerta NOVA
ING. HIDROTEKNIK	Klodjan NDQJ
ING. HIDROTEKNIK	Kostandin NOVA
ING. GJEOLOGJIK	Antonela BAZHDARI

Vula

Kapitulli

PROJEKTI ARKITEKTONIK

Titulli i Vizatimit

PROFILA TERTHOR

Realizuar JANAR 2023

Shkalla 1:100

Emërtimi i Fletës

A 1 - 44

# PROFILI TERTHOR SH 1:100

## LEGJENDË

 Siperfaqe germimi

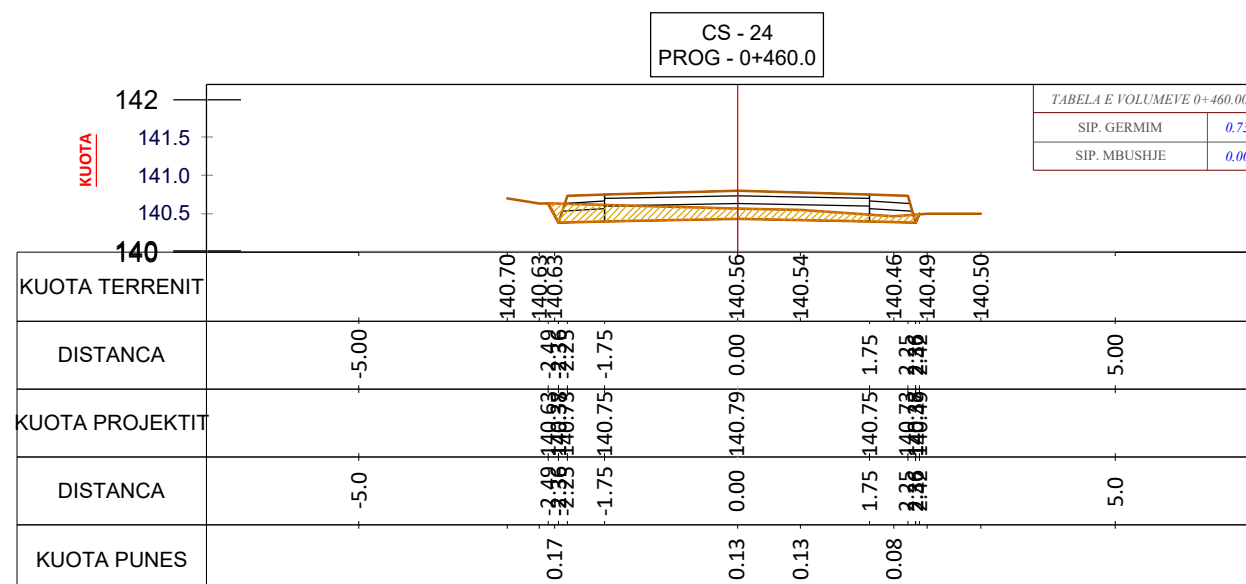
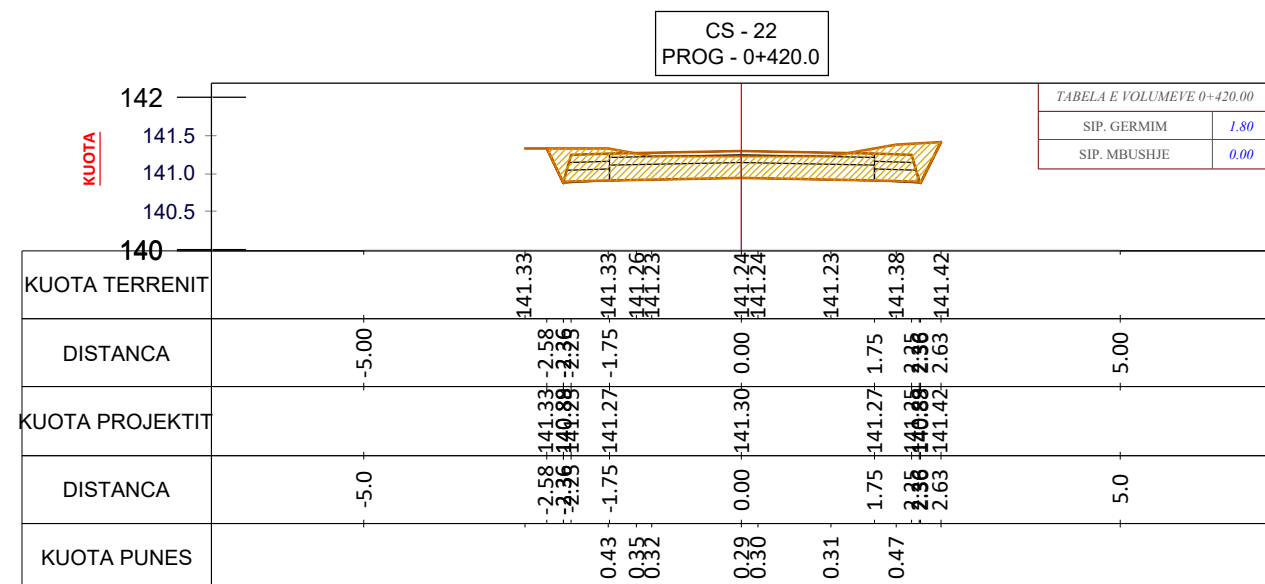
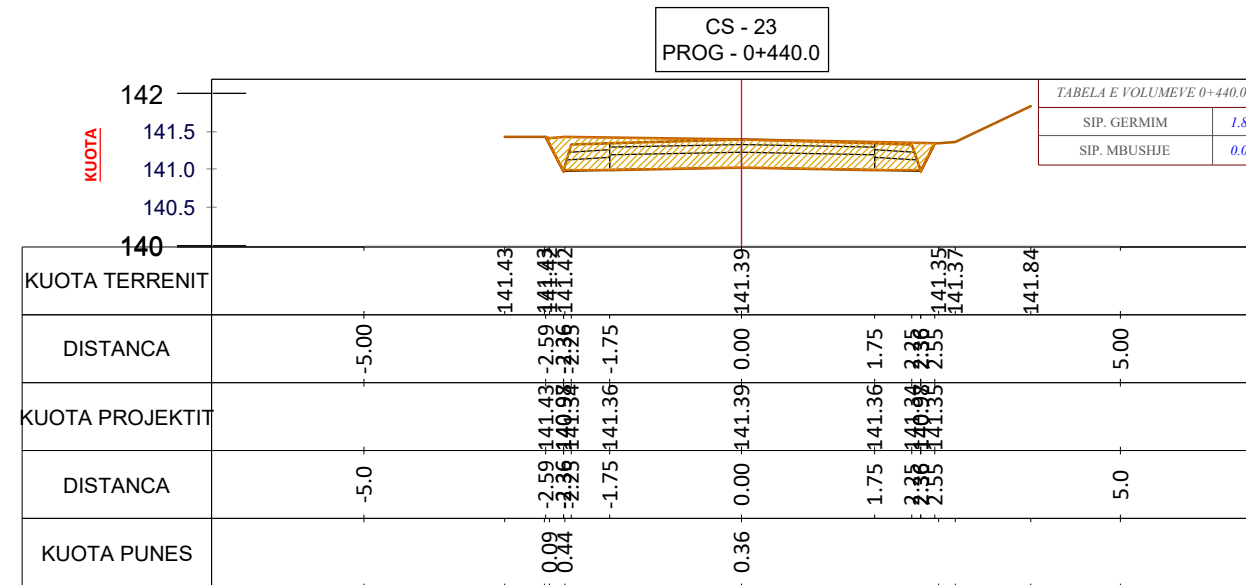
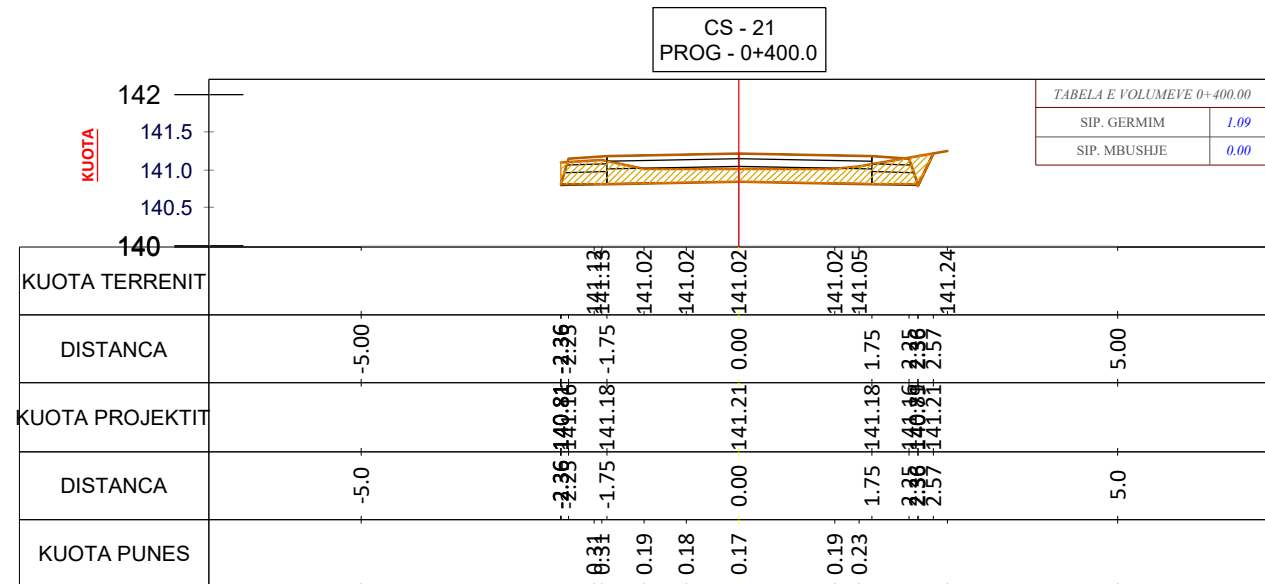

**Porositës:**  
Bashkia Malësia e Madhe

**Titulli i Projektit**  
SISTEMIM ASFALTIM  
RRUGA KOPLIK SIPERM-LUIS

**Faza**  
PROJEKT ZBATIMI

**Vula**  
Autor "NOVATECH STUDIO "SHPK

**ADMIN ING. EMIL NOVA**

**Grupi projektimit:**  
ING. NDERTIMI MIMOZA TOMCO  
ARKITEKT GERTE NOVA  
ING. HIDROTEKNIK KLADJAN NDOJ  
ING. HIDROTEKNIK KOSTANDIN NOVA  
ING. GJEOLLOJIK ANTONELA BAZHDARI

**Kapitulli**  
PROJEKTI ARKITEKTONIK

**Titulli i Vizatimit**  
PROFILA TERTHOR

Realizuar **JANAR 2023** Shkalla **1:100**  
Emërtimi i Fletës **A 1 - 45**

# PROFILI TERTHOR SH 1:100

## LEGJENDË

 Siperfaqe germimi

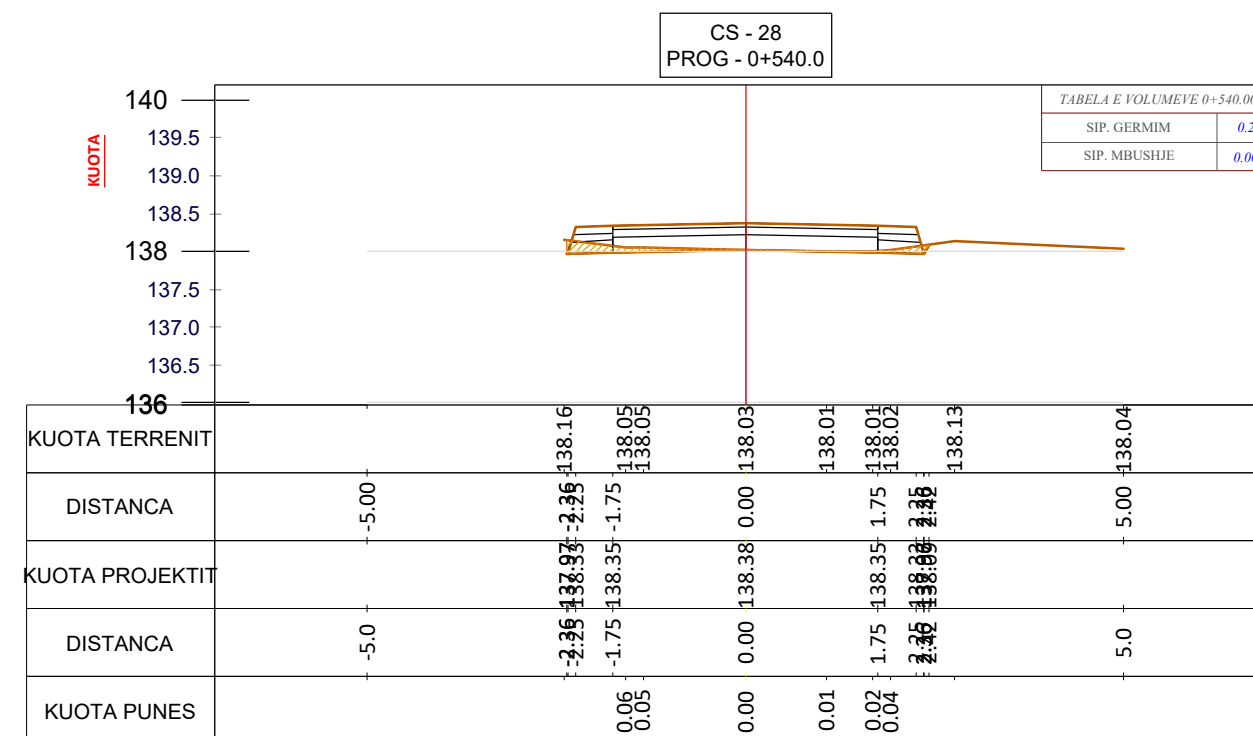
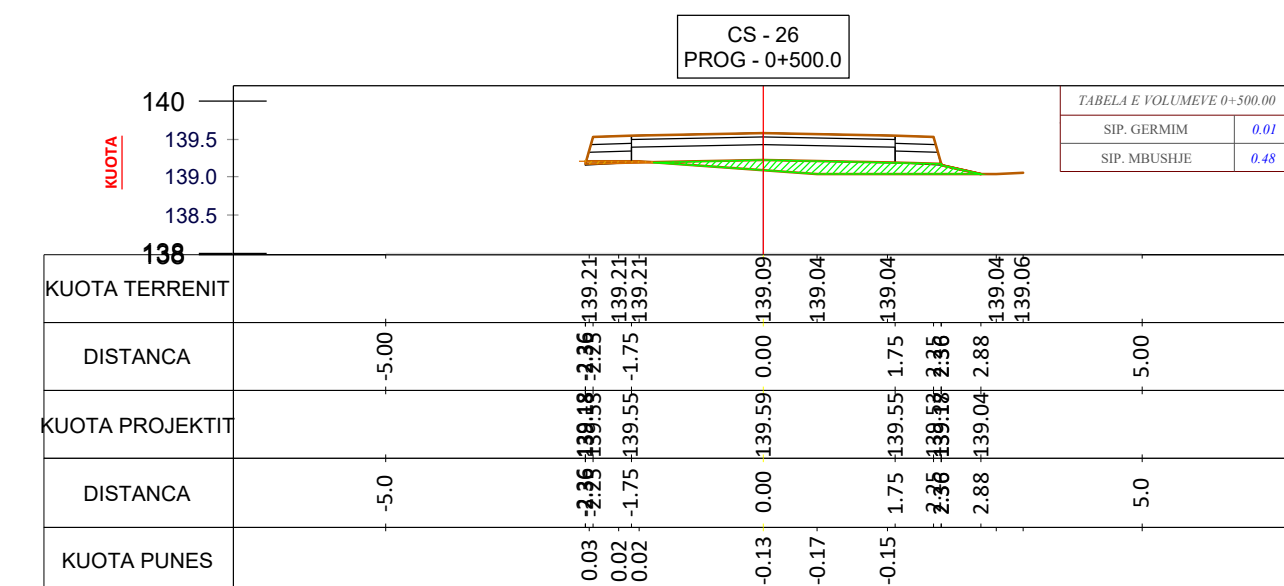
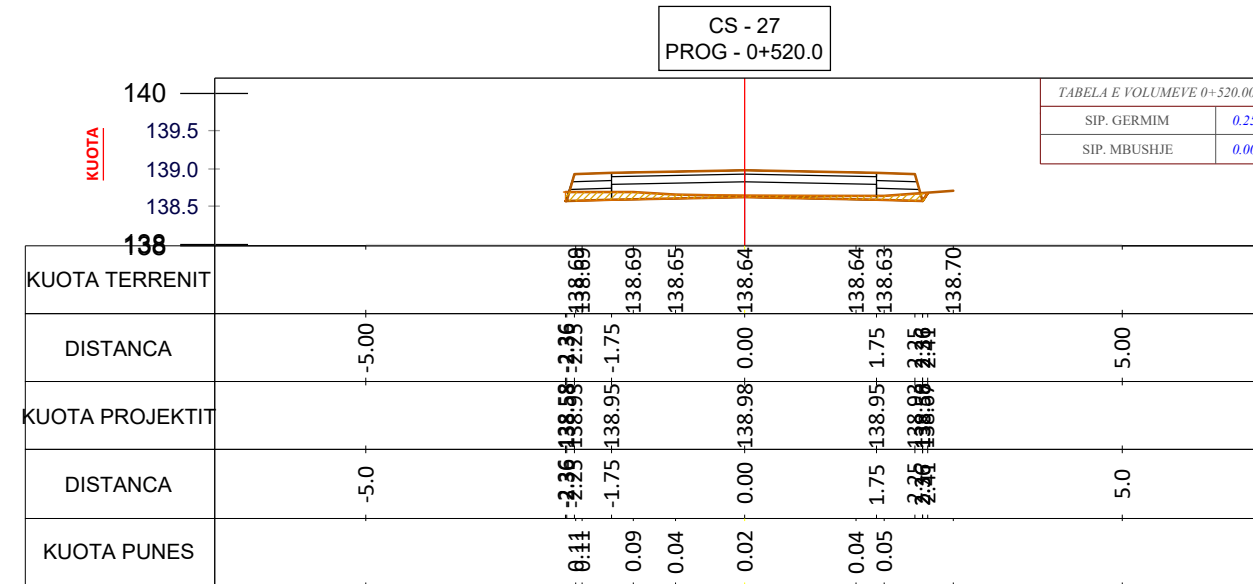
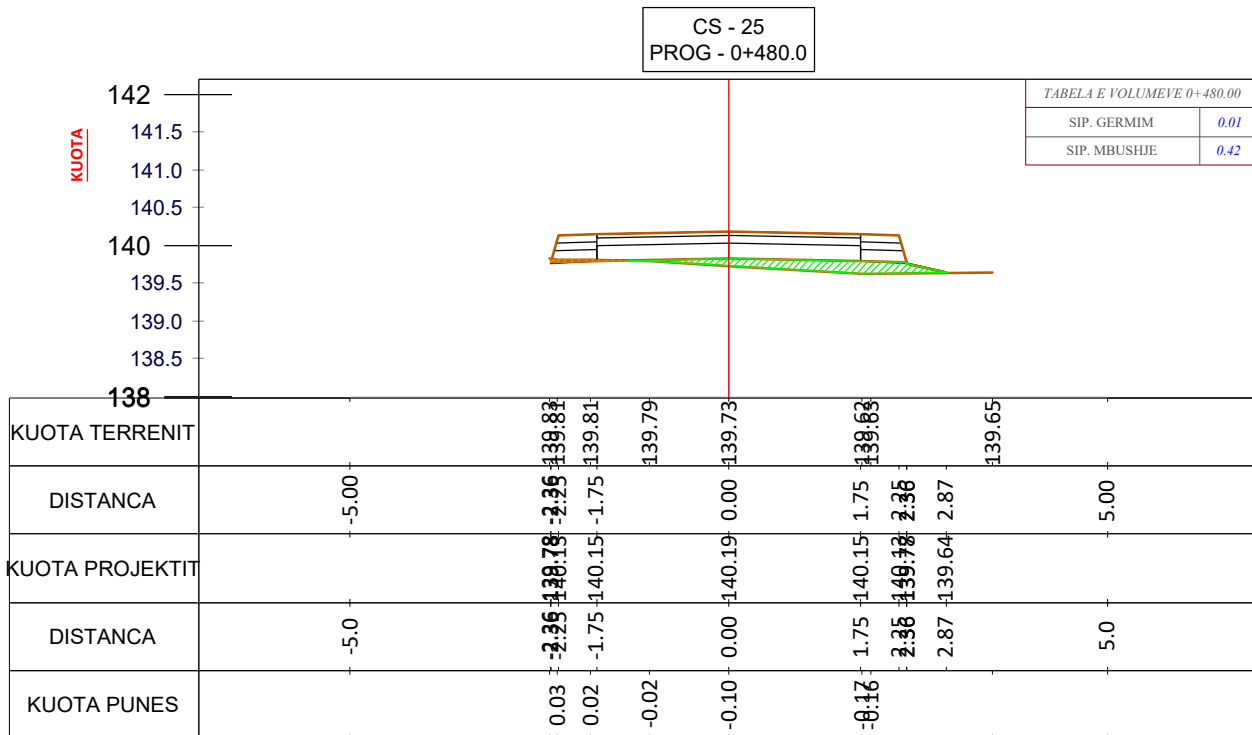

**Porositës:**  
Bashkia Malësia e Madhe

**Titulli i Projektit:**  
SISTEMIM ASFALTIM  
RRUGA KOPLIK SIPERM-LUIS

**Faza:**  
PROJEKT ZBATIMI

**Vula**  
**Autor** "NOVATECH STUDIO "SHPK  
  
ADMIN ING. EMIL NOVA

**Grupi projektimit:**  
ING. NDERTIMI MIMOZA TOMCO  
ARKITEKT GERTE NOVA  
ING. HIDROTEKNIK KLADJAN NDOJ  
ING. HIDROTEKNIK KOSTANDIN NOVA  
ING. GJEOLOGJIK ANTONELA BAZHDARI

**Kapitulli**  
PROJEKTI ARKITEKTONIK

**Titulli i Vizatimit**  
PROFILA TERTHOR

Realizuar **JANAR 2023** Shkalla **1:100**  
Emërtimi i Fletës

# PROFILI TERTHOR SH 1:100

## LEGJENDË

 Siperfaqe germimi

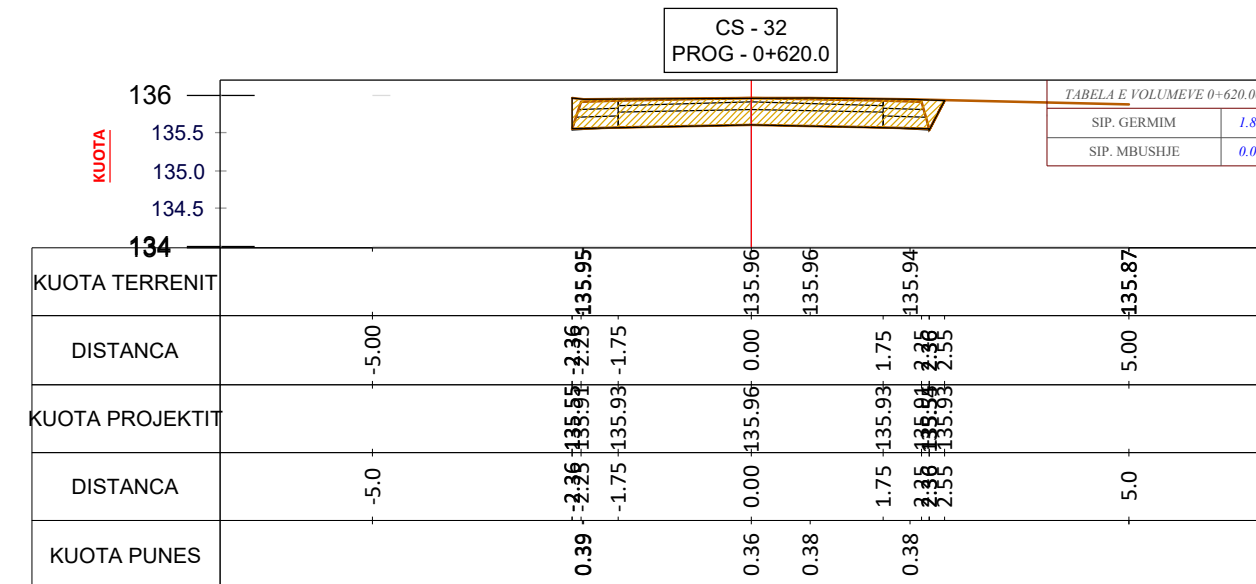
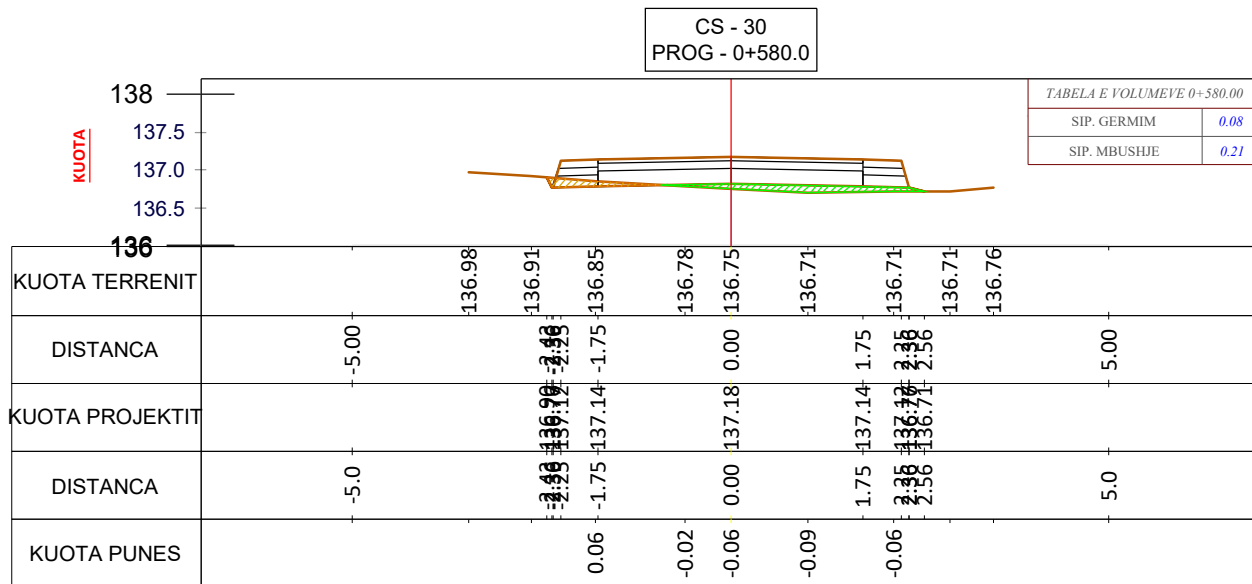
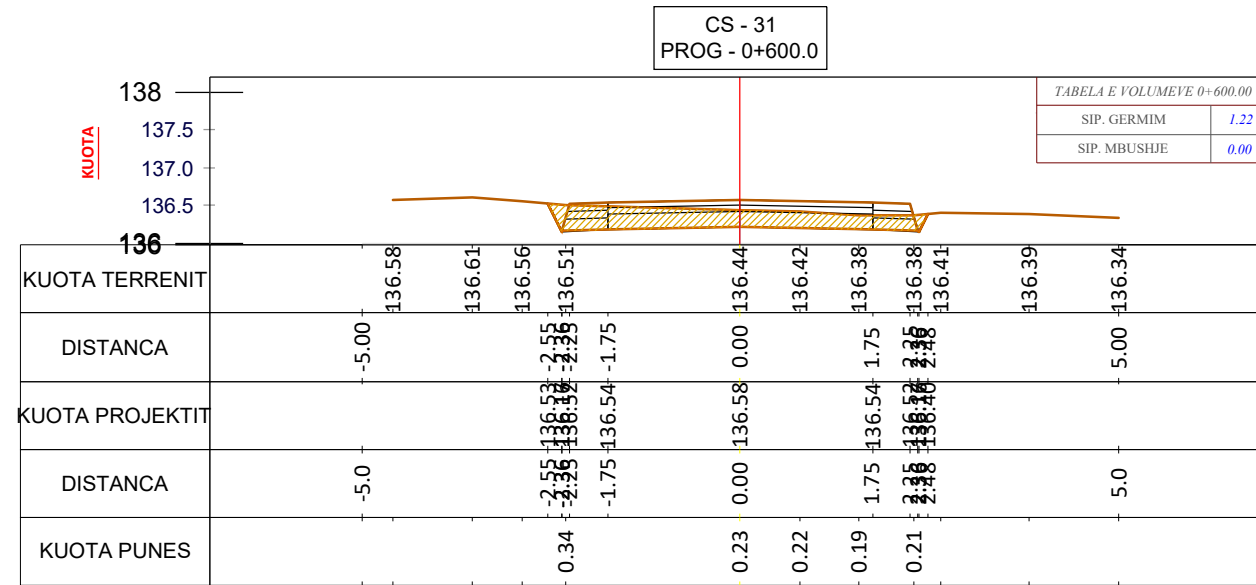
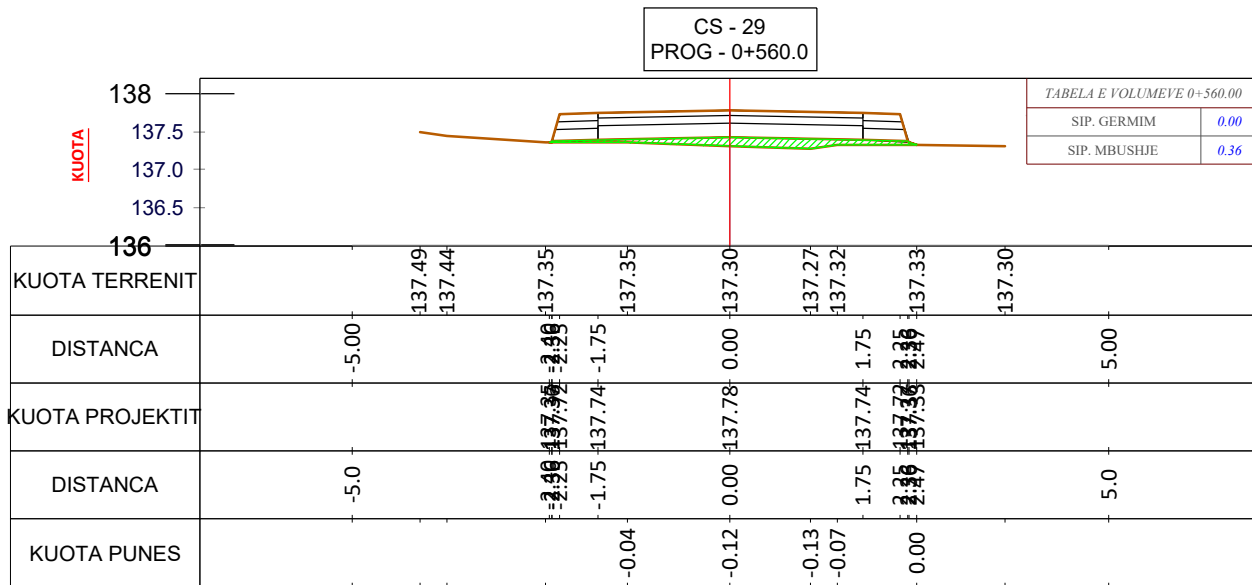

**Porositës:**  
Bashkia Malësia e Madhe

**Titulli i Projektit**  
SISTEMIM ASFALTIM  
RRUGA KOPLIK SIPERM-LUIS

**Faza**  
PROJEKT ZBATIMI

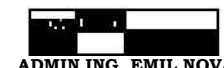
**Vula**  
**Autor** "NOVATECH STUDIO "SHPK  
  
ADMIN ING. EMIL NOVA

**Grupi projektimit:**  
ING. NDERTIMI MIMOZA TOMCO  
ARKITEKT GERTE NOVA  
ING. HIDROTEKNIK KLADJAN NDOJ  
ING. HIDROTEKNIK KOSTANDIN NOVA  
ING. GJEOLGJIK ANTONELA BAZHDARI

**Kapitulli**  
PROJEKTI ARKITEKTONIK

**Titulli i Vizatimit**  
PROFILA TERTHOR

Realizuar **JANAR 2023** Shkalla **1:100**

Emërtimi i Fletës  
**A 1 - 47**



# PROFILI TERTHOR SH 1:100

## LEGJENDË

 Siperfaqe germimi

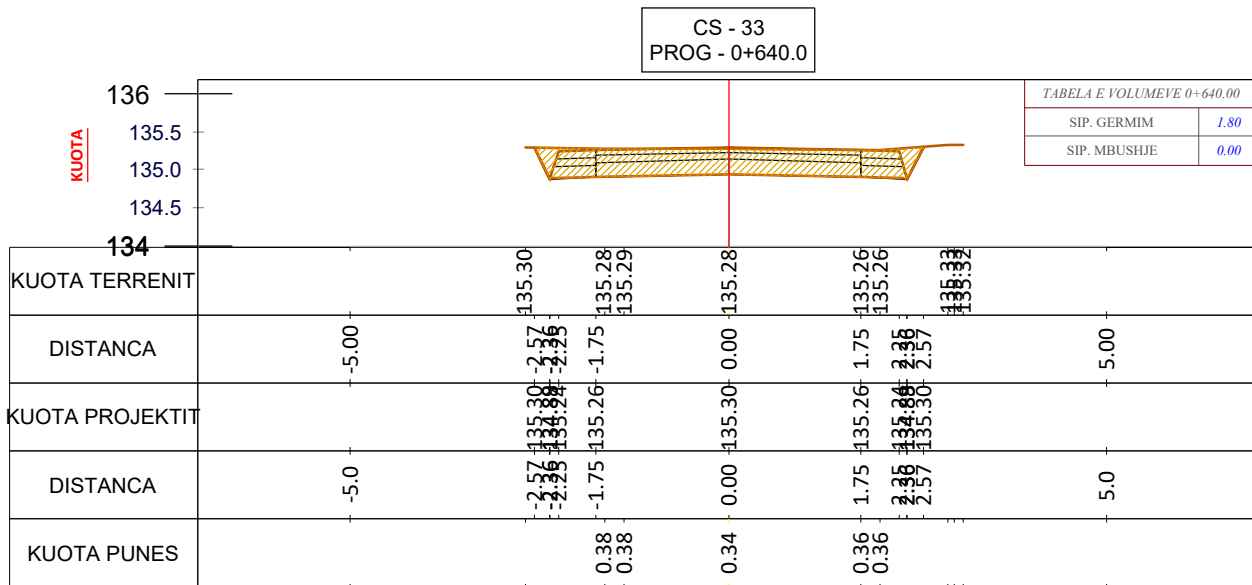

# PROFILI TERTHOR SH 1:100

## LEGJENDË

 Siperfaqe germimi

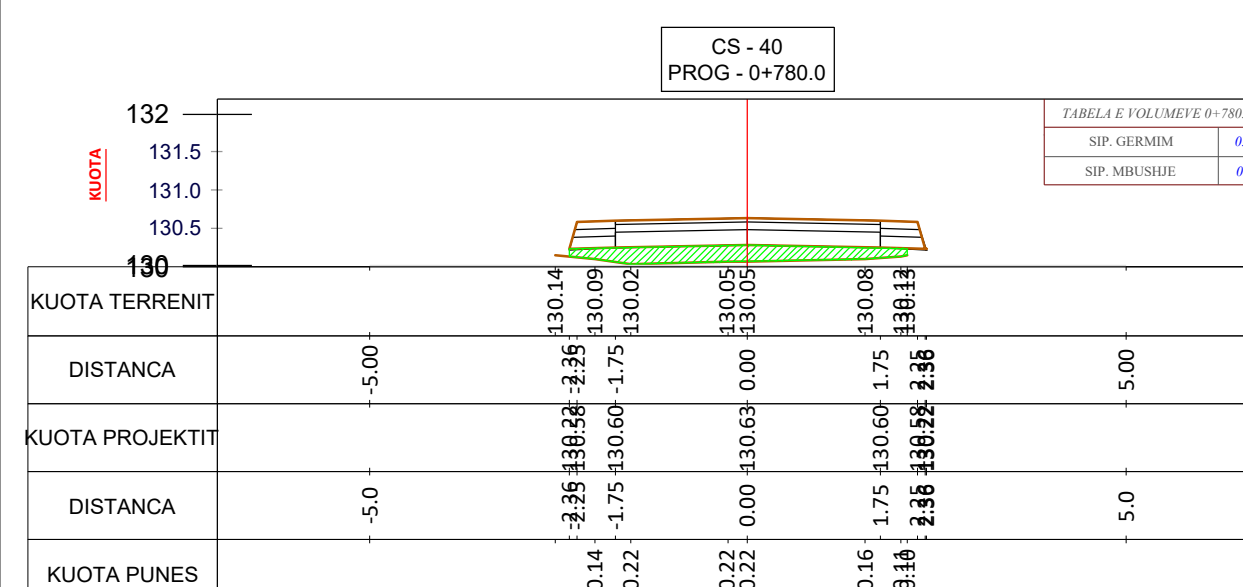
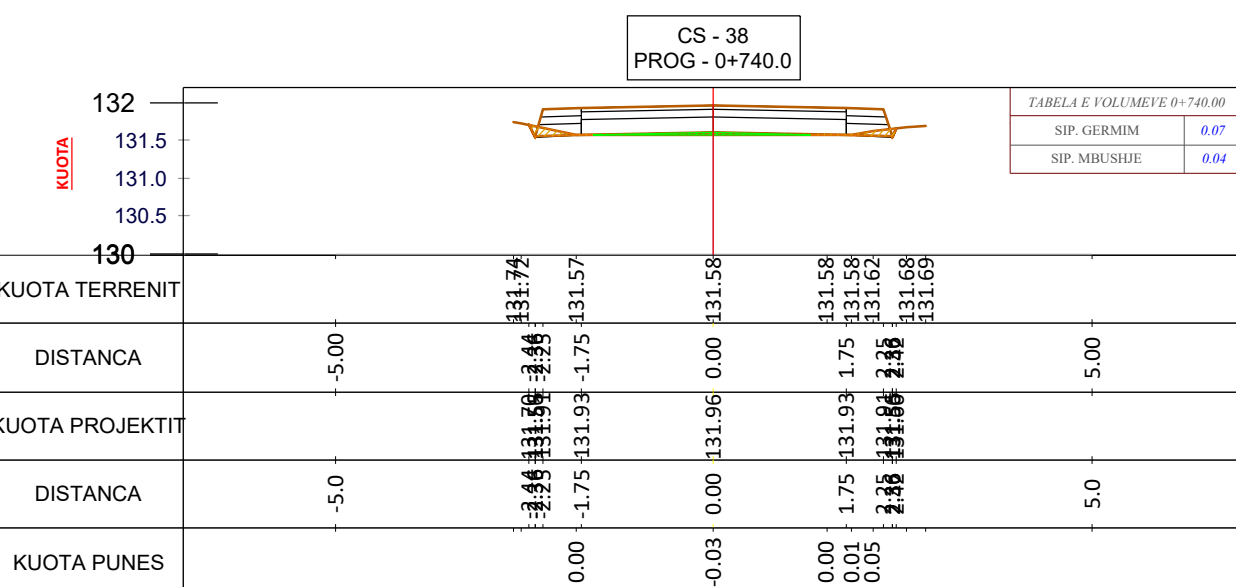
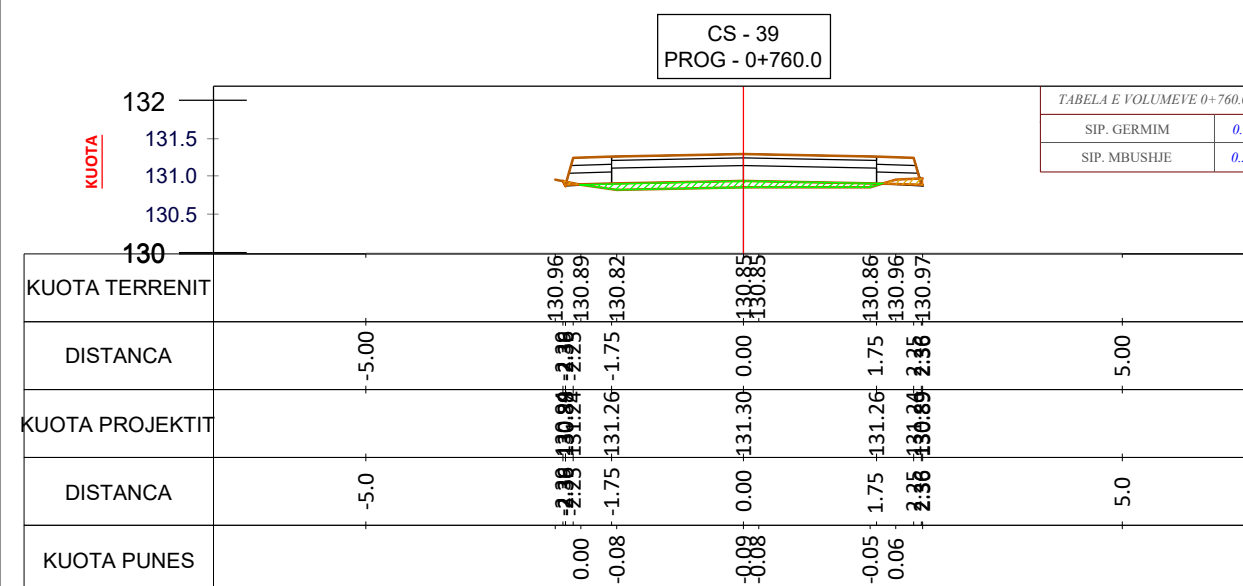
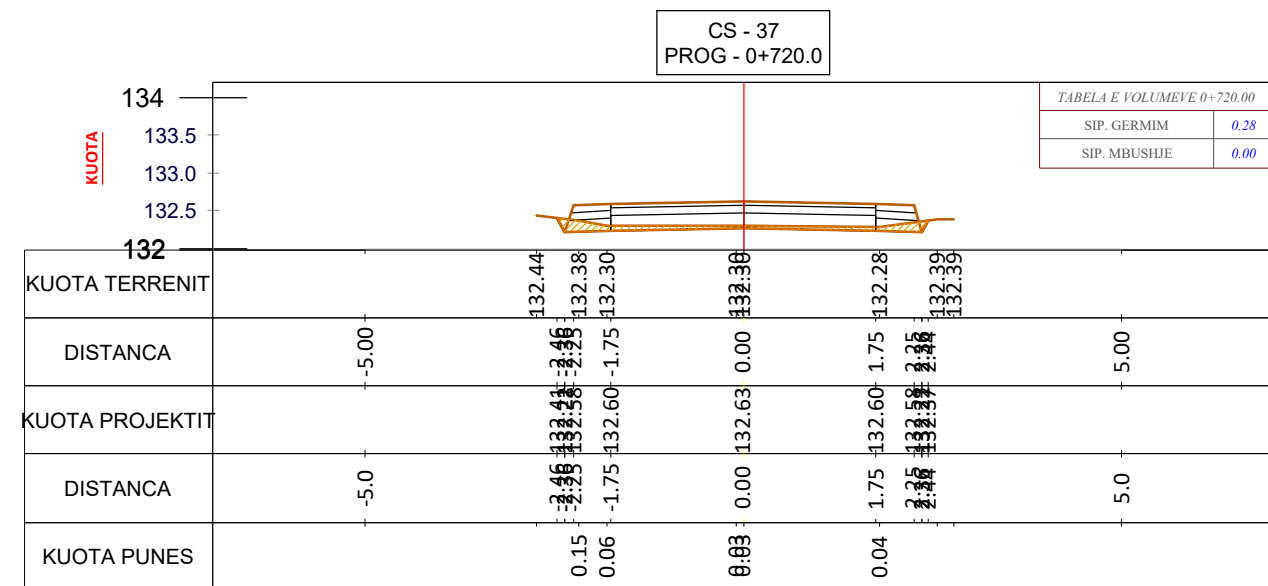

Porositës:

**Bashkia Malësia e Madhe**

Titulli i Projektit

**SISTEMIM ASFALTIM  
RRUGA KOPLIK SIPERM-LUIS**

Faza

**PROJEKT ZBATIMI**

Vula

Autor "NOVATECH STUDIO "SHPK



Grupi projektimit:

ING. NDERTIMI	Mimoza TOMCO
ARKITEKT	Gerda NOVA
ING. HIDROTEKNIK	Klodjan NDQJ
ING. HIDROTEKNIK	Kostandin NOVA
ING. GJEOLGJIK	Antonela BAZHDARI

Vula

Kapitulli

**PROJEKTI ARKITEKTONIK**

Titulli i Vizatimit

PROFILA TERTHOR

Realizuar	<b>JANAR 2023</b>	Shkalla	<b>1:100</b>
-----------	-------------------	---------	--------------

Emërtimi i Fletës

**A 1 - 49**

# PROFILI TERTHOR SH 1:100

## LEGJENDË

 Siperfaqe germimi

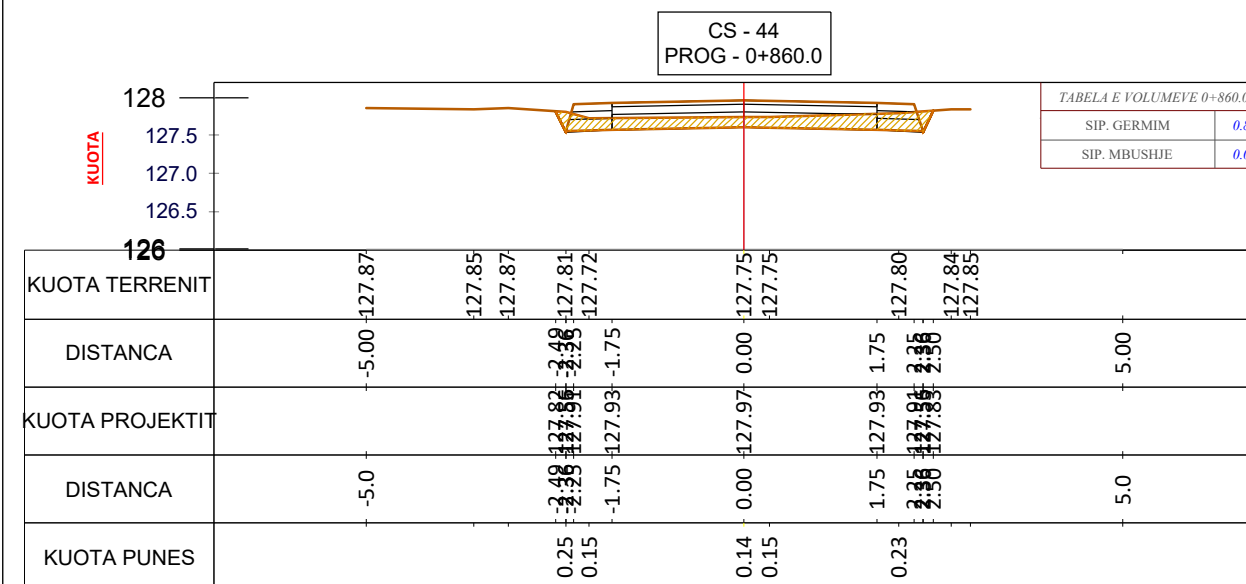
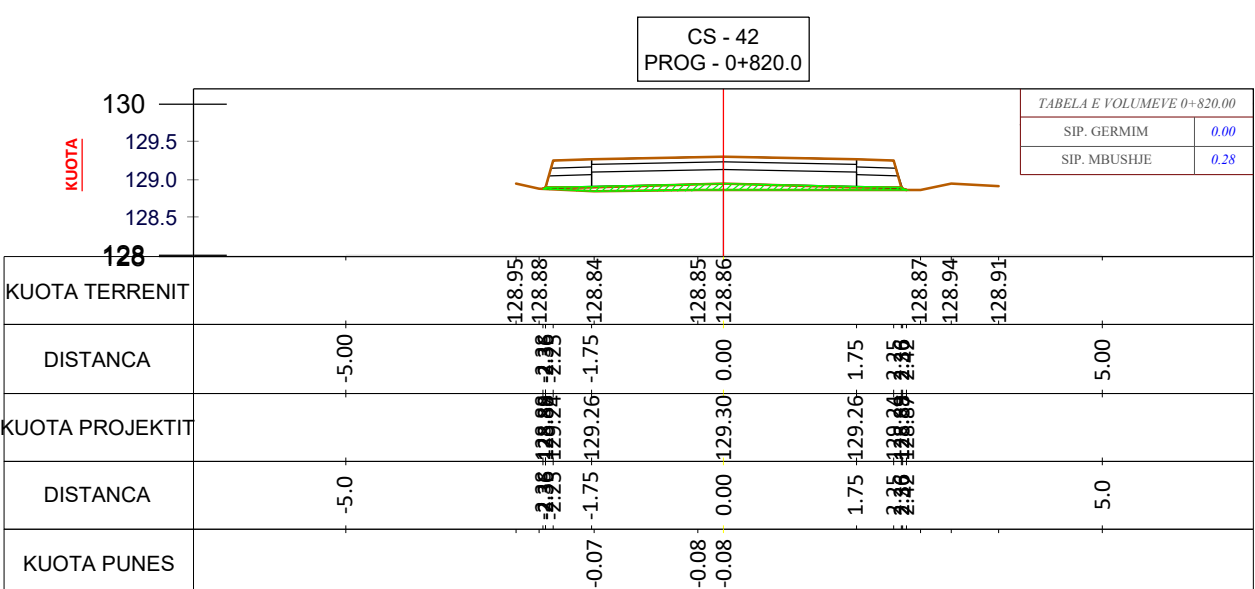
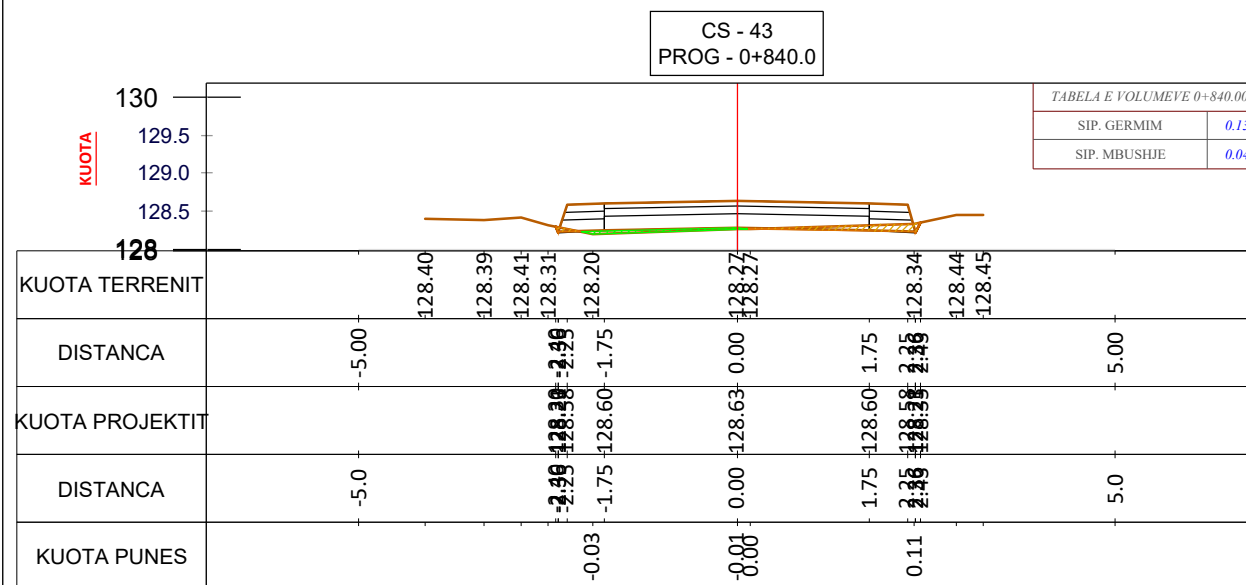
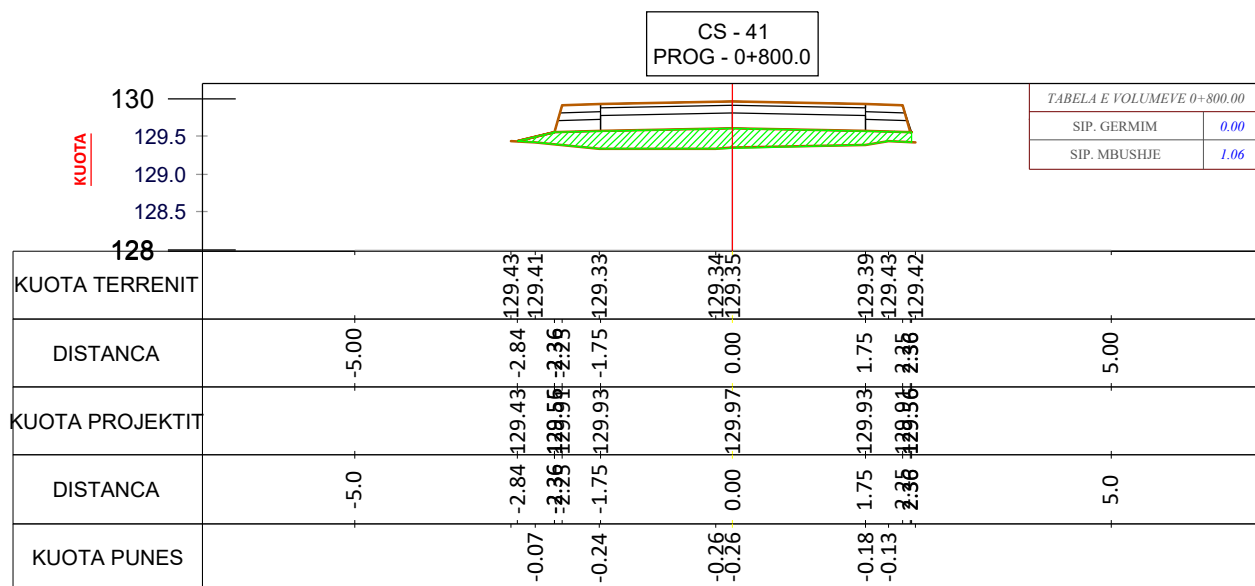

Porositës:

Bashkia Malësia e Madhe

Titulli i Projektit

SISTEMIM ASFALTIM  
RRUGA KOPLIK SIPERM-LUIS

Faza

PROJEKT ZBATIMI

Vula

Autor "NOVATECH STUDIO "SHPK



ADMIN ING. EMIL NOVA

Grupi projektimit:

ING. NDERTIMI	Mimoza TOMCO
ARKITEKT	Gerta NOVA
ING. HIDROTEKNIK	Klodjan NDOJ
ING. HIDROTEKNIK	Kostandin NOVA
ING. GJEOLOGJIK	Antonela BAZHDARI

Vula

Kapitulli

PROJEKTI ARKITEKTONIK

Titulli i Vizatimit

PROFILA TERTHOR

Realizuar **JANAR 2023** Shkalla **1:100**

Emërtimi i Fletës

**A 1 - 50**

# PROFILI TERTHOR SH 1:100

LEGJENDË

 Siperfaqe germimi

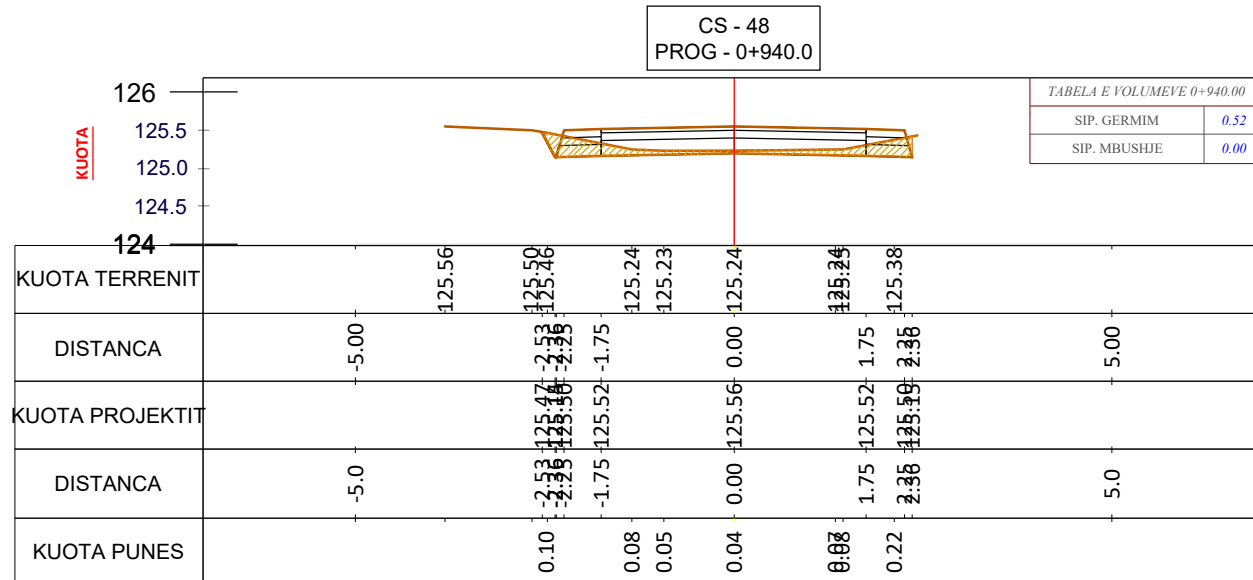
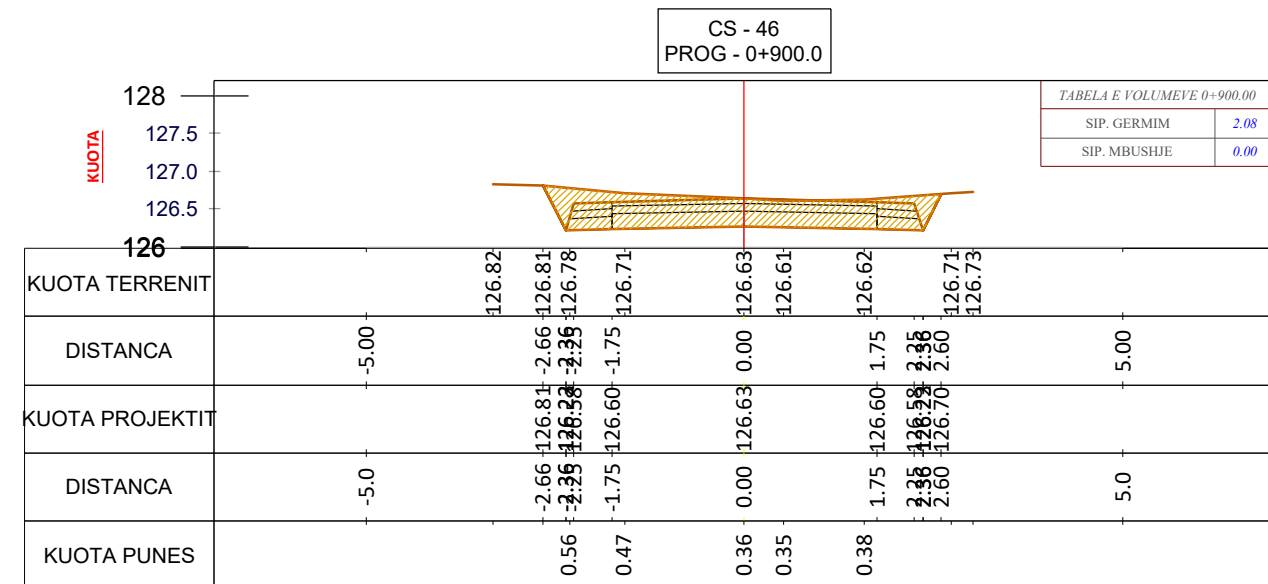
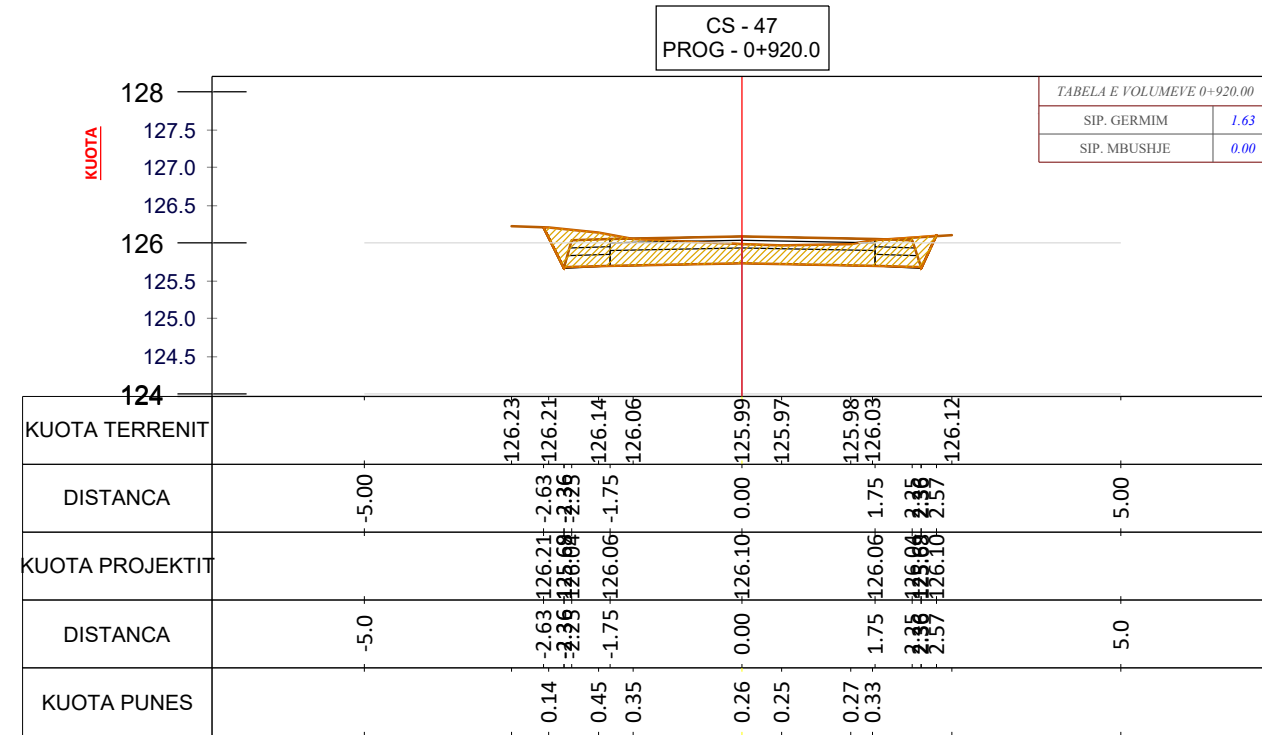
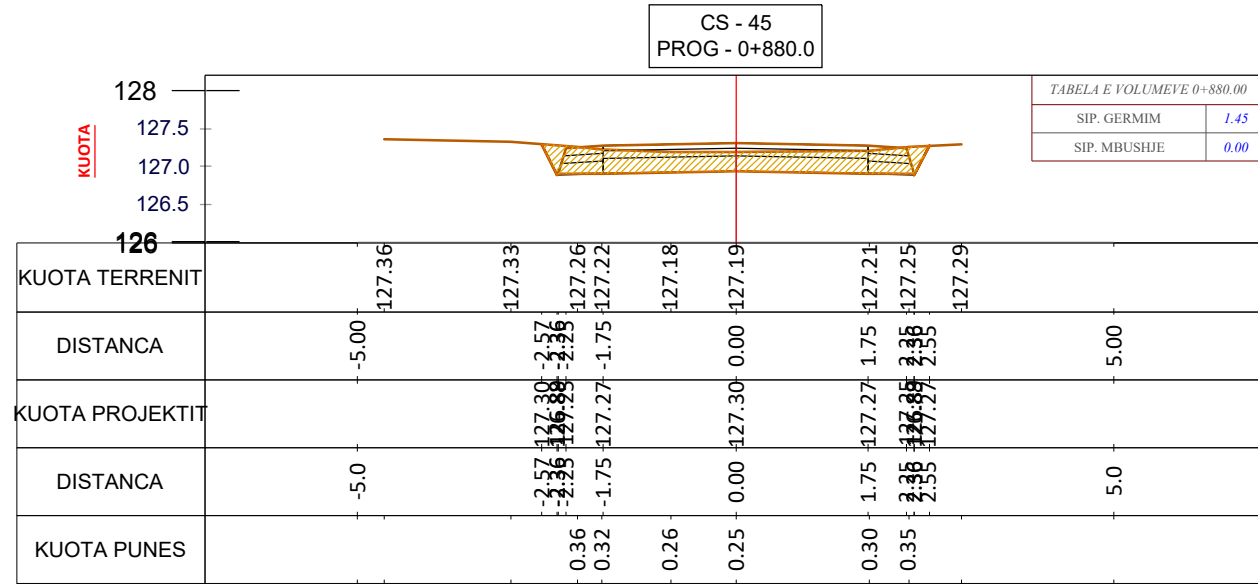

Porositës:  
**Bashkia Malësia e Madhe**

Titulli i Projektit  
**SISTEMIM ASFALTIM  
RRUGA KOPLIK SIPERM-LUIS**

Faza  
**PROJEKT ZBATIMI**

Vula  
Autor "NOVATECH STUDIO "SHPK"

  
ADMIN ING. EMIL NOVA

Grupi projektimit:  
ING. NDERTIMI MIMOZA TOMCO  
ARKITEKT GERTE NOVA  
ING. HIDROTEKNIK KLADJAN NDOJ  
ING. HIDROTEKNIK KOSTANDIN NOVA  
ING. GJEOLGJIK ANTONELA BAZHDARI

Vula  
Kapitulli  
**PROJEKTI ARKITEKTONIK**

Titulli i Vizatimit  
PROFILA TERTHOR

Realizuar **JANAR 2023** Shkalla **1:100**

Emërtimi i Fletës  
**A 1 - 51**

# PROFILI TERTHOR SH 1:100

## LEGJENDË

 Siperfaqe germimi

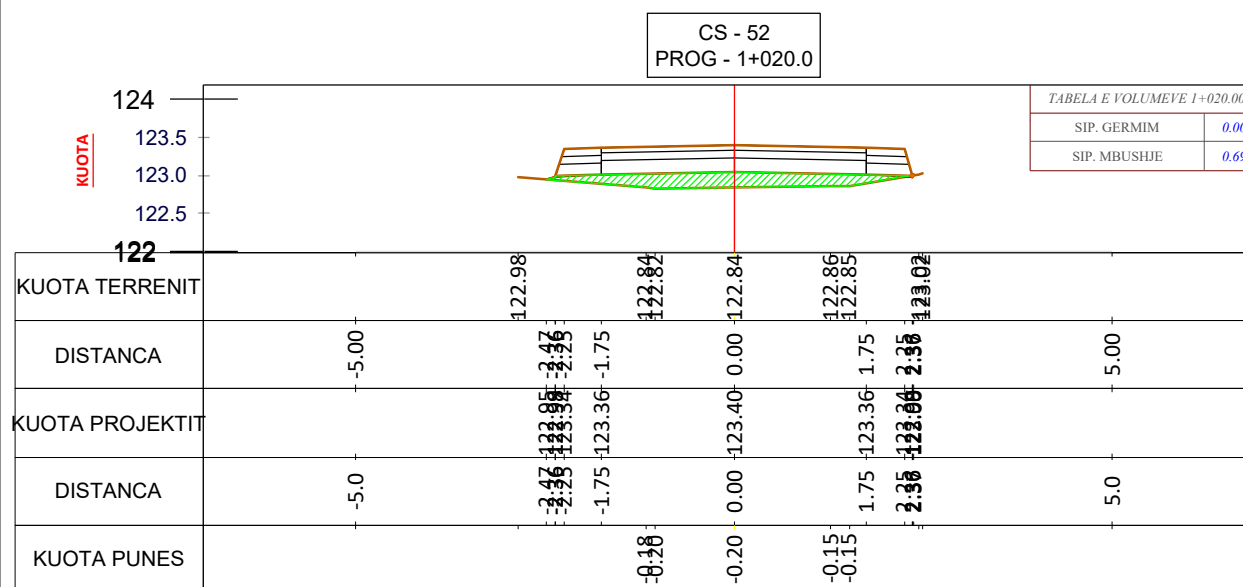
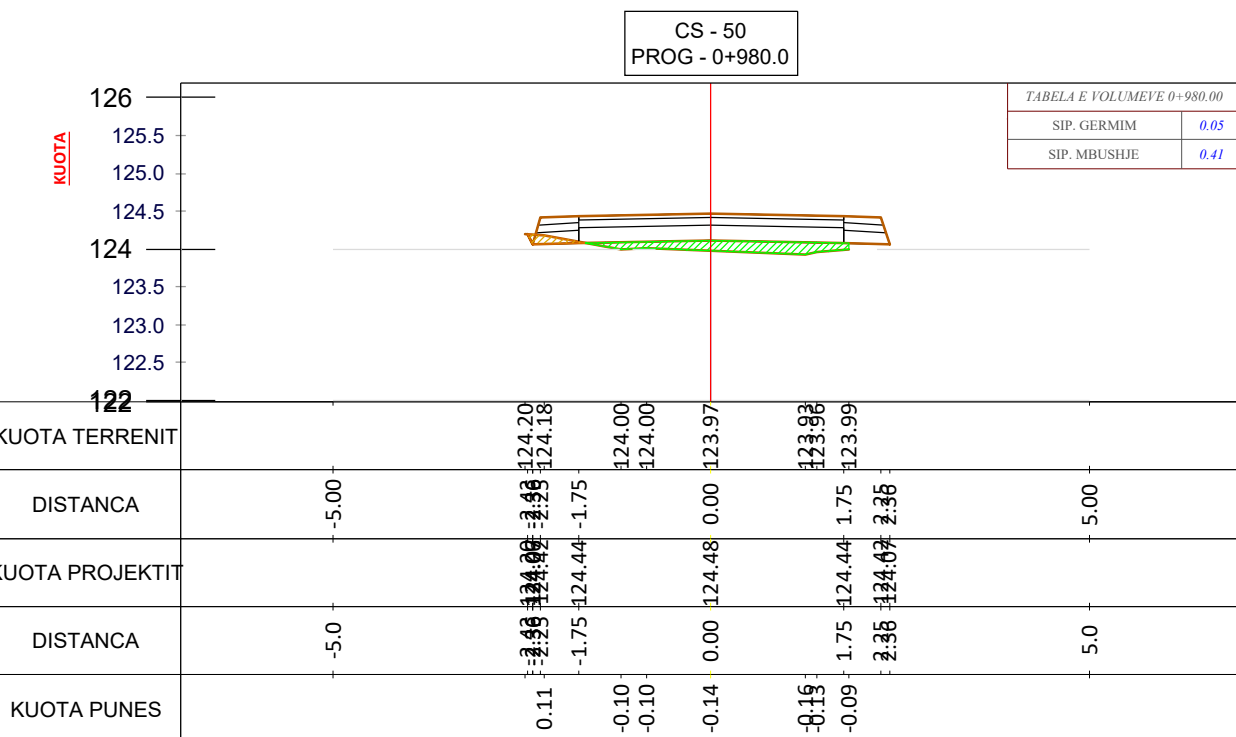
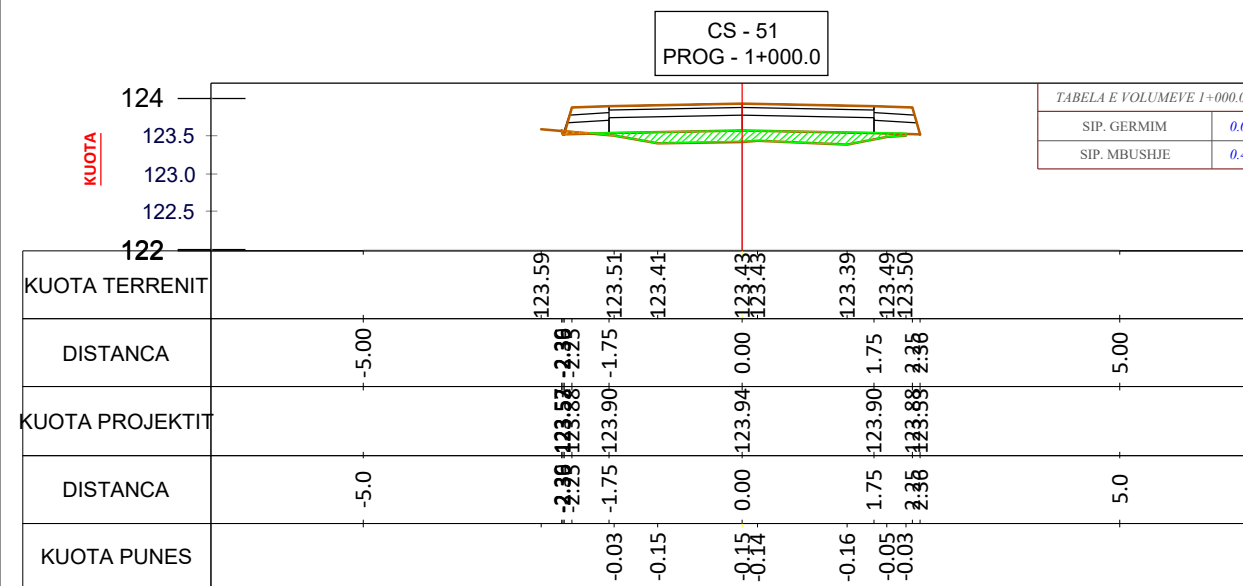
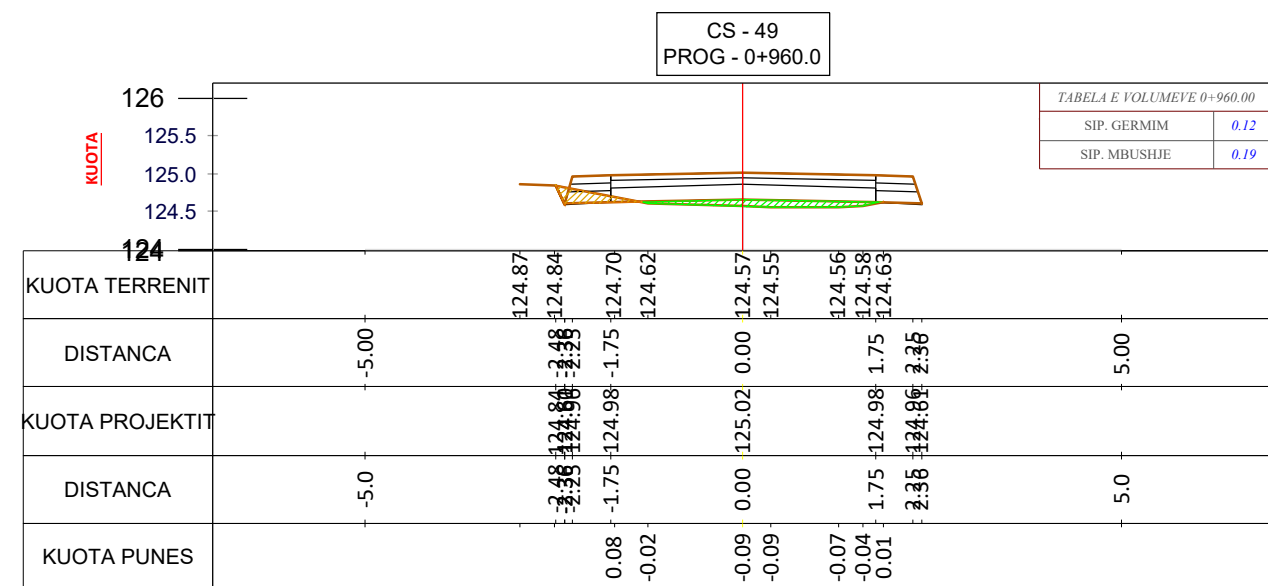

Porositës:

Bashkia Malësia e Madhe

Titulli i Projektit

SISTEMIM ASFALTIM  
RRUGA KOPLIK SIPERM-LUIS

Faza

PROJEKT ZBATIMI

Vula

Autor "NOVATECH STUDIO "SHPK



Grupi projektimit:

ING. NDERTIMI MIMOZA TOMCO  
ARKITEKT GERTA NOVA  
ING. HIDROTEKNIK KLADJAN NDOJ  
ING. HIDROTEKNIK KOSTANDIN NOVA  
ING. GJEOLGJIK ANTONELA BAZHDARI

Vula

Kapitulli

PROJEKTI ARKITEKTONIK

Titulli i Vizatimit

PROFILA TERTHOR

Realizuar JANAR 2023

Shkalla 1:100

Emërtimi i Fletës

A 1 - 52

# PROFILI TERTHOR SH 1:100

## LEGJENDË

 Siperfaqe germimi

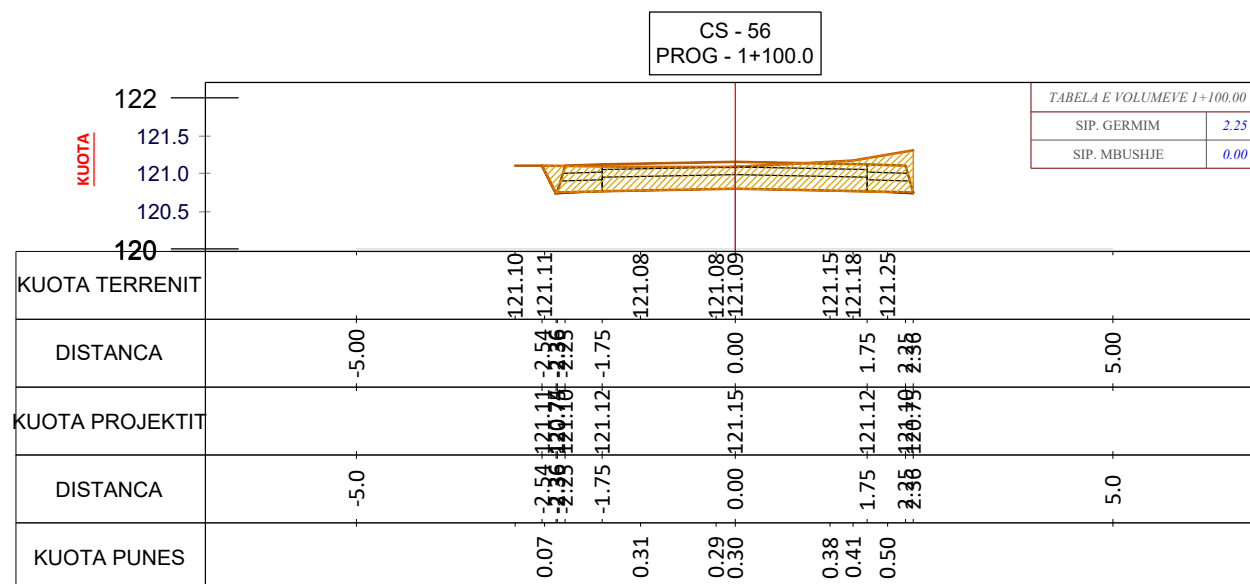
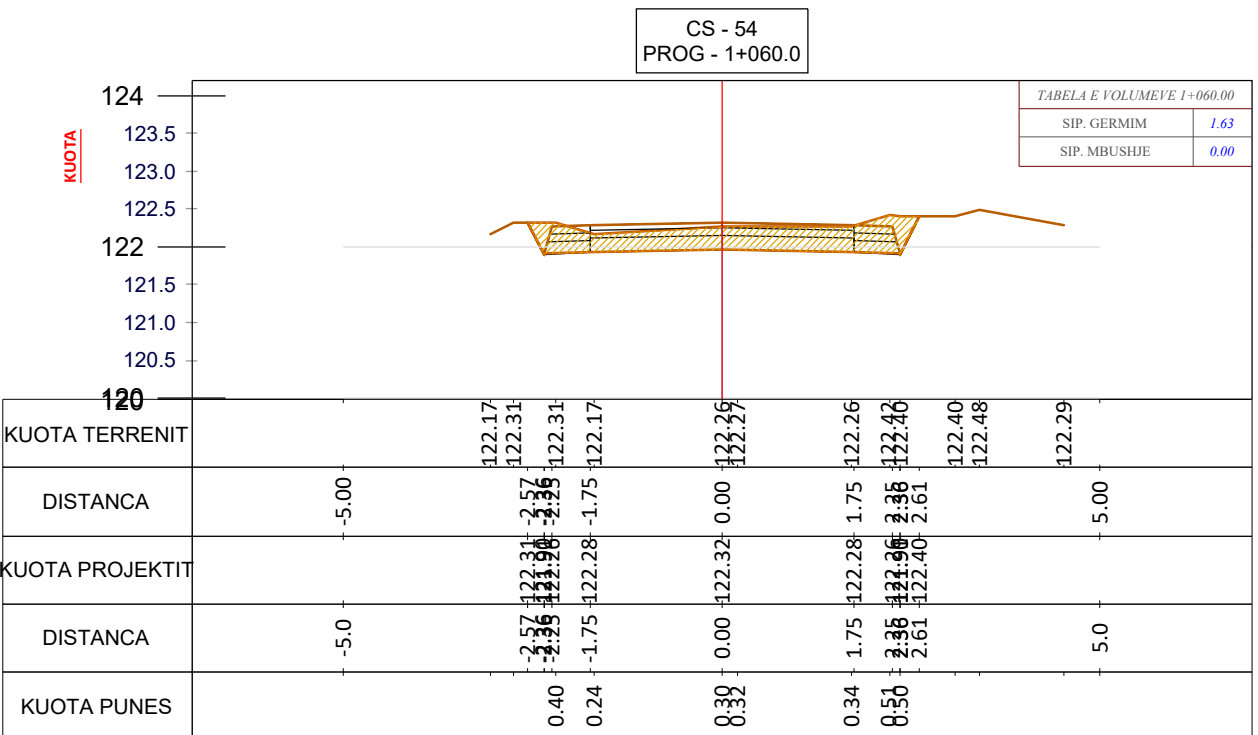
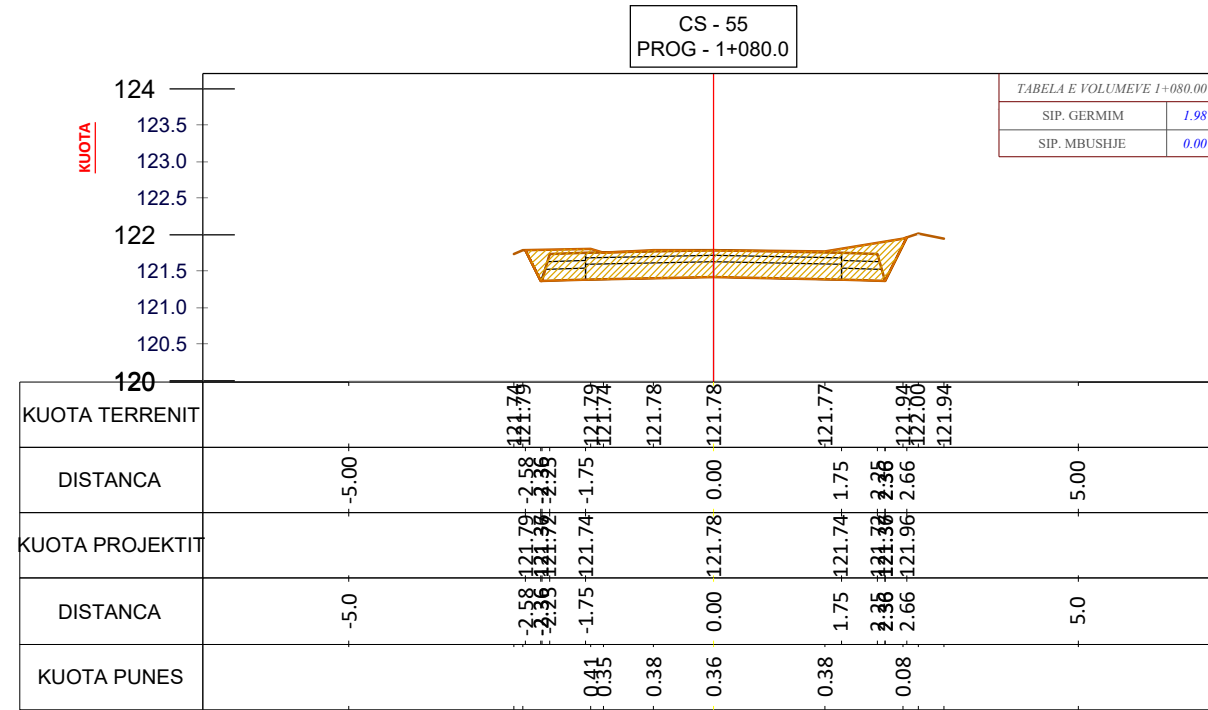
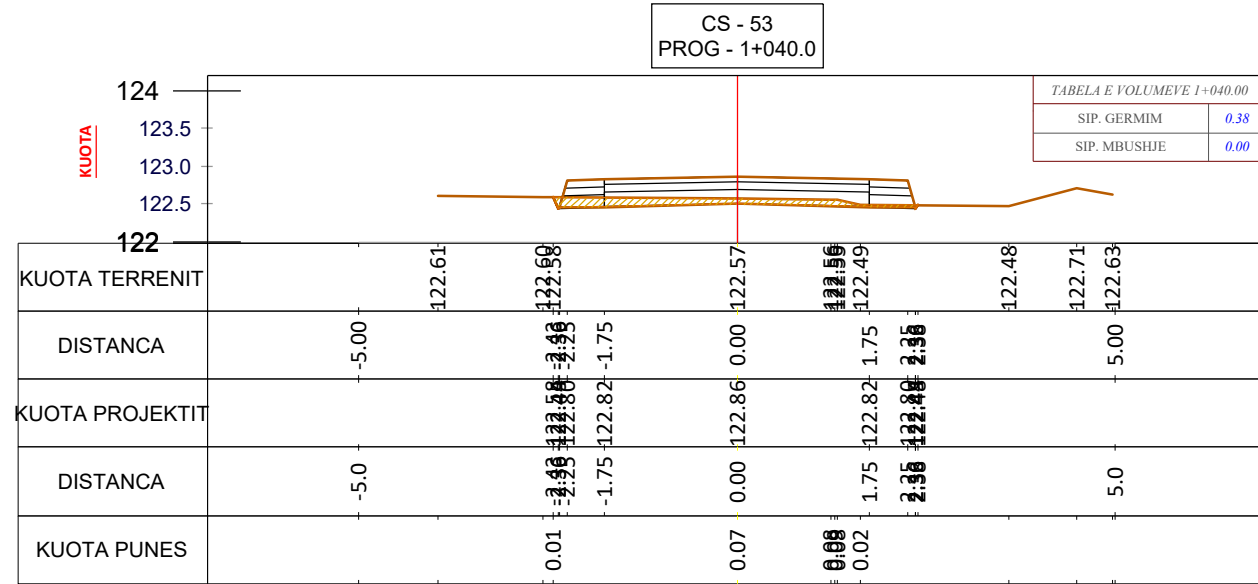

Porositës:

Bashkia Malësia e Madhe

Titulli i Projektit

SISTEMIM ASFALTIM  
RRUGA KOPLIK SIPERM-LUIS

Faza

PROJEKT ZBATIMI

Vula

Autor "NOVATECH STUDIO "SHPK

  
ADMIN ING. EMIL NOVA

Grupi projektimit:

ING. NDERTIMI	Mimoza TOMCO
ARKITEKT	Gerta NOVA
ING. HIDROTEKNIK	Klodjan NDQJ
ING. HIDROTEKNIK	Kostandin NOVA
ING. GJEOLGJIK	Antonela BAZHDARI

Vula

Kapitulli

PROJEKTI ARKITEKTONIK

Titulli i Vizatimit

PROFILA TERTHOR

Realizuar JANAR 2023

Shkalla 1:100

Emërtimi i Fletës

**A 1 - 53**

# PROFILI TERTHOR SH 1:100

## LEGJENDË

 Siperfaqe germimi

CS - 57  
PROG - 1+120.0

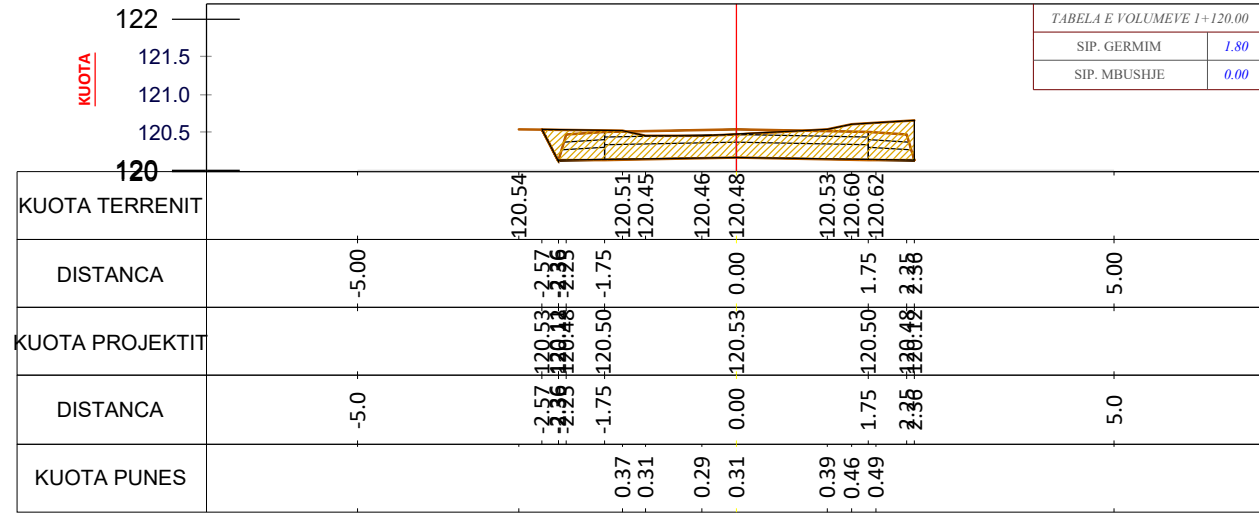

CS - 59  
PROG - 1+160.0

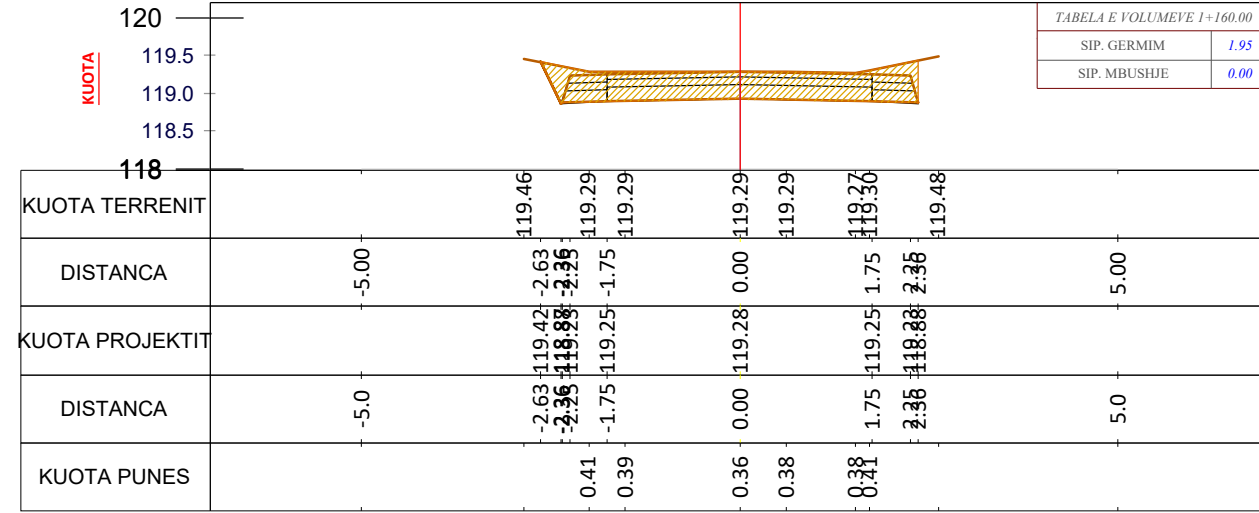

CS - 58  
PROG - 1+140.0

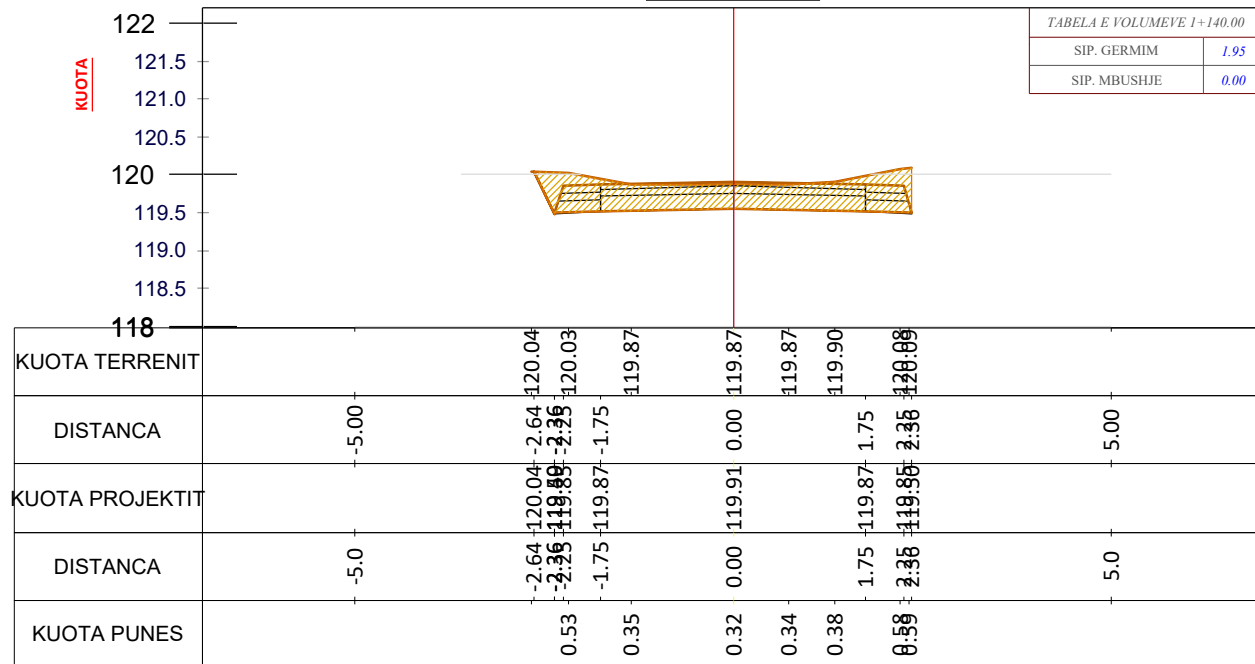

CS - 60  
PROG - 1+180.0

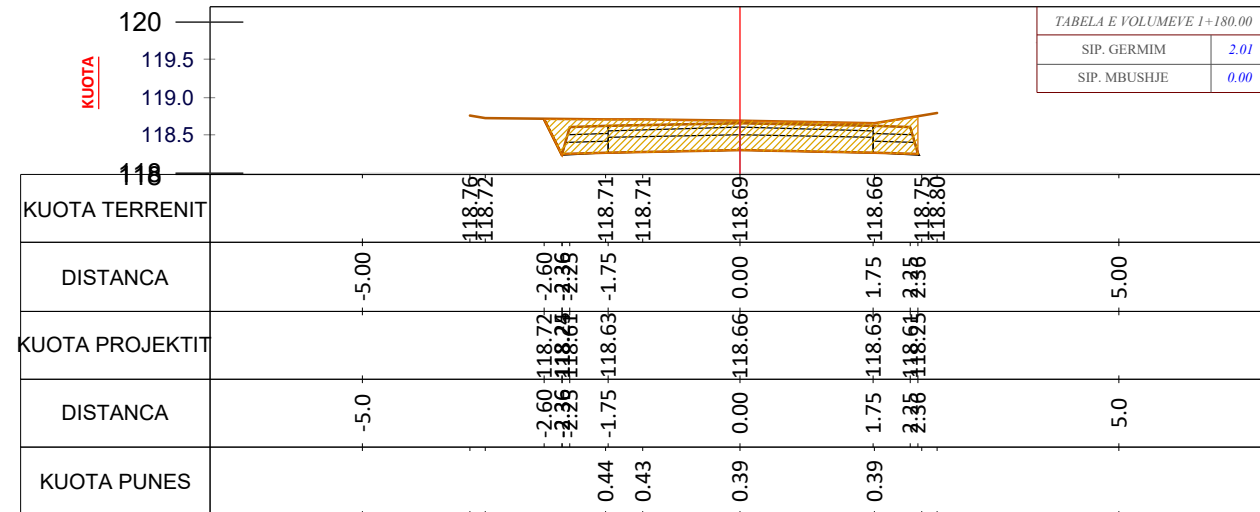

Porositës:

Bashkia Malësia e Madhe

Titulli i Projektit

SISTEMIM ASFALTIM  
RRUGA KOPLIK SIPERM-LUIS

Faza

PROJEKT ZBATIMI

Vula

Autor "NOVATECH STUDIO "SHPK



Grupi projektimit:

ING. NDERTIMI MIMOZA TOMCO  
ARKITEKT GERTE NOVA  
ING. HIDROTEKNIK KLADJAN NDOJ  
ING. HIDROTEKNIK KOSTANDIN NOVA  
ING. GJEOLGJIK ANTONELA BAZHDARI

Vula

Kapitulli

PROJEKTI ARKITEKTONIK

Titulli i Vizatimit

PROFILA TERTHOR

Realizuar JANAR 2023

Shkalla 1:100

Emërtimi i Fletës

A 1 - 54

# PROFILI TERTHOR SH 1:100

## LEGJENDË

 Siperfaqe germimi

CS - 57  
PROG - 1+120.0

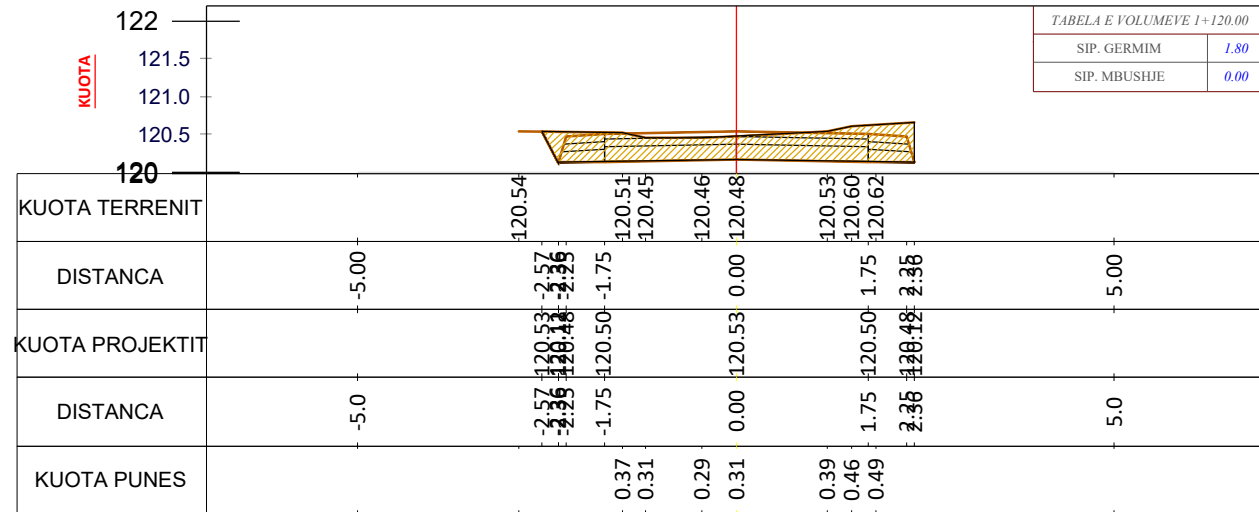

CS - 59  
PROG - 1+160.0

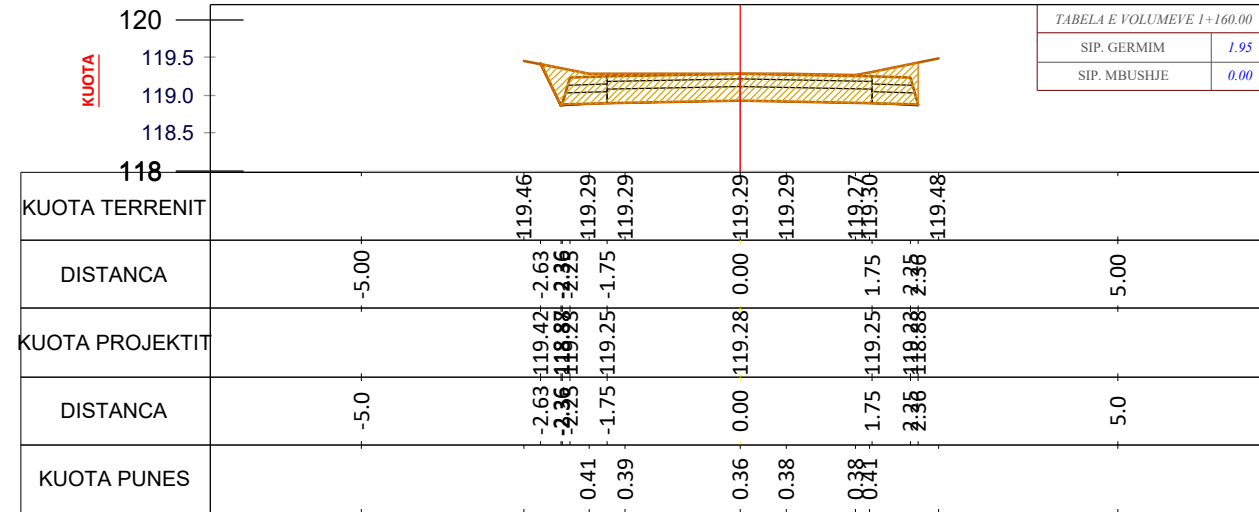

CS - 58  
PROG - 1+140.0

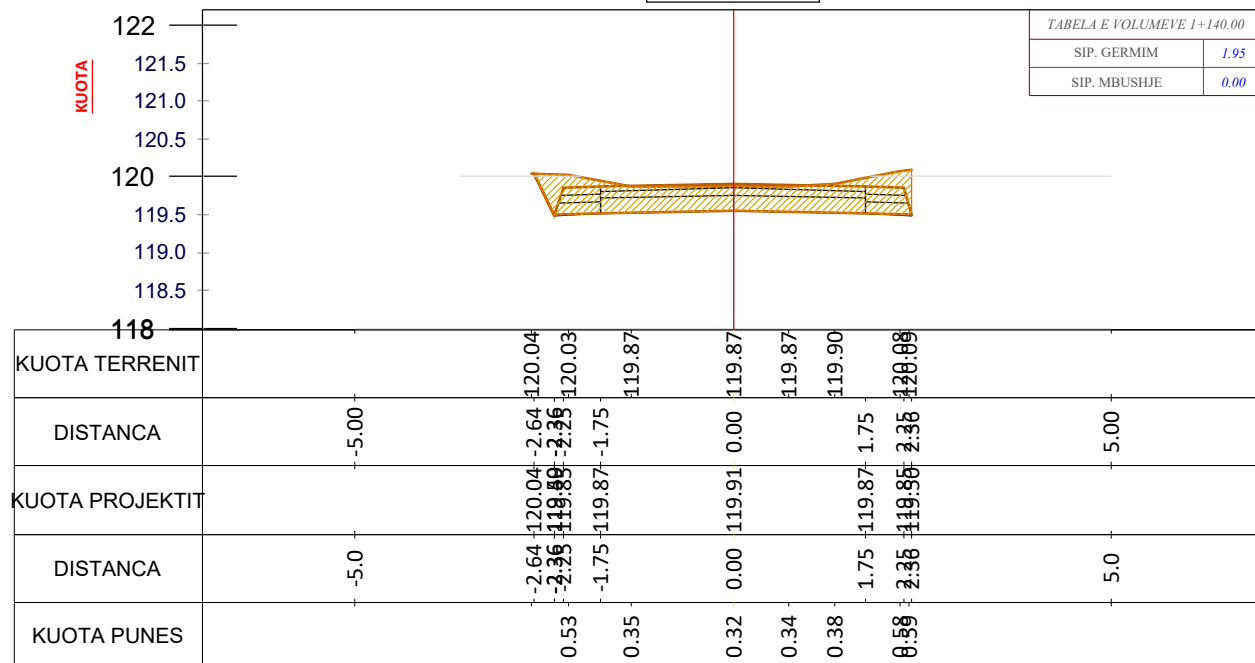

CS - 60  
PROG - 1+180.0

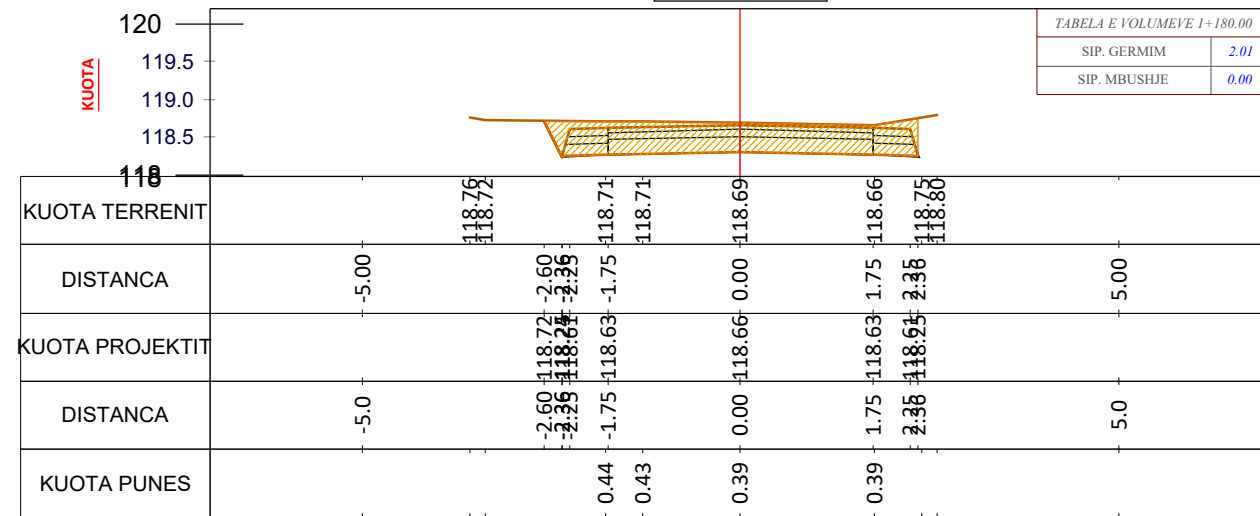

Porositës:

Bashkia Malësia e Madhe

Titulli i Projektit

SISTEMIM ASFALTIM  
RRUGA KOPLIK SIPERM-LUIS

Faza

PROJEKT ZBATIMI

Vula

Autor "NOVATECH STUDIO "SHPK



Grupi projektimit:

ING. NDERTIMI MIMOZA TOMCO  
ARKITEKT GERTE NOVA  
ING. HIDROTEKNIK KLADJAN NDOJ  
ING. HIDROTEKNIK KOSTANDIN NOVA  
ING. GJEOLGJIK ANTONELA BAZHDARI

Vula

Kapitulli

PROJEKTI ARKITEKTONIK

Titulli i Vizatimit

PROFILA TERTHOR

Realizuar JANAR 2023

Shkalla 1:100

Emërtimi i Fletës

A 1 - 55



# PROFILI TERTHOR SH 1:100

## LEGJENDË

 Siperfaqe germimi

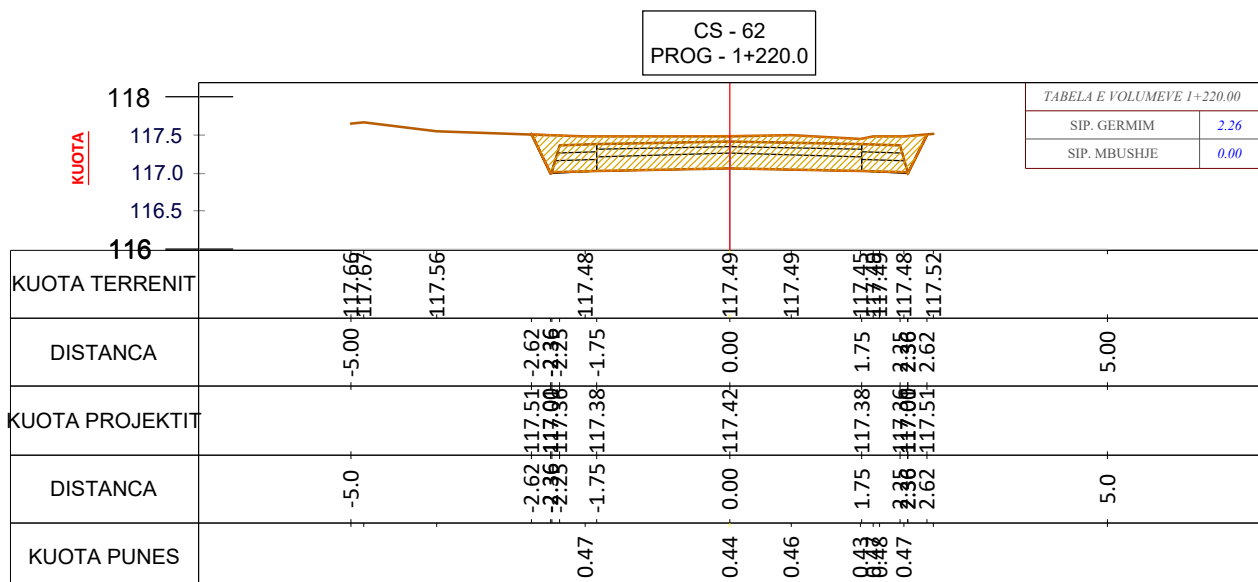
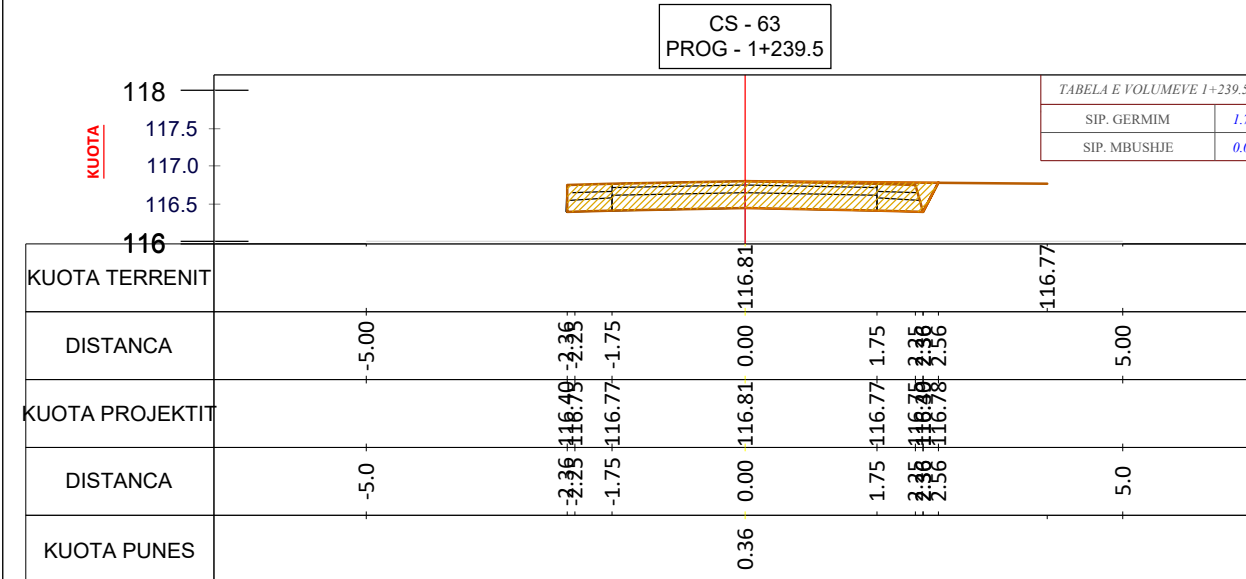
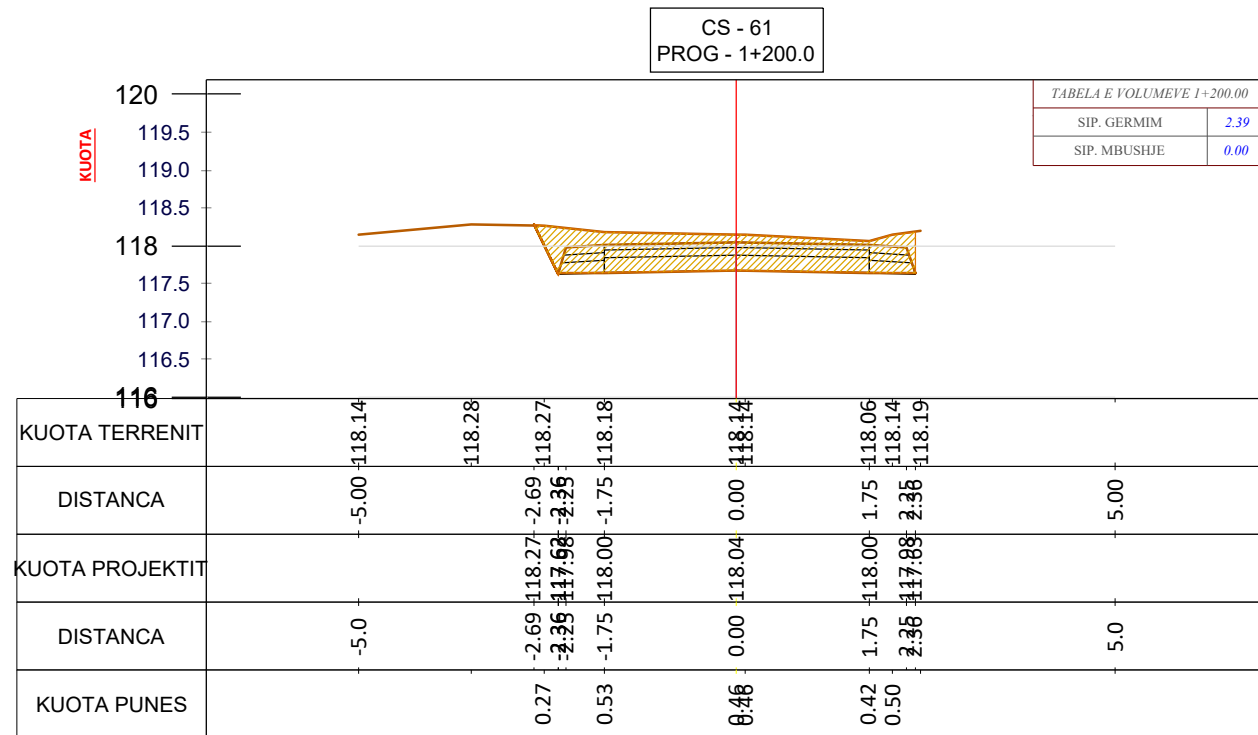

**Porositës:**  
Bashkia Malësia e Madhe

**Titulli i Projektit**  
SISTEMIM ASFALTIM  
RRUGA KOPLIK SIPERM-LUIS

**Faza**  
PROJEKT ZBATIMI

**Vula**  
Autor "NOVATECH STUDIO "SHPK

**ADMIN ING. EMIL NOVA**

**Grupi projektimit:**  
ING. NDERTIMI MIMOZA TOMCO  
ARKITEKT GERTE NOVA  
ING. HIDROTEKNIK KLADJAN NDOJ  
ING. HIDROTEKNIK KOSTANDIN NOVA  
ING. GJEOLGJIK ANTONELA BAZHDARI

**Kapitulli**  
PROJEKTI ARKITEKTONIK

**Titulli i Vizatimit**  
PROFILA TERTHOR

Realizuar **JANAR 2023** Shkalla **1:100**

Emërtimi i Fletës  
**A 1 - 56**

# PROFILI TERTHOR ASKSI II SH 1:100

TABELA E VOLUMEVE 0+000.00	
SIP. GERMIM	0.92
SIP. MBUSHJE	0.00

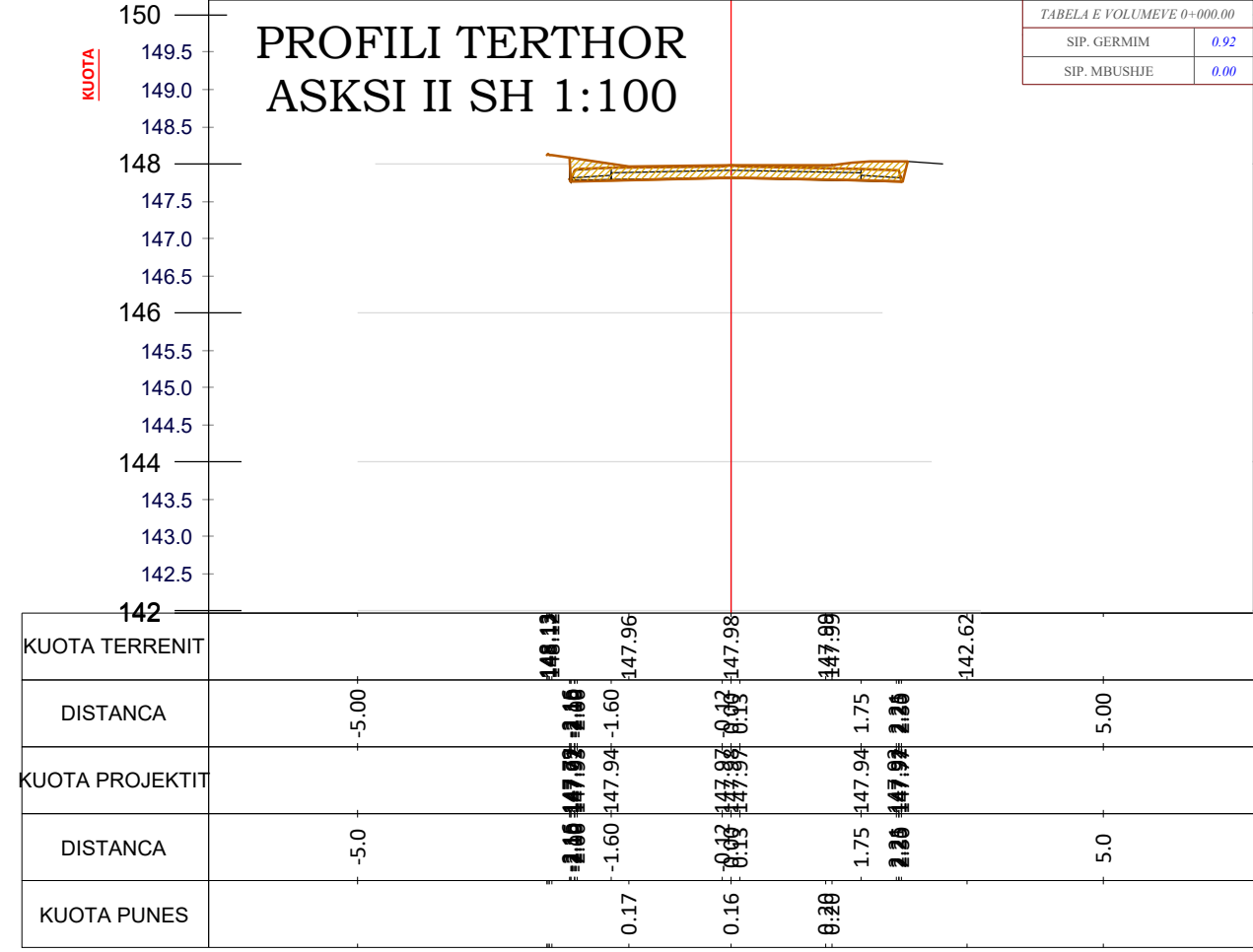

CS - 10  
PROG - 0+180.0

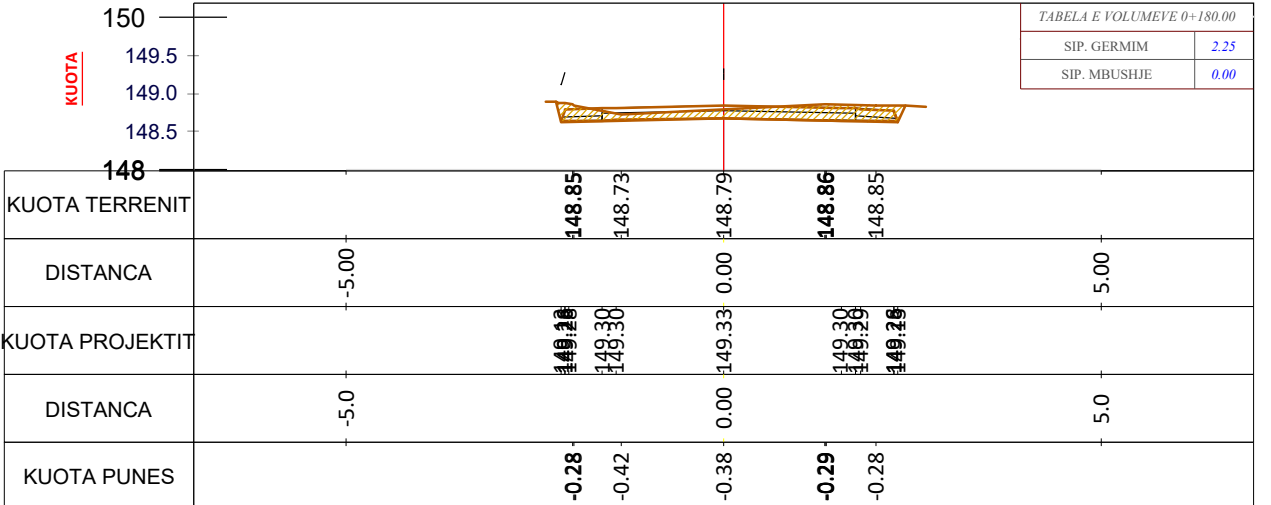

CS - 11  
PROG - 0+200.0

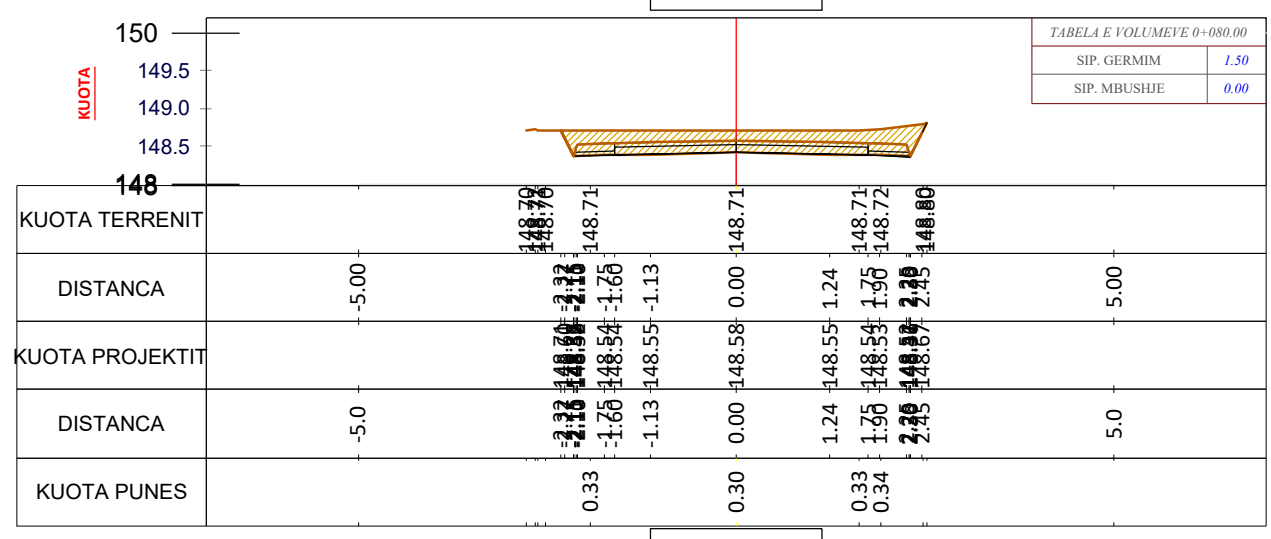
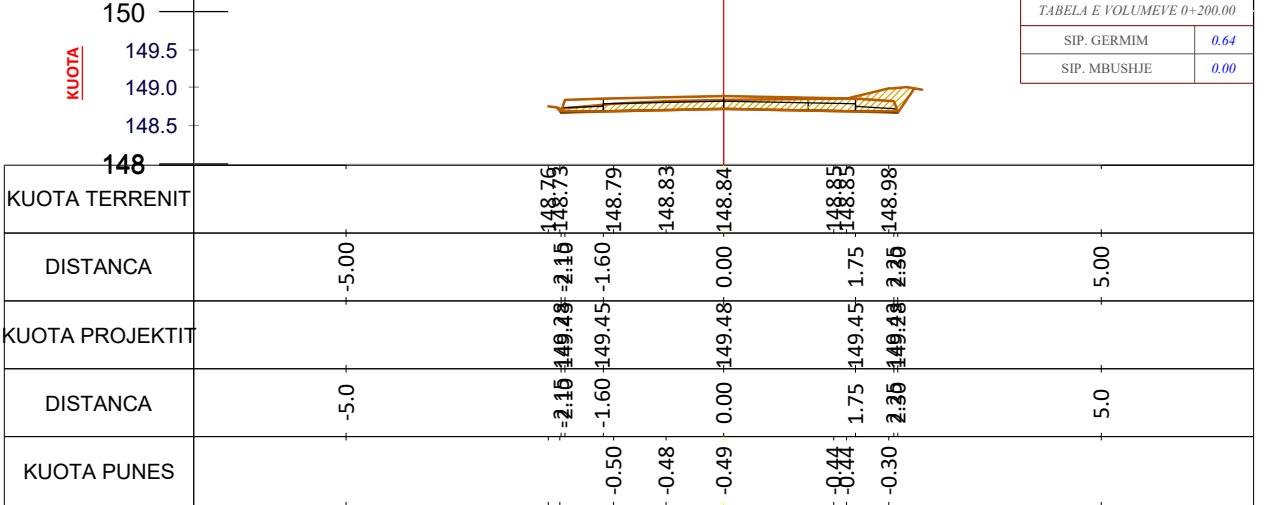

CS - 6  
PROG - 0+100.0

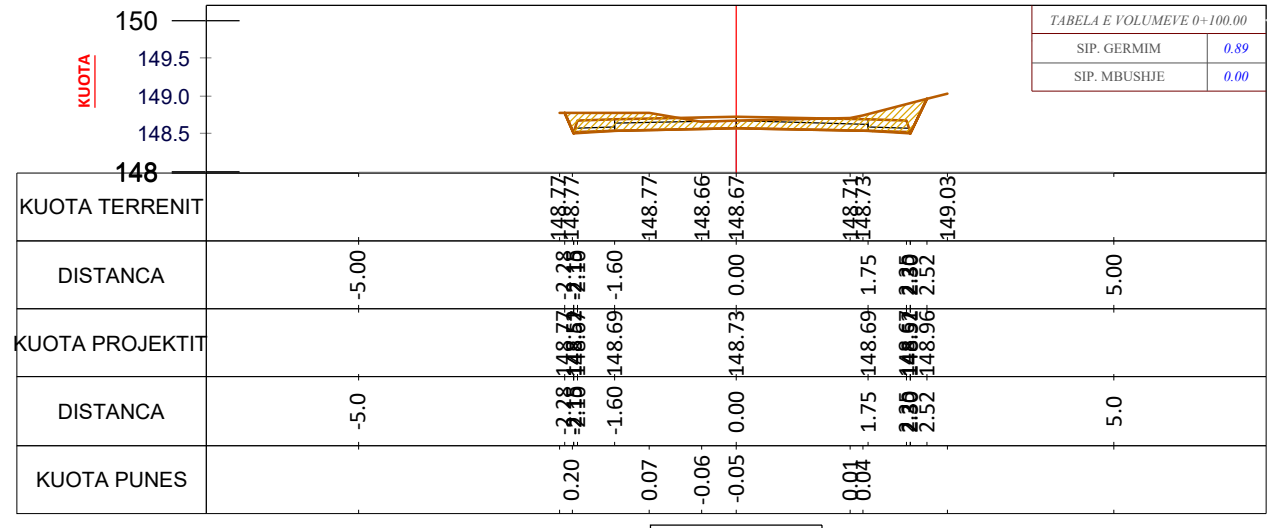

CS - 7  
PROG - 0+120.0

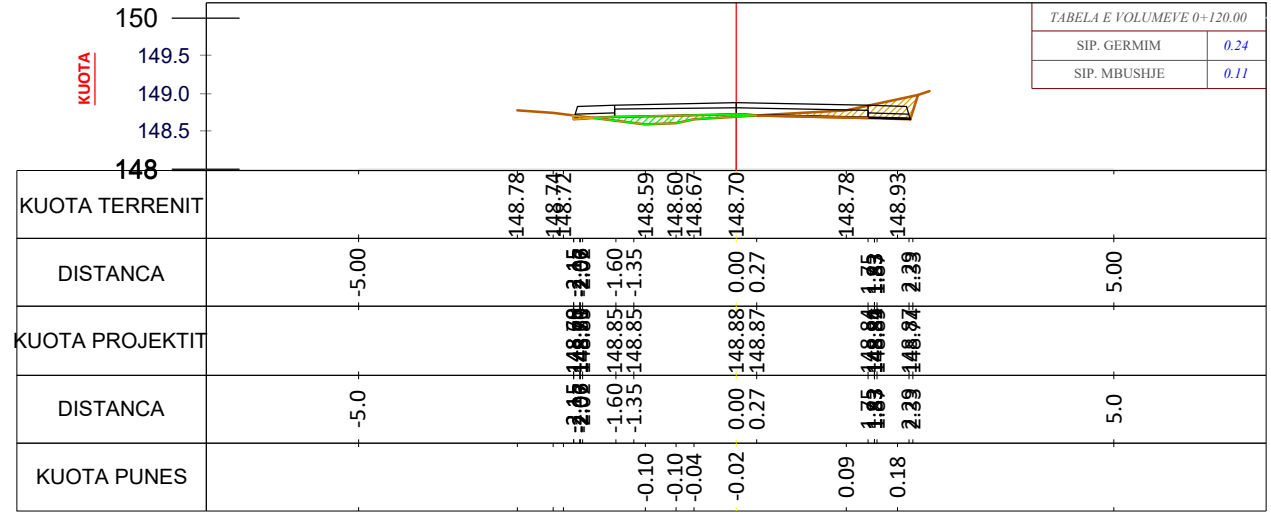

LEGJENDË  
Siperfaqe germimi

Porositës:  
Bashkia Malësia e Madhe

Titulli i Projektit  
SISTEMIM ASFALTIM  
RRUGA KOPLIK SIPERM-LUIS

Faza  
PROJEKT ZBATIMI

Vula  
Autor  
"NOVATECH STUDIO "SHPK  
ADMIN ING. EMIL NOVA

Grupi projektimit:  
ING. NDERTIMI MIMOZA TOMCO  
ARKITEKT GERTE NOVA  
ING. HIDROTEKNIK KLADJAN NDOJ  
ING. HIDROTEKNIK KOSTANDIN NOVA  
ING. GJEOLGJIK ANTONELA BAZHDARI

Kapitulli  
PROJEKTI ARKITEKTONIK

Titulli i Vizatimit  
PROFILA TERTHOR AKSI II

Realizuar JANAR 2023 Shkalla 1:100

Emërtimi i Fletës  
A 1 - 57