

**QENDER
SUKE**



PODGORAN

FUSHE

PROJEKT ZBATIMI

OBJEKTI:

"SISTEMIM ASFALTIM I RRUGES QENDER SUKE - PODGORAN FUSHE"

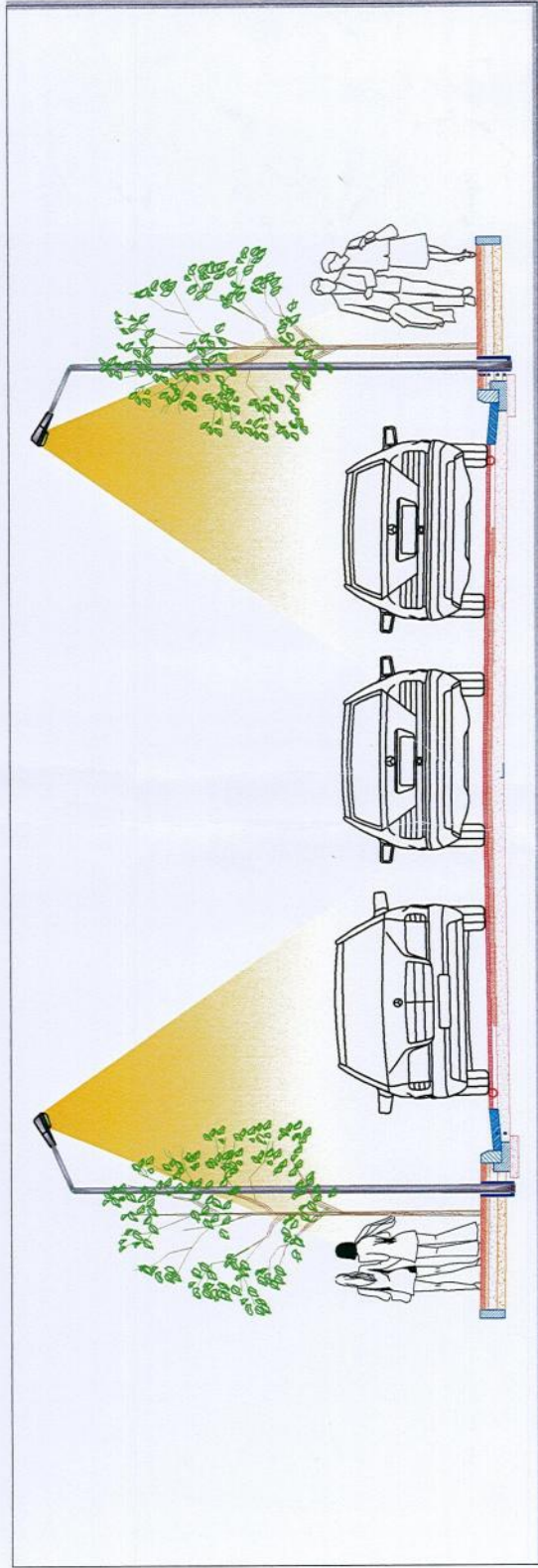

STUDIO "DERBI-E"

TETOR 2008

**Projekti : " Sistemim – Asfaltim i rruges
Qender Suke – Podgoran Fushe ",**



Tirane 2008

Përmbajtja

I.a. Punime betoni	2
1/1, 1/2 Prishje totale	3
2/3. Gërmim dheu seksion i detyruar :	3
2/4. Ndertim bankina anesore :	3
2/5. Gërmim dheu seksion i lire:	3
2/6. Mbushje me material shkembor :	4
3/7. Shtrese zhavori nen kunete:	4
3/8. Beton M-200 per kunete :	4
3/9. F.V Bordura betoni te Parapregaditura	
20x30x100 cm :	4
3/10. Mure betoni M-150 :	5
3/13, 4/17. Beton M-100 nen bordura e tubat e	
betonit :	5
4. Punime Tombino ne Rruge :	5
4/14. Gërmim dheu per kanalet :	5
4/15. Shtrese zhavori nen tuba :	5
4/16. Shtrese rere nen, anash dhe mbi tuba :	
	5
4/18. Mbushja e kanaleve me zhavor :	6
4/19, 20, 21. F.V. tuba pvc, d=200mm, 400 mm :	
4/22. F.V. tuba betoni, d=500 mm :	6
4/23. F.V. tuba b/a, d=600 mm :Error! Bookmark	
not defined.	
4/24. Ndertim puseta me zgare gize per KUB :	
5/25, 26. Shtrese cakulli makinerie, 1x15 cm,	
gran.10/60 mm, 5/50 mm :	6
5/27.Shtrese stabilizanti 1x10cm,gran.5/35mm:	
	6
5/28. Shtrese binderi me trashesi 6 cm :	7
5/29. Shtrese asfaltobetoni me trashesi 4 cm :	
	7

I. Paraqitje

Ky 'Specifikim Teknik', si dokument kontraktual, është hartuar enkas nga grupi i projektimit për projektin "Projekti Sistemim – Asfaltim i rruges Qender Suke – Podgoan Fushe", Komuna Suke. Zerat e rradhitura në përmbajtje, janë pjesë dhe përshkrime të detajuara të vizatimeve të bera nga projektuesit. Standartet e përdorura në këtë 'Specifikim Teknik', nuk kanë qenë mbështetur vetëm në vizatimet por dhe në manualët ligjore dhe libra të tjera keshillues si:

- Manuali nr.1 i "Analizat Teknike për prodhimin e materialeve të ndërtimit, udhëzime dhe kritere"

Tirane - Dhjetor 1992 (Republika e Shqipërisë - Ministria e Ndërtimit),

Projektimi i Betoneve të Zakonshme, K.T. 37-75,

Tirane - 1980 (Republika e Shqipërisë - Ministria e Ndërtimeve I.S.P.Nr. 1).

Raportet e mëposhtme për betonin, përdorur në punimet e ndërtimit dhe referuar zerave specifike, janë të vëshme për 1(një) m³ volum beton me çimento të zakonshme Portland. Këto standarte bazohen në broshurën "Projektimi i Betoneve të Zakonshme, K.T. 37-75",

Tirane 1980 (Republika e Shqipërisë - Ministria e Ndërtimeve I.S.P.Nr. 1)

II. Betoni

(Sasia për 1 m³)

I.a. Punime betoni

- I.a.1 Beton marka 100** me *inerte*, konsistencë 3-5 cm, granil deri 20 mm, rërë e lare me modul 2,6: Çimento 300 kg 240 , rërë e lare m³ 0,45 , granil m³ 0,70 , uje m³ 0,19 .
- I.a.2 Beton marka 150** me *inerte* , konsistencë 3-5 cm, granil deri 20 mm, rërë e lare me modul 2,6: Çimento 400 kg 260 , rërë e lare m³ 0,44 , granil m³ 0,70, uje m³ 0,18.
- I.a.3 Beton marka 200** me *inerte* , konsistencë 3-5 cm, granil deri 20 mm, rërë e lare me modul 2,6: Çimento 400 kg 300 , rërë e lare m³ 0,43 , granil m³ 0,69 , uje m³ 0,18 .

1. Prishje

1/1, 1/2 Prishje totale

Prishje totale rrethime muresh ose e nje pjese te ndertesese, duke perdorur çdo mjet, marrjen e masave per aplikimin e të gjithë akteve përkatëse te sigurisë së mbrojtjes se punetoreve dhe popullsise, sinjalet e dites e te nates si dhe personelin per lajmerimin e kalimtareve, punimet per rrethimet e perkohshme, riparimin per demet e mundshme qe mund t'u shkaktohen te treteve, duke përfshirë ngarkimin e materialeve qe rezulton nga prishja dhe transportin per shkarkim.

2. Punime ne rruge :

2/3. Gërmim dheu seksion i detyruar :

Gërmim dheu per trupin e rruges, deri në thellesine 50, ne truall te çfarëdo natyre dhe konsistence, te thare ose te lagur (argjile edhe n.q.s. eshte kompakte, rërë, zhavorr, gure etj.), përfshirë prerjen dhe heqjen e rrenjeve, trungjeve, gureve dhe pjesëve me volum deri në 0,30 m³, plotesimin e detyrimeve ne lidhje me ndertimet e nendheshme si kanalet e ujrave te zeza, te bardha ujesjellesit, te elektrikut ne pergjithesi etj.,

2/4. Ndertim bankina anesore :

Ky ze perfshin te gjitha proceset dhe materialet qe duhen per ndertimin e bankines uniforme me trashesi 15 cm te cakullit. Ne te perfshihet kostoja e blerjes se materialit, furnizimi, transporti, depozitimi dhe shtimi dhe nivelimi me grejder dhe cilindrimi me 5 – 6 kalime vajtje ardhje deri ne ngjeshje 98%. Cakulli duhet te jete nga thyerja e gurit te kavos me granulometri 5/40 mm, te behen provat e materialit per plotesimin e kushteve teknike per materialin qe perdoret dhe me pas te lajmerohet perfaqesuesi i Investitorit. Vetem pas miratimit me shkrim nga Supervizori do te lejohet perdorimi i materialit te cakullit per bankinat. Çmimi i referohet 1 m² shtrese me cakulli 1x15 cm, gran.5/40 mm.

2/5. Germim dheu seksion i lire:

Ky çmim perfshin teresine e puntorise dhe punimeve qe lidhen me germimin per profilimin e trupit te rruges, pamvaresisht ne se ky germim behet me krahe, me makineri apo me mina, ne prezence apo te ujit, ne seksion te detyruar apo jo, ne toke te forte apo te bute, zhavorr, beton apo asfalt. Gjithashtu ketu duhet

te futet edhe kostoja e ngarkimit, transportit, shkarkimit, ne vendet e autorizuara nga bashkia, te materialeve qe dalin nga germimi. Ky çmim i referohet 1 m³.

2/6. Mbushje me material shkembor :

Ky çmim perfshin teresine e punimeve dhe puntorise qe lidhen me mbushjen me material shkembor per profilimin e trupit te rruges dhe te trotuareve ne thellesine e dhene ne profilat terthore te projektit me shtresa çdo 20 cm, grejderimin dhe rulimin ne lageshtire te ketij materiali. Gjithashtu ketu futet dhe kostoja e blerjes/prodhimit, ngarkimit, transportit, shkarkimit, te materialeve te nevojshme. Ky çmim i referohet 1 m³.

3. Punime Betonesh ne rruge:

3/7. Shtrese stabilizanti nen kunete:

Ky çmim perfshin teresine e punimeve dhe puntorise qe lidhet me blerjen e stabilizantit, hedhjen e saj ne shtresa me $t = 10$ cm, nen kuneta ku te kihet kujdes qe te respektohet granulometria dhe dhenia e pjerrtesise dhe cdo gje tjeter e nevojshme. Po ketu duhet te futet edhe kostoja e ngarkimit, transportit, shkarkimit ne objekt te stabilizantit. Ky çmim i referohet 1 m².

3/8. Beton M-200 per kunete :

Ky çmim perfshin teresine e punimeve dhe puntorise qe lidhet me blerjen e betonit ose te materialeve dhe prodhimin e betonit M-200 per kuneten, germimi i seksionit ku do te hidhet kuneta, ngarkimin, transportin, shkarkimin, hedhjen ne veper, pregatitjen e armatures se derrases, vibrimin e tij, te gjitha keto konform vizatimit tip shoqerues ne projekt. Betonet duhet te jene me dozim sipas pikes I.a.3. Ky çmim i referohet. 1 m³.

3/9. F.V Bordura betoni te Parapregaditura 20x30x100 cm :

Ky çmim perfshin teresine e punimeve dhe puntorise qe lidhen me prodhimin/blerjen e bordurave te betonit M- 200 te parapergaditura me permasa 20x30x100 cm qe vendosen anesh rruges per te kufizuar trotuarin nga rruga, perfshin germimi per vendosjen e tyre, vendosja e tyre ne veper dhe çdo gje tjeter e nevojshme. Gjithashtu ketu futet edhe kostoja e blerjes, ngarkimit, transportit, shkarkimit, te materialeve te tjera te nevojshme (armature derrase apo metalike, rere, cemento, granil e tjera. Bordurat duhet te jene te stazhonuara mire. Ky çmim i referohet 1 ml.

3/10. Mure betoni M-150 :

Themeli i murit dhe muri ne lartesi prej betoni, me beton m-150, me dozim te betonit per m³ si pika 1.a.2, duke përfshirë kallepet, perforcimet dhe çdo gje tjeter te nevojshme per mbarimin e themeleve dhe realizimin e tyre ne menyre perfekte.

3/13, 4/17. Beton M-100 nen bordura e tubat e betonit :

Ky cmim perfshin teresine e punimeve dhe te puntorise qe lidhen me blerjen/pergatitjen betonit M-100 sipas dozatures te dhene ne piken I.a.1, hedhjen ne veper nen anash bordurave dhe nen tuba, te gjitha keto konform vizatimit tip shoqerues ne projekt, ngarkimin, transportin, shkarkimin e materialeve te nevojshme (rere e lare, granil i lare, cemento, dhe cdo gje tjeter te nevojshme). Ky cmim i referohet 1 m³.

4. Punime Tombino ne Rruge :

4/14. Germim dheu per kanalet :

Me zerin nenkuptojme germimin e seksionit te kanalit ne thellesine e kerkuar ne projekt, me krahe apo makineri, sipas rastit, perfshi ketu thyerjen e shtresave te betoneve apo asfalteve, evadimin e materialeve te teperta jashte objektit dhe cdo shpenzim tjeter qe ka te beje me realizimin e punimeve te germimit. Te perdoret kallepi aty ku eshte i nevojshem. Ky cmim i referohet 1 m³.

4/15. Shtrese zhavori nen tuba :

Ky çmim perfshin teresine e punimeve dhe puntorise qe lidhet me blerjen e zhavorit, hedhjen e saj ne shtresa me $t = 10$ cm, nen tuba ku te kihet kujdes qe te respektohet granulometria dhe dhenia e pjerrtesise dhe cdo gje tjeter e nevojshme. Po ketu duhet te futet edhe kostoja e ngarkimit, transportit, shkarkimit ne objekt te zhavorit. Ky çmim i referohet 1 m².

4/16. Shtrese rere nen, anash dhe mbi tuba :

Ky cmim perfshin teresine e punimeve qe lidhen me blerjen e materialit te reres, te puntorise per hedhjen ne veper, shtrirjen me trashesine dhe pjerrtesine e kerkuar, ngjeshjen me kujdes te shtreses poshte anash, mbi me trashesi 10 cm mbi tubat sipas projektit dhe kushteve teknike , ne cmim perfshihet ngarkimi, transporti, shkarkimi i materialit ne objekt dhe ngjeshja me kujdes e reres me qellim qe tubat te mos demtohen nga agentet mekanik. Ky çmim i referohet 1 m³.



REPUBLIKA E SHQIPERISE
 STUDIO PROJEKTUESE
 "DERBI-E"
 Rruga e DIBRES, Pall. AK, prane Schvise
 TIRANE
 email: derbi.studio@gmail.com
 Cel. 0682057034

HOOROGRAFIA
 Komuna Suke

POROSITESI

SH - 1:1000

SISTEMIM ASFAITIM I RRUGEVE
 QENDER SUKE - PODCORNAR RUSHIE

GRUPI I PROJEKTIMIT

KONSTRUKTOR	Ing. Bexhet Deda
PROJEKTUES	Ing. Alban Hoxha
ARKITECT	Ark. Olgjer Qilicaj
TOPOGRAFI	Top. Tahir Hysa
GEOLLOZ	Ing. Zenel Hysa
DATA	Tetor 2008



SH - 1:1000 Projekt zbatimi



REPUBLIKA E SHQIPERISE
STUDIO PROJEKTOUESE
"DERBLE"
 Rruga e DIBRES, Prishtine, K. prane Selvishe
 TIRANE
 email: derble@derble.com
 Call: 0652057634

HOOROGRAFIA

SISTEMIM ARZANITIM I RRUGES
QANDER HUKI - PODGORRA FUSHI
 GRUPI I PROJEKTIMIT

KONSTRUKTOR	Ing. Beqhet Deda
PROJEKTUES	Ing. Alban Hoxha
ARKITECT	Ark. Olgjer Qilicaj
TOPOGRAF	Top. Tahir Hysa
RESOLUES	Ing. Zemel Hysa
DATA	Tetor 2008

SH - 1:1000 Projekt zbatimi

PROJEKTI
 DERBLE
 HUKI

© 2009
 8 Europ
 © 2008

Image © 2009 Di
 © 2008 Eu

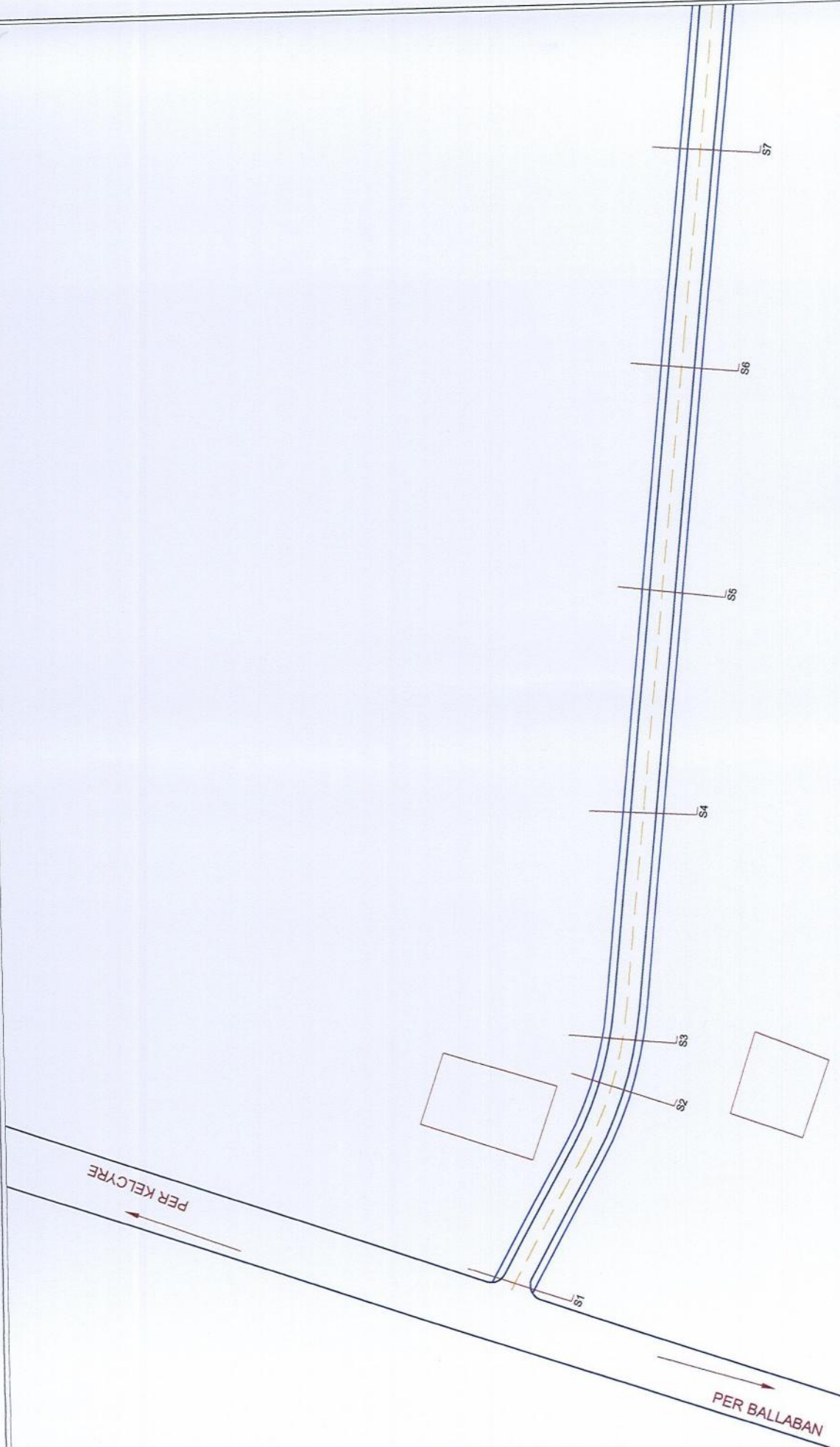

**SISTEMIM ASFALTIM I RRUGES
QENDER ZUKË - PODGORAN SUSHI**

KONSTRUKTOR	Ing. Beqir Dudi	GRUPI PROJEKTIMIT	OBJEKTI
PROJEKTUES	Ing. Alban Hoxha	PROJEKTI	DERBI-E
ANALIZIST	Ark. Oliver Qirjaqi	TITULLI	TIRANE
TITULLI	Top. Tahir Hysa	DATA	TIRANE
TITULLI	Ing. Zanel Hysa	TITULLI	TIRANE
TITULLI	Tutor 2008	TITULLI	TIRANE

SH - 1:500 Projekt zbatimi



REPUBLIKA E SHQIPERISE
STUDIO PROJEKTUESE
"DERBI-E"
Rruga e DIBRES, Pall. AK, prane Seshes
TIRANE
email: derbie.studio@gmail.com
Cell: 0682067534

PLANIMETRIA E AZHORNUAR

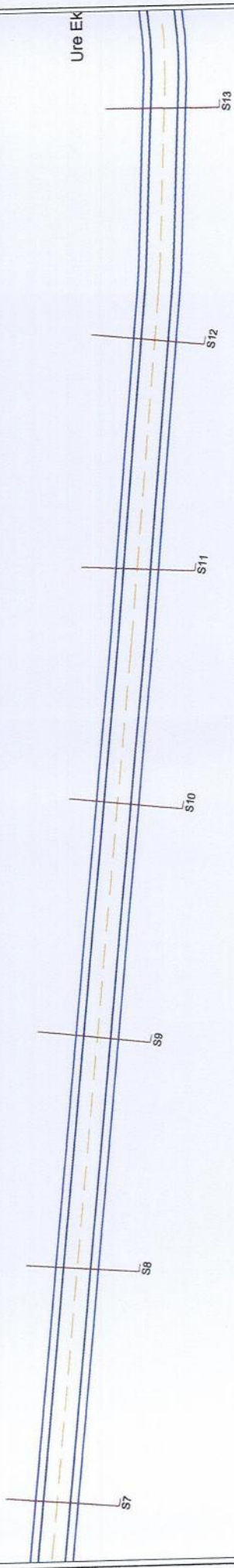

		REPUBLIKA E SHQIPERISE STUDIO PROJEKTORESE "DERBI-E" Rruga e DIBRES, Pall. Ak. prane Selvisë TIRANE email: derbie.studio@gmail.com Cell: 0682057534		SISTEMIM ASFALTIM I RRUGES QENDER SUKE - PODGORAN RUSHIE GRUPI I PROJEKTIMIT			
KONSTRUKTOR	Ing. Beqhet Deda	PROJEKTOR	Ing. Alban Hoxha	PROJEKTIM	Ing. Beqhet Deda	PROJEKTIM	Ing. Alban Hoxha
PROJEKTUES	Ark. Olgjer Qijfaj	ASHTREZ	Top. Tahir Hasa	ASHTREZ	Ing. Zeneid Hysa	ASHTREZ	Ing. Zeneid Hysa
PROJEKTUES	Ing. Zeneid Hysa	PROJEKTUES	Ing. Zeneid Hysa	PROJEKTUES	Ing. Zeneid Hysa	PROJEKTUES	Ing. Zeneid Hysa
DATA	Tetor 2008	DATA	Tetor 2008	DATA	Tetor 2008	DATA	Tetor 2008
PLANIMETRIA E AZHORNUAR				SH - 1:500 Projekt zbatim			

Qender shendetesore

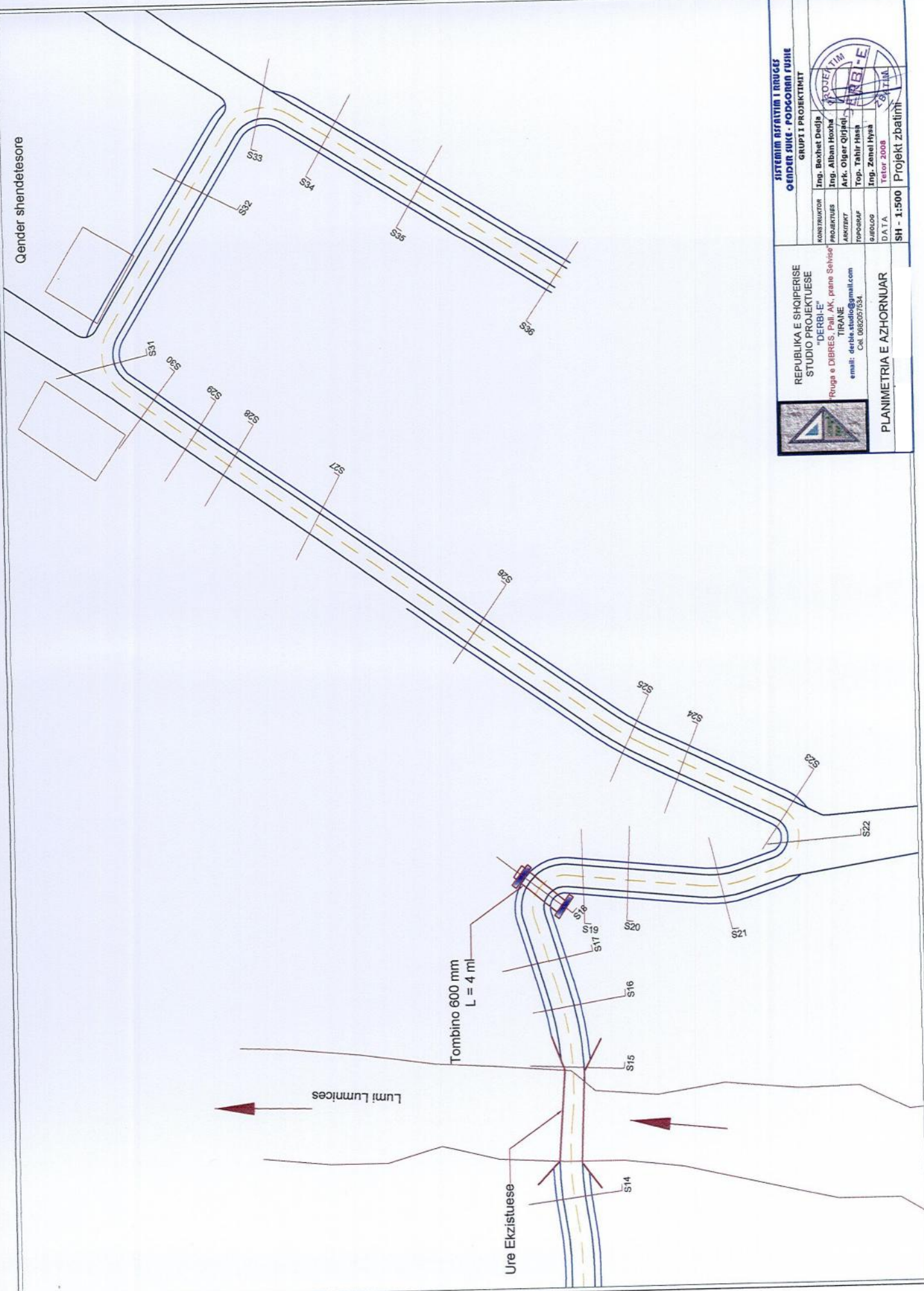

REPUBLIKA E SHQIPERISE
STUDIO PROJEKTORESE
"DERBI-E"
Rruga e DIBRES, Pall. AK. plane Selvises
TIRANE
email: derbi.studio@gmail.com
Cel. 06852057534.

PLANIMETRIA E AZHORNIUAR

SISTEMIM ASFRATIM I RRUGES
QENDER SUKE - PODGORAN RUSHI

GRUPI I PROJEKTIMIT

KONSTRUKTOR	Ing. Baxhet Duda
PROJEKTUES	Ing. Alban Hoxha
ANEXIMET	Ark. Olgjer Qijpaj
TOPOGRAFI	Top. Tahir Hash
JEKLOGJ	Ing. Zenele Hysa
DATA	Tetor 2008
SHIFRA	1/8



SH - 1:500 Projekt zbatim



PJERRESIA (%)	i=0.6%													
KUOTA R TOKES (m)	74.20	73.86	74.02	73.77	73.53	73.31	72.74	72.40	71.72	71.27	70.90	70.56	69.87	
KUOTA E PROJEKTTIT (m)	1	2	3	4	5	6	7	8	9	10	11			
DISTANCA PJESORE (m)	30.00	6.00	30.00	30.00	30.00	30.00	30.00	30.00	30.00	30.00	30.00	30.00	30.00	
DISTANCA PROGRESIVE (m)	74.60	74.11	74.02	73.86	73.53	73.31	72.74	72.40	71.72	71.27	70.90	70.56	276.01	
PLANIMETRIA	0.00											100.0	200.0	300.0
KILOMETRAZHI														

- Niveli i Veshjes Asfaltike
- Niveli i profilit, Skarifikimit
- Niveli i Rruges Ekzistuese

REPUBLIKA E SHQIPERISE
STUDIO PROJEKTUESE
"DERBI-E"
Rruga e DIBRES, Pall. AK, prane Selvise
TIRANE
email: derbi.studio@gmail.com
Cell: 068267354

SISTEMI ASFALTIM I RRUGES
QENDRI SUKE - PODGORAN RRUHE
GRUPTI I PROJEKTIMIT

KONSTRUKTOR: Ing. Bechhet Dedja
PROJEKTUES: Ing. Alban Hoxha
ARVIZOR: Ark. Olgjer Qifjaq
PROGROAR: Top. Tahir Hasa
BUEZOR: Ing. Zeneel Hysa
DATA: Tetor 2008
Sh.H - 1:1000
Sh.V - 1:100

PROFILI GJATESORE

Projekt zbatimi

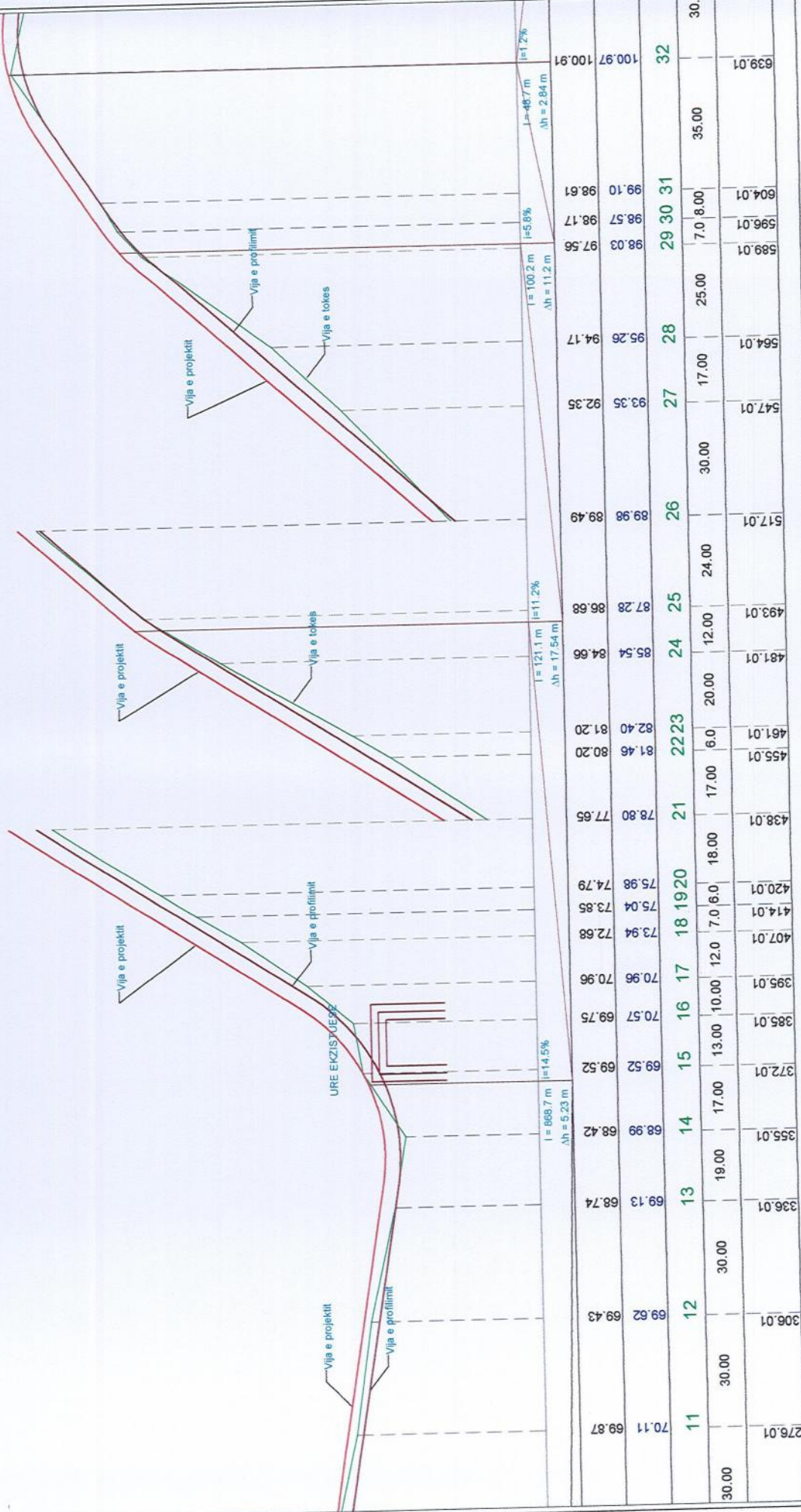

30.00	70.11	69.87	30.00	69.62	69.43	11	12	13	14	15	16	17	18	19	20	21	22	23	24	25	26	27	28	29	30	31	32	30.00
276.01	306.01	306.01	336.01	336.01	336.01	355.01	355.01	355.01	355.01	372.01	385.01	395.01	407.01	414.01	420.01	438.01	455.01	461.01	481.01	493.01	517.01	547.01	564.01	589.01	596.01	604.01	639.01	
	30.00	30.00	30.00	30.00	19.00	17.00	17.00	17.00	17.00	13.00	10.00	12.0	7.0	6.0	18.00	17.00	6.0	20.00	12.00	24.00	24.00	30.00	17.00	25.00	7.0	8.00	35.00	

300.0

400.0

500.0

600.0

SH.H - 1:1000

SH.V - 1:100

Projekt zbatimi

DATA

DATE

Ing. Zena Hysa

Top. Tahir Hysi

Ark. Olgjer Qirjaku

Ing. Alban Hoxha

Ing. Beqir Dushaj

KONSTRUKTOR

PROJEKTUES

PROJEKTUES

PROJEKTUES

PROJEKTUES

REPUBLIKA E SHQIPERISE

STUDIO PROJEKTOJESHE

"DERBI-E"

Rruga e DIBRES, Pali. AK, prane Selvishe

TIRANE

email: derbi.studio@gmail.com

Cell: 0682057534.

SISTEMIM ASFALTIM I RUGES

GRUPI I PROJEKTIMIT

PROFILI GJATESORE

- Niveli i Veshjes Asfaltike
- Niveli i profilimit, Skarfikimit
- Niveli i Ruges Ekzistuese



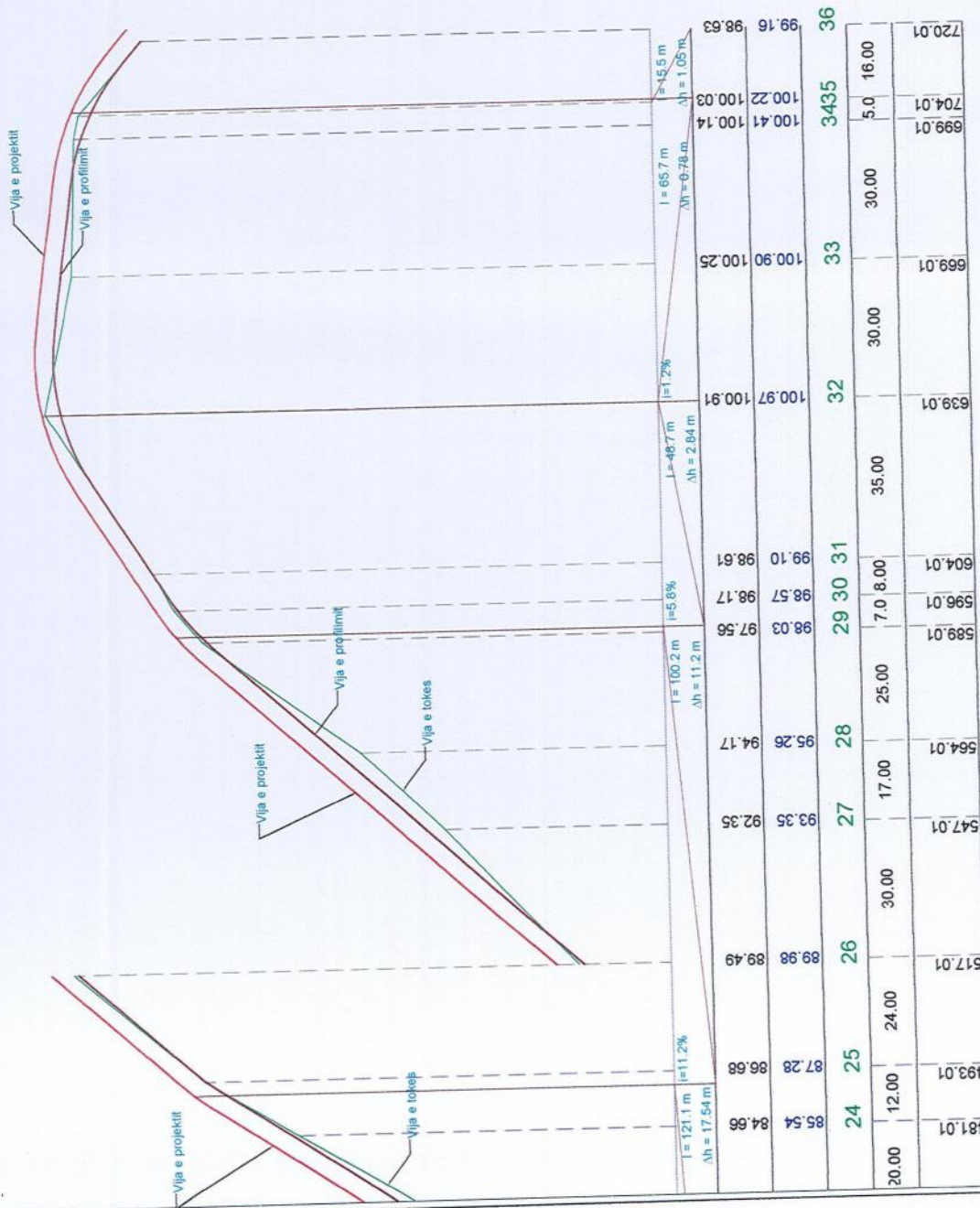

481.01	493.01	517.01	547.01	564.01	589.01	596.01	604.01	639.01	669.01	699.01	704.01	720.01
20.00	12.00	24.00	30.00	17.00	25.00	7.00	8.00	35.00	30.00	30.00	5.00	16.00
24	25	26	27	28	29	30	31	32	33	34	35	36
85.54	87.28	89.98	93.35	95.26	98.03	98.57	99.10	100.97	100.90	100.41	100.22	99.16
84.66	86.68	89.49	92.35	94.17	97.56	98.17	98.61	100.91	100.25	100.14	100.03	98.63
$l = 121.1\text{ m}$	$i = 11.2\%$	$\Delta h = 17.54\text{ m}$	$l = 100.2\text{ m}$	$i = 5.8\%$	$\Delta h = 11.2\text{ m}$	$l = 48.7\text{ m}$	$i = 1.2\%$	$\Delta h = 2.84\text{ m}$	$l = 65.7\text{ m}$	$\Delta h = 0.74\text{ m}$	$\Delta h = 1.05\text{ m}$	$l = 15.5\text{ m}$



REPUBLIKA E SHQIPERISE
STUDIO PROJEKTOUESE
"DERBIE"
Rruga e DIBRES - Pall. AK, prane Selvishe
TIRANE
email: derbie.studio@gmail.com
Cel: 0682061534

PROFILI GJATESORE

DATA
SH H - 1:1000
SH V - 1:100

SISTEMI ASFAZIM I RRUGES
GRUPI I PROJEKTIMIT

KONSTRUKTOR	Ing. Bechhet Dredfa
PROJEKTUES	Ing. Alban Hoxha
ARKITECT	Ark. Olgjer Qifjeqi
TEKNOLOG	Top. Tahir Hasa
ENJEROJE	Ing. Zeneel Hysa
DATA	Tetor 2008
SH H - 1:1000	Projekt zbatim
SH V - 1:100	



PLANIMETRIA E NDRIQIMIT

REPUBLICA E SHQIPERISE
STUDIO PROJEKTESE "DERRIJE"

TRIANE
Rruga e DIBRES, PAF AK, prane Sektorit
INDUSTRIAL

email: derrije-studio@gmail.com
0682203294

KONTAKTUESH
Ing. Bekhet Dedja
Ing. Alban Hoxha
Ark. Olgjer Qirjazi
Ing. Zefel Hysa
Ing. Zefel Hysa

PROJEKTUESH
Ing. Zefel Hysa

DATA
Tetor 2008

SISTEMIN BASTIM I RRUGES
QENDER SUKE - PODGORAN FISHJE
GRUPI I PROJEKTIMIT

Sekcioni S3
Pr. 110.0 ml

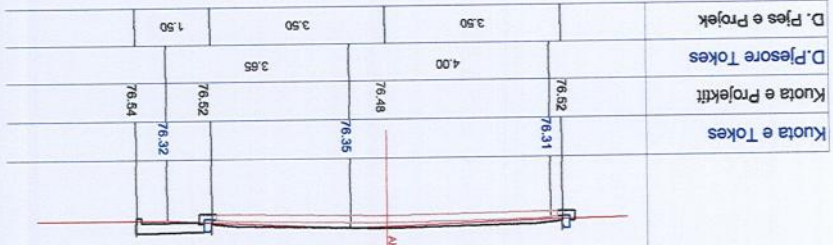

Sekcioni S2
Pr. 57.0 ml

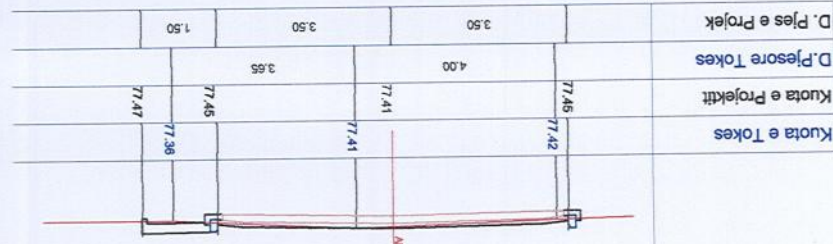

Sekcioni S1
Pr. 0.0 ml

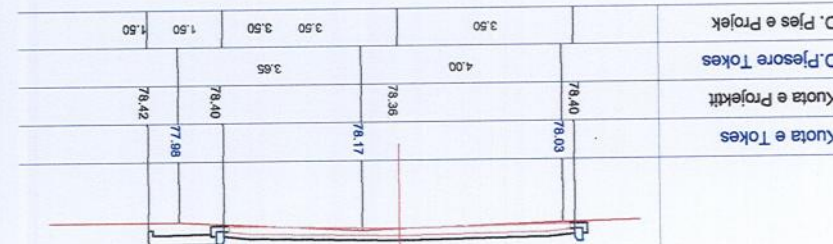

REPUBLIKA E SHQIPERISE
STUDIO PROJEKTESE
"DERRIJE"

TRANE
Rruga e Dibrës, Pst. A.K. prane Seminarit

emial: derrije@projekte.com
0692029204

REPUBLIKA E SHQIPERISE
KOSOVA

GRUPI I PROJEKTIMIT

KOMENTAR	Ing. Bekhet Doda
PROJEKTUES	Ing. Alban Hoxha
ARTIST	Art. Olgier Qisaj
TOPOGRAF	Top. Tahir Hysa
DATELOJ	Ing. Zemel Hysa
DATA	

Sektori S6
Pr. 240.0 ml

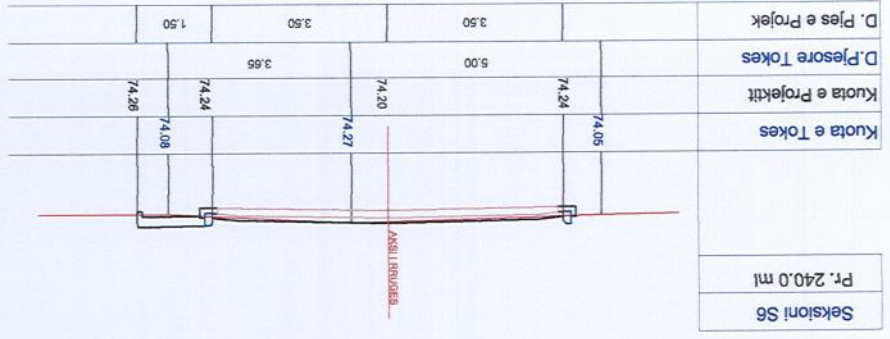

Sektori S5
Pr. 202.0 ml

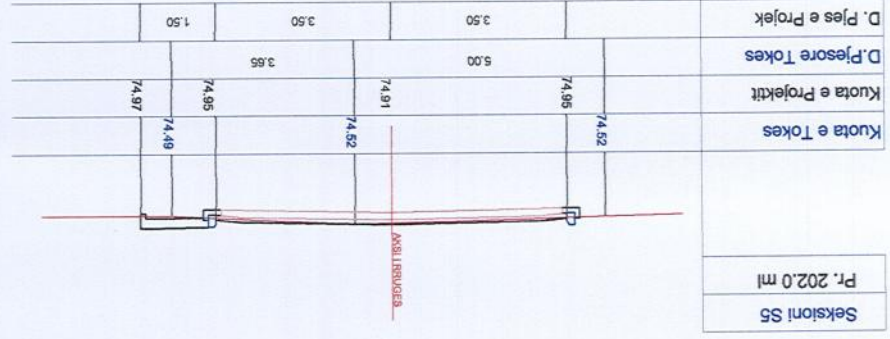

Sektori S4
Pr. 157.0 ml

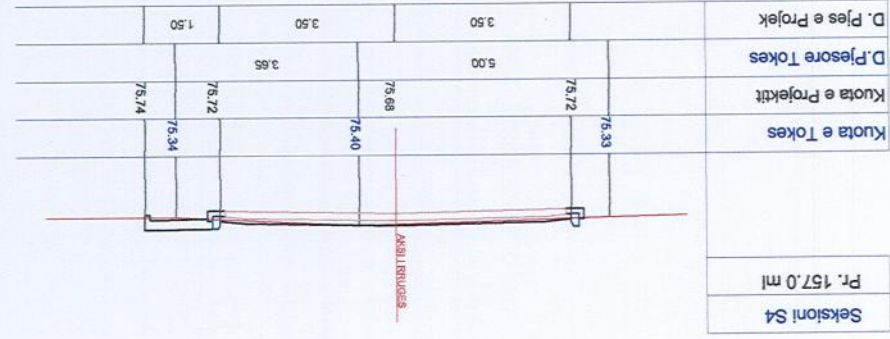

PLANIMETRIA E NDRIÇIMIT

REPUBLICA E SHQIPËRISE
STUDIO PROJEKTORE
"DERBI"
73AAE
Rruga e Dibrës, P.O. Box 9999, Shkup

email: derbi_studio@gmail.com
tel: 088292534

PROJEKTORE
Ing. Albert Hoxha
AUTORITET
Ark. Oliver Qirjaqi
PROJEKTORE
Ing. Zehra Hysa
PROJEKTORE
Ing. Zehra Hysa
DATA
Tetor, 2008

PROJEKTI
SISTEMI RRATIM I RUCES
GRUPI I PROJEKTORE

QENDER E KURTES, RUCES



Sekcioni S9
Pr. 280.0 ml

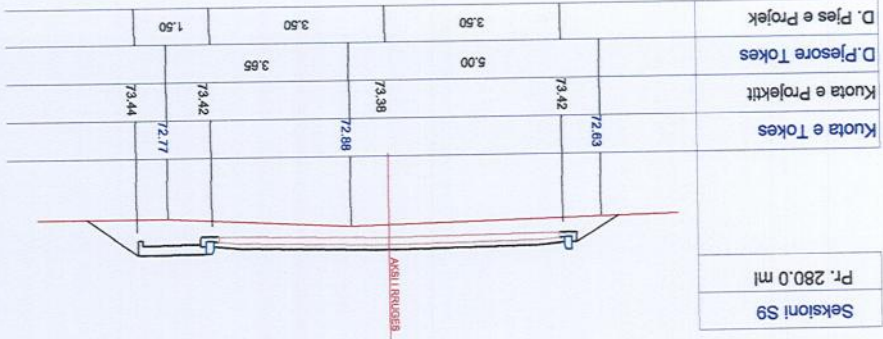

Sekcioni S8
Pr. 270.0 ml

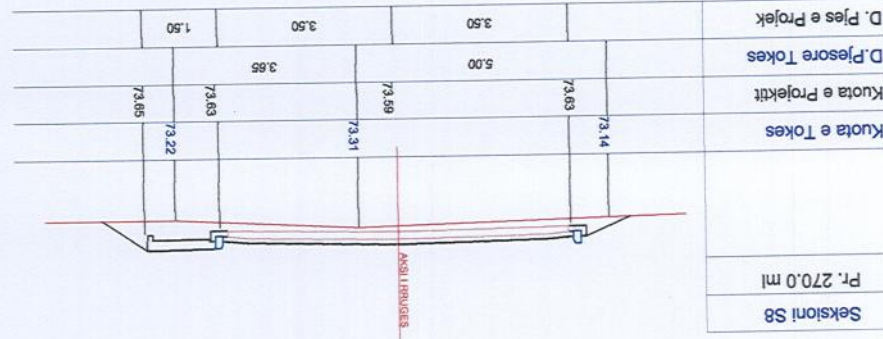

Sekcioni S7
Pr. 248.0 ml

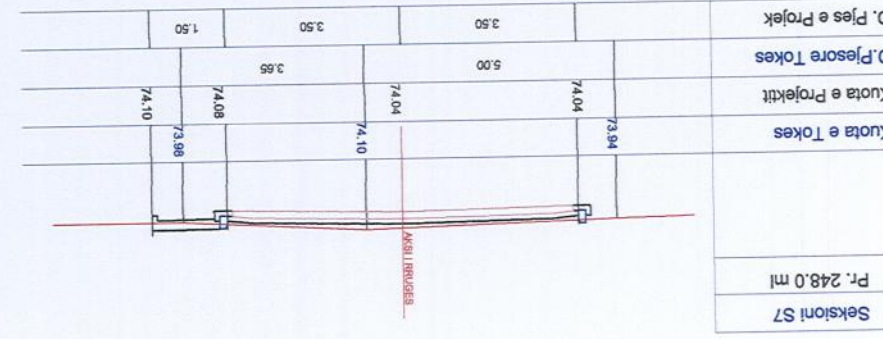

PLANIMETRIA E NDRËJIMIT

email: deviza.studio@prmk.com
 068269524

TRANE
 Pruga e DIBRES, Pall. AK. prane Shkollës

REPUBLIKA E SHQIPRISE
 STUDIO PROJEKTORESE
 "PRMK"

KOMENTARJESH
 Treg. Ahmet Hoxha
 Treg. Beqir Doda
 Treg. M. Haxhiu
 Treg. Omer Qirani
 Treg. Zaim Hysa
 Treg. Zaim Hysa
 Treg. Zaim Hysa

D.A.T.A.
 Tetor 2008

SISTEMI ASHTIM I RRUQES
QENDER SUKE - PODOBNA LIRIJE
GRUPI I PROJEKTIMIT



Sekcioni S10
 Pr. 310.0 ml

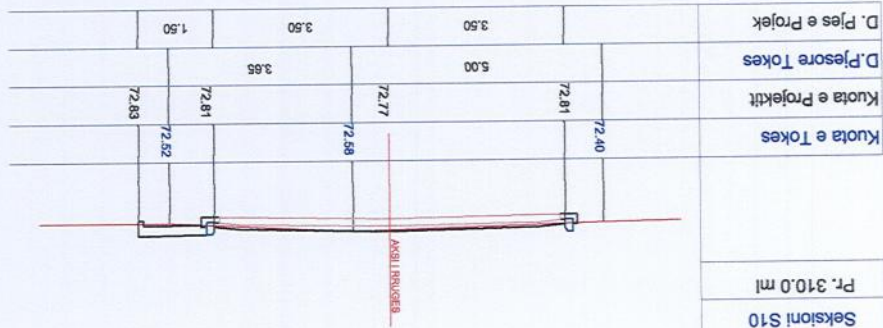

DATA	Tetor 2008
KAZA	Projekti Zbatimi
GRUPOJE	Ing. Zenel Hysa
TOMOGRAF	Ing. Zahir Hysa
ARHITEKT	Ark. Olgier Qirjaqi
PROJEKTUES	Ing. Alban Hoxha
KONSTRUKTOR	Ing. Bekhet Dedia
GRUPI I PROJEKTIMIT	
SISTEMIN ASHTATIM I RRUGES	
QENDER SUK - PODGORICA FUSHK	

PROFILI TERTHORE

STUDIO PROJEKTORE "DERBI-E"

REPUBLIKA E SHQIPERISE

TRIANE

email: derbi-studio@gmail.com

Cel. 06805234

Rruga e DIBRES, Pall. Ark. pr. me Selvia

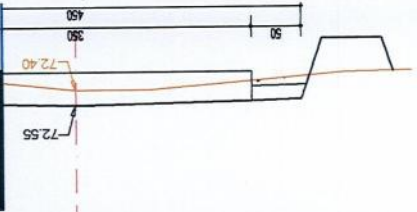

PK 6
Pr = 120.0 m

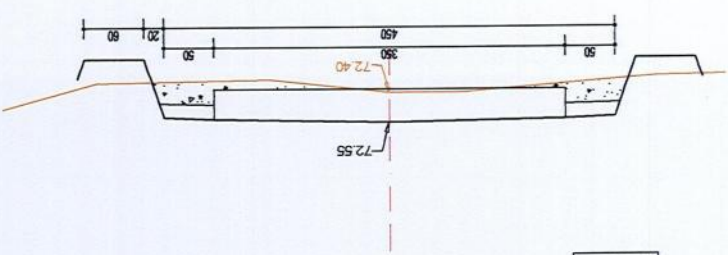

PK 5
Pr = 98.0 m

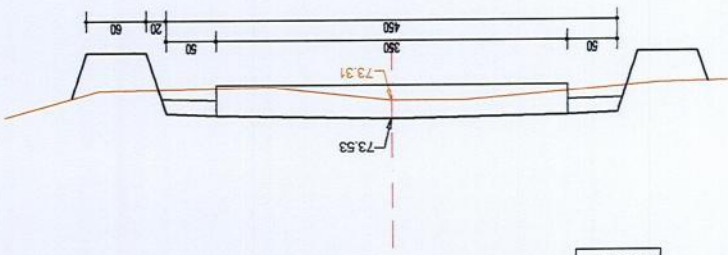

PK 4
Pr = 86.0 m

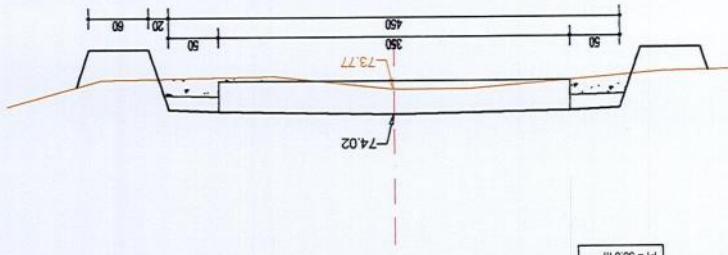

PK 3
Pr = 36.0 m

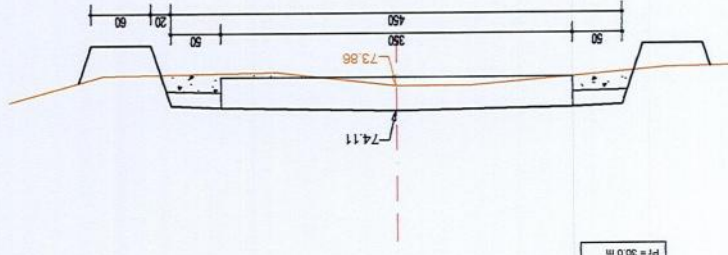

PK 2
Pr = 30.0 m

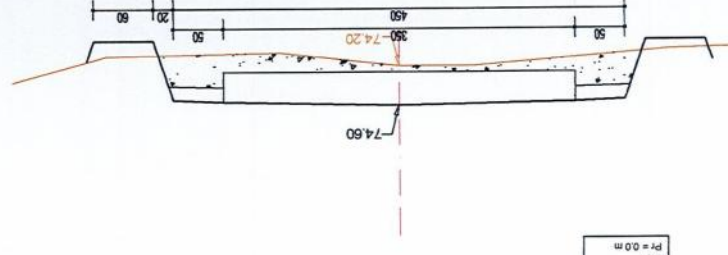

PK 1
Pr = 0.0 m

DATA	Tetor 2008
FAZA	Projekti Zbatimi
ARHITEKT	Ing. Zenei Hysa
TOPOGRAFI	Top. Tahir Hasa
PROJEKTUES	Ark. Olgjer Qirjaqi
KONSTRUKTOR	Ing. Bekhet Dedja
GRUPI I PROJEKTTIT	
QENDER SUKE - PODOCORNAN RRSHE	
SISTEMIM ASHTATIM I RRUGES	

PROFILI TERTHORE

Republika e Shqipërisë
STUDIO PROJEKTORE "DERBI-E"
 TIRANE
 email: derbi-studio@gmail.com
 Cell: 068205754

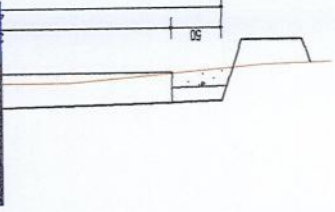

Pr. 11
Pr = 276.0 m

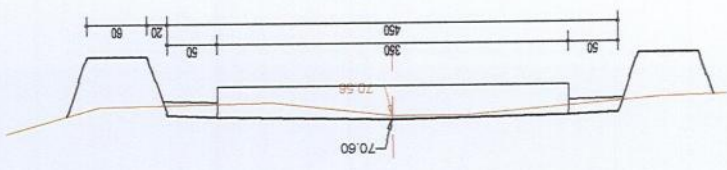

Pr. 10
Pr = 246.0 m

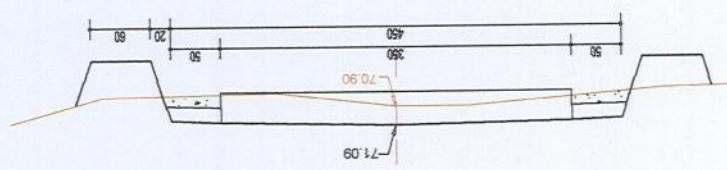

Pr. 9
Pr = 216.0 m

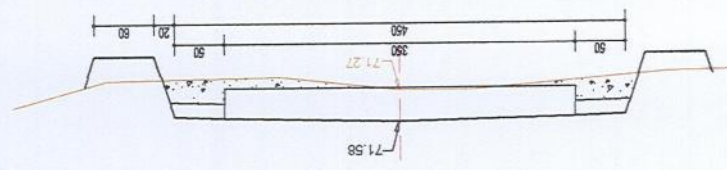

Pr. 8
Pr = 186.0 m

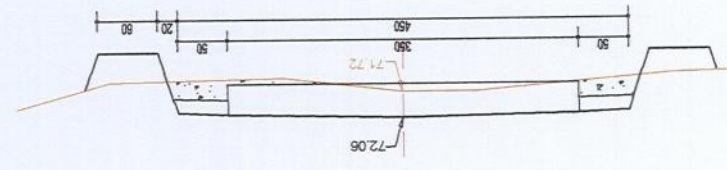

Pr. 7
Pr = 166.0 m

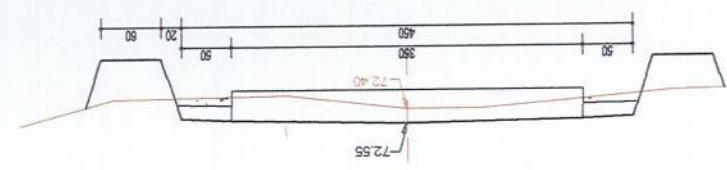

Pr. 6
Pr = 136.0 m

Pk. 16
Pr = 395.0 m

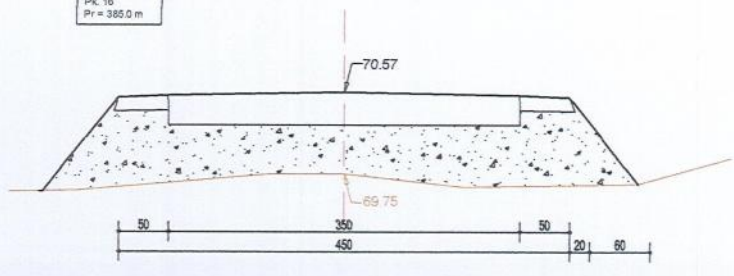

Pk. 17
Pr = 395.0 m

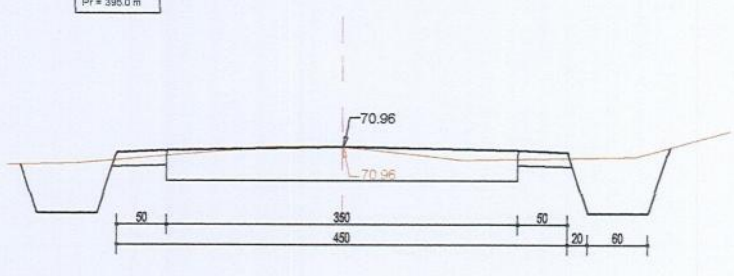

Pk. 18
Pr = 407.0 m

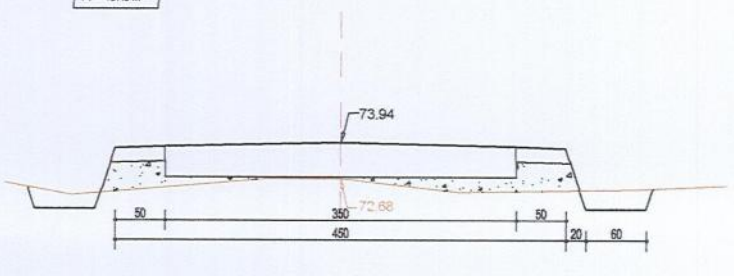

Pk. 19
Pr = 414.0 m

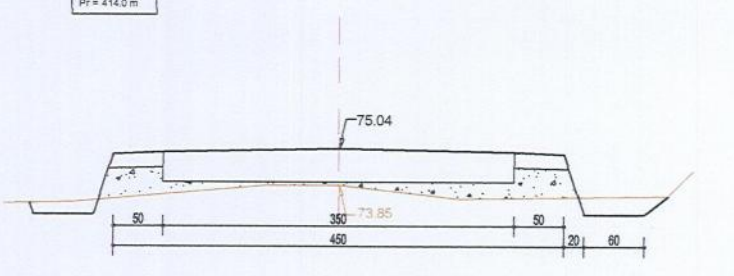

Pk. 20
Pr = 420.0 m

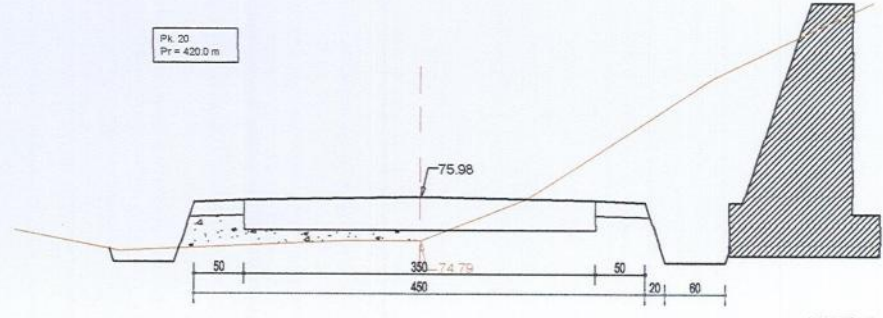

Pk. 21
Pr = 438.0 m

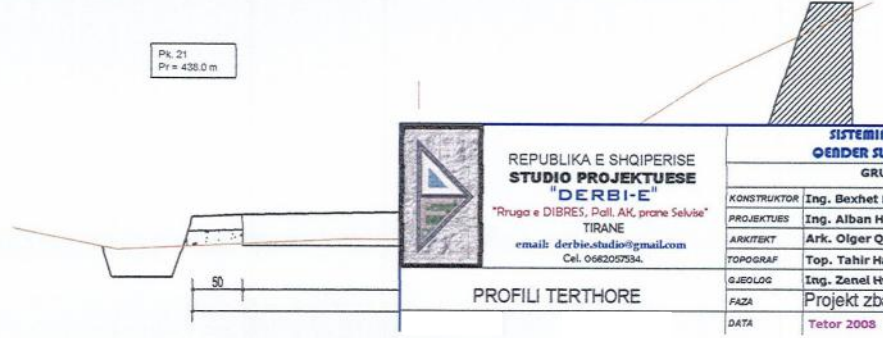

REPUBLIKA E SHQIPERISE
STUDIO PROJEKTORESE
"DERBI-E"
"Rruga e DIBRES, Pall. AK, prane Selvisë"
TIRANE
email: derbie.studio@gmail.com
Cel. 0682057934.

PROFILI TERTHORE

SISTEMIM ASFALTIM I RRUGES
QENDER SUKE - PODGORRA FUSHË
GRUPI I PROJEKTIMIT

KONSTRUKTOR	Ing. Bexhet Dedja
PROJEKTUES	Ing. Alban Hoxha
ARKITEKT	Ark. Olgjer Qirjaqi
TOPOGRAFI	Top. Tahir Hasa
GJEOLOG	Ing. Zanel Hysa
FAZA	Projekt zbatimi
DATA	Tetor 2008

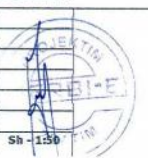

Pk. 21
Pr = 438.0 m

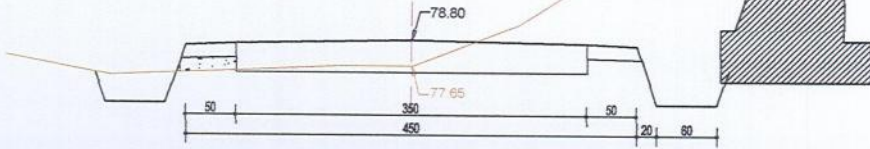

Pk. 22
Pr = 455.0 m

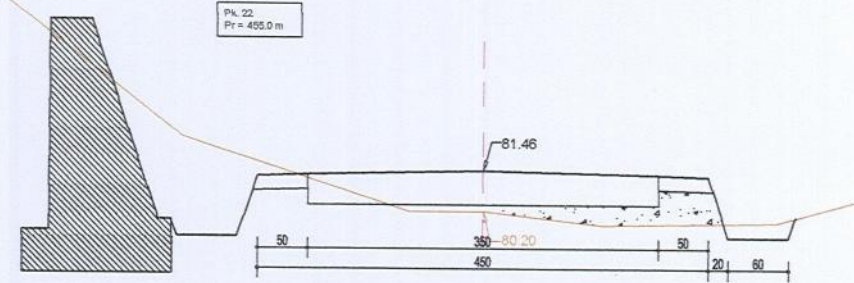

Pk. 23
Pr = 481.0 m

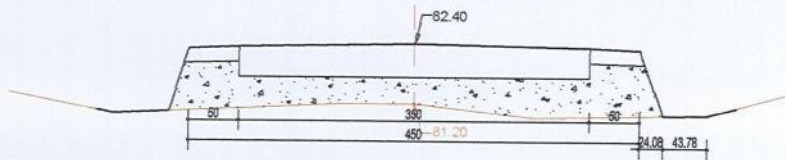

Pk. 24
Pr = 481.0 m

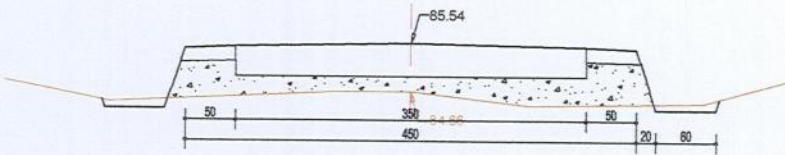

Pk. 25
Pr = 483.0 m

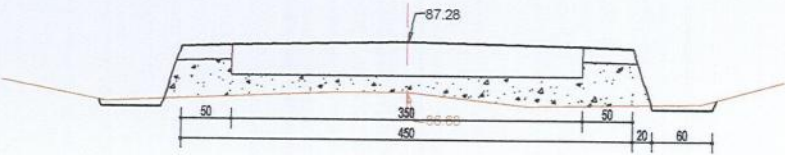

Pk. 26
Pr = 517.0 m

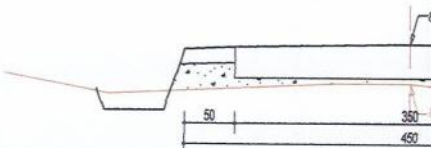

REPUBLIKA E SHQIPERISE
STUDIO PROJEKTORE
"DERBIE"
"Rruga e DIBRES, Pall. AK prane Selvisë"
TIRANE
email: derbie.studio@gmail.com
Cel. 0682057934.

PROFILI TERTHORE

SISTEMI I ASFALTIM I RRUGES
QENDER SUKE - PODGORAN FUSHE
GRUPI I PROJEKTIMIT

KONSTRUKTOR	Ing. Bexhet Dedja
PROJEKTUES	Ing. Alban Hoxha
ARKITEKT	Ark. Olgjer Qirjaqi
TOPOGRAF	Top. Tahir Hasa
GJEOLOG	Ing. Zenel Hysa
FAZA	Projekt zbatimi
DATA	Tetor 2008



Pk: 26
Pr = 517.0 m

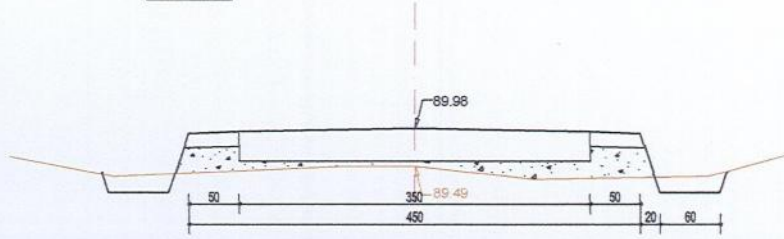

Pk: 27
Pr = 517.0 m

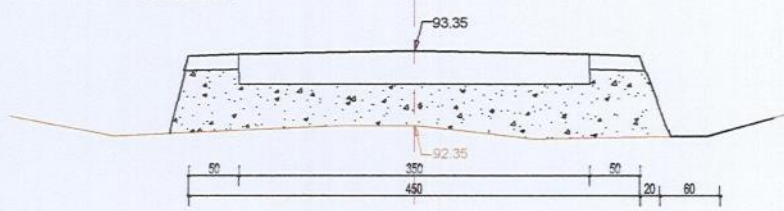

Pk: 28
Pr = 514.0 m

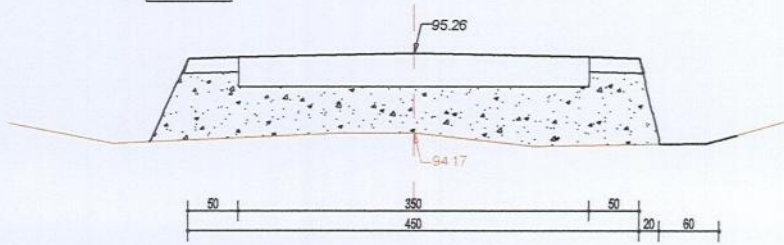

Pk: 29
Pr = 519.0 m

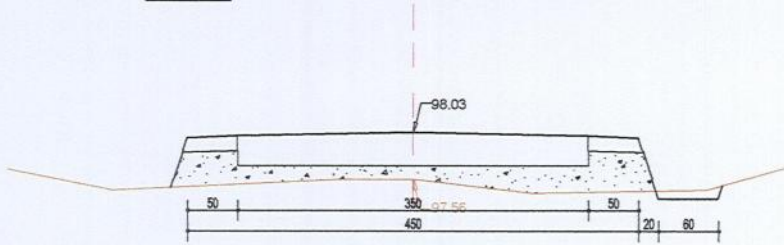

Pk: 30
Pr = 516.0 m

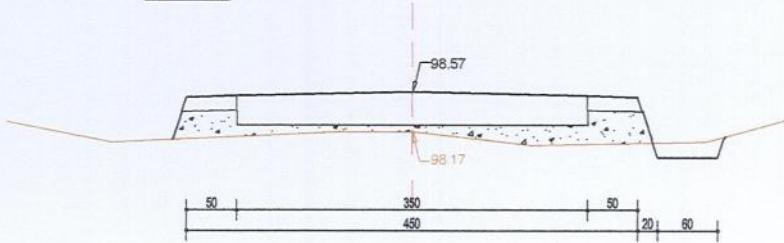

Pk: 31
Pr = 604.0 m

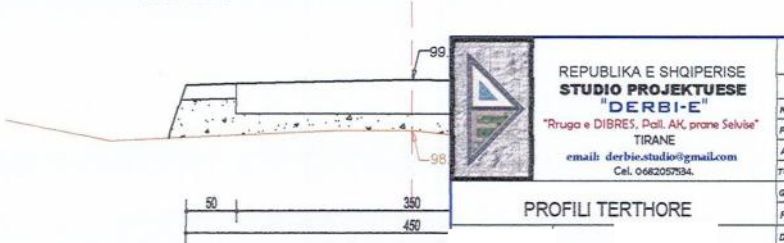

REPUBLIKA E SHQIPERISE
STUDIO PROJEKTORESE
"DERBIE"
"Rruga e DIBRES, Dull, AK, pranë Selvisë"
TIRANE
email: derbio.studio@gmail.com
Cel: 0682057934.

PROFILI TERTHORE

SISTEMIM ASFALTIM I RRUGES
QENDER SUKE - PODGORAN RUSHE

GRUPI I PROJEKTIMIT

KONSTRUKTOR	Ing. Bexhet Dedja
PROJEKTUES	Ing. Alban Hoxha
ARKITEKT	Ark. Olgjer Qirjaqi
TOPOGRAF	Top. Tahir Hasa
GJEOLOG	Ing. Zenel Hysa
FAZA	Projekt zbatimi
DATA	Tetor 2008



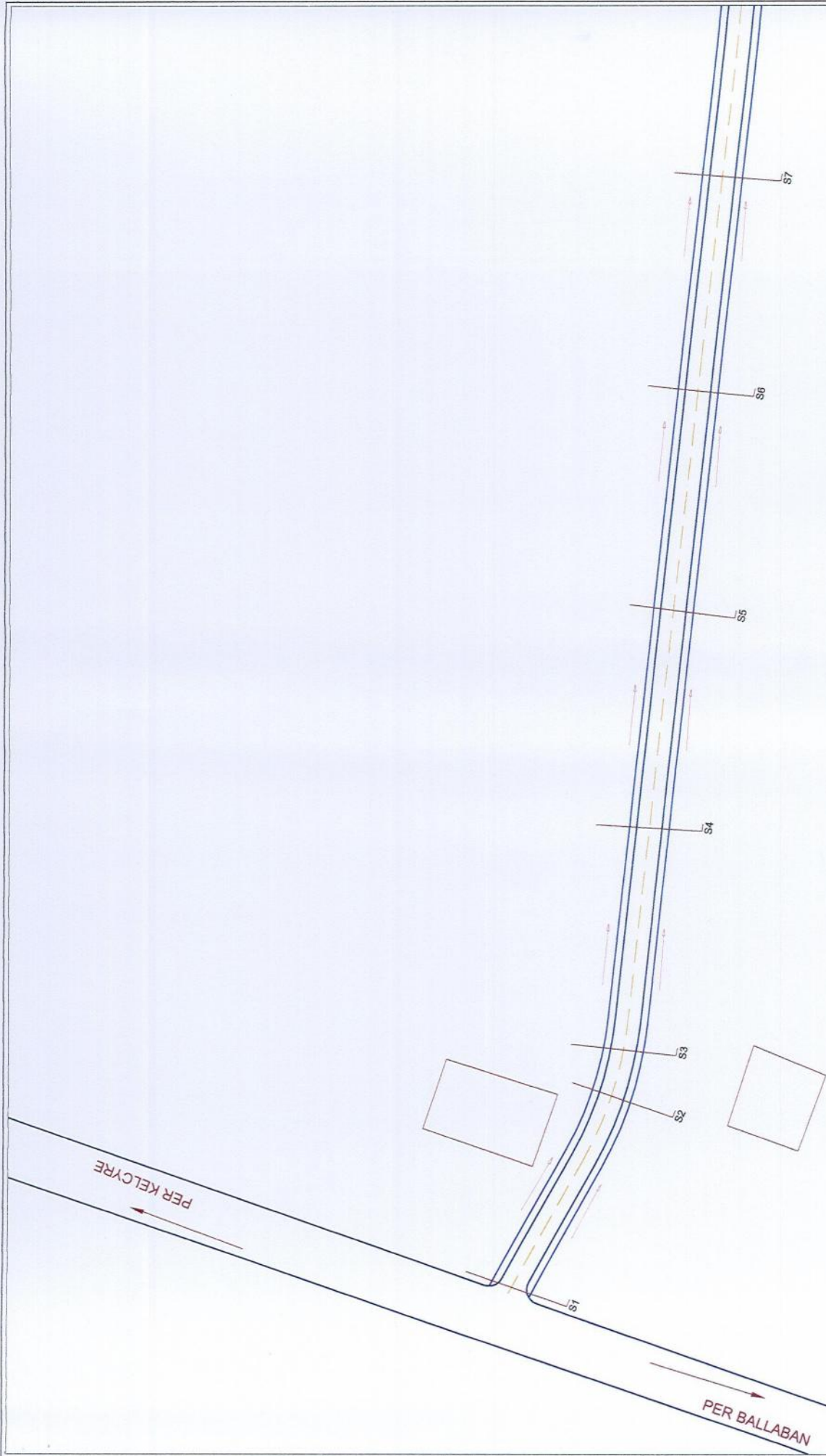

REPUBLIKA E SHQIPERISE
STUDIO PROJEKTUJESHE
"DERBI-E"
Pruga e DIBRES, Pall. AK, prane SeNise
TIRANE
email: derbi.studio@gmail.com
Cel: 0682057534

SISTEMIM ASFTATIM I RRUGES		GRUPI I PROJEKTIMIT	
KONSTRUKTOR	Inj. Bechhet Deqan	PROJEKTANT	PROJEKTANT
PROJEKTUES	Inj. Alban Hoxha	REVIZOR	REVIZOR
Autorizuar	Arif. Ojger Qirjaqi	TOPOGRAF	TOPOGRAF
SHENOJE	Top. Tahir Hysa	ING. ZEMEL HYSA	ING. ZEMEL HYSA
DATA	Tetor 2008	SH - 1:500	Projekt zbatimi

PLANIMETRIA UJRAVE TE BARDHA

Pk: 31
Pr = 604.0 m

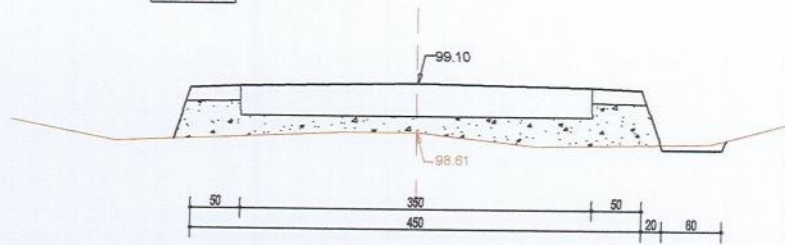

Pk: 32
Pr = 639.0 m

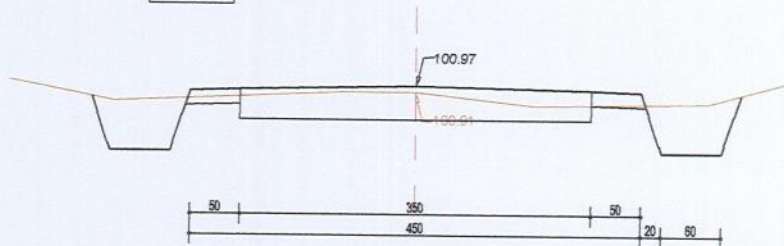

Pk: 33
Pr = 669.0 m

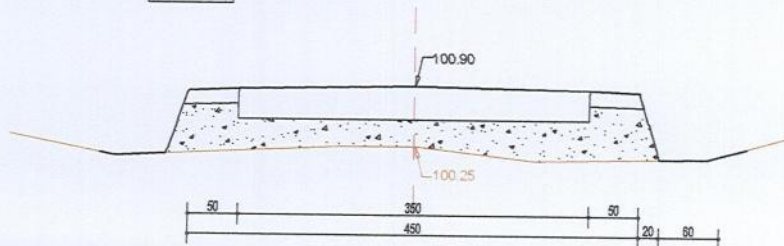

Pk: 34
Pr = 699.0 m

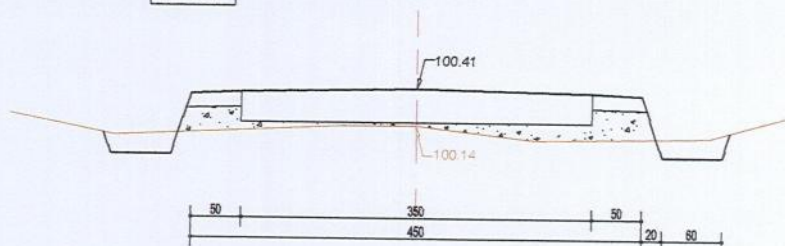

Pk: 35
Pr = 704.0 m

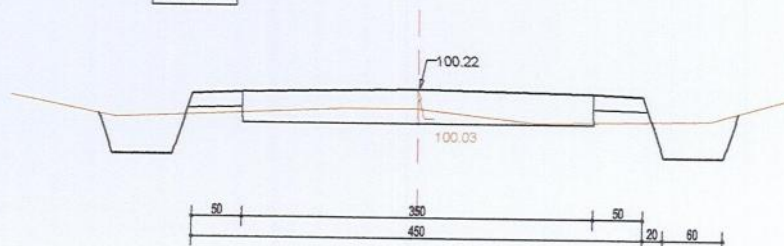

Pk: 36
Pr = 720.0 m

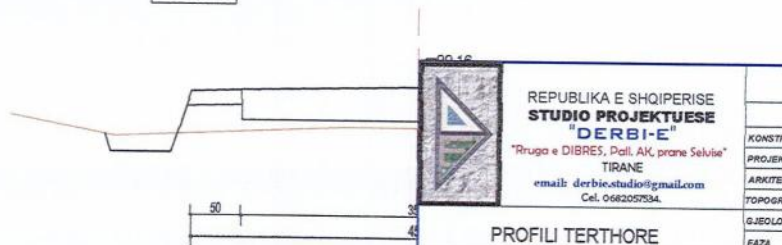

REPUBLIKA E SHQIPERISE
STUDIO PROJEKTORESE
"DERBIE"
"Rruga e DIBRES, Pall. AK prane Selvisë"
TIRANE
email: derbie.studio@gmail.com
Cel: 0682057534.

SISTEMIM ASFALTIM I RRUGES
QENDER SUKE - PODGORAN FUSHË
GRUPI I PROJEKTIMIT

KONSTRUKTOR	Ing. Bexhet Dedja
PROJEKTUES	Ing. Alban Hoxha
ARKITEKT	Ark. Olgjer Qirjaqi
TOPOGRAF	Top. Tahir Hasa
GJEOLOG	Ing. Zenel Hysa
FAZA	Projekt zbatimi
DATA	Tetor 2008



PROFILI TERTHORE

Sk: 1:50

PROFIL TERTHOR TIP

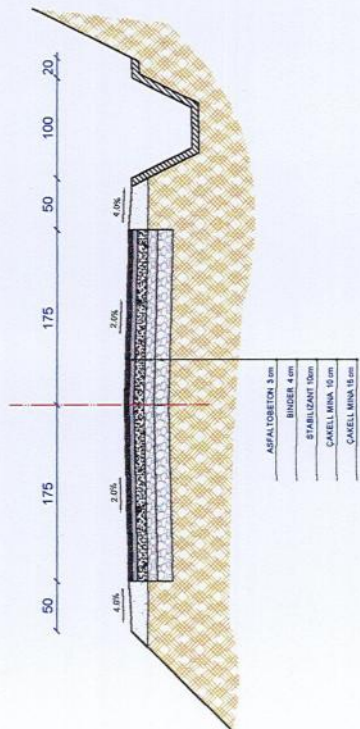

Perdoret nga S1 deri ne S36

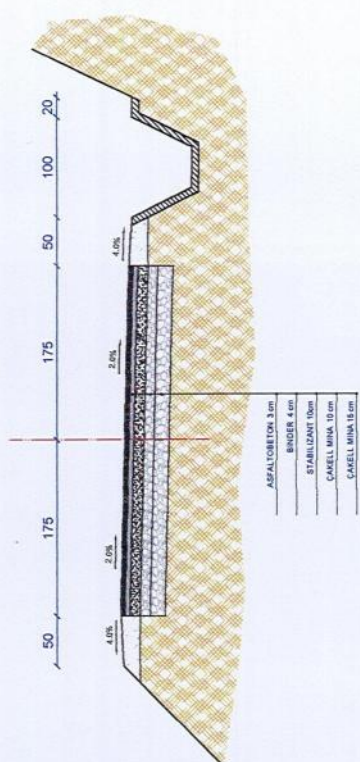

Perdoret ne kthese



REPUBLIKA E SHQIPERISE
 STUDIO PROJEKTORE
 "DERRBI"
 Rruga e DIBRES, palli AK, prane Selvisë
 TIRANE
 email: dch@derbi.com
 Cel: 0992027504

SEKSIONI TERTHORE TIP

SISTEMI I ASFAITIMIT I RRUGES	
QENDER ROME - PODGORICA RUMI	
GRUPI I PROJEKTIMIT	
KONSTRUKTORE	Ing. Beqir Deda
PROJEKTORE	Ing. Alban Hoxha
ANOTIMET	Ark. Oliver Qijasi
TOPOGRAFI	Top. Tahir Hysa
GEORRUGJE	Ing. Zaim Hysa
DATA	Tetor 2008
SH	Projekti zbatimi
SH	1:25



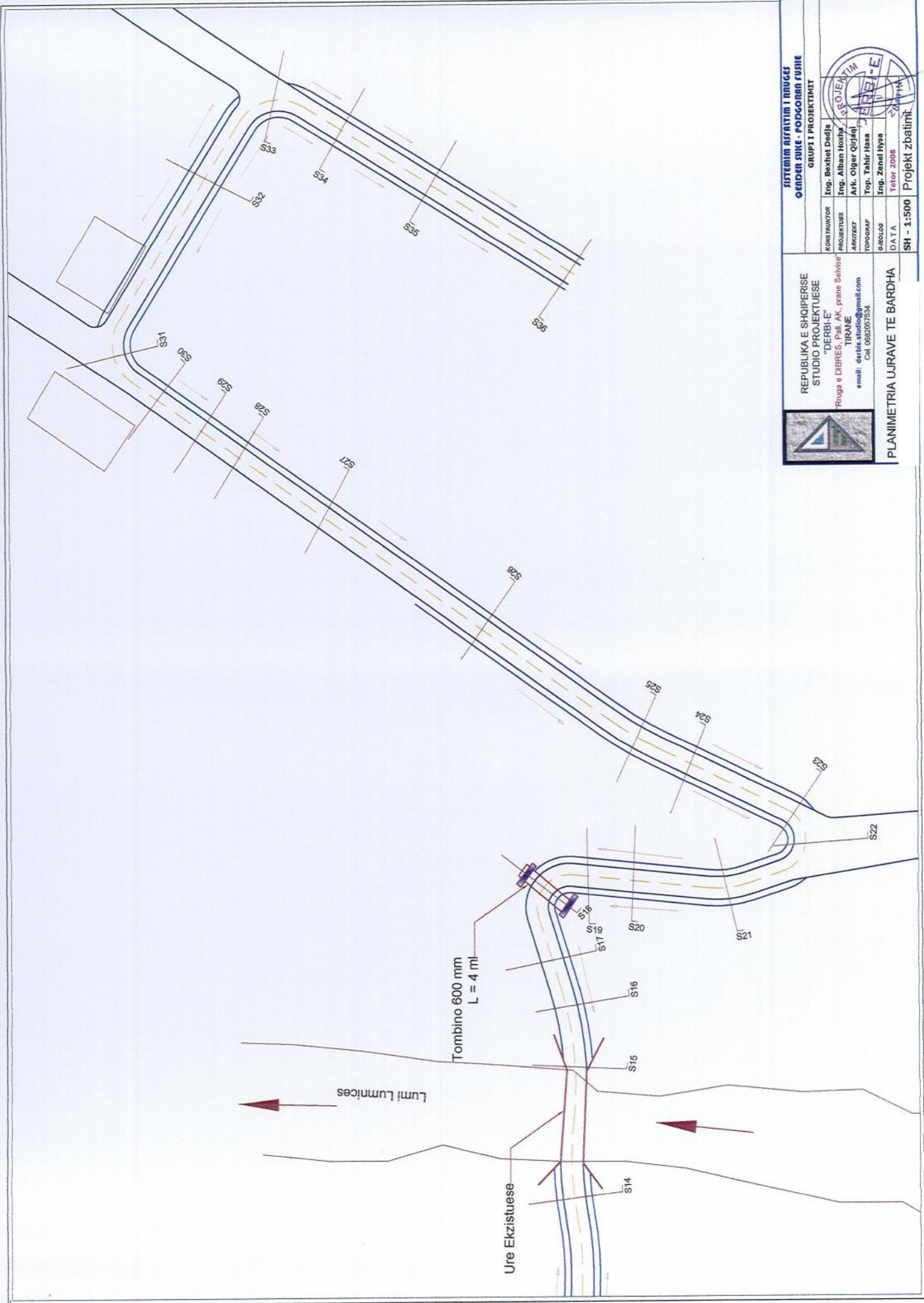

REPUBLIKA E SHQIPERISE
STUDIO PROJEKTUESE
"DERBI-E"
Rruga e DIBRES, Pall. AK. prane Selise
TIRANE
email: derbis.studio@gmail.com
Cel. 0692057534

SISTEMIM ASFRATIM I RRUGES
QENDER SUKE - PODGORAN RUSHIE
GRUPI I PROJEKTIMIT

KONSTRUKTOR	Ing. Beqhet Deda
PROJEKTUES	Ing. Alban Hoxha
ASKREZT	Ark. Oliver Qirjali
POZICAF	Top. Tahir Hasa
GAZOLLO	Ing. Zened Hysa
DATA	Tetor 2008
SH - 1:500	Projekti zbatim.



PLANIMETRIA UJRAVE TE BARDHA

DETAJI I PUSTES SE UJRAVE TE SHIUT

PAMJE ANESORE E PUSTES SE GIZES SHKALLA 1:5

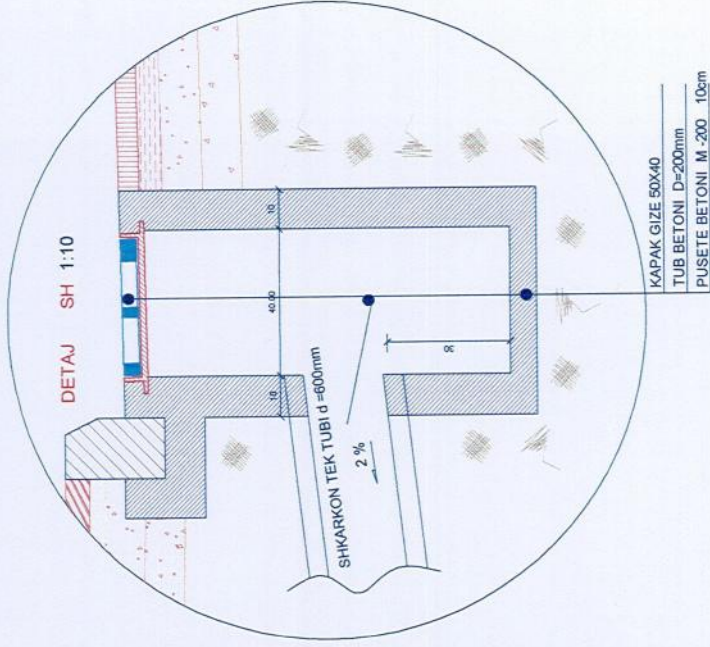
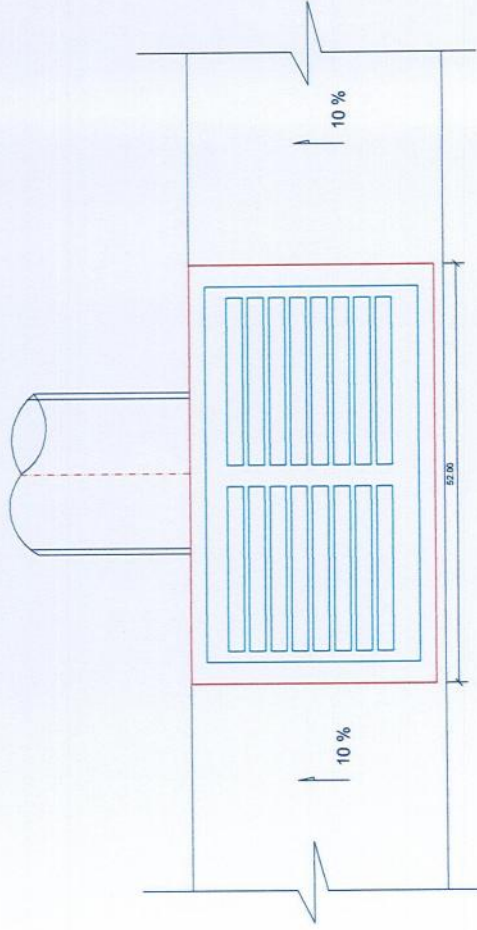

REPUBLIKA E SHQIPERISE
STUDIO PROJEKTORE
"DERBIE"
Rruga e DIBRES Palli AK, Prane Sabirine
Kod Postar: 11010
email: derbiestudio@gmail.com
Cof: 085252534

INSTITUTI ARKITEKTURIAL I BANGJES
QENDRI I UJRAVE - POPULLIMI RULITE

konstruktore	Ing. Sh. Sh. Sh.
projektor	Ing. A. A. A.
arkitekt	Ark. O. O. O.
projektor	Topi, T. T. T.
konstruktore	Ing. Z. Z. Z.
DATA	Tetor 2023
SH - 1:25	Projekt Zbatim

PUSETAT SHIMBLEDEHESE

PLANIMETRIA

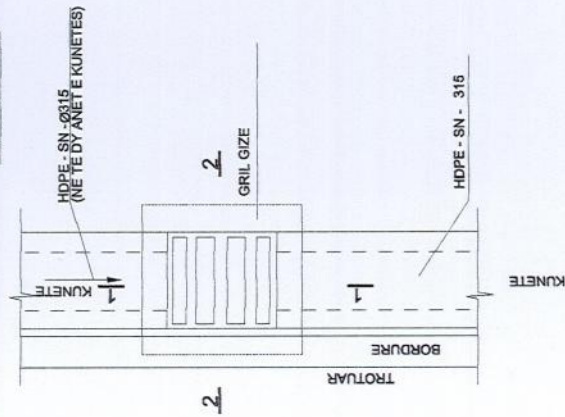

PRERJA 1-1

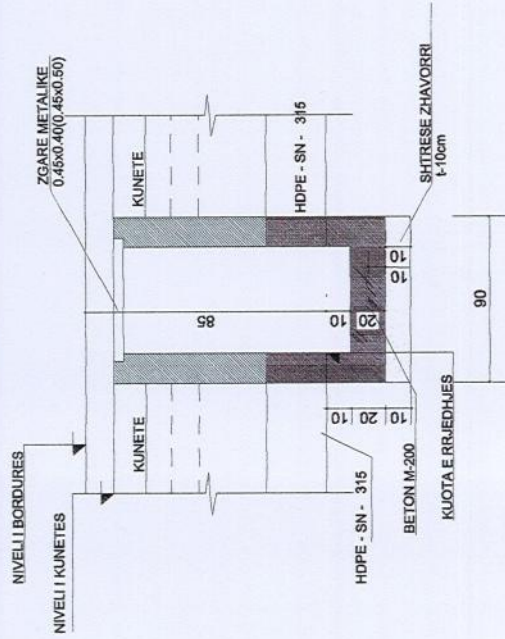

PRERJA 2-2

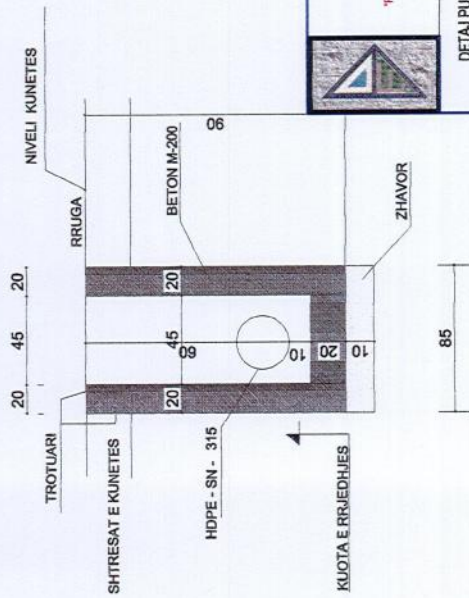

PRERJE TERTHORE E KANALIZIMEVE ME TUBO P.V.C. Ø250, Ø315 DHE Ø400

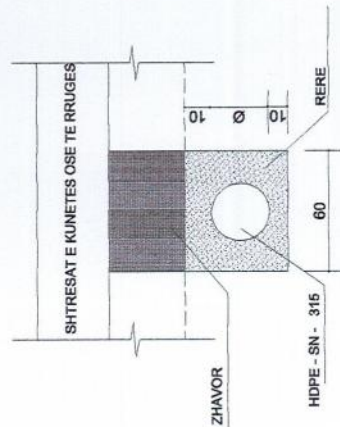

REPUBLIKA E SHQIPERISE
STUDIO PROJEKTORE
"DERBI-E"
TRANE
"Rruga e DIBRES, Pall. AK, prane Shkollës"
email: derbi-studio@gmail.com
Cel: 068208301

KUTURIMI EFFETTIVO I BRAGAT
GONDIA ERM - FODSOMBA PERE
GRUPPI PROJEKTIK

KOMITIMTOR	Inj. Robert Bogja
PROJEKTUES	Inj. Alban Hoxha
APROVATOR	Ark. Oliver Gjilaj
PROJEKTUES	Top. Tahir Hasan
GRUPPORE	Inj. Zined Myta
DATA	Tetor 2008
SH - 1135	Projekt zballim

DETALJ PUSETE SHIMBLEDEHESE

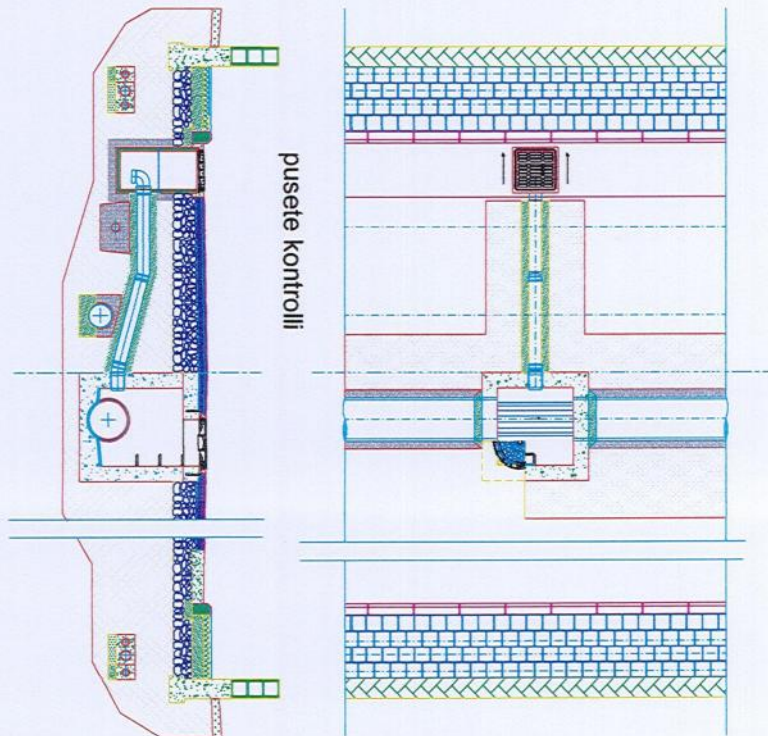

pusete kontrolli

Planimetri dhe seksione rugeore tip

	REPUBLIKA E SHQIPERISE STUDIO PROJEKTOUESE "DERBI-E" "Rruga e DIBRES, Pall. AK, prane Selvisit" TIRANE email: derbi.studio@gmail.com tel: 0682657334		SISTEMIM ASFALTIM I RRUGES QENDER RUKË - PODGORAN RUSHE GRUPI I PROJEKTOUES	
	KONSTRUKTOR	Ing. Bekhet Deda	PROJEKTOUES	Ing. Alban Hoxha
ARKITECT	Ark. Olgjer Dajshi	TOPOGRAFI	Top. Tahir Hysa	
GEOLLOZ	Ing. Zeneel Hysa	D. A. T. A	Tetor 2008	
DETAJ PUSETE U.B		SH - 1:25	Projekt zbatimi	

lidhje - puseste
 tub i lidhjes: pvc Ø 160
 tub i ujrave te bardha: beton Ø 500

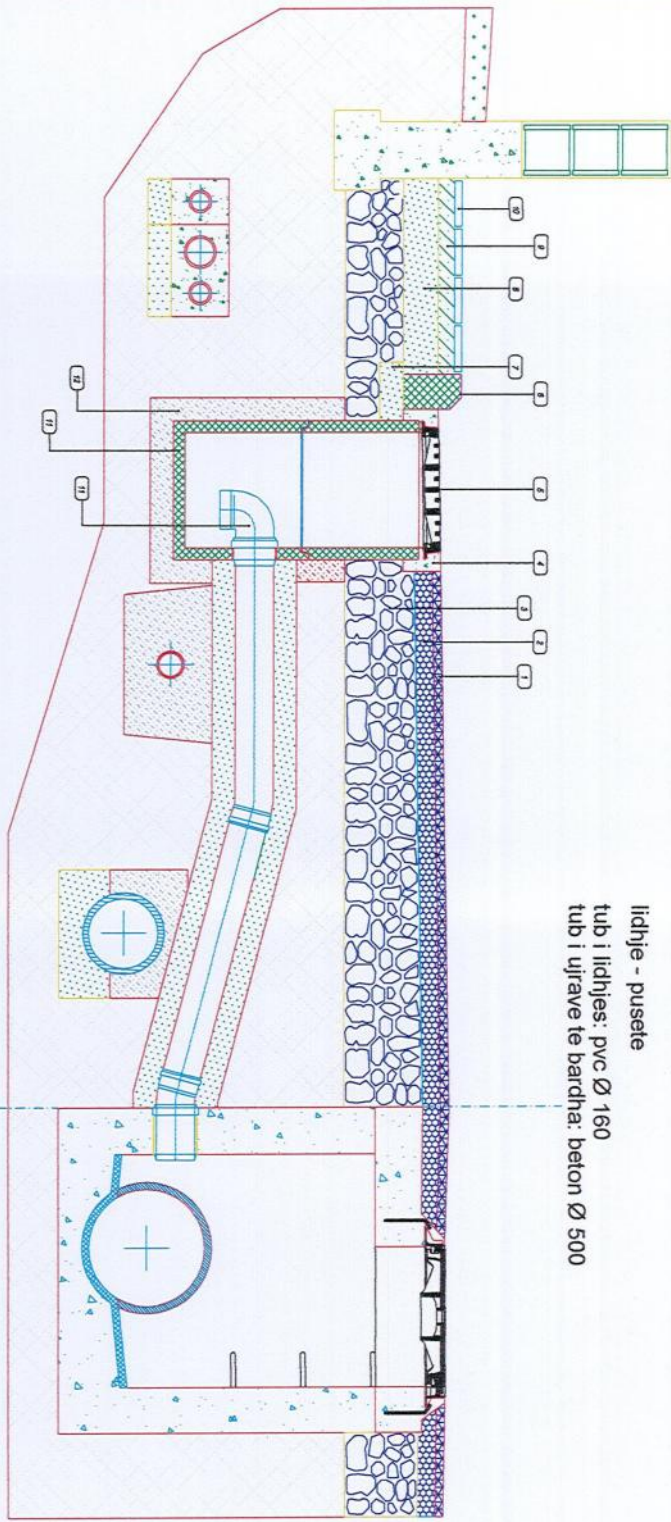

LEGJENDA

- 1 Asfaltbeton
- 2 Binder
- 3 cakull
- 4 korigjimentat diametrole
- 5 grille e sheshte GL
- 6 bordure rruqore
- 7 themel / bordures - beton
- 8 cakulli trotuar
- 9 zhanvor
- 10 plake betoni per trotuar
- 11 puseste betoni e paralelkuar
- 12 shtese rreze
- 13 Tub PVC
- 14 granit
- 15 kursete
- 16 tub i ujrave te bardha
- 17 puseste kontrolli

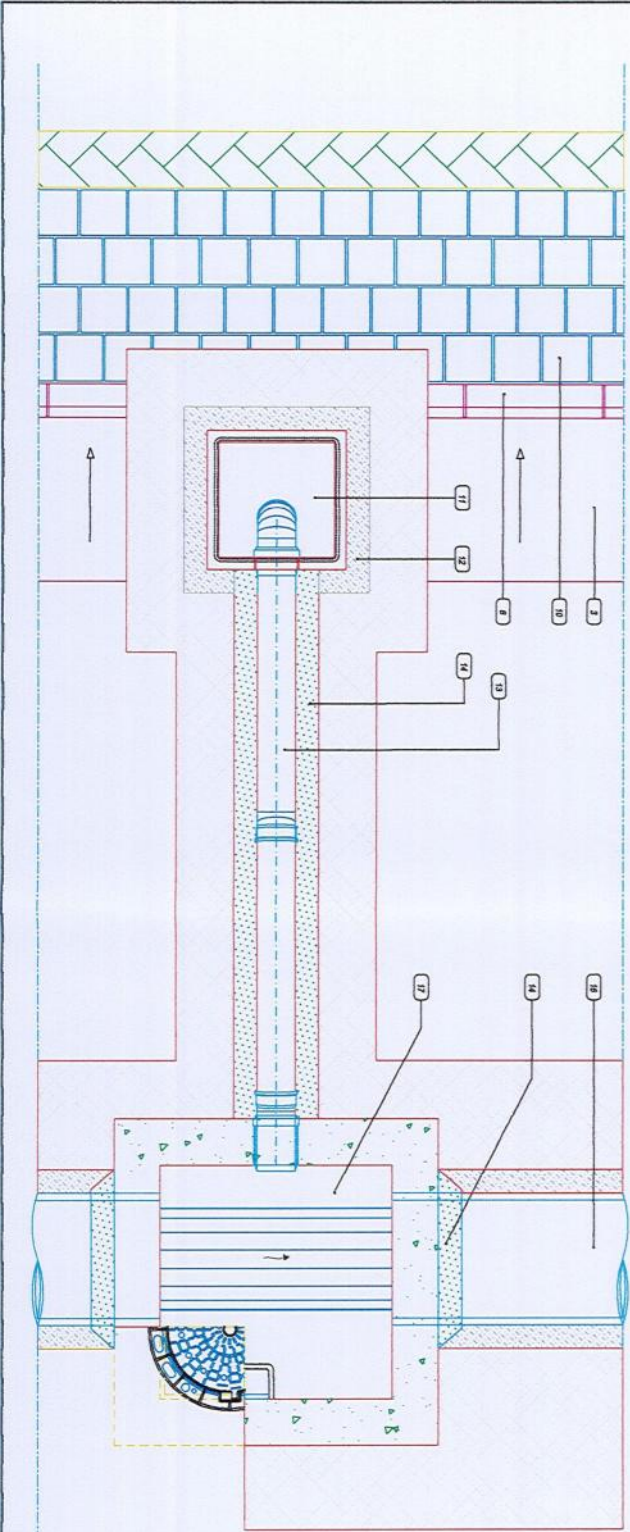

 <p>REPUBLIKA E SHQIPERISE STUDIO PROJEKTOUSE "DERBI-E" Rruga e DIBRES Pali AK, prane Selvise TIRANE email: derbi.studio@gmail.com Cel. 082057534</p>	SISTEMIM ASFALTIM I RRUGES QENDER RUCHE - PODOGRIFFUSKE GRUPI I PROJEKTIMIT	
	KONSTRUKTOR PROJEKTUES ARKITEKT TOPOGRAF GJERBOLLOS D A T A SH - 1:25	Ing. Beqet Dedja Ing. Alban Hoxha Ark. Olgjer Qibjazi Top. Tahir Hesa Ing. Zeset Hysa Tetor 2008 Projekt zbatim

DETAJ PUSETE U.B

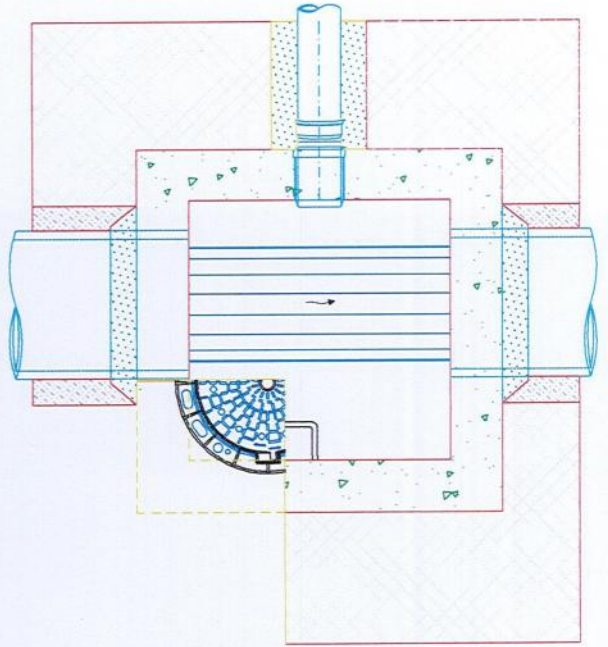

Puste kontrolli ne linje - derdhje nga kapaku
tub shkarkimi betoni Ø 500

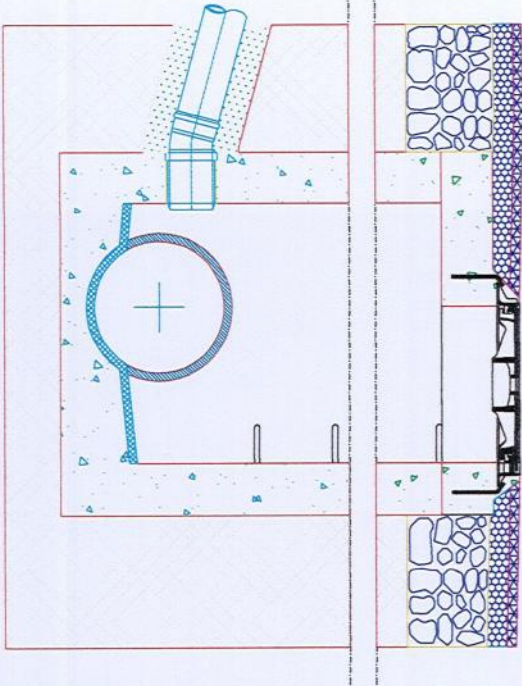

ca. 100
ca. 140

LEGJENDA

1	tundi i pusetes
2	hidrozollim
3	tub i shkarkimi te ujrave te zeza
4	lithes celiku Ø 10 cdo 12 cm
5	shkallje celiku
6	kapak gjeza D400 - hap. dhije Ø 800 mm
7	asfaltbeton
8	Binder
9	soleta betonarme
10	pusete betoni
11	themeli rrugore
12	mbushje me inerte
13	rare
14	xhunto elastike

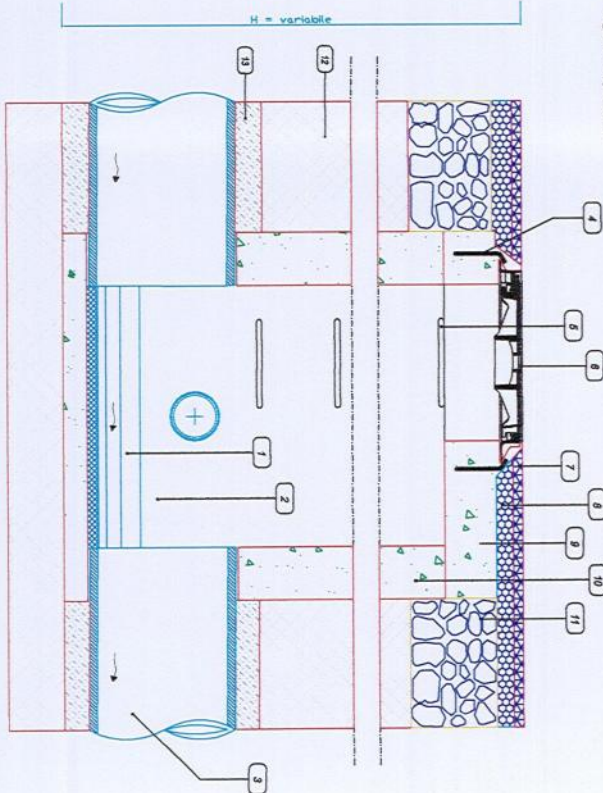

ca. 100
ca. 140

 REPUBLIKA E SHQIPERISE STUDIO PROJEKTUESE "DERBI-E" Rruga e DIBRES, Pali, AK, prane Selvisit TIRANE email: derbi.studio@gmail.com Cel: 0682557334	SISTEMIM ASFAITIM I RRUGES OENDER SUKE - PODGORAN RUGJE GRUPI I PROJEKTIMIT	
	KONSTRUKTORI PROJEKTUESI ARKITEKT TOPOGRAF SURTOLOG D. A. T. A	Inz. Beket Dedja Inz. Alban Hoxha Ark. Oliver Qijasi Top. Tahir Haxa Inz. Zefel Hysa Tetor 2008
DETAJ PUSETE U.B		SH - 1:25 Projekt zbatimi

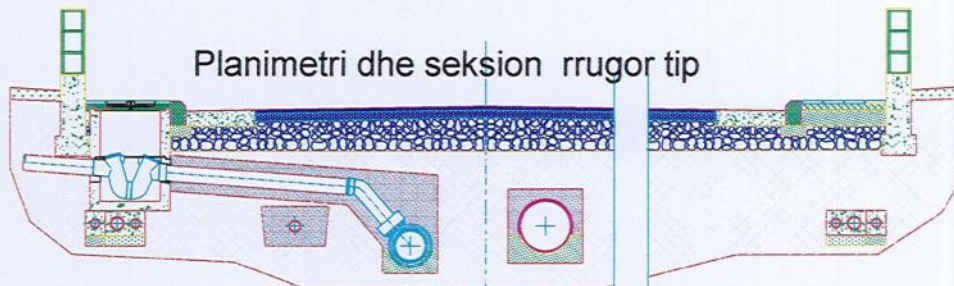

Lidhje private

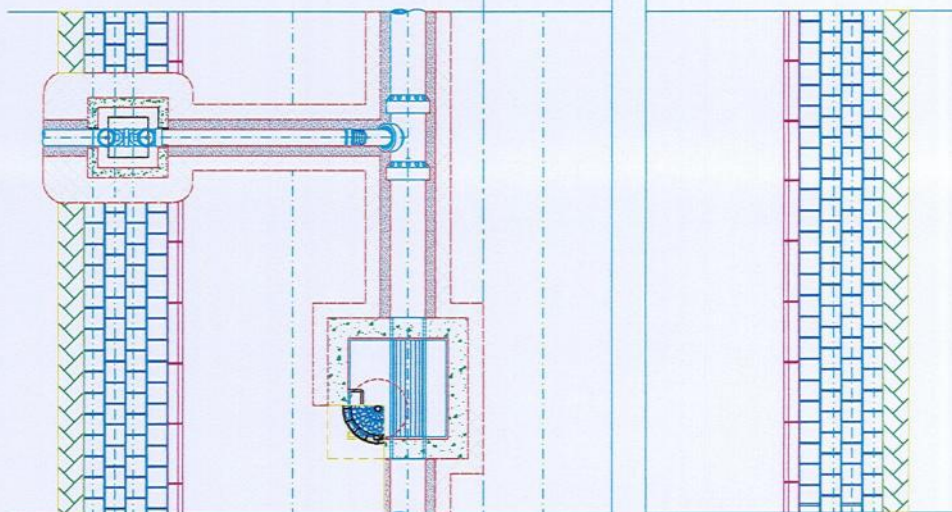

PUSETE KONTROLLI

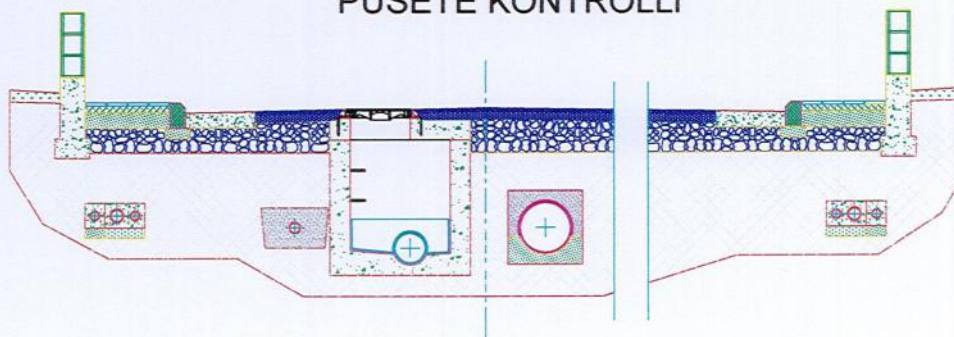

 REPUBLIKA E SHQIPERISE STUDIO PROJEKTOESE "DERBI-" "Rruga e DIBRES, Pall. AK, prane Selvisë" TIRANE email: derbi.studio@gmail.com Cel. 0682057334	SISTEMI I ASFALTIMIT I RRUGES QENDER RUGE - PODGORAN RUGE GRUPI I PROJEKTIMIT	
	KONSTRUKTOR PROJEKTUES ARHITEKT TOPOGRAF GJEOLOG DATA	Ing. Bexhet Dedja Ing. Alban Hoxha Ark. Olgjer Qirjazi Top. Tahir Hasa Ing. Zemel Hysa Tetor 2008
DETAJI PUSFTF SH - 1:25	Projekt zbatimi	

lidhje private e u.z

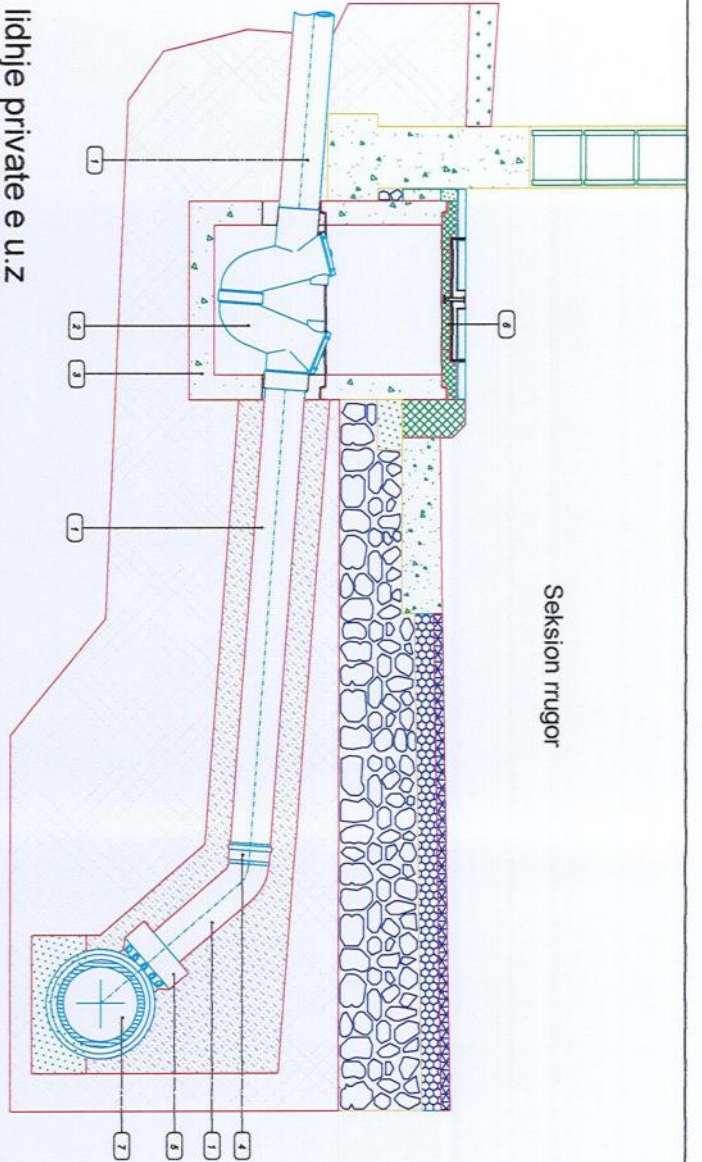

Seksion rrugor

planimetri

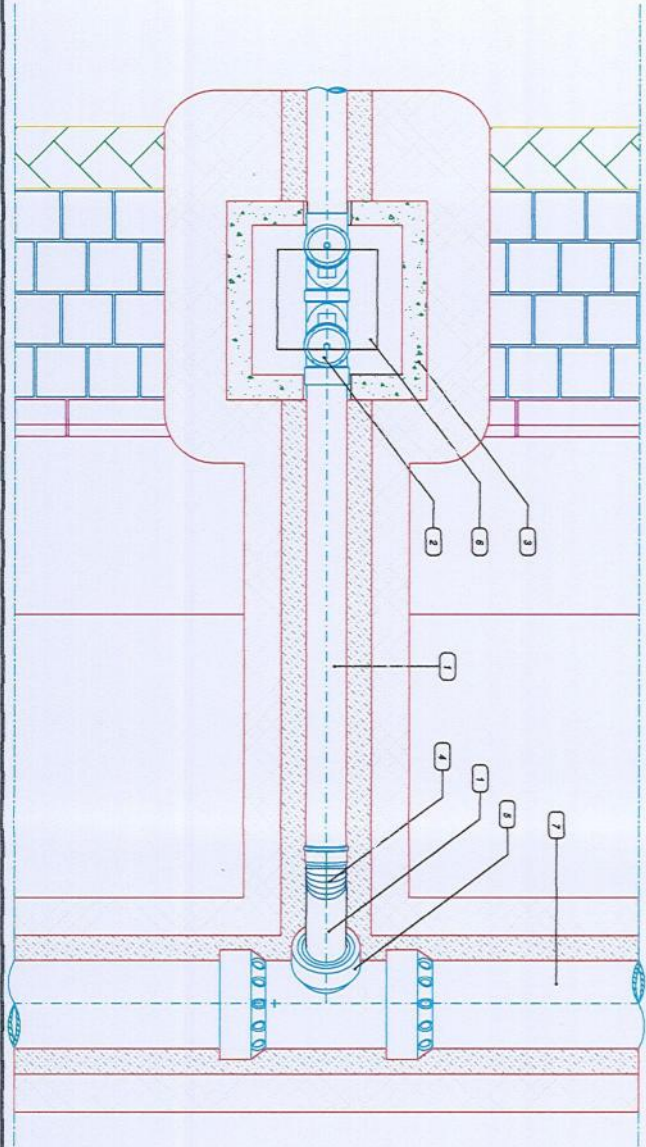

LEGIENDA	
1	Tub PVC tip SN - mm 160
2	Silon PVC - mm 160
3	pusete e parafabrikuar betoni
4	bnj / PVC - 45°
5	Brake Gras 90° me degazim DN 160
6	kapak
7	katëktor / ujtrave te zezra gras DN 300

 <p>REPUBLIKA E SHQIPERISE STUDIO PROJEKTUESE "DERBIE" Rruga e DIBRES, Pali AK, prane Selvisë TRANE email: derbie.studio@gmail.com Cel. 0682057334</p>	<p>SISTEMIM ASFRATIM I RRUGES QENDER SUKTE - PODGOORRI, JANINE GRUPI I PROJEKTIMIT ROJEXIM</p>	
	<p>KONSTRUKTOR Ing. Bexhet Dodja</p> <p>PROJEKTUES Ing. Alban Hoxha</p> <p>ARKITEKT Ark. Olgër Qirjaqi</p> <p>TOPOGRAF Top. Tahir Haxa</p> <p>QESOLOG Ing. Zenel Hysa</p> <p>D.A.T.A Tetor 2008</p>	<p>SH - 1:25 Projekt zbatimi</p>

DETAJ PUSETE

DETAJET E SEKSIONIT TERTHORE TIP

DETAJI - A SHKALLA 1:5

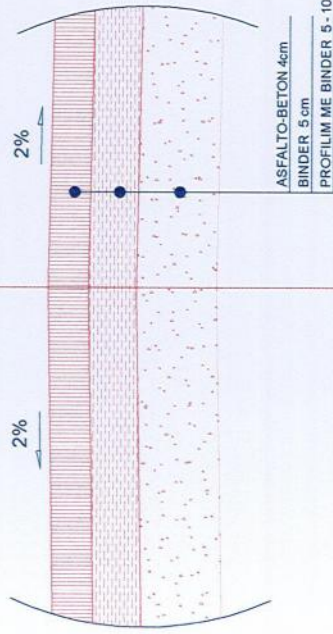

DETAJI -B1 SHKALLA 1:10

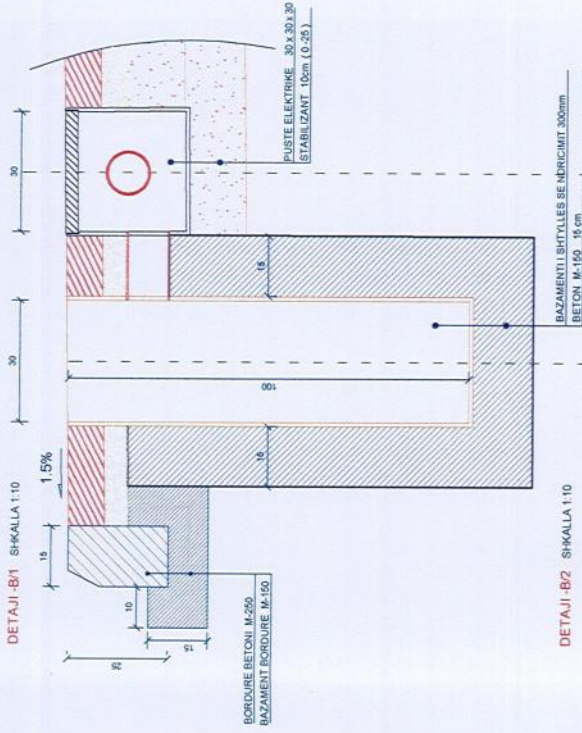

DETAJI D SHKALLA 1:10

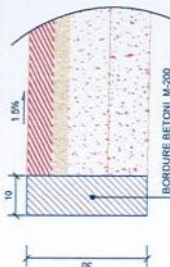

DETAJI -B2 SHKALLA 1:10

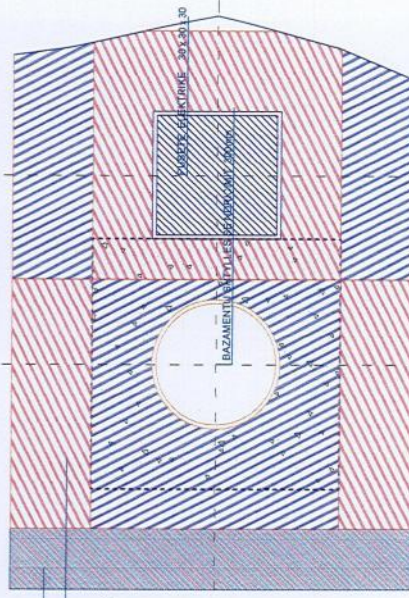

DETAJI -B3 SHKALLA 1:10

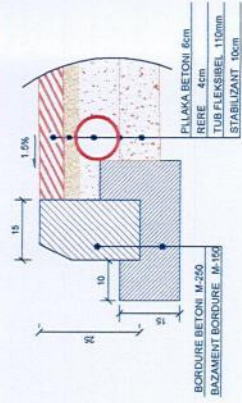

DETAJI -B4 SHKALLA 1:10
BOROURE E ULUR NE HYRIET E SHTEPVE

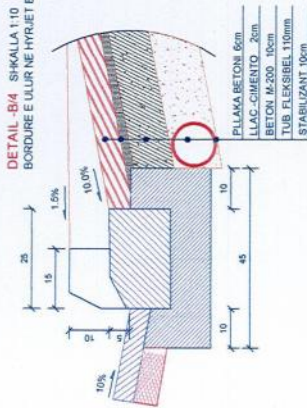

REPUBLIKA E SHQIPERISE
STUDIO PROJEKTORESE
"DERBIE"
TIRANE
Rruga e DIBRES, Pall. AK. para Selvisë
email: derbie@derbie.com
derbie@derbie.com
Cell: 0680670264

SISTEMIM BIFATIM I RRUGËVE
QENDËR JUKË - PODOCOMARTURË
GRUPI I PROJEKTOREVE JEKTA
ING. BASHKËTËRË
ING. ALBAN HOQA
ARK. OJGËR QJIFAJ
TOP. TASHI RISA
ING. ZEMEL HYSA
Të bërë 2008
Projekti zbatim

DETAJ PUSETE U.B

SH - 125

PRERJE GJATESORE E TUBACIONIT NE RRUGE DHE Pusetave

Prerje e vendosjes pusetave prej betoni

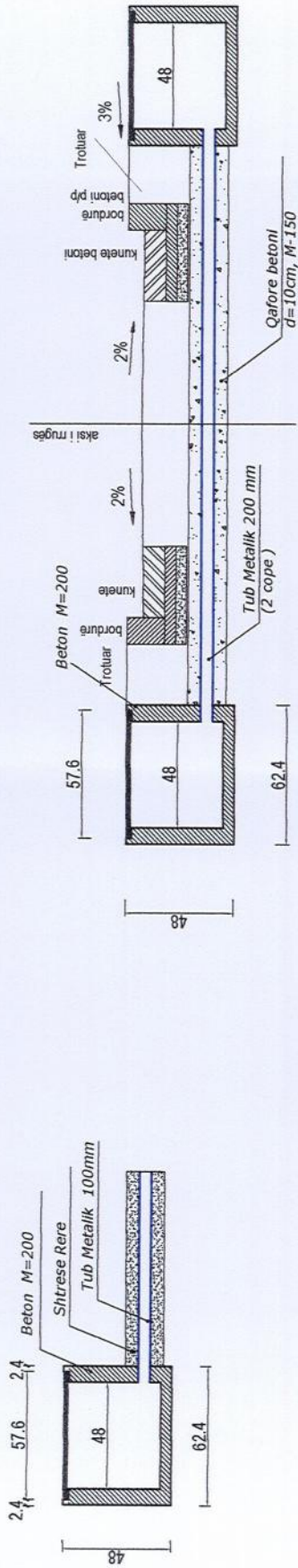

SHËNIME :

- Gjatë realizimit të intersektimeve kuota e vendosjes së pusetave prej gize mund të ndryshojë sipas rasisit
- Tubi mund të vendoset me një pjerrësi të lehtë sipas nevojës. Thellësia e vendosjes duhet të jetë më e vogël se Hmin. = 70cm nga sip. e asfaltit.

PRERJE GJATESORE E TUBACIONIT NE TROTUARE DHE Pusetave

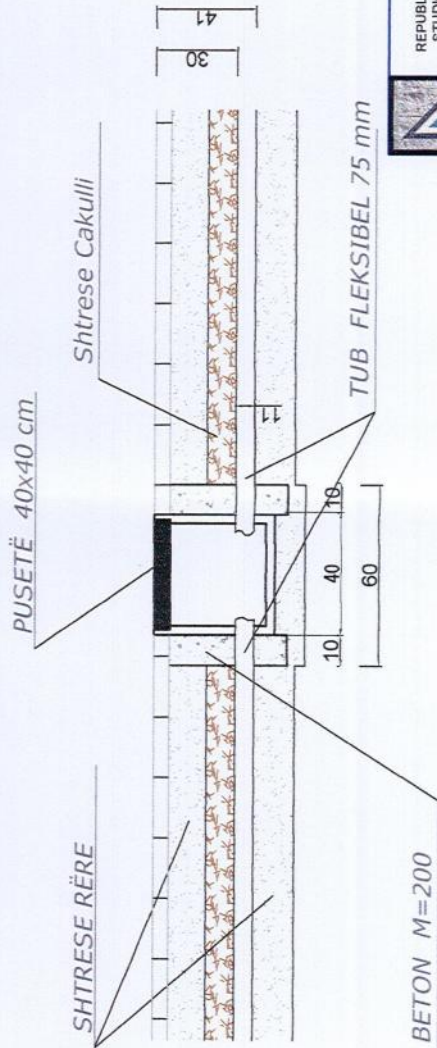

REPUBLIKA E SHQIPERISE
STUDIO PROJEKTUESE
"DERBIE"
Rruga e DIBRES Pall. AK. prane Shkolës
TIFANE
email: derbie.studio@gmail.com
Cel: 069267534

DETAJ TUBACIONESH

BETON M=200

TUB FLEKSIBEL 75 mm

Shtrese Cakulli

PUSETË 40x40 cm

SHTRESE RËRE

SISTEMIM ARRATIM I RRUGES	
OENDER BUIE - PODGORRA FUSHË	
GRUPI I PROJEKTIMIT	
KONSTRUKTOR	Ing. Bechjet Duda
PROJEKTUES	Ing. Alban Hoxha
APROVANT	Ark. Oliver Qifajqi
PROJEKTOAR	Top. Tahir Haxa
ELABORUAR	Ing. Zencel Nysa
DATA	Tetor 2008
SH - 1:25	Projekt zbatimi

PRERJE TERTHORE E TUBACIONIT NE RRUGE

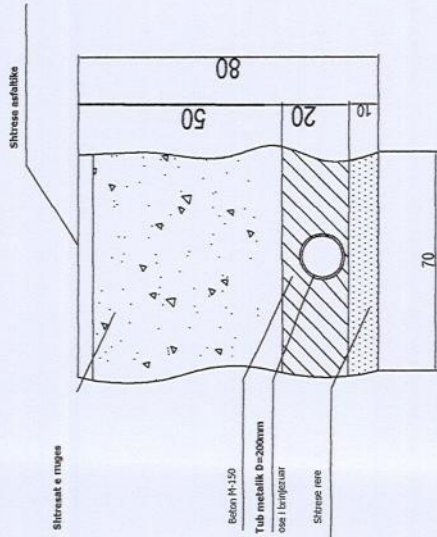
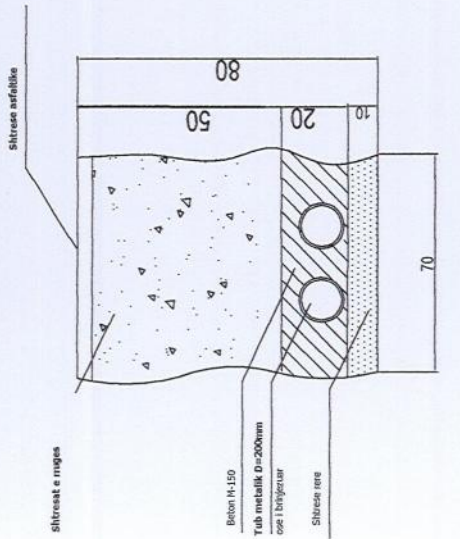

PRERJE TERTHORE E TUBACIONIT NE TROTUARE

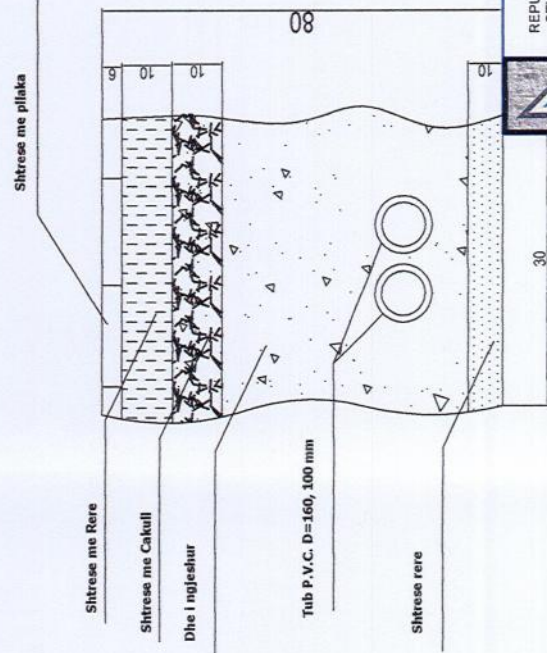
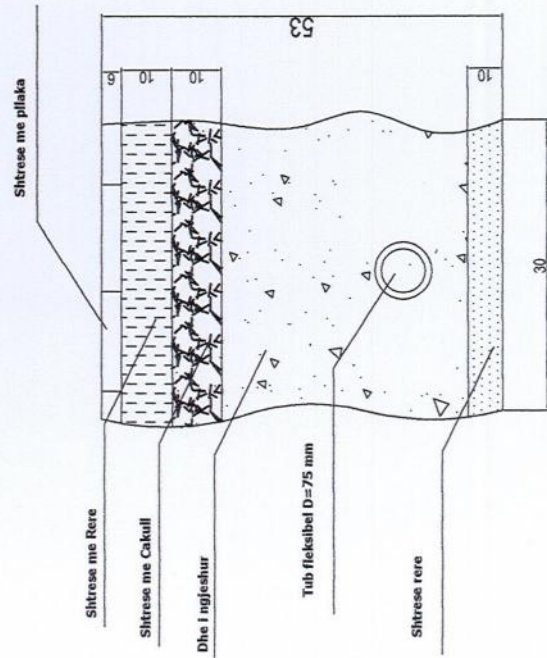

REPUBLIKA E SHOPIPERISE
STUDIO PROJEKTUESE

"DERBIE"
Rruga e DIBRES Pall. AK. pjane Shkollë
TIRANE
email: derbie.studio@gmail.com
Cel: 0692057534

DETAJ TUBACIONESH

SISTEMIM ASFAITIM I RRUGES

QENDER JUKE - PODGORAN RRUHE

GRUPI I PROJEKTIMIT

Kontraktor

Prokurues

Akronizim

Propozuar

kuroroc

DATA

SH - 1:25

Projekt zbatimi



ARMIMI I TUBAVE ME D=600

PRERJE TERTHORE

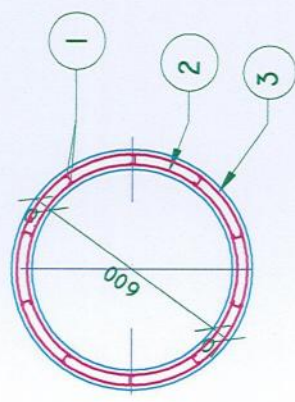

PRERJE GJATESORE

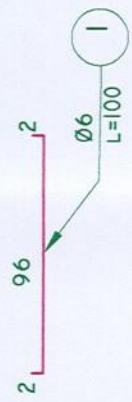
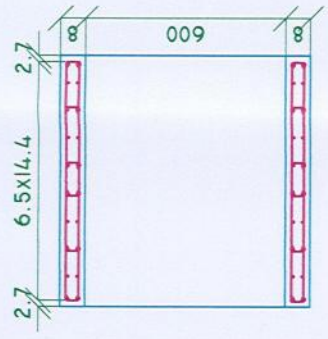

ARMATURA SPIRALE

E JASHTEME

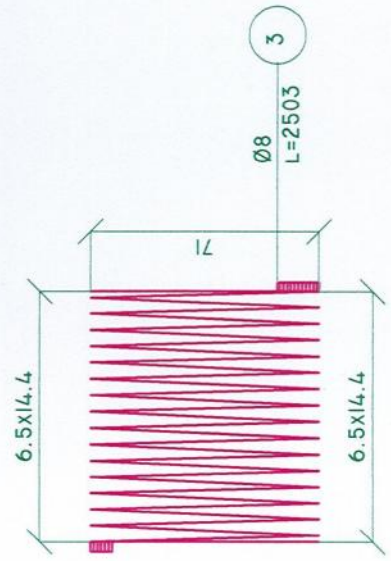

E BRENDESHME

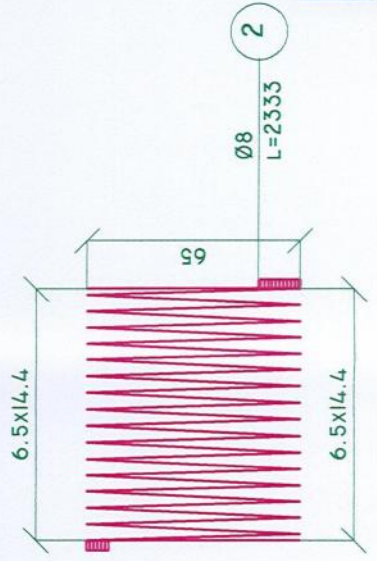

SASIA E HEKURIT PER NJE TUB

POZ NR	Ø mm	L cm	SASIA COPE	L m	ARMATURA PER NJE ELEMENT		
					Ø mm	Σ Lm	Σ PESHA kg
1	6	100	20	20	23.3	0.222	5.16
2	8	2333	1	23.33	8	0.395	19.1
3	8	2503	1	25.03			
4	6	13	25	3.25			
HEKUR FeB 44K PER NJE TUB					kg		24.3
BETON M-200 PER NJE TUB					m ³		0.21



REPUBLIKA E SHQIPERISE
STUDIO PROJEKTUESE
"DERBIE"
"RIVAJA E DIBRES" PALL AX FRANE
SILVIE
TRAFIK
email: derbie@derbie.com
Tel: 0683267534

ARMIMI I TOMBINOS

SISTEMI ARMATIM I RUGEGE
QENDRA JUTE - FOC-CONCRETE



Ing. Bexhet Dega
Ing. Alban Hoxha
Ark. Olgjer Ojzaj
Top. Tahir Hasi
Ing. Zenel Hysi

SH - 1:20
PROJEKT ZBATIMI

Pk. 11
Pr = 276.0 m

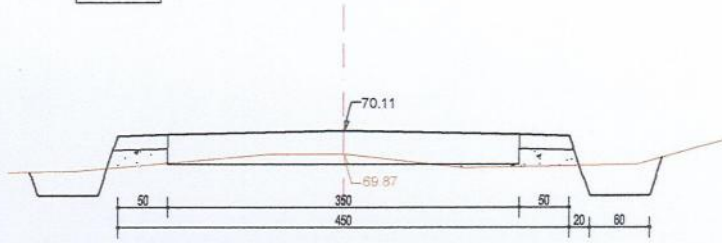

Pk. 12
Pr = 306.0 m

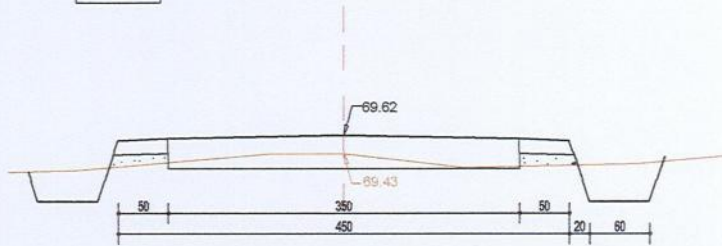

Pk. 13
Pr = 336.0 m

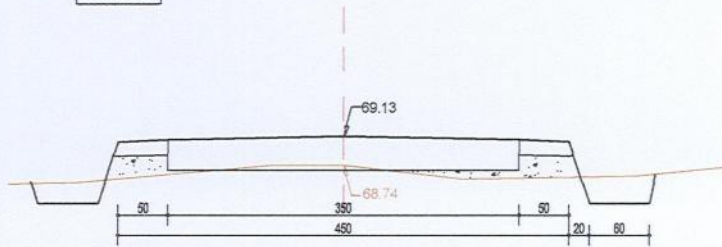

Pk. 14
Pr = 356.0 m

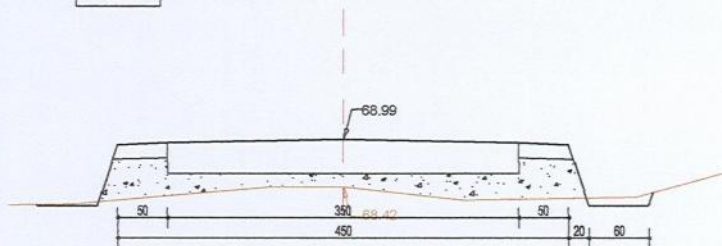

Pk. 15
Pr = 372.0 m

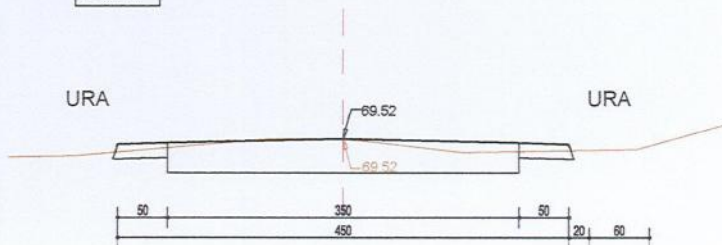

Pk. 16
Pr = 385.0 m

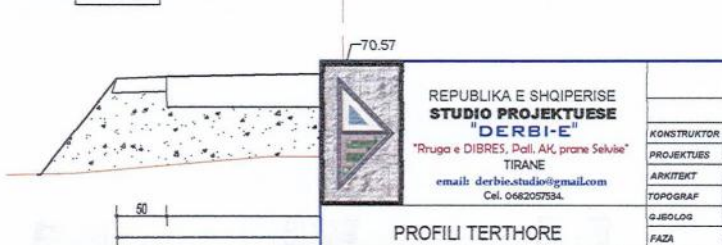

REPUBLIKA E SHQIPERISE
STUDIO PROJEKTORE
"DERBIE"
"Rruga e DIBRES, Dull, AK, pranë Selvise"
TIRANE
email: derbie.studio@gmail.com
Cel: 0682057934.

SISTEMI I ASFALTIM I RRUGES
QENDER SUKE - PODGORAN FUSHE
GRUPI I PROJEKTIMIT

KONSTRUKTOR	Ing. Bexhet Dedja
PROJEKTUES	Ing. Alban Hoxha
ARKITEKT	Ark. Olgjer Qirjaqi
TOPOGRAF	Top. Tahir Hasa
GJEOLOG	Ing. Zenel Hysa
FAZA	Projekt zbatimi
DATA	Tetor 2008



PROFILI TERTHORE

Sk - 1.50

Ure Ekzist

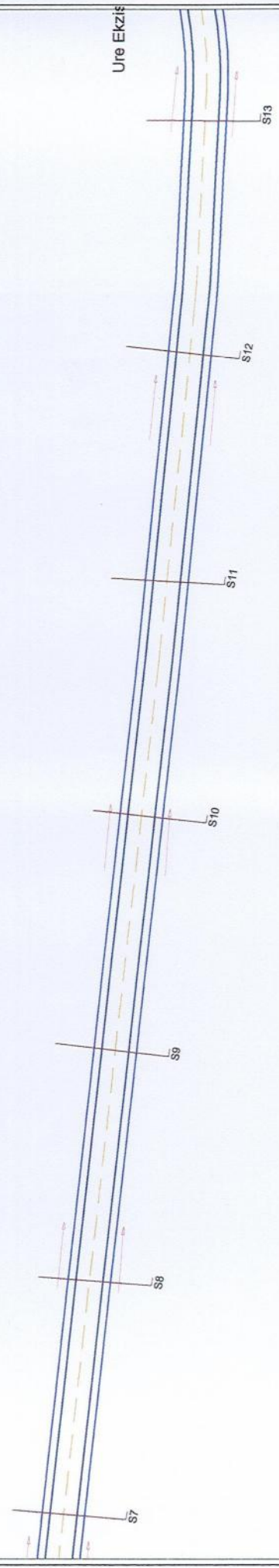

REPUBLIKA E SHQIPERISE
STUDIO PROJEKTOUESE
"DERBLE"
Rruga e DIBRES, Pall. AK, prane "Selvisë"
TIRANE
email: derble.studio@gmail.com
Cel: 0662027534

SISTEMI I ASFALTIM I RRUGES QENDER SUKE - PODGORAN FUSHI	
GRUPI I PROJEKTIMIT	
KONSTRUKTOR	Ing. Bexhet Duda
PROJEKTUES	Ing. Alban Hoxha
APROVANT	Ark. Olgjer Ojzefi
TRACESAR	Top. Tahir Haxa
Q. ASHLOO	Ing. Zenel Hysa
DATA	Tetor 2008
SH - 1:500	Projekt zbatimi

PLANIMETRIA UJRAVE TE BARDHA