



BASHKIA ROSKOVEC

DREJTORI E PLANIFIKIMIT DHE ZHVILLIMIT TE TERRITORIT

OBJEKTI: SISTEMIASFALTIM I RRUGES NR.3, FSHATI VELMISH DHE RIKONSTRUKSIONI I CEZMES PUBLIKE, FAZA-1

SHENIM: NDRYSHIMET NE PROJEKT DUHET TE MIRATOHEN ME PARE NGA GRUPI I PROJEKTIMIT, DHE DREJTORIA E PLANIFIKIMIT DHE ZHVILLIMIT TE TERRITORIT

| | | | | | | | | |
|---|--|---|---|--|----------------------------------|---------|------------|------------------------------|
|  | Porosites Bashkia Roskovec | Projekt SISTEMIM-ASFALTIMI I RRUGES NR.3, FSHATI VELMISH DHE RIKONST- RUKSIONI I CEZMES PUBLIKE, FAZA-1 | Grupi i Projektimit : Ing. Eldison KOCAQI Ing. Erion HOXHA Ing. Arben DUKAJ | Drejtor i P.ZH.T : RAKIP HAZIZAJ | Titull flete KOPERTINA | Date | 25/10/2018 | Flete A3 Nr. 00 |
| | Miratoi Kryetar: Majlinda BUFI | | | | | Shkalla | | |



Porosites
Bashkia Roskovec
Miratoi
Kryetar: **Majlinda Bufi**

Projekt :
**SISTEMIM-ASFALTIMI I RRUGES NR.3,
FSHATI VELMISH DHE RIKONSTRUKSIONI I
CEZMES PUBLIKE, FAZA-1**

Grupi i Projektimit :
Ing. Erion HOXHA
Ing. Eldison KOCAQI
Ing. Arben DUKAJ

Drejtor i P.Z.H.T :
Rakip Hazizaj

Titull flete :
**ZONIM I PROJEKTIT (ORTOFOTO
2015)**

| | |
|---------|------------|
| Date | 25.10.2018 |
| Shkalla | 1:1000 |

Flete A3 Nr.
01



LEGJENDE

-  RRUGE E SHTRUAR ME RERE BITUMINOZE
-  SIPERFACI E PAKISTEMUR
-  TROTUARE EKZISTUESE
-  MURE RRETHUES EKZISTUES
-  GARDHE EKZISTUES



Porosites
Bashkia Roskovec
 Miratoi
 Kryetar: **Majlinda Bufi**

Projekt :
**SISTEMIM-ASFALTIMI I RRUGES NR.3,
 FSHATI VELMISH DHE RIKONSTRUKSIONI I
 CEZMES PUBLIKE, FAZA-1**

Grupi i Projektimit :
 Ing. Erion HOXHA
 Ing. Eldison KOCAQI
 Ing. Arben DUKAJ

Drejtor i P.ZH.T :
Rakip HAZIJAJ

Titull flete :
PLANIMETRIA E PERGJITHSHME





Date
 Shkalla

25.10.2018
 1:750

Flete A3 Nr.
02









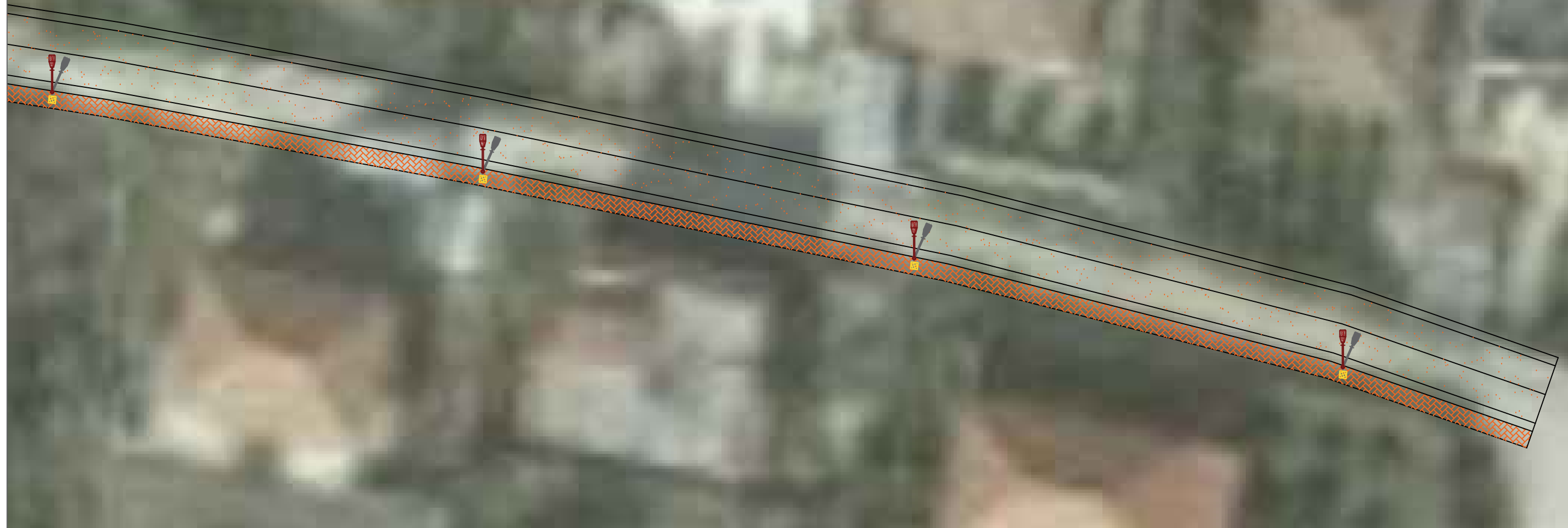



LEGJENJE

-  RRËZE E SYTRUAR ME PËRE BITUMINGJË
-  SIPERFAQE E PASISTEMJAR
-  TRUTUARE EKZISTUERE
-  MURE RRETHUES EKZISTUES
-  GARDHE EKZISTUES

| | | | | | | | | |
|---|--|---|--|---|---|------|------------------|---------------------------|
|  | Porosites Bashkia Roskovec | Projekt : SISTEMIM-ASFALTIMI I RRUGES NR.3, FSHATI VELMISH DHE RIKONSTRUKSIONI I CEZMES PUBLIKE, FAZA-1 | Grupi i Projektimit : Ing. Erion HOXHA Ing. Eldison KOCAQI Ing. Arben DUKAJ | Drejtor i P.Z.H.T : Rakip HAZIJAJ | Titull flete : PLANI I RILEVIMIT I RRUGES | Date | 25.10.2018 | Flete A3 Nr. 03 |
| | Miratoi Kryetar: Majlinda Bufi | | | | | | Shkalla 1:350 | |



LEGJENDE

- | | | | |
|---|------------------------------------|---|------------------------------|
|  | RRUGE E SHTRUAR ME RERE BITUMINOZE |  | GARDHE EKZISTUES |
|  | SIPERFAQE E GJELBERUAR |  | PUSETE ELEKTRIKE 40X40X40 cm |
|  | TROTUARE ME PLLAKA |  | PUSETE B/A SHIU 40X40X100 cm |
|  | MURE RRETHUES EKZISTUES |  | KUNETE BETONI, 0.5m |
|  | SHTYLLA ELEKTRIKE H=7m |  | MUR RRETHUES I RI |



Porosites
Bashkia Roskovec
Miratoi
Kryetar: **Majlinda Bufi**

Projekt :
**SISTEMIM-ASFALTIMI I RRUGES NR.3,
FSHATI VELMISH DHE RIKONSTRUKSIONI I
CEZMES PUBLIKE, FAZA-1**

Grupi i Projektimit :
Ing. Erion HOXHA
Ing. Eldison KOCAQI
Ing. Arben DUKAJ

Drejtor i P.ZH.T :
Rakip HAZIJAJ

Titull flete :
**PLANI I PERGJITHSHEM I
RRUGES**

Date

25.10.2018

Shkalla

1:300

Flete A3 Nr.

04

PROFILAT TERTHORE
 Profili Nr.0
 Progresivi 0.0 m
 K.Tokes 24.00 m
 K.Projektit 24.28m
 Germim= 0.20 m3/m
 Mbushje= 1.40 m3/m

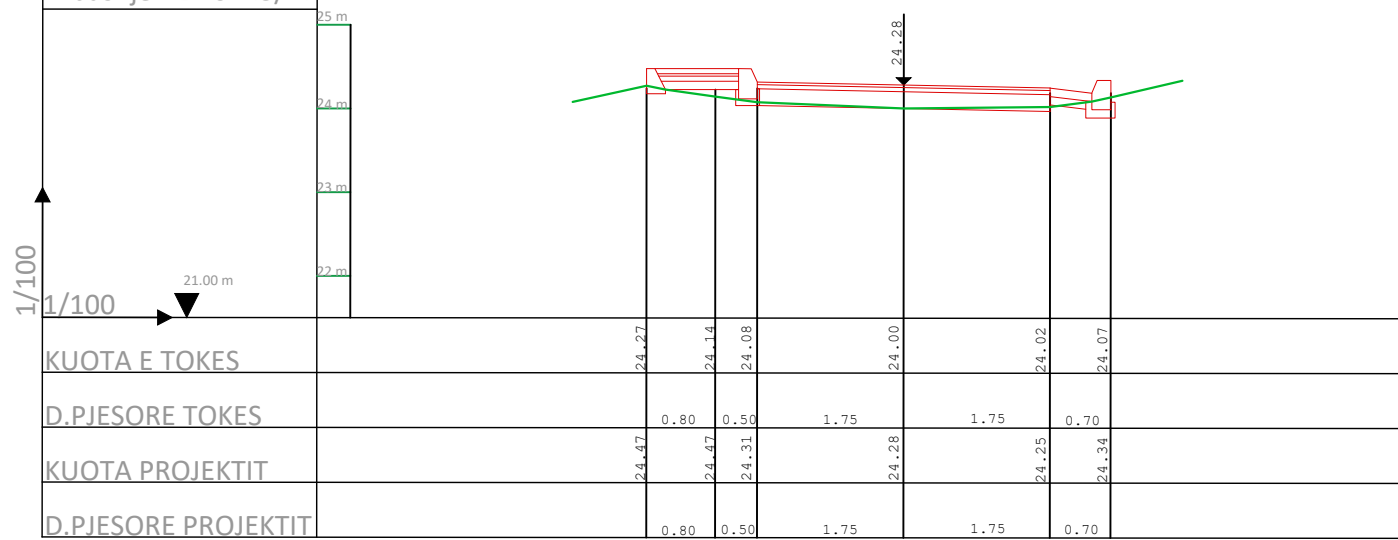

PROFILAT TERTHORE
 Profili Nr.1
 Progresivi 10.0 m
 K.Tokes 24.00 m
 K.Projektit 24.28m
 Germim= 0.213 m3/m
 Mbushje= 1.38 m3/m

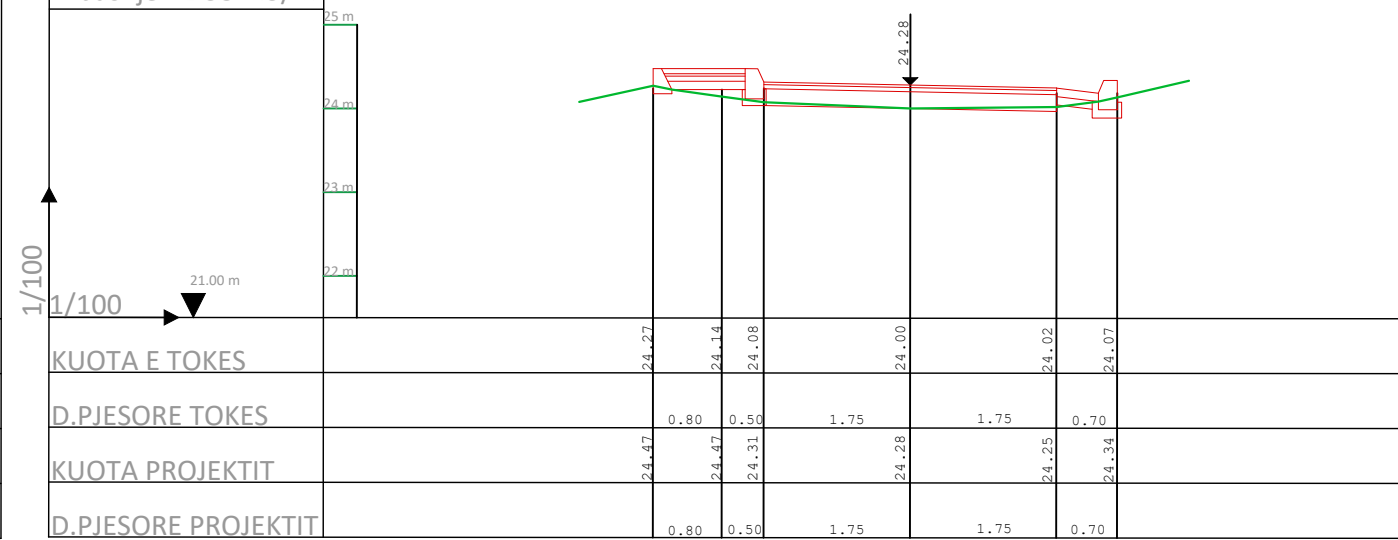

PROFILAT TERTHORE
 Profili Nr.2
 Progresivi 51.0 m
 K.Tokes 24.00 m
 K.Projektit 24.28m
 Germim= 0.21 m3/m
 Mbushje= 1.41 m3/m

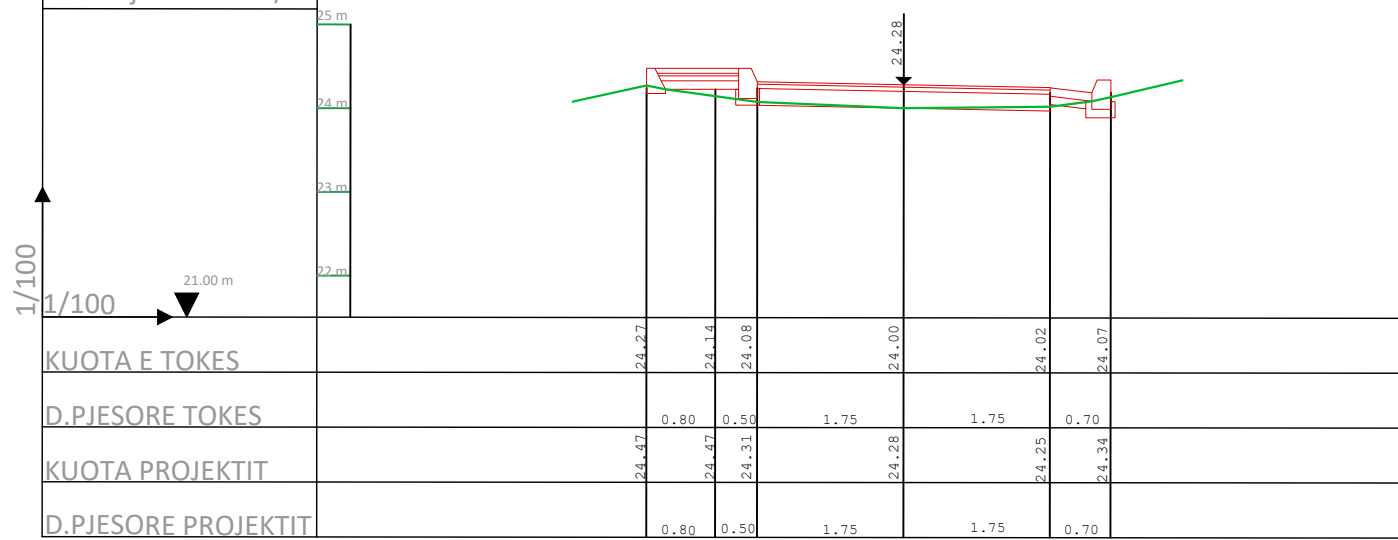

PROFILAT TERTHORE
 Profili Nr.3
 Progresivi 106.0 m
 K.Tokes 24.00 m
 K.Projektit 24.28m
 Germim= 0.20 m3/m
 Mbushje= 1.389 m3/m

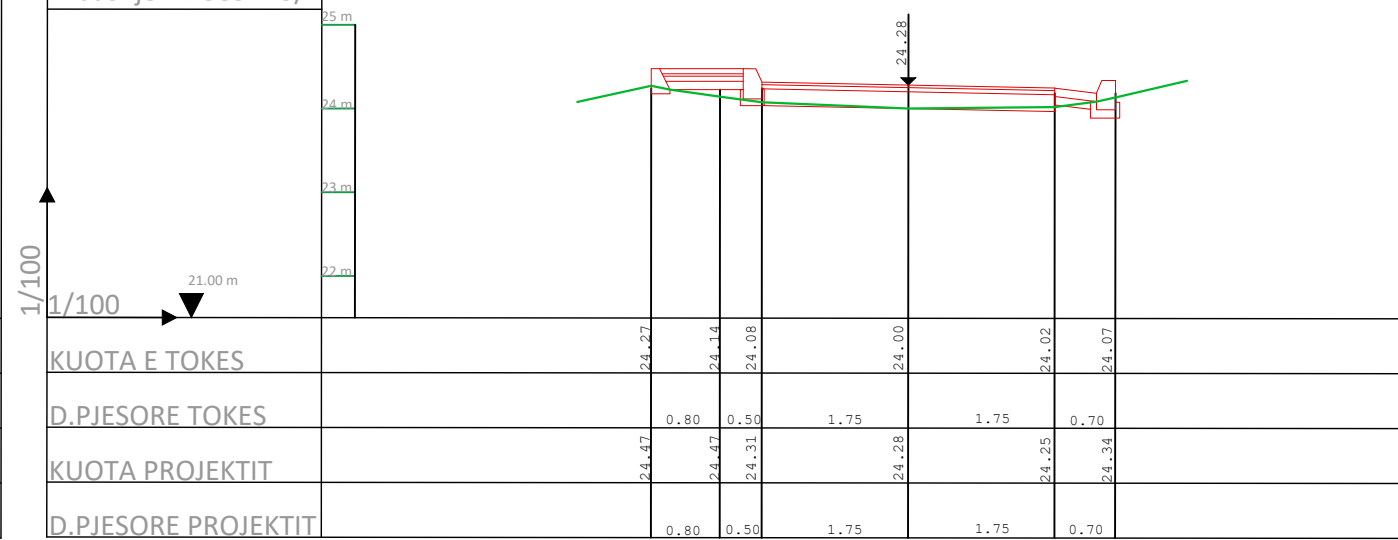

Porosites
Bashkia Roskovec
 Miratoi
 Kryetar: **Majlinda Bufi**

Projekt :
SISTEMIM-ASFALTIM I RRUGES NR.3,
FSHATI VELMISH DHE RIKONSTRUKSIONI I
CEZMES PUBLIKE, FAZA-1

Grupi i Projektimit :
 Ing. Erion HOXHA
 Ing. Eldison KOCAQI
 Ing. Arben DUKAJ

Drejtor i P.Z.H.T :
Rakip HAZIJAJ

Titull flete :
PROFILE TERTHORE TE RRUGES

Date
 25.10.2018
 Shkalla
 1:100

Flete A3 Nr.
06

PROFILAT TERTHORE
 Profili Nr.4
 Progresivi 150.0 m
 K.Tokes 25.00 m
 K.Projektit 25.28m
 Germim= 0.21 m3/m
 Mbushje= 1.376 m3/m

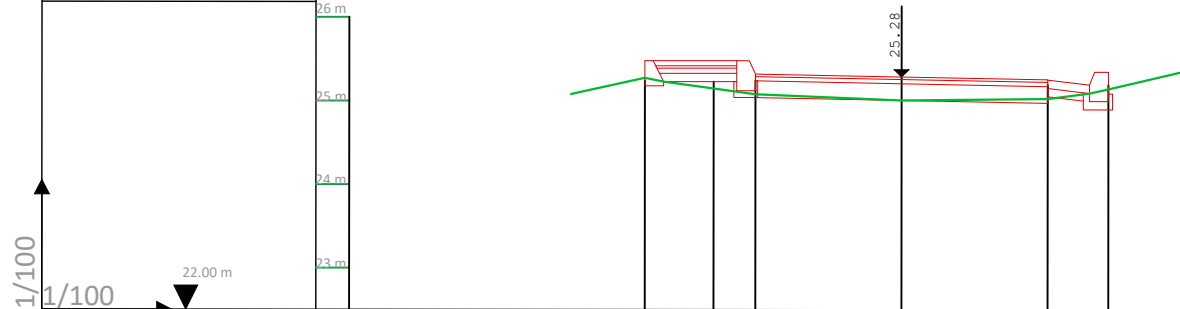

| | | | | | | |
|---------------------|-------|-------|-------|-------|-------|-------|
| KUOTA E TOKES | 25.27 | 25.14 | 25.08 | 25.00 | 25.02 | 25.07 |
| D.PJESORE TOKES | 0.80 | 0.50 | 1.75 | 1.75 | 0.70 | |
| KUOTA PROJEKTIT | 25.47 | 25.47 | 25.31 | 25.28 | 25.25 | 25.34 |
| D.PJESORE PROJEKTIT | 0.80 | 0.50 | 1.75 | 1.75 | 0.70 | |

PROFILAT TERTHORE
 Profili Nr.5
 Progresivi 207.0 m
 K.Tokes 26.00 m
 K.Projektit 26.28m
 Germim= 0.22 m3/m
 Mbushje= 1.37 m3/m

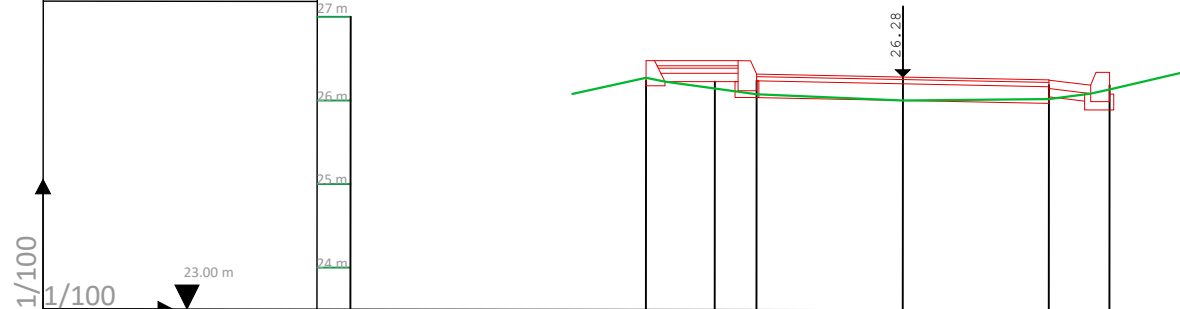

| | | | | | | |
|---------------------|-------|-------|-------|-------|-------|-------|
| KUOTA E TOKES | 26.27 | 26.14 | 26.08 | 26.00 | 26.02 | 26.07 |
| D.PJESORE TOKES | 0.80 | 0.50 | 1.75 | 1.75 | 0.70 | |
| KUOTA PROJEKTIT | 26.47 | 26.47 | 26.31 | 26.28 | 26.25 | 26.34 |
| D.PJESORE PROJEKTIT | 0.80 | 0.50 | 1.75 | 1.75 | 0.70 | |

PROFILAT TERTHORE
 Profili Nr.6
 Progresivi 236.0 m
 K.Tokes 26.70 m
 K.Projektit 26.98m
 Germim= 0.20 m3/m
 Mbushje= 1.40 m3/m

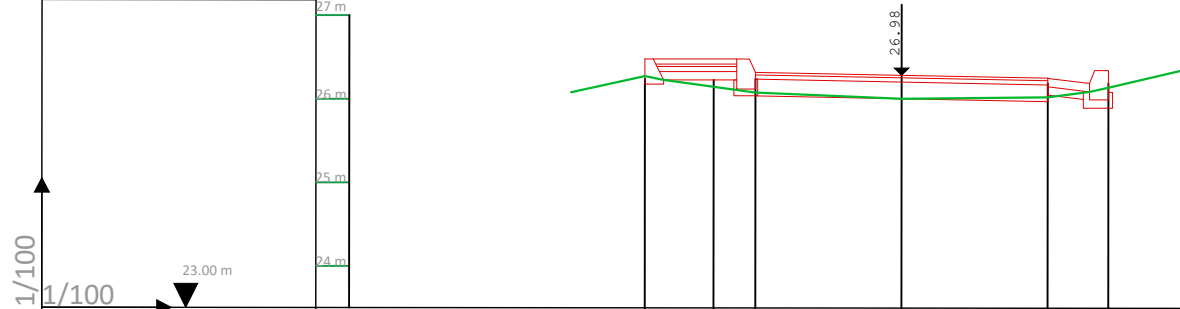

| | | | | | | |
|---------------------|-------|-------|-------|-------|-------|-------|
| KUOTA E TOKES | 26.80 | 26.80 | 26.76 | 26.70 | 26.73 | 26.75 |
| D.PJESORE TOKES | 0.80 | 0.50 | 1.75 | 1.75 | 0.70 | |
| KUOTA PROJEKTIT | 27.08 | 27.08 | 27.02 | 26.98 | 26.96 | 26.94 |
| D.PJESORE PROJEKTIT | 0.80 | 0.50 | 1.75 | 1.75 | 0.70 | |

PROFILAT TERTHORE
 Profili Nr.7
 Progresivi 256.0 m
 K.Tokes 27.00 m
 K.Projektit 27.28m
 Germim= 0.197 m3/m
 Mbushje= 1.413 m3/m

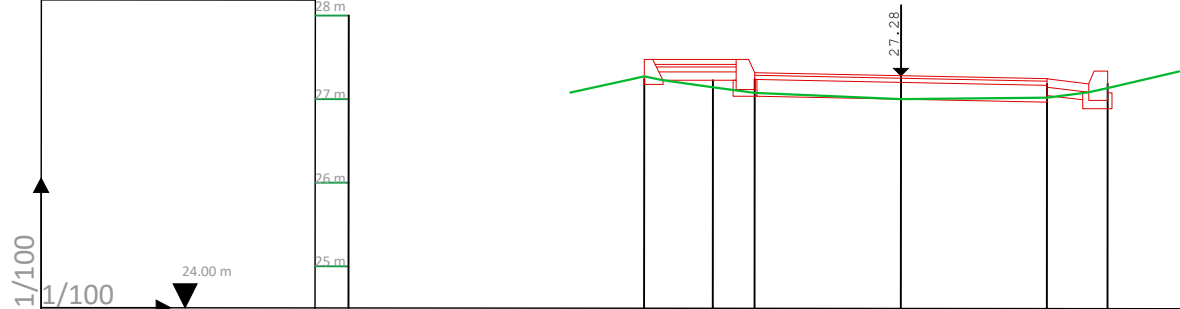

| | | | | | | |
|---------------------|-------|-------|-------|-------|-------|-------|
| KUOTA E TOKES | 27.27 | 27.14 | 27.08 | 27.00 | 27.02 | 27.07 |
| D.PJESORE TOKES | 0.80 | 0.50 | 1.75 | 1.75 | 0.70 | |
| KUOTA PROJEKTIT | 27.47 | 27.47 | 27.31 | 27.28 | 27.25 | 27.34 |
| D.PJESORE PROJEKTIT | 0.80 | 0.50 | 1.75 | 1.75 | 0.70 | |



Parosites
Bashkia Roskovec
 Miratoi
 Kryetar: **Majlinda Bufi**

Projekt :
SISTEMIM-ASFALTIMI I RRUGES NR.3,
FSHATI VELMISH DHE RIKONSTRUKSIONI I
CEZMES PUBLIKE, FAZA-1

Grupi i Projektimit :
 Ing. Erion HOXHA
 Ing. Eldison KOCAQI
 Ing. Arben DUKAJ

Drejtor i P.Z.H.T :
Rakip HAZIJAJ

Titull flete :
PROFILE TERTHORE TE RRUGES

Date
 25.10.2018
 Shkalla
 1:100

Flete A3 Nr.
07

PROFILAT TERTHORE
 Profili Nr.8
 Progresivi 278.0 m
 K.Tokes 28.40 m
 K.Projektit 28.68m
 Germim= 0.20 m3/m
 Mbushje= 1.40 m3/m

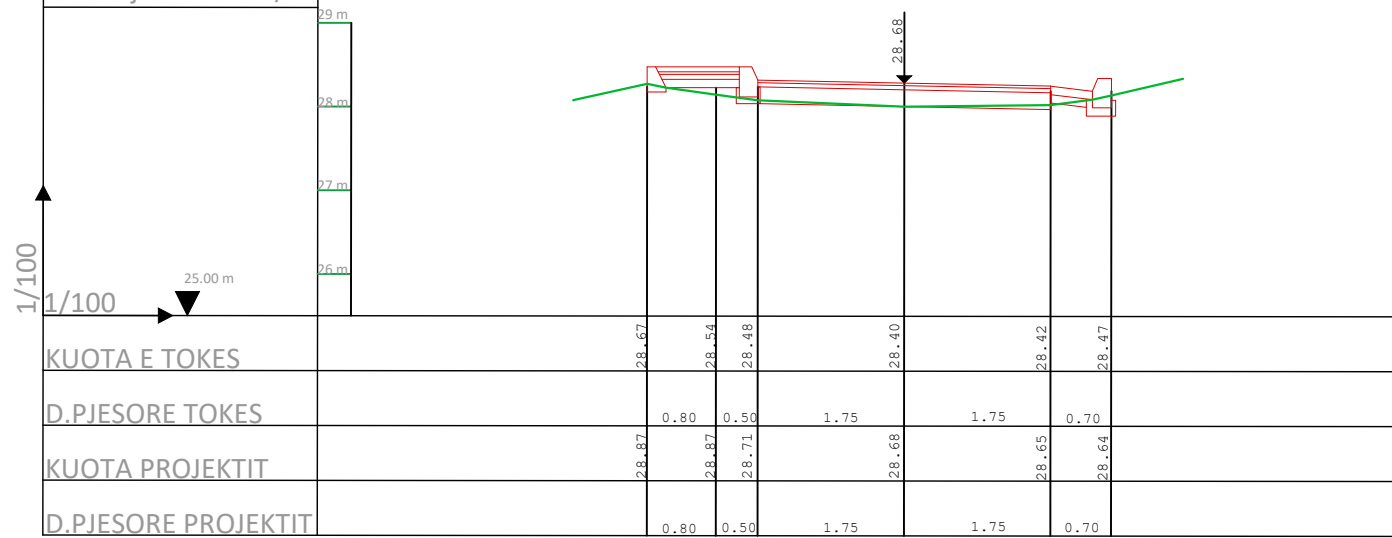

PROFILAT TERTHORE
 Profili Nr.9
 Progresivi 328.0 m
 K.Tokes 32.70 m
 K.Projektit 32.98m
 Germim= 0.222 m3/m
 Mbushje= 1.405 m3/m

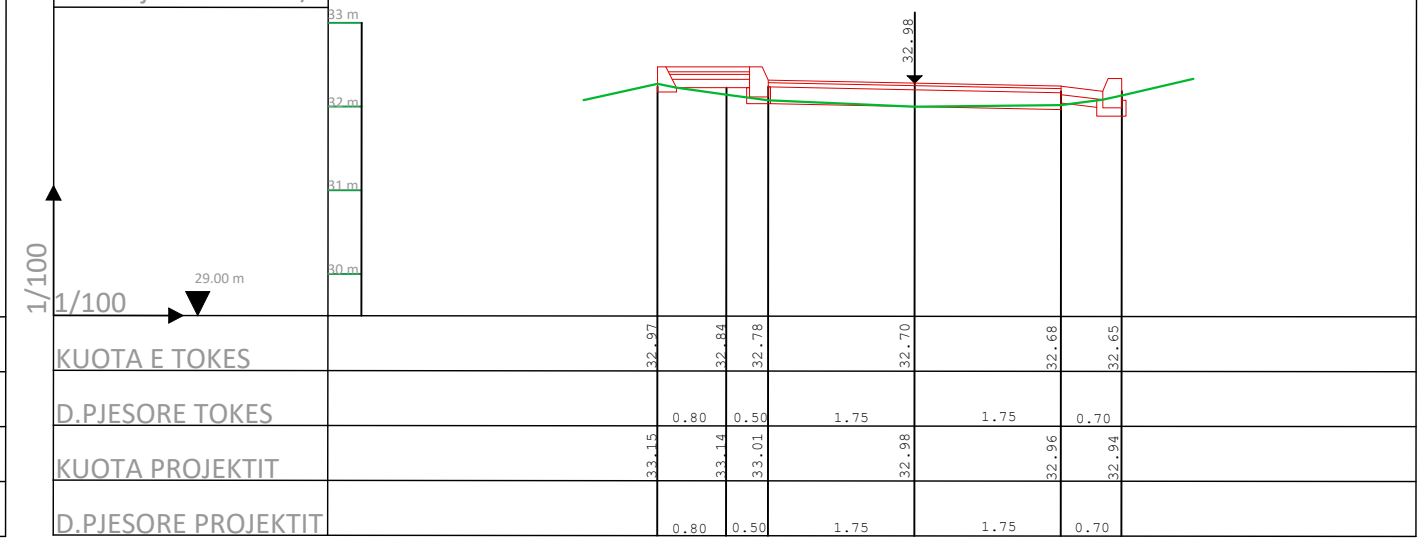

PROFILAT TERTHORE
 Profili Nr.10
 Progresivi 354.0 m
 K.Tokes 35.50 m
 K.Projektit 35.78m
 Germim= 0.21 m3/m
 Mbushje= 1.38 m3/m

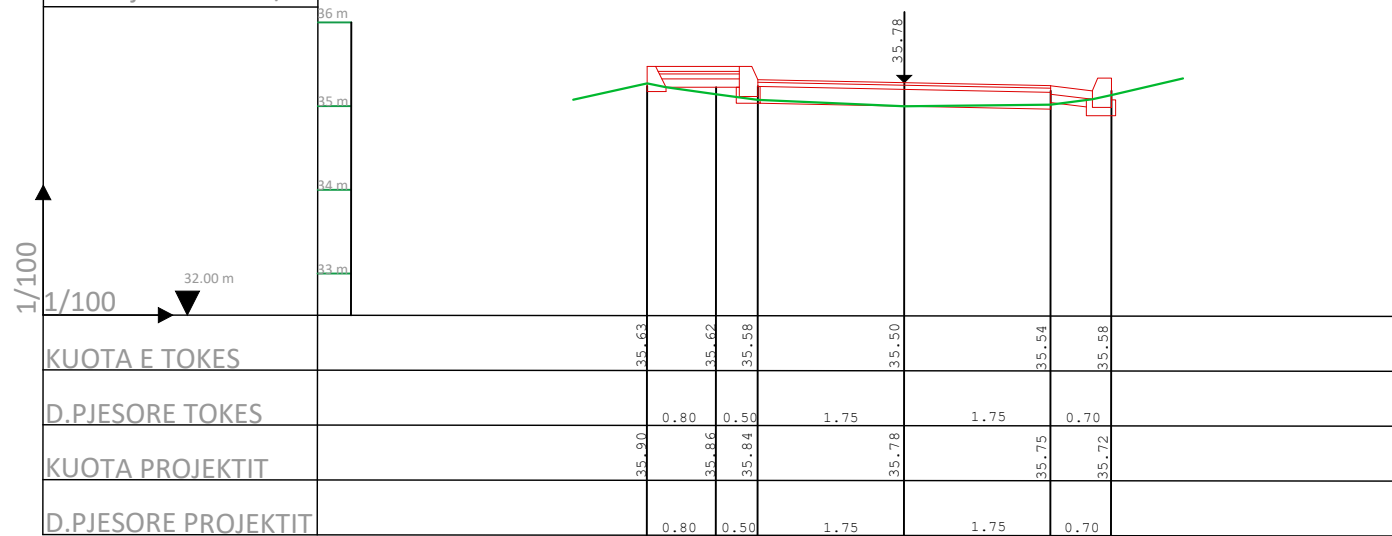

PROFILAT TERTHORE
 Profili Nr.11
 Progresivi 379.0 m
 K.Tokes 37.00 m
 K.Projektit 37.28m
 Germim= 0.198 m3/m
 Mbushje= 1.432 m3/m

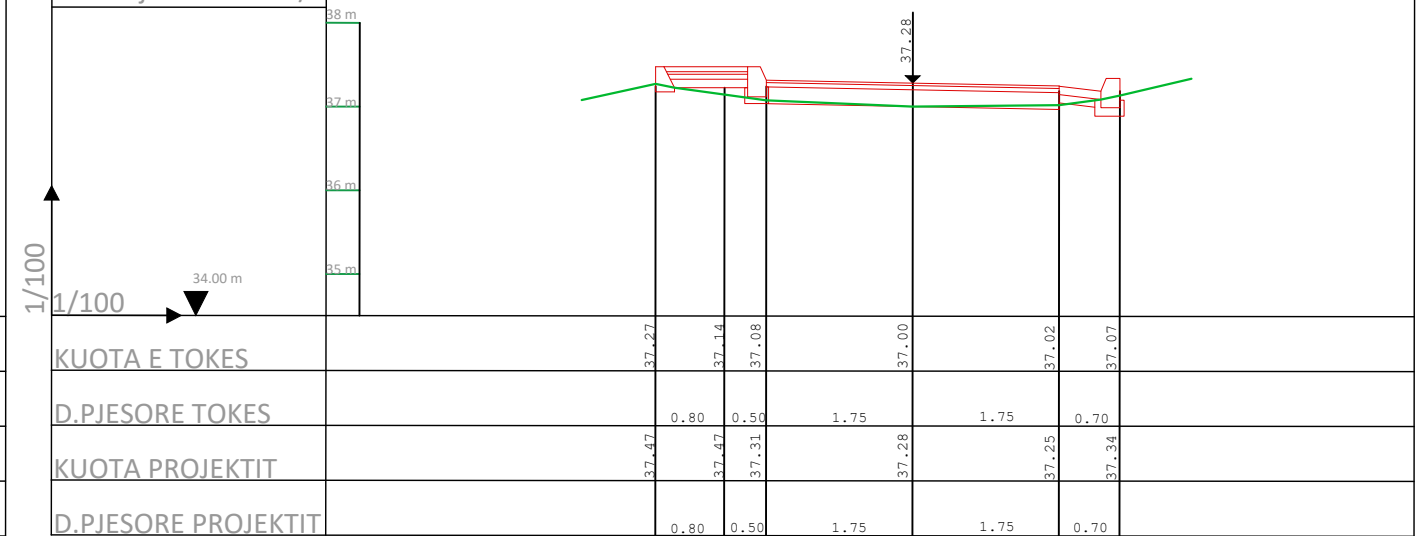

Porosites
Bashkia Roskovec
 Miratoi
 Kryetar: **Majlinda Bufi**

Projekt :
**SISTEMIM-ASFALTIMI I RRUGES NR.3,
 FSHATI VELMISH DHE RIKONSTRUKSIONI I
 CEZMES PUBLIKE, FAZA-1**

Grupi i Projektimit :
 Ing. Erion HOXHA
 Ing. Eldison KOCAQI
 Ing. Arben DUKAJ

Drejtor i P.Z.H.T :
Rakip HAZIJAJ

Titull flete :
PROFILE TERTHORE TE RRUGES

Date
 25.10.2018
 Shkalla
 1:100

Flete A3 Nr.
08

PROFILAT TERTHORE
 Profili Nr.12
 Progresivi 389.0 m
 K.Tokes 37.00 m
 K.Projektit 37.28m
 Germim= 0.198 m3/m
 Mbushje= 1.432 m3/m

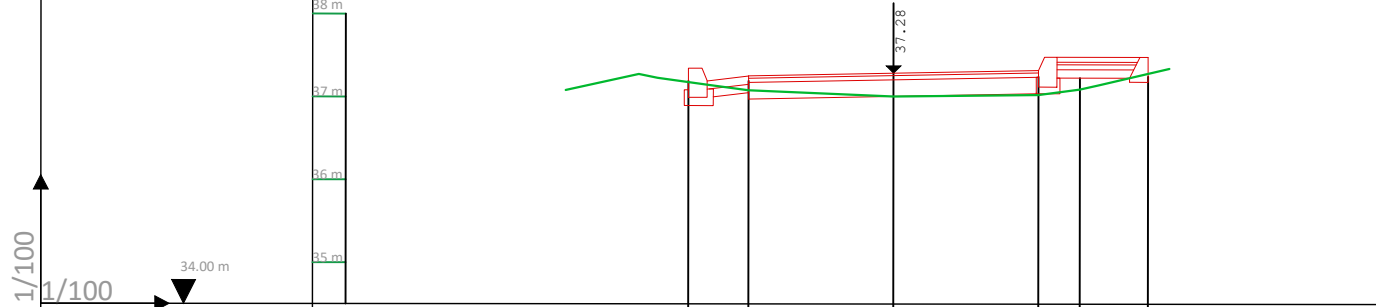

| | | | | | | | |
|---------------------|--|-------|-------|-------|-------|-------|-------|
| KUOTA E TOKES | | 37.07 | 37.02 | 37.00 | 37.08 | 37.14 | 37.27 |
| D.PJESORE TOKES | | 0.70 | 1.75 | 1.75 | 0.50 | 0.80 | |
| KUOTA PROJEKTIT | | 37.34 | 37.25 | 37.28 | 37.31 | 37.47 | 37.47 |
| D.PJESORE PROJEKTIT | | 0.70 | 1.75 | 1.75 | 0.50 | 0.80 | |

PROFILAT TERTHORE
 Profili Nr.13
 Progresivi 413.0 m
 K.Tokes 36.50 m
 K.Projektit 36.78m
 Germim= 0.198 m3/m
 Mbushje= 1.432 m3/m

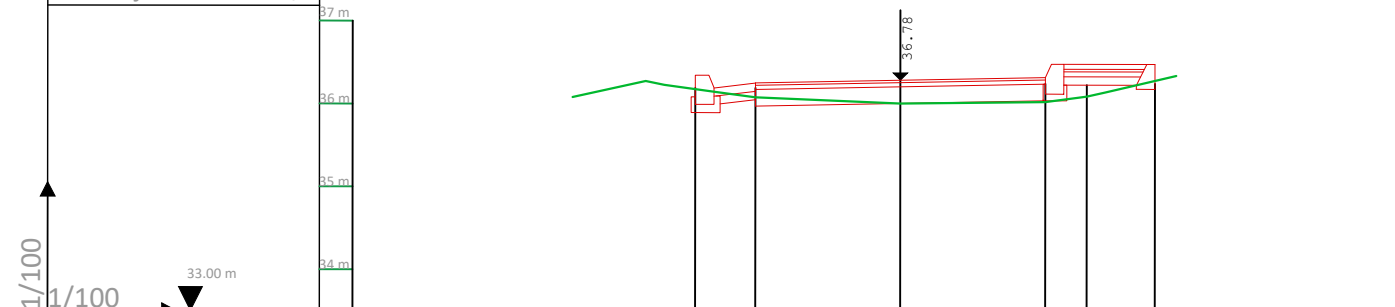

| | | | | | | | |
|---------------------|--|-------|-------|-------|-------|-------|-------|
| KUOTA E TOKES | | 36.57 | 36.52 | 36.50 | 36.58 | 36.64 | 36.70 |
| D.PJESORE TOKES | | 0.70 | 1.75 | 1.75 | 0.50 | 0.80 | |
| KUOTA PROJEKTIT | | 36.74 | 36.75 | 36.78 | 36.81 | 36.87 | 36.87 |
| D.PJESORE PROJEKTIT | | 0.70 | 1.75 | 1.75 | 0.50 | 0.80 | |

PROFILAT TERTHORE
 Profili Nr.14
 Progresivi 423.0 m
 K.Tokes 36.40 m
 K.Projektit 36.68m
 Germim= 0.198 m3/m
 Mbushje= 1.432 m3/m

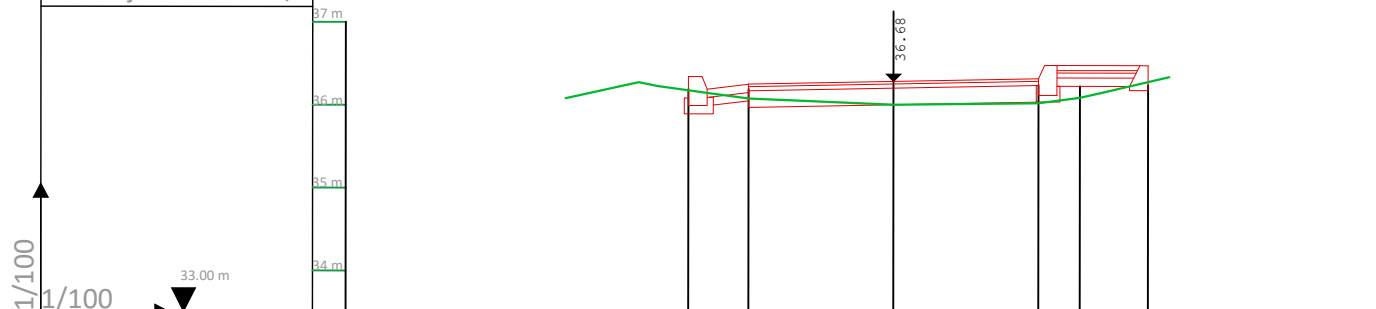

| | | | | | | | |
|---------------------|--|-------|-------|-------|-------|-------|-------|
| KUOTA E TOKES | | 36.47 | 36.42 | 36.40 | 36.48 | 36.54 | 36.65 |
| D.PJESORE TOKES | | 0.70 | 1.75 | 1.75 | 0.50 | 0.80 | |
| KUOTA PROJEKTIT | | 36.63 | 36.65 | 36.68 | 36.71 | 36.84 | 36.84 |
| D.PJESORE PROJEKTIT | | 0.70 | 1.75 | 1.75 | 0.50 | 0.80 | |

PROFILAT TERTHORE
 Profili Nr.15
 Progresivi 455.0 m
 K.Tokes 35.20 m
 K.Projektit 335.48m
 Germim= 0.198 m3/m
 Mbushje= 1.432 m3/m

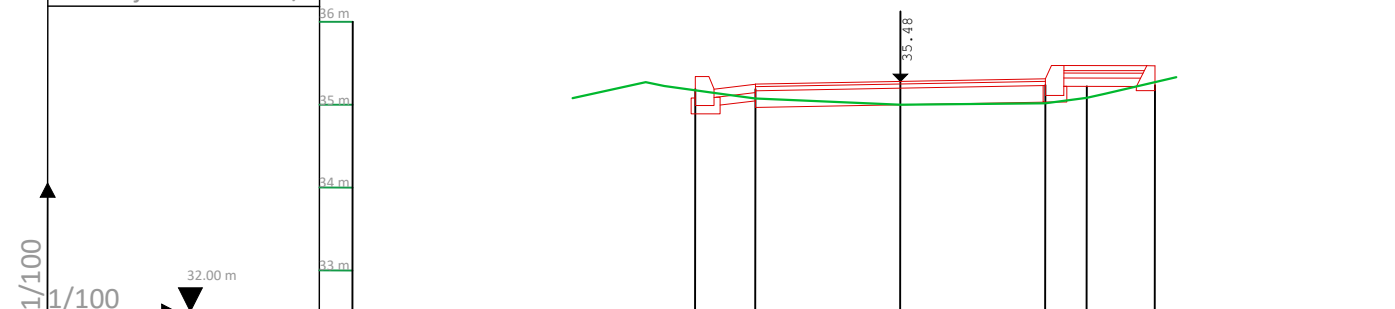

| | | | | | | | |
|---------------------|--|-------|-------|-------|-------|-------|-------|
| KUOTA E TOKES | | 35.27 | 35.22 | 35.20 | 35.27 | 35.34 | 35.37 |
| D.PJESORE TOKES | | 0.70 | 1.75 | 1.75 | 0.50 | 0.80 | |
| KUOTA PROJEKTIT | | 35.43 | 35.45 | 35.48 | 35.51 | 35.60 | 35.60 |
| D.PJESORE PROJEKTIT | | 0.70 | 1.75 | 1.75 | 0.50 | 0.80 | |



Porosites
Bashkia Roskovec
 Miratoi
 Kryetar: **Majlinda Bufi**

Projekt :
SISTEMIM-ASFALTIMI I RRUGES NR.3,
FSHATI VELMISH DHE RIKONSTRUKSIONI I
CEZMES PUBLIKE, FAZA-1

Grupi i Projektimit :
 Ing. Erion HOXHA
 Ing. Eldison KOCAQI
 Ing. Arben DUKAJ

Drejtor i P.Z.H.T :
Rakip HAZIJAJ

Titull flete :
PROFILE TIP TE RRUGES

Date
 25.10.2018
 Shkalla
 1:40

Flete A3 Nr.
09

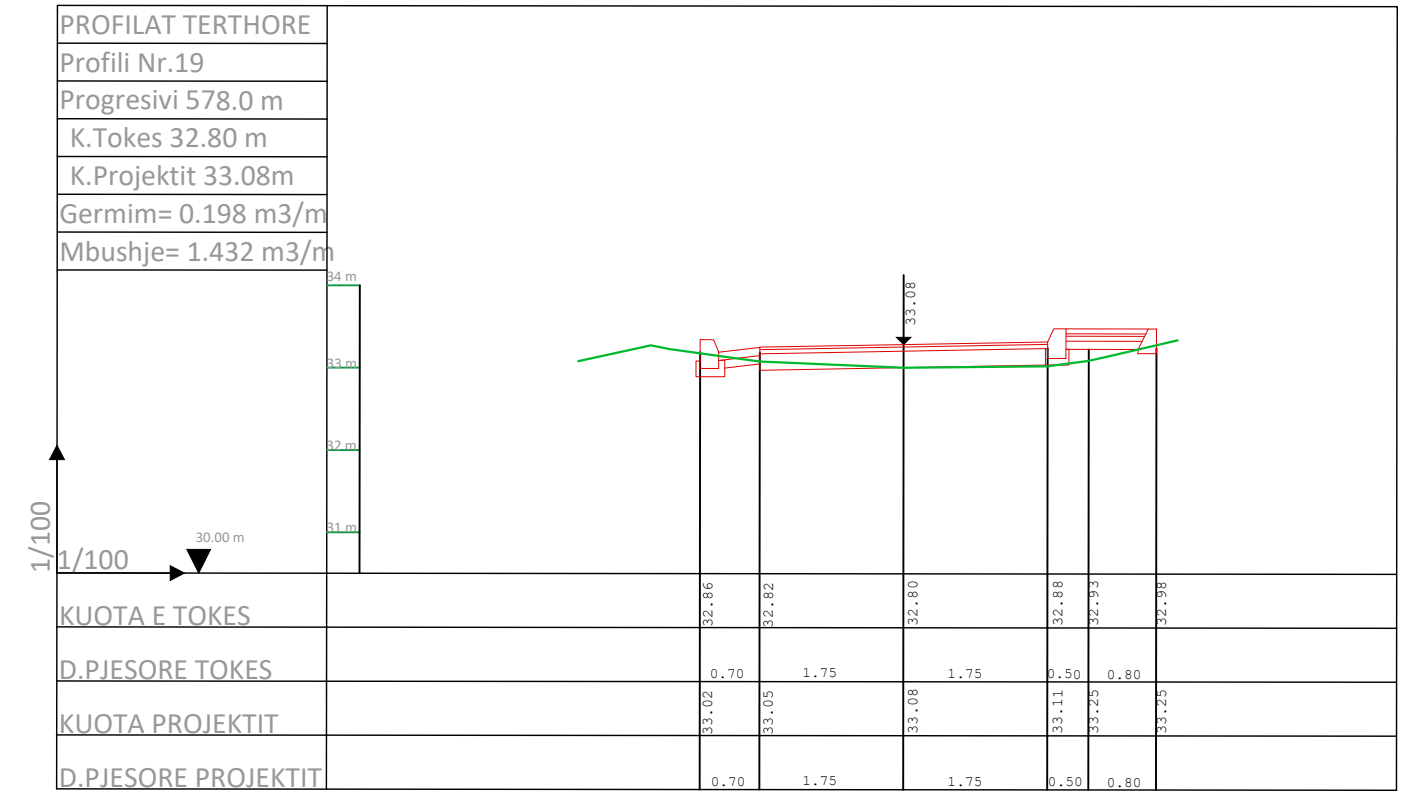
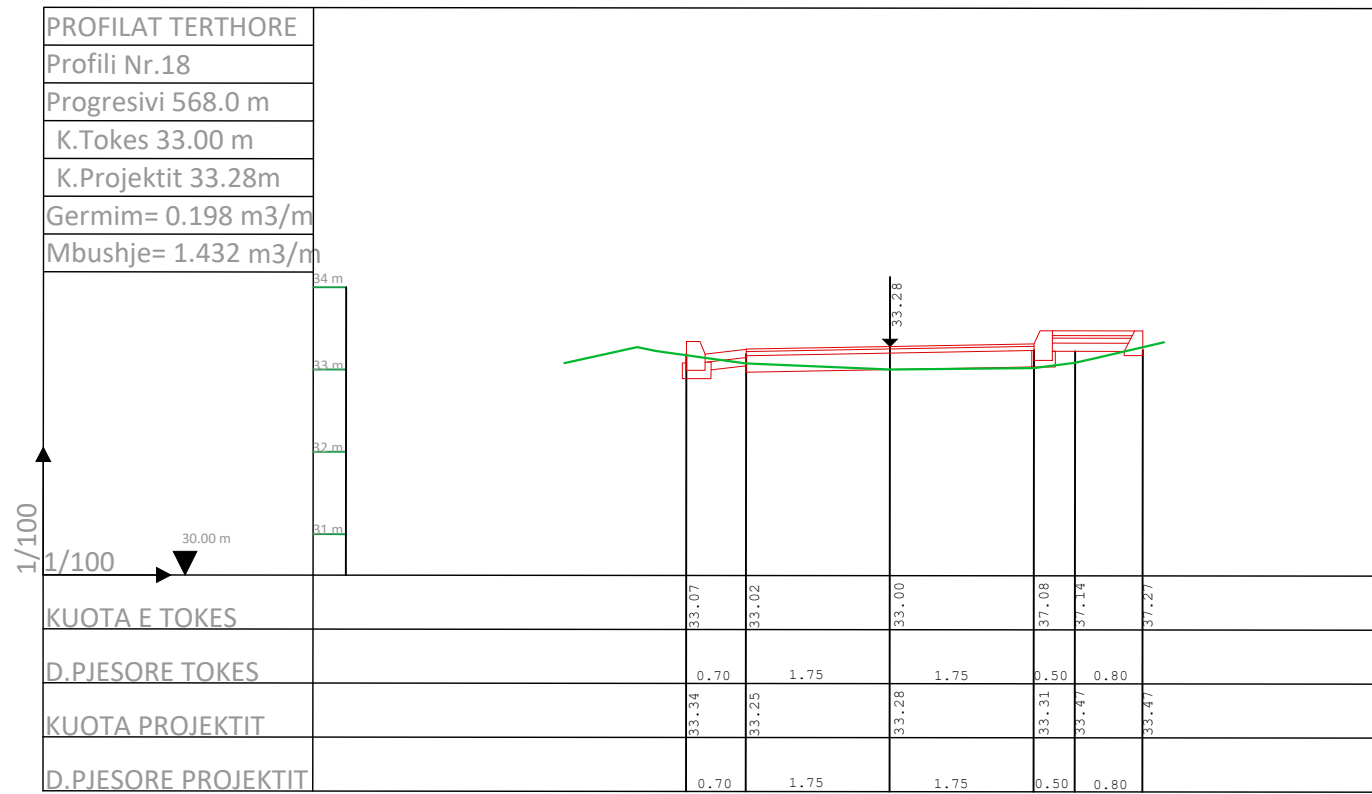
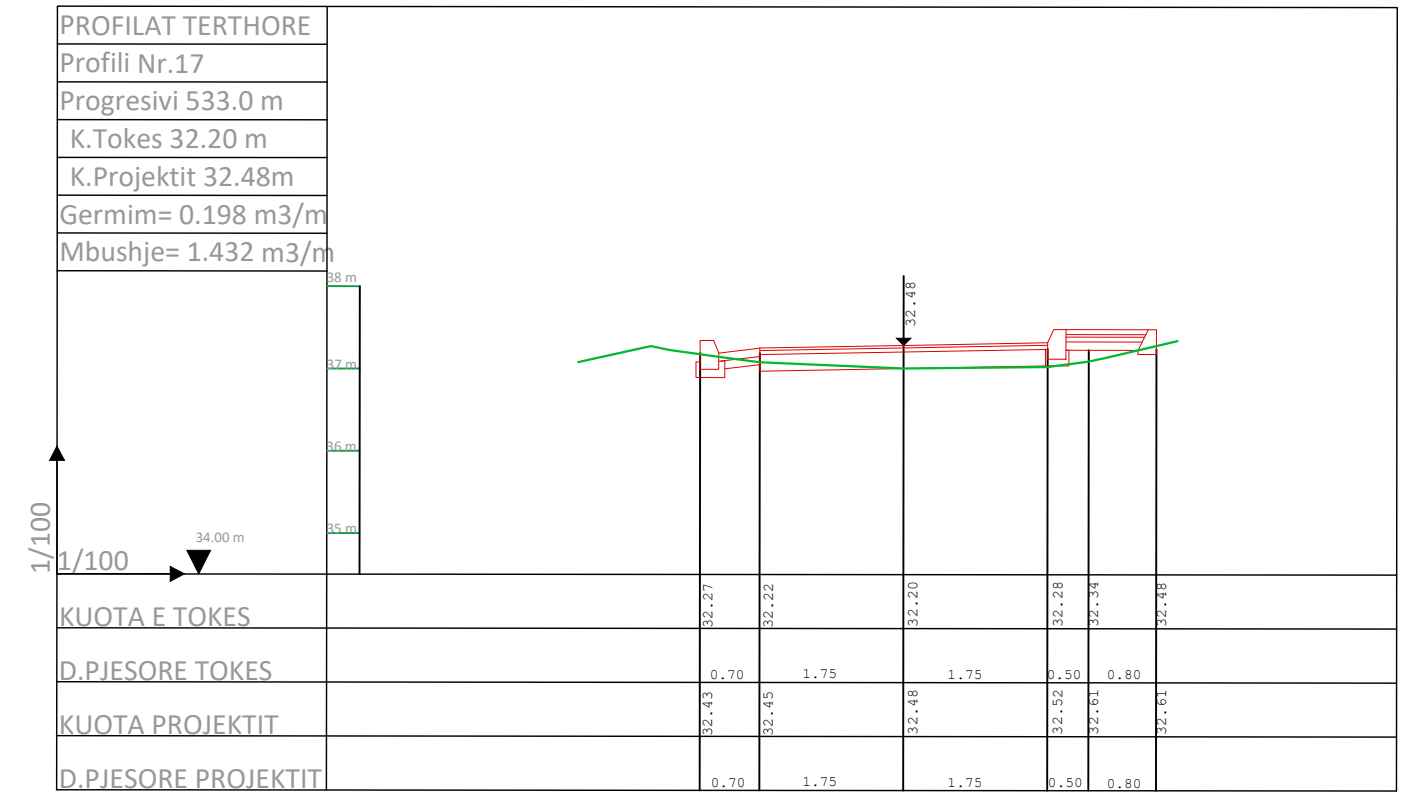
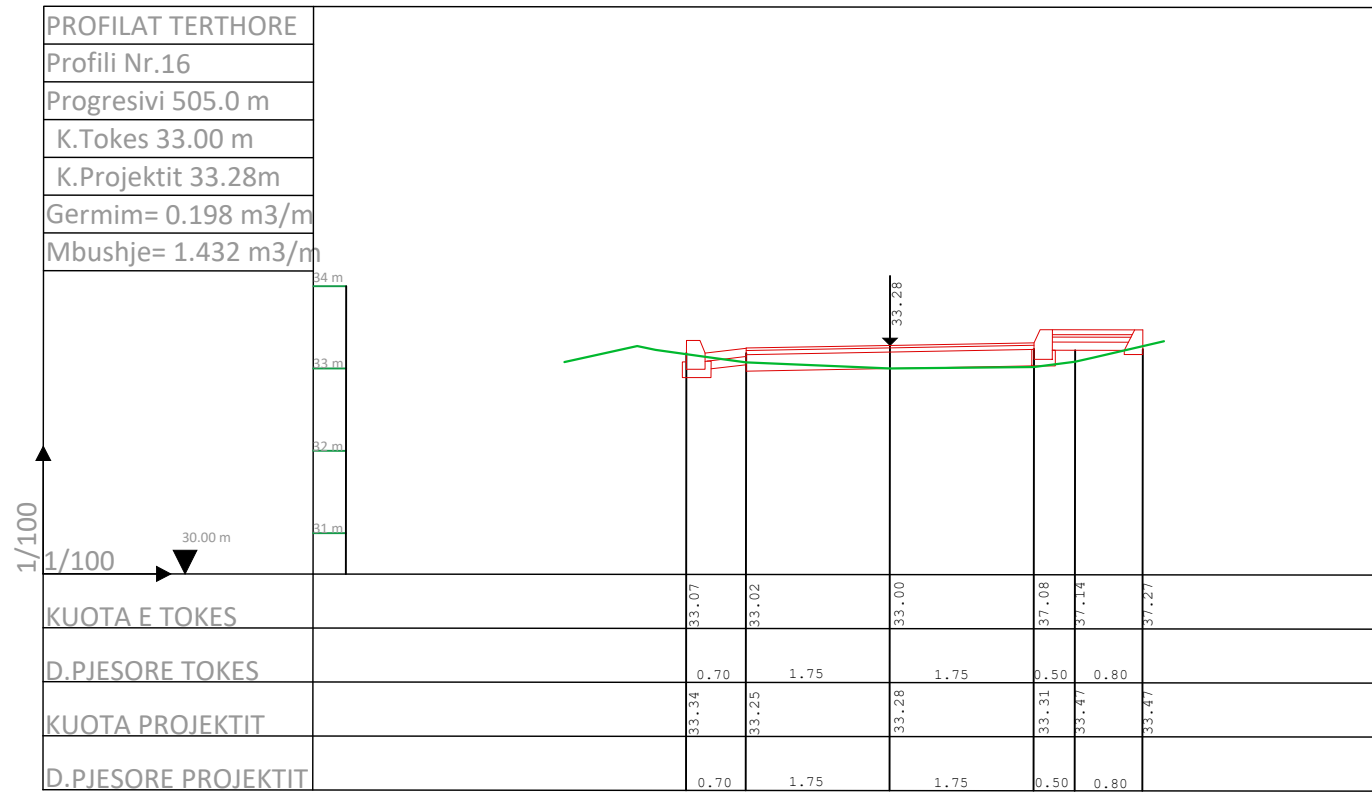

Porosites
Bashkia Roskovec
Miratoi
Kryetar: **Majlinda Bufi**

Projekt :
**SISTEMIM-ASFALTIMI I RRUGES NR.3,
FSHATI VELMISH DHE RIKONSTRUKSIONI I
CEZMES PUBLIKE, FAZA-1**

Grupi i Projektimit :
Ing. Erion HOXHA
Ing. Eldison KOCAQI
Ing. Arben DUKAJ

Drejtor i P.Z.H.T :
Rakip HAZIJAJ

Titull flete :
PROFILE TERTHORE TE RRUGES

Date
25.10.2018
Shkalla
1:40

Flete A3 Nr.
10

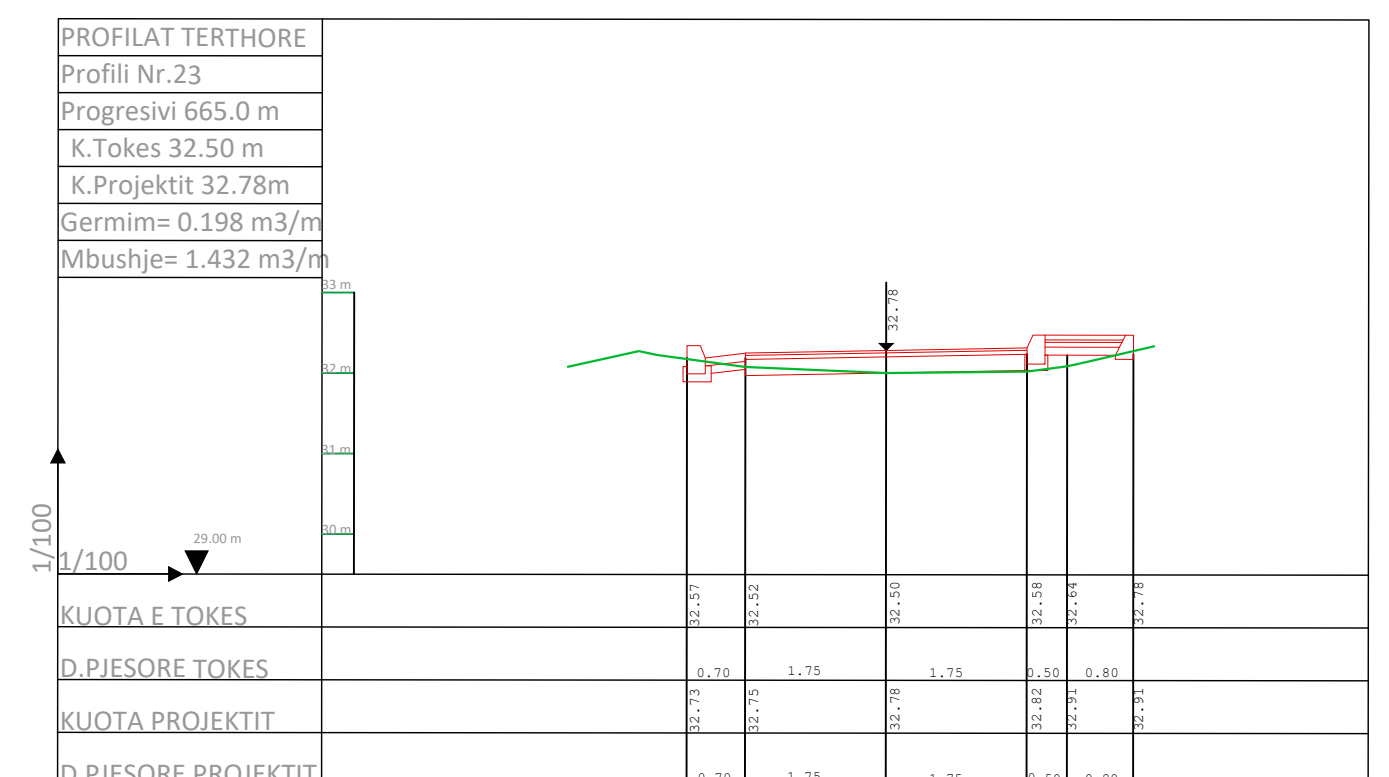
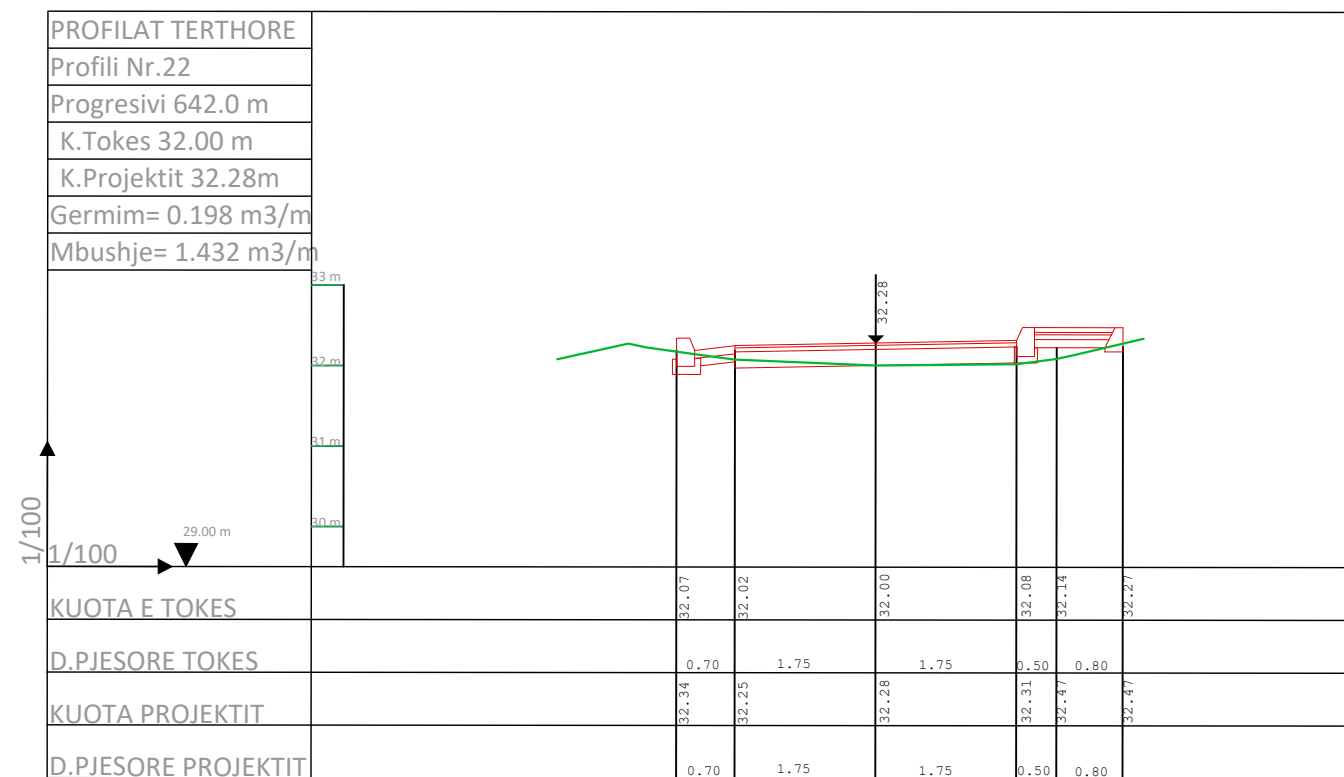
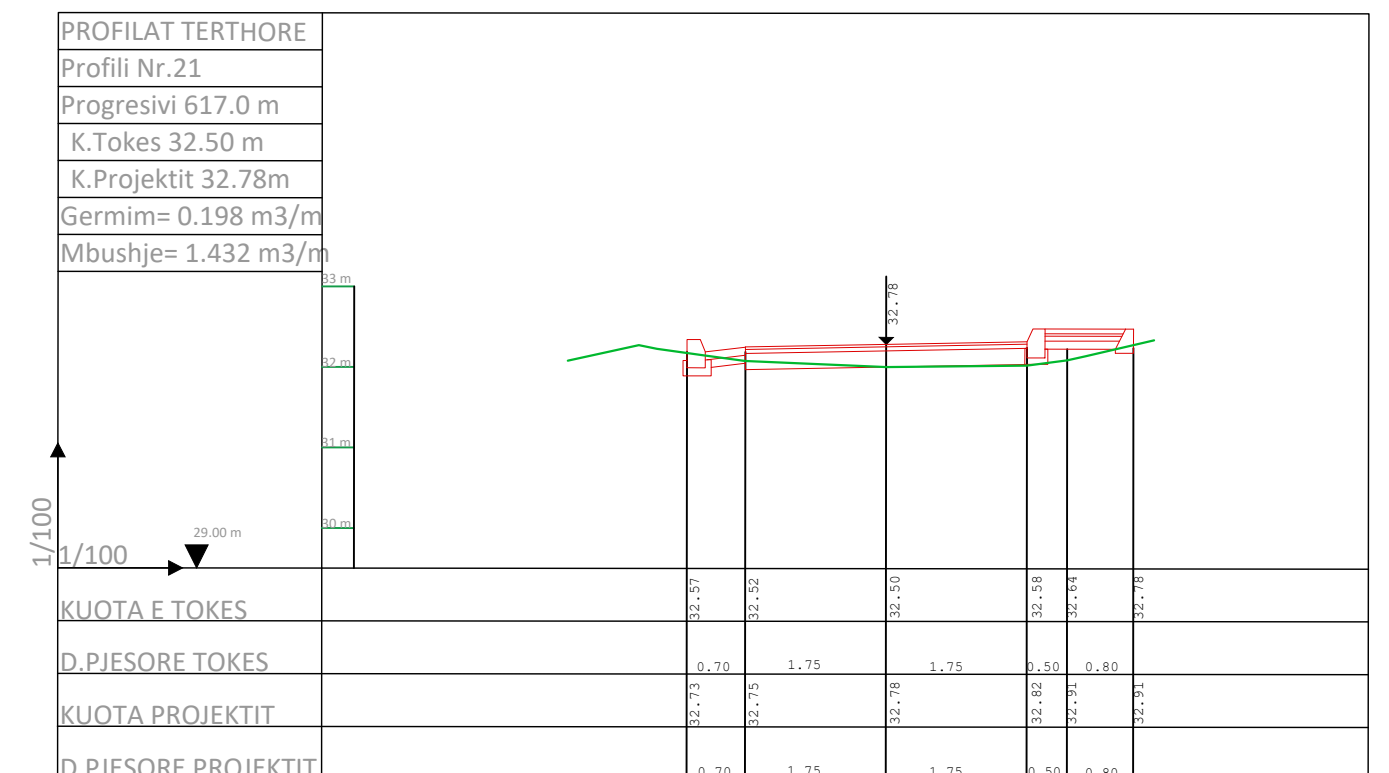
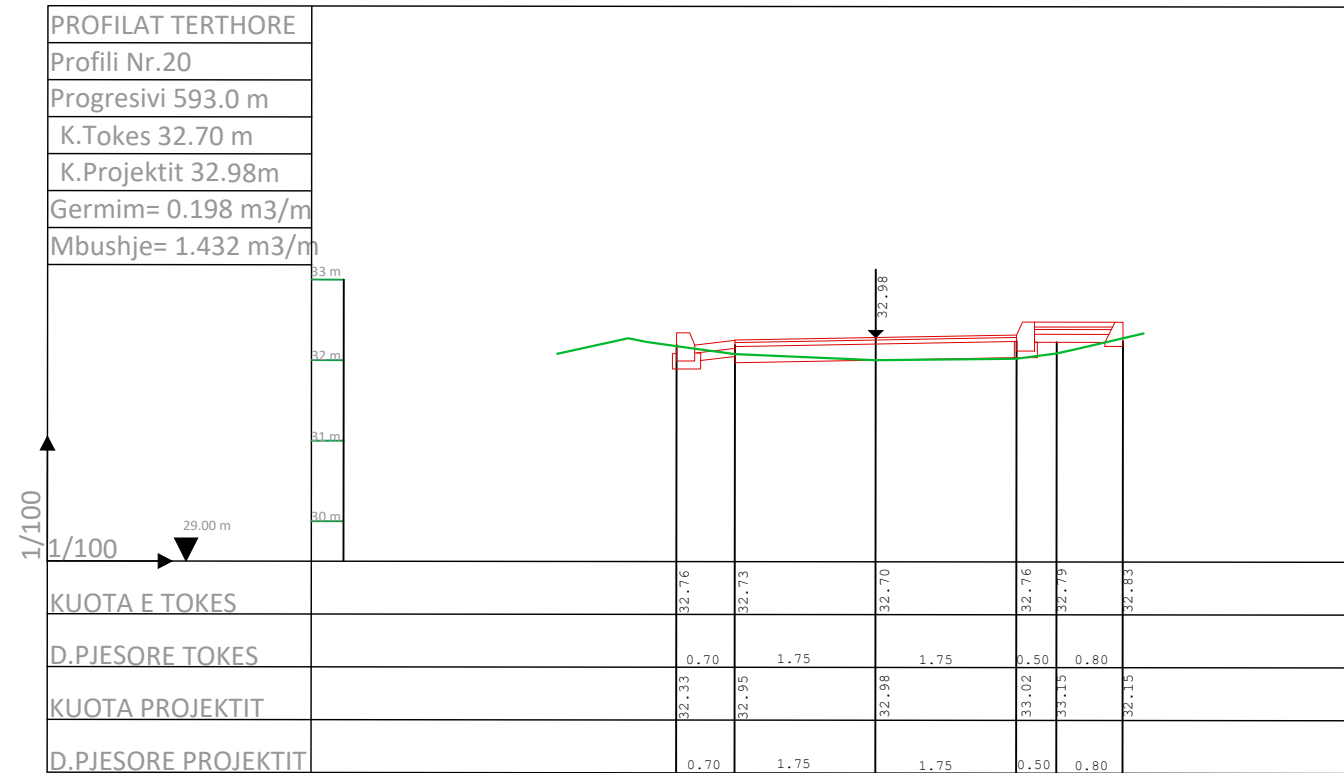

Porosites
Bashkia Roskovec
Miratoi
Kryetar: **Majlinda Bufi**

Projekt :
**SISTEMIM-ASFALTIM I RRUGES NR.3,
FSHATI VELMISH DHE RIKONSTRUKSIONI I
CEZMES PUBLIKE, FAZA-1**

Grupi i Projektimit :
Ing. Erion HOXHA
Ing. Eldison KOCAQI
Ing. Arben DUKAJ

Drejtor i P.Z.H.T :
Rakip HAZIJAJ

Titull flete :
PROFILE TERTHORE TE RRUGES

| | |
|---------|------------|
| Date | 25.10.2018 |
| Shkalla | 1:30 |

Flete A3 Nr.
11

PROFILAT TERTHORE
 Profili Nr.24
 Progresivi 690.0 m
 K.Tokes 32.20 m
 K.Projektit 32.48m
 Germim= 0.198 m3/m
 Mbushje= 1.432 m3/m

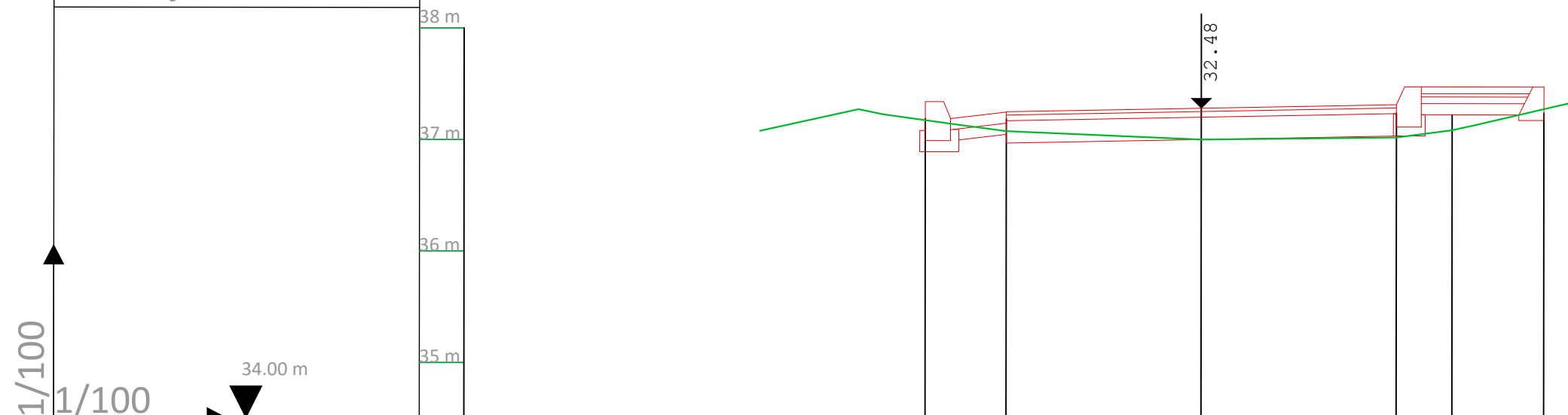

| | | | | | | |
|---------------------|-------|-------|-------|-------|-------|-------|
| KUOTA E TOKES | 32.27 | 32.22 | 32.20 | 32.28 | 32.34 | 32.48 |
| D.PJESORE TOKES | 0.70 | 1.75 | 1.75 | 0.50 | 0.80 | |
| KUOTA PROJEKTIT | 32.43 | 32.45 | 32.48 | 32.52 | 32.61 | 32.61 |
| D.PJESORE PROJEKTIT | 0.70 | 1.75 | 1.75 | 0.50 | 0.80 | |



Parosites
Bashkia Roskovec
 Miratoi
 Kryetar: **Majlinda Bufi**

Projekt :
SISTEMIM-ASFALTIMI I RRUGES NR.3,
FSHATI VELMISH DHE RIKONSTRUKSIONI I
CEZMES PUBLIKE, FAZA-1

Grupi i Projektimit :
 Ing. Erion HOXHA
 Ing. Eldison KOCAQI
 Ing. Arben DUKAJ

Drejtor i P.Z.H.T :
Rakip HAZIJAJ

Titull flete :
PLANI I RILEVIMIT I RRUGES

| | |
|---------|------------|
| Date | 25.10.2018 |
| Shkalla | 1:500 |

Flete A3 Nr.
12

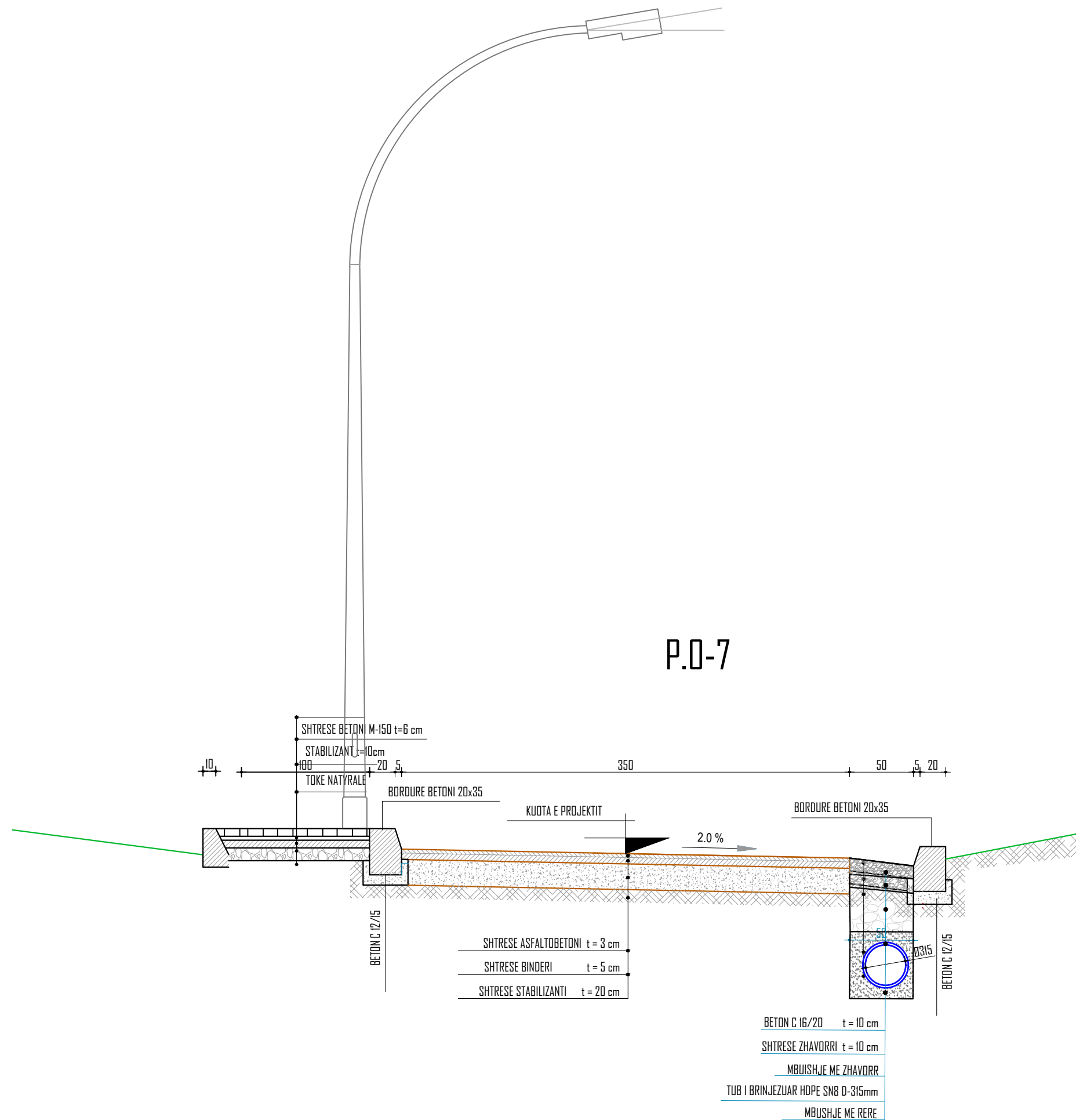

Porosites
Bashkia Roskovec
 Miratoi
 Kryetar: **Majlinda Bufi**

Projekt :
SISTEMIM-ASFALTIMI I RRUGES NR.3,
FSHATI VELMISH DHE RIKONSTRUKSIONI I
CEZMES PUBLIKE, FAZA-1

Grupi i Projektimit :
 Ing. Erion HOXHA
 Ing. Eldison KOCAQI
 Ing. Arben DUKAJ

Drejtor i P.Z.H.T :
Rakip HAZIJAJ

Titull flete :
PROFILE TIP TE RRUGES

| | |
|---------|------------|
| Date | 25.10.2018 |
| Shkalla | 1:40 |

Flete A3 Nr.
13

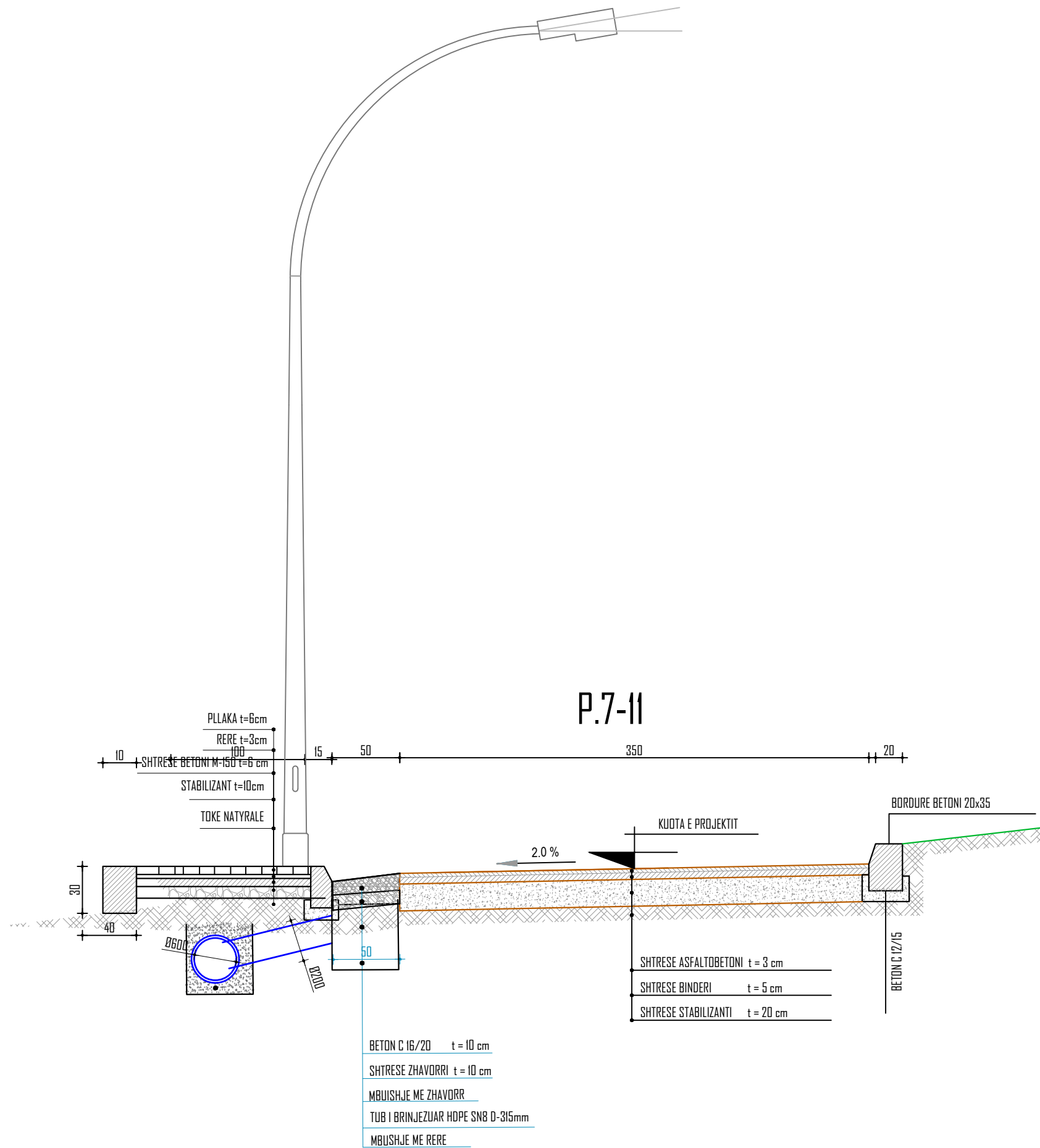

Porosites
Bashkia Roskovec
 Miratoi
 Kryetar: **Majlinda Bufi**

Projekt :
**SISTEMIM-ASFALTIMI I RRUGES NR.3,
 FSHATI VELMISH DHE RIKONSTRUKSIONI I
 CEZMES PUBLIKE, FAZA-1**

Grupi i Projektimit :
 Ing. Erion HOXHA
 Ing. Eldison KOCAQI
 Ing. Arben DUKAJ

Drejtor i P.Z.H.T :
Rakip HAZIJAJ

Titull flete :
PROFILE TIP TE RRUGES

| | |
|---------|------------|
| Date | 25.10.2018 |
| Shkalla | 1:40 |

Flete A3 Nr.
14

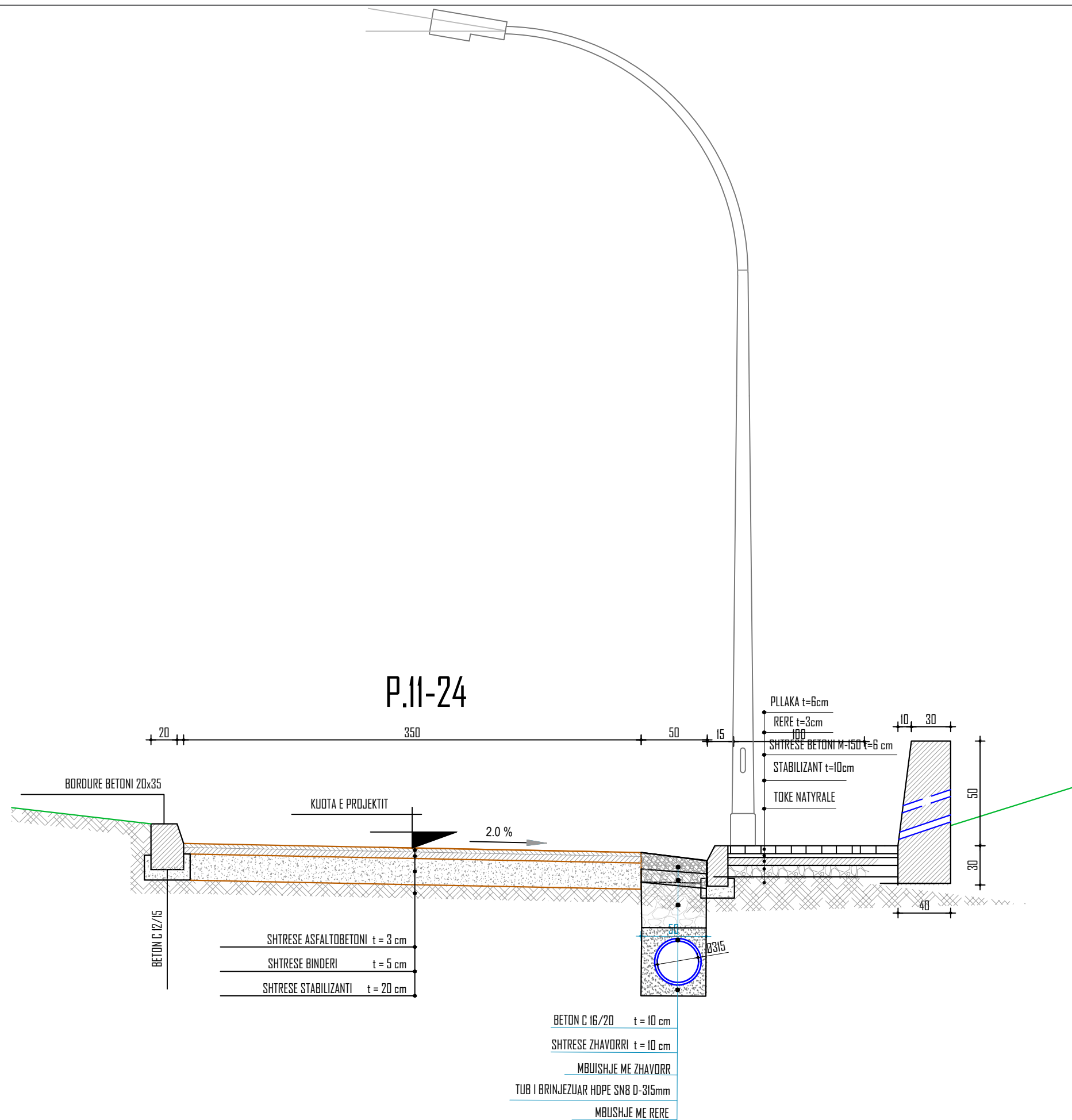

Porosites
Bashkia Roskovec
 Miratoi
 Kryetar: **Majlinda Bufi**

Projekt :
**SISTEMIM-ASFALTIMI I RRUGES NR.3,
 FSHATI VELMISH DHE RIKONSTRUKSIONI I
 CEZMES PUBLIKE, FAZA-1**

Grupi i Projektimit :
 Ing. Erion HOXHA
 Ing. Eldison KOCAQI
 Ing. Arben DUKAJ

Drejtor i P.ZH.T :
Rakip HAZIJAJ

Titull flete :
PROFILE TIP TE RRUGES

| | |
|---------|------------|
| Date | 25.10.2018 |
| Shkalla | 1:40 |

Flete A3 Nr.
15

DETAJ SHIMBLEDHESI

PAMJA NGA SIPER E SHIMBLEDHESIT 40x40

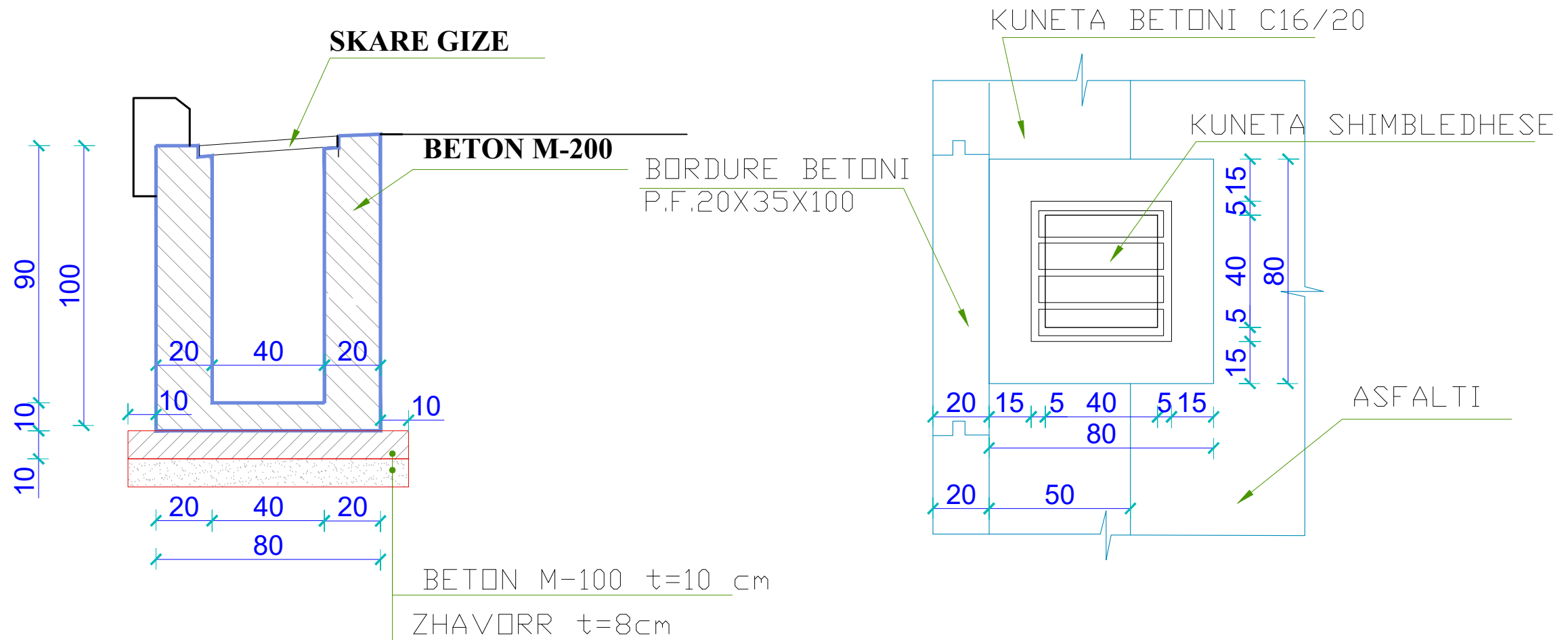

Parosites
Bashkia Roskovec
Miratoi
Kryetar: **Majlinda Bufi**

Projekt :
**SISTEMIM-ASFALTIMI I RRUGES NR.3,
FSHATI VELMISH DHE RIKONSTRUKSIONI I
CEZMES PUBLIKE, FAZA-1**

Grupi i Projektimit :
Ing. Erion HOXHA
Ing. Eldison KOCAQI
Ing. Arben DUKAJ

Drejtor i P.Z.H.T :
Rakip HAZIJAJ

Titull flete :
**PLANIMETRIA E KULLIMIT TE
UJERAVE TE SHIUT**

Date 25.10.2018
Shkalla 1:750

Flete A3 Nr.
16



Porosites
Bashkia Roskovec
 Miratoi
 Kryetar: **Majlinda Bufi**

Projekt :
**SISTEMIM-ASFALTIMI I RRUGES NR.3,
 FSHATI VELMISH DHE RIKONSTRUKSIONI I
 CEZMES PUBLIKE, FAZA-1**

Grupi i Projektimit :
 Ing. Erion HOXHA
 Ing. Eldison KOCAQI
 Ing. Arben DUKAJ

Drejtor i P.ZH.T :
Rakip HAZIJAJ

Titull flete :
**PLANIMETRIA E VENDOSJES SE
 NDRICIMIT RRUGOR**

| | |
|---------|------------|
| Date | 25.10.2018 |
| Shkalla | 1:750 |

Flete A3 Nr.
17

Detaji i montimit te shtylles

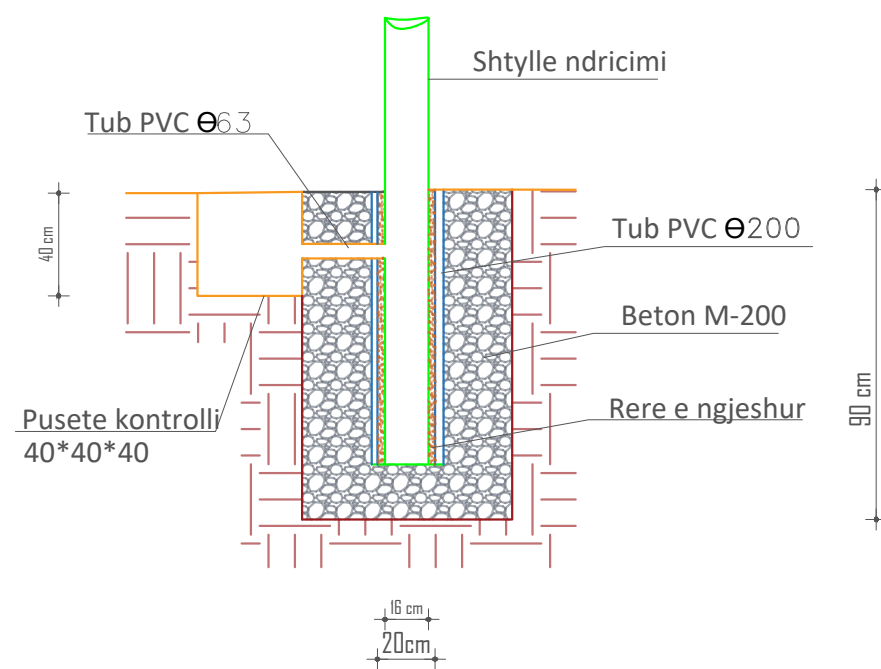

Detaji i kalimit te kablrit ne pusete

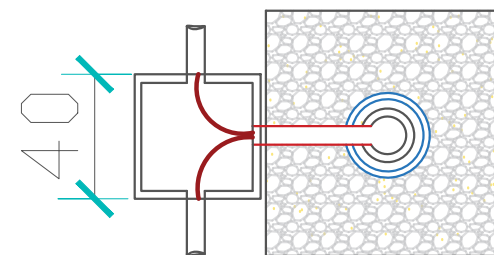

Detaji i montimit te Tokezimit te shtylles

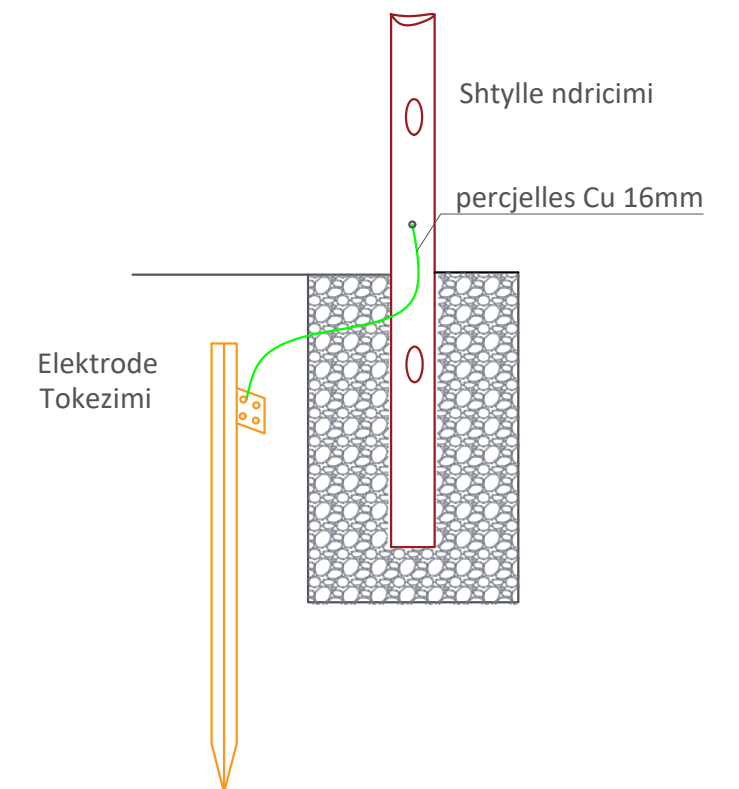

Porosites
Bashkia Roskovec
Miratoi
Kryetar: **Majlinda Bufi**

Projekt :
**SISTEMIM-ASFALTIMI I RRUGES NR.3,
FSHATI VELMISH DHE RIKONSTRUKSIONI I
CEZMES PUBLIKE, FAZA-1**

Grupi i Projektimit :
Ing. Erion HOXHA
Ing. Eldison KOCAQI
Ing. Arben DUKAJ

Drejtor i P.Z.H.T :
Rakip HAZIJAJ

Titull flete :
**DETAJE TE MONTIMIT TE
KABLOVE TE NDRICIMIT RRUGOR**

Date 25.10.2018

Shkalla

Flete A3 Nr.

18

Detaji i instalimit te kabllave dhe lidhja e ndricuesit

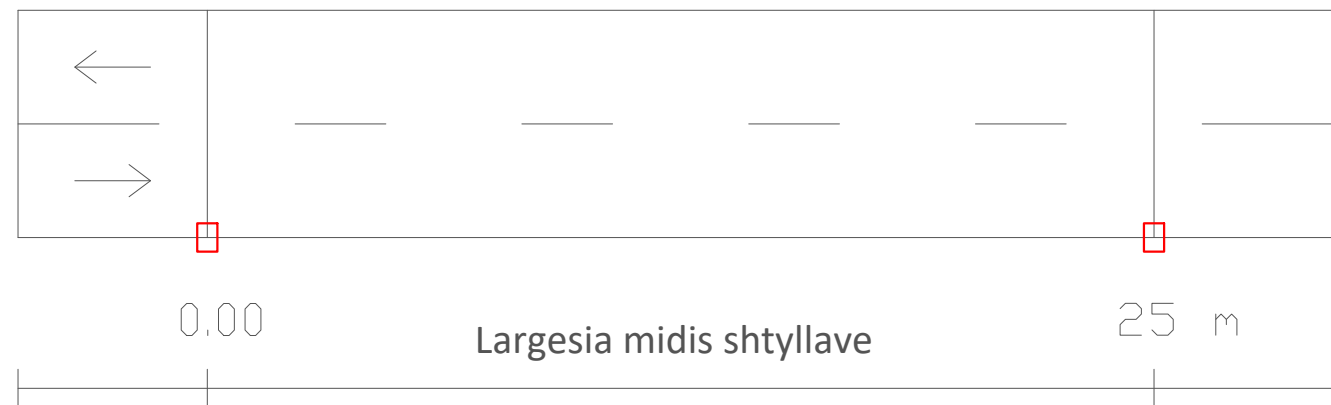

| Simboli | Emertimi i elementit |
|---------|---------------------------------|
| | Ndricuesi monotonal SAP-T 1SDW |
| | Automat 2P, 6A, 6kA |
| | Morseta e lidhjes se ndricuesit |
| | Takezimi i shtylles |

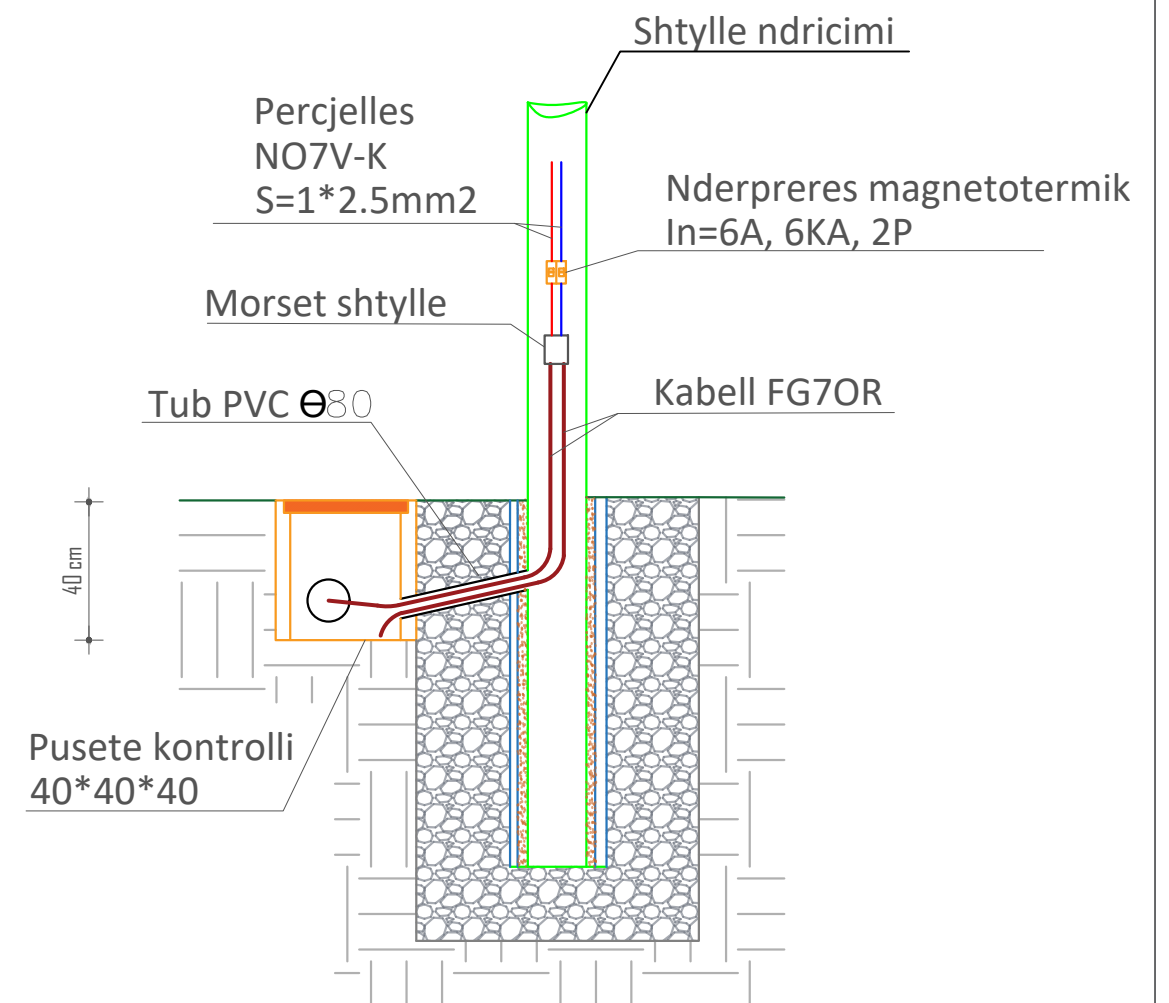

Porosites
Bashkia Roskovec
Miratoi
Kryetar: **Majlinda Bufi**

Projekt :
**SISTEMIM-ASFALTIMI I RRUGES NR.3,
FSHATI VELMISH DHE RIKONSTRUKSIONI I
CEZMES PUBLIKE, FAZA-1**

Grupi i Projektimit :
Ing. Erion HOXHA
Ing. Eldison KOCAQI
Ing. Arben DUKAJ

Drejtor i P.Z.H.T :
Rakip HAZIJAJ

Titull flete :
**DETAJE TE MONTIMIT TE
NDRICIMIT RRUGOR**

Date 25.10.2018
Shkalla

Flete A3 Nr.
19

Kuadri Elektrik

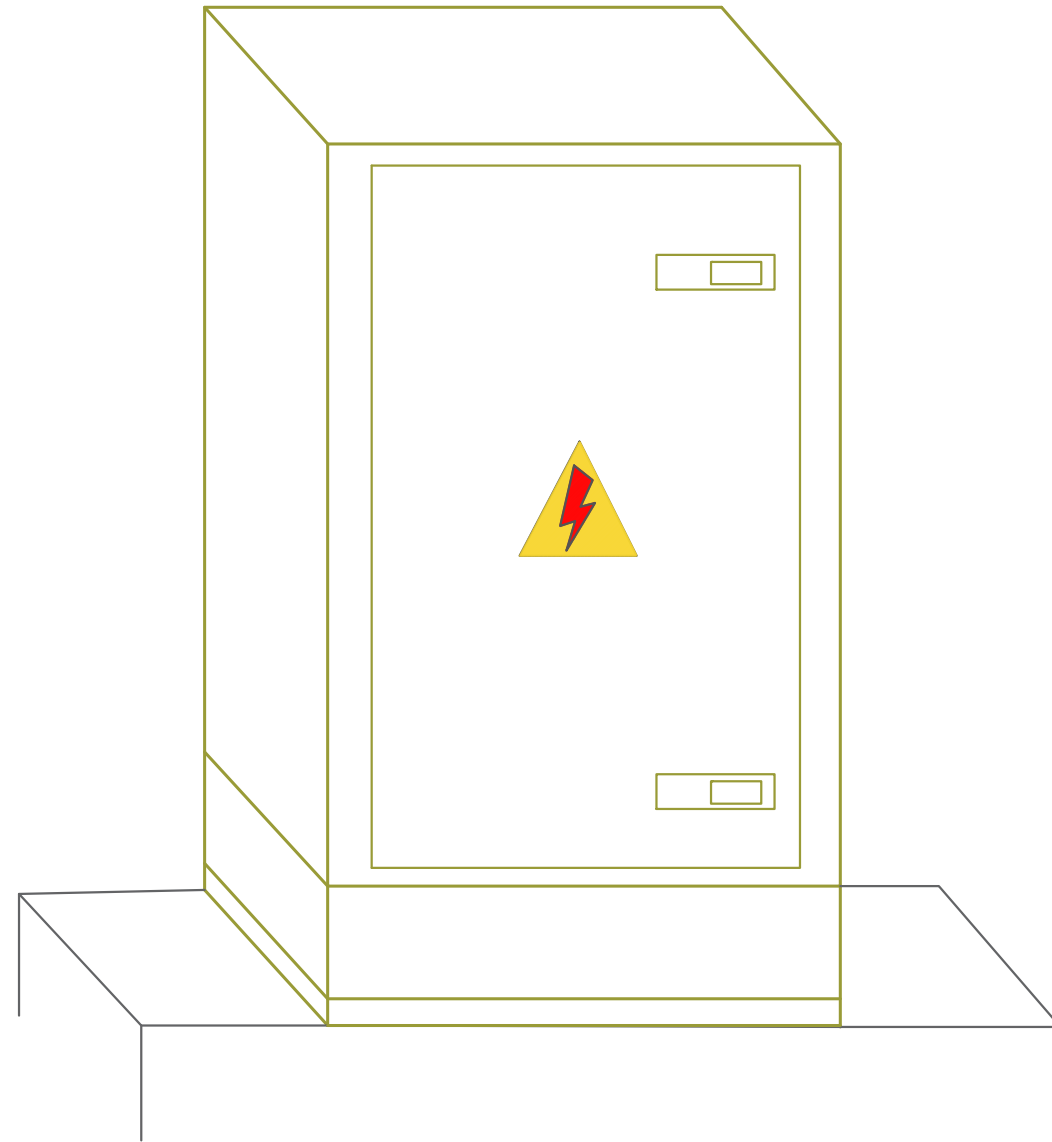

Skema e lidhjes se ndricimit qarkut te komandimit te

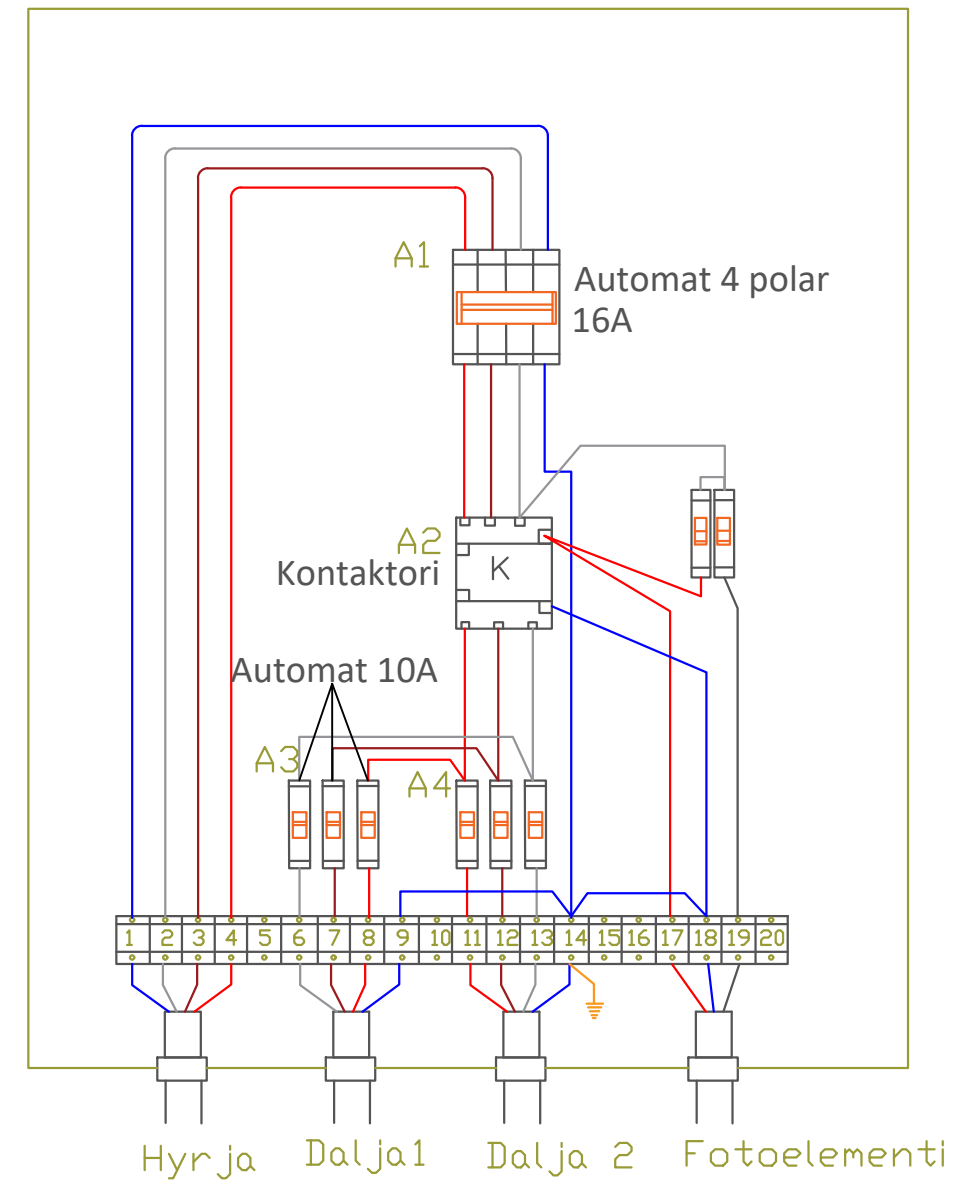

Porosites
Bashkia Roskovec
Miratoi
Kryetar: **Majlinda Bufi**

Projekt :
**SISTEMIM-ASFALTIMI I RRUGES NR.3,
FSHATI VELMISH DHE RIKONSTRUKSIONI I
CEZMES PUBLIKE, FAZA-1**

Grupi i Projektimit :
Ing. Erion HOXHA
Ing. Eldison KOCAQI
Ing. Arben DUKAJ

Drejtor i P.Z.H.T :
Rakip HAZIJAJ

Titull flete :
**DETAJE TE MONTIMIT TE
NDRICIMIT RRUGOR**

Date
Shkalla

25.10.2018

Flete A3 Nr.
20