

**PLANVENDOSJA E TREGUT TE MALLRAVE TE PERDORURA, BASHKIA GRAMSH
SHKALLA 1:1000**

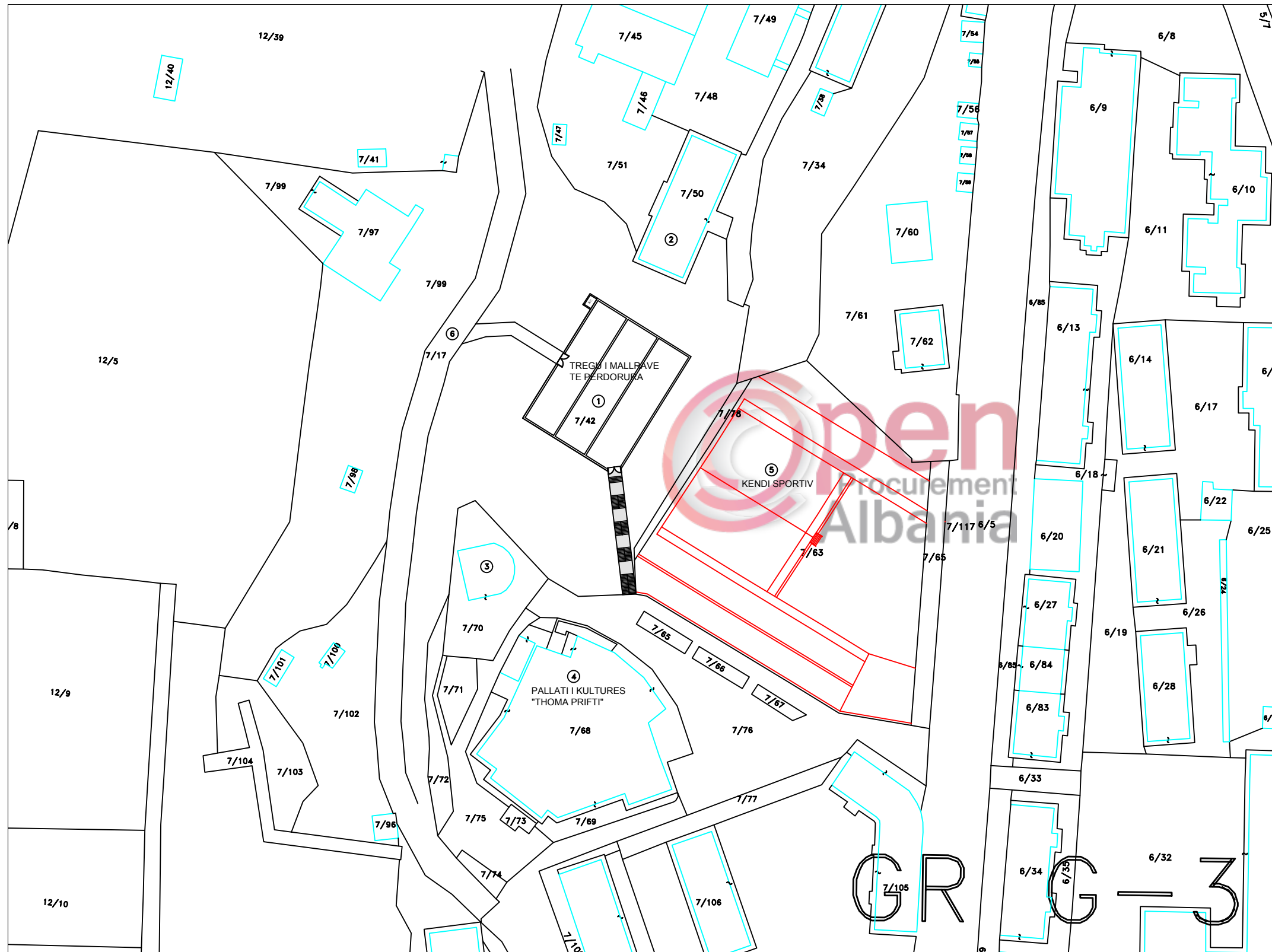

**MIRATOHET
KRYETARI I BASHKISE
LULJETA DOLLANI**

**DREJTORI
DREJTORIA E PLANIFIKIMIT,
ZHVILLIMIT DHE MBROJTJES
SE TERRITORIT
ALI ÇOHODARI**

**PUNOI:
ING.DHORI NISHKU
ING. ELIANA ÇIMO**

- Shenim:
- 1. Tregu i mallrave te perdorura
 - 2. Objekt 2kt "Ish magazine e ish NTSH-se"
 - 3. Biznes privat
 - 4. Pallati i Kultures "Thoma Prifti"
 - 5. Kendi sportiv
 - 6. Rruga "Devoll"

PLANIMETRIA E MUREVE TE TREGUT TE MALLRAVE TE PERDORUR

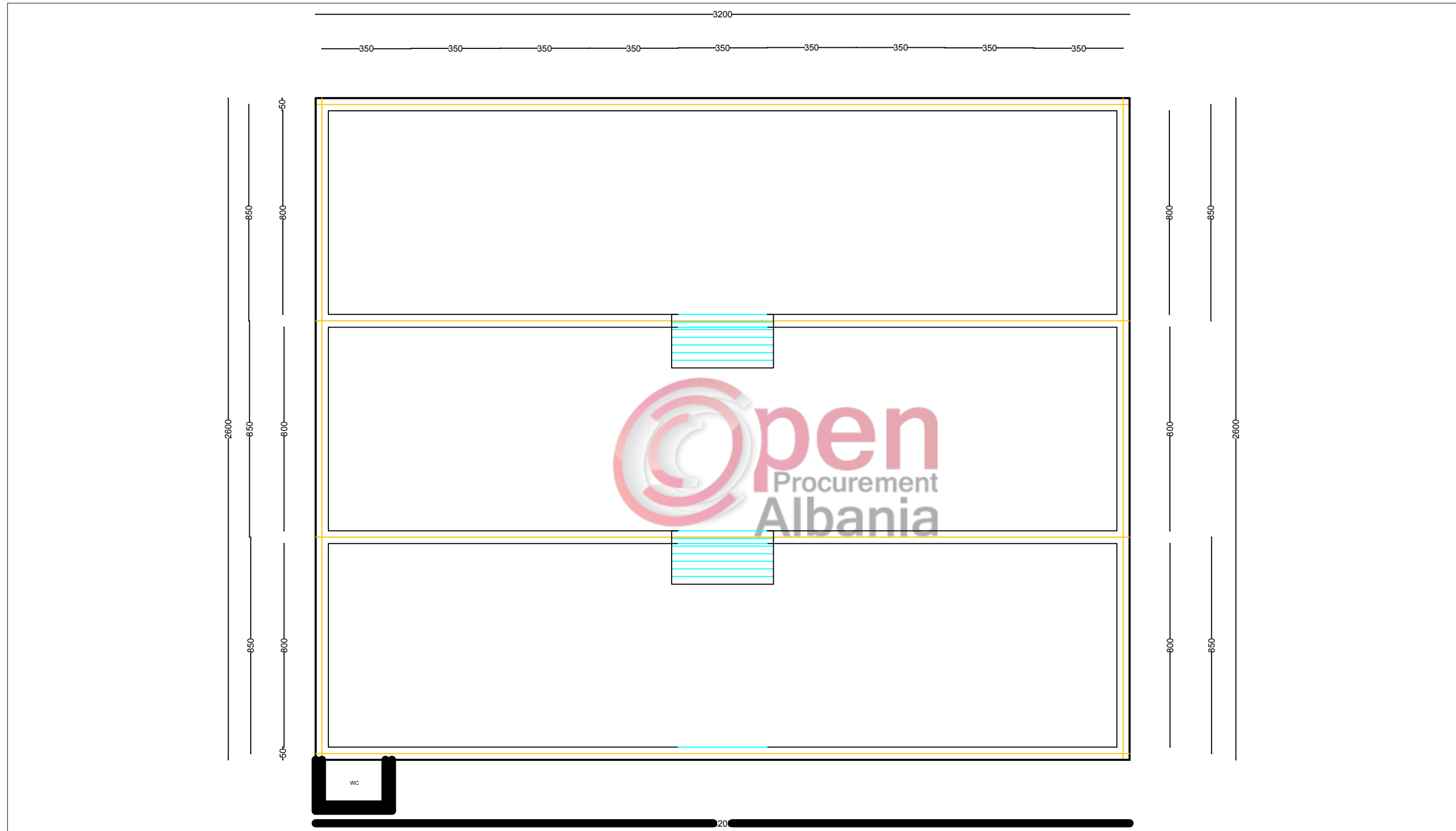

MIRATOI

DREJTORI

PUNOI

KRYETARI I BASHKISE

DREJTORIA E PLANIFIKIMIT

ING. DHORI NISHKU

LULJETA DOLLANI

ZHVILLIMIT DHE MBROJTJES

ING. ELIANA ÇIMO

SE TERRITORIT

ING. ALI ÇOHODARI

PLANI I THEMELEVE

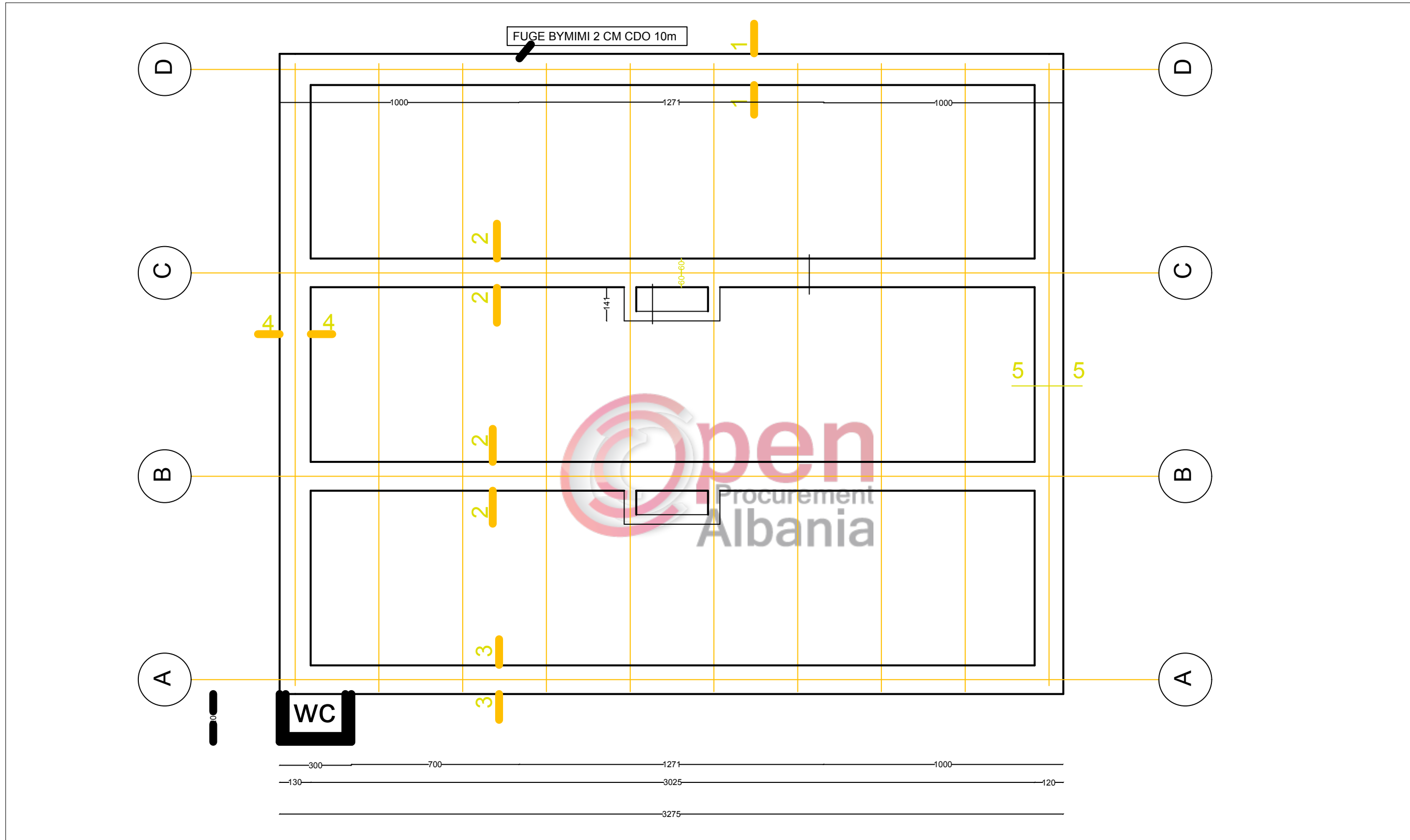

MIRATOI

KRYETARI I BASHKISE

LULJETA DOLLANI

DREJTORI

DREJTORIA E PLANIFIKIMIT

ZHVILLIMIT DHE MBROJTJES

SE TERRITORIT

ING. ALI ÇOHODARI

PUNOI

ING. DHORI NISHKU

ING. ELIANA ÇIMO

PLANI I KULLIMIT TE UJERAVE TE ÇATISE

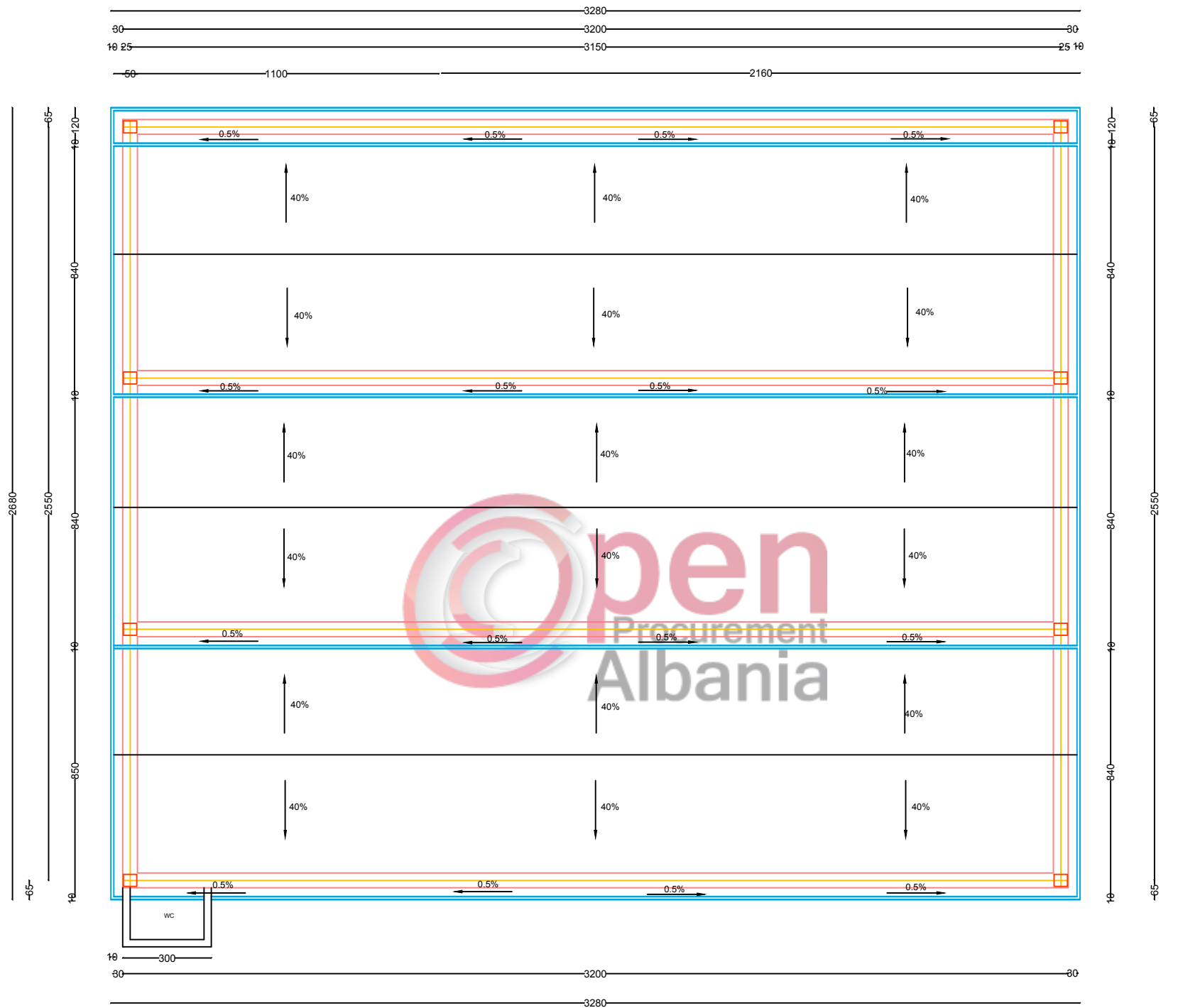

MIRATOI

KRYETARI I BASHKISE

LULJETA DOLLANI

DREJTORI

DREJTORIA E PLANIFIKIMIT

ZHVILLIMIT DHE MBROJTJES

SE TERRITORIT

ING. ALI ÇOHODARI

PUNOI

ING. DHORI NISHKU

ING. ELIANA ÇIMO

PLANI I KOLLONAVE

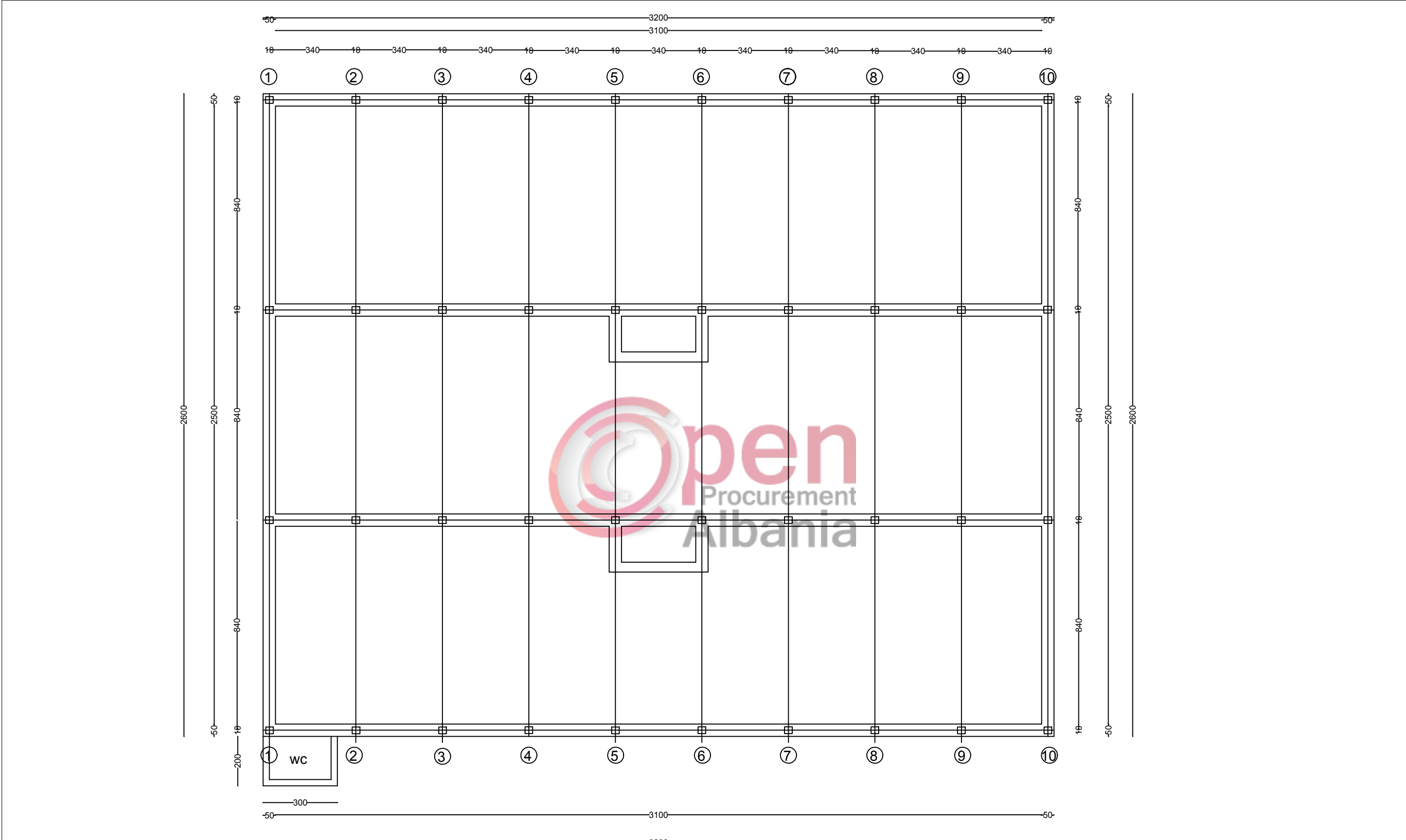

MIRATOI

KRYETARI I BASHKISE

LULJETA DOLLANI

DREJTORI

DREJTORIA E PLANIFIKIMIT

ZHVILLIMIT DHE MBROJTJES

SE TERRITORIT

ING. ALI ÇOHODARI

PUNOI

ING. DHORI NISHKU

ING. ELIANA ÇIMO

PLANI I KAPRIATAVE

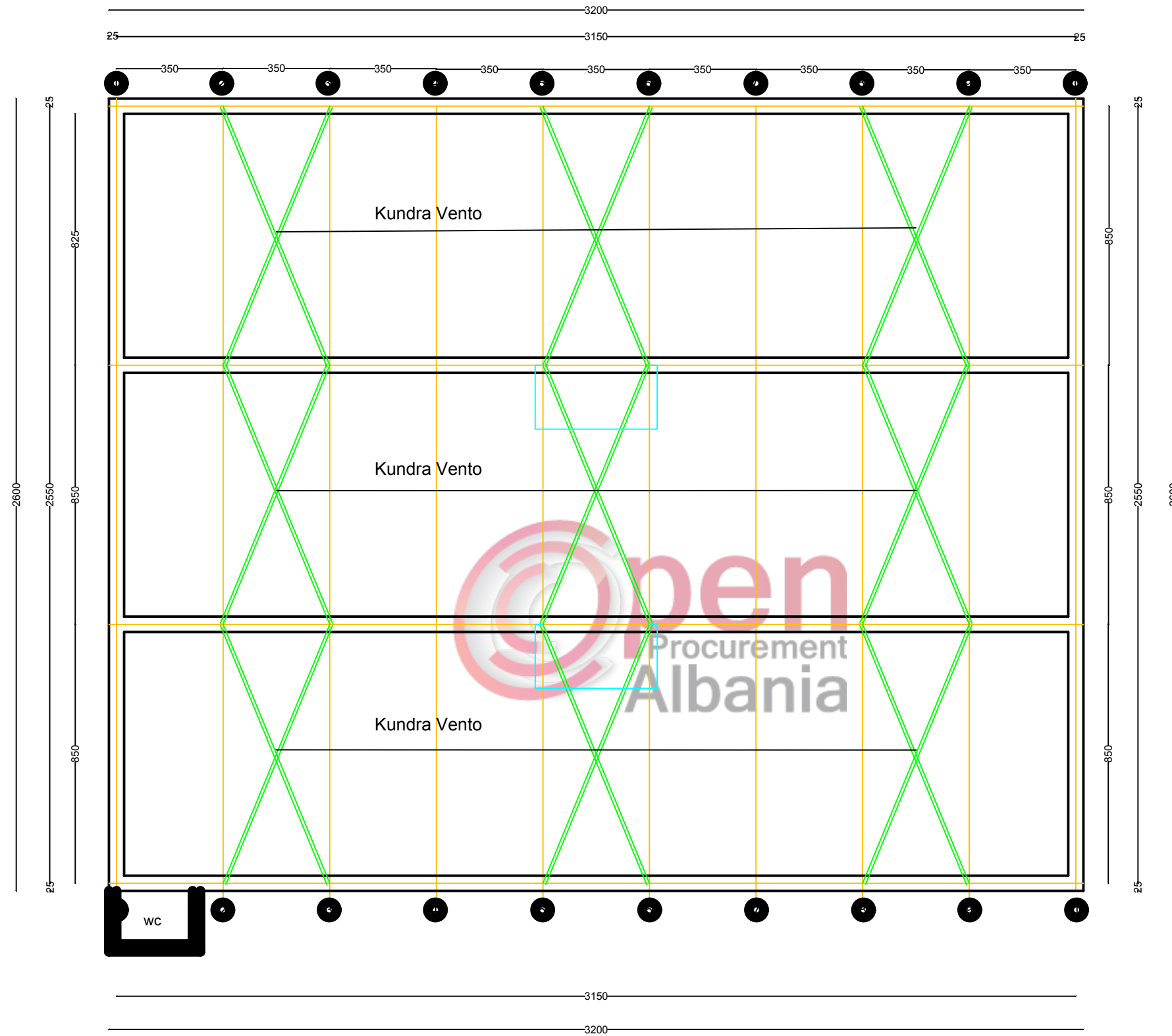

MIRATOI

KRYETARI I BASHKISE

LULJETA DOLLANI

DREJTORI

DREJTORIA E PLANIFIKIMIT

ZHVILLIMIT DHE MBROJTJES

SE TERRITORIT

ING. ALI ÇOHODARI

PUNOI

ING. DHORI NISHKU

ING. ELIANA ÇIMO

PRERJA TERTHORE E TERRENIT KU DO TE VENDOSSET TREGU I MALLRAVE TE PERDORUR, BASHKIA GRAMSH
SHKALLA 1:100

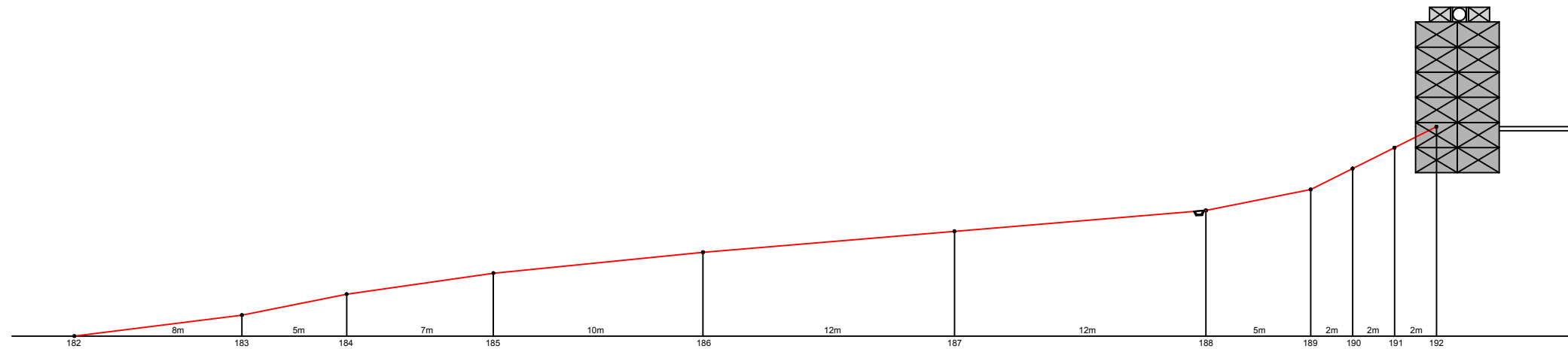

**MIRATOHET
KRYETARI I BASHKISE**

LULJETA DOLLANI

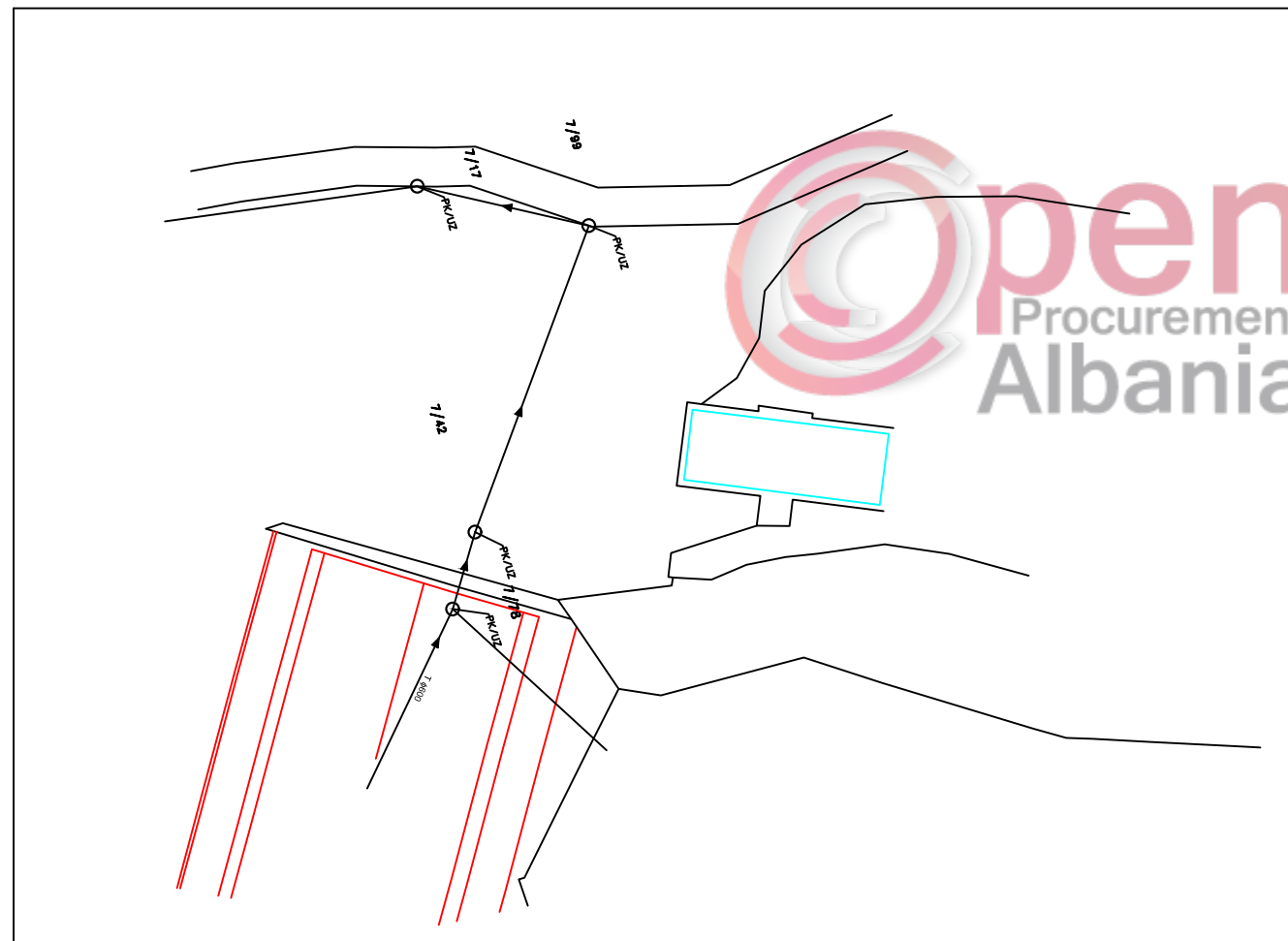

**DREJTORIA E PLANIFIKIMIT
ZHVILLIMIT DHE MBROJTJES
SE TERRITORIT**

ALI ÇOHODARI

PUNOI:

ING.DHORI NISHKU

ING. ELIANA CIMO

Shenim: Shkallet do te zbatohen sipas pozicionit te caktuar ne projekt,
duke i pershtatur sipas terrenit konkret.

PRERJA GJATESORE B - B E SHKALLEVE TE TREGUT TE MALLRAVE TE PERDORURA, BASHKIA GRAMSH

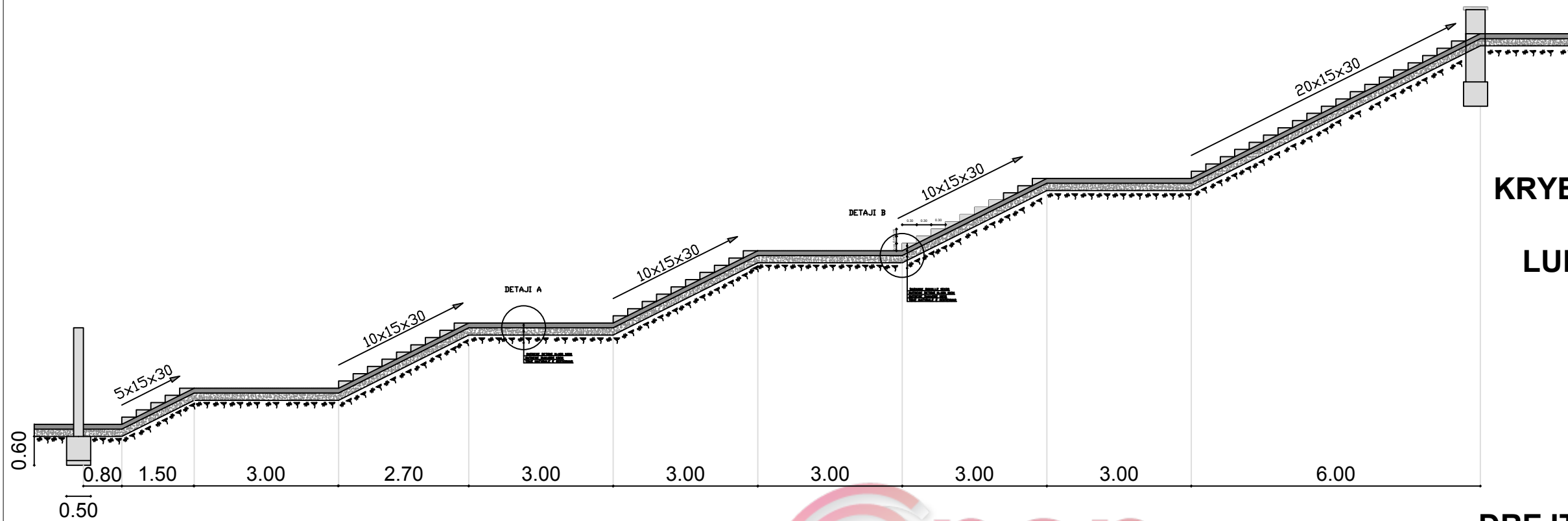

MIRATOHET
KRYETARI I BASHKISE
LULJETA DOLLANI

DETAJI A

DETAJI B

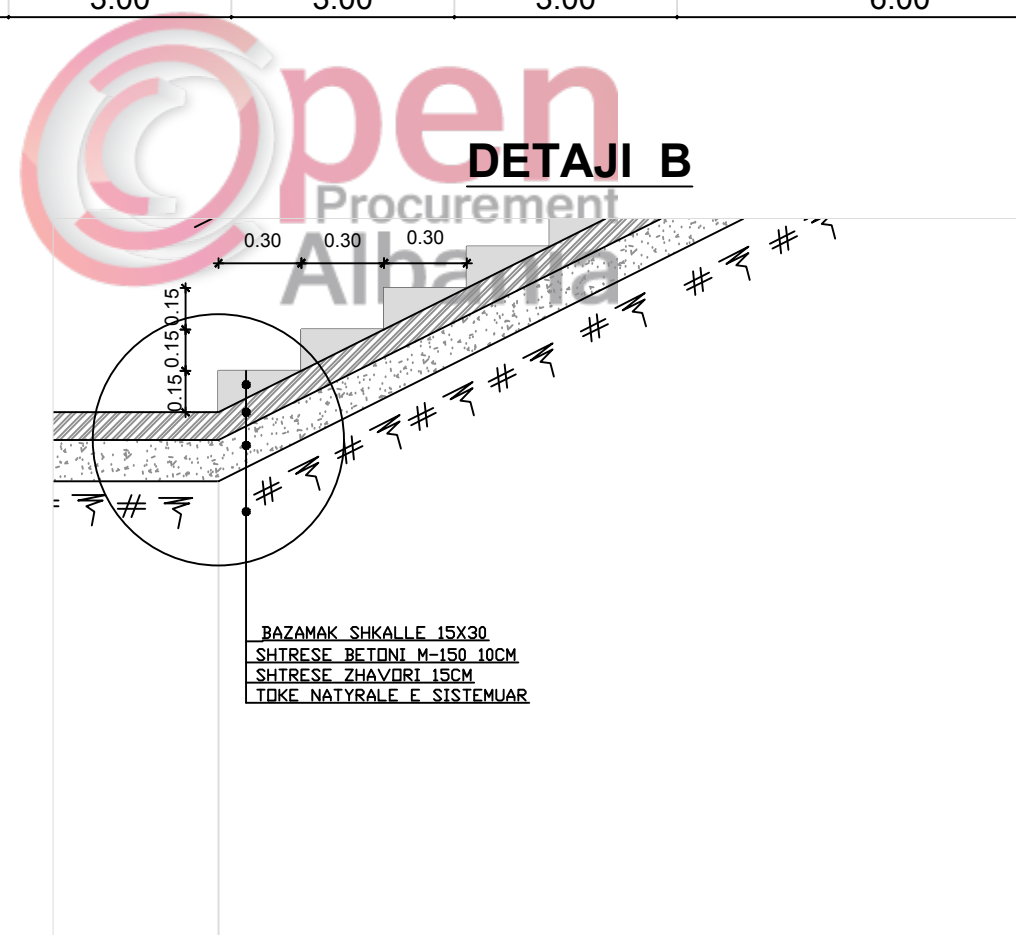
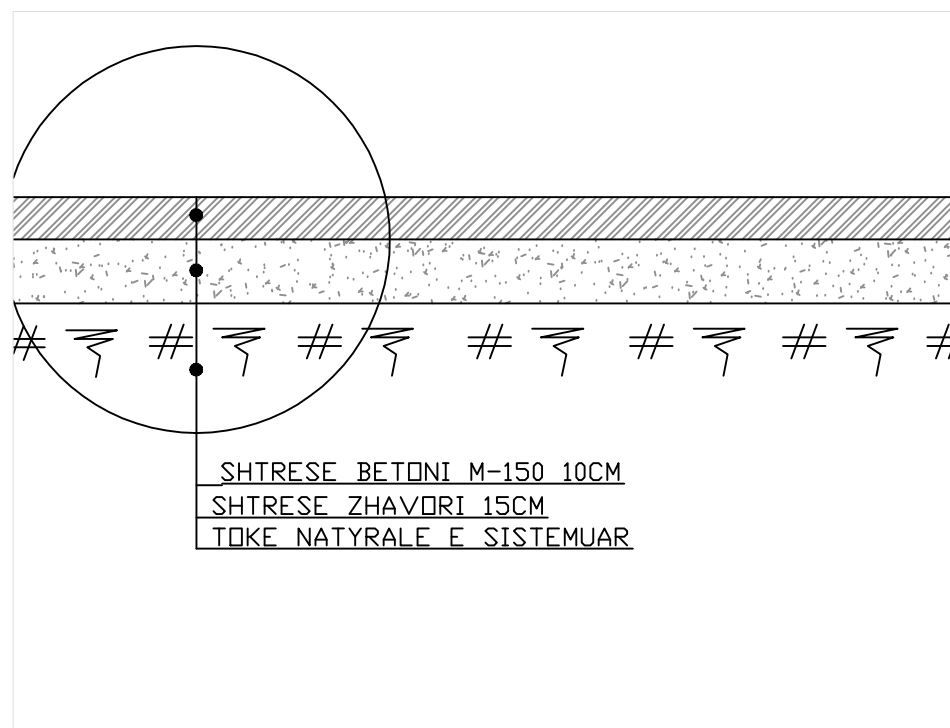

DREJTORIA E PLANIFIKIMIT
ZHVILLIMIT DHE MBROJTJES
SE TERRITORIT

ALI ÇOHODARI

PUNOI:

ING.DHORI NISHKU

ING. ELIANA CIMO

Shenim: Shkallet do te zbatohen sipas pozicionit te caktuar ne projekt, duke i pershtatur sipas terrenit konkret.

PRERJA TERTHORE A-A

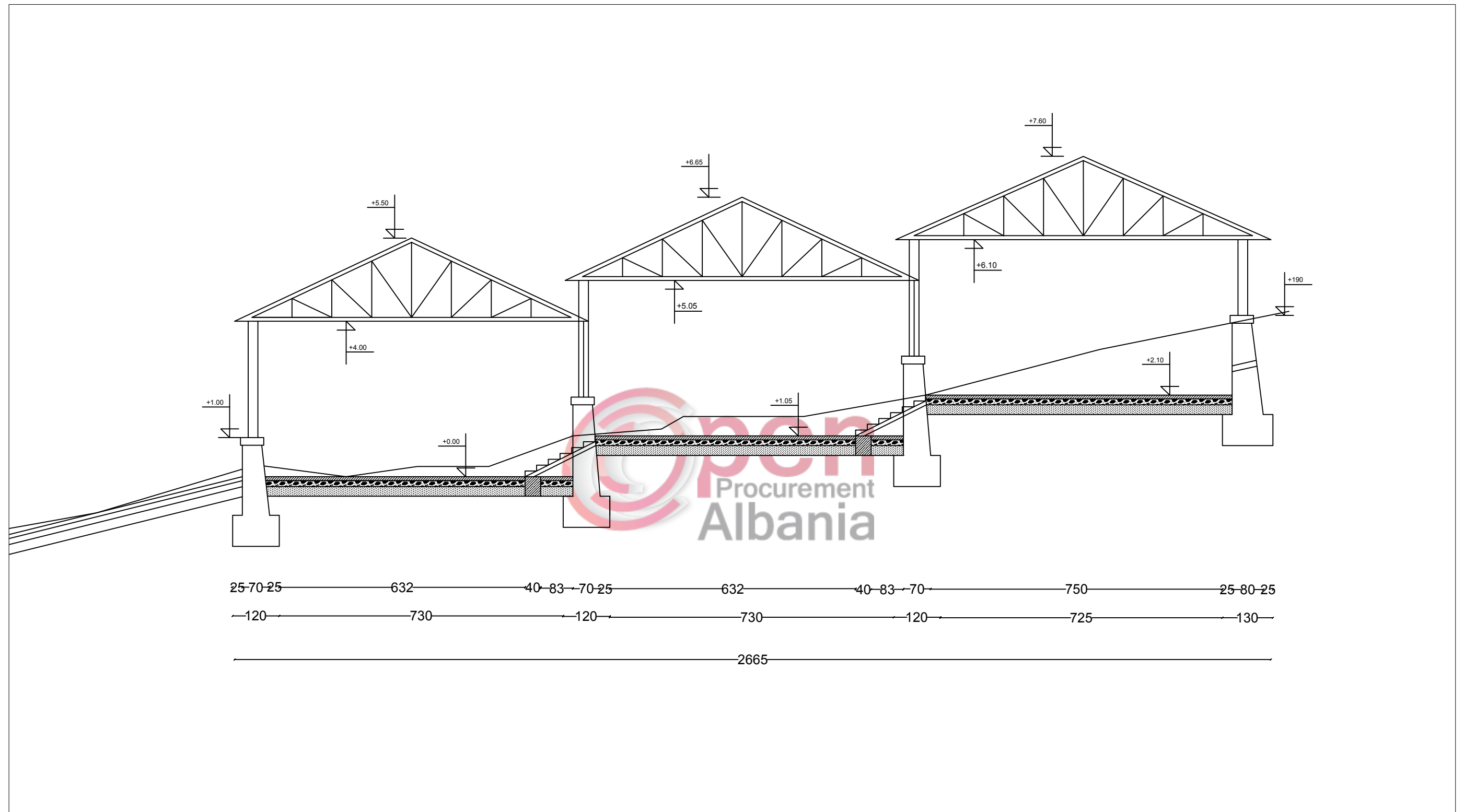

MIRATOI

KRYETARI I BASHKISE

LULJETA DOLLANI

DREJTORI

DREJTORIA E PLANIFIKIMIT

ZHVILLIMIT DHE MBROJTJES

SE TERRITORIT

ING. ALI ÇOHODARI

PUNOI

ING. DHORI NISHKU

ING. ELIANA ÇIMO

**PLANIMETRIA E RRJETIT TE KANALIZIMEVE TE UJRAVE TE BARDHA DHE DRENAZHIMI I TERRITORIT TE TREGUT
TE MALLRAVE TE PERDORURA, BASHKIA GRAMSH
SHKALLA 1:500**

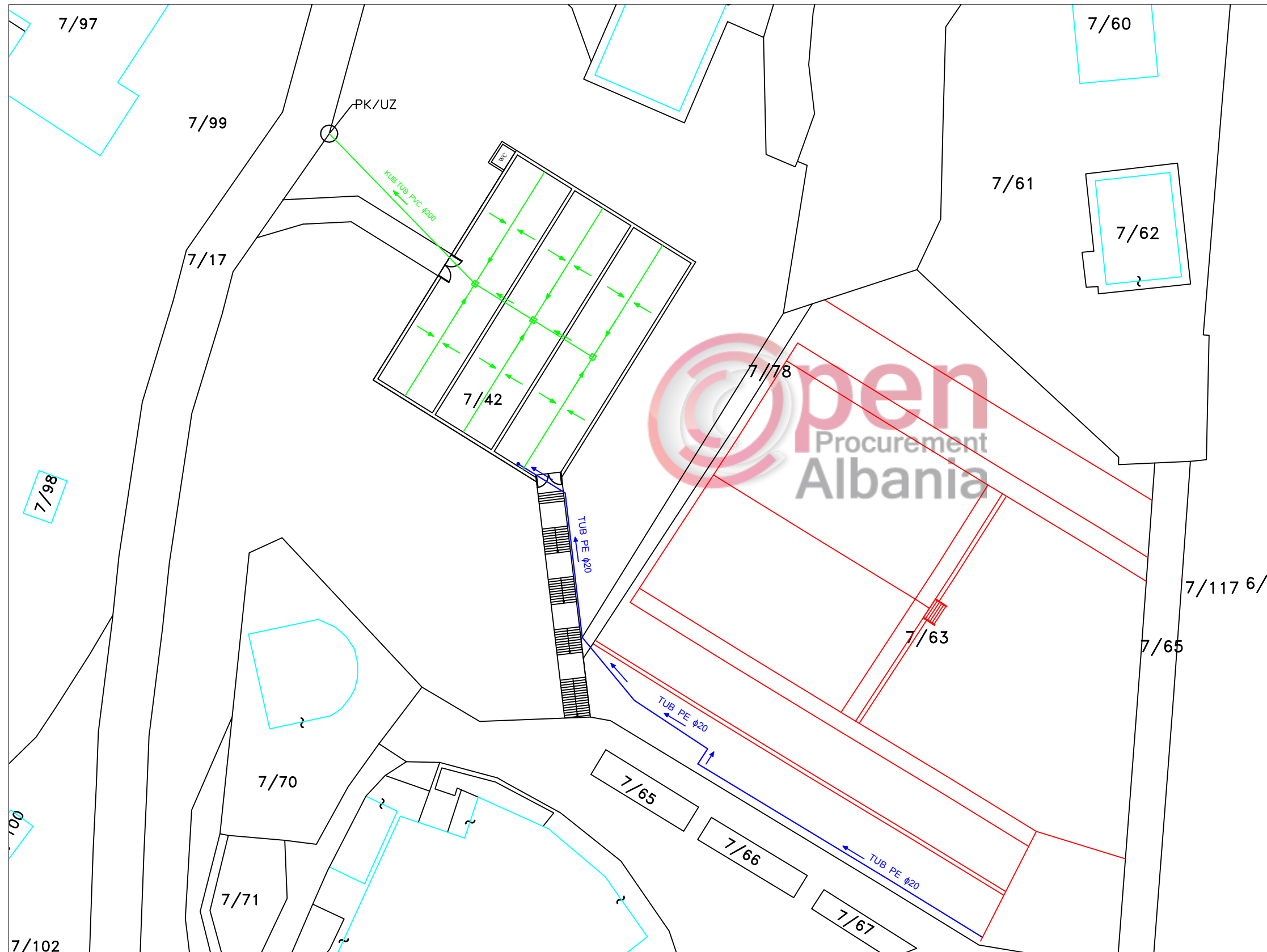

**MIRATOHET
KRYETARI I BASHKISE
LULJETA DOLLANI**

**DREJTORI
DREJTORIAE PLANIFIKIMIT,
ZHVILLIMIT DHE MBROJTJES
SE TERRITORIT
ALI ÇOHODARI**

**PUNOI:
ING.DHORI NISHKU
ING. ELIANA ÇIMO**

**PLANIMETRIA E RRJETIT TE KANALIZIMEVE TE UJRAVE TE ZEZA, PRANE TREGUT TE MALLRAVE TE PERDORURA
BASHKIA GRAMSH
SHKALLA 1:500**

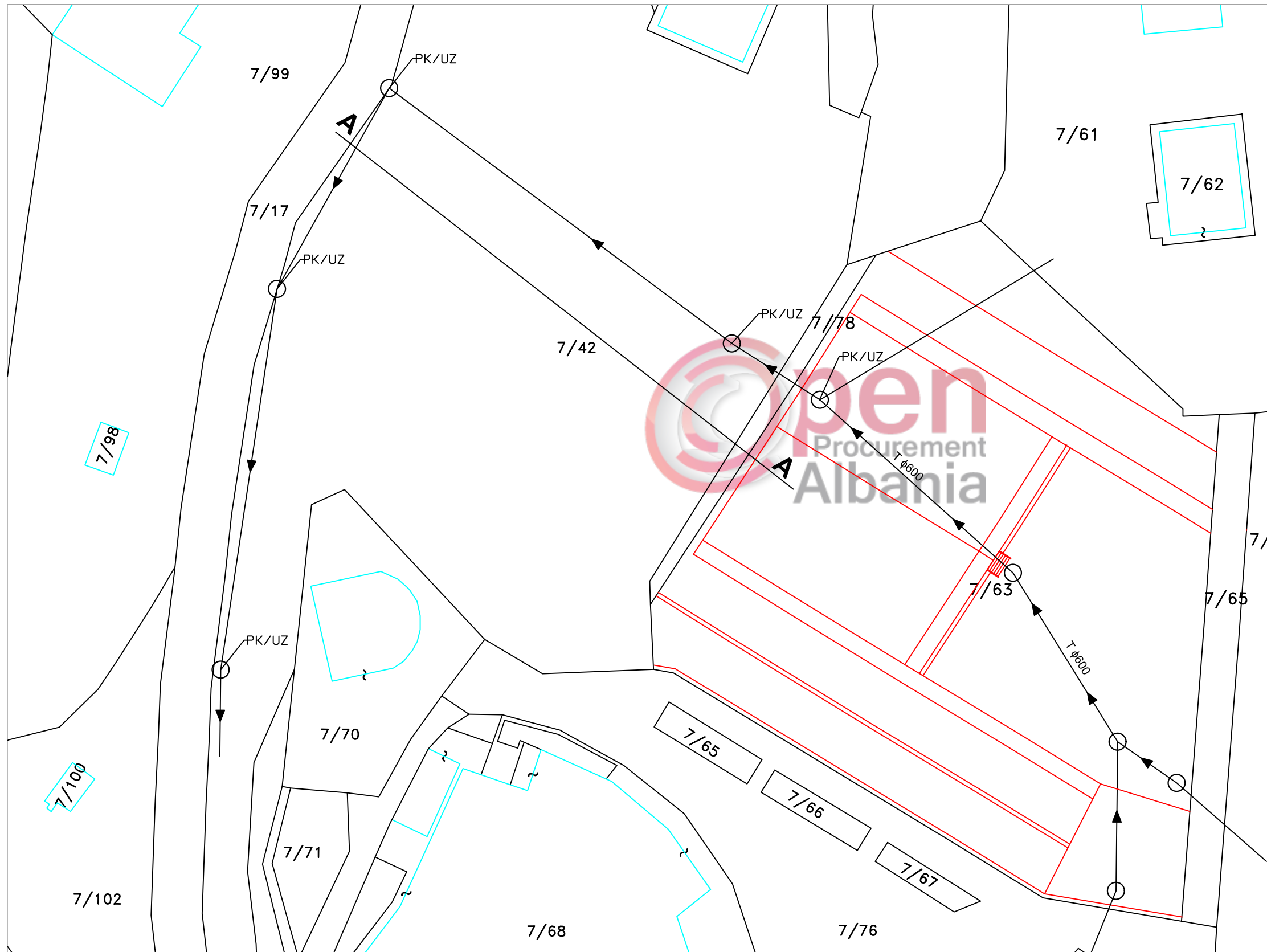

**MIRATOHET
KRYETARI I BASHKISE
LULJETA DOLLANI**

**DREJTORI
DREJTORIA E PLANIFIKIMIT,
ZHVILLIMIT DHE MBROJTJES
SE TERRITORIT
ALI ÇOHODARI**

**PUNOI:
ING. DHORI NISHKU
ING. ELIANA ÇIMO**

PLANIMETRIA E TREGUT TE MALLRAVE TE PERDORURA, BASHKIA GRAMSH
SHKALLA 1:500

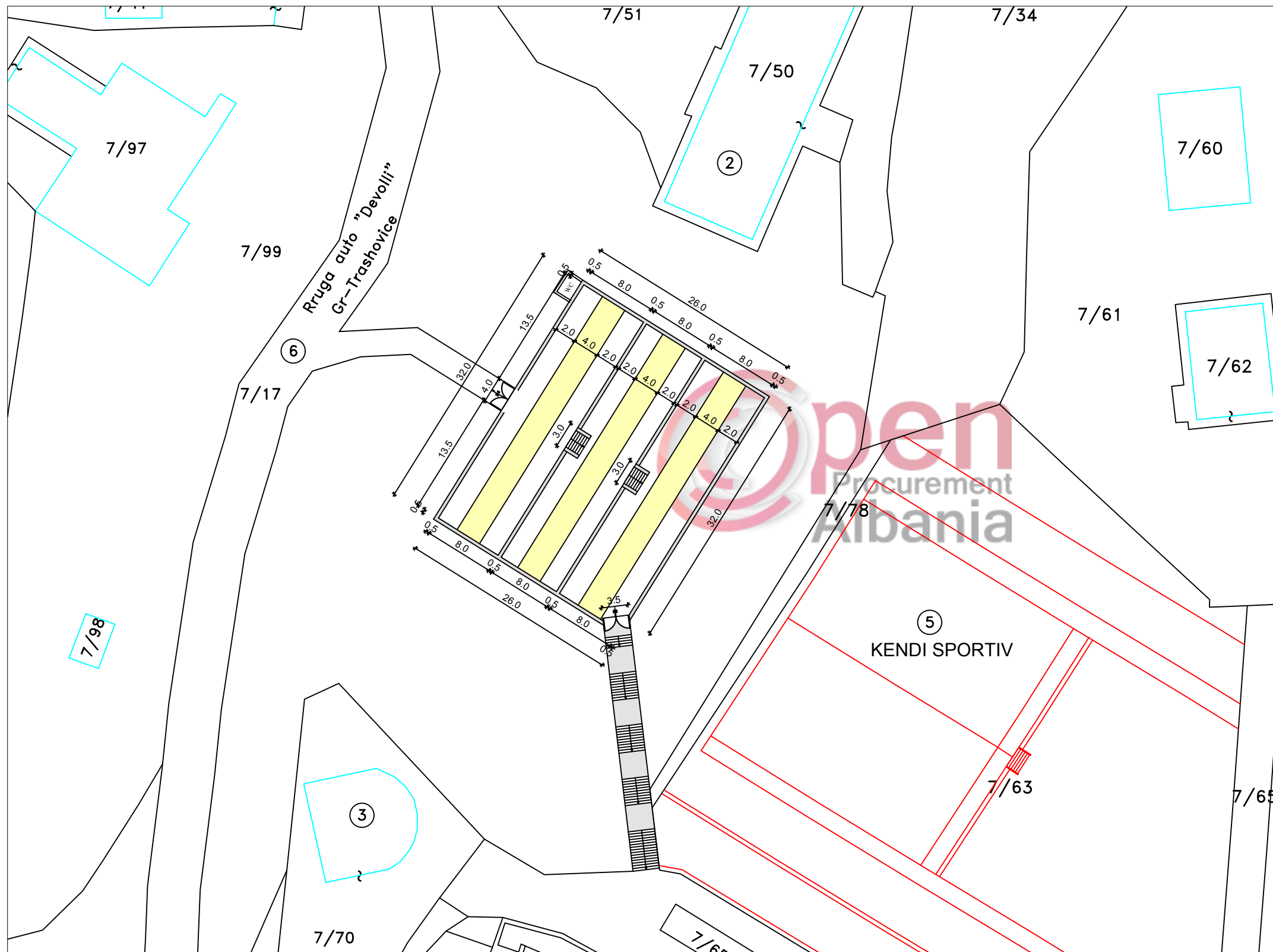

MIRATOHET
KRYETARI I BASHKISE
LULJETA DOLLANI

DREJTORI
DREJTORIA E PLANIFIKIMIT,
ZHVILLIMIT DHE MBROJTJES
SE TERRITORIT
ALI ÇOHODARI

PUNOI:
ING.DHORI NISHKU
ING. ELIANA ÇIMO

PLANIMETRIA E NYJES H/SANITARE (WC)

SH 1:50

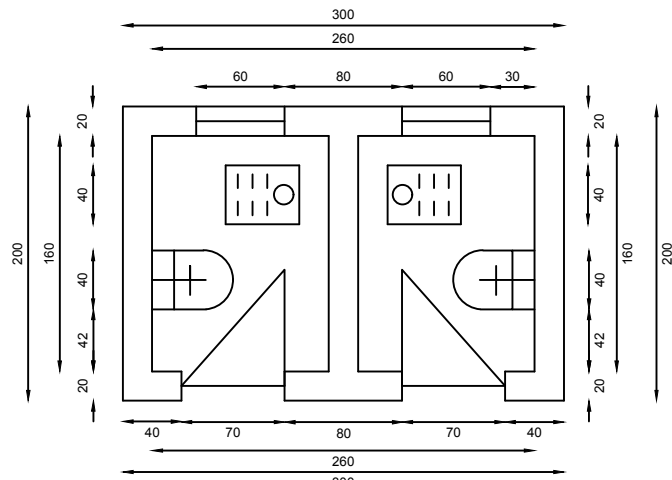

PLANI THEMELEVE E NYJES H/SANITARE (WC)

SH 1:50

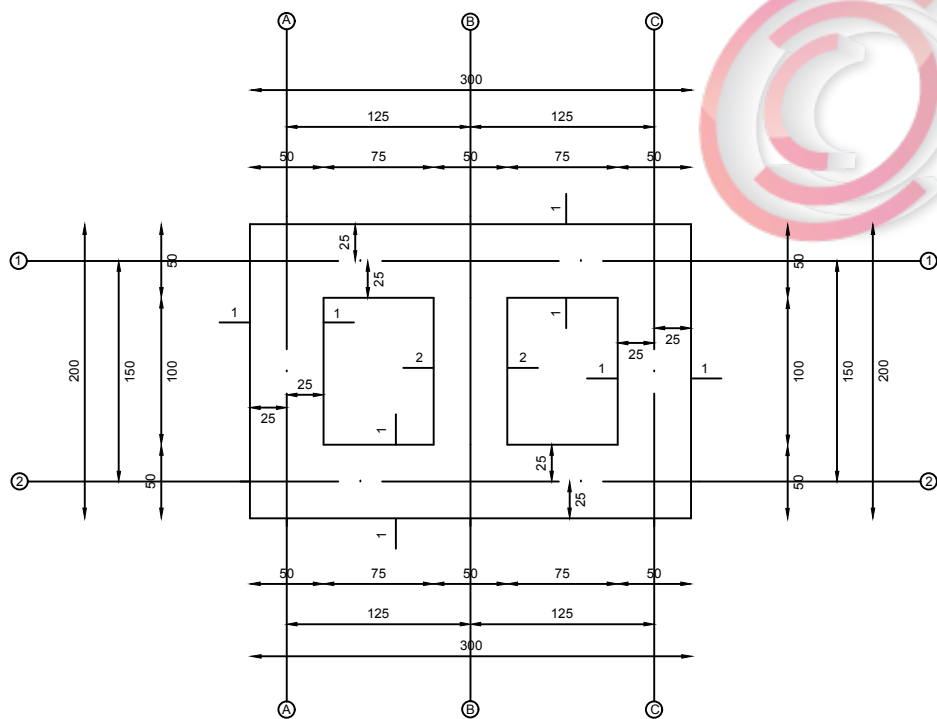

MIRATOI

KRYETARI I BASHKISE

LULJETA DOLLANI

DREJTORI

DREJTORIA E PLANIFIKIMIT

ZHVILLIMIT DHE MBROJTJES

SE TERRITORIT

ING. ALI ÇOHODARI

PUNOI

ING. DHORI NISHKU

ING. ELIANA ÇIMO

PRERJA 1-1 E THEMELIT

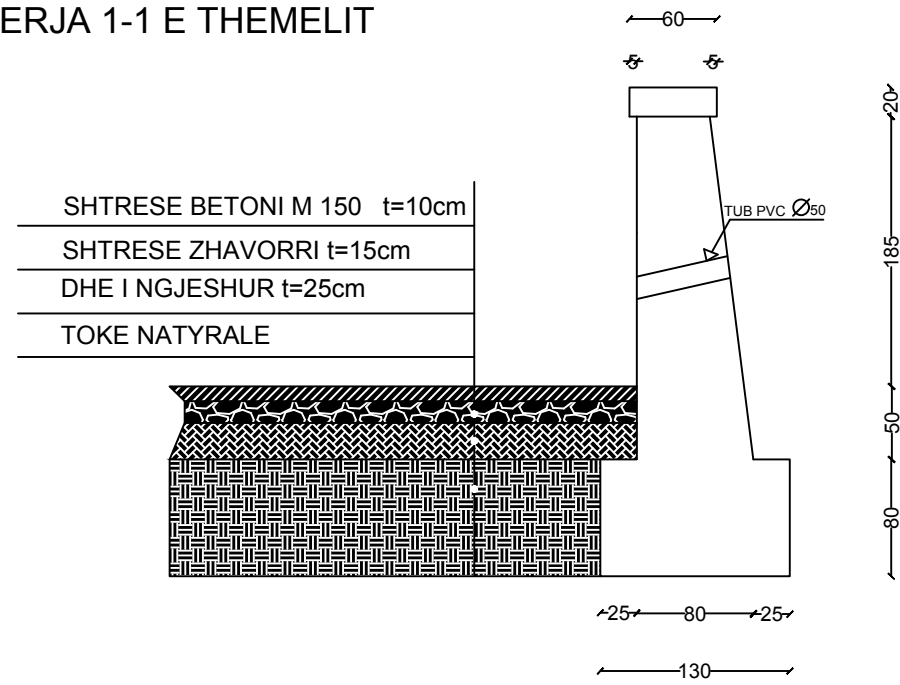

PRERJA 3-3 E THEMELIT

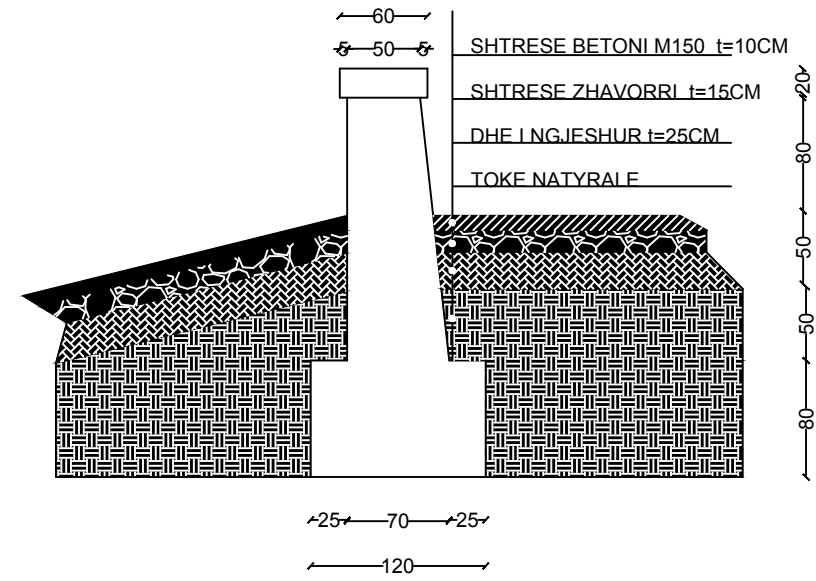

PRERJA 5-5 E THEMELIT

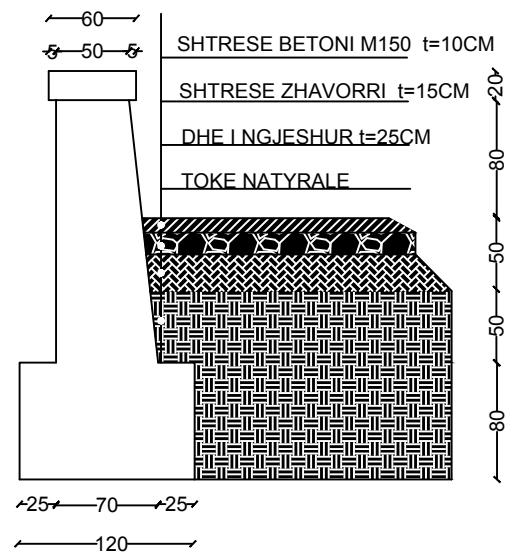

PRERJA 4-4 E THEMELIT

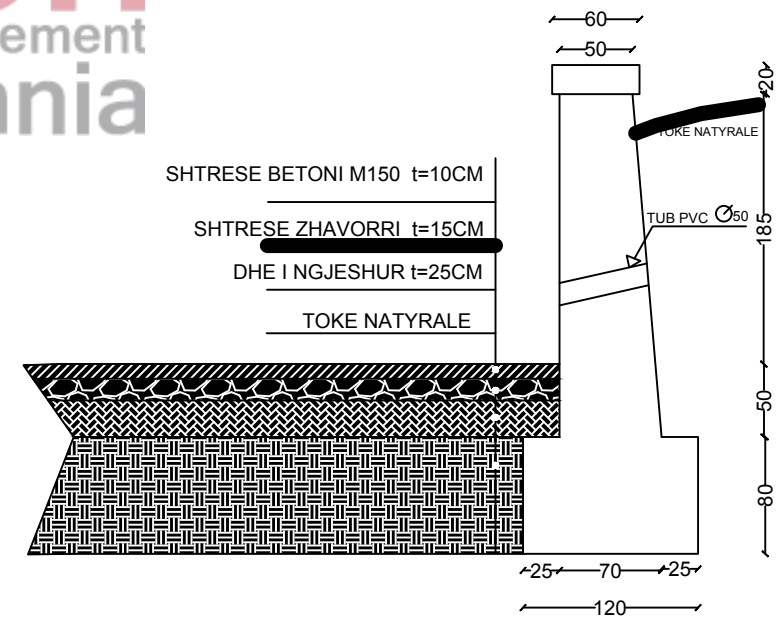

MIRATOI

KRYETARI I BASHKISE
 LULJETA DOLLANI

DREJTORI

DREJTORIA E PLANIFIKIMIT
 ZHVILLIMIT DHE MBROJTJES
 SE TERRITORIT
 ING. ALI ÇOHODARI

PUNOI

ING. DHORI NISHKU
 ING. ELIANA ÇIMO