

BASHKIA LEZHE

PROJEKT - ZBATIMI

OBJEKTI: SISTEMIM, ASFALTIM RRUGES AZEM HAJDARI



PROJEKTUES:

BASHKIA LEZHE

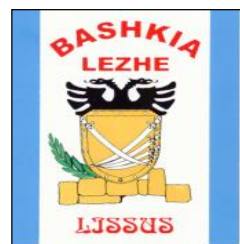

BASHKIA LEZHE

PROJEKT - ZBATIMI

OBJEKTI: SISTEMIM, ASFALTIM I RRUGES AZEM HAJDARI

HORTOGRAFIA E RRUGES

PROJEKTUES:

BASHKIA LEZHE

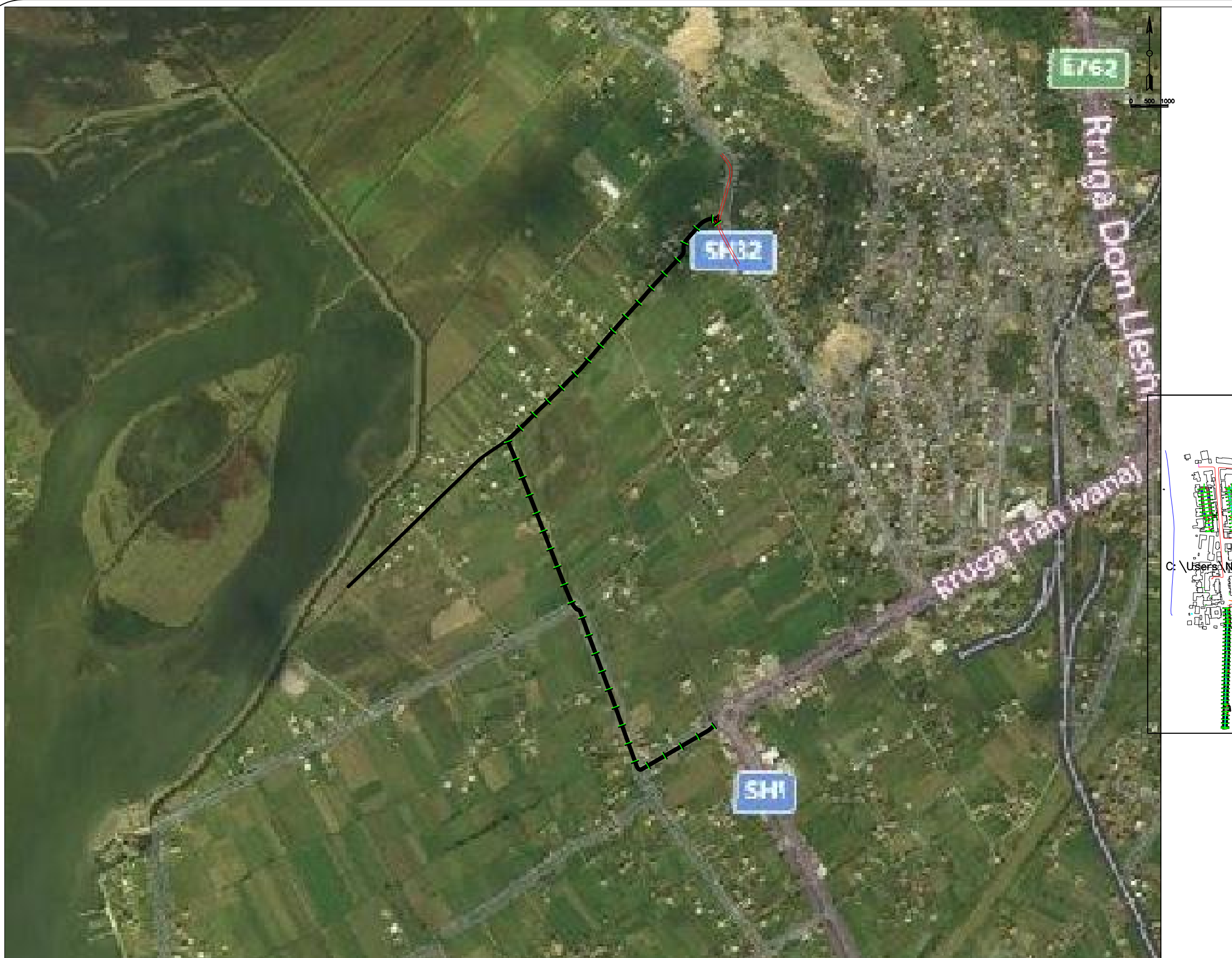



REPUBLIKA E SHQIPËRISE
BASHKIA LEZHE
 PROJEKT ZBATIMI
 SISTEMIM, ASFALTIM RRUGA AZEM
 HAJDARI

BASHKIA LEZHE
 DREJTORIA E PLANIFIKIMI
 DHE ZHVILLIMIT TE
 TERRITORIT

Ark.DODE ZHUBA	
Ing.ADIONA MARTINI	
Ing.GJOVALIN MARKU	
Ing.GJON LUCA	
Ing.ALBAN LAÇI	

Project Name and Address
 SISTEMIM, ASFALTIM I RRUGES AZEM
 HAJDARI

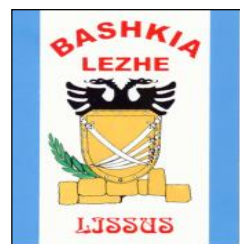
Project HORTOGRAFIA	Sheet
Date	1
Scale 1:500	



BASHKIA LEZHE

PROJEKT - ZBATIMI

OBJEKTI: SISTEMIM, ASFALTIM I RRUGES AZEM HAJDARI

PALMIMETRIA E RRUGES

PROJEKTUES:

BASHKIA LEZHE

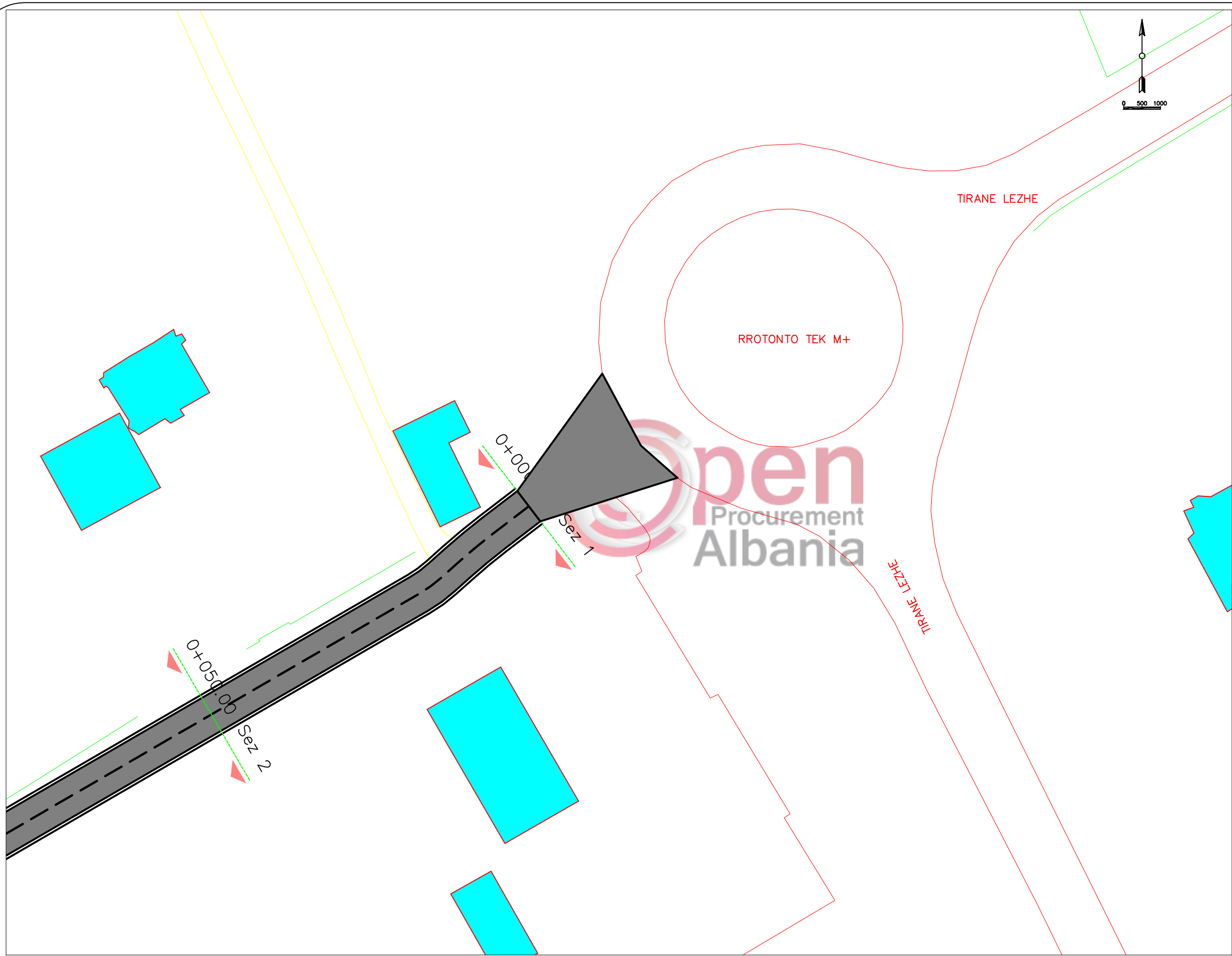

REPUBLIKA E SHQIPËRISE
BASHKIA LEZHE
 PROJEKT ZBATIMI
 SISTEMIM, ASFALTIM RRUGA AZEM
 HAJDARI

Firm Name and Address

BASHKIA LEZHE
 DREJTORIA E PLANIFIKIMI
 DHE ZHVILLIMIT TE
 TERRITORIT

Ark.DODE ZHUBA	
Ing.ADIONA MARTINI	
Ing.GJOVALIN MARKU	
Ing.GJON LUCA	
Ing.ALBAN LAÇI	

Project Name and Address
 SISTEMIM, ASFALTIM I RRUGES AZEM
 HAJDARI

Project PLANIMETRIA	Sheet
Date JANAR 2019	
Scale 1:500	

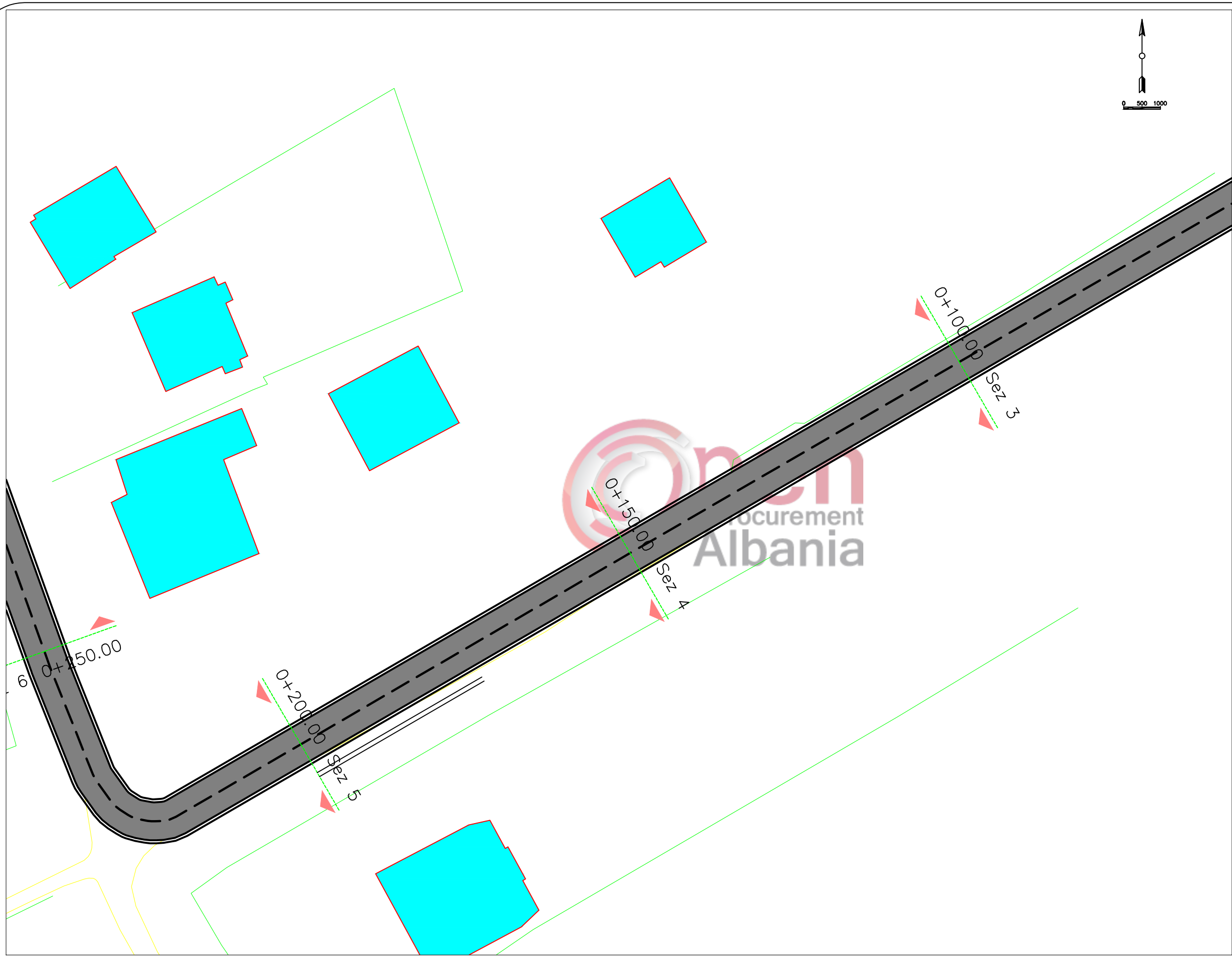

REPUBLIKA E SHQIPËRISE
BASHKIA LEZHE
 PROJEKT ZBATIMI
 SISTEMIM, ASFALTIM RRUGA AZEM
 HAJDARI

Firm Name and Address

BASHKIA LEZHE
 DREJTORIA E PLANIFIKIMI
 DHE ZHVILLIMIT TE
 TERRITORIT

Ark.DODE ZHUBA	
Ing.ADIONA MARTINI	
Ing.GJOVALIN MARKU	
Ing.GJON LUCA	
Ing.ALBAN LAÇI	

Project Name and Address
 SISTEMIM, ASFALTIM I RRUGES AZEM
 HAJDARI

Project PLANIMETRIA	Sheet
Date JANAR 2019	
Scale 1:500	

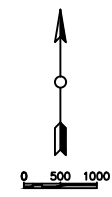

REPUBLIKA E SHQIPËRISE
BASHKIA LEZHE
 PROJEKT ZBATIMI
 SISTEMIM, ASFALTIM RRUGA AZEM
 HAJDARI

Firm Name and Address

BASHKIA LEZHE
 DREJTORIA E PLANIFIKIMI
 DHE ZHVILLIMIT TE
 TERRITORIT

Ark. DODE ZHUBA	
Ing. ADIONA MARTINI	
Ing. GJOVALIN MARKU	
Ing. GJON LUCA	
Ing. ALBAN LAÇI	

Project Name and Address
 SISTEMIM, ASFALTIM I RRUGES AZEM
 HAJDARI

Project PLANIMETRIA	Sheet
Date JANAR 2019	
Scale 1:500	

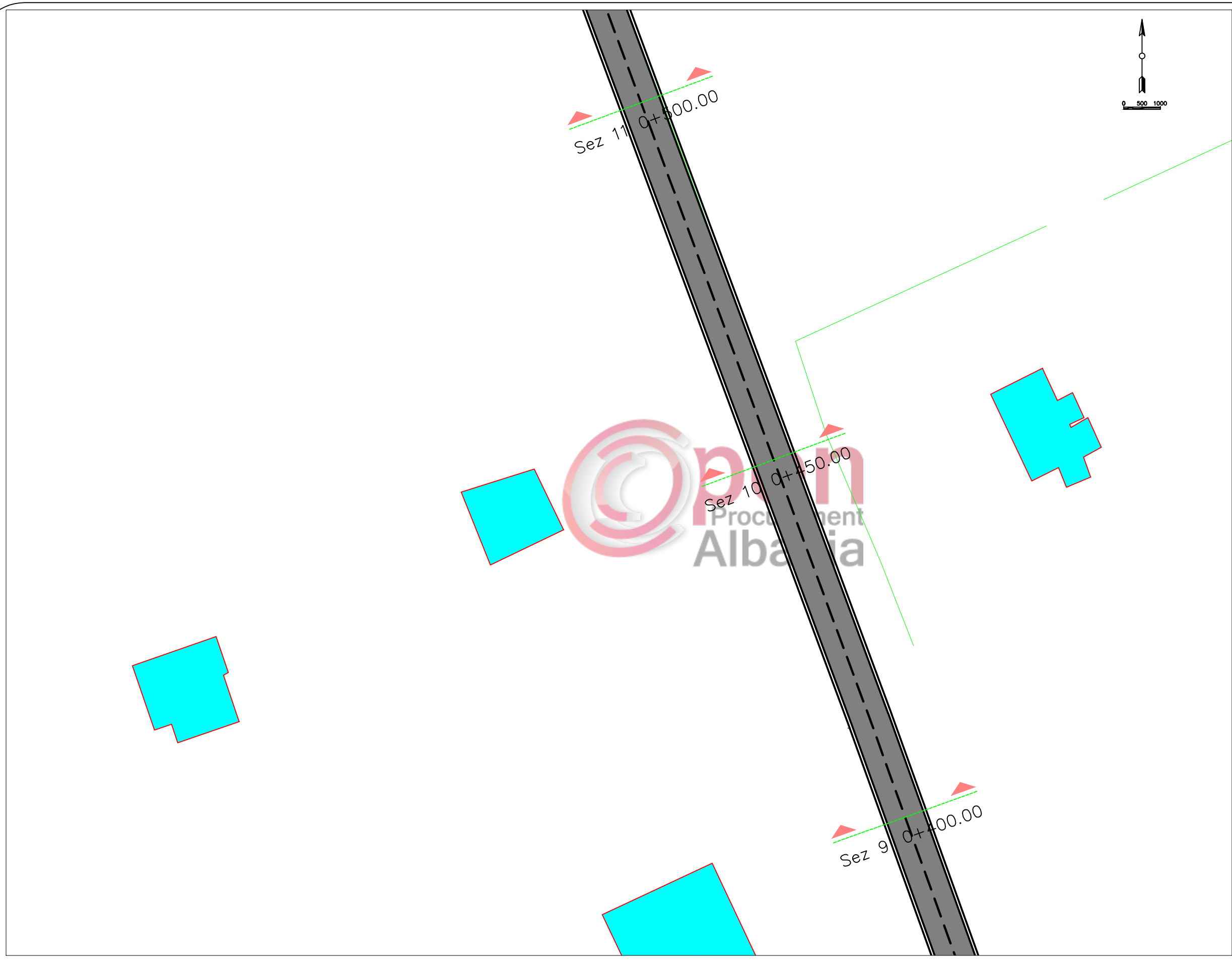

REPUBLIKA E SHQIPËRISE
BASHKIA LEZHE
 PROJEKT ZBATIMI
 SISTEMIM, ASFALTIM RRUGA AZEM
 HAJDARI

Firm Name and Address

BASHKIA LEZHE
 DREJTORIA E PLANIFIKIMI
 DHE ZHVILLIMIT TE
 TERRITORIT

Ark.DODE ZHUBA	
Ing.ADIONA MARTINI	
Ing.GJOVALIN MARKU	
Ing.GJON LUCA	
Ing.ALBAN LAÇI	

Project Name and Address
 SISTEMIM, ASFALTIM I RRUGES AZEM
 HAJDARI

Project PLANIMETRIA	Sheet
Date JANAR 2019	
Scale 1:500	

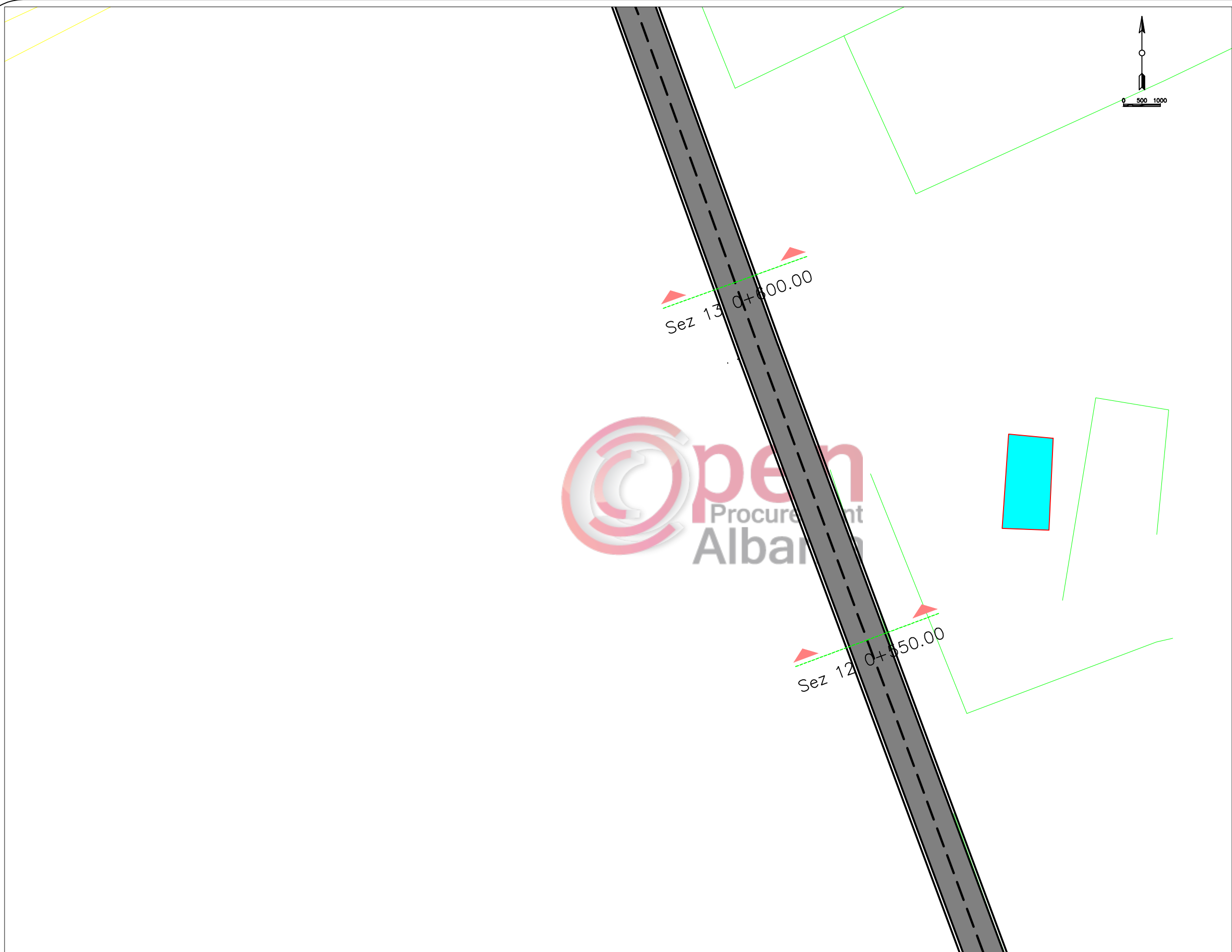

 REPUBLIKA E SHQIPËRISE
 BASHKIA LEZHE
 PROJEKT ZBATIMI
 SISTEMIM, ASFALTIM RRUGA AZEM
 HAJDARI

Firm Name and Address

 BASHKIA LEZHE
 DREJTORIA E PLANIFIKIMI
 DHE ZHVILLIMIT TE
 TERRITORIT

Ark.DODE ZHUBA	
Ing.ADIONA MARTINI	
Ing.GJOVALIN MARKU	
Ing.GJON LUCA	
Ing.ALBAN LAÇI	

Project Name and Address
 SISTEMIM, ASFALTIM I RRUGES AZEM
 HAJDARI

Project PLANIMETRIA	Sheet
Date JANAR 2019	
Scale 1:500	

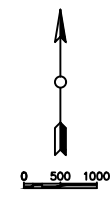

Sez 16 0+150.00

Sez 15 0+100.00

Sez 14 0+50.00

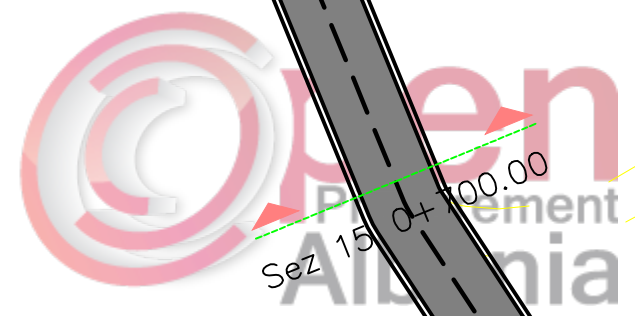

REPUBLIKA E SHQIPËRISE
BASHKIA LEZHE

PROJEKT ZBATIMI
SISTEMIM, ASFALTIM RRUGA AZEM
HAJDARI

Firm Name and Address



BASHKIA LEZHE
DREJTORIA E PLANIFIKIMI
DHE ZHVILLIMIT TE
TERRITORIT

Ark.DODE ZHUBA

Ing.ADIONA MARTINI

Ing.GJOVALIN MARKU

Ing.GJON LUCA

Ing.ALBAN LAÇI

Project Name and Address

SISTEMIM, ASFALTIM I RRUGES AZEM
HAJDARI

Project
PLANIMETRIA

Date
JANAR 2019

Scale
1:500

Sheet

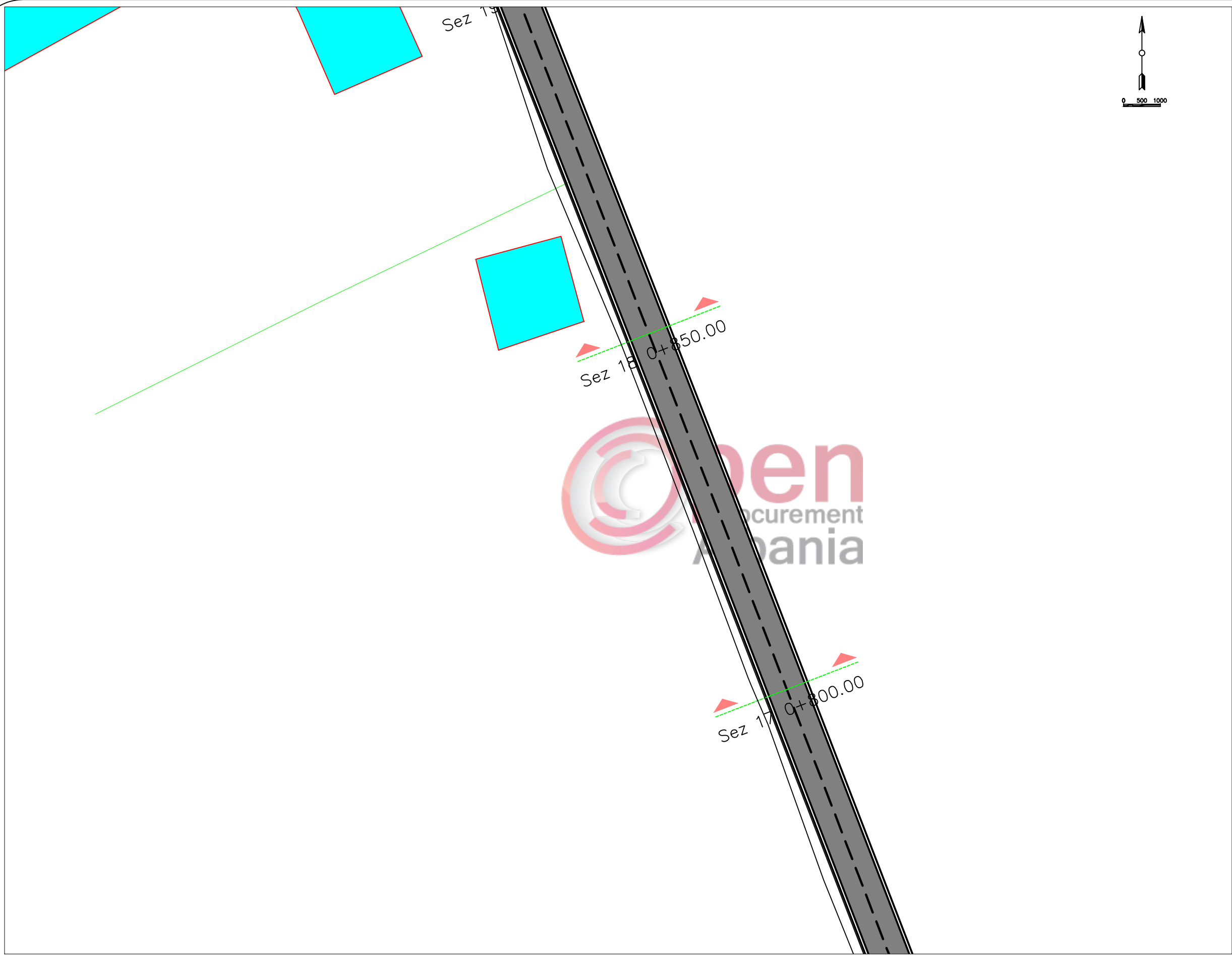



REPUBLIKA E SHQIPËRISE
BASHKIA LEZHE
 PROJEKT ZBATIMI
 SISTEMIM, ASFALTIM RRUGA AZEM
 HAJDARI

BASHKIA LEZHE
 DREJTORIA E PLANIFIKIMI
 DHE ZHVILLIMIT TE
 TERRITORIT

Ark.DODE ZHUBA	
Ing.ADIONA MARTINI	
Ing.GJOVALIN MARKU	
Ing.GJON LUCA	
Ing.ALBAN LAÇI	

SISTEMIM, ASFALTIM I RRUGES AZEM
 HAJDARI

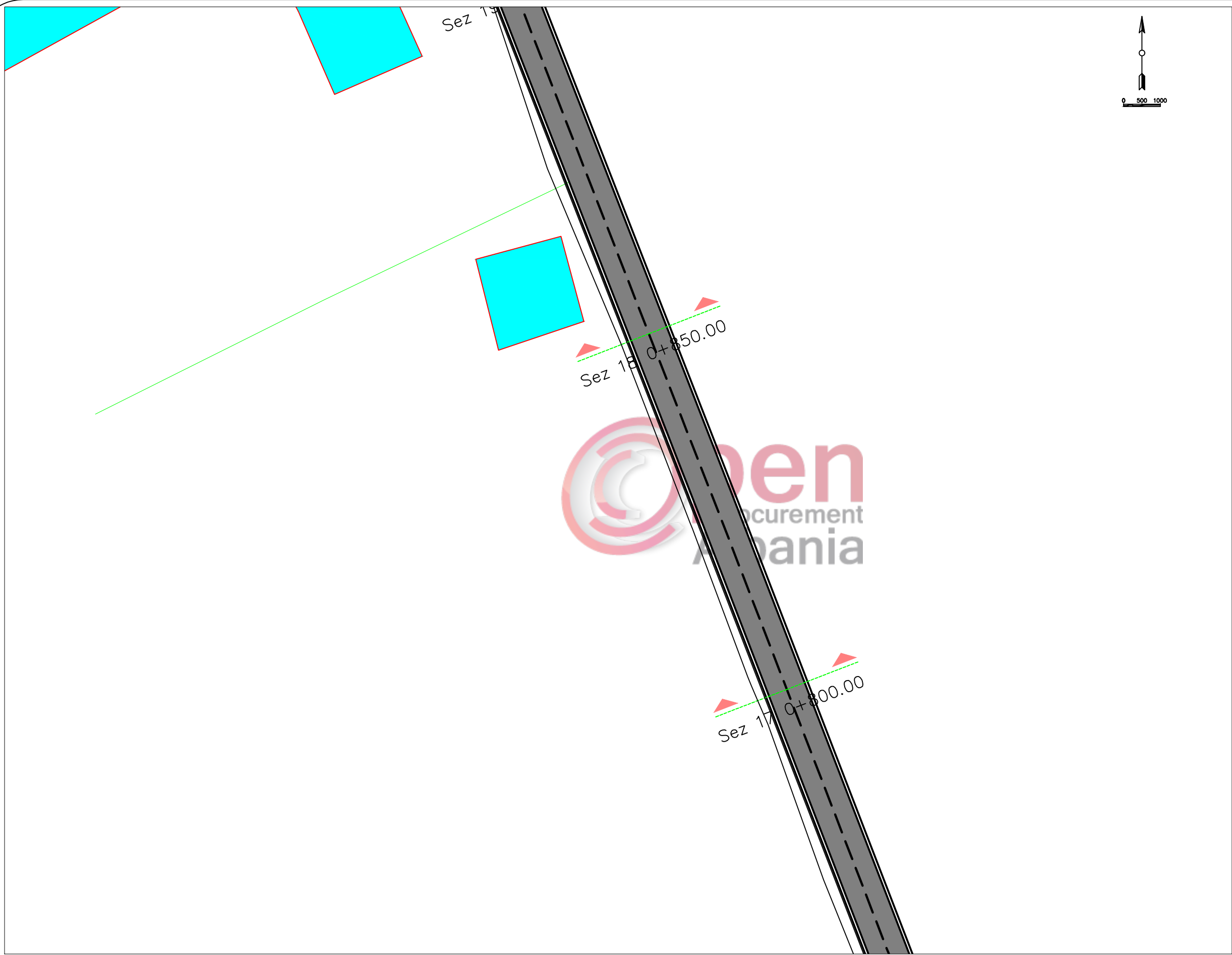
Project PLANIMETRIA	Sheet
Date JANAR 2019	
Scale 1:500	





REPUBLIKA E SHQIPËRISE
BASHKIA LEZHE
 PROJEKT ZBATIMI
 SISTEMIM, ASFALTIM RRUGA AZEM
 HAJDARI

BASHKIA LEZHE
 DREJTORIA E PLANIFIKIMI
 DHE ZHVILLIMIT TE
 TERRITORIT

Ark.DODE ZHUBA	
Ing.ADIONA MARTINI	
Ing.GJOVALIN MARKU	
Ing.GJON LUCA	
Ing.ALBAN LAÇI	

Project Name and Address
 SISTEMIM, ASFALTIM I RRUGES AZEM
 HAJDARI

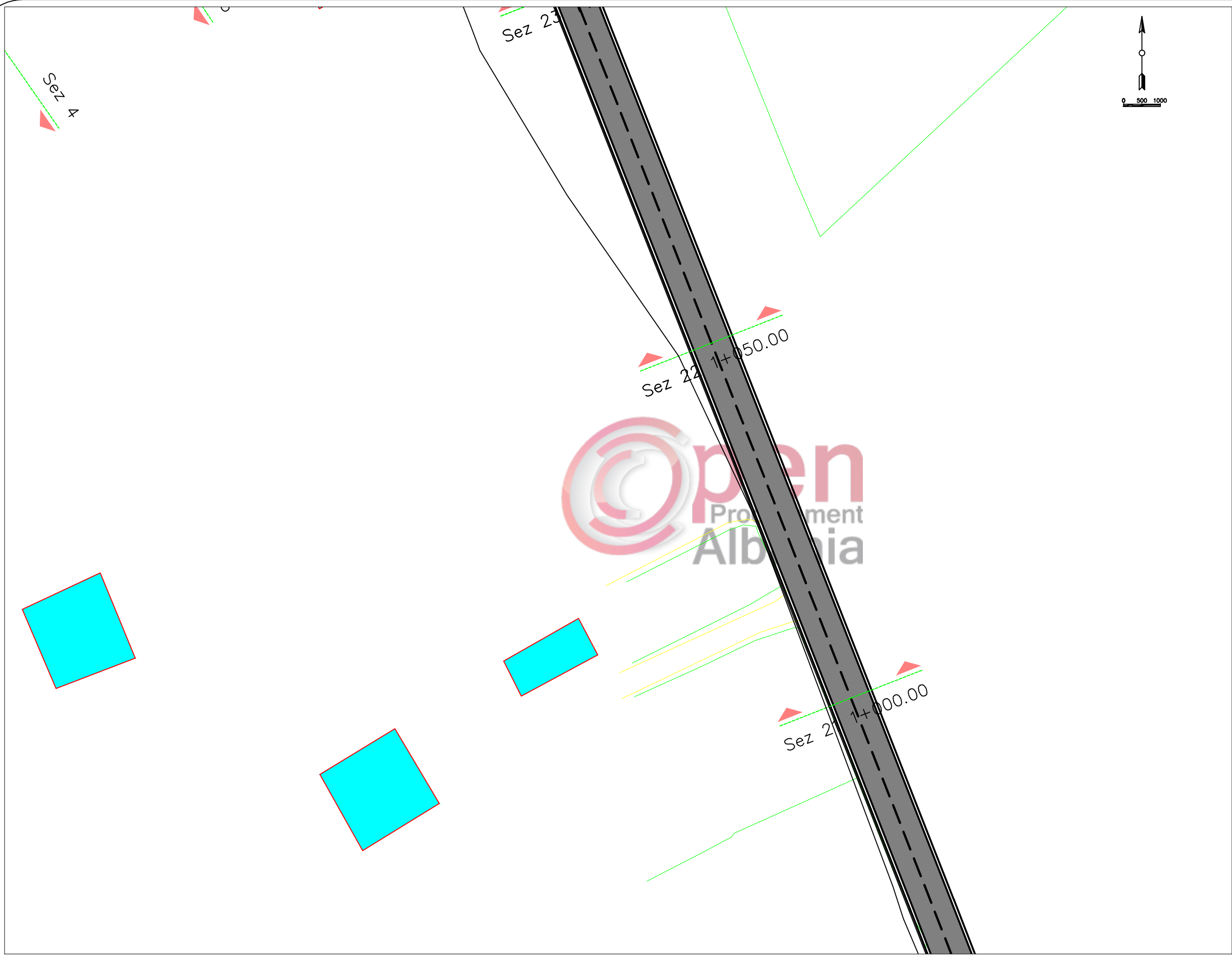
Project PLANIMETRIA	Sheet
Date JANAR 2019	
Scale 1:500	





REPUBLIKA E SHQIPËRISE
BASHKIA LEZHE
 PROJEKT ZBATIMI
 SISTEMIM, ASFALTIM RRUGA AZEM
 HAJDARI

BASHKIA LEZHE
 DREJTORIA E PLANIFIKIMI
 DHE ZHVILLIMIT TE
 TERRITORIT

Ark.DODE ZHUBA	
Ing.ADIONA MARTINI	
Ing.GJOVALIN MARKU	
Ing.GJON LUCA	
Ing.ALBAN LAÇI	

Project Name and Address
 SISTEMIM, ASFALTIM I RRUGES AZEM
 HAJDARI

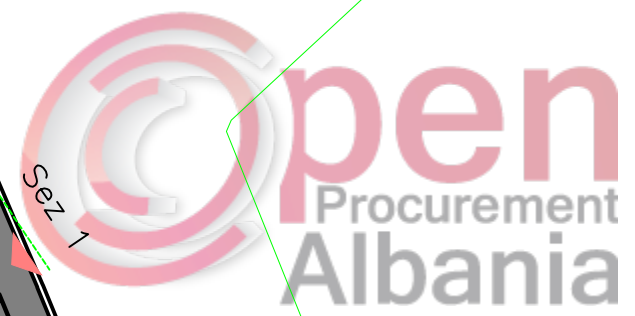
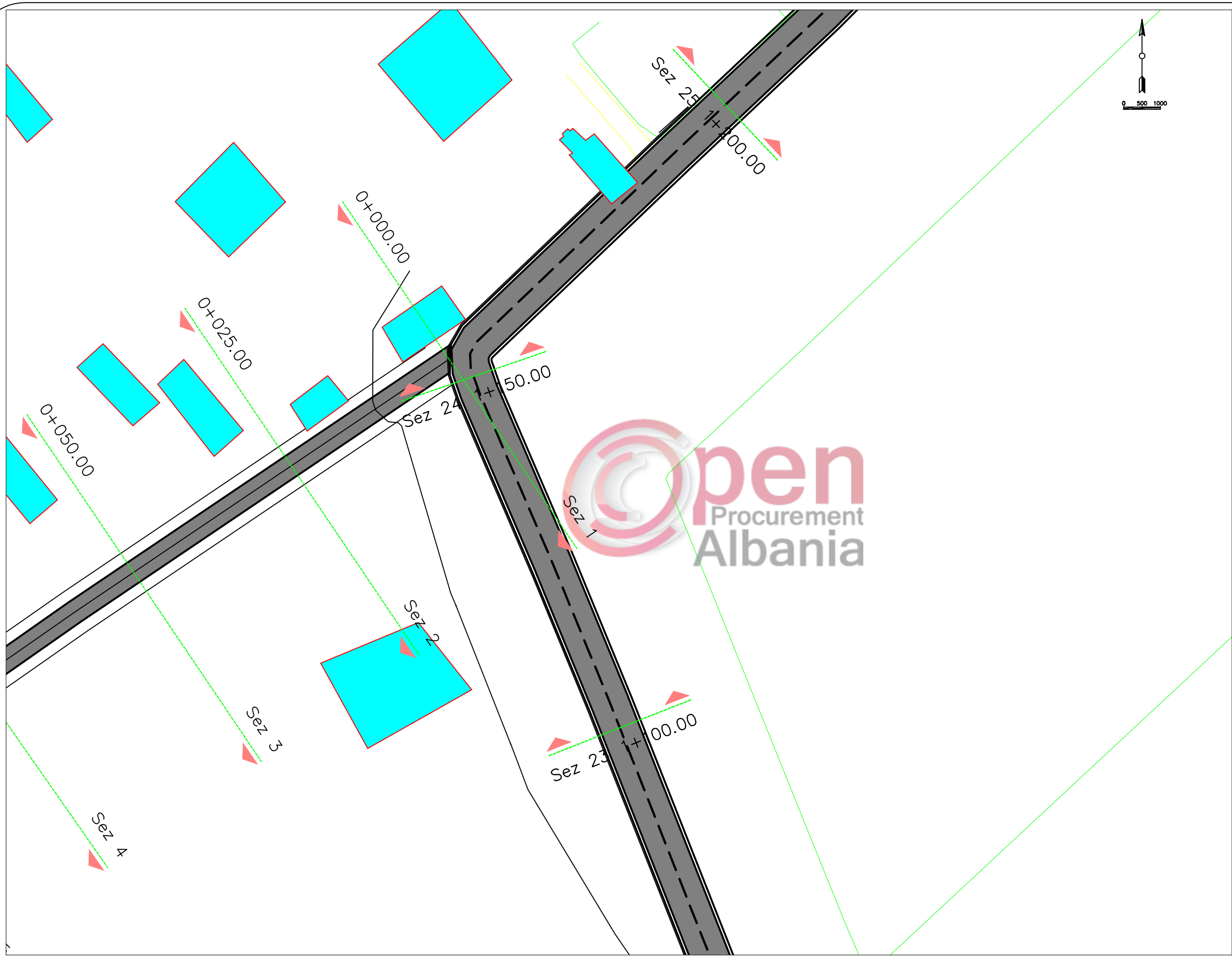
Project PLANIMETRIA	Sheet
Date JANAR 2019	
Scale 1:500	



REPUBLIKA E SHQIPËRISE
BASHKIA LEZHE
 PROJEKT ZBATIMI
 SISTEMIM, ASFALTIM RRUGA AZEM
 HAJDARI

Firm Name and Address

BASHKIA LEZHE
 DREJTORIA E PLANIFIKIMI
 DHE ZHVILLIMIT TE
 TERRITORIT

Ark.DODE ZHUBA	
Ing.ADIONA MARTINI	
Ing.GJOVALIN MARKU	
Ing.GJON LUCA	
Ing.ALBAN LAÇI	

Project Name and Address
 SISTEMIM, ASFALTIM I RRUGES AZEM
 HAJDARI

Project PLANIMETRIA	Sheet
Date JANAR 2019	
Scale 1:500	

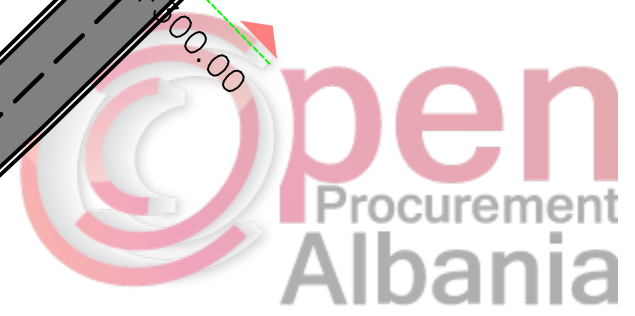
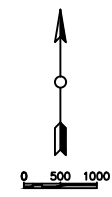
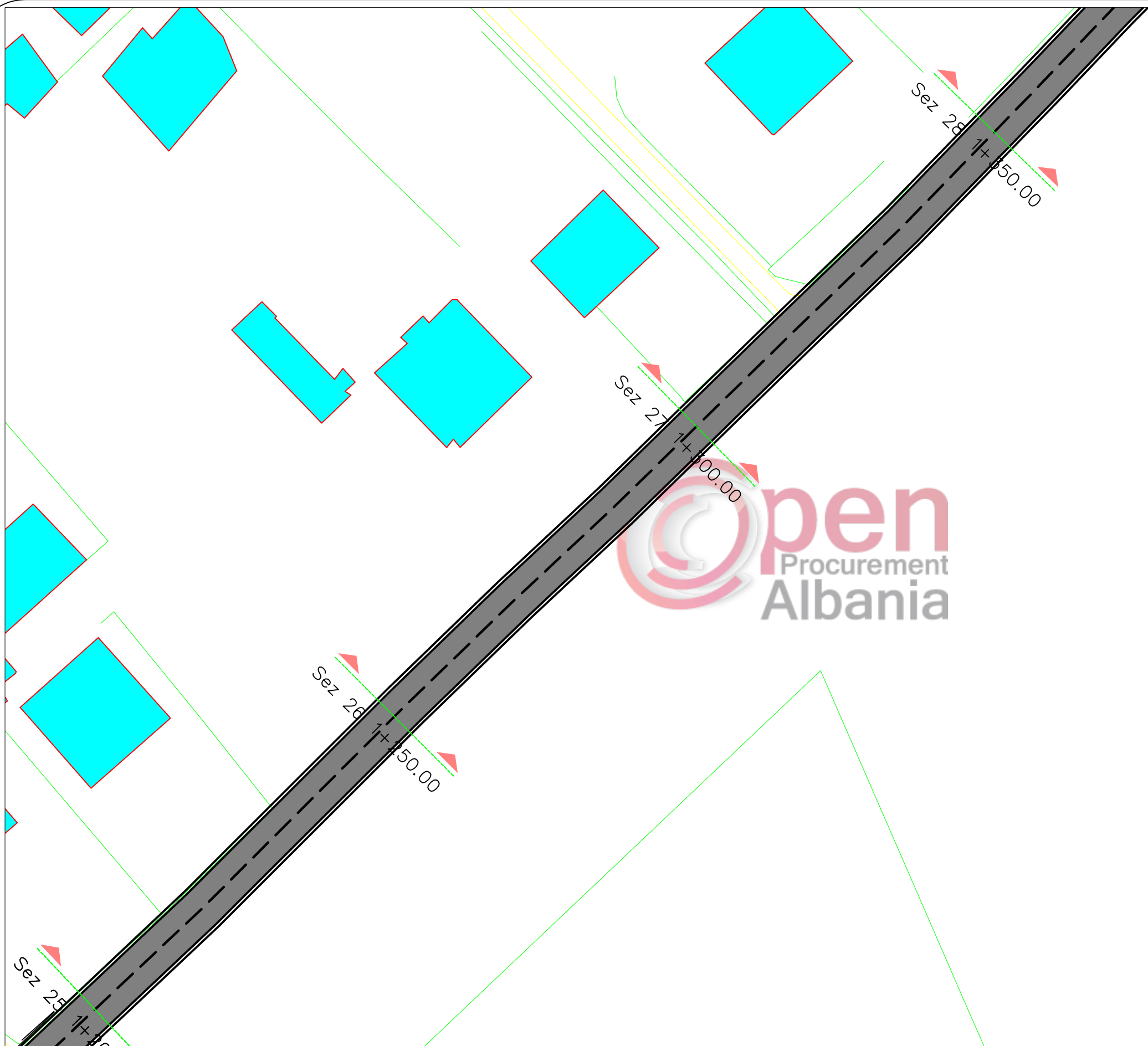

REPUBLIKA E SHQIPËRISE
BASHKIA LEZHE
 PROJEKT ZBATIMI
 SISTEMIM, ASFALTIM RRUGA AZEM
 HAJDARI

Firm Name and Address



BASHKIA LEZHE
 DREJTORIA E PLANIFIKIMI
 DHE ZHVILLIMIT TE
 TERRITORIT

Ark.DODE ZHUBA	
Ing.ADIONA MARTINI	
Ing.GJOVALIN MARKU	
Ing.GJON LUCA	
Ing.ALBAN LAÇI	

Project Name and Address

SISTEMIM, ASFALTIM I RRUGES AZEM
HAJDARI

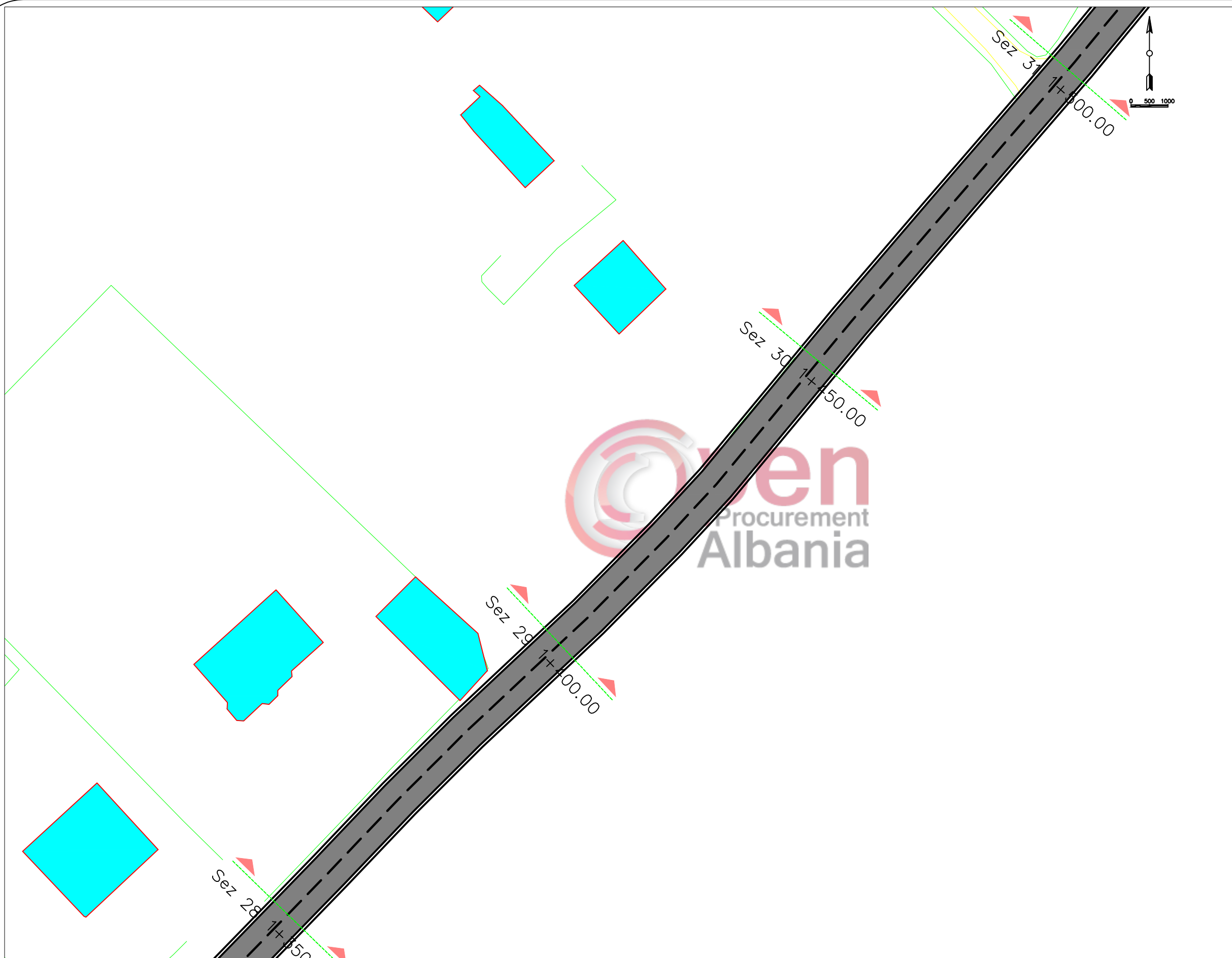
Project PLANIMETRIA	Sheet
Date JANAR 2019	
Scale 1:500	



REPUBLIKA E SHQIPËRISE
BASHKIA LEZHE
 PROJEKT ZBATIMI
 SISTEMIM, ASFALTIM RRUGA AZEM
 HAJDARI

Firm Name and Address

BASHKIA LEZHE
 DREJTORIA E PLANIFIKIMI
 DHE ZHVILLIMIT TE
 TERRITORIT

Ark.DODE ZHUBA	
Ing.ADIONA MARTINI	
Ing.GJOVALIN MARKU	
Ing.GJON LUCA	
Ing.ALBAN LAÇI	

Project Name and Address
 SISTEMIM, ASFALTIM I RRUGES AZEM
 HAJDARI

Project PLANIMETRIA	Sheet
Date JANAR 2019	
Scale 1:500	

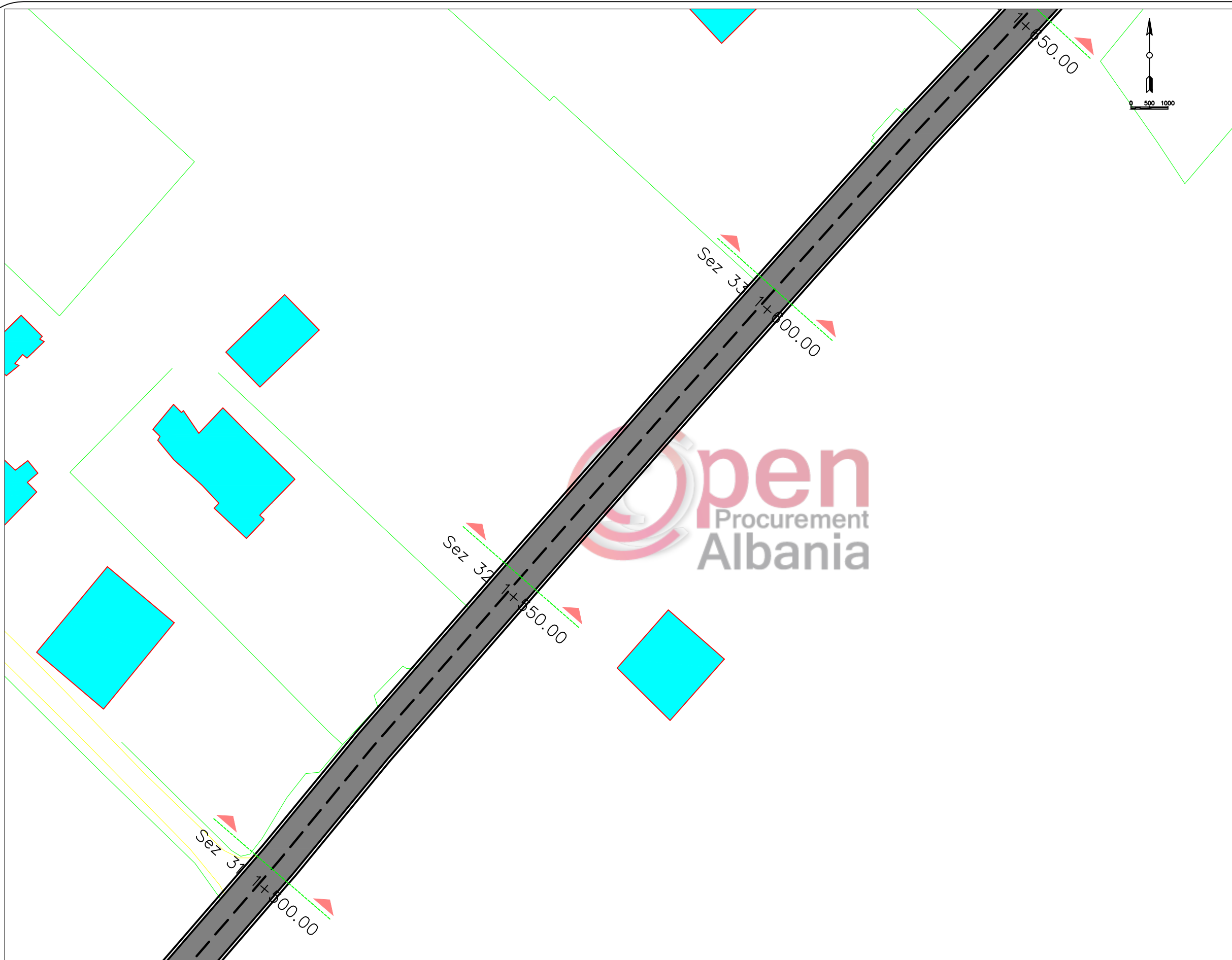

REPUBLIKA E SHQIPËRISE
BASHKIA LEZHE
 PROJEKT ZBATIMI
 SISTEMIM, ASFALTIM RRUGA AZEM
 HAJDARI

Firm Name and Address

BASHKIA LEZHE
 DREJTORIA E PLANIFIKIMI
 DHE ZHVILLIMIT TE
 TERRITORIT

Ark.DODE ZHUBA	
Ing.ADIONA MARTINI	
Ing.GJOVALIN MARKU	
Ing.GJON LUCA	
Ing.ALBAN LAÇI	

Project Name and Address
 SISTEMIM, ASFALTIM I RRUGES AZEM
 HAJDARI

<small>Project</small> PLANIMETRIA	<small>Sheet</small>
<small>Date</small> JANAR 2019	
<small>Scale</small> 1:500	

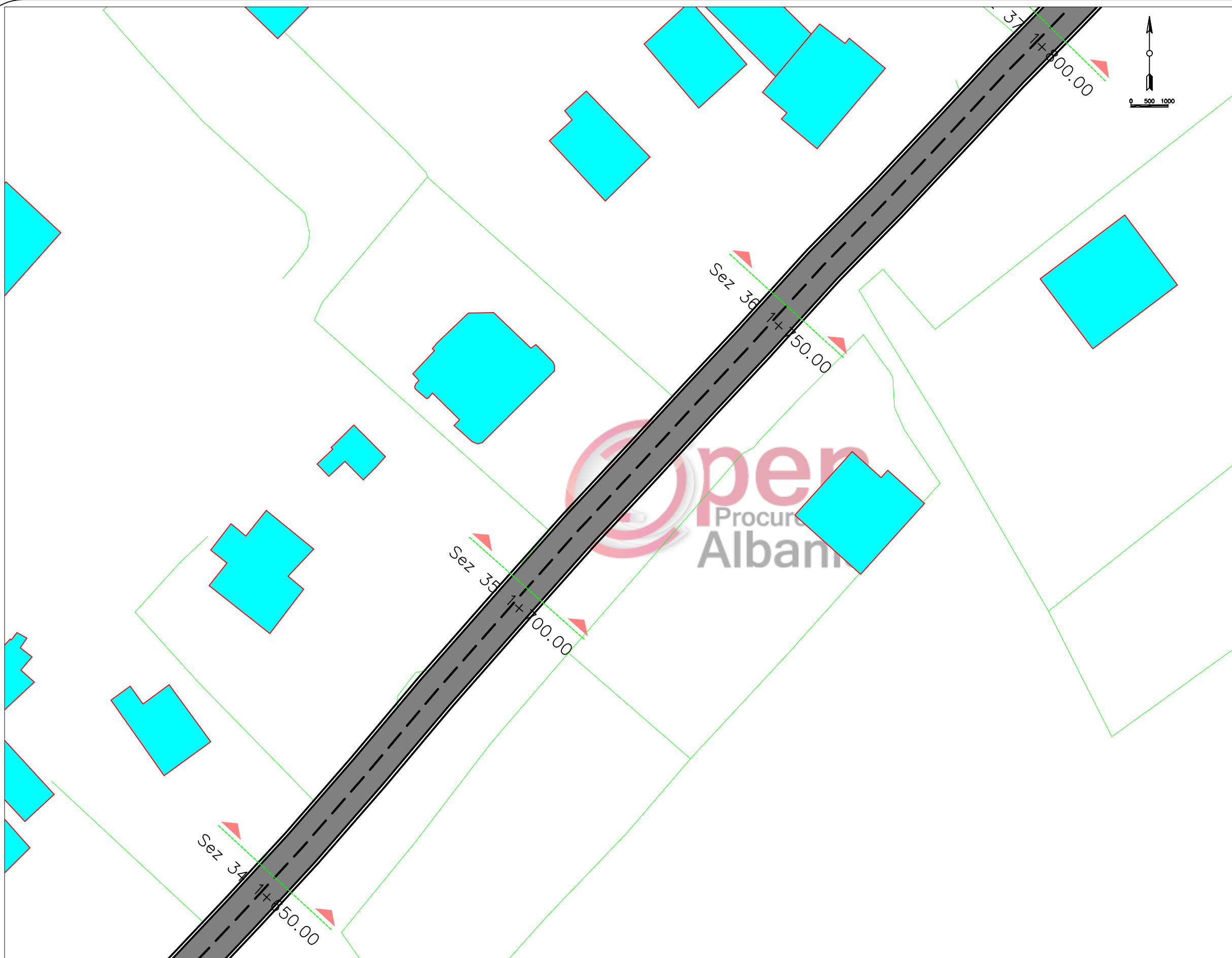



REPUBLIKA E SHQIPËRISE
BASHKIA LEZHE
 PROJEKT ZBATIMI
 SISTEMIM, ASFALTIM RRUGA AZEM
 HAJDARI

Firm Name and Address

BASHKIA LEZHE
 DREJTORIA E PLANIFIKIMI
 DHE ZHVILLIMIT TE
 TERRITORIT

Ark.DODE ZHUBA	
Ing.ADIONA MARTINI	
Ing.GJOVALIN MARKU	
Ing.GJON LUCA	
Ing.ALBAN LAÇI	

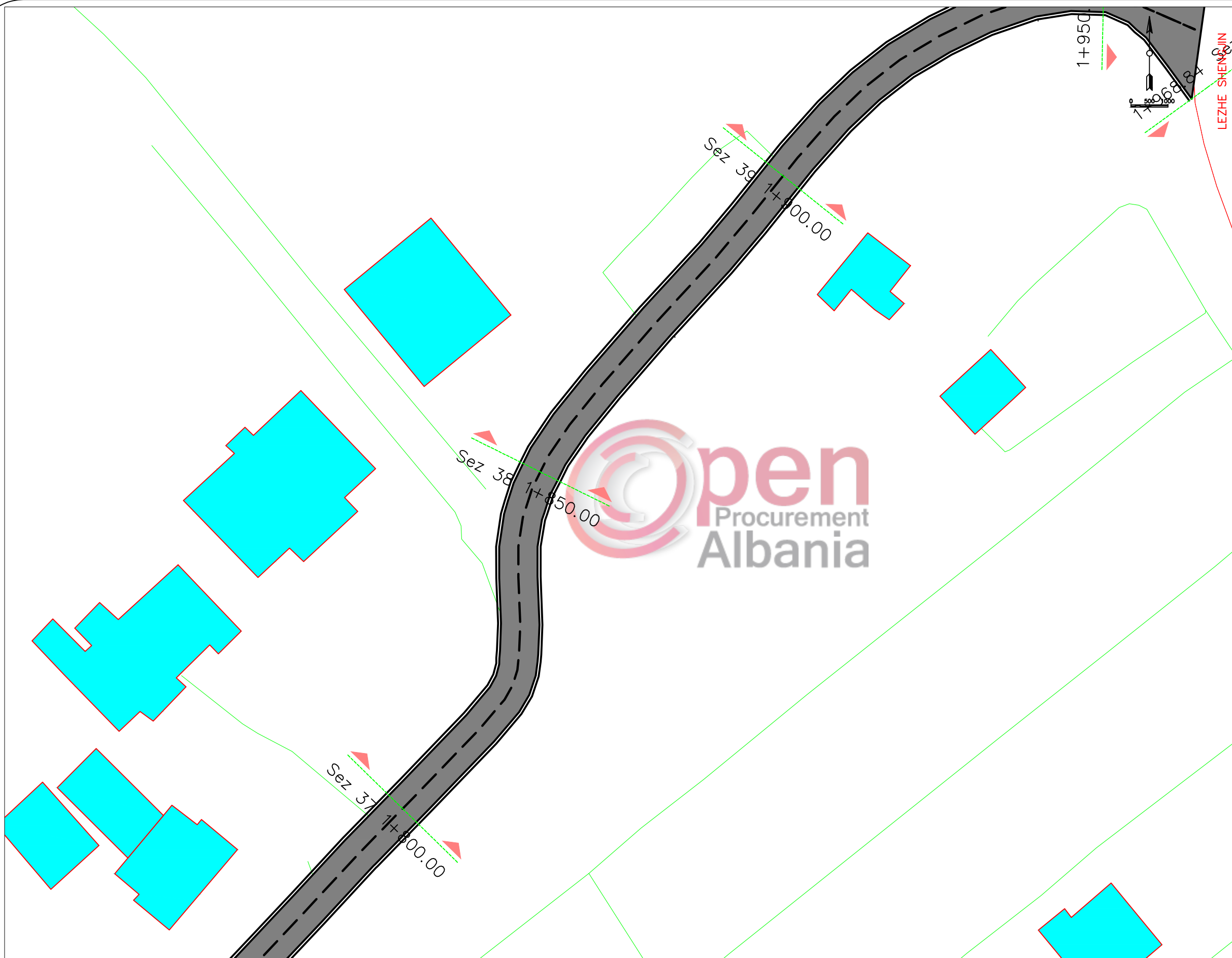
Project Name and Address
 SISTEMIM, ASFALTIM I RRUGES AZEM
 HAJDARI

<small>Project</small> PLANIMETRIA	<small>Sheet</small>
<small>Date</small> JANAR 2019	
<small>Scale</small> 1:500	



REPUBLIKA E SHQIPËRISE
BASHKIA LEZHE
 PROJEKT ZBATIMI
 SISTEMIM, ASFALTIM RRUGA AZEM
 HAJDARI

Firm Name and Address

BASHKIA LEZHE
 DREJTORIA E PLANIFIKIMI
 DHE ZHVILLIMIT TE
 TERRITORIT

Ark.DODE ZHUBA	
Ing.ADIONA MARTINI	
Ing.GJOVALIN MARKU	
Ing.GJON LUCA	
Ing.ALBAN LAÇI	

Project Name and Address
 SISTEMIM, ASFALTIM I RRUGES AZEM
 HAJDARI

Project PLANIMETRIA	Sheet
Date JANAR 2019	
Scale 1:500	

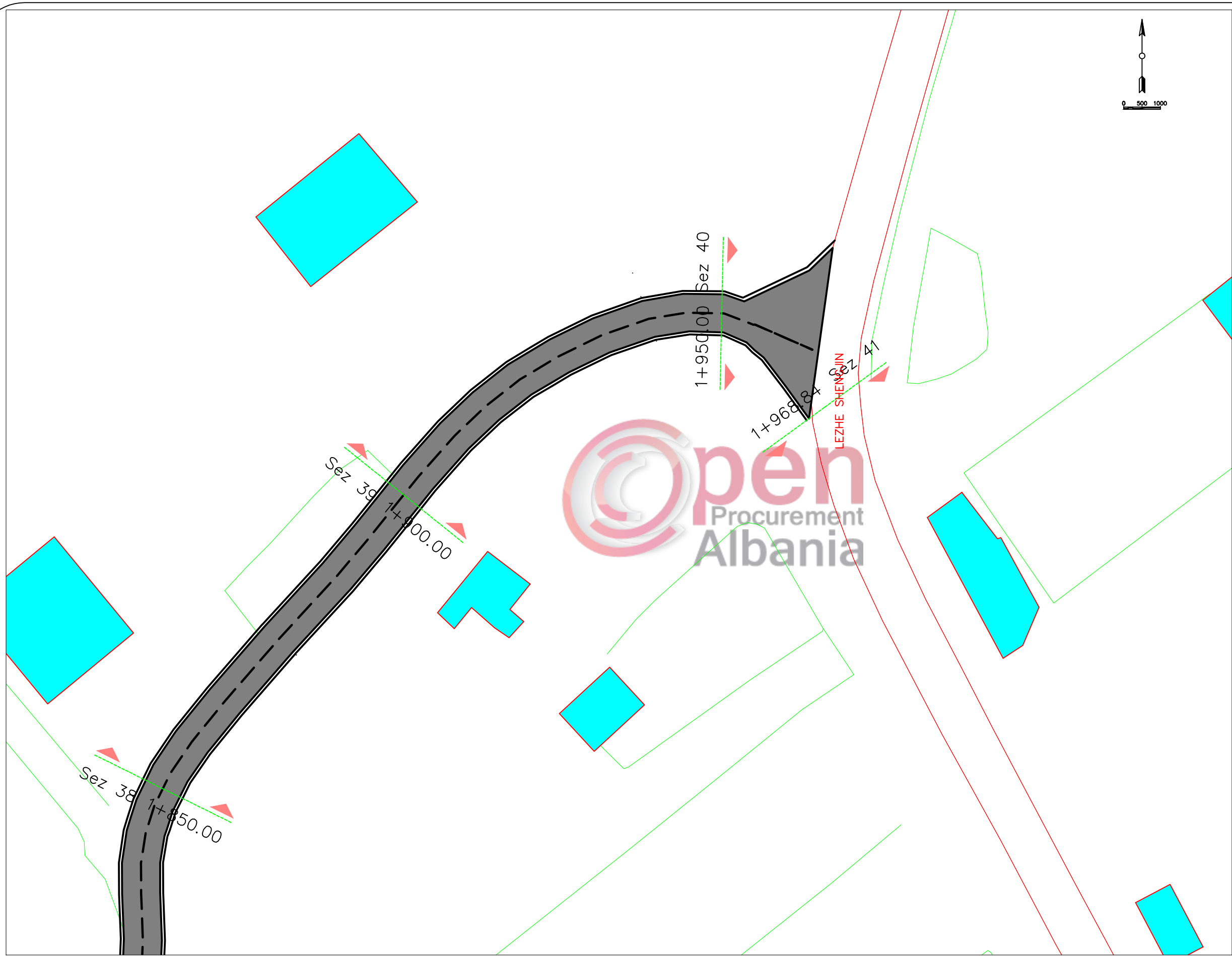

REPUBLIKA E SHQIPËRISE
BASHKIA LEZHE
 PROJEKT ZBATIMI
 SISTEMIM, ASFALTIM RRUGA AZEM
 HAJDARI

Firm Name and Address

BASHKIA LEZHE
 DREJTORIA E PLANIFIKIMI
 DHE ZHVILLIMIT TE
 TERRITORIT

Ark.DODE ZHUBA	
Ing.ADIONA MARTINI	
Ing.GJOVALIN MARKU	
Ing.GJON LUCA	
Ing.ALBAN LAÇI	

Project Name and Address
 SISTEMIM, ASFALTIM I RRUGES AZEM
 HAJDARI

Project PLANIMETRIA	Sheet
Date JANAR 2019	
Scale 1:500	

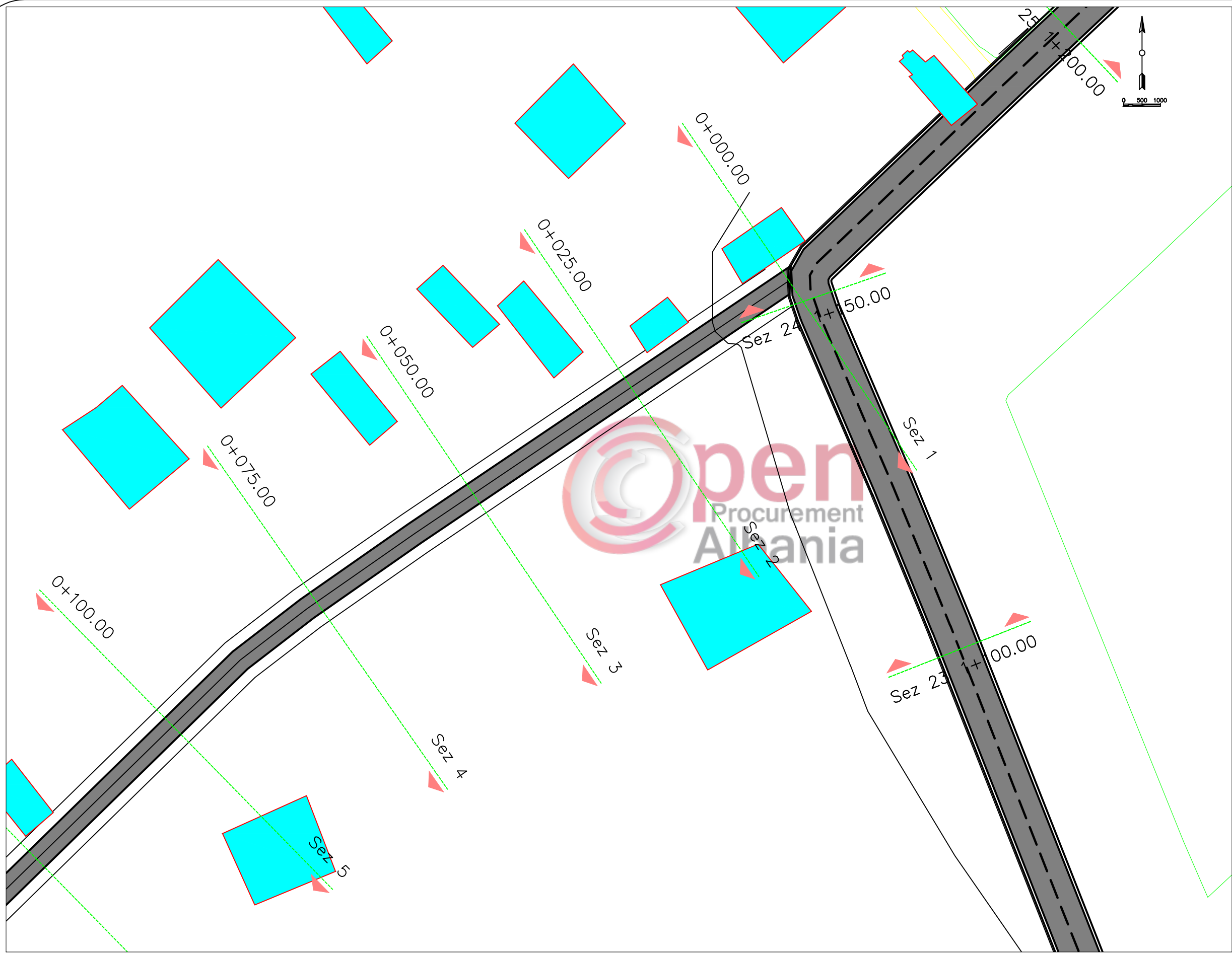

 REPUBLIKA E SHQIPËRISE
 BASHKIA LEZHE
 PROJEKT ZBATIMI
 SISTEMIM, ASFALTIM RRUGA AZEM
 HAJDARI

Firm Name and Address

 BASHKIA LEZHE
 DREJTORIA E PLANIFIKIMI
 DHE ZHVILLIMIT TE
 TERRITORIT

Ark.DODE ZHUBA	
Ing.ADIONA MARTINI	
Ing.GJOVALIN MARKU	
Ing.GJON LUCA	
Ing.ALBAN LAÇI	

Project Name and Address

SISTEMIM, ASFALTIM I RRUGES AZEM HAJDARI

Project PLANIMETRIA	Sheet
Date JANAR 2019	
Scale 1:500	



Open
Procurement
Albania

 REPUBLIKA E SHQIPËRISE
 BASHKIA LEZHE
 PROJEKT ZBATIMI
 SISTEMIM, ASFALTIM RRUGA AZEM
 HAJDARI

Firm Name and Address

 BASHKIA LEZHE
 DREJTORIA E PLANIFIKIMI
 DHE ZHVILLIMIT TE
 TERRITORIT

Ark.DODE ZHUBA	
Ing.ADIONA MARTINI	
Ing.GJOVALIN MARKU	
Ing.GJON LUCA	
Ing.ALBAN LAÇI	

Project Name and Address
 SISTEMIM, ASFALTIM I RRUGES AZEM
 HAJDARI

Project PLANIMETRIA	Sheet
Date JANAR 2019	
Scale 1:500	



REPUBLIKA E SHQIPËRISE
BASHKIA LEZHE
 PROJEKT ZBATIMI
 SISTEMIM, ASFALTIM RRUGA AZEM
 HAJDARI

Firm Name and Address

BASHKIA LEZHE
 DREJTORIA E PLANIFIKIMI
 DHE ZHVILLIMIT TE
 TERRITORIT

Ark.DODE ZHUBA	
Ing.ADIONA MARTINI	
Ing.GJOVALIN MARKU	
Ing.GJON LUCA	
Ing.ALBAN LAÇI	

Project Name and Address
 SISTEMIM, ASFALTIM I RRUGES AZEM
 HAJDARI

Project PLANIMETRIA	Sheet
Date JANAR 2019	
Scale 1:500	

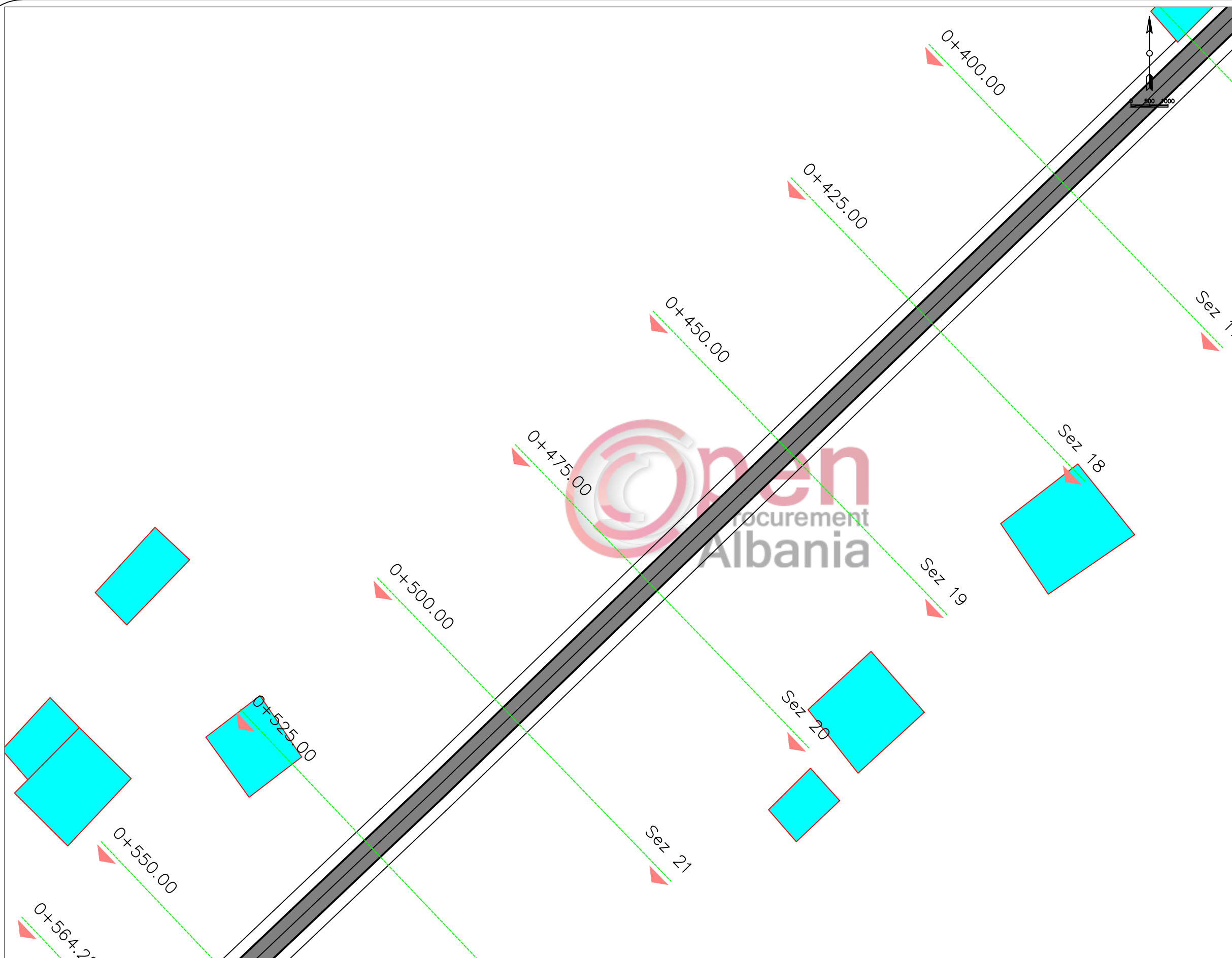

 REPUBLIKA E SHQIPËRISE
 BASHKIA LEZHE
 PROJEKT ZBATIMI
 SISTEMIM, ASFALTIM RRUGA AZEM
 HAJDARI

Firm Name and Address

 BASHKIA LEZHE
 DREJTORIA E PLANIFIKIMI
 DHE ZHVILLIMIT TE
 TERRITORIT

Ark.DODE ZHUBA	
Ing.ADIONA MARTINI	
Ing.GJOVALIN MARKU	
Ing.GJON LUCA	
Ing.ALBAN LAÇI	

Project Name and Address
 SISTEMIM, ASFALTIM I RRUGES AZEM
 HAJDARI

Project PLANIMETRIA	Sheet
Date JANAR 2019	
Scale 1:500	

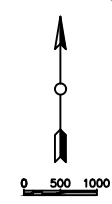
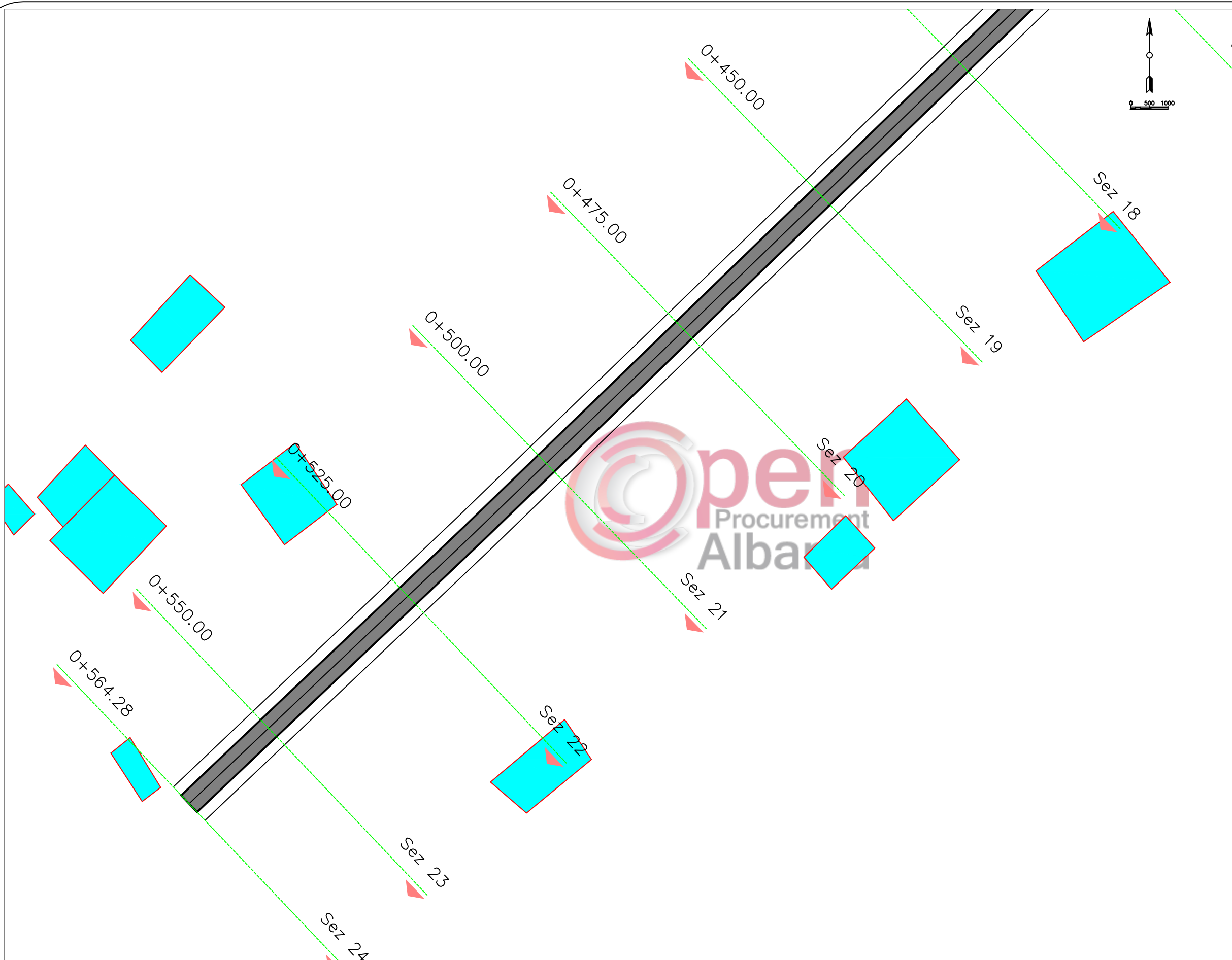

 REPUBLIKA E SHQIPËRISE
 BASHKIA LEZHE
 PROJEKT ZBATIMI
 SISTEMIM, ASFALTIM RRUGA AZEM
 HAJDARI

Firm Name and Address

 BASHKIA LEZHE
 DREJTORIA E PLANIFIKIMI
 DHE ZHVILLIMIT TE
 TERRITORIT

Ark.DODE ZHUBA	
Ing.ADIONA MARTINI	
Ing.GJOVALIN MARKU	
Ing.GJON LUCA	
Ing.ALBAN LAÇI	

Project Name and Address
 SISTEMIM, ASFALTIM I RRUGES AZEM
 HAJDARI

Project PLANIMETRIA	Sheet
Date JANAR 2019	
Scale 1:500	

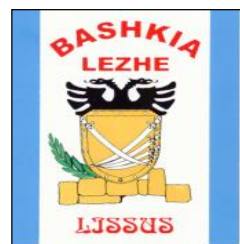

BASHKIA LEZHE

PROJEKT - ZBATIMI

OBJEKTI: SISTEMIM, ASFALTIM I RRUGES AZEM HAJDARI

 **PROFILAT TIP**

PROJEKTUES:

BASHKIA LEZHE

SEKSION TERTHOR TIP 1 Sh. 1:50

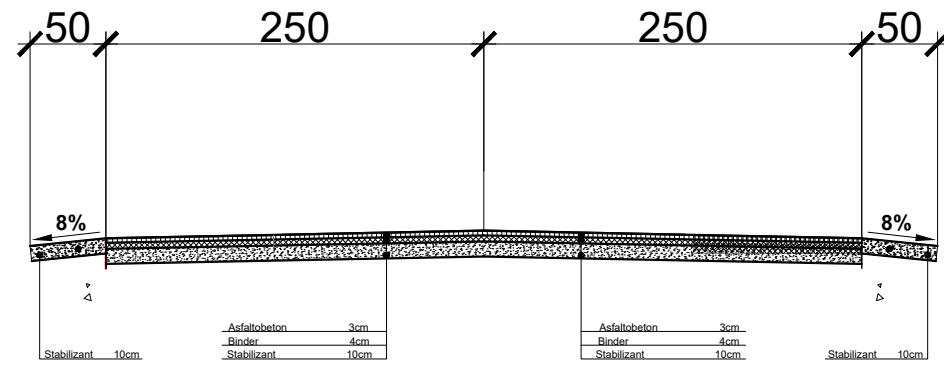

SEKSION TERTHOR TIP 2 Sh. 1:50

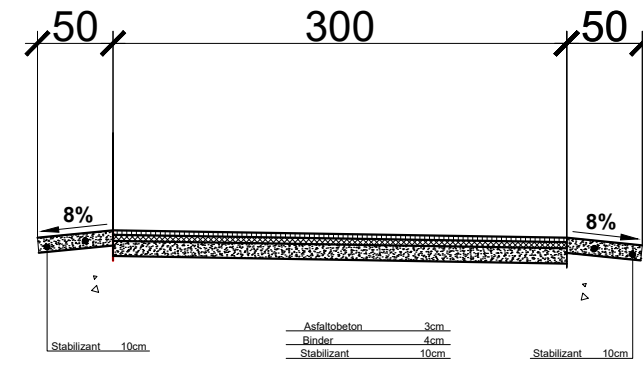

SEKSION TERTHOR TIP 2 Sh. 1:100

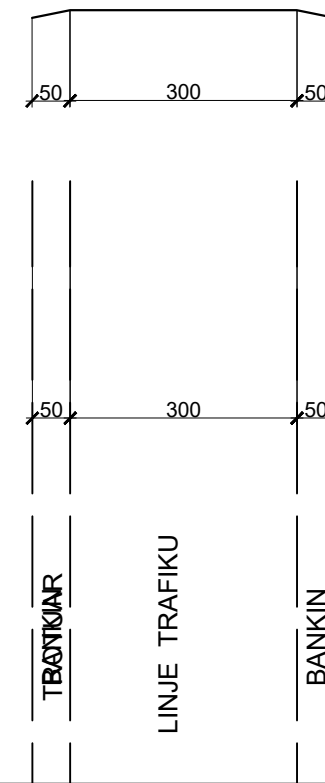
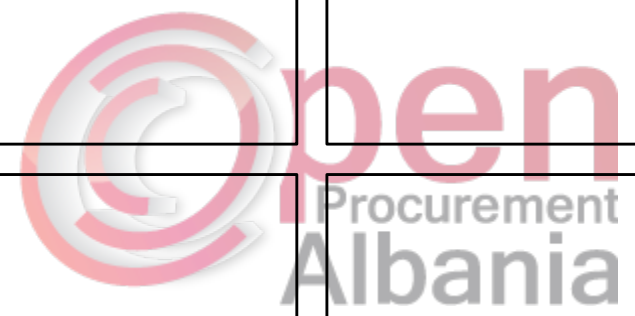
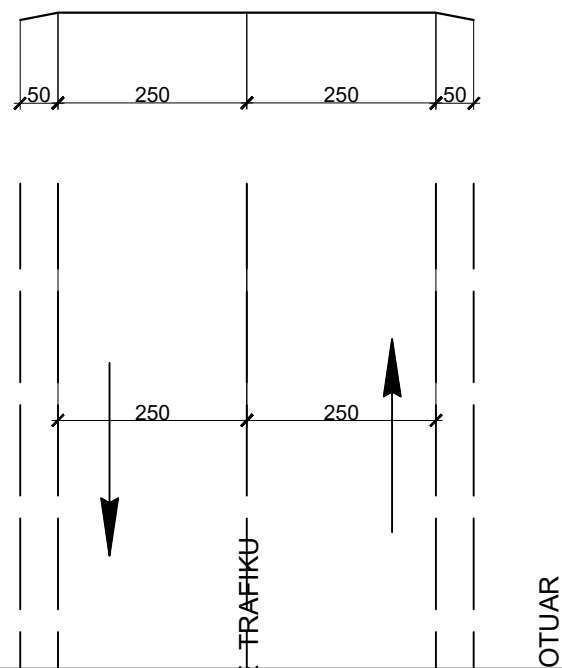

REPUBLIKA E SHQIPERISE
BASHKIA LEZHE



PROJEKT ZBATIM
JANAR 2019

SITEMIM ASFALTIM
"RRUGA E AZEM HAJDARI"
SEKSIONE TERTHORE TIP
DHE DETAJE SH. 1:50
SH. 1:100

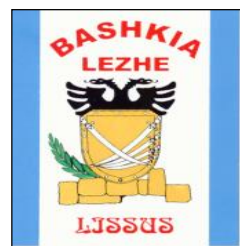

BASHKIA LEZHE

PROJEKT - ZBATIMI

OBJEKTI: SISTEMIM, ASFALTIM I RRUGES AZEM HAJDARI

PROFILI GJATESOR

PROJEKTUES:

BASHKIA LEZHE

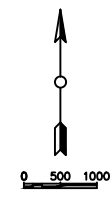

REPUBLIKA E SHQIPËRISE
BASHKIA LEZHE
 PROJEKT ZBATIMI
 SISTEMIM, ASFALTIM RRUGA AZEM
 HAJDARI

Firm Name and Address



BASHKIA LEZHE
 DREJTORIA E PLANIFIKIMI
 DHE ZHVILLIMIT TE
 TERRITORIT

Ark.DODE ZHUBA	
Ing.ADIONA MARTINI	
Ing.GJOVALIN MARKU	
Ing.GJON LUCA	
Ing.ALBAN LAÇI	

Project Name and Address

SISTEMIM, ASFALTIM I RRUGES AZEM
HAJDARI

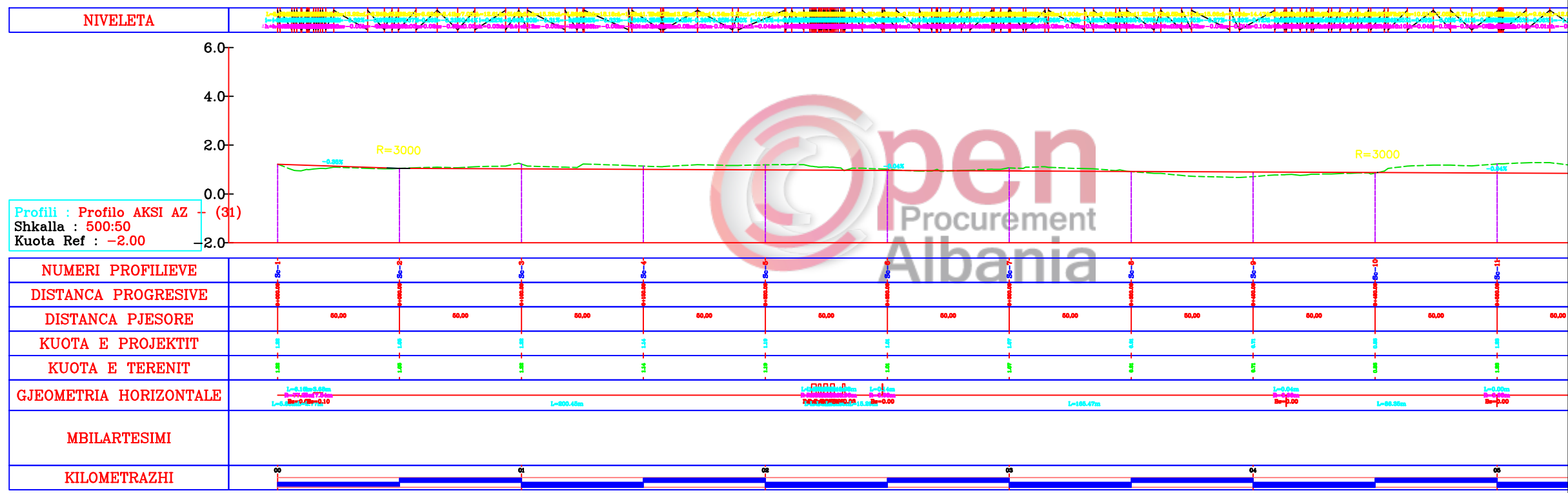
Project	PROFILIGJATESORE	Sheet	
Date	JANAR 2019		1
Scale	1:500		



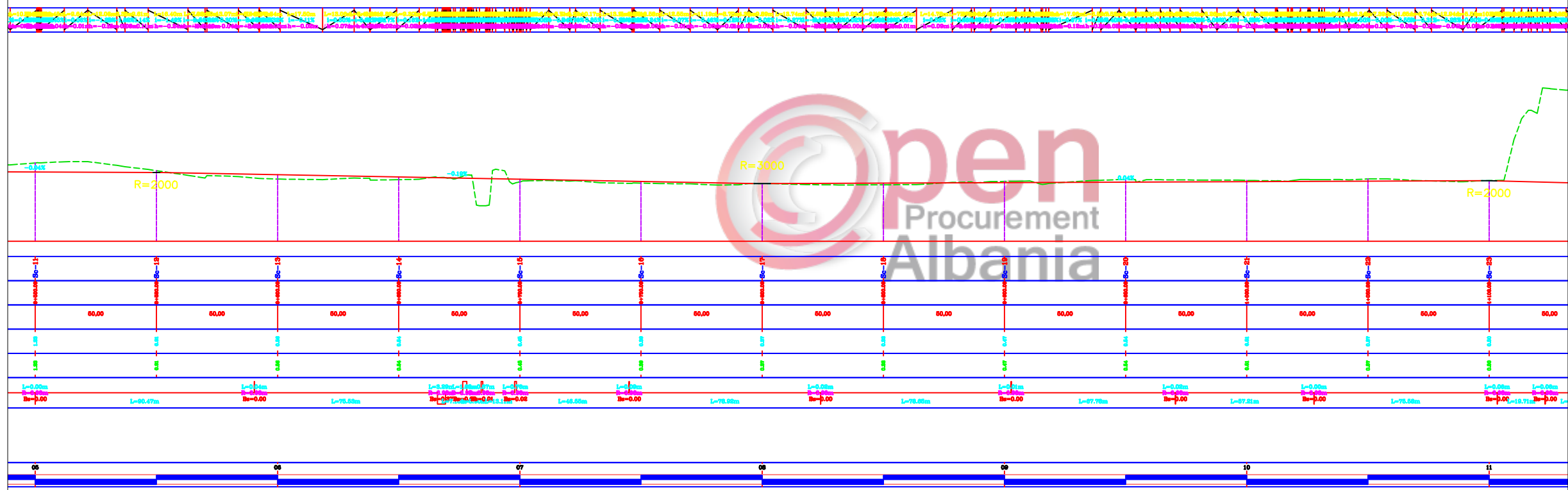
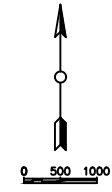

REPUBLIKA E SHQIPËRISE
BASHKIA LEZHE
 PROJEKT ZBATIMI
 SISTEMIM, ASFALTIM RRUGA AZEM
 HAJDARI

Firm Name and Address

BASHKIA LEZHE
 DREJTORIA E PLANIFIKIMI
 DHE ZHVILLIMIT TE
 TERRITORIT

Ark.DODE ZHUBA	
Ing.ADIONA MARTINI	
Ing.GJOVALIN MARKU	
Ing.GJON LUCA	
Ing.ALBAN LAÇI	

Project Name and Address
 SISTEMIM, ASFALTIM I RRUGES AZEM
 HAJDARI

Project PROFILIGJATESORE	Sheet 2
Date JANAR 2019	
Scale 1:500	

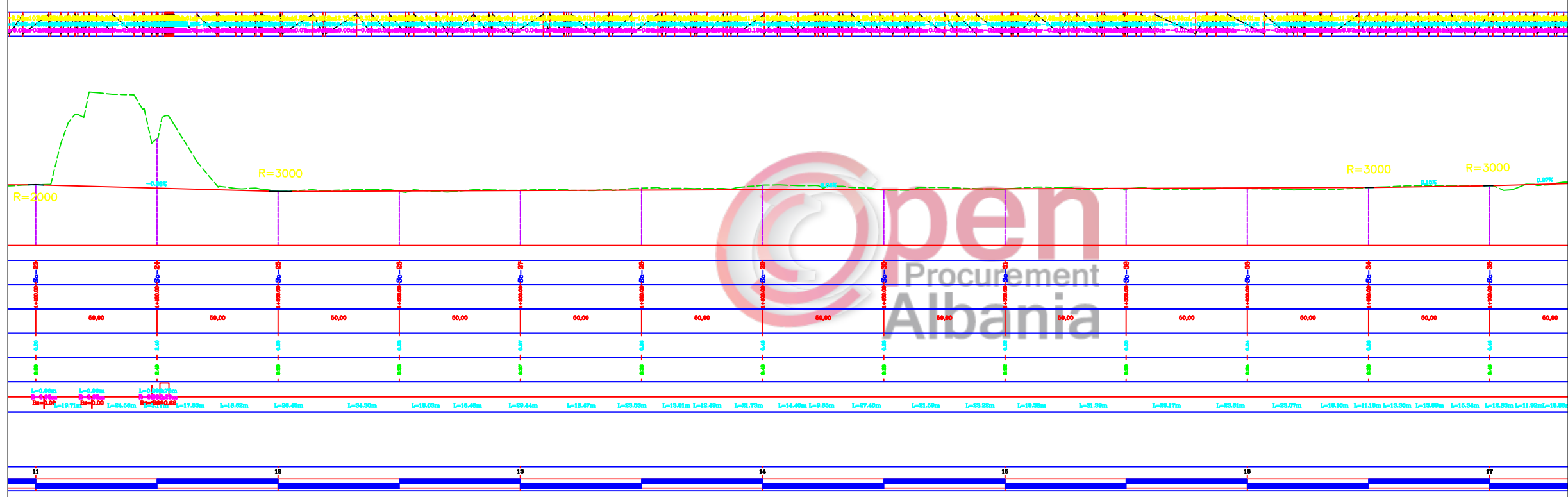
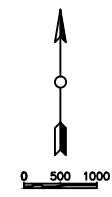

REPUBLIKA E SHQIPËRISE
BASHKIA LEZHE
 PROJEKT ZBATIMI
 SISTEMIM, ASFALTIM RRUGA AZEM
 HAJDARI

Firm Name and Address

BASHKIA LEZHE
 DREJTORIA E PLANIFIKIMI
 DHE ZHVILLIMIT TE
 TERRITORIT

Ark.DODE ZHUBA	
Ing.ADIONA MARTINI	
Ing.GJOVALIN MARKU	
Ing.GJON LUCA	
Ing.ALBAN LAÇI	

Project Name and Address
 SISTEMIM, ASFALTIM I RRUGES AZEM
 HAJDARI

Project PROFILIGJATESORE	Sheet
Date JANAR 2019	2
Scale 1:500	

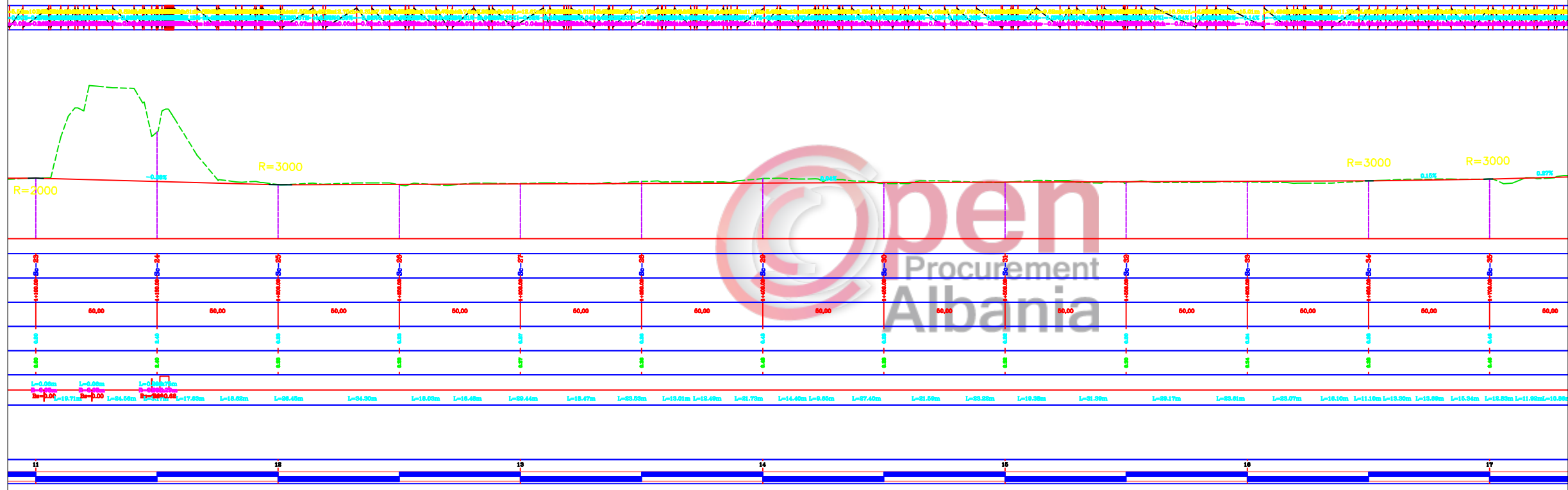
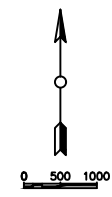

REPUBLIKA E SHQIPËRISE
BASHKIA LEZHE
 PROJEKT ZBATIMI
 SISTEMIM, ASFALTIM RRUGA AZEM
 HAJDARI

Firm Name and Address

BASHKIA LEZHE
 DREJTORIA E PLANIFIKIMI
 DHE ZHVILLIMIT TE
 TERRITORIT

Ark.DODE ZHUBA	
Ing.ADIONA MARTINI	
Ing.GJOVALIN MARKU	
Ing.GJON LUCA	
Ing.ALBAN LAÇI	

Project Name and Address
 SISTEMIM, ASFALTIM I RRUGES AZEM
 HAJDARI

Project PROFILIGJATESORE	Sheet 2
Date JANAR 2019	
Scale 1:500	

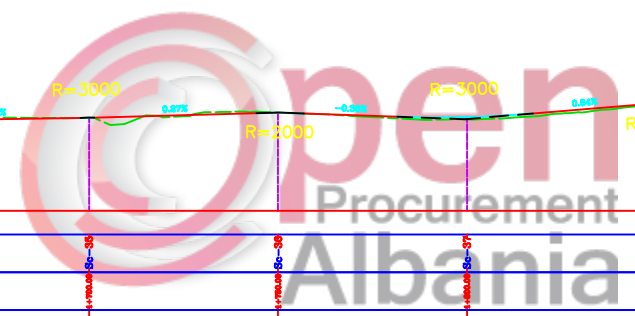
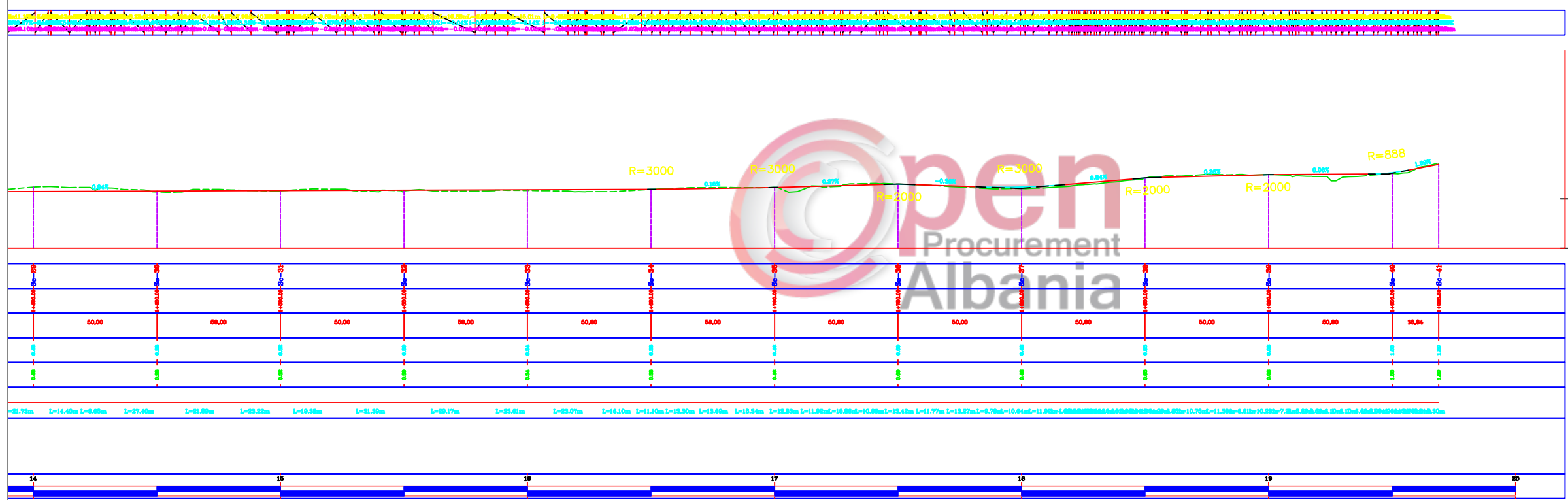
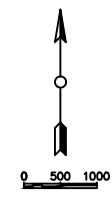

REPUBLIKA E SHQIPËRISE
BASHKIA LEZHE
 PROJEKT ZBATIMI
 SISTEMIM, ASFALTIM RRUGA AZEM
 HAJDARI

Firm Name and Address

BASHKIA LEZHE
 DREJTORIA E PLANIFIKIMI
 DHE ZHVILLIMIT TE
 TERRITORIT

Ark.DODE ZHUBA	
Ing.ADIONA MARTINI	
Ing.GJOVALIN MARKU	
Ing.GJON LUCA	
Ing.ALBAN LAÇI	

Project Name and Address
 SISTEMIM, ASFALTIM I RRUGES AZEM
 HAJDARI

Project PROFILIGJATESORE	Sheet
Date JANAR 2019	2
Scale 1:500	

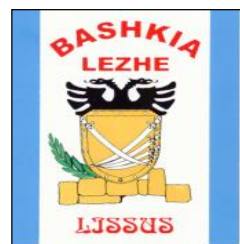

BASHKIA LEZHE

PROJEKT - ZBATIMI

OBJEKTI: SISTEMIM, ASFALTIM I RRUGES AZEM HAJDARI

PROFILAT TERTHORE

PROJEKTUES:

BASHKIA LEZHE

AKSI AZ
1
Progr.: 0+000.00
Scala : 1:500:500
Q.Rif. : -3.50

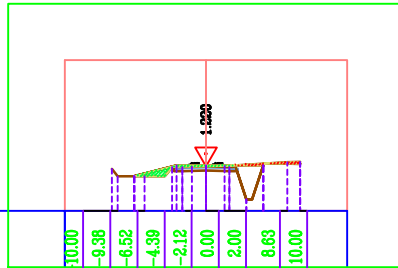

DIST.PROGRES.TERENIT		0.96	0.18	0.18	0.18	0.18	1.20	1.22	1.24	1.66	1.69	10.00
KUOTA TERENIT		0.96	0.18	0.18	0.18	0.18	1.20	1.22	1.24	1.66	1.69	
DIST.PROGRES.PROJEKTIT		-10.00	-9.38	-6.52	-4.39	-2.12	0.00	2.00	8.63	10.00		
KUOTA PROJEKTIT		-10.00	-9.38	-6.52	-4.39	-2.12	0.00	2.00	8.63	10.00		



 REPUBLIKA E SHQIPËRIE
 BASHKIA LEZHE
 PROJEKT ZBATIMI
 SISTEMI ASFALTIM I RRUGES AZEM HAJDARI

Site Name and Address

 BASHKIA LEZHE
 DREJTORIA E PLANIFIKIMIT
 DHE ZHVILLIMIT TE
 TERRITORIT

Ark. DODE ZHUBA	
Ing. ADJONA MARTINI	
Ing. GJOVALIN MARKU	
Ing. GJON LUCA	
Ing. ALBAN LACI	

Wepun seksionet terthore	Sheet
Skala Janar 2019	
Skala 1:500	

AKSI AZ
 Numeri Profil : -2-
 Progresivi : 0+050.00
 Shkalla : 500:500
 Kuota.Referuese : -7.50

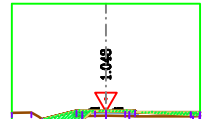

DIST.PROGRES.TERENIT	-1.50	-1.82	-6.66	-5.96	-5.07	-2.73	-1.97	-1.15	0.00	0.97	2.05	9.95	10.00
KUOTA TERENIT	0.91	0.93	0.15	-0.13	0.06	-0.06	0.58	1.06	1.06	1.02	1.02	0.61	0.61
DIST.PJESORE.TERENIT													
DIST.PROGRES.PROJEKTIT	-1.00	-1.82	-6.66	-5.96	-5.07	-2.73	-1.97	-1.42	-1.15	0.00	0.97	2.05	9.95
KUOTA PROJEKTIT	0.91	0.93	0.15	-0.13	0.06	-0.06	0.58	0.99	1.06	1.05	1.02	1.02	0.61
DIST.PJESORE.PROJEKTIT													



 REPUBLIKA E SHQIPËRIE
 BASHKIA LEZHE
 PROJEKT ZBATIMI
 SISTEMI ASFALTIMI RRUGES AZEM HAJDARI

Site Name and Address

 BASHKIA LEZHE
 DREJTORIA E PLANIFIKIMI
 DHE ZHVILLIMIT TE
 TERRITORIT

Ark.DODE ZHUBA	
Ing.AJONA MARTINI	
Ing.GJOVALIN MARKU	
Ing.GJON LUCA	
Ing.ALBAN LACI	

<small>Weges</small> seksionet terthore	<small>Sheet</small>
<small>Scale</small> Janar 2019	
<small>Scale</small> 1:500	

AKSI AZ
 Numeri Profilit : -3-
 Progresivi : 0+100.00
 Shkalla : 500:500
 Kuota.Referuese : -7.50

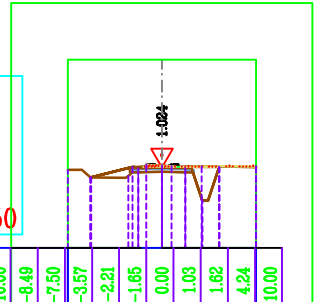

DIST.PROGRES.TERENIT	-10.80	-8.49	-7.50	-3.57	-2.21	-1.65	0.00	1.03	1.62	4.24	10.00
KUOTA TERENIT	0.80	0.81	-0.04	0.13	1.11	1.89	1.22	1.15	1.11	1.16	1.17
DIST.PJESORE.TERENIT											
DIST.PROGRES.PROJEKTI	-10.80	-8.49	-7.50	-3.88	-2.21	-1.65	0.00	1.03	1.35	4.24	10.00
KUOTA PROJEKTI	0.80	0.81	0.23	-0.04	0.13	1.11	1.83	1.22	1.15	1.16	1.17
DIST.PJESORE.PROJEKTI											





REPUBLIKA E SHQIPËRIE
 BASHKIA LEZHE
 PROJEKT ZBATIMI
 SISTEMI ASFALTIM I RRUGES AZEM HAJDARI



BASHKIA LEZHE
 DREJTORIA E PLANIFIKIMI
 DHE ZHVILLIMIT TE
 TERRITORIT

Ark.DODE ZHUBA	
Ing.AJONA MARTINI	
Ing.GJOVALIN MARKU	
Ing.GJON LUCA	
Ing.ALBAN LACI	

Projekti seksionet terthore	Rruga
Date: Janar 2019	
Skala: 1:500	

AKSI AZ
 Numeri Profil : -4-
 Progresivi : 0+150.00
 Shkalla : 500:500
 Kuota.Referuese : -7.50

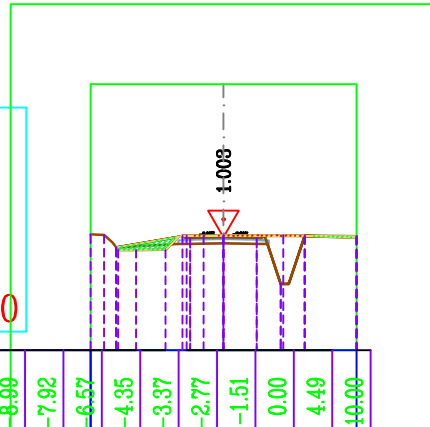

DIST.PROGRES.TERENIT	-10.00	-8.99	-7.92	-6.57	-4.35	-3.37	-2.77	-1.51	0.00	4.49	10.00		
KUOTA TERENIT	1.21	1.18	0.03	0.05	0.05	1.05	1.11	1.11	1.14	1.14	0.95		
DIST.PJESORE.TERENIT													
DIST.PROGRES.PROJEKTIT	-10.00	-8.99	-7.92	-6.57	-4.35	-3.64	-3.18	-2.77	-1.51	0.00	0.27	4.49	10.00
KUOTA PROJEKTIT	1.18	1.18	0.62	0.03	0.05	0.76	1.06	1.11	1.11	1.14	1.14	0.95	
DIST.PJESORE.PROJEKTIT													



 REPUBLIKA E SHQIPËRISE
 BASHKIA LEZHE
 PROJEKT ZBATIMI
 SISTEMIM ASFALTIM I RRUGES AZEM HAJDARI

Firma Name and Address

 BASHKIA LEZHE
 DREJTORIA E PLANIFIKIMI
 DHE ZHVILLIMIT TE
 TERRITORIT

Ark.DODE ZHUBA	
Ing.ADIONA MARTINI	
Ing.GJOVALIN MARKU	
Ing.GJON LUCA	
Ing.ALBAN LAÇI	

Projekt	seksionet terthore	Sheet
Data	Janar 2019	
Shkalla	1:500	

AKSI AZ
 Numeri Profil : -5-
 Progresivi : 0+200.00
 Shkalla : 500:500
 Kuota.Referuese : -7.50

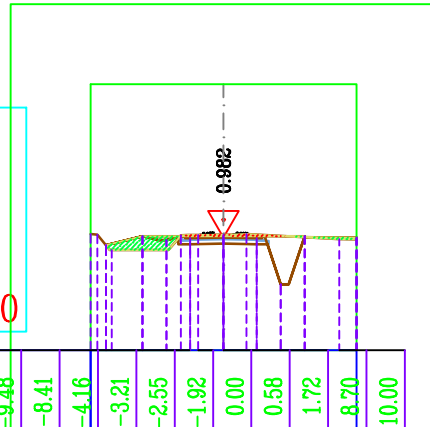

DIST.PROGRES.TERENIT	-10.00	-9.48	-8.41	-4.16	-3.21	-2.55	-1.92	0.00	0.58	1.72	8.70	10.00
KUOTA TERENIT	1.24	1.20	0.04	0.03	1.15	1.17	1.18	1.19	1.19	1.23	0.86	0.84
DIST.PJESORE.TERENIT												
DIST.PROGRES.PROJEKTIT	-10.00	-9.48	-8.41	-4.16	-3.21	-2.55	-1.92	0.00	0.58	1.72	8.70	10.00
KUOTA PROJEKTIT	1.24	1.20	0.04	0.03	1.15	1.17	1.18	1.19	1.19	1.23	0.86	0.84
DIST.PJESORE.PROJEKTIT												





 REPUBLIKA E SHQIPËRISE
 BASHKIA LEZHE
 PROJEKT ZBATIMI
 SISTEMIM ASFALTIM I RRUGES AZEM HAJDARI

Firma Name and Address

 BASHKIA LEZHE
 DREJTORIA E PLANIFIKIMI
 DHE ZHVILLIMIT TE
 TERRITORIT

Ark.DODE ZHUBA	
Ing.ADIONA MARTINI	
Ing.GJOVALIN MARKU	
Ing.GJON LUCA	
Ing.ALBAN LAÇI	

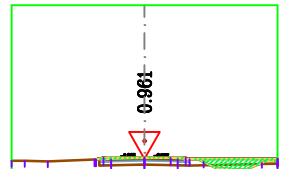
Projekt seksionet terthore	Sheet
Data Janar 2019	
Shkalla 1:500	

AKSI AZ
 Numeri Profilit : -6-
 Progresivi : 0+250.00
 Shkalla : 500:500
 Kuota.Referuese : -2.50



DIST.PROGRES.TERENIT	-10.00	-9.00	-7.28	-3.76	-0.88	0.00	1.97	3.37	4.05	5.41	7.28	7.81	8.82	10.00
KUOTA TERENIT	0.82	0.81	0.77	0.91	0.99	1.01	1.03	0.93	0.91	0.26	0.12	0.23	0.65	0.79
DIST.PJESORE.TERENIT														
DIST.PROGRES.PROJEKTI	-10.00	-9.00	-7.28	-3.76	-0.88	-0.41	0.00	1.97	3.37	4.05	4.45	5.41	7.28	7.57
KUOTA PROJEKTI	0.82	0.81	0.77	0.91	0.99	1.00	1.01	1.03	0.93	0.91	0.72	0.26	0.12	0.12
DIST.PJESORE.PROJEKTI														

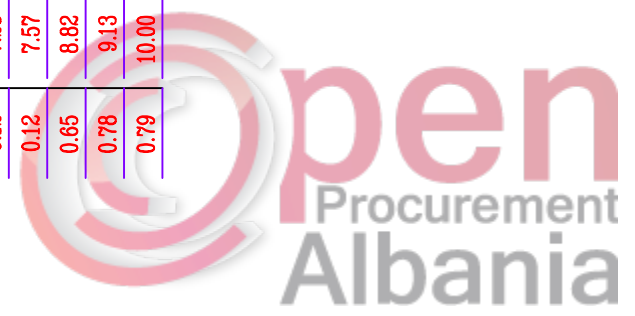



 REPUBLIKA E SHQIPËRISE
 BASHKIA LEZHE
 PROJEKT ZBATIMI
 SISTEMIM ASFAL TIM I RRUGES AZEM HAJDARI

Firm Name and Address

 BASHKIA LEZHE
 DREJTORIA E PLANIFIKIMI
 DHE ZHVILLIMIT TE
 TERRITORIT
 Ark.DODE ZHUBA
 Ing.ADIONA MARTINI
 Ing.GJOVALIN MARKU
 Ing.GJON LUCA
 Ing.ALBAN LAÇI

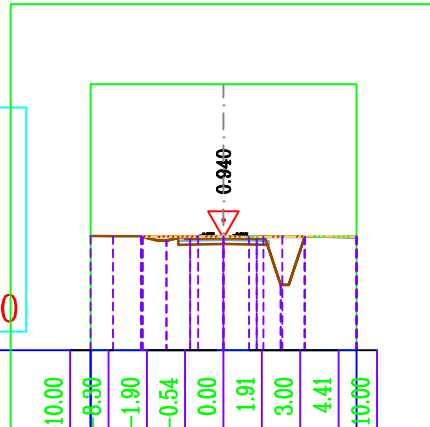
Projekt	seksionet terthore	Sheet
Data	Janar 2019	
Shkalla	1:500	

AKSI AZ
 Numeri Profil : -7-
 Progresivi : 0+300.00
 Shkalla : 500:500
 Kuota.Referuese : -7.50



DIST.PROGRES.TERENIT	-10.00	-8.30	-1.90	-0.54	0.00	1.91	3.00	4.41	10.00	
KUOTA TERENIT	1.10	1.07	1.08	1.07	1.07	1.03	1.03	1.07	1.05	
DIST.PJESORE.TERENIT										
DIST.PROGRES.PROJEKTIT	-10.00	-8.30	-1.90	-0.54	0.00	1.91	3.00	3.31	4.41	10.00
KUOTA PROJEKTIT	1.10	1.07	1.08	1.07	1.07	1.03	1.03	1.04	1.07	1.05
DIST.PJESORE.PROJEKTIT										





 REPUBLIKA E SHQIPËRISE
 BASHKIA LEZHE
 PROJEKT ZBATIMI
 SISTEMIM ASFALTIM I RRUGES AZEM HAJDARI

Firma Name and Address

 BASHKIA LEZHE
 DREJTORIA E PLANIFIKIMI
 DHE ZHVILLIMIT TE
 TERRITORIT

Ark.DODE ZHUBA	
Ing.ADIONA MARTINI	
Ing.GJOVALIN MARKU	
Ing.GJON LUCA	
Ing.ALBAN LAÇI	

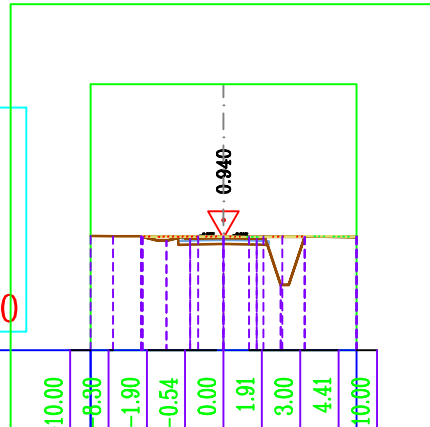
Projekt	seksionet terthore	Sheet
Data	Janar 2019	
Shkalla	1:500	

AKSI AZ
 Numeri Profil : -7-
 Progresivi : 0+300.00
 Shkalla : 500:500
 Kuota.Referuese : -7.50



DIST.PROGRES.TERENIT	-10.00	-8.30	-1.90	-0.54	0.00	1.91	3.00	4.41	10.00	
KUOTA TERENIT	1.10	1.07	1.08	1.07	1.07	1.03	1.03	1.07	1.05	
DIST.PJESORE.TERENIT										
DIST.PROGRES.PROJEKTIT	-10.00	-8.30	-1.90	-0.54	0.00	1.91	3.00	3.31	4.41	10.00
KUOTA PROJEKTIT	1.10	1.07	1.08	1.07	1.07	1.03	1.03	1.04	1.07	1.05
DIST.PJESORE.PROJEKTIT										





 REPUBLIKA E SHQIPËRISE
 BASHKIA LEZHE
 PROJEKT ZBATIMI
 SISTEMIM ASFALTIM I RRUGES AZEM HAJDARI

Firma Name and Address

 BASHKIA LEZHE
 DREJTORIA E PLANIFIKIMI
 DHE ZHVILLIMIT TE
 TERRITORIT
 Ark.DODE ZHUBA
 Ing.ADIONA MARTINI
 Ing.GJOVALIN MARKU
 Ing.GJON LUCA
 Ing.ALBAN LAÇI

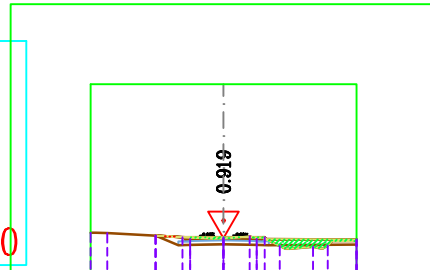
Projekt	seksionet terthore	Sheet
Date	Janar 2019	
Shkalla	1:500	

AKSI AZ
 Numeri Profil : -8-
 Progresivi : 0+350.00
 Shkalla : 500:500
 Kuota.Referuese : -2.50



DIST.PROGRES.TERENIT	-10.00	-9.60	-8.74	-0.77	0.00	0.41	1.95	2.77	4.21	4.96	6.73	7.42	8.17	10.00		
KUOTA TERENIT	1.34	1.34	1.30	0.88	0.91	0.93	1.08	0.96	0.35	0.14	0.14	0.27	0.14	0.70		
DIST.PJESORE.TERENIT																
DIST.PROGRES.PROJEKTTIT	-10.00	-9.60	-8.74	-0.77	0.00	0.41	1.95	2.77	4.21	4.65	4.96	6.73	7.42	7.83	8.17	10.00
KUOTA PROJEKTTIT	1.34	1.34	1.30	0.88	0.91	0.93	1.08	0.96	0.35	0.14	0.14	0.27	0.14	0.38	0.71	0.70
DIST.PJESORE.PROJEKTTIT																



 REPUBLIKA E SHQIPËRISE
 BASHKIA LEZHE
 PROJEKT ZBATIMI
 SISTEMIM ASFALTIM I RRUGES AZEM HAJDARI

Firma Name and Address

 BASHKIA LEZHE
 DREJTORIA E PLANIFIKIMI
 DHE ZHVILLIMIT TE
 TERRITORIT

Ark.DODE ZHUBA	
Ing.ADIONA MARTINI	
Ing.GJOVALIN MARKU	
Ing.GJON LUCA	
Ing.ALBAN LAÇI	

Projekt	seksionet terthore	Sheet
Data	Janar 2019	
Shkalla	1:500	

AKSI AZ
 Numeri Profilit : -9-
 Progresivi : 0+400.00
 Shkalla : 500:500
 Kuota.Referuese : -2.50

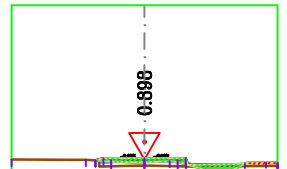

DIST.PROGRES.TERENIT	-10.00	-5.40	-4.42	-0.65	0.00	1.89	2.22	3.12	4.55	6.53	7.55	9.12	10.00
KUOTA TERENIT	0.91	0.89	0.88	0.69	0.71	0.77	0.76	0.57	0.46	0.15	0.14	0.59	0.67
DIST.PJESORE.TERENIT													
DIST.PROGRES.PROJEKTI	-10.00	-5.40	-4.42	-0.91	-0.65	0.00	1.89	2.22	3.12	3.37	4.55	6.53	6.99
KUOTA PROJEKTI	0.91	0.89	0.88	0.69	0.69	0.71	0.77	0.76	0.57	0.46	0.15	0.14	0.30
DIST.PJESORE.PROJEKTI													



REPUBLICA E SHQIPËRIE
 BASHKIA LEZHE
 PROJEKT ZBATIMI
 SISTEMIM ASFAL TIM I RRUGES AZEM HAJDARI

Firma Name and Address
 BASHKIA LEZHE
 DREJTORIA E PLANIFIKIMI
 DHE ZHVILLIMIT TE
 TERRITORIT

Ark.DODE ZHUBA	
Ing.ADIONA MARTINI	
Ing.GJOVALIN MARKU	
Ing.GJON LUCA	
Ing.ALBAN LAÇI	

Projekt seksionet terthore	Sheet
Data Janar 2019	
Shkalla 1:500	

AKSI AZ
 Numeri Profilit : -10-
 Progresivi : 0+450.00
 Shkalla : 500:500
 Kuota.Referuese : -2.50

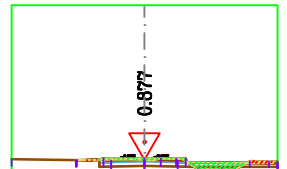

DIST.PROGRES.TERENIT	-10.00	-5.07	-0.85	0.00	0.63	1.22	1.93	2.81	4.01	4.55	5.02	6.82	7.59	9.35	10.00	
KUOTA TERENIT	0.93	0.86	0.89	0.95	0.83	0.97	0.96	0.95	0.18	0.18	0.17	0.17	0.60	0.75	0.76	
DIST.PJESORE.TERENIT																
DIST.PROGRES.PROJEKTIT	-10.00	-5.07	-0.85	0.00	0.63	1.22	1.93	2.37	2.81	4.01	4.55	5.02	6.82	7.59	9.35	10.00
KUOTA PROJEKTIT	0.93	0.86	0.89	0.85	0.83	0.97	0.96	0.95	0.95	0.18	0.18	0.17	0.17	0.60	0.75	0.76
DIST.PJESORE.PROJEKTIT																



REPUBLICA E SHQIPËRIE
 BASHKIA LEZHE
 PROJEKT ZBATIMI
 SISTEMIM ASFAL TIM I RRUGES AZEM HAJDARI

Firma Name and Address

BASHKIA LEZHE
 DREJTORIA E PLANIFIKIMI
 DHE ZHVILLIMIT TE
 TERRITORIT

Ark.DODE ZHUBA	
Ing.ADIONA MARTINI	
Ing.GJOVALIN MARKU	
Ing.GJON LUCA	
Ing.ALBAN LAÇI	

Projekt	seksionet terthore	Sheet
Date	Janar 2019	
Shkalle	1:500	

AKSI AZ
 Numeri Profil : -11-
 Progresivi : 0+500.00
 Shkalla : 500:500
 Kuota.Referuese : -7.50

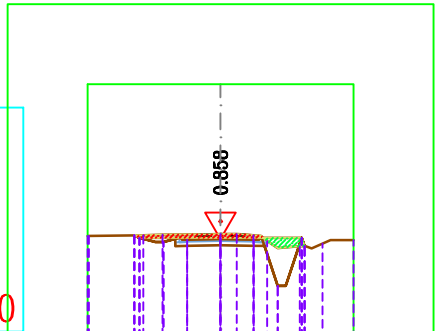

DIST.PROGRES.TERENIT	-1.00	-9.89	-5.81	-4.36	-0.92	0.00	1.22	2.00	3.05	4.29	5.96	6.86	7.67	8.26	10.00
KUOTA TERENIT	1.11	1.11	1.14	1.19	1.22	1.23	1.23	1.20	1.10	0.18	0.32	0.15	0.51	0.78	0.78
DIST.PJESORE.TERENIT															
DIST.PROGRES.PROJEKTIT	-1.00	-8.89	-4.81	-3.36	-0.92	0.00	1.22	2.00	3.05	4.29	5.96	6.86	7.67	8.26	10.00
KUOTA PROJEKTIT	1.11	1.11	1.14	1.19	1.22	1.23	1.23	1.15	1.10	0.71	0.18	0.32	0.51	0.78	0.78
DIST.PJESORE.PROJEKTIT															



 REPUBLIKA E SHQIPËRIE
 BASHKIA LEZHE
 PROJEKT ZBATIMI
 SISTEMIM ASFALTIM I RRUGES AZEM HAJDARI

Firma Name and Address

 BASHKIA LEZHE
 DREJTORIA E PLANIFIKIMI
 DHE ZHVILLIMIT TE
 TERRITORIT

Ark.DODE ZHUBA	
Ing.ADIONA MARTINI	
Ing.GJOVALIN MARKU	
Ing.GJON LUCA	
Ing.ALBAN LAÇI	

Projekt seksionet terthore	Sheet
Data Janar 2019	
Shkalla 1:500	

AKSI AZ
 Numeri Profilit : -12-
 Progresivi : 0+550.00
 Shkalla : 500:500
 Kuota.Referuese : -2.50



DIST.PROGRES.TERENIT	-1.00	-8.02	-5.47	-1.84	-0.63	0.00	1.32	2.00	2.51	3.42	4.11	4.83	6.64	7.82	10.00
KUOTA TERENIT	0.66	0.71	0.75	0.84	0.88	0.88	0.89	0.89	0.75	0.79	0.10	0.14	0.17	0.95	0.95
DIST.PJESORE.TERENIT															
DIST.PROGRES.PROJEKTIT	-1.00	-8.02	-5.47	-1.84	-0.63	0.00	1.32	2.00	2.51	3.42	4.11	4.83	6.64	7.82	10.00
KUOTA PROJEKTIT	0.66	0.71	0.75	0.84	0.88	0.88	0.89	0.89	0.75	0.79	0.10	0.14	0.17	0.95	0.95
DIST.PJESORE.PROJEKTIT															



REPUBLICA E SHQIPËRIE
 BASHKIA LEZHE
 PROJEKT ZBATIMI
 SISTEMIM ASFAL TIM I RRUGES AZEM HAJDARI

Firma Name and Address
 BASHKIA LEZHE
 DREJTORIA E PLANIFIKIMI
 DHE ZHVILLIMIT TE
 TERRITORIT

Ark.DODE ZHUBA	
Ing.ADIONA MARTINI	
Ing.GJOVALIN MARKU	
Ing.GJON LUCA	
Ing.ALBAN LAÇI	

Projekt	seksionet terthore	Sheet
Date	Janar 2019	
Shkale	1:500	

AKSI AZ
 Numeri Profil : -13-
 Progresivi : 0+600.00
 Shkalla : 500:500
 Kuota.Referuese : -7.50

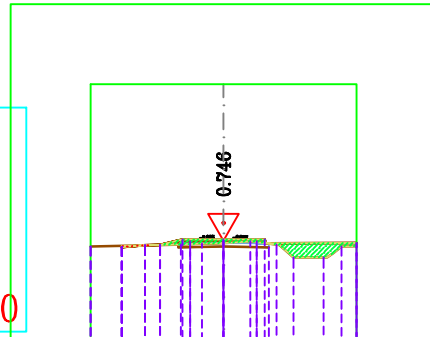

DIST.PROGRES.TERENIT	-10.00	-9.99	-3.21	-1.63	-0.77	0.00	2.02	3.98	5.26	7.52	8.24	8.87	10.00		
KUOTA TERENIT	0.30	0.30	0.46	0.51	0.52	0.56	0.69	0.44	-0.51	-0.51	-0.19	0.31	0.33		
DIST.PJESORE.TERENIT															
DIST.PROGRES.PROJEKTI	-10.50	-9.99	-3.21	-1.63	-0.77	0.00	2.02	3.98	4.25	5.26	7.52	7.78	8.24	8.87	10.00
KUOTA PROJEKTI	0.30	0.30	0.46	0.51	0.52	0.56	0.69	0.44	0.41	-0.51	-0.51	-0.19	0.31	0.33	
DIST.PJESORE.PROJEKTI															





 REPUBLIKA E SHQIPËRIE
 BASHKIA LEZHE
 PROJEKT ZBATIMI
 SISTEMIM ASFALTIM I RRUGES AZEM HAJDARI

Firma Name and Address

 BASHKIA LEZHE
 DREJTORIA E PLANIFIKIMI
 DHE ZHVILLIMIT TE
 TERRITORIT

Ark.DODE ZHUBA	
Ing.ADIONA MARTINI	
Ing.GJOVALIN MARKU	
Ing.GJON LUCA	
Ing.ALBAN LAÇI	

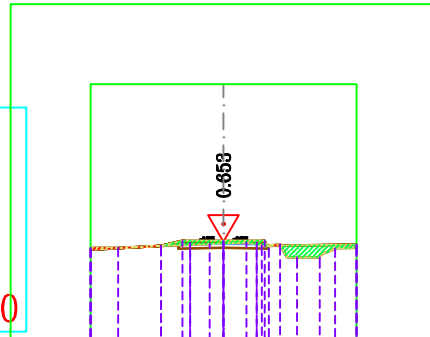
Projekt seksionet terthore	Sheet
Date Janar 2019	
Shkalla 1:500	

AKSI AZ
 Numeri Profil : -14-
 Progresivi : 0+650.00
 Shkalla : 500:500
 Kuota.Referuese : -7.50



DIST.PROGRES.TERENIT	-10.00	-7.93	-1.04	-0.51	0.00	1.72	2.87	4.25	4.76	5.52	7.24	8.38	8.97	10.00
KUOTA TERENIT	0.20	0.21	0.50	0.52	0.54	0.61	0.41	0.48	-0.51	-0.51	-0.51	0.14	0.19	0.21
DIST.PJESORE.TERENIT														
DIST.PROGRES.PROJE	-10.00	-7.93	-1.04	-0.51	0.00	1.72	2.87	3.34	4.25	4.63	5.52	7.24	8.38	10.00
KUOTA PROJEKTI	0.20	0.21	0.50	0.52	0.54	0.61	0.41	0.35	0.48	-0.29	-0.51	-0.51	0.14	0.19
DIST.PJESORE.PROJEKTI														





 REPUBLIKA E SHQIPËRISE
 BASHKIA LEZHE
 PROJEKT ZBATIMI
 SISTEMIM ASFALTIM I RRUGES AZEM HAJDARI

Firma Name and Address

 BASHKIA LEZHE
 DREJTORIA E PLANIFIKIMI
 DHE ZHVILLIMIT TE
 TERRITORIT

Ark.DODE ZHUBA	
Ing.ADIONA MARTINI	
Ing.GJOVALIN MARKU	
Ing.GJON LUCA	
Ing.ALBAN LAÇI	

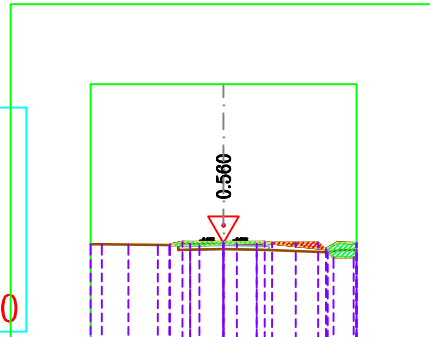
Projekt seksionet terthore	Sheet
Data Janar 2019	
Shkalla 1:500	

AKSI AZ
 Numeri Profil : -15-
 Progresivi : 0+700.00
 Shkalla : 500:500
 Kuota.Referuese : -7.50



DIST.PROGRES.TERENIT	-1.81	-9.16	-7.16	-4.93	-1.81	0.00	1.00	1.57	3.64	5.43	7.10	7.66	8.25	9.78	10.00	
KUOTA TERENIT	0.47	0.48	0.45	0.43	0.39	0.49	0.54	0.58	0.58	0.59	0.59	0.07	-0.51	-0.51	-0.48	
DIST.PJESORE.TERENIT																
DIST.PROGRES.PROJEKTIT	-1.81	-9.16	-7.16	-4.93	-1.81	0.00	1.00	1.57	3.64	5.43	5.93	7.10	7.66	8.25	9.78	10.00
KUOTA PROJEKTIT	0.47	0.48	0.45	0.43	0.39	0.49	0.54	0.58	0.58	0.59	0.59	0.07	-0.51	-0.51	-0.48	
DIST.PJESORE.PROJEKTIT																





 REPUBLIKA E SHQIPËRISE
 BASHKIA LEZHE
 PROJEKT ZBATIMI
 SISTEMIM ASFALTIM I RRUGES AZEM HAJDARI

Firma Name and Address

 BASHKIA LEZHE
 DREJTORIA E PLANIFIKIMI
 DHE ZHVILLIMIT TE
 TERRITORIT

Ark.DODE ZHUBA	
Ing.ADIONA MARTINI	
Ing.GJOVALIN MARKU	
Ing.GJON LUCA	
Ing.ALBAN LAÇI	

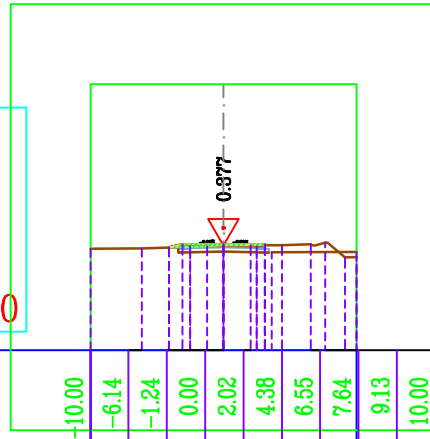
Projekt seksionet terthore	Sheet
Date Janar 2019	
Shkalle 1:500	

AKSI AZ
 Numeri Profil : -17-
 Progresivi : 0+800.00
 Shkalla : 500:500
 Kuota.Referuese : -7.50



DIST.PROGRES.TERENIT		10.00	6.14	1.24	0.00	2.02	4.38	6.55	7.64	9.13	10.00			
KUOTA TERENIT		0.13	0.15	0.34	0.37	0.41	0.39	0.48	0.58	-0.51	-0.48			
DIST.PJESORE.TERENIT														
DIST.PROGRES.PROJEKTIT		10.00	6.14	1.24	0.36	0.00	2.02	4.38	6.55	7.64	7.96	9.13	10.00	
KUOTA PROJEKTIT		0.13	0.15	0.34	0.37	0.37	0.41	0.39	0.48	0.37	0.58	0.48	-0.51	-0.48
DIST.PJESORE.PROJEKTIT														





 REPUBLIKA E SHQIPËRISE
 BASHKIA LEZHE
 PROJEKT ZBATIMI
 SISTEMIM ASFALTIM I RRUGES AZEM HAJDARI

Firma Name and Address

 BASHKIA LEZHE
 DREJTORIA E PLANIFIKIMI
 DHE ZHVILLIMIT TE
 TERRITORIT

Ark.DODE ZHUBA	
Ing.ADIONA MARTINI	
Ing.GJOVALIN MARKU	
Ing.GJON LUCA	
Ing.ALBAN LAÇI	

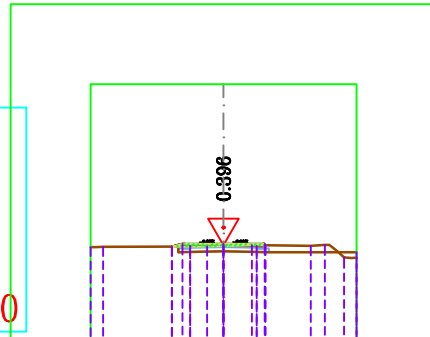
Project seksionet terthore	Sheet
Date Janar 2019	
Scale 1:500	

AKSI AZ
 Numeri Profil : -18-
 Progresivi : 0+850.00
 Shkalla : 500:500
 Kuota.Referuese : -7.50



DIST.PROGRES.TERENIT	-10.00	-9.67	-9.34	0.00	2.12	2.98	6.55	7.61	8.52	9.05	9.59	10.00	
KUOTA TERENIT	0.25	0.24	0.30	0.33	0.40	0.40	0.35	0.42	-0.03	-0.51	-0.56	-0.54	
DIST.PJESORE.TERENIT													
DIST.PROGRES.PROJEKTIT	-10.00	-9.67	-9.34	0.00	2.12	2.98	6.55	7.61	7.94	8.52	9.05	9.59	10.00
KUOTA PROJEKTIT	0.25	0.24	0.30	0.33	0.40	0.40	0.35	0.42	0.42	-0.03	-0.51	-0.56	-0.54
DIST.PJESORE.PROJEKTIT													



REPUBLICA E SHQIPËRIE
 BASHKIA LEZHE
 PROJEKT ZBATIMI
 SISTEMIM ASFAL TIM I RRUGES AZEM HAJDARI

Firma Name and Address
 BASHKIA LEZHE
 DREJTORIA E PLANIFIKIMI
 DHE ZHVILLIMIT TE
 TERRITORIT

Ark.DODE ZHUBA	
Ing.ADIONA MARTINI	
Ing.GJOVALIN MARKU	
Ing.GJON LUCA	
Ing.ALBAN LAÇI	

Projekt seksionet terthore	Sheet
Data Janar 2019	
Shkalla 1:500	

AKSI AZ
 Numeri Profil : -19-
 Progresivi : 0+900.00
 Shkalla : 500:500
 Kuota.Referuese : -7.50

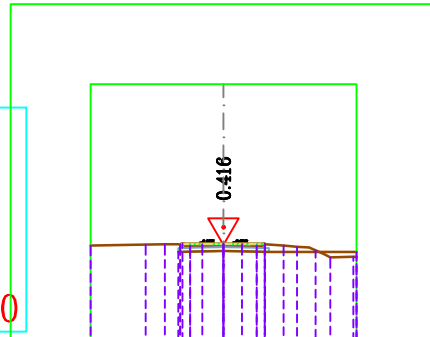

DIST.PROGRES.TERENIT	-10.90	-5.87	-4.41	-1.59	0.00	1.37	1.97	3.09	4.51	5.52	6.44	7.57	9.76	10.00	
KUOTA TERENIT	0.38	0.45	0.47	0.47	0.47	0.47	0.44	0.47	0.37	0.29	0.22	-0.28	-0.47	-0.46	
DIST.PJESORE.TERENIT															
DIST.PROGRES.PROJEKTIT	-10.90	-5.87	-4.41	-1.59	0.00	1.37	1.97	3.09	4.51	5.52	6.44	7.57	8.03	9.76	10.00
KUOTA PROJEKTIT	0.38	0.45	0.47	0.47	0.47	0.47	0.44	0.47	0.37	0.29	0.22	0.01	-0.28	-0.47	-0.46
DIST.PJESORE.PROJEKTIT															





 REPUBLIKA E SHQIPËRISE
 BASHKIA LEZHE
 PROJEKT ZBATIMI
 SISTEMIM ASFALTIM I RRUGES AZEM HAJDARI

Firma Name and Address

 BASHKIA LEZHE
 DREJTORIA E PLANIFIKIMI
 DHE ZHVILLIMIT TE
 TERRITORIT
 Ark.DODE ZHUBA
 Ing.ADIONA MARTINI
 Ing.GJOVALIN MARKU
 Ing.GJON LUCA
 Ing.ALBAN LAÇI

Projekt: *seksionet terthore* Sheet:
 Date: *Janar 2019*
 Shkalle: *1:500*

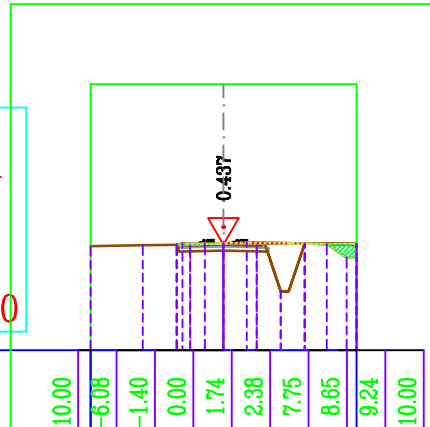
AKSI AZ
 Numeri Profil : -20-
 Progresivi : 0+950.00
 Shkalla : 500:500
 Kuota.Referuese : -7.50



DIST.PROGRES.TERENIT	-10.00	-6.08	-1.40	0.00	1.74	2.38	7.75	8.65	9.24	10.00	
KUOTA TERENIT	0.32	0.40	0.49	0.54	0.61	0.61	0.49	-0.13	-0.51	-0.49	
DIST.PJESORE.TERENIT											
DIST.PROGRES.PROJEKTIT	-10.00	-6.08	-1.77	-1.40	0.00	1.74	2.38	7.75	8.65	9.24	10.00
KUOTA PROJEKTIT	0.32	0.40	0.44	0.49	0.54	0.61	0.61	0.49	-0.13	-0.51	-0.49
DIST.PJESORE.PROJEKTIT											



REPUBLICA E SHQIPËRIE
 BASHKIA LEZHE
 PROJEKT ZBATIMI
 SISTEMIM ASFALTIM I RRUGES AZEM HAJDARI

BASHKIA LEZHE
 DREJTORIA E PLANIFIKIMI
 DHE ZHVILLIMIT TE
 TERRITORIT

Ark.DODE ZHUBA	
Ing.ADIONA MARTINI	
Ing.GJOVALIN MARKU	
Ing.GJON LUCA	
Ing.ALBAN LAÇI	

Projekt seksionet terthore	Sheet
Data Janar 2019	
Shkalla 1:500	

AKSI AZ
 Numeri Profil : -21-
 Progresivi : 1+000.00
 Shkalla : 500:500
 Kuota.Referuese : -7.50

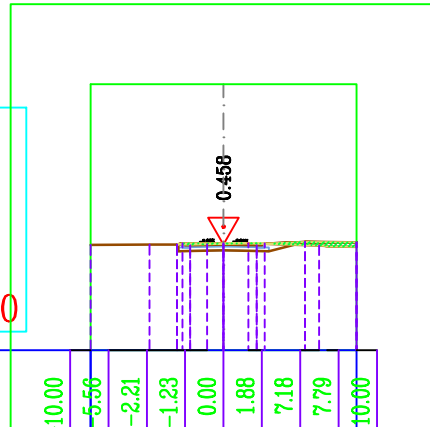

DIST.PROGRES.TERENIT	-10.00	-5.56	-2.21	-1.23	0.00	1.88	7.18	7.79	10.00	
KUOTA TERENIT	0.43	0.44	0.45	0.48	0.50	0.55	0.39	0.30	0.28	
DIST.PJESORE.TERENIT										
DIST.PROGRES.PROJEKTIT	-10.00	-5.56	-2.21	-1.23	-0.27	0.00	1.88	7.18	7.62	10.00
KUOTA PROJEKTIT	0.43	0.44	0.45	0.48	0.50	0.50	0.55	0.39	0.35	0.28
DIST.PJESORE.PROJEKTIT										



REPUBLICA E SHQIPËRIE
 BASHKIA LEZHE
 PROJEKT ZBATIMI
 SISTEMIM ASFALTIM I RRUGES AZEM HAJDARI

Firma Name and Address
 BASHKIA LEZHE
 DREJTORIA E PLANIFIKIMI
 DHE ZHVILLIMIT TE
 TERRITORIT

Ark.DODE ZHUBA	
Ing.ADIONA MARTINI	
Ing.GJOVALIN MARKU	
Ing.GJON LUCA	
Ing.ALBAN LAÇI	

Projekt seksionet terthore	Sheet
Data Janar 2019	
Shkalle 1:500	

AKSI AZ
 Numeri Profil : -22-
 Progresivi : 1+050.00
 Shkalla : 500:500
 Kuota.Referuese : -7.50

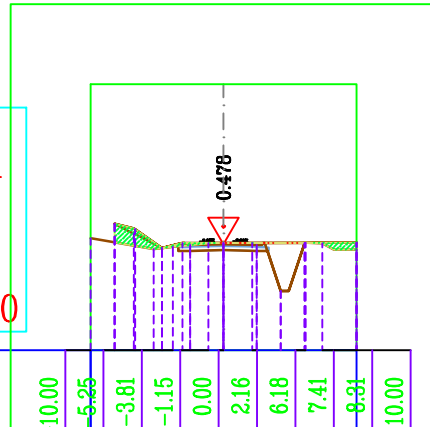

DIST.PROGRES.TERENIT	-10.00	-5.25	-3.81	-1.15	0.00	2.16	6.18	7.41	8.31	10.00
KUOTA TERENIT	0.93	0.42	0.28	0.56	0.57	0.57	0.58	0.55	0.07	0.05
DIST.PJESORE.TERENIT										
DIST.PROGRES.PROJEKTIT	-10.00	-5.25	-3.81	-1.15	0.00	2.16	6.18	7.41	8.31	10.00
KUOTA PROJEKTIT	0.93	0.12	0.28	0.56	0.57	0.57	0.58	0.55	0.07	0.05
DIST.PJESORE.PROJEKTIT										





 REPUBLIKA E SHQIPËRIE
 BASHKIA LEZHE
 PROJEKT ZBATIMI
 SISTEMIM ASFALTIM I RRUGES AZEM HAJDARI

Firma Name and Address

 BASHKIA LEZHE
 DREJTORIA E PLANIFIKIMI
 DHE ZHVILLIMIT TE
 TERRITORIT

Ark.DODE ZHUBA	
Ing.ADIONA MARTINI	
Ing.GJOVALIN MARKU	
Ing.GJON LUCA	
Ing.ALBAN LAÇI	

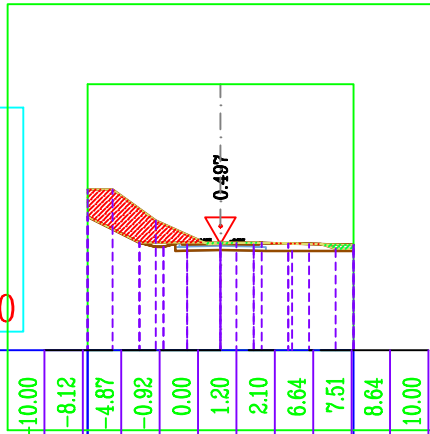
Projekt seksionet terthore	Sheet
Data Janar 2019	
Shkalle 1:500	

AKSI AZ
 Numeri Profil : -23-
 Progresivi : 1+100.00
 Shkalla : 500:500
 Kuota.Referuese : -7.50



DIST.PROGRES.TERENIT	-10.00	-8.12	-4.87	-0.92	0.00	1.20	2.10	6.64	7.51	8.64	10.00
KUOTA TERENIT	4.59	4.58	2.24	0.46	0.50	0.56	0.58	0.50	0.51	0.13	0.11
DIST.PJESORE.TERENIT											
DIST.PROGRES.PROJEKTIT	-10.00	-8.12	-4.87	-0.92	0.00	1.20	2.10	6.64	7.51	8.64	10.00
KUOTA PROJEKTIT	4.59	4.58	2.24	0.46	0.50	0.56	0.58	0.50	0.51	0.13	0.11
DIST.PJESORE.PROJEKTIT											



REPUBLICA E SHQIPËRIE
 BASHKIA LEZHE
 PROJEKT ZBATIMI
 SISTEMIM ASFAL TIM I RRUGES AZEM HAJDARI

Firma Name and Address
 BASHKIA LEZHE
 DREJTORIA E PLANIFIKIMI
 DHE ZHVILLIMIT TE
 TERRITORIT

Ark.DODE ZHUBA	
Ing.ADIONA MARTINI	
Ing.GJOVALIN MARKU	
Ing.GJON LUCA	
Ing.ALBAN LAÇI	

Projekt seksionet terthore	Sheet
Data Janar 2019	
Shkale 1:500	

AKSI AZ
 Numeri Profil : -24-
 Progresivi : 1+150.00
 Shkalla : 500:500
 Kuota.Referuese : -7.50

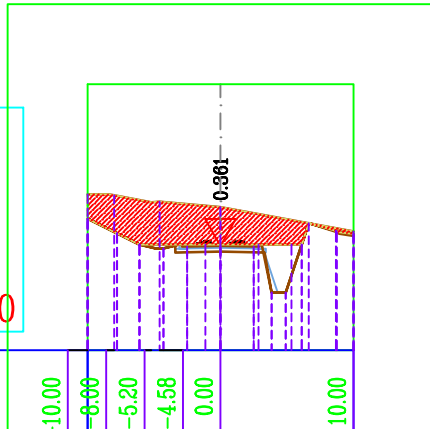

DIST.PROGRES.TERENIT	-10.00	0.00	-5.20	-4.58	0.00	10.00	
KUOTA TERENIT	4.22	4.14	3.62	3.67	3.26	1.43	
DIST.PJESORE.TERENIT							
DIST.PROGRES.PROJEKTIT	-10.00	-8.43	-8.00	-5.20	-4.58	0.00	10.00
KUOTA PROJEKTIT	4.22	4.22	4.14	3.62	3.67	3.26	1.43
DIST.PJESORE.PROJEKTIT							



 REPUBLIKA E SHQIPËRISE
 BASHKIA LEZHE
 PROJEKT ZBATIMI
 SISTEMIM ASFAL TIM I RRUGES AZEM HAJDARI

Firma Name and Address

 BASHKIA LEZHE
 DREJTORIA E PLANIFIKIMI
 DHE ZHVILLIMIT TE
 TERRITORIT

Ark.DODE ZHUBA	
Ing.ADIONA MARTINI	
Ing.GJOVALIN MARKU	
Ing.GJON LUCA	
Ing.ALBAN LAÇI	

Projekt	seksionet terthore	Sheet
Date	Janar 2019	
Shkalla	1:500	

AKSI AZ
 Numeri Profil : -25-
 Progresivi : 1+200.00
 Shkalla : 500:500
 Kuota.Referuese : -7.50

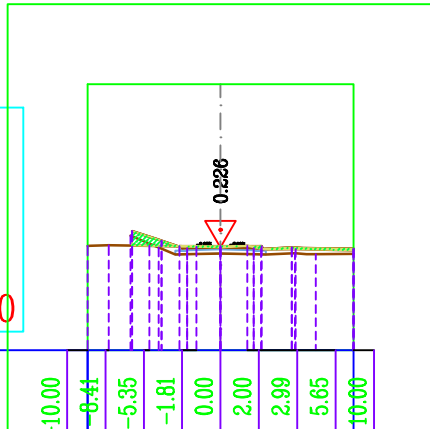

DIST.PROGRES.TERENIT	-10.00	-8.41	-5.35	-1.81	0.00	2.00	2.99	5.65	10.00	
KUOTA TERENIT	0.35	0.39	0.35	0.27	0.22	0.35	0.15	0.12	-0.01	
DIST.PJESORE.TERENIT										
DIST.PROGRES.PROJEKTIT	-10.00	-8.41	-5.35	-1.81	0.00	2.00	2.99	3.34	5.65	10.00
KUOTA PROJEKTIT	0.35	0.39	0.35	0.27	0.22	0.35	0.15	0.09	-0.12	0.01
DIST.PJESORE.PROJEKTIT										



REPUBLICA E SHQIPËRIE
 BASHKIA LEZHE
 PROJEKT ZBATIMI
 SISTEMIM ASFALTIM I RRUGES AZEM HAJDARI

Firma Name and Address
 BASHKIA LEZHE
 DREJTORIA E PLANIFIKIMI
 DHE ZHVILLIMIT TE
 TERRITORIT

Ark.DODE ZHUBA	
Ing.ADIONA MARTINI	
Ing.GJOVALIN MARKU	
Ing.GJON LUCA	
Ing.ALBAN LAÇI	

Projekt seksionet terthore	Sheet
Data Janar 2019	
Shkalla 1:500	

AKSI AZ
 Numeri Profil : -26-
 Progresivi : 1+250.00
 Shkalla : 500:500
 Kuota.Referuese : -7.50

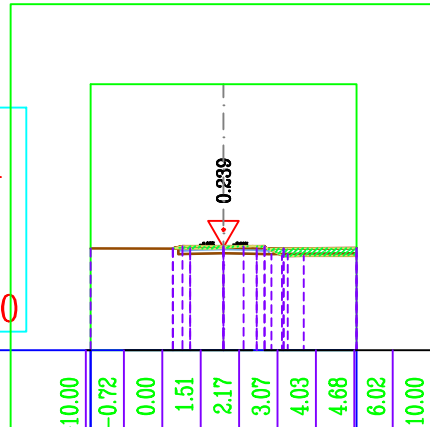

DIST.PROGRES.TERENIT	-10.00	-0.72	0.00	1.51	2.17	3.07	4.03	4.68	6.02	10.00	
KUOTA TERENIT	0.16	0.15	0.19	0.31	0.32	0.25	-0.20	-0.42	-0.41	-0.39	
DIST.PJESORE.TERENIT											
DIST.PROGRES.PROJEKTIT	-10.00	-0.50	0.00	1.51	2.00	3.07	4.03	4.39	4.68	6.02	10.00
KUOTA PROJEKTIT	0.16	0.15	0.19	0.31	0.32	0.25	-0.20	-0.37	-0.42	-0.41	-0.39
DIST.PJESORE.PROJEKTIT											





 REPUBLIKA E SHQIPËRISE
 BASHKIA LEZHE
 PROJEKT ZBATIMI
 SISTEMIM ASFAL TIM I RRUGES AZEM HAJDARI

Firm Name and Address

 BASHKIA LEZHE
 DREJTORIA E PLANIFIKIMI
 DHE ZHVILLIMIT TE
 TERRITORIT
 Ark.DODE ZHUBA
 Ing.ADIONA MARTINI
 Ing.GJOVALIN MARKU
 Ing.GJON LUCA
 Ing.ALBAN LAÇI

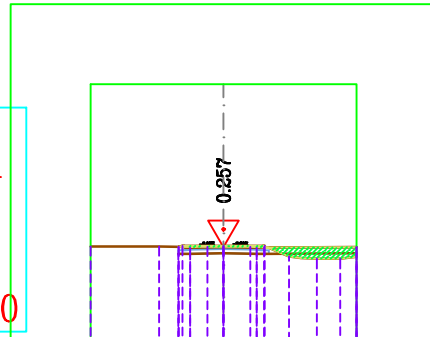
Projekt	seksionet terthore	Sheet
Data	Janar 2019	
Shkalla	1:500	

AKSI AZ
 Numeri Profil : -27-
 Progresivi : 1+300.00
 Shkalla : 500:500
 Kuota.Referuese : -7.50



DIST.PROGRES.TERENIT	10.00	4.85	1.96	1.22	0.00	2.00	3.04	3.85	4.93	5.80	7.00	8.77	10.00	
KUOTA TERENIT	0.31	0.31	0.27	0.27	0.28	0.29	0.23	0.02	-0.43	-0.56	-0.62	-0.60	-0.48	
DIST.PJESORE.TERENIT														
DIST.PROGRES.PROJEKTIT	10.00	4.85	1.96	1.22	0.00	2.00	3.04	3.40	3.85	4.93	5.80	7.00	8.77	10.00
KUOTA PROJEKTIT	0.31	0.31	0.27	0.28	0.27	0.28	0.29	0.23	0.02	-0.43	-0.56	-0.62	-0.60	-0.48
DIST.PJESORE.PROJEKTIT														





 REPUBLIKA E SHQIPËRISE
 BASHKIA LEZHE
 PROJEKT ZBATIMI
 SISTEMIM ASFALTIM I RRUGES AZEM HAJDARI

Firm Name and Address

 BASHKIA LEZHE
 DREJTORIA E PLANIFIKIMI
 DHE ZHVILLIMIT TE
 TERRITORIT
 Ark.DODE ZHUBA
 Ing.ADIONA MARTINI
 Ing.GJOVALIN MARKU
 Ing.GJON LUCA
 Ing.ALBAN LAÇI

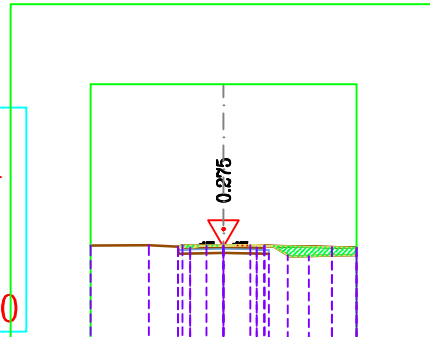
Projekt: seksionet terthore
 Date: Janar 2019
 Shkalle: 1:500

AKSI AZ
 Numeri Profil : -28-
 Progresivi : 1+350.00
 Shkalla : 500:500
 Kuota.Referuese : -7.50



DIST.PROGRES.TERENIT	-10.00	-5.61	-1.81	-1.29	0.00	2.00	3.05	3.77	4.83	6.41	7.16	10.00	
KUOTA TERENIT	0.37	0.41	0.32	0.35	0.36	0.39	0.36	0.31	-0.34	-0.42	-0.40	-0.35	
DIST.PJESORE.TERENIT													
DIST.PROGRES.PROJEKTI	-10.00	-5.61	-2.28	-1.81	-1.29	0.00	2.00	3.05	3.77	4.83	6.41	7.16	10.00
KUOTA PROJEKTI	0.37	0.41	0.22	0.32	0.35	0.36	0.39	0.36	0.31	-0.34	-0.42	-0.40	-0.35
DIST.PJESORE.PROJEKTI													



 REPUBLIKA E SHQIPËRIE
 BASHKIA LEZHE
 PROJEKT ZBATIMI
 SISTEMIM ASFALTIM I RRUGES AZEM HAJDARI

Firma Name and Address

 BASHKIA LEZHE
 DREJTORIA E PLANIFIKIMI
 DHE ZHVILLIMIT TE
 TERRITORIT

Ark.DODE ZHUBA	
Ing.ADIONA MARTINI	
Ing.GJOVALIN MARKU	
Ing.GJON LUCA	
Ing.ALBAN LAÇI	

Projekt seksionet terthore	Sheet
Data Janar 2019	
Shkalla 1:500	

AKSI AZ
 Numeri Profil : -29-
 Progresivi : 1+400.00
 Shkalla : 500:500
 Kuota.Referuese : -7.50

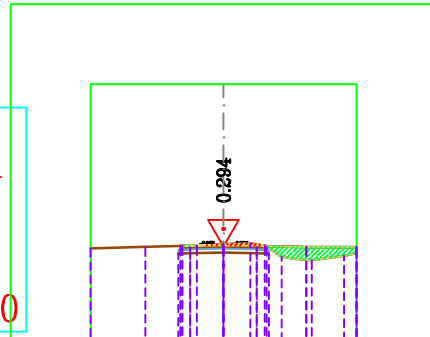

DIST.PROGRES.TERENIT	-10.00	-5.88	-2.01	0.00	2.00	2.71	3.25	3.83	4.37	5.30	6.62	9.07	9.66	10.00
KUOTA TERENIT	0.17	0.27	0.38	0.49	0.55	0.45	0.30	-0.11	-0.46	-0.60	-0.72	-0.39	-0.27	-0.15
DIST.PJESORE.TERENIT														
DIST.PROGRES.PROJEKTI	-10.00	-5.88	-2.01	0.00	2.00	2.71	3.25	3.83	4.37	5.30	6.62	9.07	9.66	10.00
KUOTA PROJEKTI	0.17	0.27	0.38	0.49	0.51	0.55	0.45	0.30	-0.11	-0.46	-0.60	-0.39	-0.27	-0.15
DIST.PJESORE.PROJEKTI														





 REPUBLIKA E SHQIPËRIE
 BASHKIA LEZHE
 PROJEKT ZBATIMI
 SISTEMIM ASFALTIM I RRUGES AZEM HAJDARI

Firma Name and Address

 BASHKIA LEZHE
 DREJTORIA E PLANIFIKIMI
 DHE ZHVILLIMIT TE
 TERRITORIT
 Ark.DODE ZHUBA
 Ing.ADIONA MARTINI
 Ing.GJOVALIN MARKU
 Ing.GJON LUCA
 Ing.ALBAN LAÇI

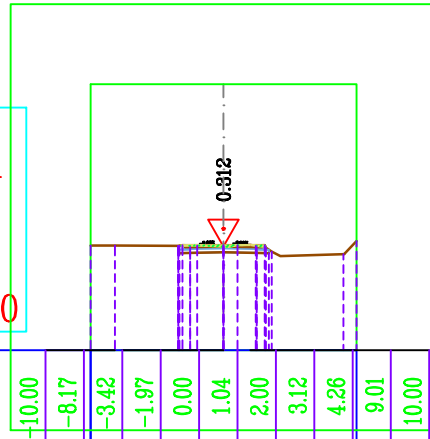
Projekt: *seksionet terthore* Sheet:
 Data: *Janar 2019*
 Shkalle: *1:500*

AKSI AZ
 Numeri Profil : -30-
 Progresivi : 1+450.00
 Shkalla : 500:500
 Kuota.Referuese : -7.50



DIST.PROGRES.TERENIT	-10.00	-8.17	-3.42	-1.97	0.00	1.04	2.00	3.12	4.26	9.01	10.00				
KUOTA TERENIT	0.38	0.37	0.34	0.37	0.27	0.39	0.43	0.26	-0.42	-0.27	0.72				
DIST.PJESORE.TERENIT															
DIST.PROGRES.PROJEKTIT	-10.00	-8.17	-3.42	-1.97	0.00	1.04	2.00	2.42	3.12	3.62	4.26	9.01	10.00		
KUOTA PROJEKTIT	0.38	0.37	0.34	0.37	0.29	0.27	0.26	0.39	0.43	0.35	0.26	-0.09	-0.42	-0.27	0.72
DIST.PJESORE.PROJEKTIT															





 REPUBLIKA E SHQIPËRIE
 BASHKIA LEZHE
 PROJEKT ZBATIMI
 SISTEMIM ASFALTIM I RRUGES AZEM HAJDARI

Firma Name and Address

 BASHKIA LEZHE
 DREJTORIA E PLANIFIKIMI
 DHE ZHVILLIMIT TE
 TERRITORIT

Ark.DODE ZHUBA	
Ing.ADIONA MARTINI	
Ing.GJOVALIN MARKU	
Ing.GJON LUCA	
Ing.ALBAN LAÇI	

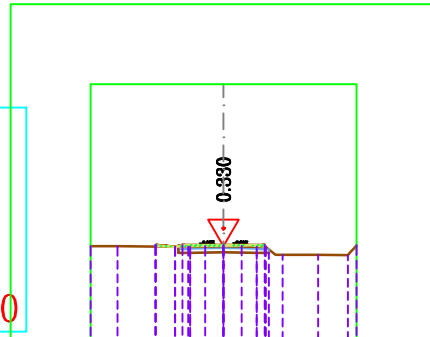
Projekt seksionet terthore	Sheet
Date Janar 2019	
Shkalla 1:500	

AKSI AZ
 Numeri Profil : -31-
 Progresivi : 1+500.00
 Shkalla : 500:500
 Kuota.Referuese : -7.50



DIST.PROGRES.TERENIT	-10.00	-7.98	-3.59	-2.65	-1.37	0.00	1.36	2.00	3.16	3.91	4.43	7.12	9.35	9.93	10.00	
KUOTA TERENIT	0.32	0.34	0.29	0.31	0.32	0.34	0.35	0.37	0.27	-0.32	-0.31	-0.32	-0.34	0.34	0.41	
DIST.PJESORE.TERENIT																
DIST.PROGRES.PROJEKTIT	-10.00	-7.98	-3.59	-2.65	-1.37	0.00	1.36	2.00	2.29	3.16	3.91	4.43	7.12	9.35	10.00	
KUOTA PROJEKTIT	0.32	0.34	0.29	0.31	0.32	0.34	0.35	0.37	0.34	0.27	-0.32	-0.31	-0.32	-0.34	0.12	0.41
DIST.PJESORE.PROJEKTIT																





 REPUBLIKA E SHQIPËRISE
 BASHKIA LEZHE
 PROJEKT ZBATIMI
 SISTEMIM ASFALTIM I RRUGES AZEM HAJDARI

Firma Name and Address

 BASHKIA LEZHE
 DREJTORIA E PLANIFIKIMI
 DHE ZHVILLIMIT TE
 TERRITORIT
 Ark.DODE ZHUBA
 Ing.ADIONA MARTINI
 Ing.GJOVALIN MARKU
 Ing.GJON LUCA
 Ing.ALBAN LAÇI

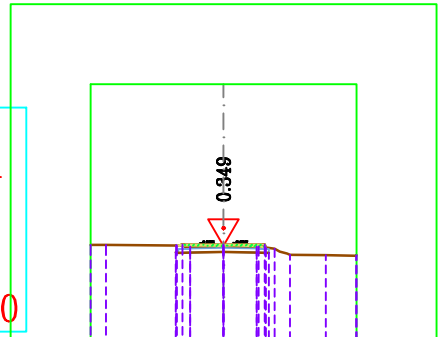
Projekt	seksionet terthore	Sheet
Data	Janar 2019	
Shkalla	1:500	

AKSI AZ
 Numeri Profil : -32-
 Progresivi : 1+550.00
 Shkalla : 500:500
 Kuota.Referuese : -7.50



DIST.PROGRES.TERENIT	-10.00	-8.83	-3.52	-0.53	0.00	0.81	2.63	3.85	4.77	7.68	9.96	10.00	
KUOTA TERENIT	0.42	0.42	0.38	0.32	0.34	0.37	0.30	0.14	-0.22	-0.35	-0.38	-0.34	
DIST.PJESORE.TERENIT													
DIST.PROGRES.PROJEKTIT	-10.00	-8.83	-3.52	-0.53	0.00	0.81	2.63	3.85	4.22	4.77	7.68	9.96	10.00
KUOTA PROJEKTIT	0.42	0.42	0.38	0.32	0.34	0.37	0.30	0.14	-0.07	-0.22	-0.35	-0.38	-0.34
DIST.PJESORE.PROJEKTIT													





 REPUBLIKA E SHQIPËRIE
 BASHKIA LEZHE
 PROJEKT ZBATIMI
 SISTEMIM ASFALTIM I RRUGES AZEM HAJDARI

Firma Name and Address

 BASHKIA LEZHE
 DREJTORIA E PLANIFIKIMI
 DHE ZHVILLIMIT TE
 TERRITORIT

Ark.DODE ZHUBA	
Ing.ADIONA MARTINI	
Ing.GJOVALIN MARKU	
Ing.GJON LUCA	
Ing.ALBAN LAÇI	

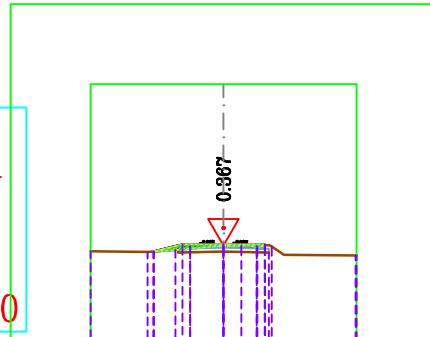
Projekt seksionet terthore	Sheet
Date Janar 2019	
Shkalle 1:500	

AKSI AZ
 Numeri Profil : -33-
 Progresivi : 1+600.00
 Shkalla : 500:500
 Kuota.Referuese : -7.50



DIST.PROGRES.TERENIT	10.00	5.72	3.63	0.70	0.00	1.35	2.00	2.54	3.17	4.55	9.92	10.00	
KUOTA TERENIT	-0.05	-0.11	0.03	0.32	0.33	0.36	0.37	0.24	0.40	-0.32	-0.37	-0.37	
DIST.PJESORE.TERENIT													
DIST.PROGRES.PROJEKTI	10.00	5.72	3.63	0.70	0.00	1.35	2.00	2.54	3.17	3.46	4.55	9.92	10.00
KUOTA PROJEKTIT	-0.05	-0.11	0.03	0.32	0.33	0.36	0.37	0.24	0.40	0.39	-0.32	-0.37	-0.37
DIST.PJESORE.PROJEKTIT													





 REPUBLIKA E SHQIPËRISE
 BASHKIA LEZHE
 PROJEKT ZBATIMI
 SISTEMIM ASFALTIM I RRUGES AZEM HAJDARI

Firma Name and Address

 BASHKIA LEZHE
 DREJTORIA E PLANIFIKIMI
 DHE ZHVILLIMIT TE
 TERRITORIT

Ark.DODE ZHUBA	
Ing.ADIONA MARTINI	
Ing.GJOVALIN MARKU	
Ing.GJON LUCA	
Ing.ALBAN LAÇI	

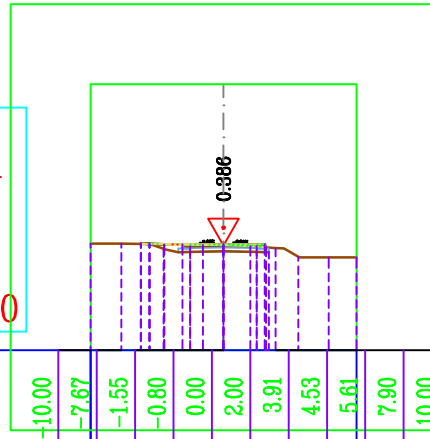
Projekt	seksionet terthore	Sheet
Data	Janar 2019	
Shkalla	1:500	

AKSI AZ
 Numeri Profilit : -34-
 Progresivi : 1+650.00
 Shkalla : 500:500
 Kuota.Referuese : -7.50



DIST.PROGRES.TERENIT	-10.00	-7.67	-1.55	-0.80	0.00	2.00	3.91	4.53	5.61	7.90	10.00	
KUOTA TERENIT	0.51	0.53	0.42	0.42	0.39	0.34	0.19	0.15	-0.46	-0.52	-0.52	
DIST.PJESORE.TERENIT												
DIST.PROGRES.PROJEKTIT	-10.00	-7.67	-1.55	-0.80	0.00	2.00	3.91	4.53	5.61	5.94	7.90	10.00
KUOTA PROJEKTIT	0.51	0.53	0.42	0.42	0.39	0.34	0.19	0.15	-0.46	-0.52	-0.52	-0.52
DIST.PJESORE.PROJEKTIT												





 REPUBLIKA E SHQIPËRIE
 BASHKIA LEZHE
 PROJEKT ZBATIMI
 SISTEMIM ASFALTIM I RRUGES AZEM HAJDARI

Firma Name and Address

 BASHKIA LEZHE
 DREJTORIA E PLANIFIKIMI
 DHE ZHVILLIMIT TE
 TERRITORIT

Ark.DODE ZHUBA	
Ing.ADIONA MARTINI	
Ing.GJOVALIN MARKU	
Ing.GJON LUCA	
Ing.ALBAN LAÇI	

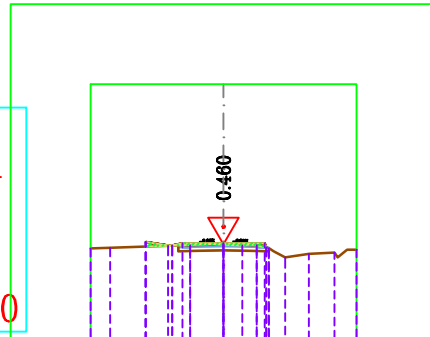
Projekt seksionet terthore	Sheet
Data Janar 2019	
Shkalla 1:500	

AKSI AZ
 Numeri Profil : -35-
 Progresivi : 1+700.00
 Shkalla : 500:500
 Kuota.Referuese : -7.50



DIST.PROGRES.TERENIT	10.00	8.53	7.77	7.00	6.41	6.00	5.64	5.34	5.00	4.64	4.26	3.84	3.37	2.85	2.28	1.66	1.00	0.30	0.00	
KUOTA TERENIT	0.16	0.21	0.47	0.43	0.37	0.45	0.40	0.18	-0.06	-0.52	-0.26	-0.16	0.01	0.07						
DIST.PJESORE.TERENIT																				
DIST.PROGRES.PROJEKTI	10.00	8.53	7.77	7.00	6.41	6.00	5.64	5.34	5.00	4.64	4.26	3.84	3.37	2.85	2.28	1.66	1.00	0.30	0.00	
KUOTA PROJEKTIT	0.16	0.21	0.47	0.43	0.37	0.45	0.40	0.18	-0.06	-0.52	-0.26	-0.16	0.01	0.07						
DIST.PJESORE.PROJEKTIT																				





 REPUBLIKA E SHQIPËRIE
 BASHKIA LEZHE
 PROJEKT ZBATIMI
 SISTEMIM ASFALTIM I RRUGES AZEM HAJDARI

Firma Name and Address

 BASHKIA LEZHE
 DREJTORIA E PLANIFIKIMI
 DHE ZHVILLIMIT TE
 TERRITORIT

Ark.DODE ZHUBA	
Ing.ADIONA MARTINI	
Ing.GJOVALIN MARKU	
Ing.GJON LUCA	
Ing.ALBAN LAÇI	

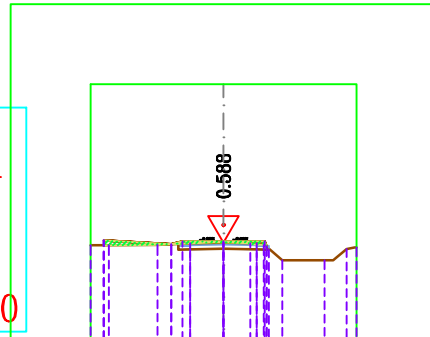
Projekt	seksionet terthore	Sheet
Data	Janar 2019	
Shkalla	1:500	

AKSI AZ
 Numeri Profil : -36-
 Progresivi : 1+750.00
 Shkalla : 500:500
 Kuota.Referuese : -7.50



DIST.PROGRES.TERENIT	-10.80	-8.62	-4.97	-0.71	0.00	0.68	2.00	3.03	4.41	7.60	8.25	9.25	9.85	10.00	
KUOTA TERENIT	0.41	0.39	0.43	0.60	0.59	0.58	0.54	0.42	-0.73	-0.73	-0.73	0.12	0.23	0.23	
DIST.PJESORE.TERENIT															
DIST.PROGRES.PROJEKTIT	-10.80	-8.62	-4.97	-0.71	0.00	0.68	2.00	3.03	4.41	7.60	8.25	8.55	9.25	9.85	10.00
KUOTA PROJEKTIT	0.41	0.39	0.43	0.60	0.59	0.58	0.54	0.42	-0.73	-0.73	-0.73	-0.48	0.12	0.23	0.23
DIST.PJESORE.PROJEKTIT															





 REPUBLIKA E SHQIPËRIE
 BASHKIA LEZHE
 PROJEKT ZBATIMI
 SISTEMIM ASFALTIM I RRUGES AZEM HAJDARI

Firma Name and Address

 BASHKIA LEZHE
 DREJTORIA E PLANIFIKIMI
 DHE ZHVILLIMIT TE
 TERRITORIT

Ark.DODE ZHUBA	
Ing.ADIONA MARTINI	
Ing.GJOVALIN MARKU	
Ing.GJON LUCA	
Ing.ALBAN LAÇI	

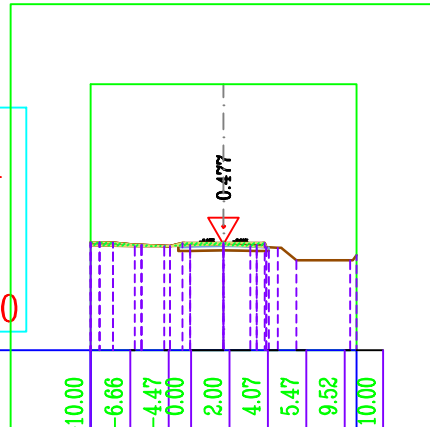
Projekt seksionet terthore	Sheet
Data Janar 2019	
Shkalla 1:500	

AKSI AZ
 Numeri Profil : -37-
 Progresivi : 1+800.00
 Shkalla : 500:500
 Kuota.Referuese : -7.50



DIST.PROGRES.TERENIT		-10.00	-6.66	-4.47	0.00	2.00	4.07	5.47	9.52	10.00		
KUOTA TERENIT		0.40	0.33	0.32	0.42	0.33	0.21	-0.73	-0.73	-0.35		
DIST.PJESORE.TERENIT												
DIST.PROGRES.PROJEKTIT	-10.00	-6.66	-4.47	-0.49	0.00	0.33	2.00	4.07	4.34	5.47	9.52	10.00
KUOTA PROJEKTIT	0.40	0.33	0.32	0.44	0.42	0.40	0.33	0.21	0.20	-0.73	-0.73	-0.35
DIST.PJESORE.PROJEKTIT												





 REPUBLIKA E SHQIPËRISE
 BASHKIA LEZHE
 PROJEKT ZBATIMI
 SISTEMIM ASFALTIM I RRUGES AZEM HAJDARI

Firm Name and Address

 BASHKIA LEZHE
 DREJTORIA E PLANIFIKIMI
 DHE ZHVILLIMIT TE
 TERRITORIT
 Ark.DODE ZHUBA
 Ing.ADIONA MARTINI
 Ing.GJOVALIN MARKU
 Ing.GJON LUCA
 Ing.ALBAN LAÇI

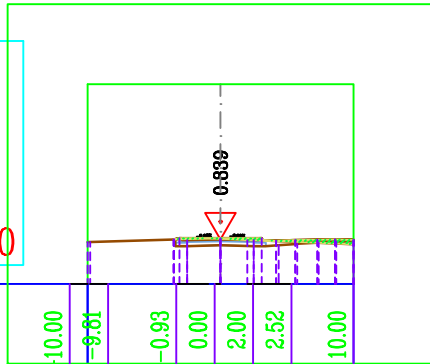
Projekt
 seksionet terthore
 Date
 Janar 2019
 Shkalle
 1:500

AKSI AZ
 Numeri Profil : -38-
 Progresivi : 1+850.00
 Shkalla : 500:500
 Kuota.Referuese : -2.50



DIST.PROGRES.TERENIT	10.00	9.81	0.93	0.00	2.00	2.52	10.00
KUOTA TERENIT	0.65	0.65	0.90	0.88	0.78	0.79	0.46
DIST.PJESORE.TERENIT							
DIST.PROGRES.PROJEKTIT	-10.00	-9.81	-0.93	0.00	2.00	2.52	10.00
KUOTA PROJEKTIT	0.65	0.65	0.90	0.88	0.78	0.79	0.46
DIST.PJESORE.PROJEKTIT							



 REPUBLIKA E SHQIPËRIE
 BASHKIA LEZHE
 PROJEKT ZBATIMI
 SISTEMIM ASFAL TIM I RRUGES AZEM HAJDARI

Firma Name and Address

 BASHKIA LEZHE
 DREJTORIA E PLANIFIKIMI
 DHE ZHVILLIMIT TE
 TERRITORIT

Ark.DODE ZHUBA	
Ing.ADIONA MARTINI	
Ing.GJOVALIN MARKU	
Ing.GJON LUCA	
Ing.ALBAN LAÇI	

Projekt seksionet terthore	Sheet
Date Janar 2019	
Shkalle 1:500	

AKSI AZ
 Numeri Profilit : -39-
 Progresivi : 1+900.00
 Shkalla : 500:500
 Kuota.Referuese : -2.50

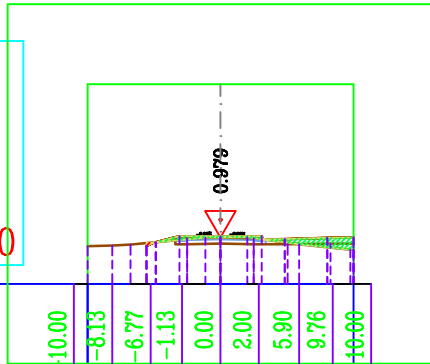

DIST.PROGRES.TERENIT	-10.00	-8.13	-6.77	-1.13	0.00	2.00	5.90	9.76	10.00
KUOTA TERENIT	0.32	0.38	0.46	0.97	0.98	0.99	0.46	0.06	0.07
DIST.PJESORE.TERENIT									
DIST.PROGRES.PROJEKTIT	-10.00	-8.13	-6.77	-1.13	0.00	2.00	5.90	9.76	10.00
KUOTA PROJEKTIT	0.32	0.38	0.46	0.97	0.98	0.99	0.46	0.06	0.07
DIST.PJESORE.PROJEKTIT									



 REPUBLIKA E SHQIPËRISE
 BASHKIA LEZHE
 PROJEKT ZBATIMI
 SISTEMIM ASFAL TIM I RRUGES AZEM HAJDARI

Firma Name and Address

 BASHKIA LEZHE
 DREJTORIA E PLANIFIKIMI
 DHE ZHVILLIMIT TE
 TERRITORIT

Ark.DODE ZHUBA	
Ing.ADIONA MARTINI	
Ing.GJOVALIN MARKU	
Ing.GJON LUCA	
Ing.ALBAN LAÇI	

Projekt seksionet terthore	Sheet
Data Janar 2019	
Shkalla 1:500	

AKSI AZ
 Numeri Profilit : -40-
 Progresivi : 1+950.00
 Shkalla : 500:500
 Kuota.Referuese : -2.50

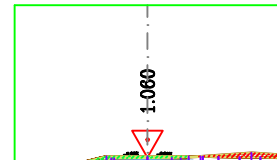

DIST.PROGRES.TERENIT	-10.00	-3.80	-2.72	0.00	1.82	3.98	7.81	10.00
KUOTA TERENIT	0.43	0.63	1.00	1.02	1.03	1.16	1.40	1.26
DIST.PJESORE.TERENIT								
DIST.PROGRES.PROJEKTIT	-10.00	-3.80	-2.72	0.00	1.82	3.98	7.81	10.00
KUOTA PROJEKTIT	0.43	0.63	1.00	1.02	1.03	1.16	1.40	1.26
DIST.PJESORE.PROJEKTIT								



REPUBLICA E SHQIPËRIE
 BASHKIA LEZHE
 PROJEKT ZBATIMI
 SISTEMIM ASFAL TIM I RRUGES AZEM HAJDARI

Firma Name and Address
 BASHKIA LEZHE
 DREJTORIA E PLANIFIKIMI
 DHE ZHVILLIMIT TE
 TERRITORIT

Ark.DODE ZHUBA	
Ing.ADIONA MARTINI	
Ing.GJOVALIN MARKU	
Ing.GJON LUCA	
Ing.ALBAN LAÇI	

Projekt seksionet terthore	Sheet
Data Janar 2019	
Shkalla 1:500	

AKSI AZ
 Numeri Profilit : -41-
 Progresivi : 1+968.84
 Shkalla : 500:500
 Kuota.Referuese : -7.50

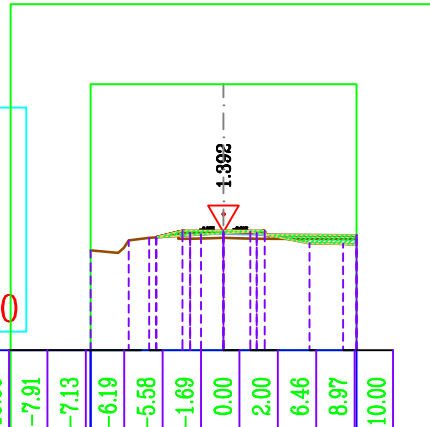

DIST.PROGRES.TERENIT	-10.00	-7.91	-7.13	-6.19	-5.58	-1.69	0.00	2.00	6.46	8.97	10.00
KUOTA TERENIT	0.02	-0.17	0.75	0.88	0.96	1.21	1.30	1.41	0.54	0.50	0.48
DIST.PJESORE.TERENIT											
DIST.PROGRES.PROJEKTI	-10.00	-7.91	-7.13	-6.19	-5.58	-1.69	0.00	2.00	6.46	8.97	10.00
KUOTA PROJEKTI	-0.17	0.22	0.75	0.88	0.96	1.21	1.30	1.41	0.54	0.50	0.48
DIST.PJESORE.PROJEKTIT											



 REPUBLIKA E SHQIPËRISE
 BASHKIA LEZHE
 PROJEKT ZBATIMI
 SISTEMIM ASFALTIM I RRUGES AZEM HAJDARI

Firma Name and Address

 BASHKIA LEZHE
 DREJTORIA E PLANIFIKIMI
 DHE ZHVILLIMIT TE
 TERRITORIT

Ark.DODE ZHUBA	
Ing.ADIONA MARTINI	
Ing.GJOVALIN MARKU	
Ing.GJON LUCA	
Ing.ALBAN LAÇI	

Projekt seksionet terthore	Sheet
Data Janar 2019	
Shkalle 1:500	