

MIRATOHET
KRYETARI I BASHKISE
MALIQ
GËZIM TOPÇIU

PROJEKT
ZBATIMI

SISTEMIM
ASFALTIM I RRUGËS
HYRËSE FSHATI ZVIRINË

(Faza I)

Prilli 2019

SISTEMIM ASFALTIM I RRUGËS HYRËSE I FSHATIT ZVIRINË (Faza I)

Qelimi	Auth.	Dr.	Sikalla	Doc. number
Per Aprovimi	Ing.S. KOTI	Ing.M. ZHULLI		Page: Nr. 1
Emertimi i vizatimit				
KAPAKU				

DREKTORIA E PLANIFIKIMIT
DHE KONTROLLIT TE
ZHVILLIMIT TE TERRITORT
ING. ENKELLEDA JONUSILARI

SKEMA ORJENTUESE

SHK - 1 : 25000

MIRATOHET
KRYETARI I BASHKISE
MALIQ
GËZIM TOPÇIU



LEGJENDA

Rruga që do të Rikonstruktohet

SISTEMIM ASFALTIM | RRUGËS HYRËSE | FSHATIT ZVIRINË (Faza I)

Qelimi	Auth.	Dr.	Shtetli	Doc. number
Per Aproxim	Ing.S.KOTI	Ing.M.ZHULLI		Page:Nr. 3
Emertimi i vizatimit				
SKEMA DRIENTUSE				

DREJTORIA E PLANIFIKIMIT
DHE KONTROLLIT TE
ZHVILLIMIT TE TERRITORIT
ING.ENKELIDA JONUSILARI

Sc - 10

Sc - 11

Sc - 12

Sc - 13

0+225.00

0+250.00

0+275.00

0+300.00



SISTEMIM ASFALTIM I RRUGËS HYRËSE I FSHATIT ZVIRINË (Faza I)

Qelimi	Autb.	Dr.	Shkalla	Doc. number
Per Aprovim	Ing.S.KOTI			Page: Nr. 8
Emertimi i vizatimit				DREKTORIA E PLANIFIKIMIT URBAN DHE PROJEKTIVE INGENJERLEJDA JONUSILARI
PLANIMETRIA E ZBATIMIT TË BOKSIT				

PLANIMETRI E RRUGËS AKSI "A"

1:500

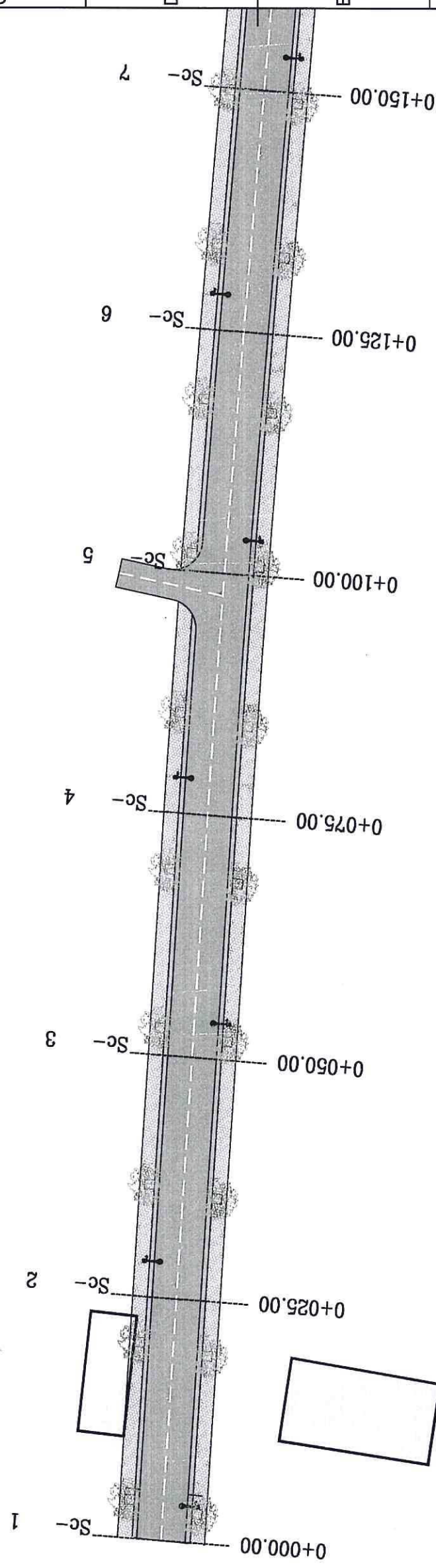

Vahide Genda

PROJEKT ZBATIMI			
Punoi Ing. Fes DEROMEAJ	Kontrollor Ing. Indrit KOLECI	Miratoi - data Ing. Vahide GRUDA	Emri i dokumentit Emri i dokumentit
PALMA CONSTRUCTION sh.p.k. Tirana, Shqipëri Buz. Bajram Curri, Palasat Agrar, H. & Aq. 05 audopajma@outlook.com +355 68 403 0581		Sistemi-Asfaltim Rrugë të brëndshme rrjeti i ujësllësit +KUZ F'sharrt Zvërinë PLANIMETRI e RRUGËS	
Shkalla në A3 1:500		Data Korrik 2017	Nr. Fletës C-101

PLANIMETRI E RRUGËS AKSI "A"

1:500

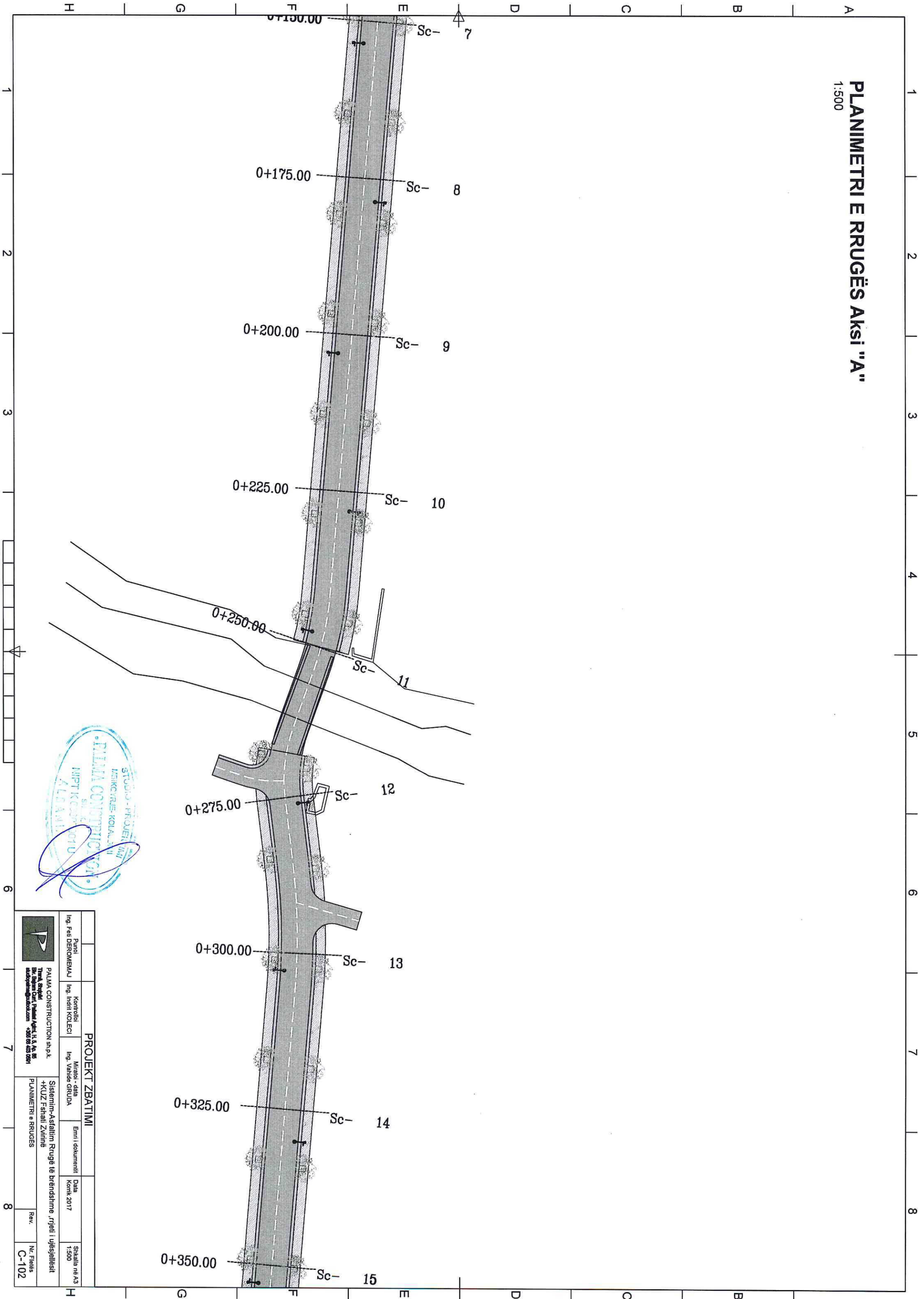

PROJEKT ZBATIMI			
Punoi Ing. Fati DEROMEAJ	Kontrollori Ing. Indrit KOLECI	Mirator - data Ing. Vahide GRUDA	Data Korrik 2017
PALMA CONSTRUCTION sh.p.k. Tirana, Shqipëri Bulevardi "Dëshmorët e Kombit" Nr. 10 Kontakt: +355 69 888 888		Sistemi - Asfaltim Rrugë të brëndshme, rrjetit i ujësjellësit + KULZ Fshatit Zvërnë	
PLANIMETRI E RRUGËS			Nr. Folia C-102

PROFIL GJATËSOR - AKSIA

1:1500 | 1:150

NIVELLETA

$D=60.00m$ $I=-2.81\%$ $Ah=-0.74m$	$L=47.49m$ $R=2425.83$	$L=130.13m$ $I=-0.85\%$ $Ah=-1.18m$	$L=28.24m$ $R=7786.05$	$D=64.13m$ $I=-0.52\%$ $Ah=-0.13m$	$L=24.18m$ $R=2000.00$	$L=40.11m$ $I=-1.23\%$ $Ah=-0.80m$	$L=33.48m$ $R=3000.00$
--	---------------------------	---	---------------------------	--	---------------------------	--	---------------------------

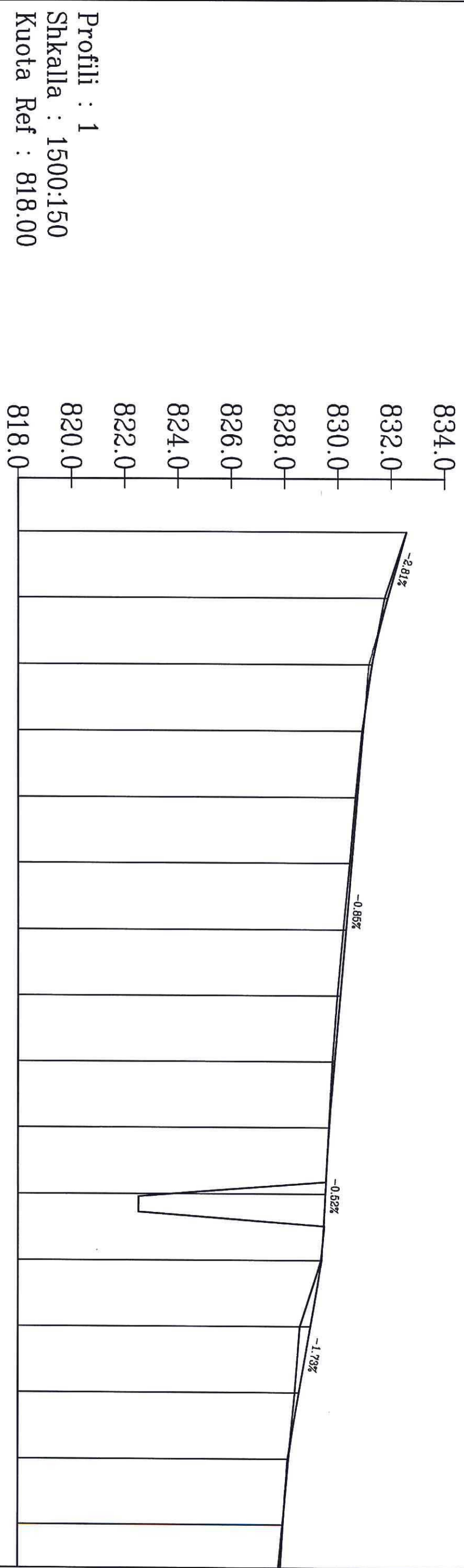

Profili : 1
Shkalla : 1500:150
Kuota Ref : 818.00

NUMERI PROFILIEVE	DISTANCA PROGRESIVE	DISTANCA PJESORE	KUOTA E TERENIT	KUOTA E PROJEKTT
Sc-1	0+000.00	25,00	832.57	832.57
Sc-2	0+025.00	25,00	831.75	831.86
Sc-3	0+050.00	25,00	831.28	831.28
Sc-4	0+075.00	25,00	830.91	830.95
Sc-5	0+100.00	25,00	830.67	830.73
Sc-6	0+125.00	25,00	830.45	830.52
Sc-7	0+150.00	25,00	830.20	830.31
Sc-8	0+175.00	25,00	829.98	830.09
Sc-9	0+200.00	25,00	829.80	829.88
Sc-10	0+225.00	25,00	829.67	829.68
Sc-11	0+250.00	25,00	823.76	829.54
Sc-12	0+275.00	25,00	829.37	829.37
Sc-13	0+300.00	25,00	828.57	828.98
Sc-14	0+325.00	25,00	828.39	828.55
Sc-15	0+350.00	25,00	828.16	828.16
Sc-16	0+375.00	25	827.94	827.96

GJEOMETRIA HORIZONTALE

KILOMETRAZHI



PROJEKT ZBATTIMI

Puni	Kontrolli	Mirato	Emri i dokumentit	Data	Shkalla në A3
Ing. Fae DEROMEVAJ	Ing. Indrit KOLECI	Ing. Vahide GRUDA		Korrik 2017	1:1500 1:150
PALMA CONSTRUCTION sh.p.k.			Sistemi i Asfaltim Rrugë të Brëndshme .rtjefit i njëjtelisht		
+KUZ Eshtell Zvithë			PROFIL GJATËSOR - AKSIA A		
Rev.					Nr. Fielis
					C-201



PROFIL TËRTHOR - AKSI A

1:100

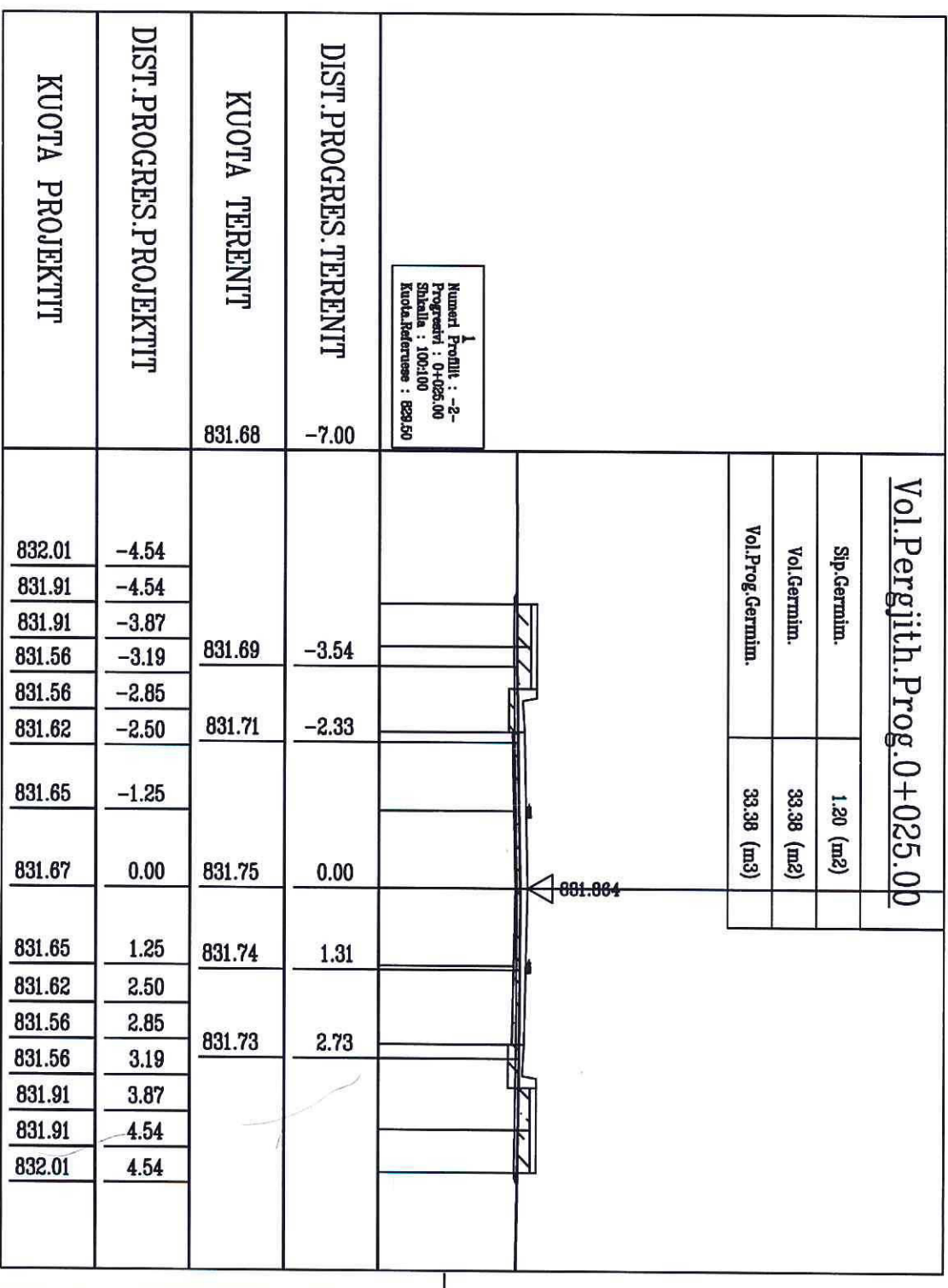
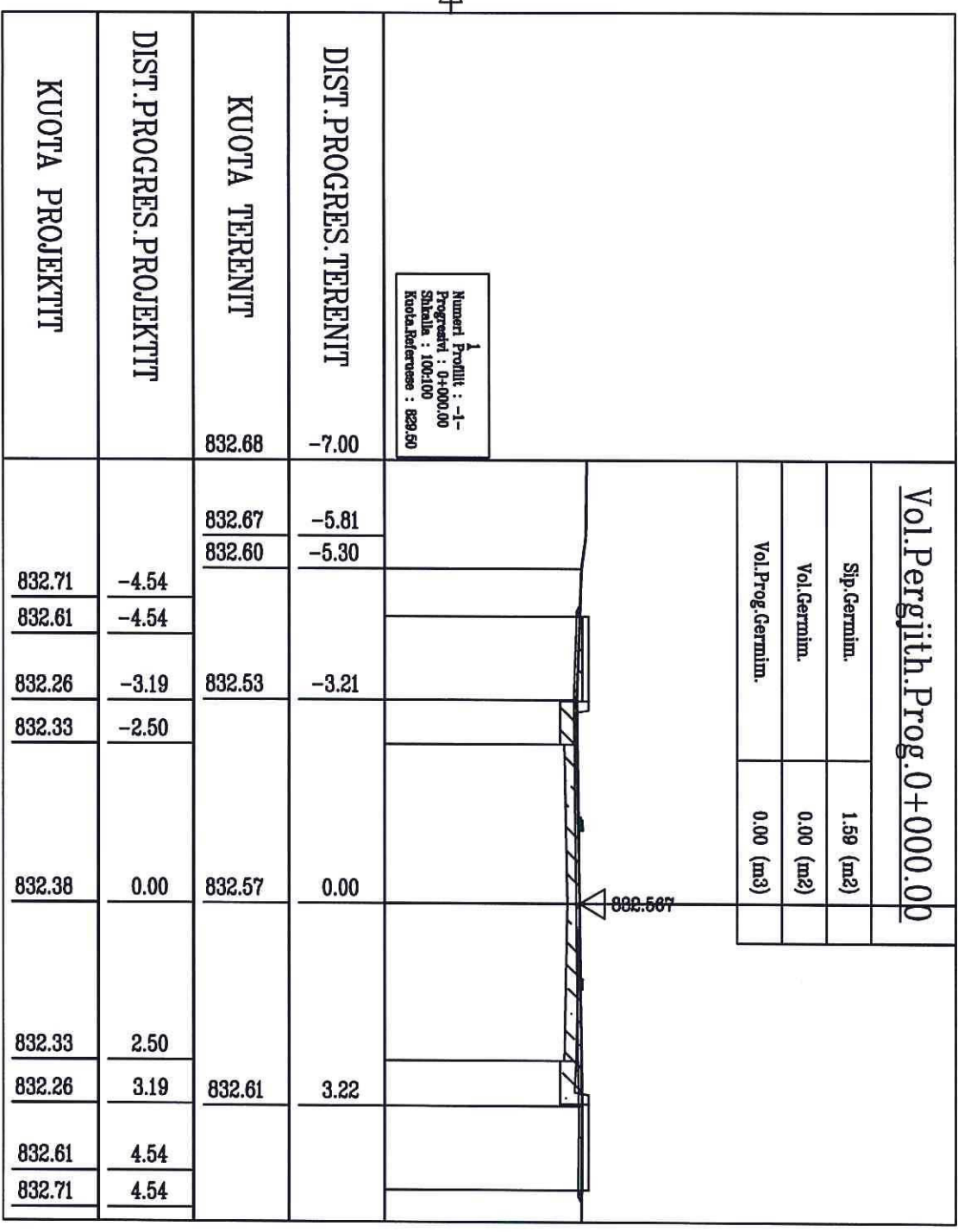

Numeri Profil: -1-
Prograsti: 0+000.00
Shkalla: 100:100
Kuota.Referuese: 829.50

Numeri Profil: -2-
Prograsti: 0+025.00
Shkalla: 100:100
Kuota.Referuese: 829.50

DIST.PROGRES.TERENIT	832.67	832.60	832.53	832.57	832.61	832.61	832.71
KUOTA TERENIT	832.68						
DIST.PROGRES.PROJEKTTI	-4.54	-4.54	-3.19	-2.50	0.00	2.50	3.19
KUOTA PROJEKTTI	832.71	832.61	832.26	832.33	832.38	832.33	832.26

DIST.PROGRES.TERENIT	831.69	831.71	831.75	831.74	831.73	831.91	831.91
KUOTA TERENIT	831.68						
DIST.PROGRES.PROJEKTTI	-4.54	-4.54	-3.87	-3.19	-2.85	-2.50	-1.25
KUOTA PROJEKTTI	832.01	831.91	831.91	831.56	831.56	831.62	831.65



PROJEKT ZBATIMI

PROFIL TËRTHOR - AKSI A

Ing. Fati DEROMEVAU | Ing. Indrit KOLECI | Ing. Vahide GRUDA

Miratori | Emri i dokumentit | Data | Shkalla ne A3

1:100

Rev. | N. Fletës | C-301

PROFIL TËRTHOR - AKSI A

1:100

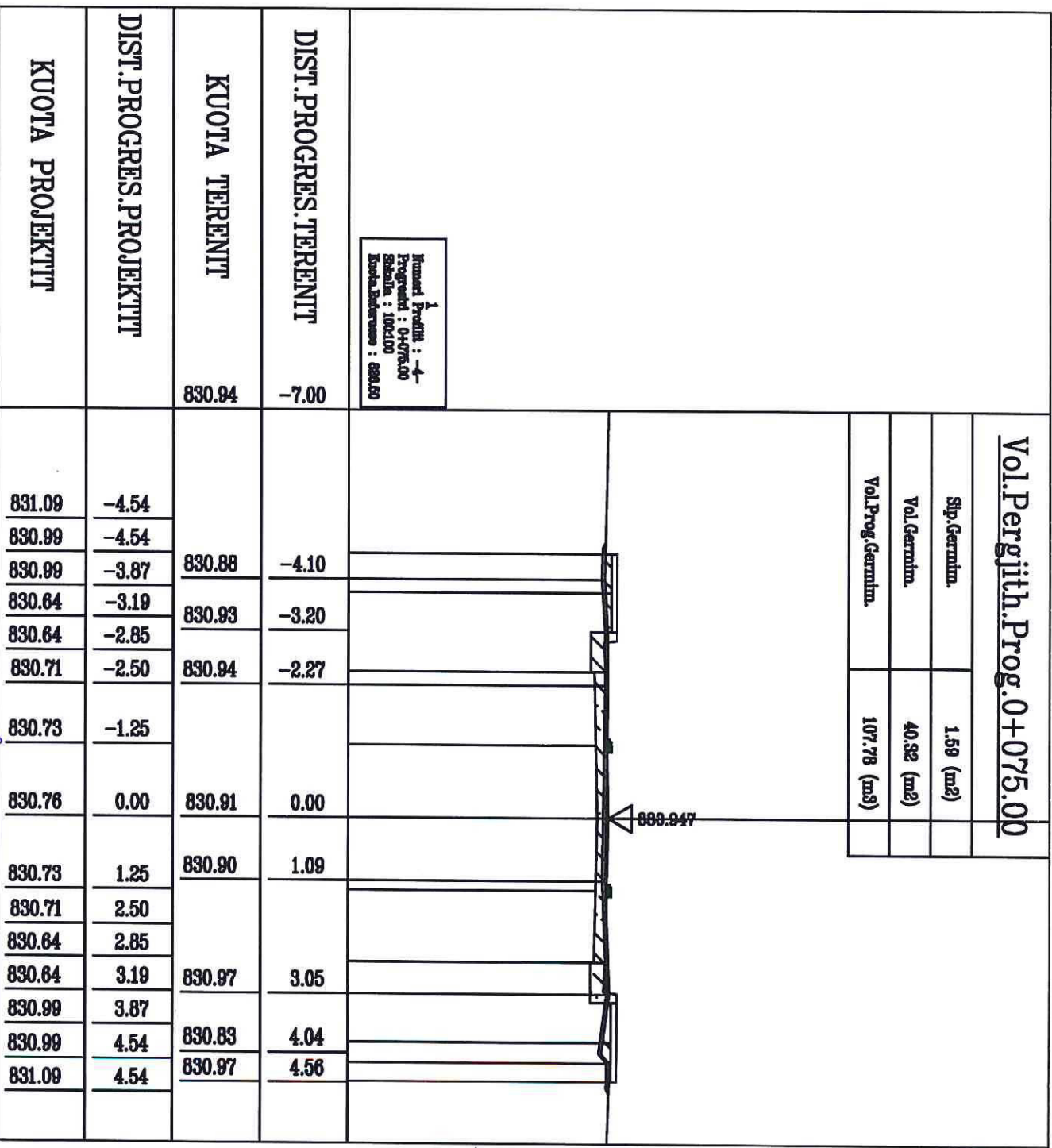
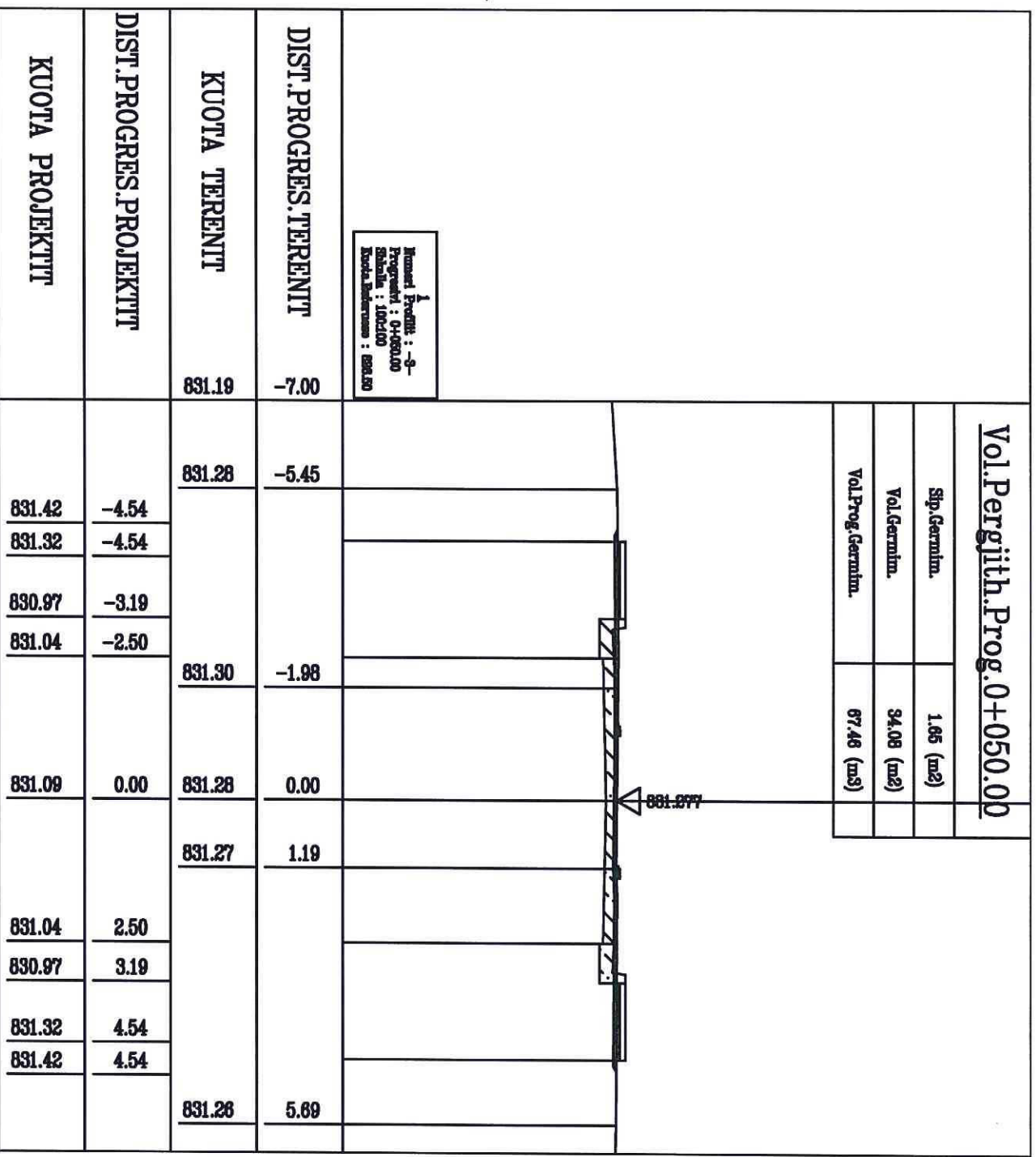

Komiteti Projektiv : -
 Projekti : 0+050.00
 Shkalla : 1:100
 Kuota Blerimes : 831.19

Komiteti Projektiv : -
 Projekti : 0+075.00
 Shkalla : 1:100
 Kuota Blerimes : 830.84



PROJEKT ZBATIMI	
Punoi Ing. Faei DEROMEJAJ	Kontrollori Ing. Indrit KOLECI
Miratori Ing. Vahide GRUDA	Emri i dokumentit Sistemi i Asistimit Rruges te Brendshme , rrethi i udhesjellesi
PALMA CONSTRUCTION sh.p.k Tirane, Shqipëri Bulevardi "Dimitri Shuteriqi" Nr. 10 Kontakt: +355 69 800 0891	
+KUZI Eshtari Zvëritë	
PROFIL TËRTHOR - AKSI A	Rev.
N. F. Fieles	
C-302	

1 2 3 4 5 6 7 8

PROFIL TËRTHOR - AKSI A

1:100

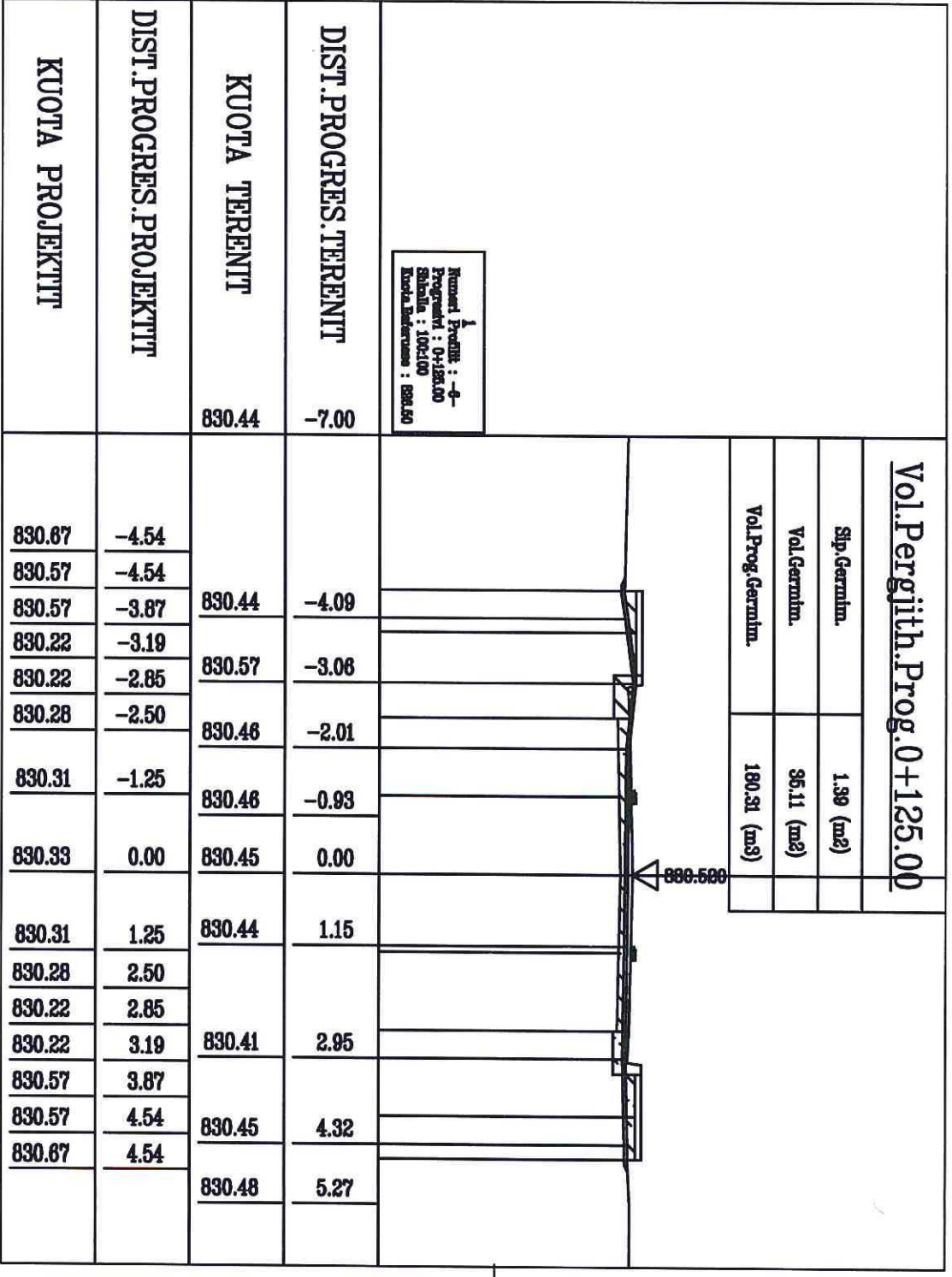
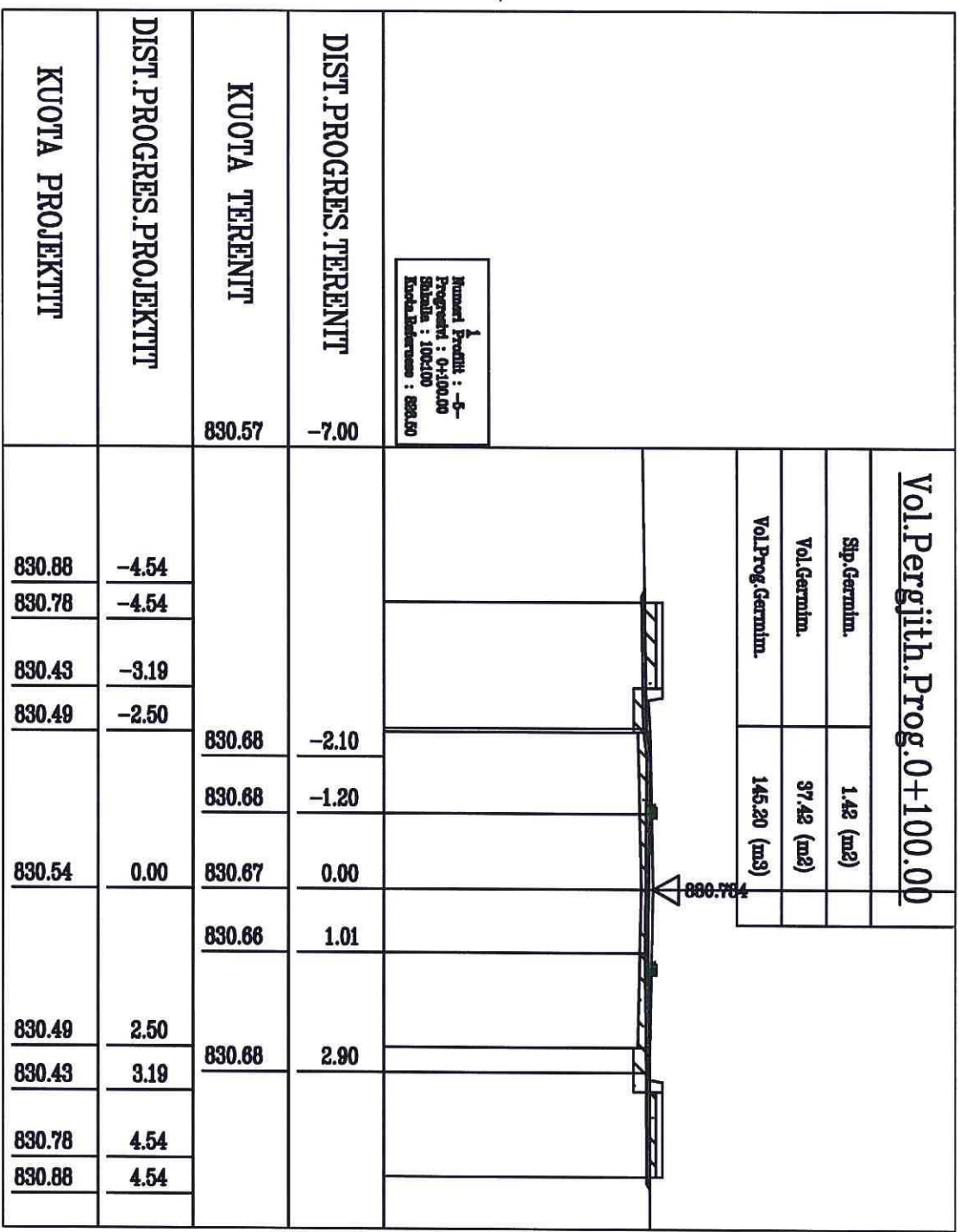

Numeri Projekt : -
 Progresi : 0+100.00
 Skala : 1:100
 Kuota Referenca : 830.50

Numeri Projekt : -
 Progresi : 0+125.00
 Skala : 1:100
 Kuota Referenca : 830.50



PROJEKTZBATIMI			
Puni	Kontrolli	Mirato	Emri i dokumentit
Ing. Fati DEROMEVAJ	Ing. Indrit KOLECI	Ing. Vahide GRUDA	Sistemi-Astallim Rrugë të Drëndshme ,rrethi i ujësjetësist +KUZ Fshati Zvirinë
PALMA CONSTRUCTION sh.p.k			PROFIL TËRTHOR - AKSI A
Tirana, Shqipëri Bulevardi "Dimitri Shuteriqi" Nr. 11, A. 10, B. 10 Tel: +355 68 820 0581 Email: info@palmaconstruction.com			Nr. Fielis C-303
Data: 2017			Skala: në A3 1:100
Rev.			

PROFIL TËRTHOR - AKSI A

1:100

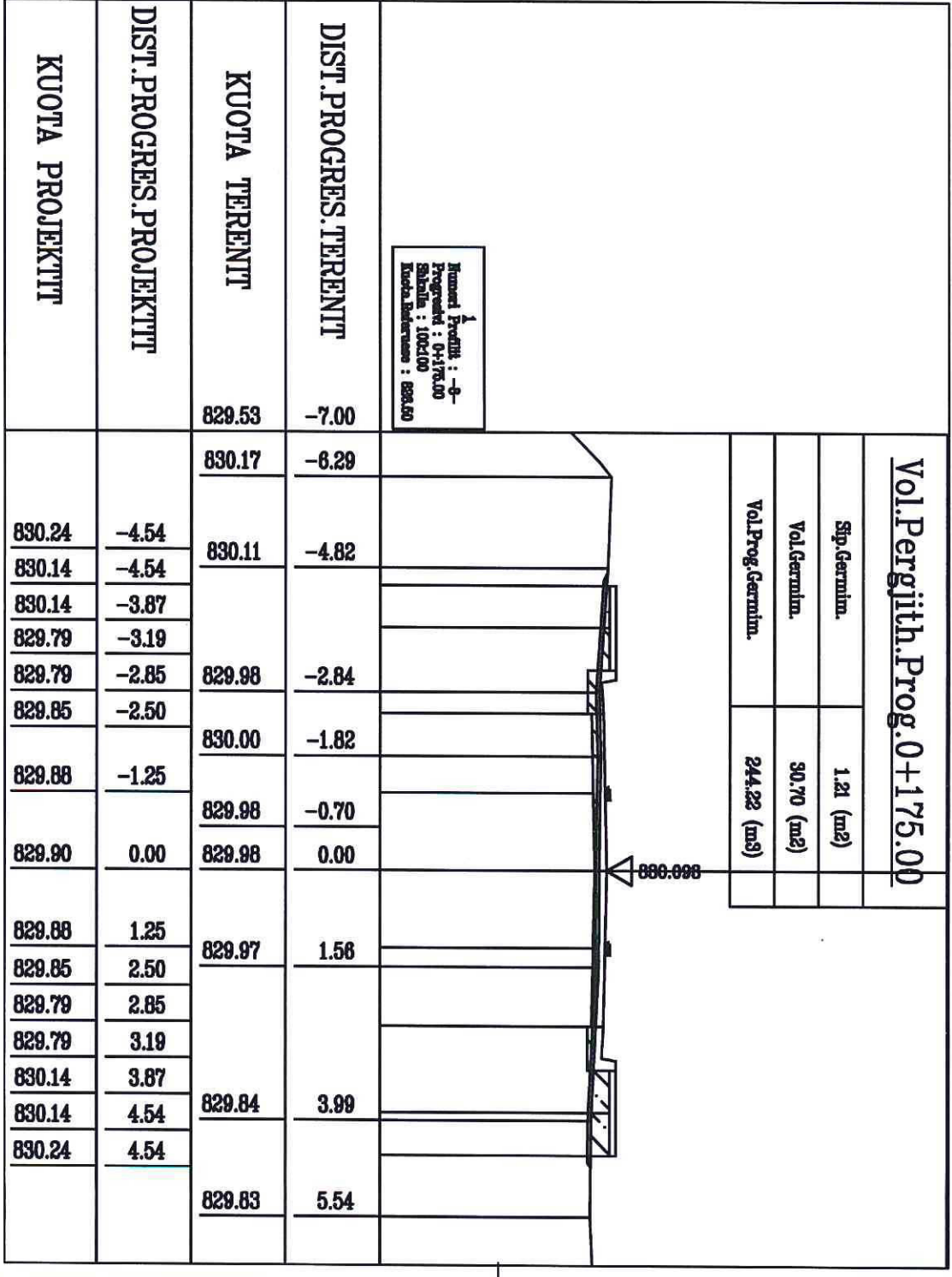
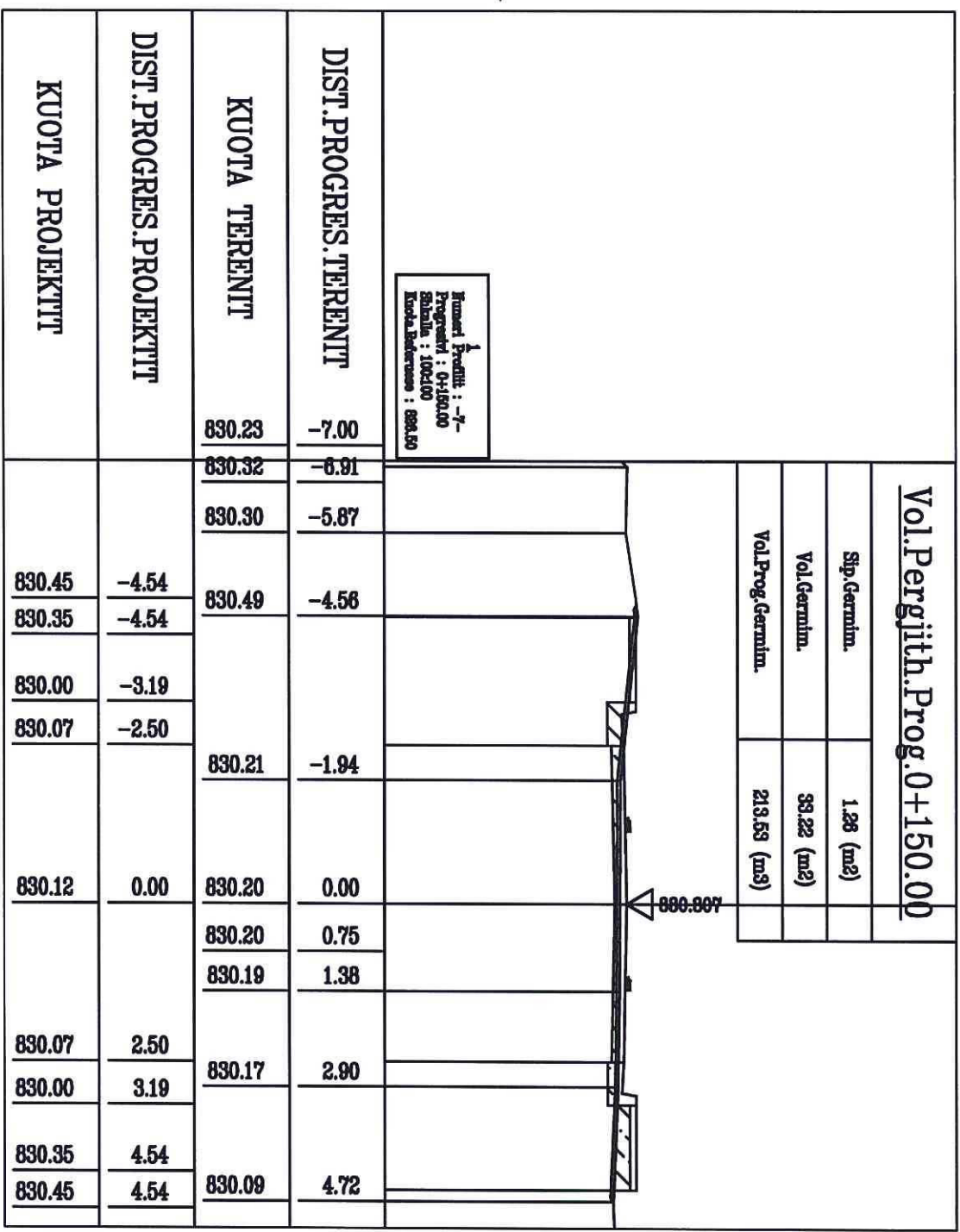

Numeri Projekt : -7-
 Programi : 0+150.00
 Shkalla : 1:100
 Kuota Referenca : 880.50

Numeri Projekt : -8-
 Programi : 0+175.00
 Shkalla : 1:100
 Kuota Referenca : 880.50



PROJEKT ZBATIMI				
Punoi	Kontrollori	Miratori	Emri i dokumentit	Data
Ing. Feli DEROMEAJ	Ing. Inerti KOLECI	Ing. Vahide GRUDA		Korrik 2017
PALMA CONSTRUCTION sh.p.k. Tiranë, Shqipëri www.palmaconstruction.com +355 69 401 0591		Sistemi i Asfaltim Rrugë të brëndshme ,rrethi i ujësjetesit +KUZ Fsheti Zvirinë		
PROFIL TËRTHOR - AKSI A				Rev.
				Nr. Fielis C-304

PROFIL TËRTHOR - AKSI A

1:100

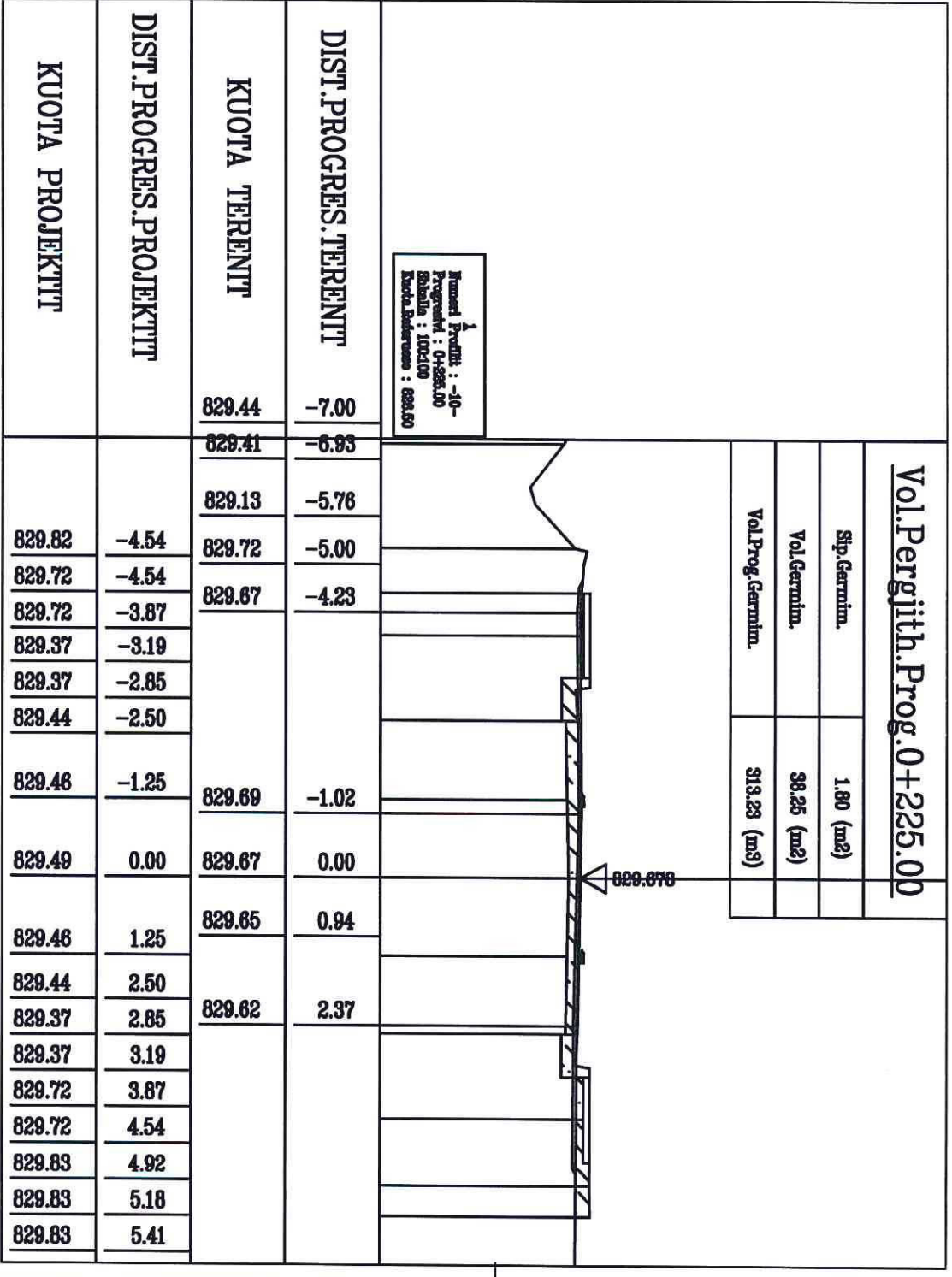
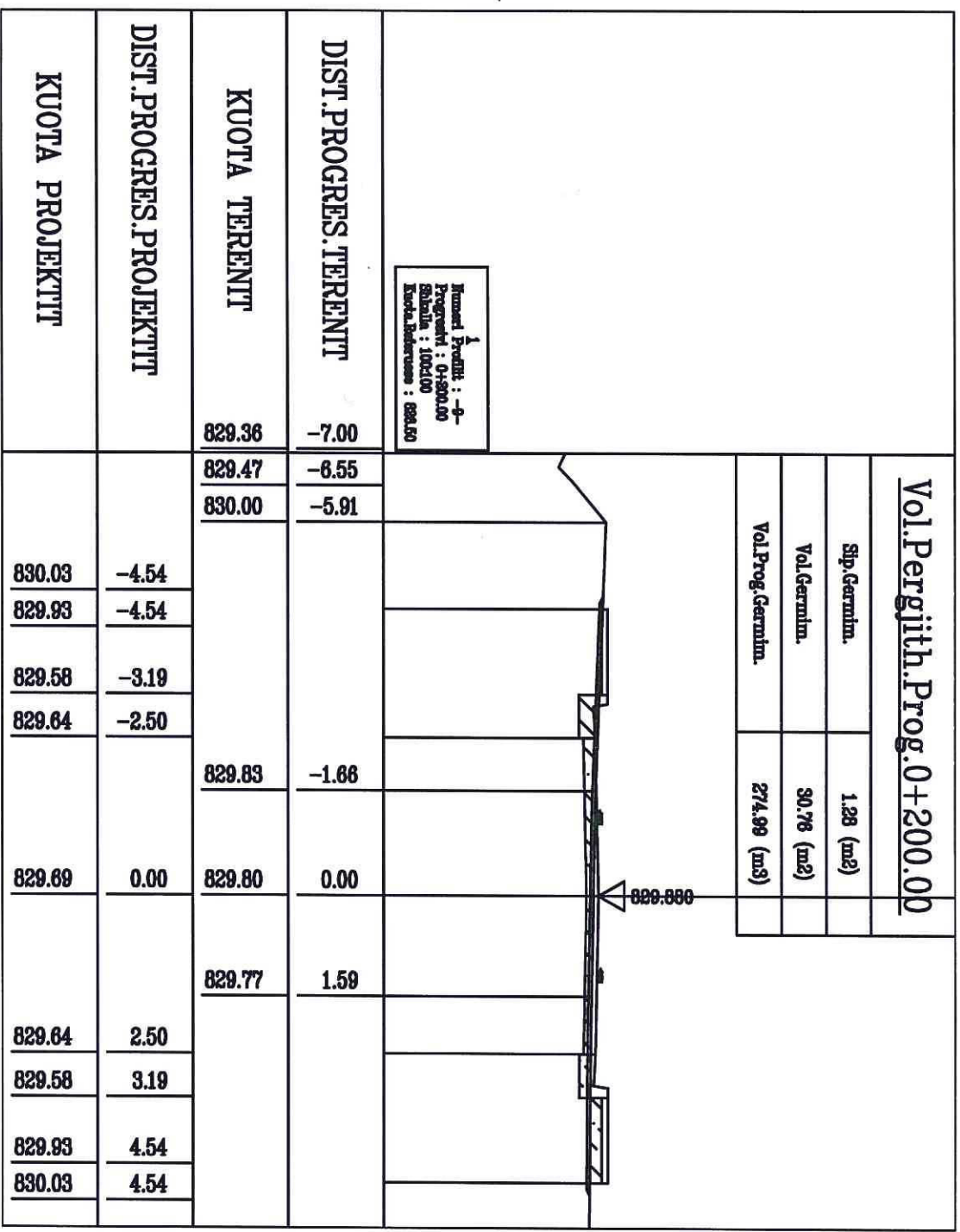

PROJEKT ZBATIMI			
Puni	Kontrolori	Miratori	Data
Ing. Fati DEROMEAJ	Ing. Indrit KOLECI	Ing. Vahide GRUDA	Korrik 2017
PALMA CONSTRUCTION sh.p.k.		Sistemim-Arsullim Rruges te Brëndshme ,rrejt i udhësjetësist	
Tirana, Shqipëri		+KUZ Fshati Zvërinë	
BKS: 01/17/2017		PROFIL TËRTHOR - AKSI A	
Rev.		N. Fletës	
		C-305	

1 2 3 4 5 6 7 8

PROFIL TËRTHOR - AKSIA

1:100

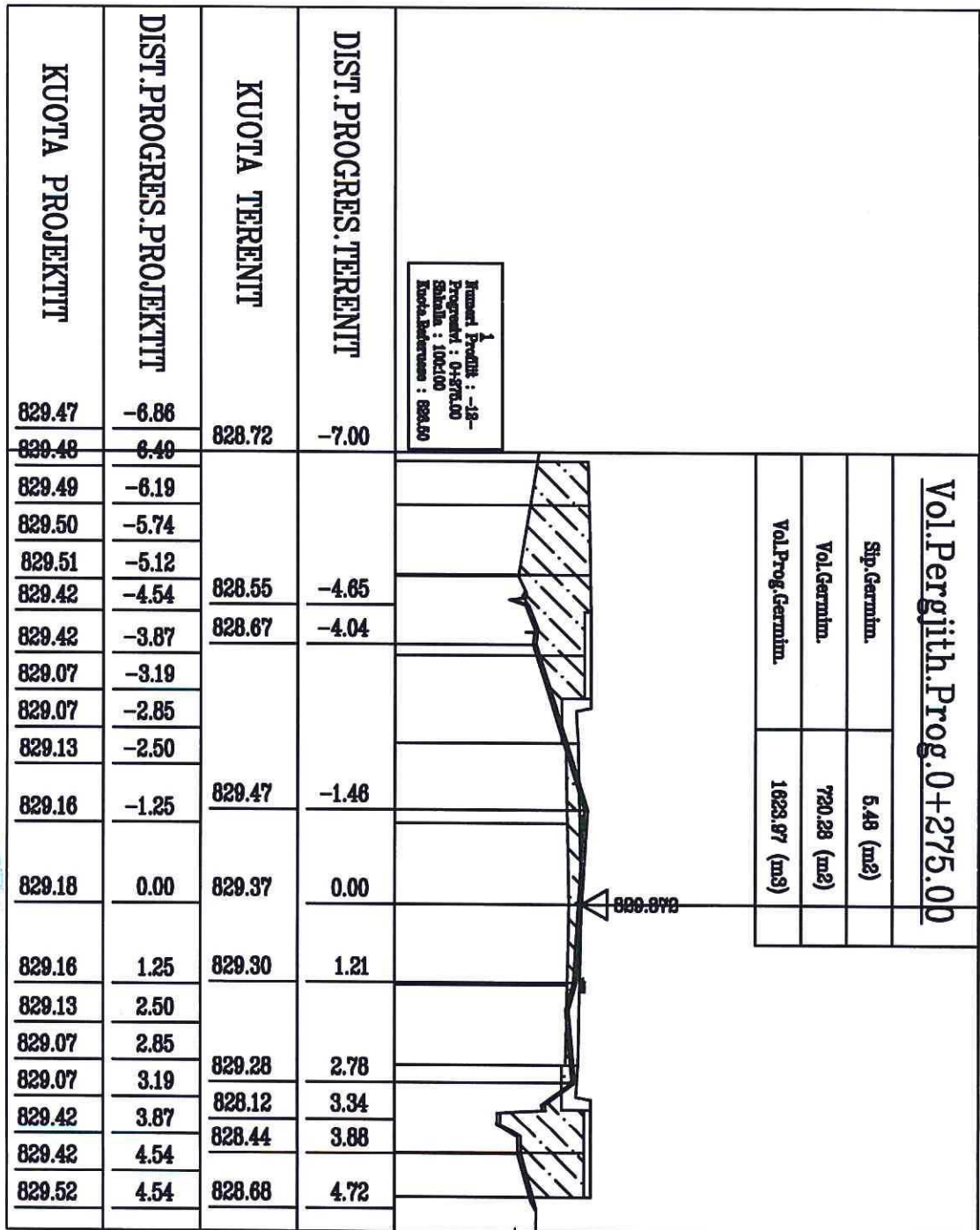
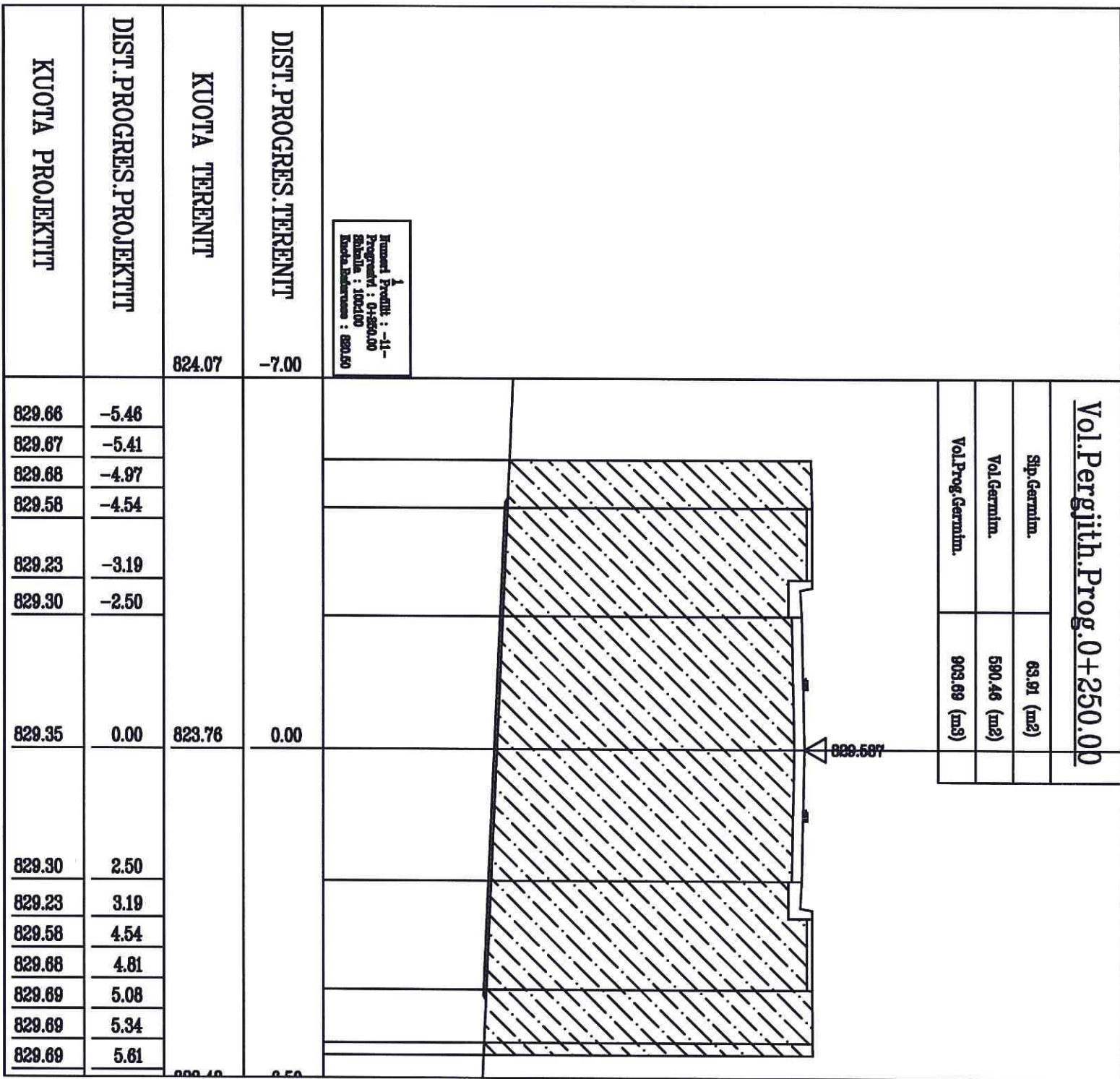

PROJEKT ZBATIMI			
Proj. Puni	Kontrollet	Mikrot	Emri i dokumentit
Ing. Fati DEROMEJAJ	Ing. Indrit KOLECI	Ing. Vahide GRUDA	Kornt. 2017
PALMA CONSTRUCTION sh.p.k. Tirane, Shqipëri Buzë Durrës, Peshëq, K. & A. No. 66 info@palmaconstruction.com *069 66 489 081			Sistemit-Asfaltim Rruge të brendshme , rruget i ujësjetesit +KUZ Fshati Zvërrinë
PROFIL TËRTHOR - AKSIA			Nr. Fletës C-306

PROFIL TËRTHOR - AKSI A

1:100

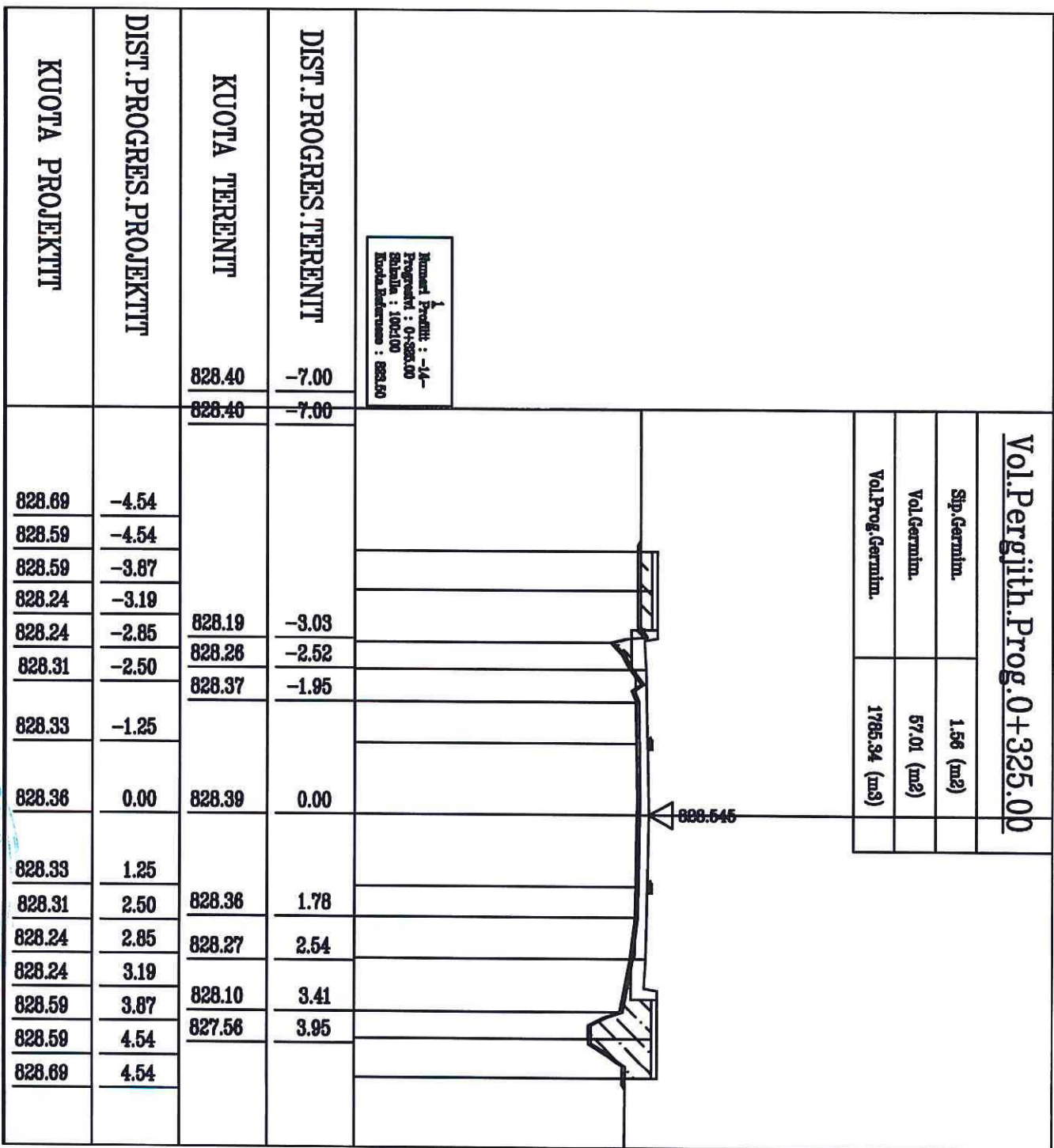
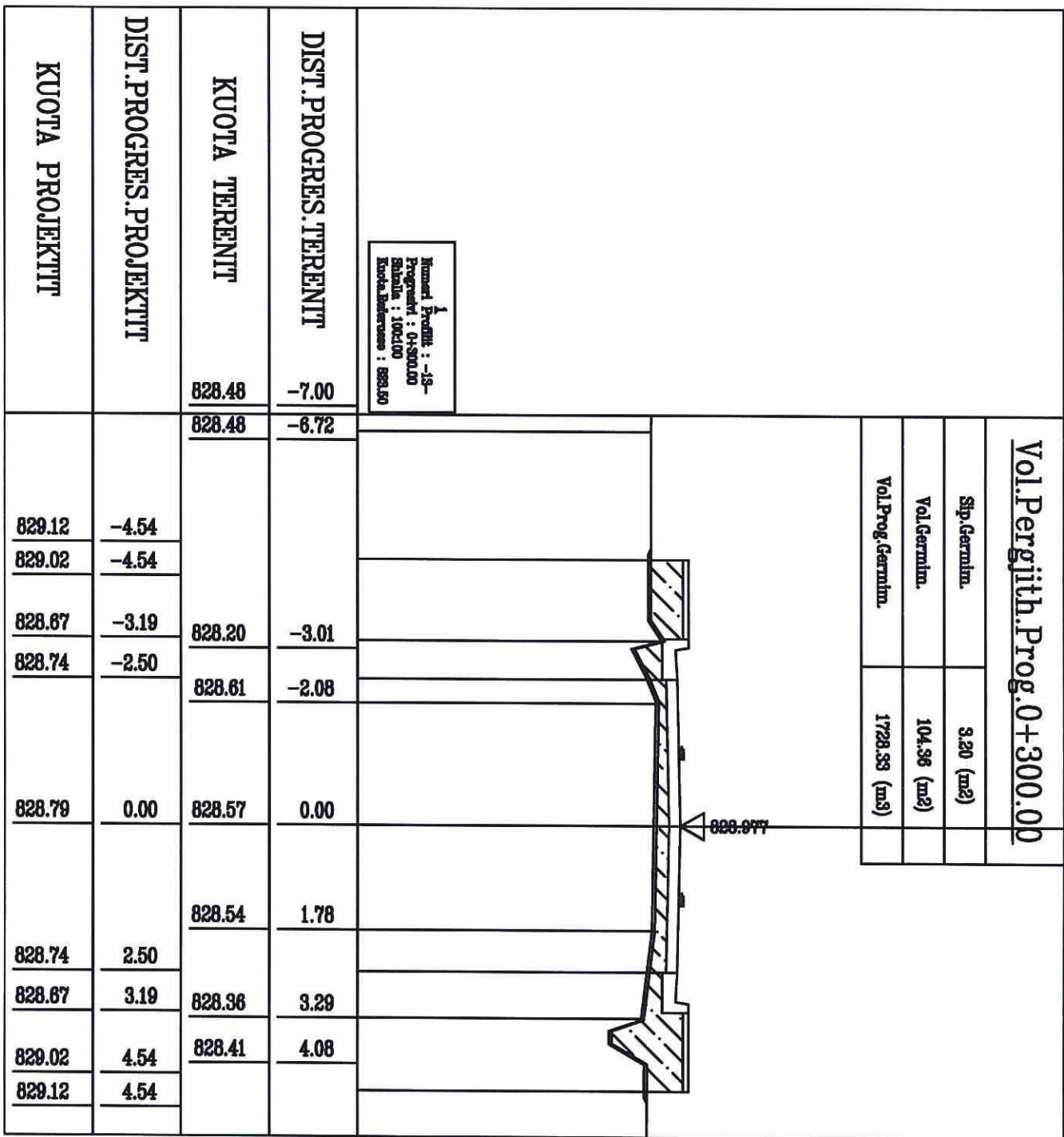

NUMERI PËRSHI : -13-
PROGRESI : 0+300.00
SHALLI : 100/100
KUOTA BASHKËSHTET : 828.50

NUMERI PËRSHI : -14-
PROGRESI : 0+325.00
SHALLI : 100/100
KUOTA BASHKËSHTET : 828.50



PROJEKT ZBATIMI			
Puri	Kontrolli	Mirato	Emri i dokumentit
Ing. Feli DEROMEJAJ	Ing. Indri KOLECI	Ing. Vahide GRUDA	Data
PALMA CONSTRUCTION sh.p.k.			Komk 2017
Sistemim-Astafim Rrugë të brendshme ,rrethi i ujësjetesi +KLUZ Fshati Zvërnë			Shkalla në A3
PROFIL TËRTHOR - AKSI A			1:100
Rev.			Nr. Fletës
			C-307

PROFIL TËRTHOR - AKSI A

1:100

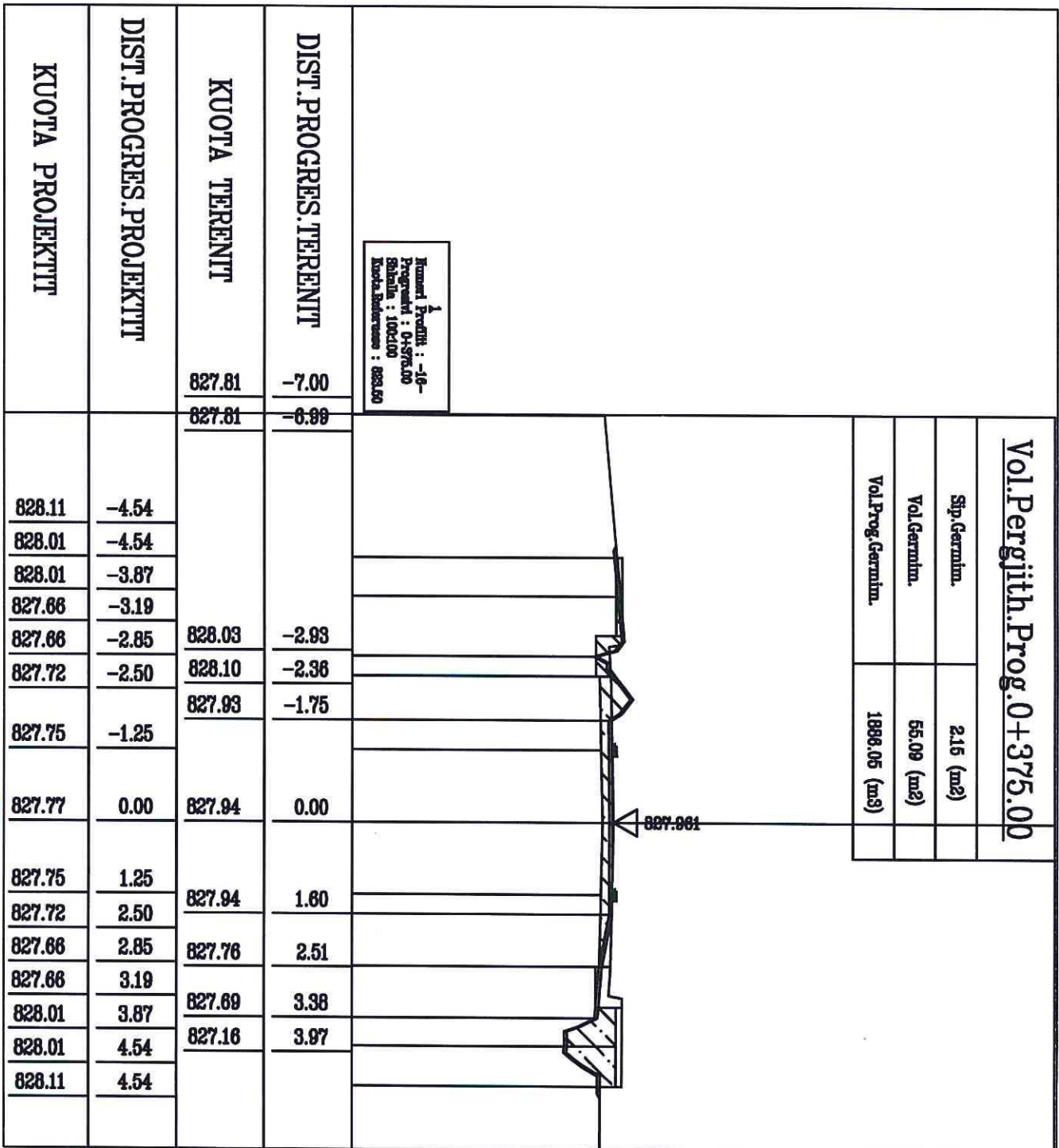
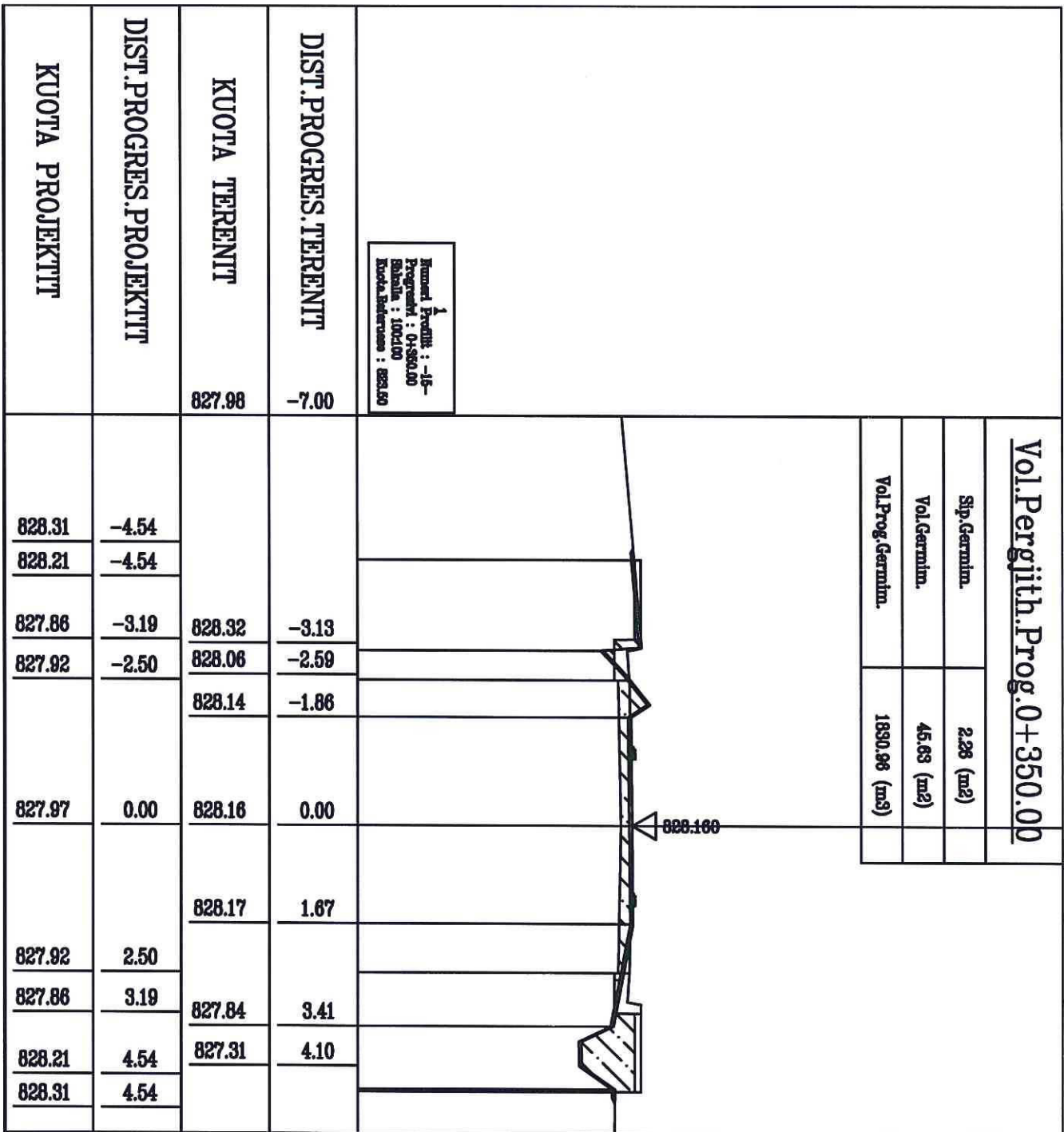

Numeri i Profilit : -15-
 Programi : 0-350.00
 Shtesa : 100x100
 Kufija Blerese : 828.50

Numeri i Profilit : -16-
 Programi : 0-375.00
 Shtesa : 100x100
 Kufija Blerese : 828.50

DIST.PROGRES.TERENTIT	827.98	827.92	827.86	827.80	827.74	827.68	827.62	827.56	827.50	827.44	827.38	827.32	827.26	827.20	827.14	827.08	827.02	826.96
KUOTA TEREENTIT	827.98	827.92	827.86	827.80	827.74	827.68	827.62	827.56	827.50	827.44	827.38	827.32	827.26	827.20	827.14	827.08	827.02	826.96
DIST.PROGRES.PROJEKTTIT	-4.54	-4.54	-3.19	-2.50	0.00	2.50	3.19	4.54	4.54									
KUOTA PROJEKTTIT	828.31	828.21	827.86	827.92	827.97	827.92	827.86	828.21	828.31									

DIST.PROGRES.TERENTIT	827.81	827.75	827.69	827.63	827.57	827.51	827.45	827.39	827.33	827.27	827.21	827.15	827.09	827.03	826.97	826.91	826.85	826.79
KUOTA TEREENTIT	827.81	827.75	827.69	827.63	827.57	827.51	827.45	827.39	827.33	827.27	827.21	827.15	827.09	827.03	826.97	826.91	826.85	826.79
DIST.PROGRES.PROJEKTTIT	-4.54	-4.54	-3.87	-3.19	-2.85	-2.50	-1.25	0.00	1.25	2.50	2.85	3.19	3.87	4.54	4.54			
KUOTA PROJEKTTIT	828.11	828.01	828.01	827.66	827.66	827.72	827.75	827.77	827.75	827.72	827.66	827.66	828.01	828.01	828.11			



PROJEKT ZBATIM			
Punoi	Kontrollori	Miratori	Emri i dokumentit
Ing. Feli DERKONJAJ	Ing. Inatir KOLECI	Ing. Vanide GRUDA	PROFIL TËRTHOR - AKSI A
PALMA CONSTRUCTION sh.p.k.		Sistemi i Asistimit Rrugë të brendshme r/rrethi i ujësjesorit	
Tirana, Shqipëri Pallat Kujti, H. S. Ali, Nr. 55 Autoparkimi@palmaconstruction.com +355 69 402 0991		+KUZ Fshati Zvërnjë	
Rev.		Nr. Fletës	C-308

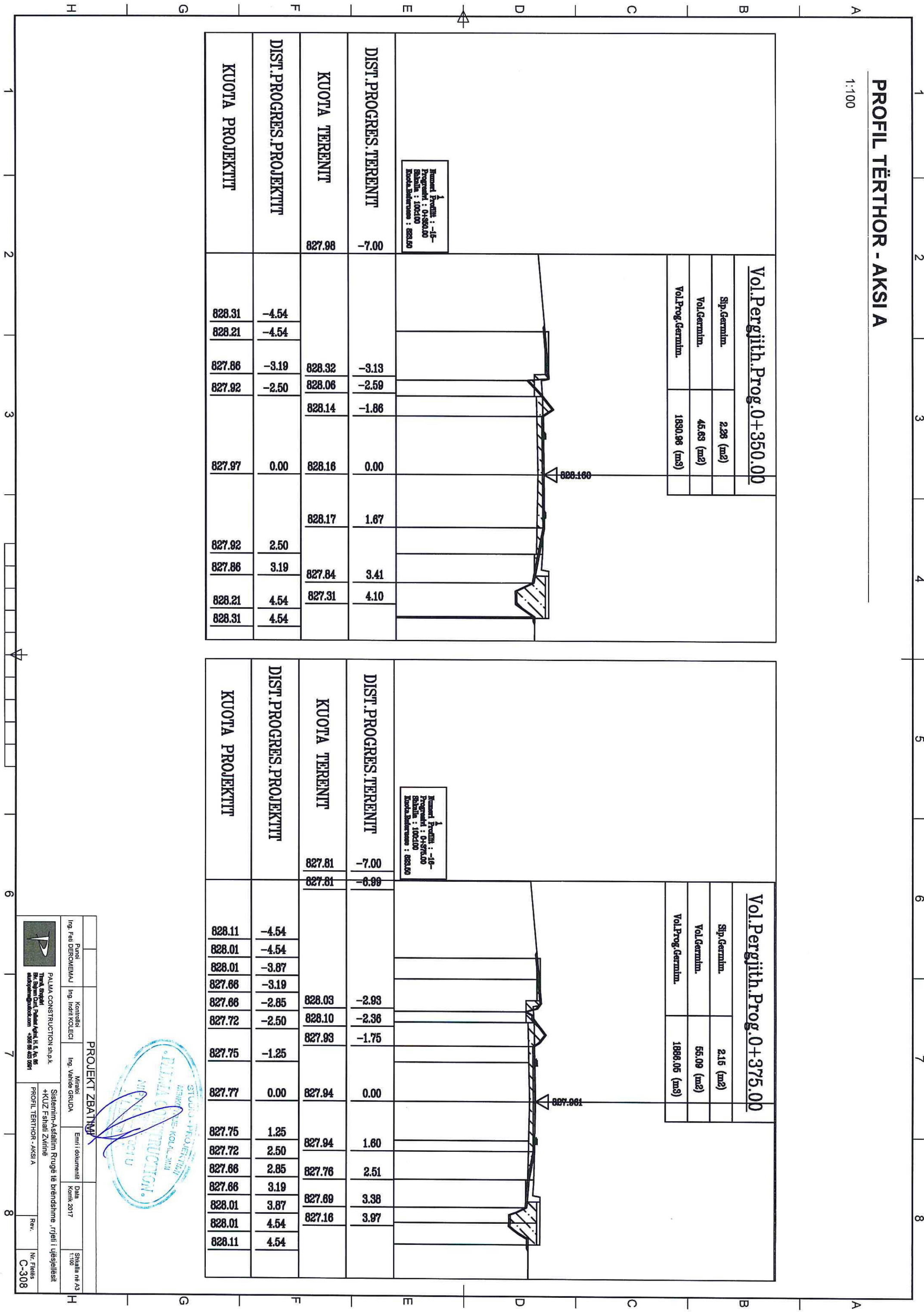

PROFIL TËRTHOR TIP

1:50

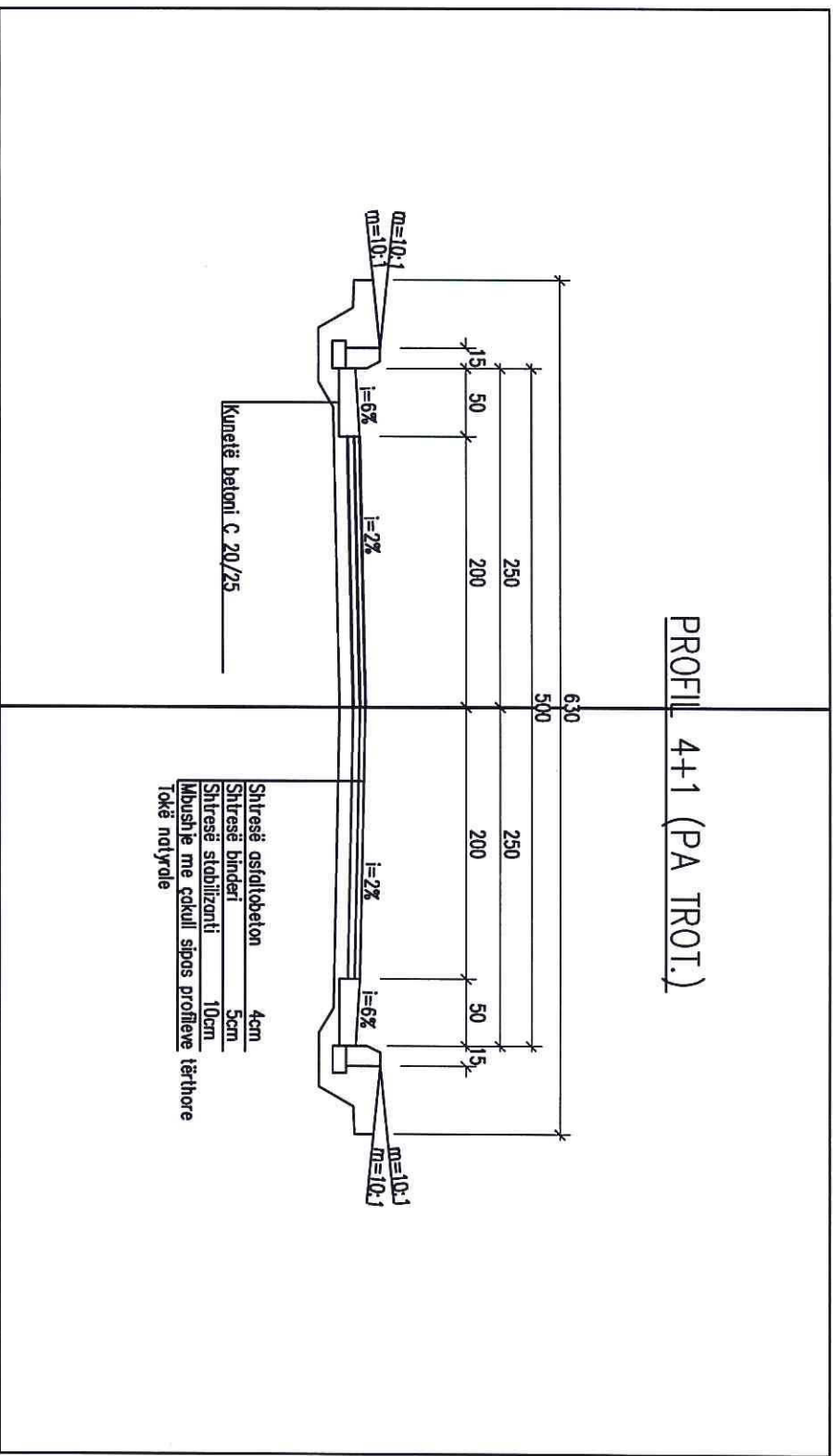
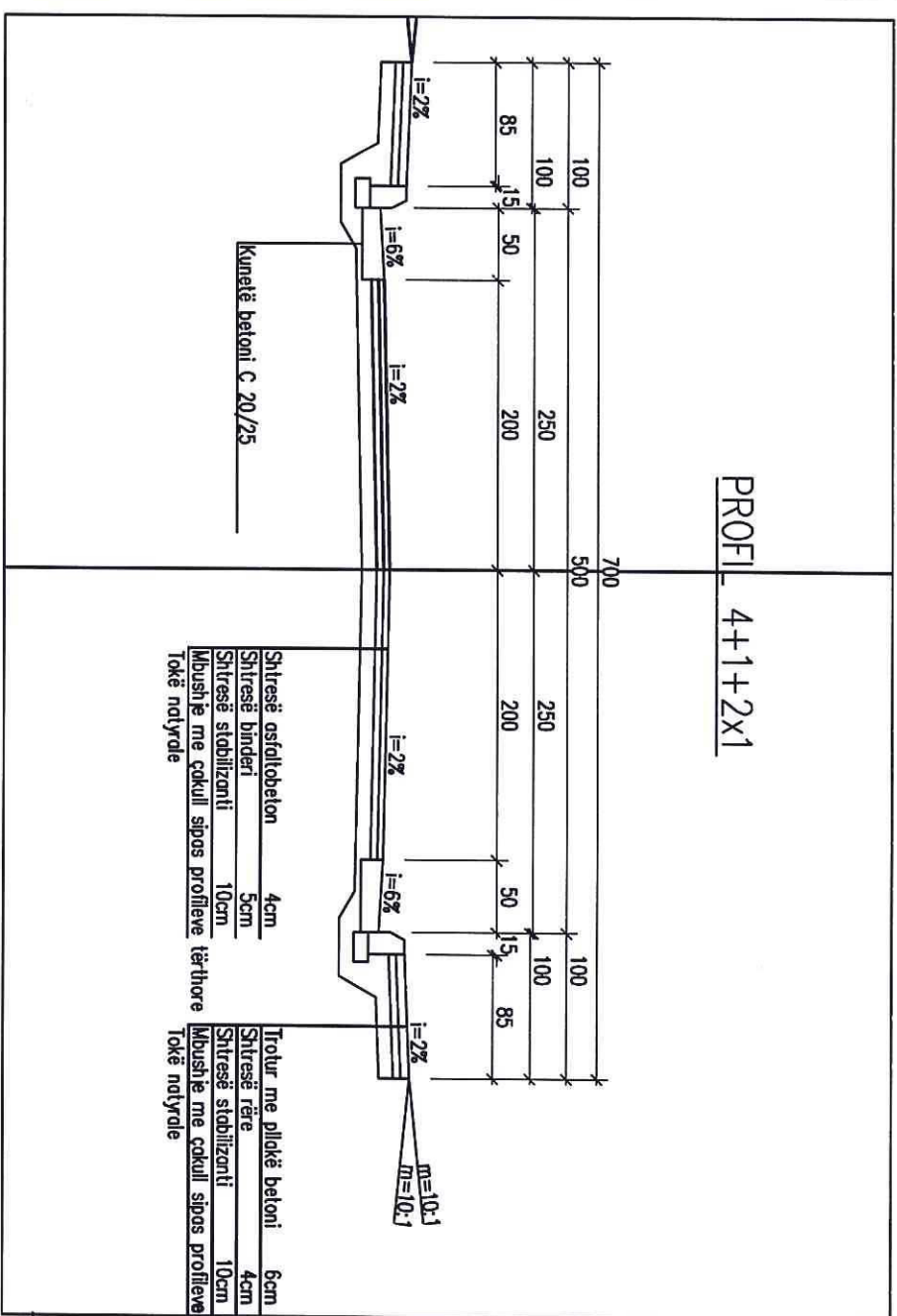
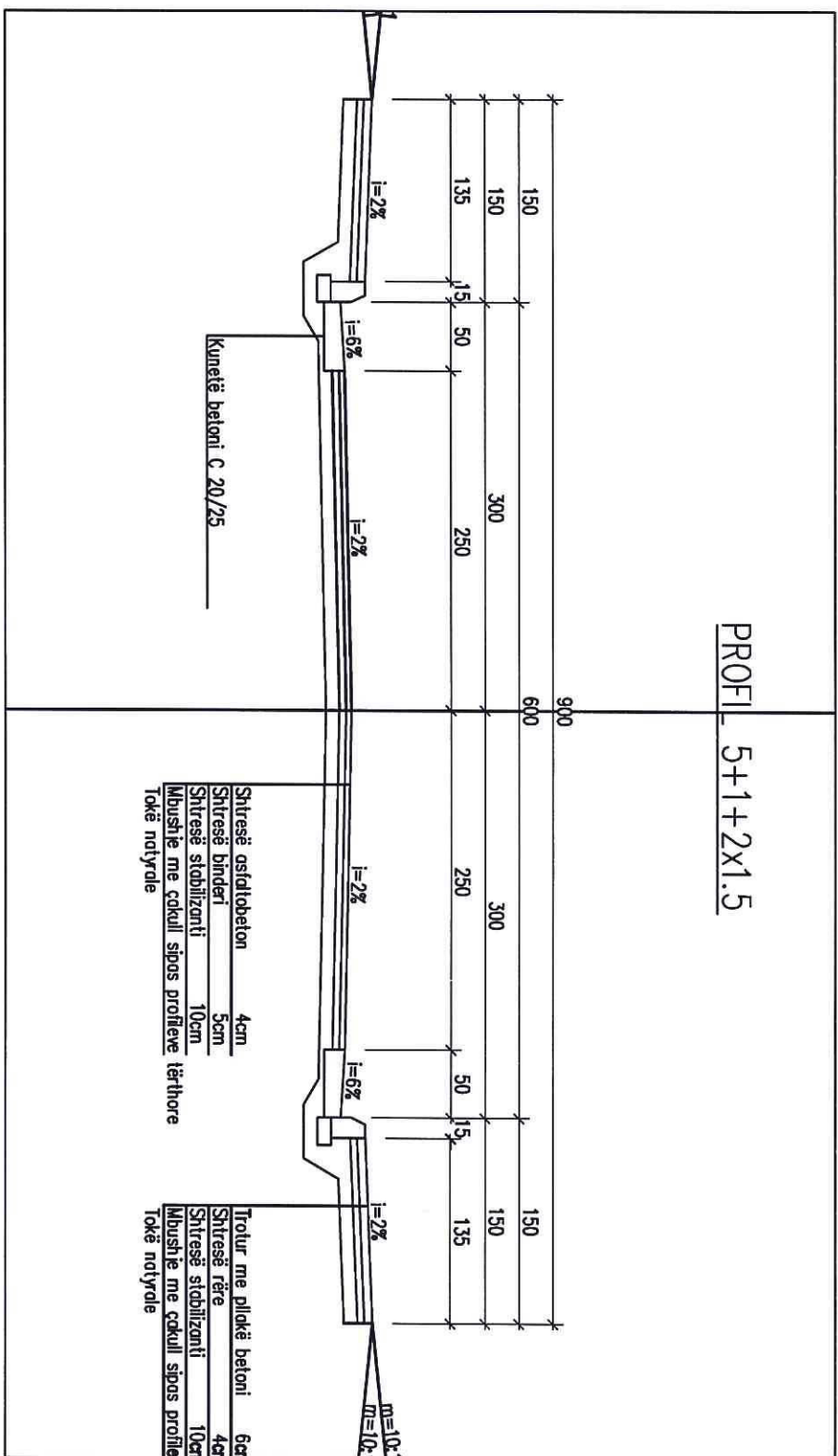

PROJEKT ZBATIMI			
Punoi: Ing. Fati DEROMEVAJ	Kontrolloi: Ing. Indrit KOLECI	Miratoi - data: Ing. Vehide GRUDA	Emri i dokumentit: Sistemin-Asfalim Rrugë të brëndshme - rrethi i ujësullësi +KUZ Fshat Zvirinë
PALMA CONSTRUCTION sh.p.k. Bk. Bregun e Cezar, Peshëqir, Rr. 5 & Nr. 65 shkup@palmaconstruction.com +355 88 420 0571			Data: Korrik 2017
PROFIL TËRTHOR TIP			Shkalla në A3: 1:50
Rev:			Nr. Fletës: C-200

PLANIMETRIA E BOKSIT SHK. 1:100

**MIRATOHET
KRYETARI I BASHKISE
MALIQ
GËZIM TOPÇIU**

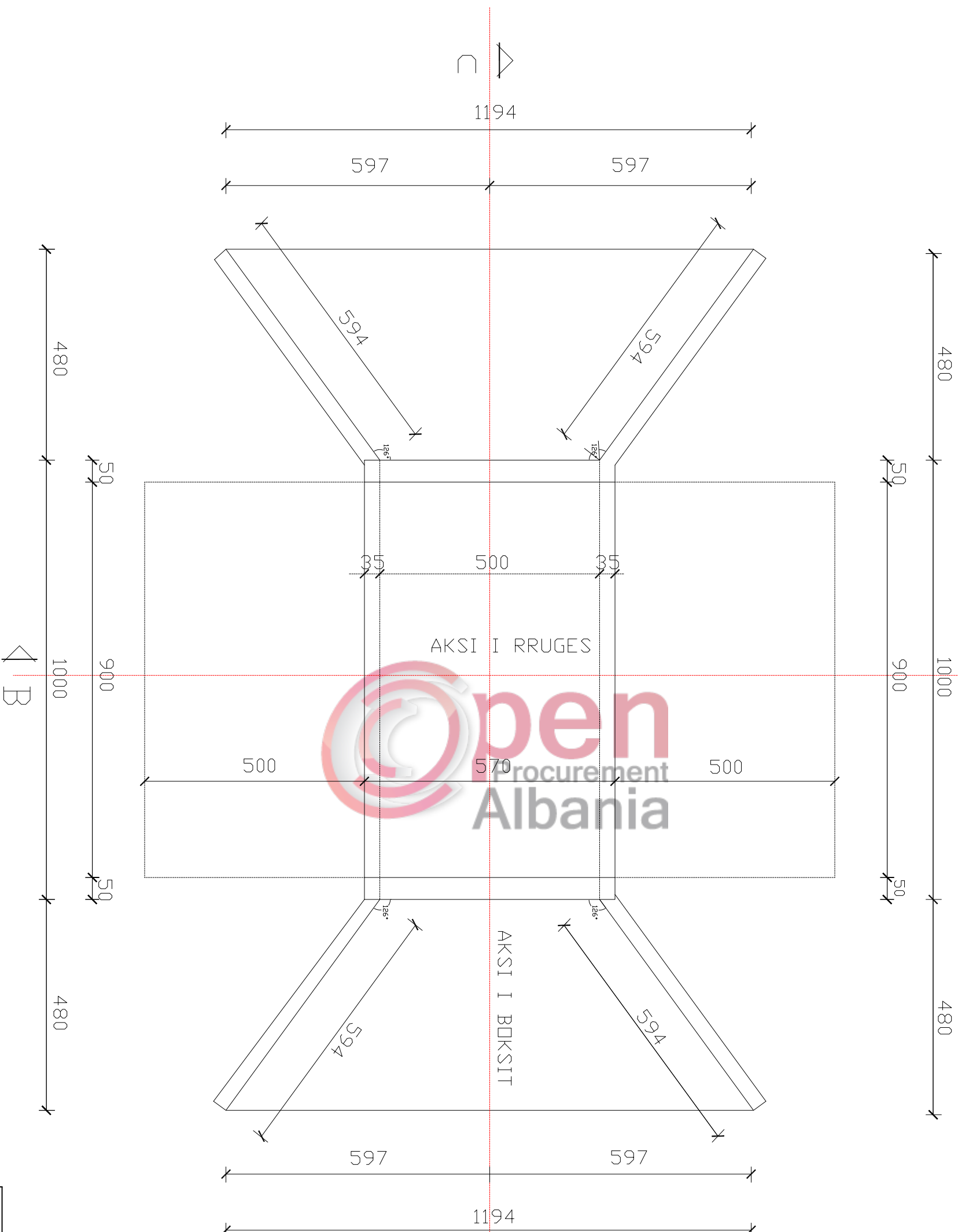

SISTEMIM ASFALTIM I RRUGËS HYRËSE I FSHATIT ZVIRINË (Faza I)

Qelimi	Auth.	Dr.	Shkalla	Doc. number
Per Aprovim	Ing.S.KOTI			Page: Nr. 9/1
Emertimi i vizatimit				DREKTORIA E PLANIFIKIMIT URBAN DHE PROJEKTIVE INGENJERLEJDA JONUSILARI
PLANIMETRIA E BOKSIT				

**MIRATOHET
KRYETARI I BASHKISE
MALIQ
GËZIM TOPÇIU**

PRERJA B – B SHK. 1:50

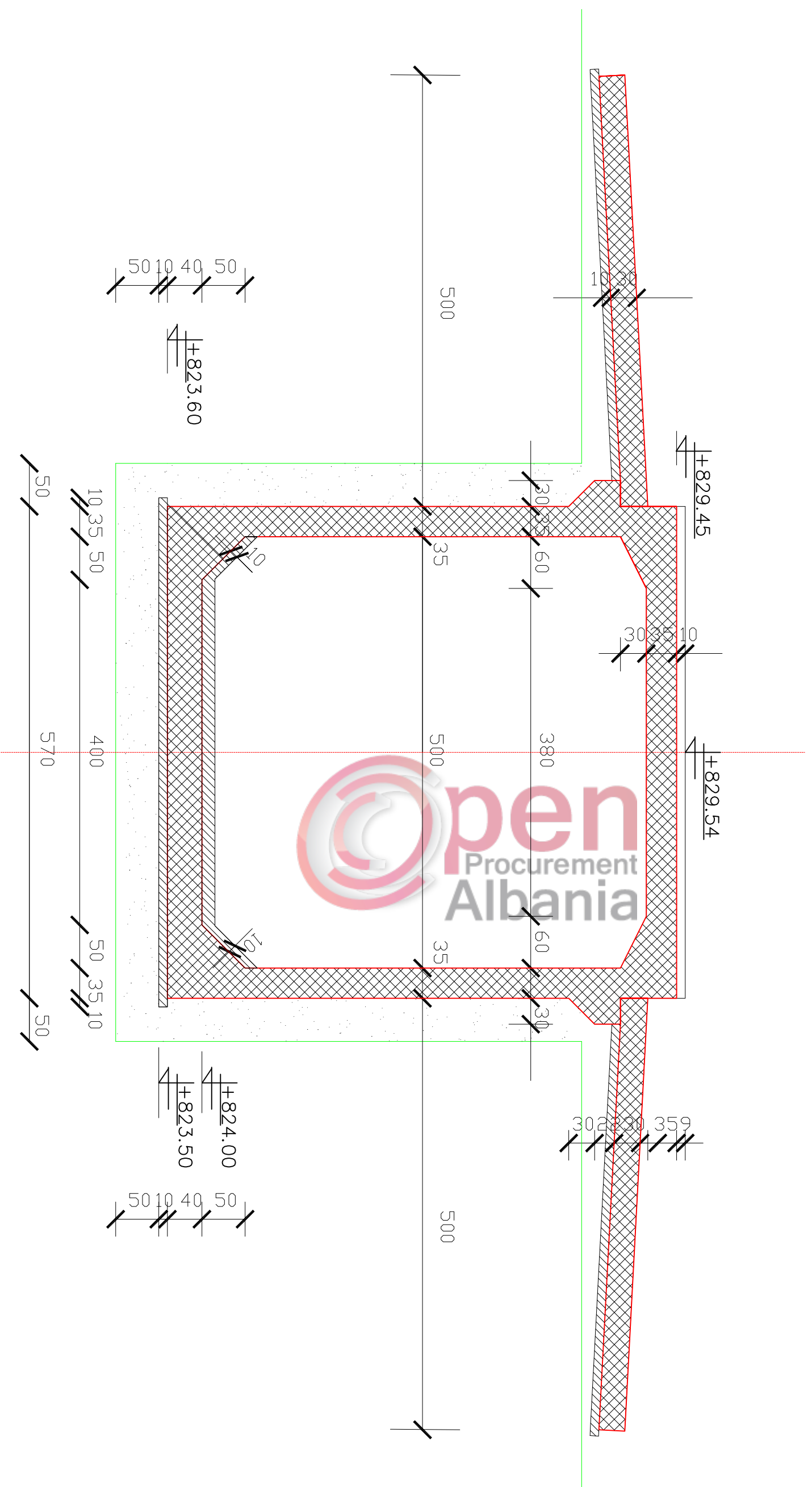

SISTEMIM ASFALTIM I RRUGËS HYRËSE I FSHATIT ZVIRINË (Faza I)

Qelimi	Auth.	Dr.	Shkalla	Doc. number
Per Aprovim	Ing.S.KOTI			Faqe: Nr. 9/2
Emertimi i vizatimit				DREKTORIA E PLANIFIKIMIT URBAN DHE PROJEKTIVE INGENJERLEDA JONUSILARI
PRERJA B – B				

**MIRATOHET
KRYETARI I BASHKISE
MALIQ
GËZIM TOPÇIU**

PRERJA C – C SHK. 1:100

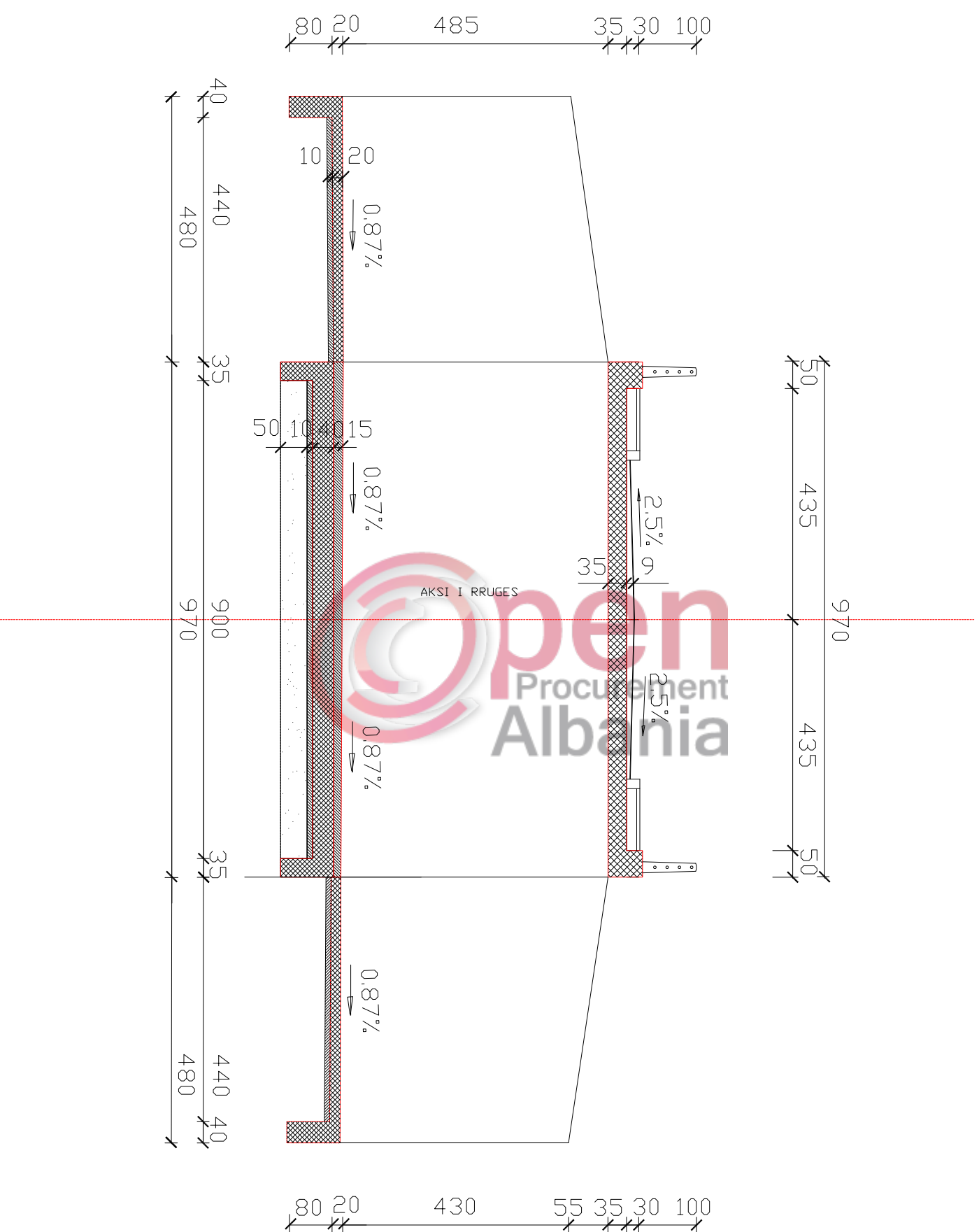

SISTEMIM ASFALTIM I RRUGËS HYRËSE I FSHATIT ZVIRINË (Faza I)

Qelimi	Auth.	Dr.	Shkalla	Doc. number
Per Aprovim	Ing.S.KOTI			Page: Nr. 9/3
Emertimi i vizatimit				DREJTORIA E PLANIFIKIMIT URBAN DHE PROJEKTIVË INGENJERLEJDA JONNISLARI
PRERJA C – C				

ARMIMI I BOKSIT SHK. 1:50

MIRATOHET
KRYETARI I BASHKISE
MALIQ
GËZIM TOPÇIU

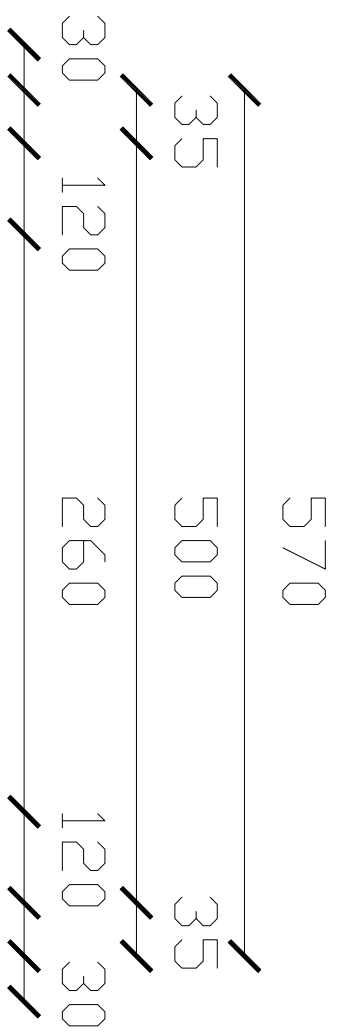

DETAI 2

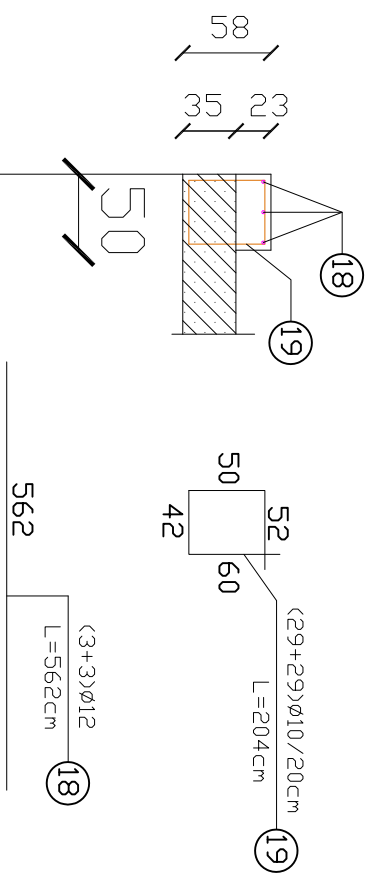

DETAI 1

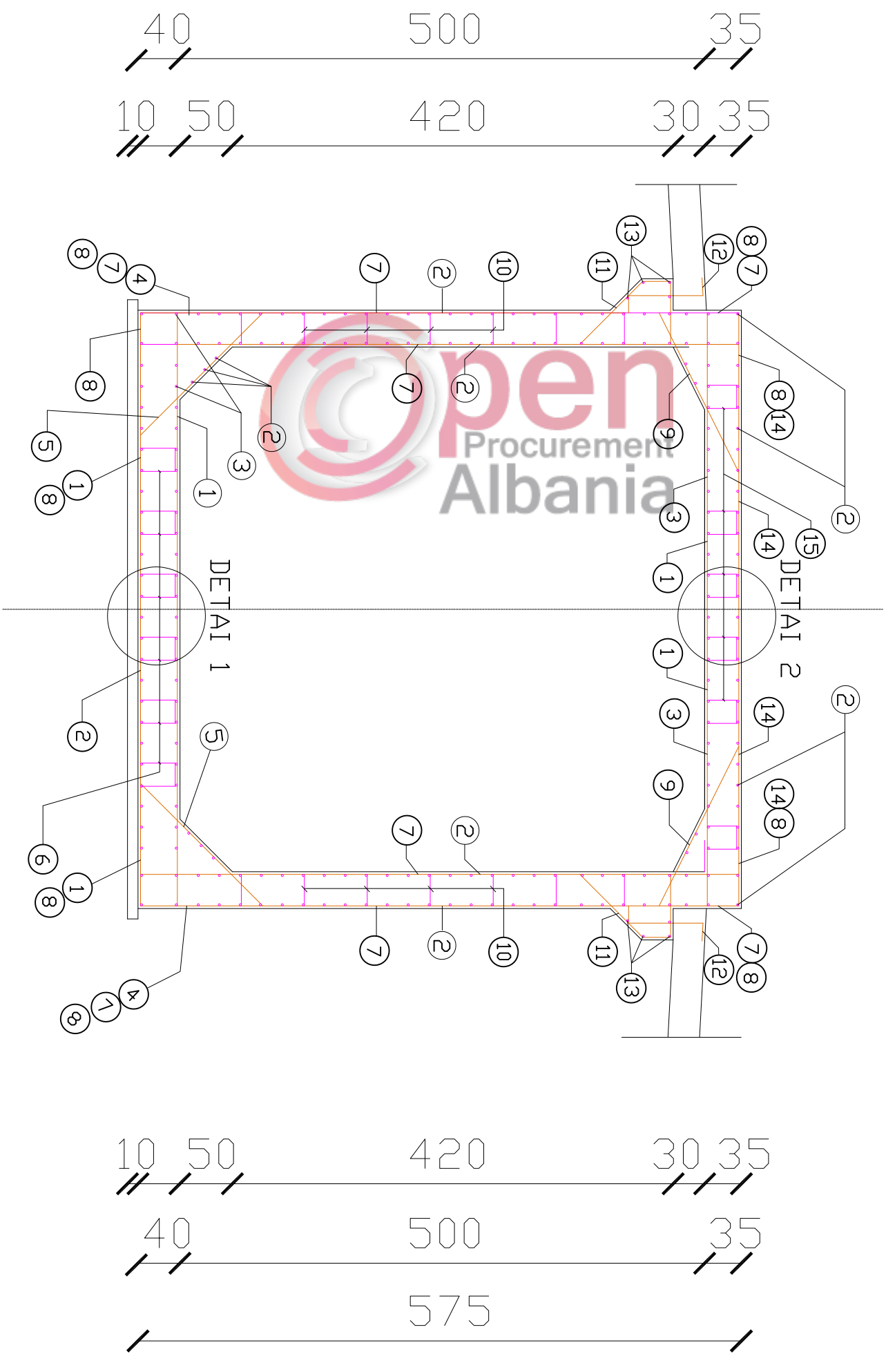
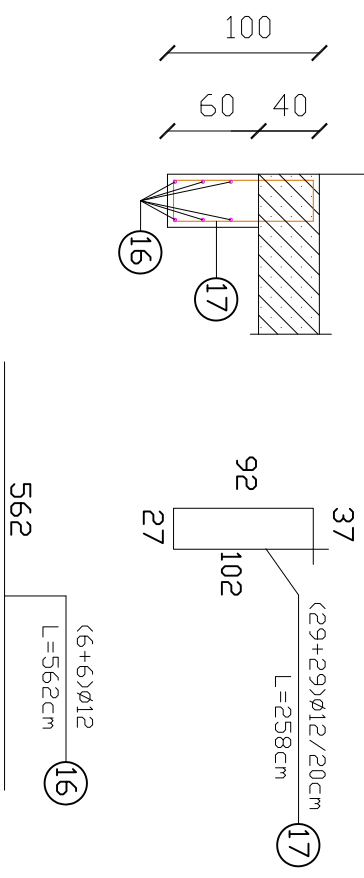

SISTEMIM ASFALTIM I RRUGËS HYRËSE I FSHATIT ZVIRINË (Faza I)

Qëllimi	Aut.	Dr.	Shtalla	Doc. number
Per Aprovim	Ing.S.KOTI			Page: Nr. 10/1
Emertimi i vizatimit				DREJTORIA E PLANIFIKIMIT URBAN DHE PROJEKTIVE INGENJERLEJDA JONUSILARI
ARMIMI I BOKSIT				

ARMIMI I BOKSIT SHK. 1:50

MIRATOHET
KRYETARI I BASHKISE
MALIQ
GËZIM TOPÇIU

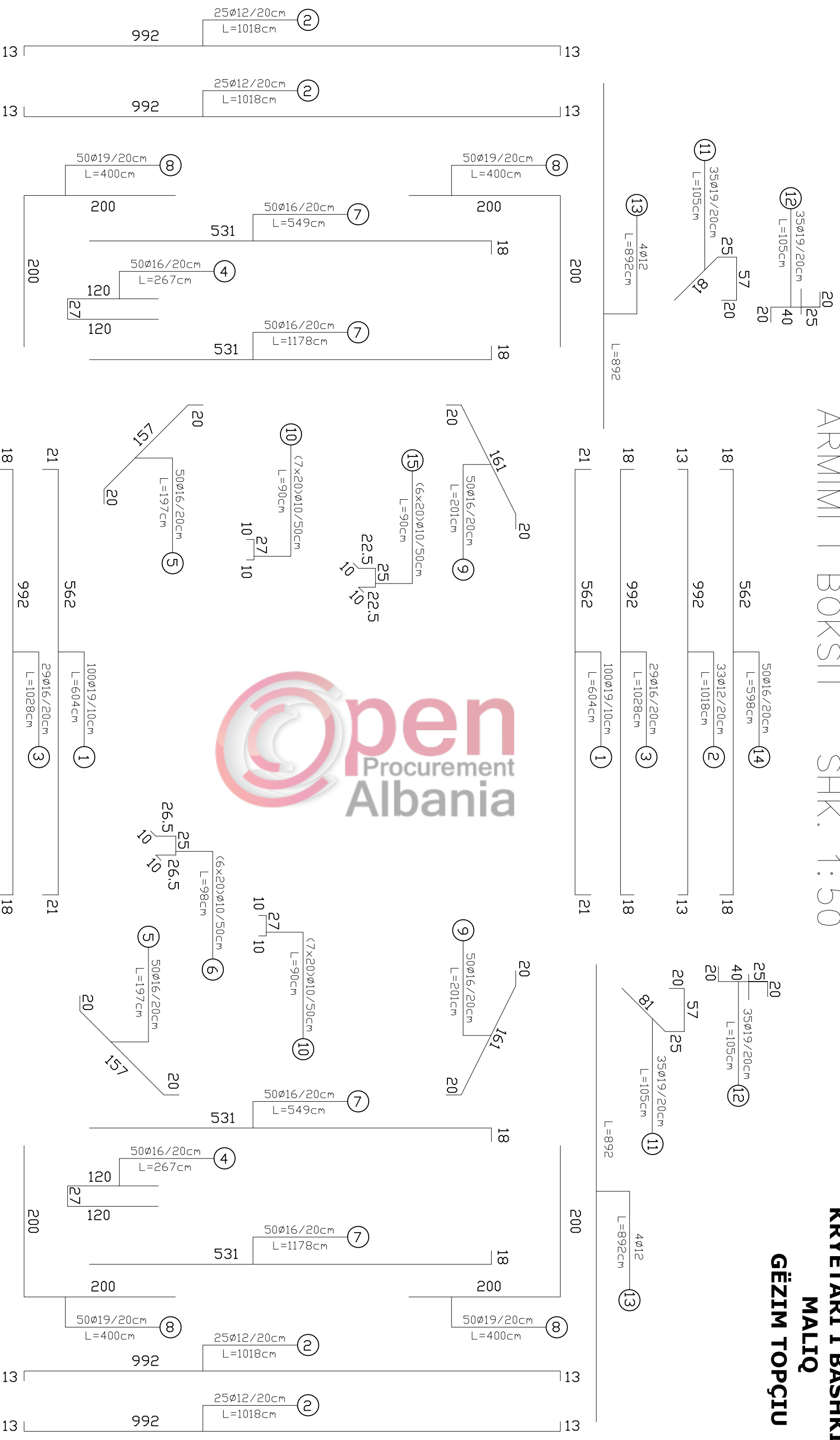

SISTEMIM ASFALTIM I RRUGËS HYRËSE I FSHATIT ZVIRINË (Faza I)

Qelimi	Aut.	Dr.	Shkalla	Doc. number
Per Aprovim	Ing.S.KOTI			Faqe: Nr. 10/2
Emertimi i vizatimit				
Pozicioni i Hekurave të Boksit				DREJTORIA E PLANIFIKIMIT URBAN DHE PROJEKTIVE INGENJERLEJDA JONUSILLARI

ARMIMI I SOLETËS SHK. 1:50

MIRATOHET
KRYETARI I BASHKISE
MALIQ
GËZIM TOPÇIU



TABELA PER SOLETEN

Nr.	Ø mm	L cm	sasi cop	Σ L ml	Përmbledhje			
					Ø mm	Σ L ml	peshë kg/ml	peshë kg
1	16	529	112	592.48	10	243.20	0.633	153.9
2	16	547	112	612.64	12	1878.50	0.911	1711.3
3	12	992	136	1349.12	16	1205.12	1.621	1953.5
4	12	519	102	529.38	Hekur gjithësej			
5	10	76	320	243.20	3818.7			

TABELA PER BOKSIN

Nr.	Ø mm	L cm	sasi cop	Σ L ml	Përmbledhje			
					Ø mm	Σ L ml	peshë kg/ml	peshë kg
1	19	604	250	1510.00	10	595.92	0.633	377.2
2	12	1018	168	1710.24	12	2032.40	0.911	1851.5
3	16	1028	58	596.24	16	2731.74	1.621	4428.2
4	16	267	100	267.00	19	2383.50	2.288	5453.5
5	16	197	100	197.00	Hekur gjithësej			
6	10	98	120	117.60	12110.4			
7	16	549	200	1098.00				
8	19	400	200	800.00				
9	16	201	100	201.00				
10	10	90	280	252.00				
11	16	105	70	73.50				
12	19	105	70	73.50				
13	12	892	8	71.36				
14	16	598	50	299.00				
15	10	90	120	108.00				
16	12	562	12	67.44				
17	12	258	58	149.64				
18	12	562	6	33.72				
19	10	204	58	118.32				

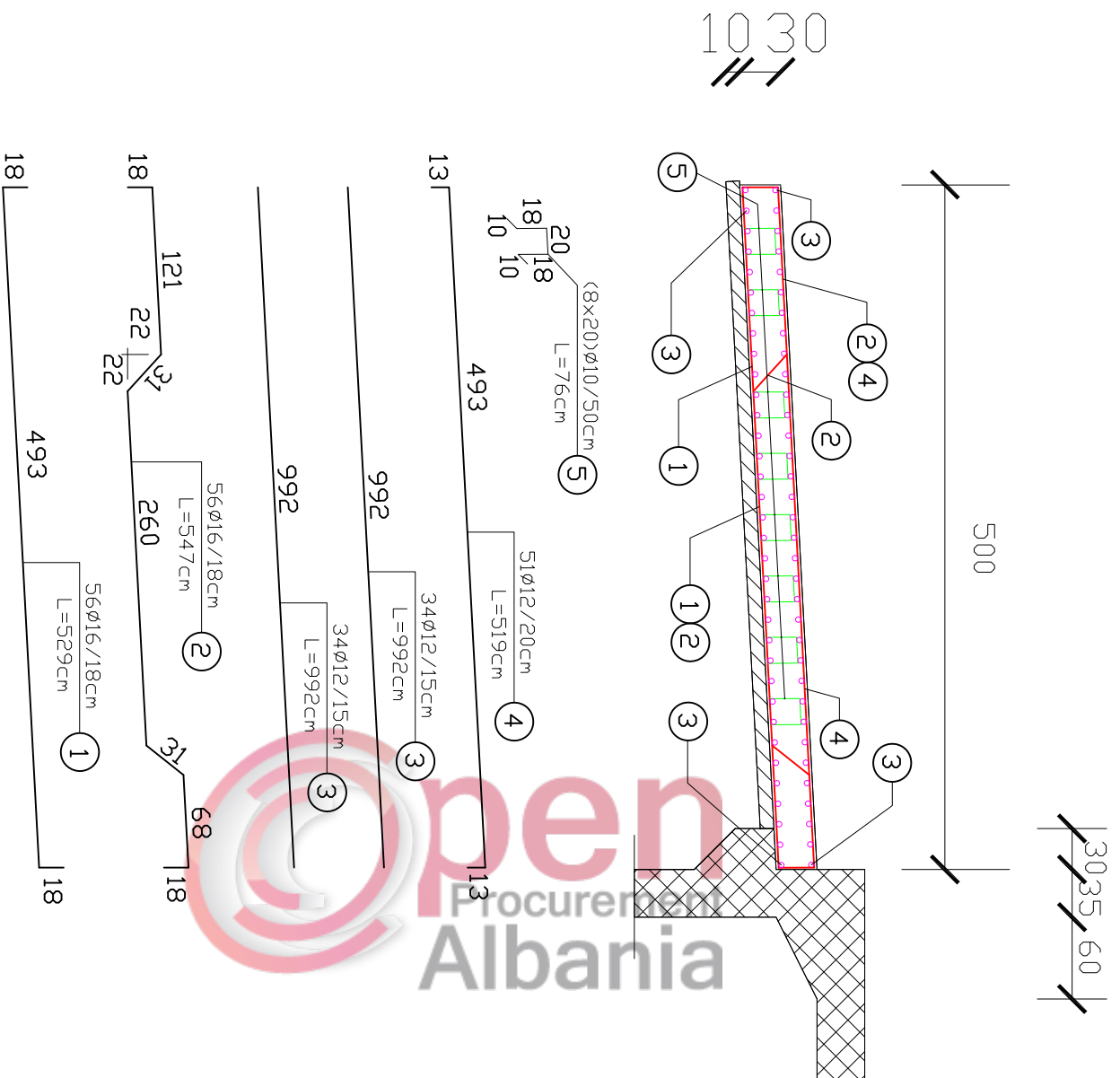
SISTEMIM ASFALTIM I RRUGËS HYRËSE I FSHATIT ZVIRINË (Faza I)

Qelimi	Aut.	Dr.	Shkalla	Doc. number
Per Aprovim	Ing. S.KOTI	Ing. Th. KOROVESH		Faqe: Nr. 10/3
Emertimi i vizatimit				DREKTORIA E PLANIFIKIMIT URBAN DHE PROJEKTIVË INGENJERLEJDA JONUSILARI
ARMIMI I SOLETËS				

**MIRATOHET
KRYETARI I BASHKISE
MALIQ
GËZIM TOPÇIU**

ARMIMI I SHESHIT SHK. 1:50

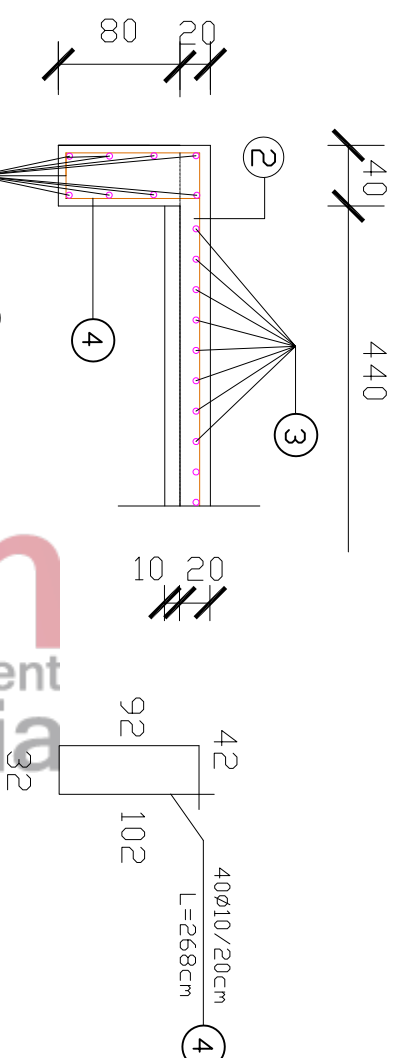

792	8012	1	L=792cm
50~472	57012/20cm	2	L=19960cm
492~1134	23012/20cm	3	L=18699cm

TABELLA PER MURET MBAJTES

Cilësori	Nr.	Ø mm	L cm	sasi cop	Σ L ml	Përmbledhje			
						Ø mm	Σ L ml	pesha kg	
Muret Mbajtës 4 cop	1	16	262	31	81,22	10	2356,96	0,633	1491,9
	2	14	220	31	68,20	12	1535,40	0,911	1398,8
	3	10	386	31	119,66	14	272,80	1,242	338,8
	4	10	592	56	331,52	16	897,76	1,621	1455,3
	5	12	592	23	136,16	Hekur gjithësej			4684,8
	6	10	164	52	85,28				
	7	12	170	31	52,70				
	8	16	462	31	143,22				
	9	12	155	31	48,05				
	10	12	474	31	146,94				
	11	10	58	91	52,78				

TABELLA PER SHESHET

Shprehjet Cop	Nr.	Ø mm	L cm	sasi cop	Σ L ml	Përmbledhje			
						Ø mm	Σ L ml	pesha kg	
Shprehjet Cop	1	12	792	8	63,36	10	316,24	0,633	200,2
	2	12	Var.	57	199,60	12	899,90	0,911	819,8
	3	12	Var.	23	186,99	Hekur gjithësej			1020,0
	4	10	268	59	158,12				

SISTEMIM ASFALTIM I RRUGËS HYRËSE I FSHATIT ZVIRINË (Faza I)

Qelimi	Auth.	Dr.	Shkalla	Doc. number
Per Aprovim	Ing.S.KOTI			Page: Nr. 10/5
Emertimi i vizatimit				DREJTORIA E PLANIFIKIMIT URBAN DHE PROJEKTIVE INGENJERLEJDA JONUSILARI
ARMIMI I SHESHIT				

ARMIMI I MURIT SHK. 1:50

MIRATOHET
KRYETARI I BASHKISE
MALIQ
GËZIM TOPÇIU

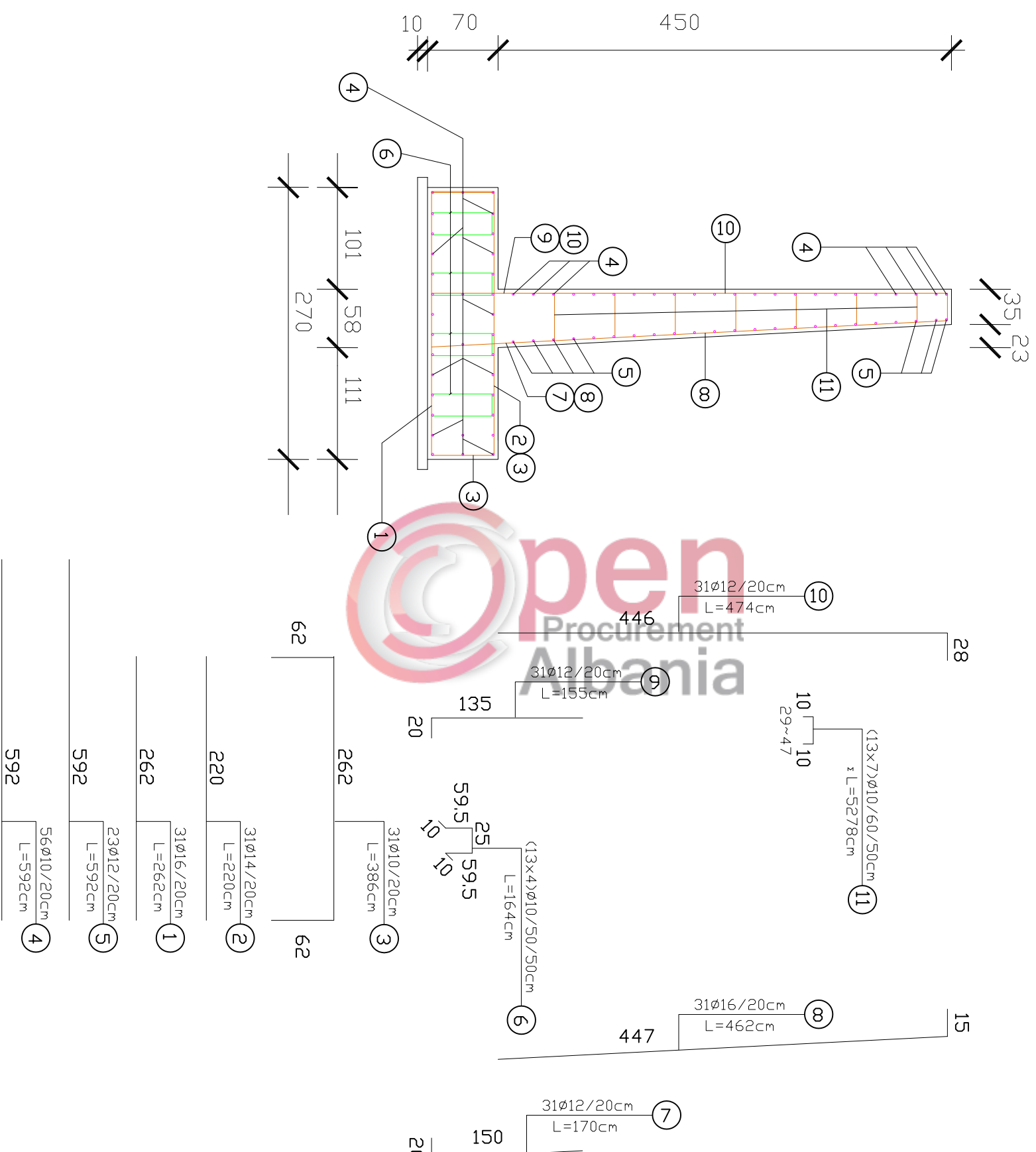

SISTEMIM ASFALTIM I RRUGËS HYRËSE I FSHATIT ZVIRINË (Faza I)

Qelimi	Auth.	Dr.	Shkalla	Doc. number
Per Aprovim	Ing.S.KOTI			Page: Nr. 10/4
Emertimi i vizatimit				DREJTORIA E PLANIFIKIMIT URBAN DHE PROJEKTIVE INGENJERELIDA JONNISLARI
ARMIMI I MURIT				

MIRATOHET
KRYETARI I BASHKISE
MALIQ
GEZIM TOPÇIU

PRERJE TERTHORE TIP A - A

Sh. 1:50

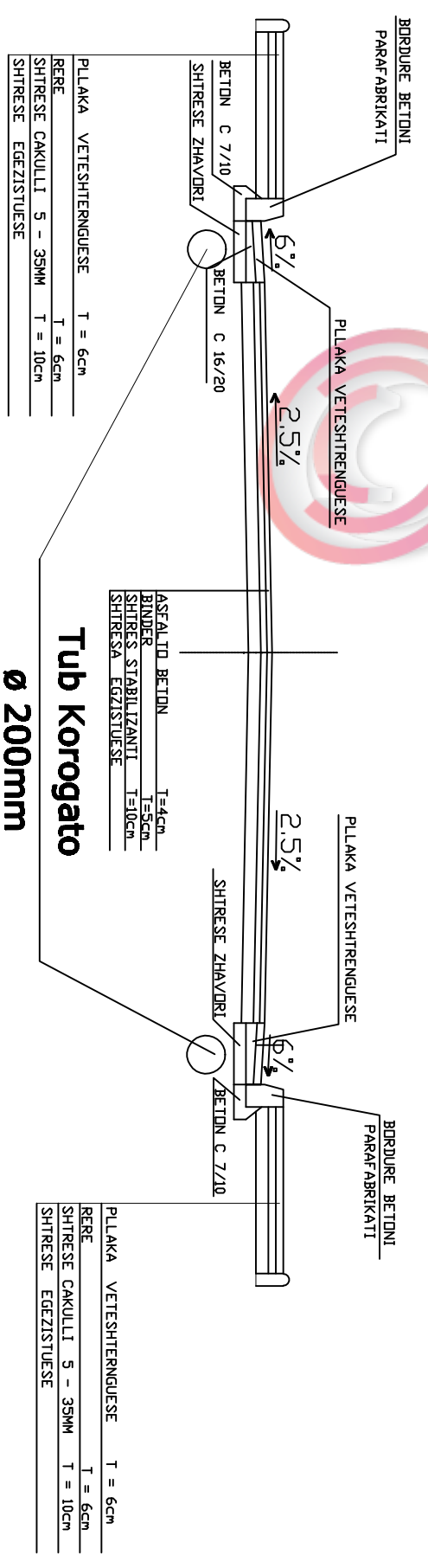
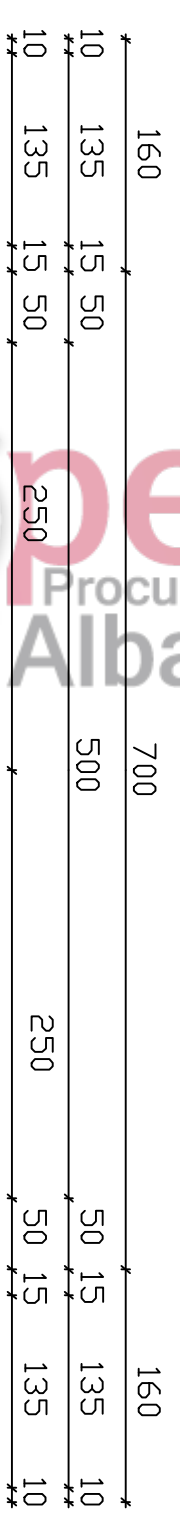

PLAKA VETESHTRENGESE	T = 6cm
RRE	T = 6cm
SHTRESE ÇAKULLI 5 - 35MM	T = 10cm
SHTRESE EGEZISTUESE	

ASFALTO BETON	T=4cm
PAVIMENTI	T=5cm
SHTRESE STABILIZANTI	T=10cm
SHTRESE EGEZISTUESE	

PLAKA VETESHTRENGESE	T = 6cm
RRE	T = 6cm
SHTRESE ÇAKULLI 5 - 35MM	T = 10cm
SHTRESE EGEZISTUESE	

SISTEMIM ASFALTIM I RRUGËS HYRËSE I FSHATIT ZVIRINË (Faza I)

Qëndral	Amal	Dz.	Shtetli	Doca number
Per Agjencine	Ing. SAKOTI	Ing. M. ZEBULI		Regjist. 11
Emertimi i vizatimit				
Profili Terthore Tip				
DREKTORIA E PLANIFIKIMIT ZHVILLIMIT TE TERTHORET ING. SHKENCEDORA KONSTRUKTIVE				

PLANIMETRIA E INTERSEKTIMIT TE TROTUARIT

SH 1:25

B1

MIRATOHET
KRYETARI I BASHKISE
MALIQ
GËZIM TOPÇIU

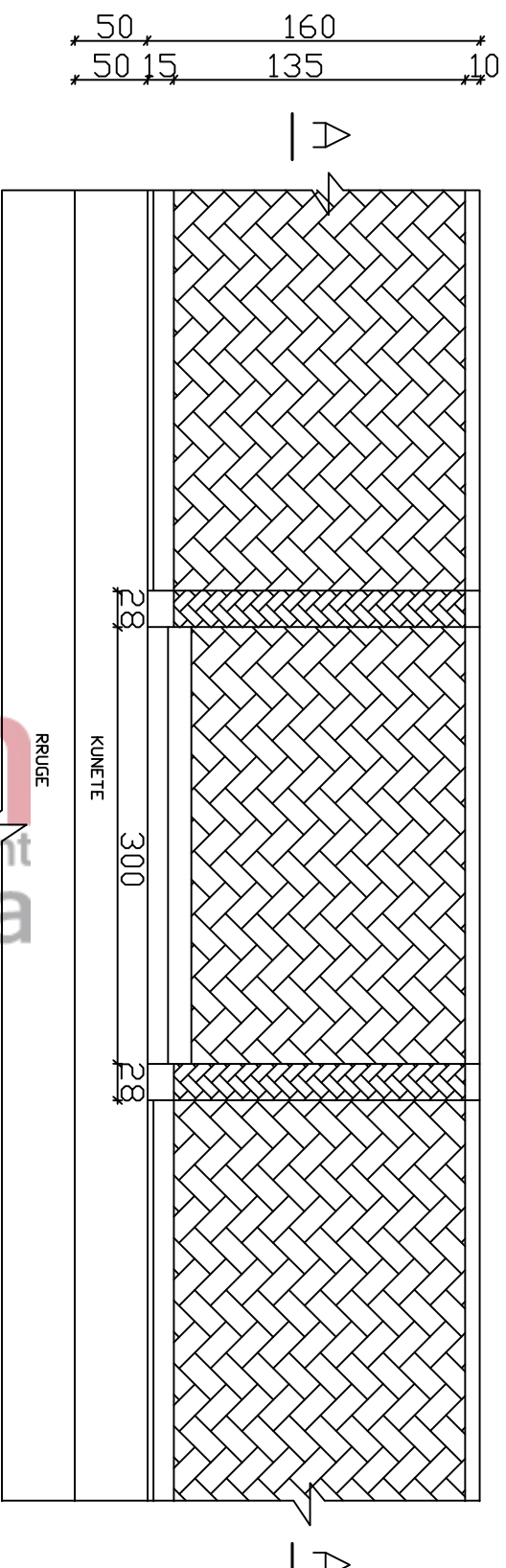

PRERJJA A - A SH 1:25

SHTRESE ME PLLAKA VETESHTERNGUESE t = 6cm
SHTRESE BETONI C16/20 t = 10cm
SHTRESE ÇAKULLI S - 35MM t = 10cm

SHTRESE ME PLLAKA VETESHTERNGUESE t = 6cm
SHTRESE RERE t = 6cm
SHTRESE ÇAKULLI S - 35MM t = 10cm

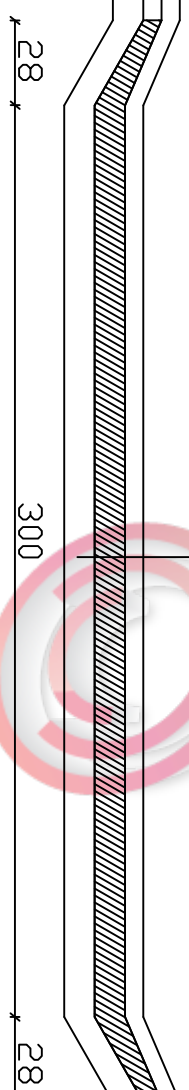

SHTRESE ME PLLAKA VETESHTERNGUESE t = 6cm
SHTRESE RERE t = 6cm
SHTRESE ÇAKULLI S - 35MM t = 10cm

PRERJJA B - B SH 1:25

SHTRESE ME PLLAKA VETESHTERNGUESE t = 6cm
SHTRESE BETONI C16/20 t = 10cm
SHTRESE ÇAKULLI S - 35MM t = 10cm

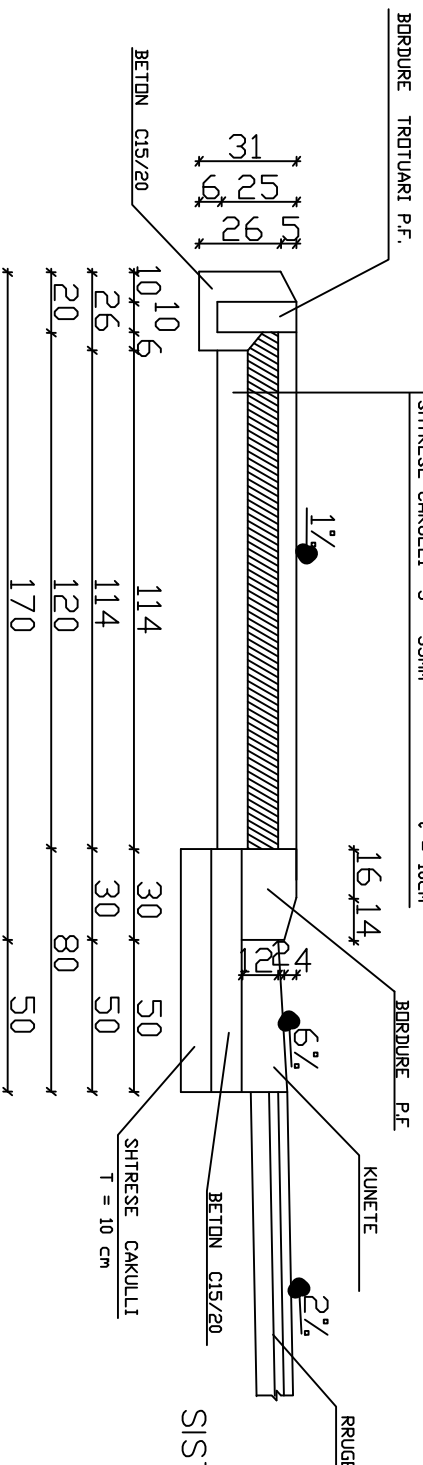

SISTEMIM ASFALTIM I RRUGËS HYRËSE I FSHATIT ZVIRINË (Faza I)

Qelimi	Auth.	Dr.	Sikalla	Doc. number
Per Aprovimi	Ing.S.KOTTI			Faqe: Nr. 11/1
Emertimi i vizatimit				DREJTORIA E PLANIFIKIMIT DHE KONTROLLIT TE ZHVILLIMIT TE TERRITORIT ING. ENKELLEIDA JONUSILARI
DETAJI I BORÐURAVE E KUNTAVE				

PLANIMETRIA E INTERSEKTIMIT TE TROTUARIT
PER PERSONAT ME AFTESI TE KUFIZUAR

SH 1:50

MIRATOHET
KRYETARI I BASHKISE
MALIQ
GËZIM TOPÇIU

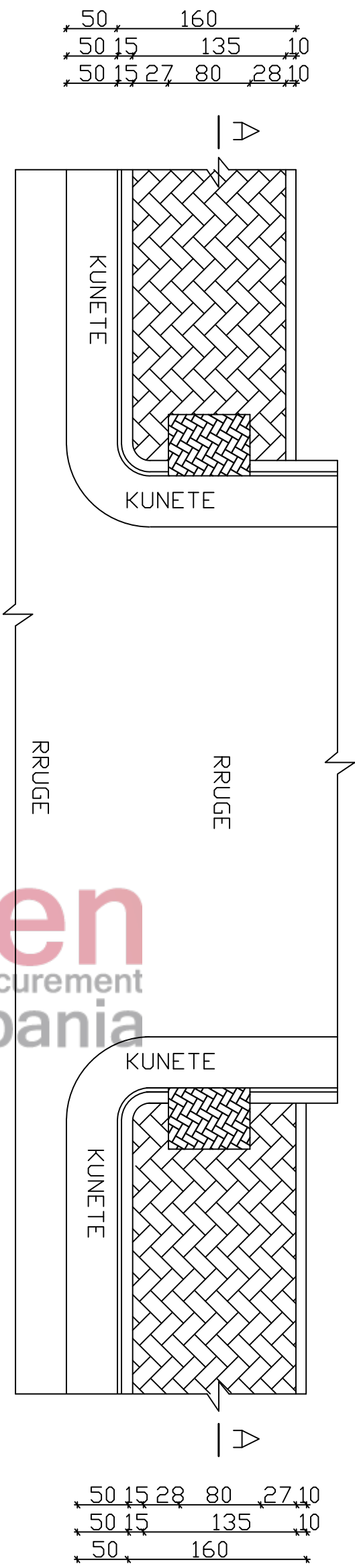

PRERJA A - A SH 1:50

400 ÷ 600	175
60 ÷ 50	300 ÷ 500
60 ÷ 50	300 ÷ 500

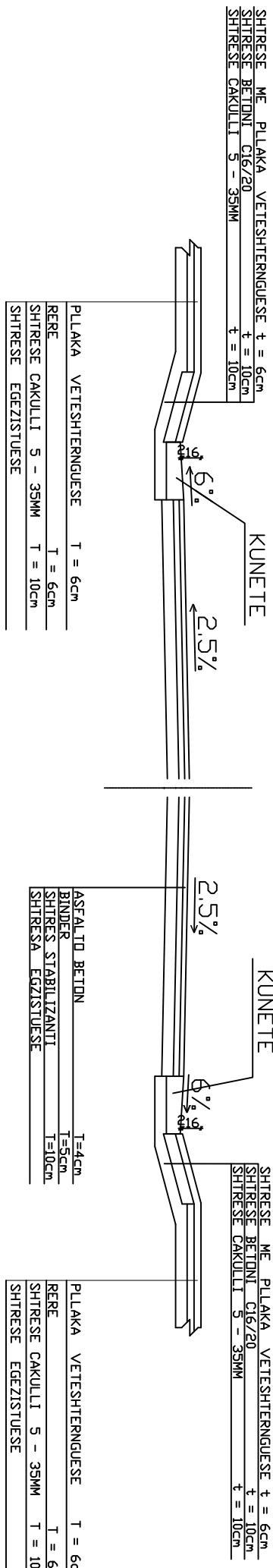

SHTRESE ME PLLAKA VETESHTRNGUESE t = 6cm
SHTRESE BETONI C16/20 t = 10cm
SHTRESE ÇAKULLI S - 35MM t = 10cm

PLLAKA VETESHTRNGUESE T = 6cm
RERE T = 6cm
SHTRESE ÇAKULLI S - 35MM T = 10cm
SHTRESE EGEZISTUESE

ASFALTO BETON T=4cm
BINDER T=5cm
SHTRES STABILIZANTI T=10cm
SHTRESA EGEZISTUESE

SHTRESE ME PLLAKA VETESHTRNGUESE t = 6cm
SHTRESE BETONI C16/20 t = 10cm
SHTRESE ÇAKULLI S - 35MM t = 10cm

PLLAKA VETESHTRNGUESE T = 6cm
RERE T = 6cm
SHTRESE ÇAKULLI S - 35MM T = 10cm
SHTRESE EGEZISTUESE

SISTEMIM ASFALTIM I RRUGËS HYRËSE I FSHATIT ZVIRINË (Faza I)

Qellimi	Auth.	Dr.	Sikalla	Doc. number
Per Approvimi	Ing.S.KOTI			Page: Nr. 11/2
Emertimi i vizatimit				
DETAJI I INTERSEKTIMIT TE TROTUARIT				

DREJTORIA E PLANIFIKIMIT
DHE KONTROLLIT TE
ZHVILLIMIT TE TERRITORIT
ING. ENKELLEDA JONUSILARI

**MIRATOHET
KRYETARI I BASHKISE
MALIQ
GËZIM TOPÇIU**

DETAJI I PEMEVE
Sh. 1:20

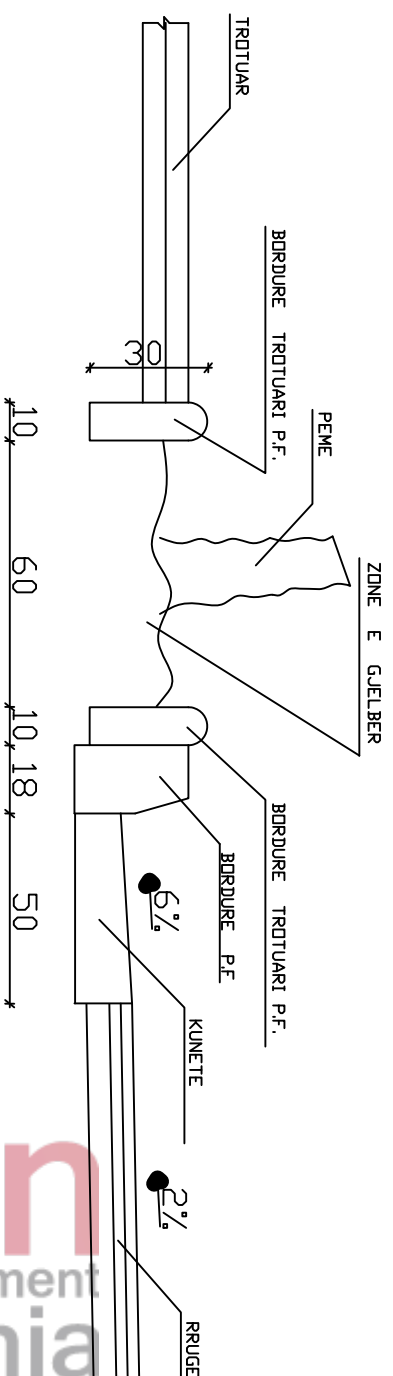

DETAJI I BORDURES DHE KUNETES
Sh. 1:20

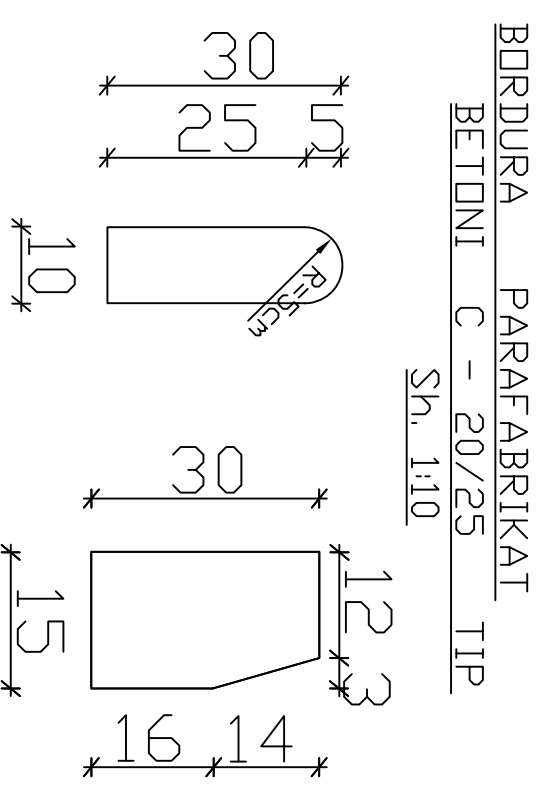
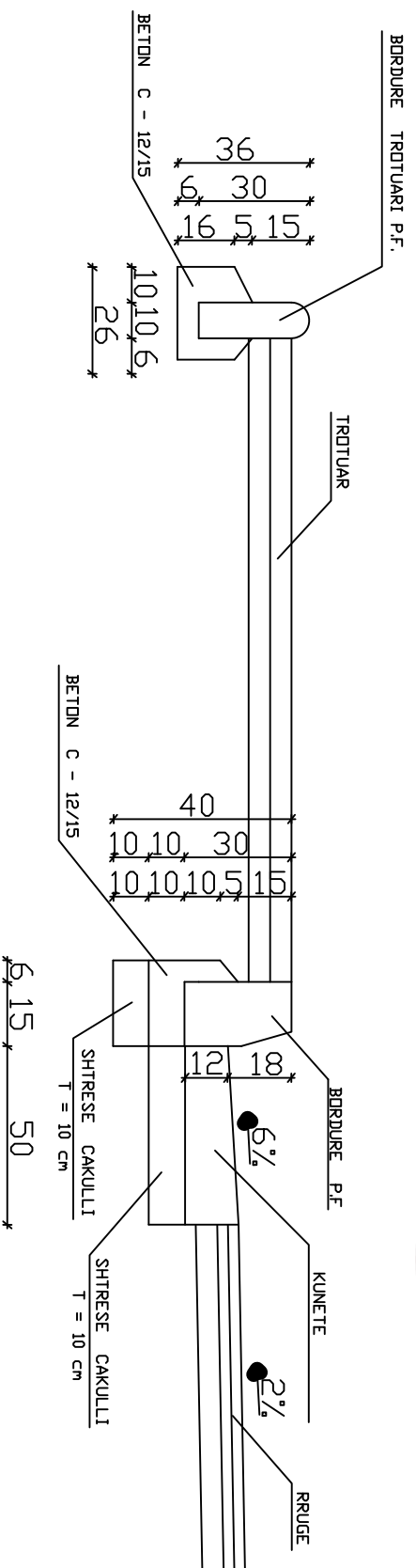

KUNETEA TIP
Sh. 1:10

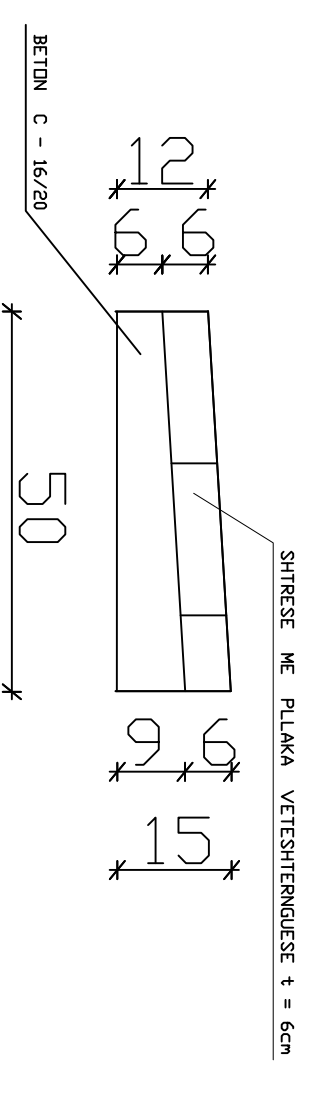

SISTEMIM ASFALTIM I RRUGËS HYRËSE I FSHATIT ZVIRINË (Faza I)

Qelimi	Auth.	Dr.	Shkalla	Doc. number
Per Aprovim	Ing. S.KOTI			Faqe: Nr. 11/3
Emertimi i vizatimit				DREJTORIA E PLANIFIKIMIT DHE KONTROLLIT TE ZHVILLIMIT TE TERRITORIT ING. ENKELBIDA JONUSILARI
DETAJI I BORDURAVE E KUNTAVE				

PLANI I KANALIZIMEVE TË URAVE TË BARDHA AKSI "A"

1:500

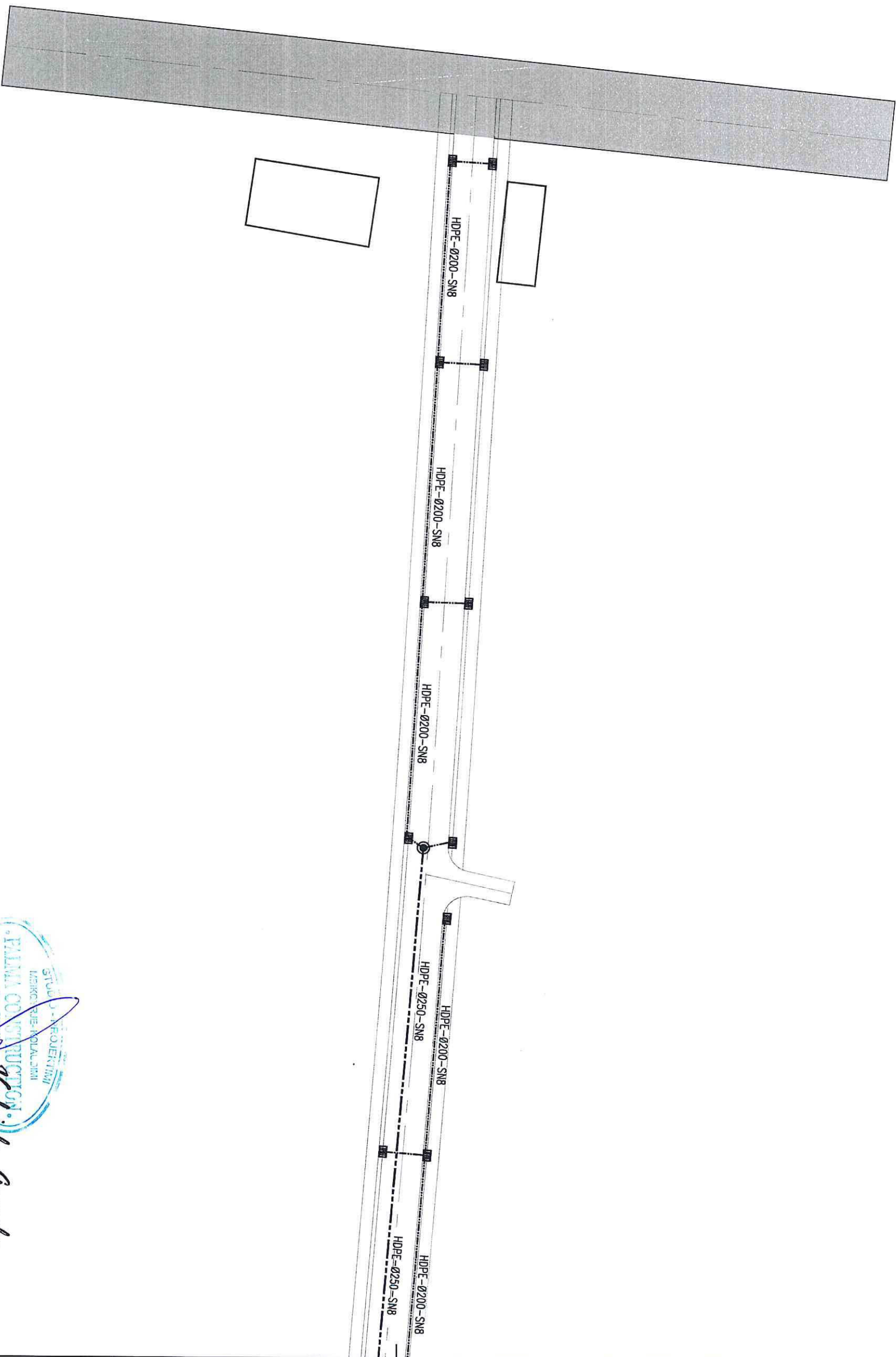

STUDIUM-PROJEKTIMI
 LIRI KEQER-ROJUESI
 PALMA CONSTRUCTION sh.p.k.
 NIKETI
 Vardishe Gruda

PROJEKT ZBATIMI

Punoi	Kontrolli	Mirator - data	Emri i dokumentit	Data	Shtylla nr. A3
Ing. Fati DEROMEJAJ	Ing. Indrit KOLECI	Ing. Vardishe GRUDA	Sistemin-Asfaltim Rrugë të brëndshme - rrethi i ujësjellësit +KUZ Fshat Zvithë	Korrik, 2017	1:500
PALMA CONSTRUCTION sh.p.k.			PLANI I KANALIZIMEVE TË URAVE TË BARDHA	Rev:	Nr. Fritës H-201
Titulli: Tërbim Nr. Dokumenti: 11.6.16.05 E-mail: info@palmaconstruction.com Tel: +355 69 453 0091					

- Ø200
- Ø250
- Ø315

- Ø350
- Ø400
- Ø500

H
G
F
E
D
C
B
A

1
2
3
6
7
8

PLANI I KANALIZIMEVE TË URAVE TË BARDHA AKSI "A"

1:500

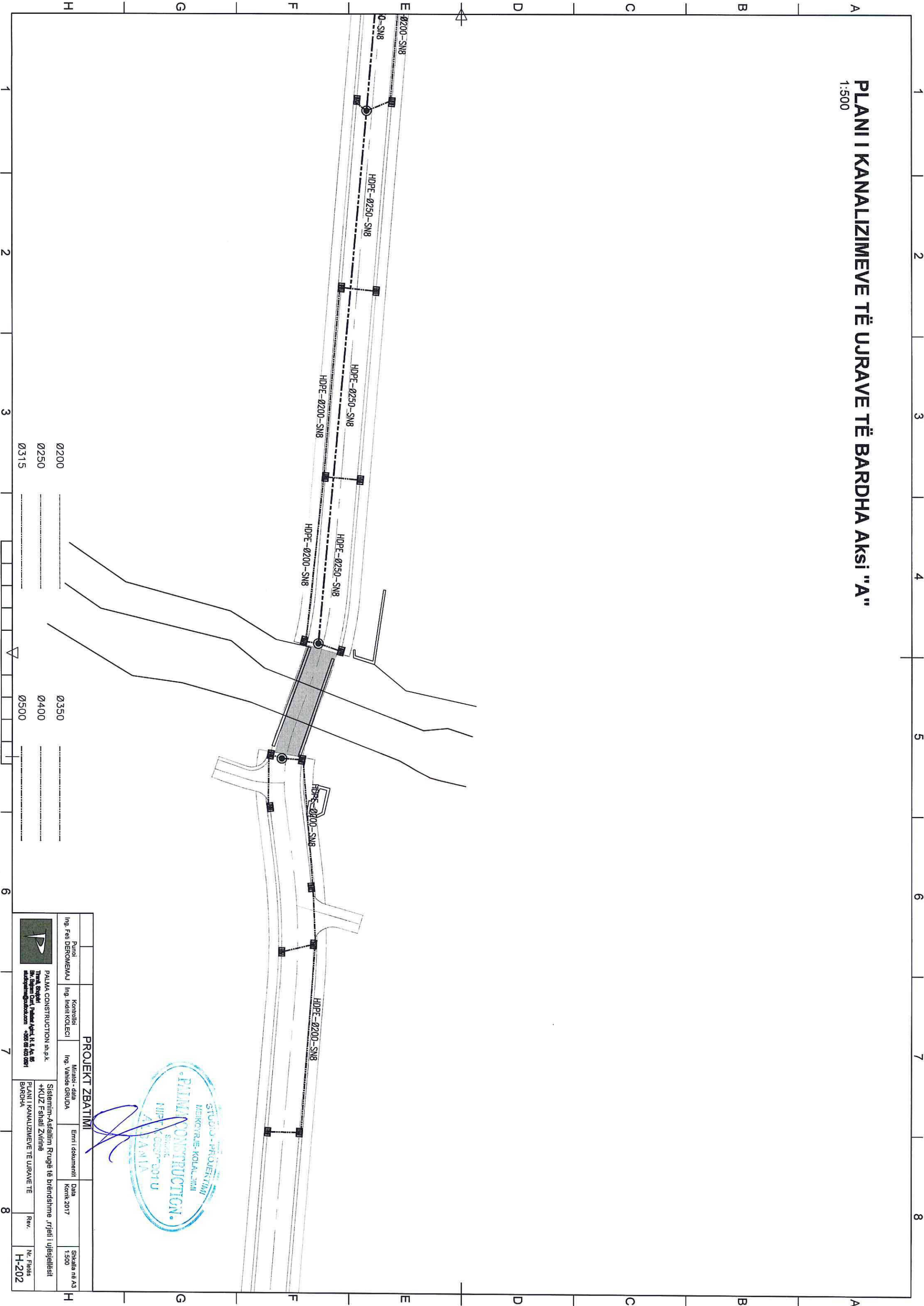

PROJEKT ZBATIMI			
Punoi	Kontrolloi	Miratoi - dita	Emri i dokumentit
Ing. Fau DEROMEKALJ	Ing. Indrit KOLECI	Ing. Vanda GRUDA	Data
PALMA CONSTRUCTION sh.p.k.			Kontrollimi
Tirana, Shqipëri Bv. Shqipëri, Pëllumbas, Këmbës, Nr. 11 & Nr. 12 autogjurmimi@palma.com +355 69 403 0891			Kontrollimi
Sistemi i Armatimit Rrugë të brëndshme, rrjetit i ujësjetësist +KUZ Fshajt Zvrinë			Rev.
PLANI I KANALIZIMEVE TË URAVE TË BARDHA			Nr. Fletës
			H-202



PUCETA SHIU DHE DETAJE

MIRATOHET
KRYETARI I BASHKISE
MALIQ
GEZIM TOPÇIU

PRERJA A-A SH 1:10

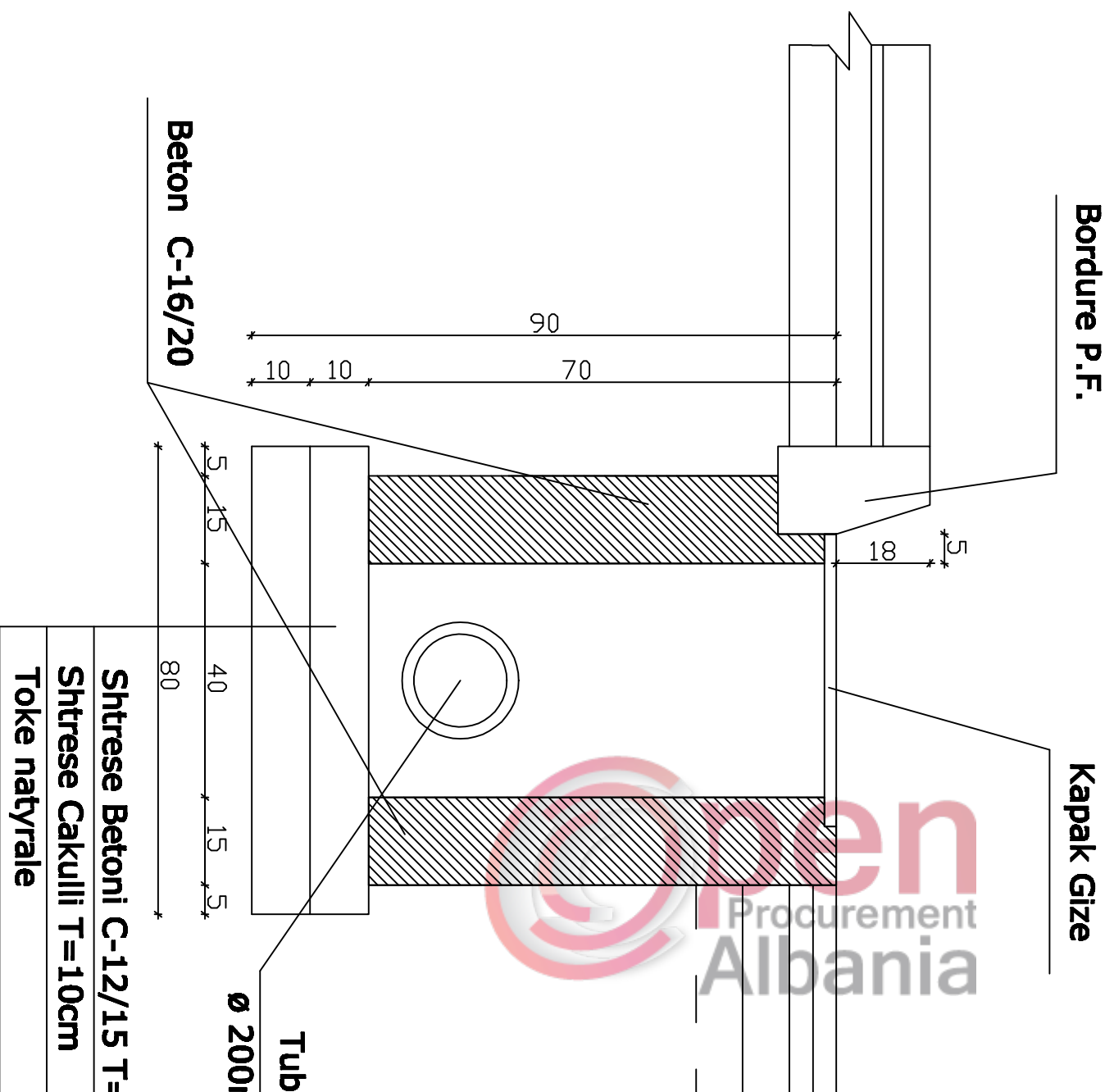

PLANIMETRIA E PUSETES SE UJRAVE SIPERFAQESORE

SH 1:10

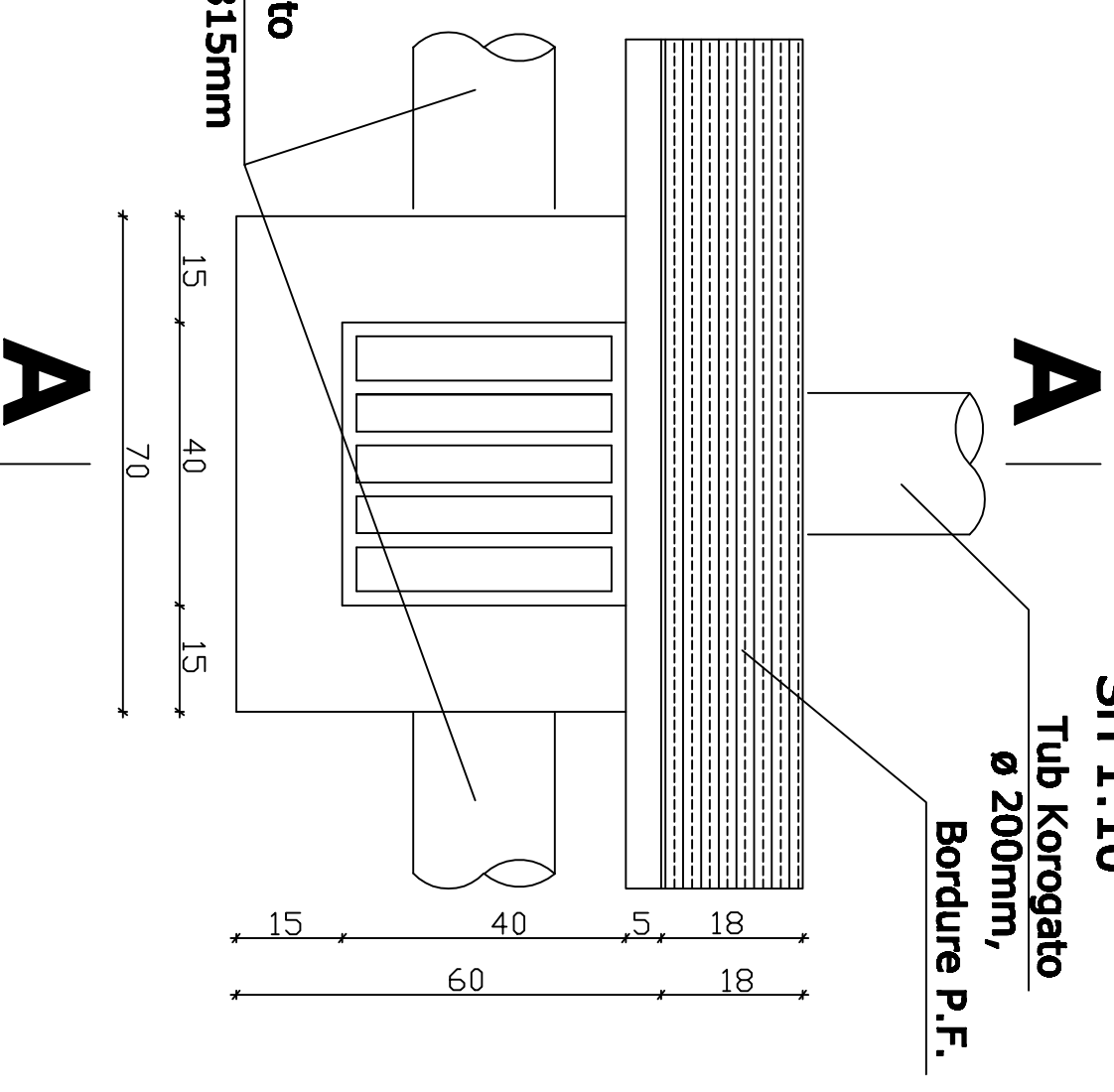

- Shtrese Betoni C-12/15 T=10cm
- Shtrese Cakulli T=10cm
- Toke natyrale

Tub Korogato
Ø 200mm, Ø 315mm

A

Qelimi	Avdi	Dc	Shtesha	Doc. number
Pse Agjencia	Ing.SKODRË	Ing.JL.ZBULLI		Regjist. 13/1
Emertimi i vizatimit				ORGANIZATA E PRAKTIKANTËR ZHVILLIMET E TËRMEJIT ING. SHKODRË, ZHURRIANË
Pusetete Shiu				

PUCETA SHIU DHE DETAJE

MIRATOHET
KRYETARI I BASHKISE
MALIQ
GEZIM TOPÇIU

PRERJA A-A SH 1:10

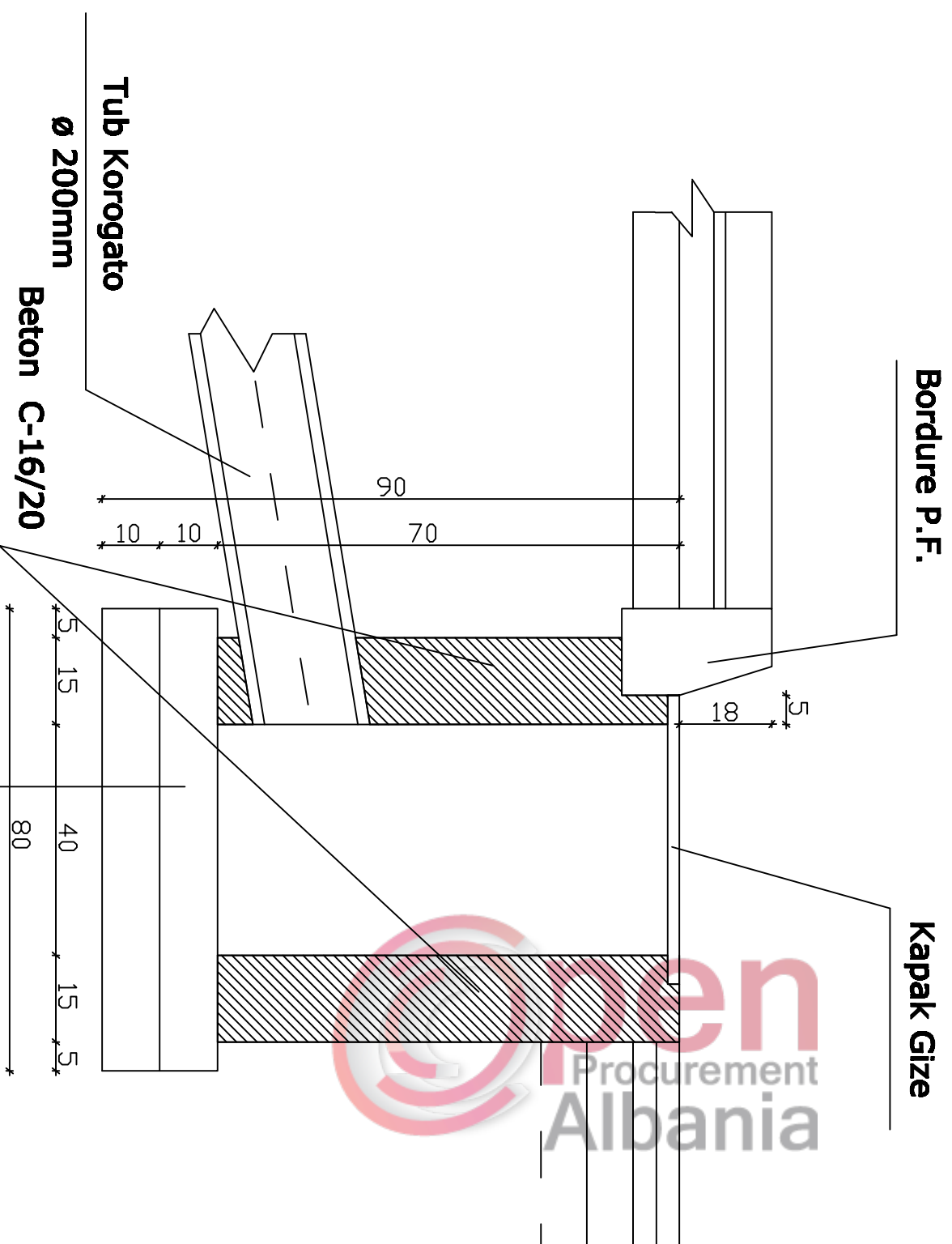

PLANIMETRIA E PUSITES SE UJRAVE SIPERFAQESORE SH 1:10

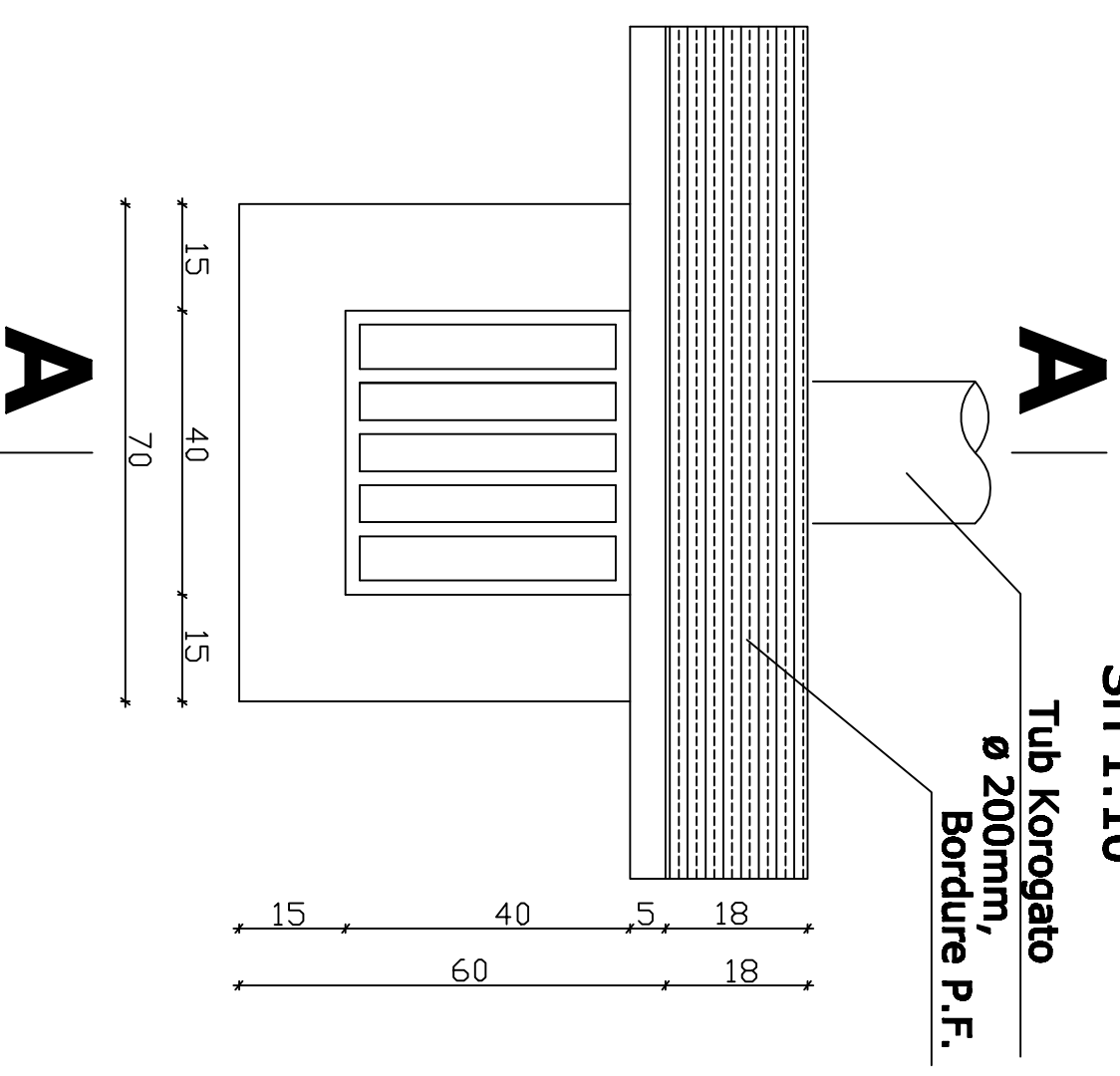

Shtrese Betoni C-12/15 T=10cm
Shtrese Cakulli T=10cm
Toke natyrale

SISTEMIM ASFALTIM | RRUGËS HYRËSE | FSHATIT ZVIRINË (Faza I)

Qelbimi	Avdi	Dz	Shtesha	Doc. number
Pse Agjencia	Ing.S.KODRI	Ing.M. ZEBULI		Regjist. 13/2
Emertimi i vizimitit				
Pusetete Shiu				

ORGANIZATA E PLANIMETRIE DHE ZHVILIMIT TE TERRITORET DHE SHPALLIMETRA, ZHURINJAN

PLANIMETRI E PERGJITHSHME E NDRICIMIT

1:500

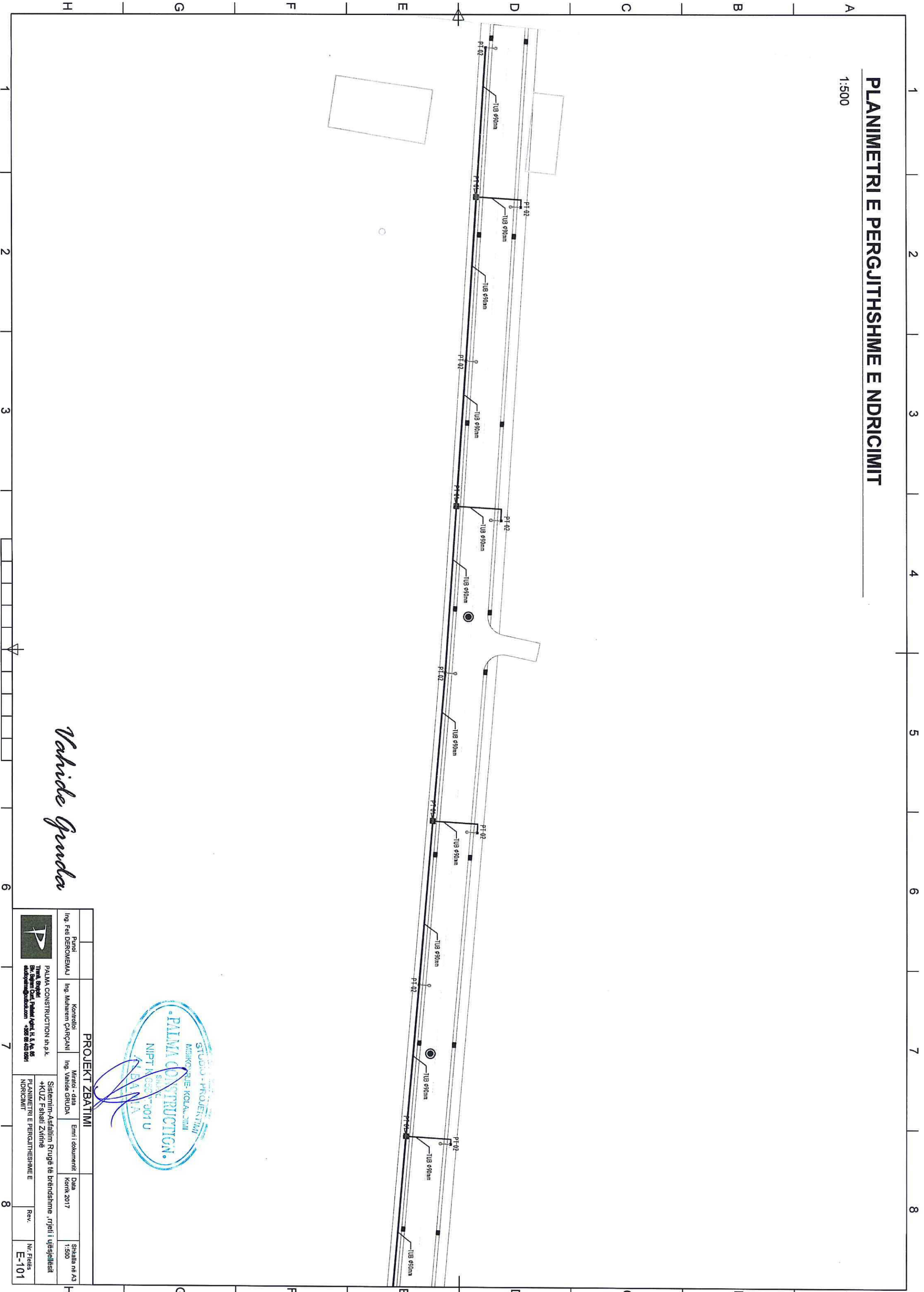

Vahide Gruda

PROJEKT ZBATIMI			
Punoi	Kontrolli	Mirësi - data	Emri i dokumentit
Ing. Fati DEROMEAJ	Ing. Muharem ÇARÇANI	Ing. Vahide GRUDA	Data
PALMA CONSTRUCTION sh.p.k.		Korrik 2017	
Tirana, Shqipëri Bv. Shqipëri Çeliku, Pallati Nr. 11 & Nr. 15 Autoparkimi@palma.com +355 68 408 0891		Sistemin-Asfaltim Rrugë të brëndshme - rrjeti i ujësullësi +KUDZ-Fshati Zymëre	
NDRICIMI		Rev.	Nr. Fletes
			E-101

PLANIMETRI E PERGJITHSHME E NDRICIMIT

1:500

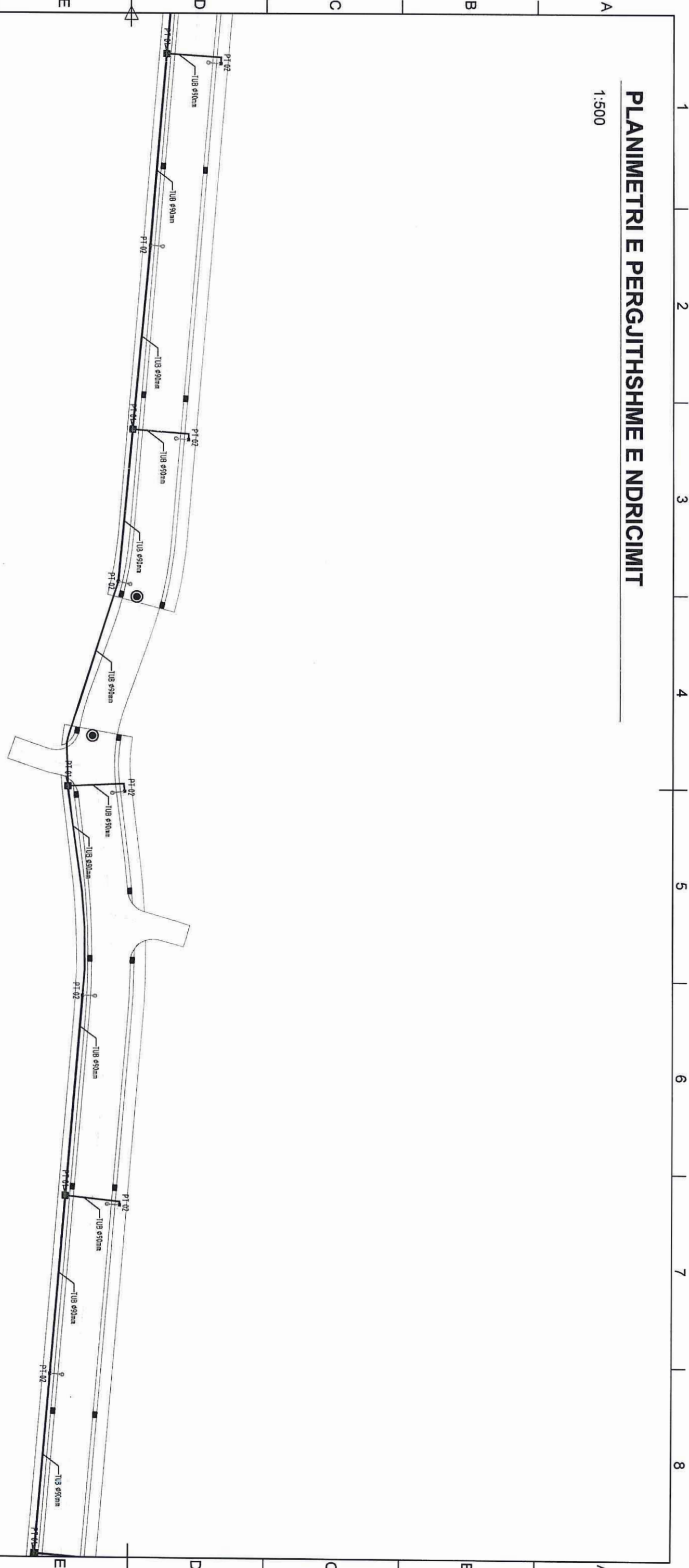

PROJEKT ZBATIMI

Proj. P Ing. Fati DEROMEJAJ	Kontrollor Ing. Muharem ÇARÇANI	Mirator - data Ing. Valide GRUDA	Emri i dokumentit Sistemi: Asfaltim Rrugë të brendshme, rrethi i ujësillësi +KUZ F'shahë Zafinë	Data Korrik 2017	Shkalla në A3 1:500
PALMA CONSTRUCTION sh.p.k. Tirana, Shqipëri Rruga "Dëshmorët e Kombit" Nr. 10 Tel: +355 69 450 0591 Email: info@palmaconstruction.com			PLANIMETRI E PERGJITHSHME E NDRICIMIT	Rev.	Nr. Fletës E-102

PLANIMETRI E PERGJITHSHME E GJELBËRIMIT

1:500

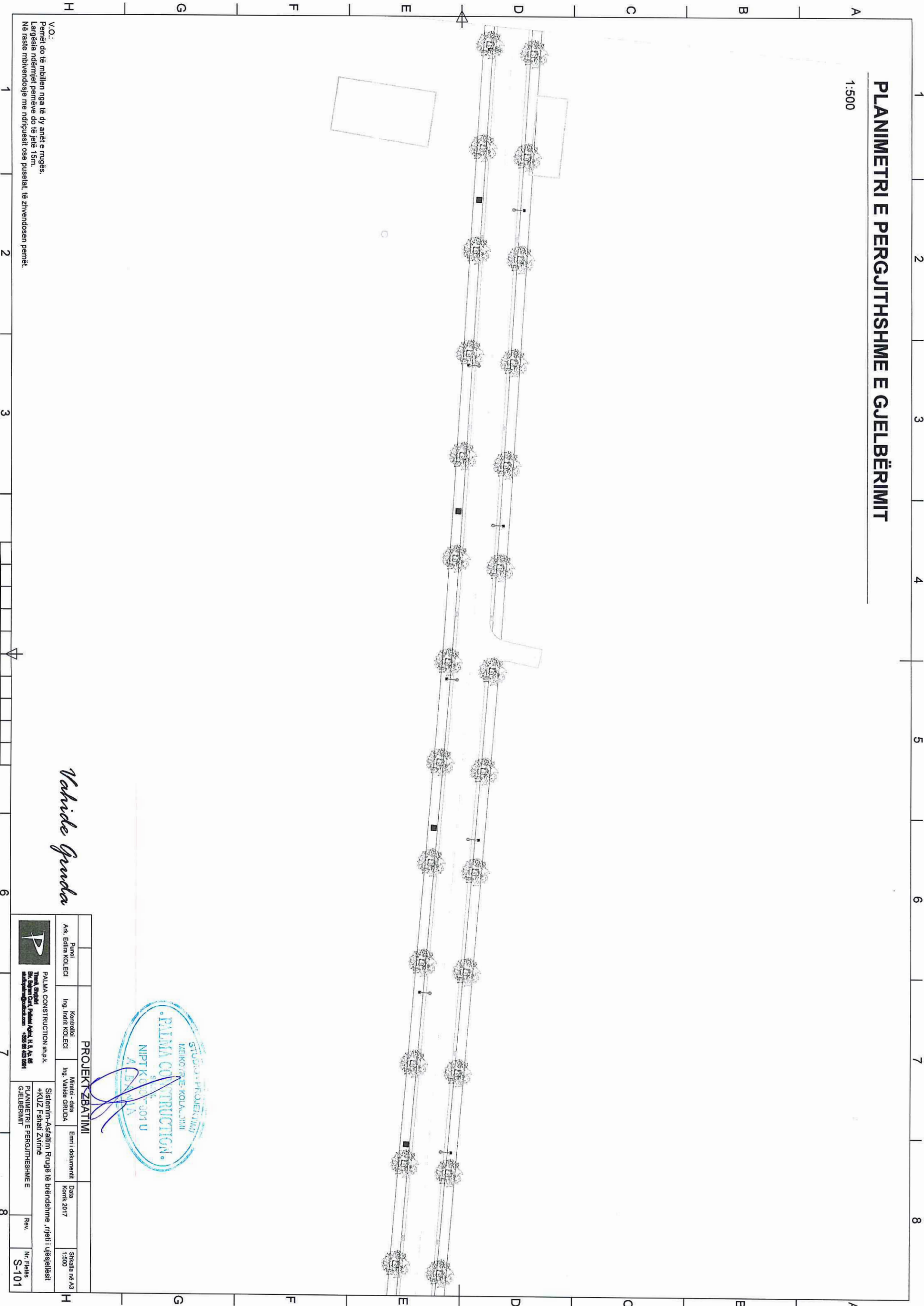

Schide Gruda



PROJEKT ZBATIMI			
Punoi	Kontrollori	Mirator - data	Emri i dokumentit
Ark. Edlira KOLECI	Ing. Indris KOLECI	Ing. Valide GRUDA	Data
PALMA CONSTRUCTION sh.p.k.		Sistemi: Asfaltim Rruge të brendshme, rrethi i ujësillësi + KLIZ Fshati Zvërnë	
Tëra të drejtat e autoritetit të kësaj sh.p.k. janë të rezervuara dhe nuk mund të përdoren pa lejen e kompanisë.		PLANIMETRI E PERGJITHSHME E GJELBËRIMIT	
Rev.			Nr. Fletës
			S-101

V.O.:
Pemeti do të mbillen nga të dy anët e rrugës.
Largësia ndërmjet pemëve do të jetë 15m.
Në rastë mbivendosje me ndëruasit ose puselat, të zhvendosen pemeti.

PLANIMETRI E PERGJITHSHME E GJELBËRIMIT

1:500

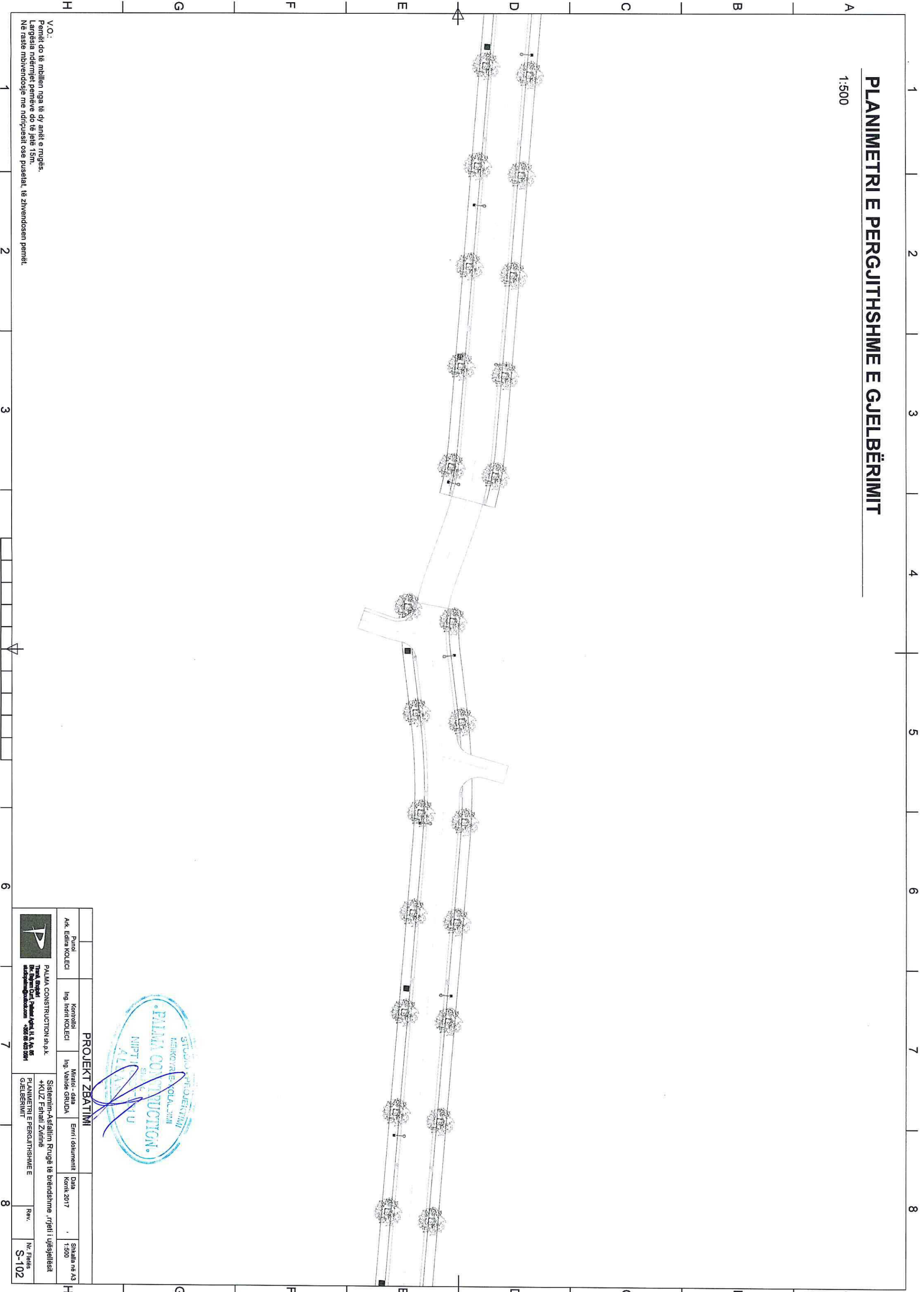

PROJEKT ZBATIMI			
Punoi	Kontrolli	Miratoj - data	Emri i dokumentit
Ark. Edira KOLECI	Ing. Indri KOLECI	Ing. Vendi GRUDA	Data
PALMA CONSTRUCTION sh.p.k. Tirana, Shqipëri Bv. Shqipëri, Përkrahje Nr. 11 & Nr. 12 Autoparkimi: 067 88 403 0091			Kontrolli Komit. 2017
Sistemi - Afatim Rrugë të brëndshme, rrjetit i ujësullësit +KUZ Fshatit Zvinnë			Shpalla nr. A3 1:500
PLANIMETRI E PERGJITHSHME E GJELBËRIMIT			Rev.
Nr. Fletës S-102			

V.O.:
Pernëti do të mbillen nga të dy anët e rrugës.
Largësia ndërmjet pemëve do të jetë 15m.
Në rastie mbivendosje me ndriçuesit ose puselet, të zhvendosen pemët.

KOLLONA H.S.P. KONIK

SH 1:25

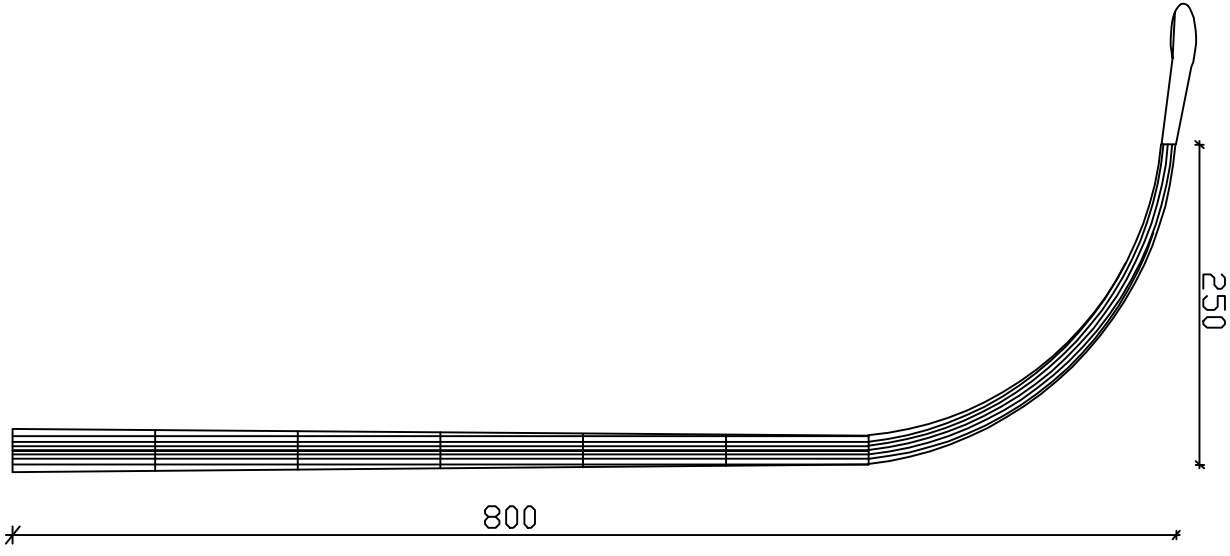

DETALJ I INKASTRIMIT TE KOLLONES

SH 1:25

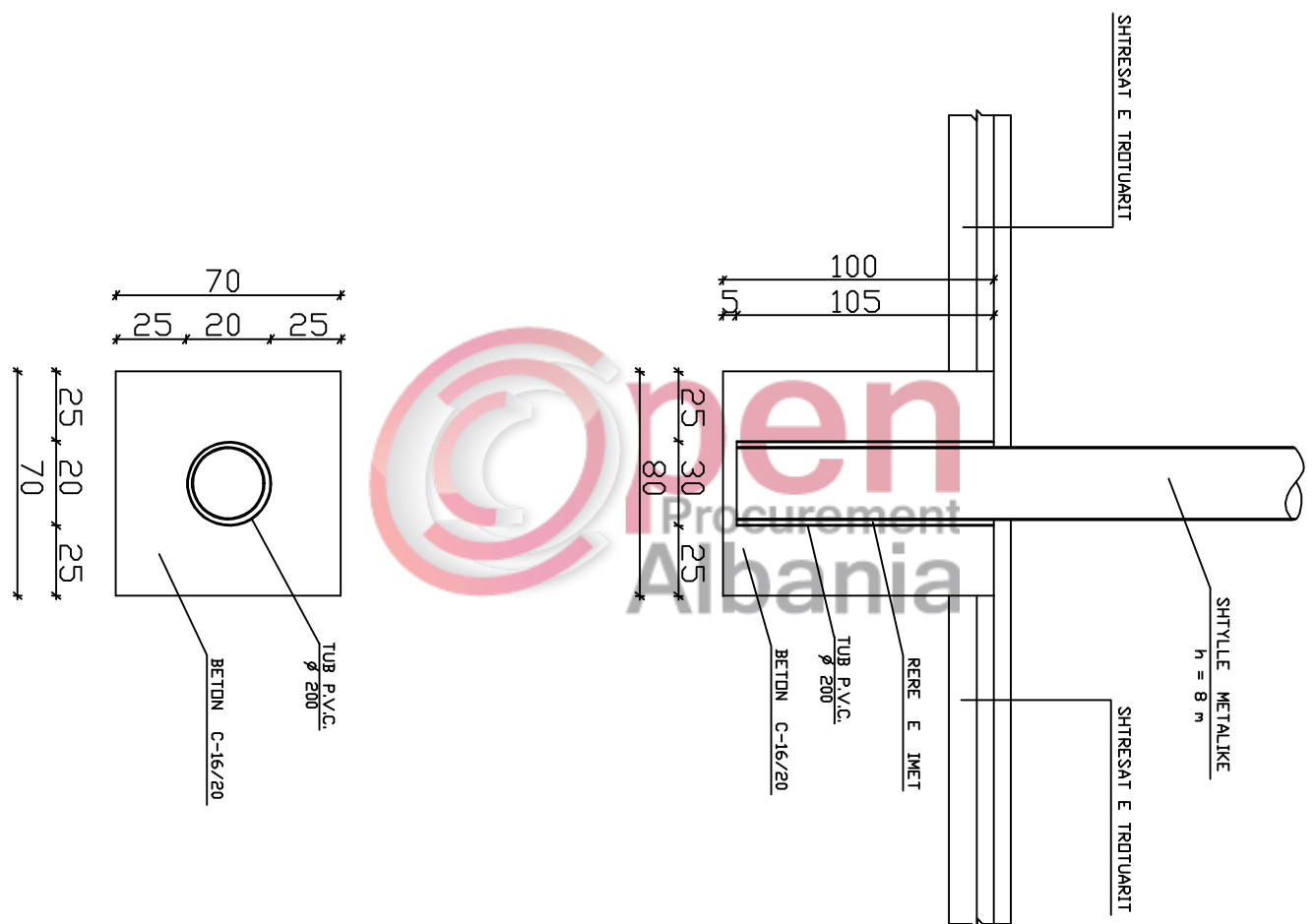

TIDHJA E ELEKTRODES

SE TOGEZIMIT

SH 1:25

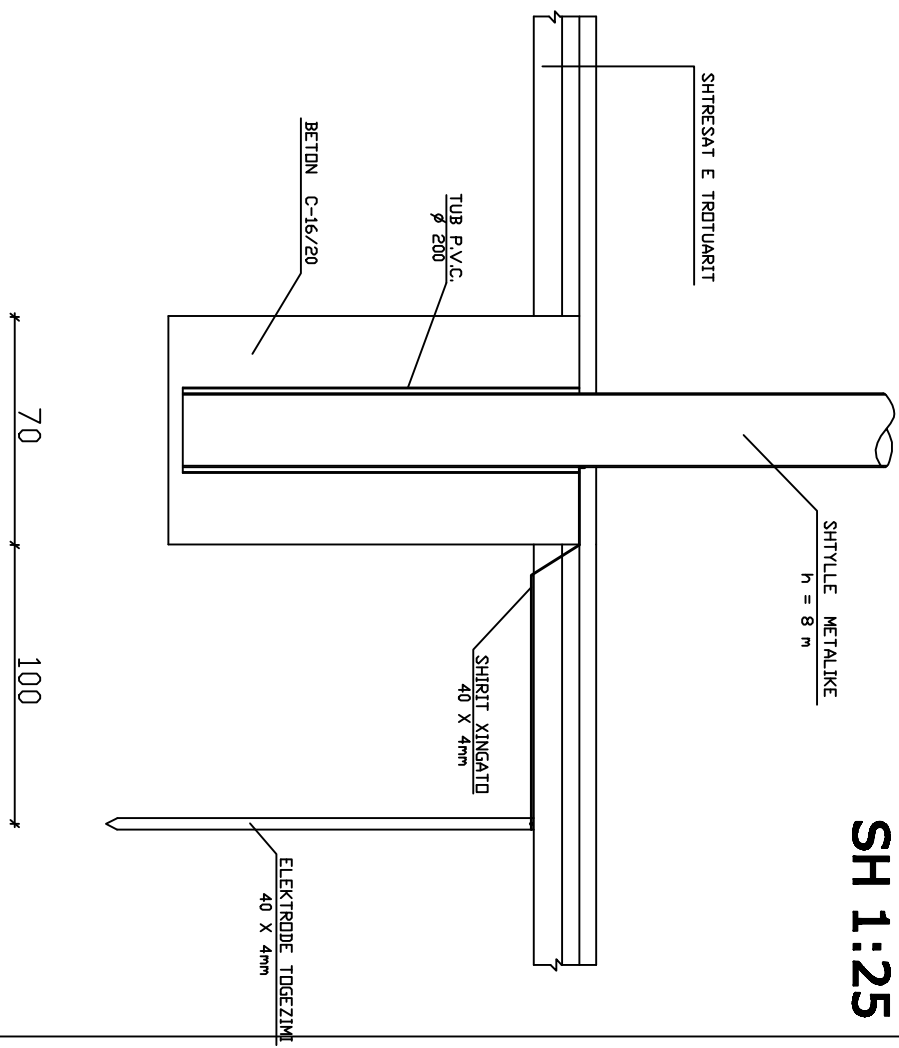

SISTEMIM ASFALTIM I RRUGËS HYRËSE I FSHATIT ZVIRINË (Faza I)

**MIRATOHET
KRYETARI I BASHKISE
MALIQ
GEZIM TOPÇIU**

Qëndra	Avla	Dc	Shtylla	Doc. number
Per Agjencine	Ing. S. KOSTI	Ing. M. ZBULI		Page: 15/1
Emertimi i vizatimit				Drejtorja e Pajushit
Detajet e Ndricimit				Zhvilluesit e vizatimit
				Ing. SHKENDER XHARRAJ

PLANIMETRIA E PUSETES ELEKTRIKE NE TROTUAR

SH 1:25

MIRATOHET

KRYETARI I BASHKISE

MALIQ

GEZIM TOPÇIU

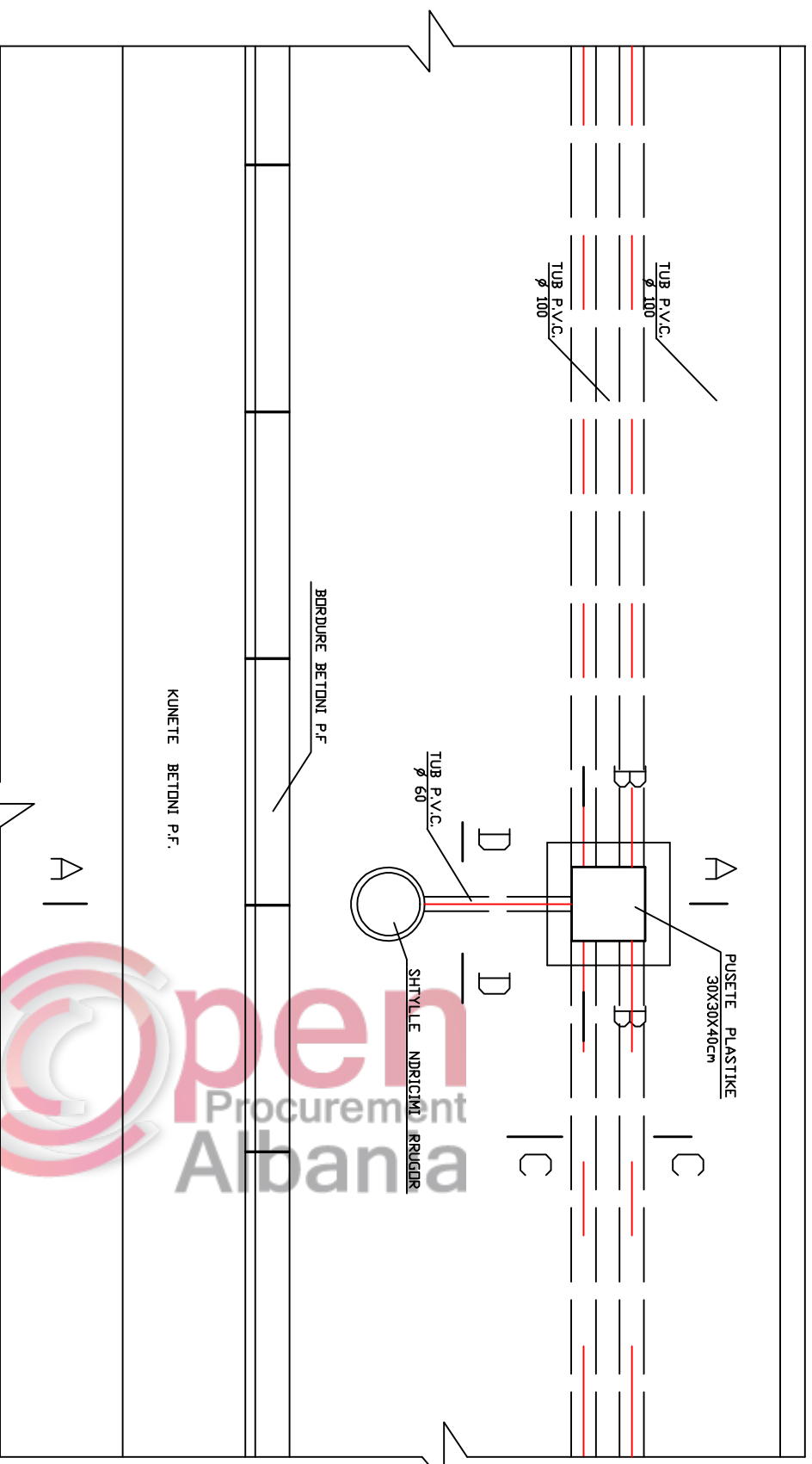

PRERJA A - A
SH 1:25

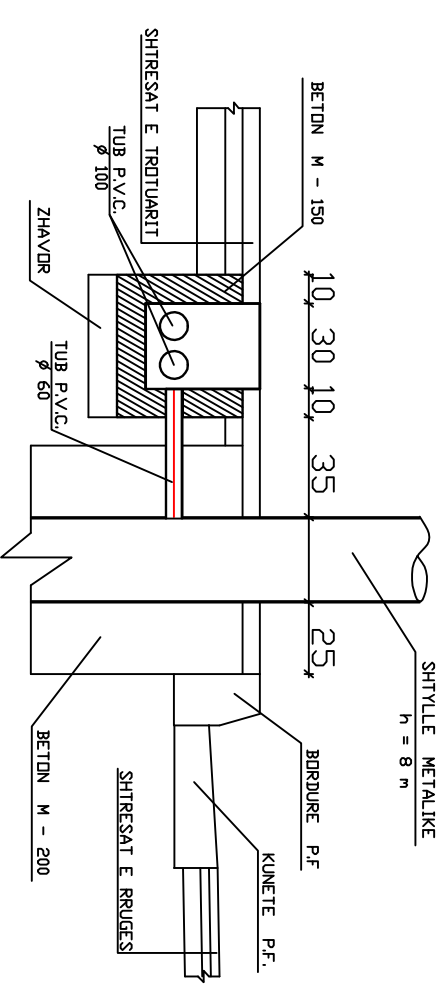

PRERJA D - D
SH 1:25

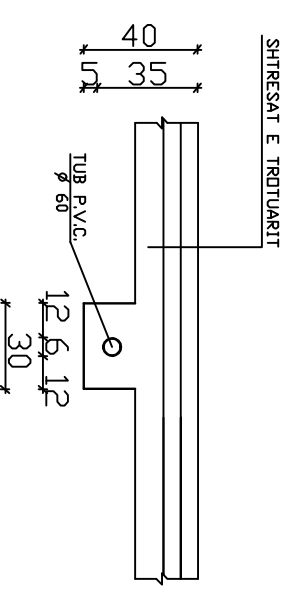

PRERJA C - C
SH 1:25

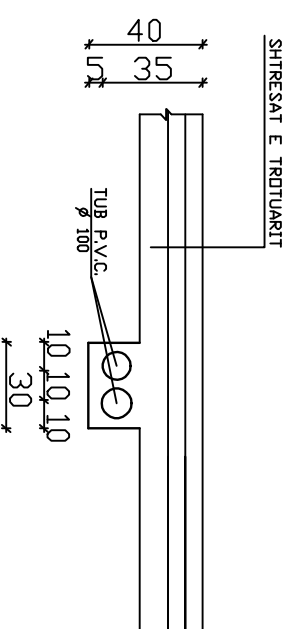

PRERJA B - B
SH 1:25

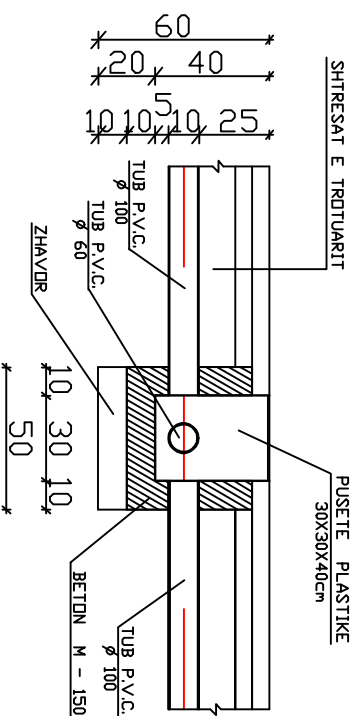

SISTEMIM ASFALTIM I RRUGËS HYRËSE I FSHATIT ZVIRINË (Faza I)

Qëllimi	Asht.	Dz.	Shtabla	Data, numër
Pse Agjencia	Ing. S. KOTI	Ing. M. ZBULI		Regjist. 15/2
Emertimi i vizatimit				
Detajet e Ndricimit				
DISEJTOVA E PRAJETOVA DISEJTOVA E PRAJETOVA ZHVILLOVA E TREGTOVA ING. ENKELB D. ZHURAVLARI				