



REPUBLIKA E SHQIPERISE

BASHKIA GRAMSH
MIRATOHET
KRYETARI I BASHKISE
"LULJETA DOLLANI"

PROJEKT ZBATIMI

**OBJEKTI: "RIKONSTRUKSIONI I
KANALIT UJITES
GALIGAT - SINGAR SIPER - DRIZE
BASHKIA GRAMSH**

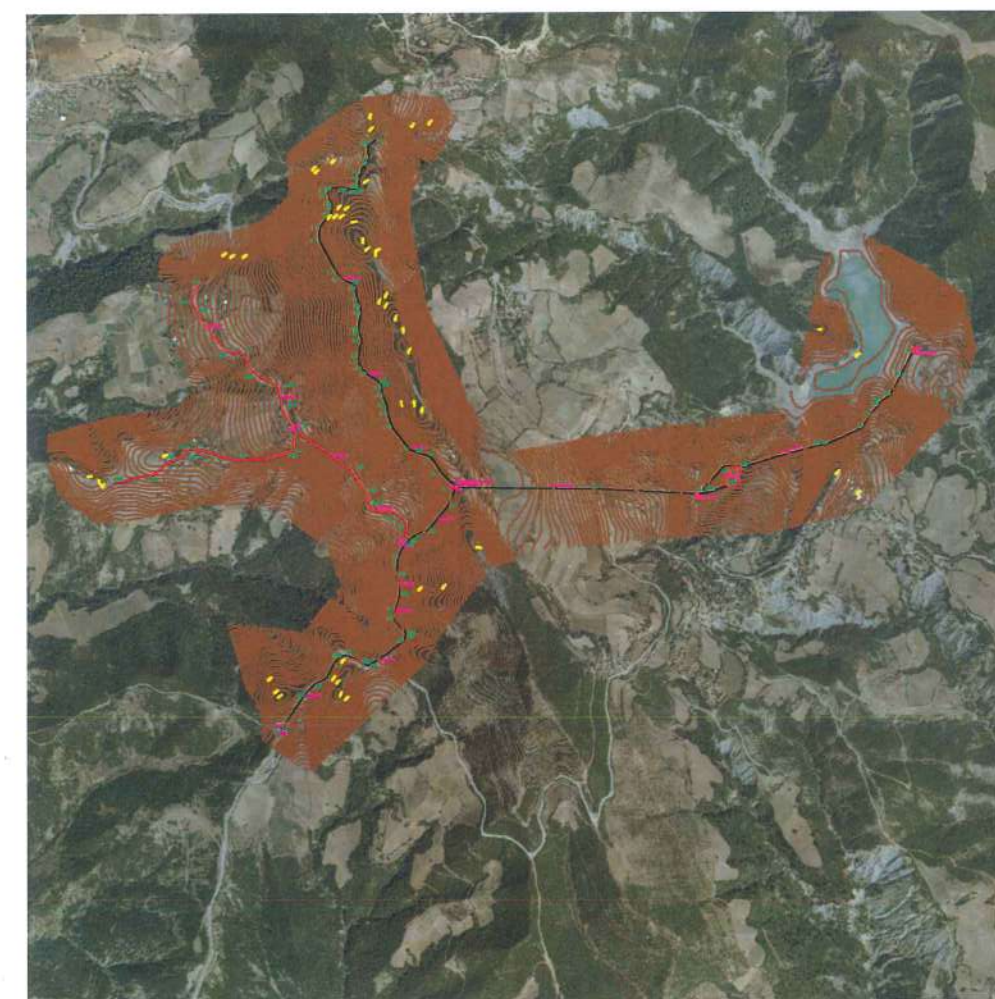
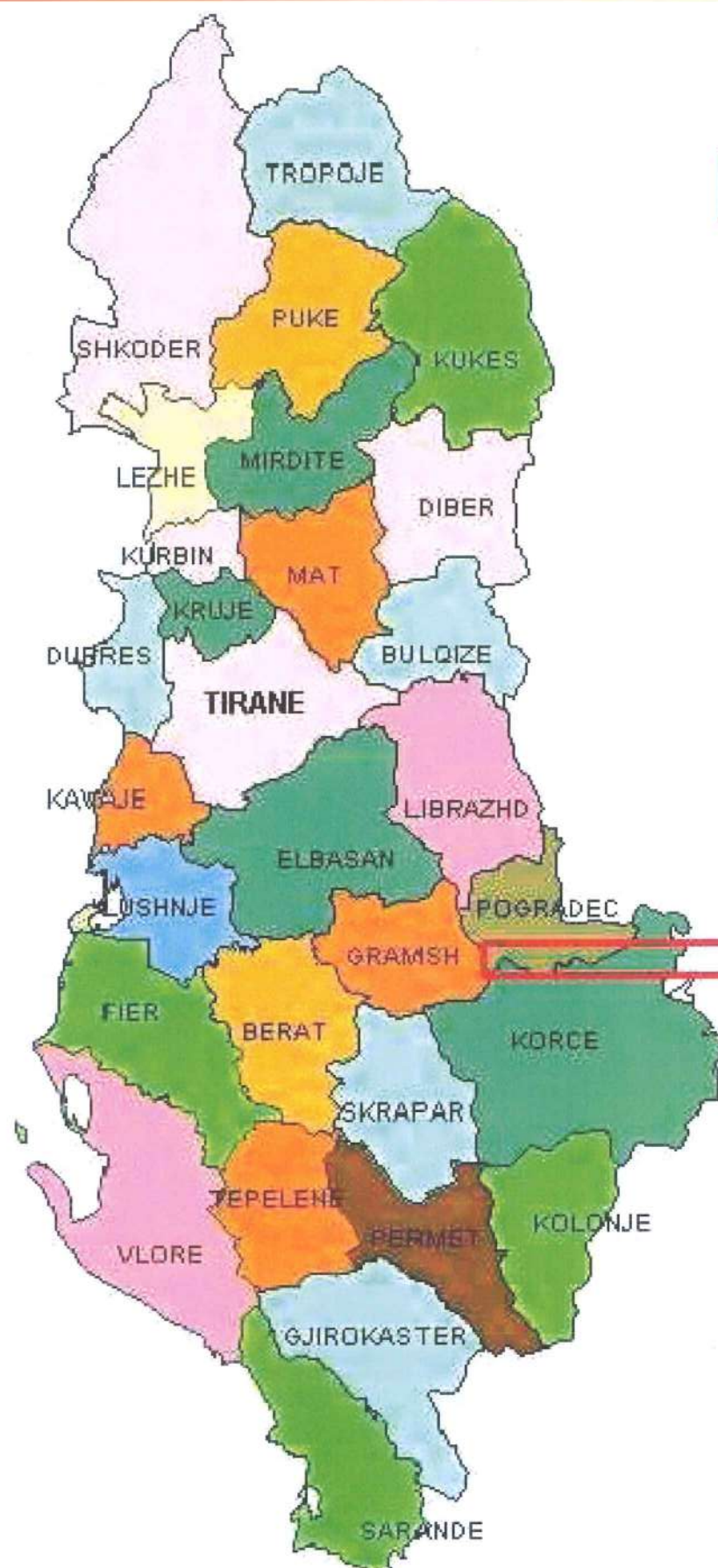

TABHA MYRTAJ
DREJTIM
E

PUSETE TIP (1.5x1.5x1.5)m

PLANIMETRIA SHK.1:25

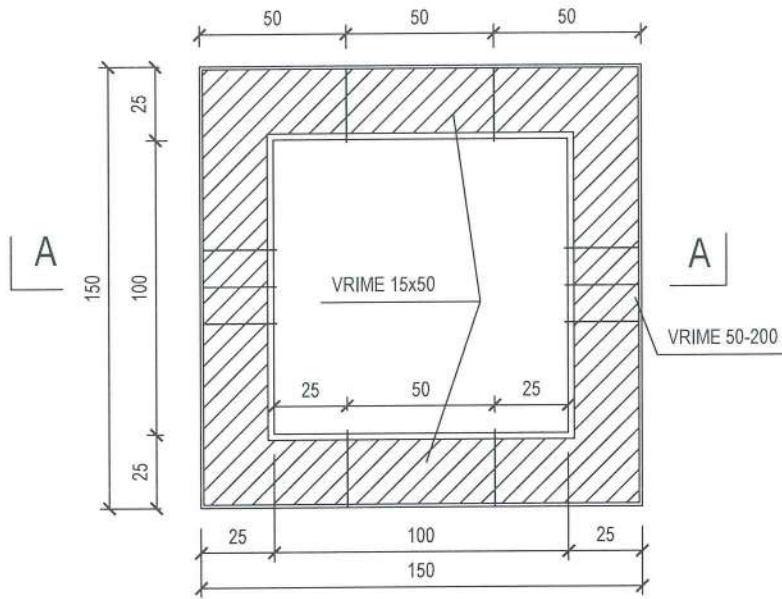

KAPAKU B/A I PUSETAVE

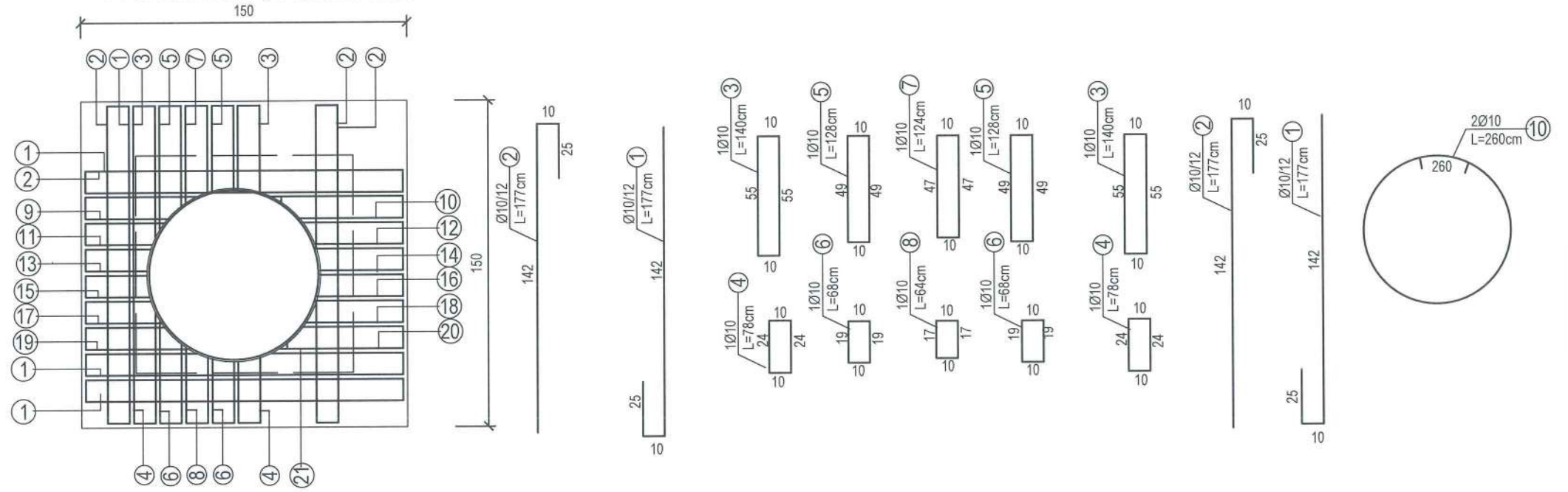

PRERJA A - A SHK.1:25



TABELA E HEKURIT PER KAPAKUN B/A TE PUSETAVE

ELEMENTI	NR	Ø mm	GJATESIA cm	N cope	Σ ml	PERMBLEDHESE			
						Ø/mm	Σ/ml	kg/ml	KG
KAPAK PUSETE	1	10	177	14	24.8	10	76.2	0.615	47
	2	10	177	14	24.8				
	3	10	140	2	2.8	TOTALI 47			
	4	10	78	2	1.6				
	5	10	128	2	2.6				
	6	10	68	2	1.4				
	7	10	124	1	1.3				
	8	10	64	1	0.64				
	9	10	86	1	0.86				
	10	10	144	1	1.44				
	11	10	70	1	0.7				
	12	10	130	1	1.3				
	13	10	64	1	0.64				
	14	12	124	1	1.24				
	15	10	66	1	0.66				
	16	10	128	1	1.28				
	17	10	78	1	0.78				
	18	10	108	1	1.08				
	19	10	100	1	1				
	20	10	166	1	1.66				
	21	10	260	2	3.2				

PUSETE (1x1x1.5)m TIP

NR	EMERTIMI	NJESIA	SASIA
1	GERMIM DHEU TOKE E FORTE PER GROPEN	M3	6
2	SHTRESE ZHAVORRI t=10cm	M3	0.26
3	BETON M-150	M3	2.45
4	BETON M-200 PER APAKUN	M3	0.295
5	KALLEPERI	M2	21
6	HEKUR BETONI	KG	47
7	KAPAK GIZE I BRINJEZUAR	COPE	1

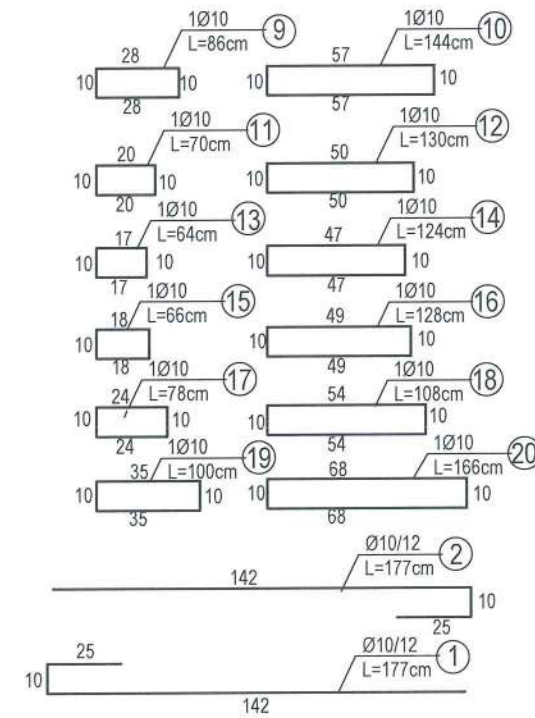
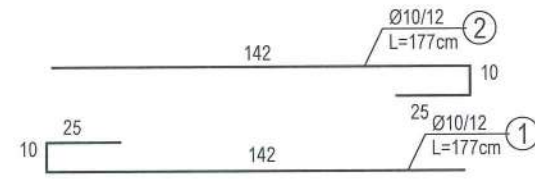
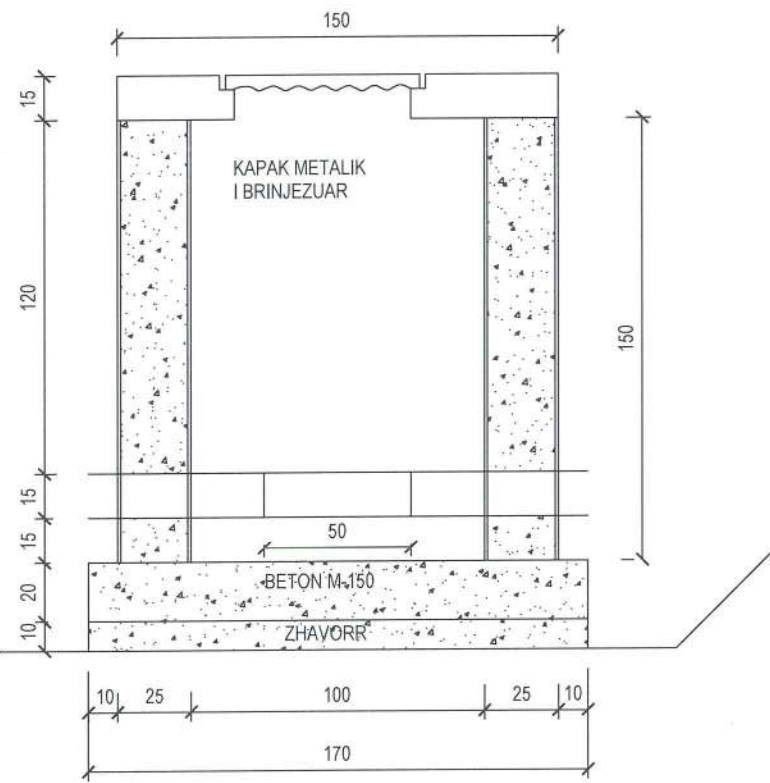
NATASHA MYRTAJ
PROJEKTIM DREJTIM
KO

KALIM KANALI DHE RRUGE ME TUB CELIKU TIP

Sh 1:100

Detaj i Bllokut te Ankorimit Shk 1:20

Planimetria Sh 1:100

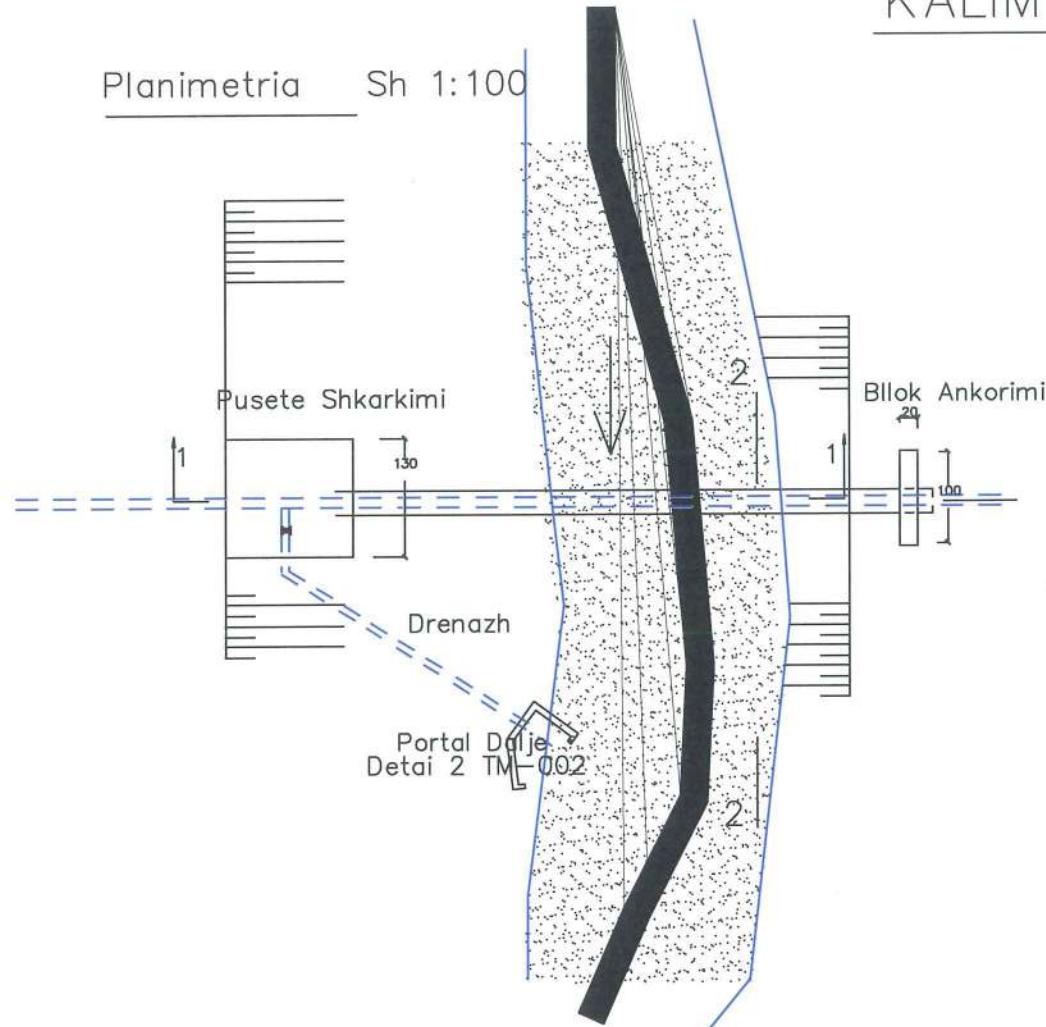

Detaj i Tubit KUR KALON RRUGEN

sc 1: 10

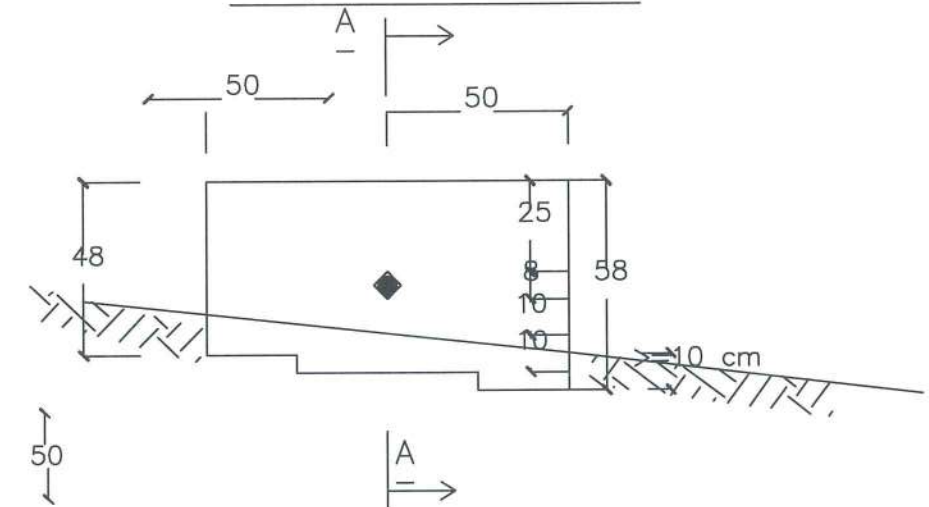
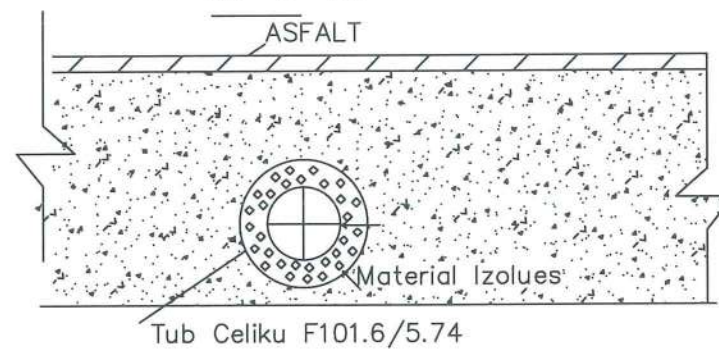

Seksioni A-A

PAKETA E RRUGES
Tub Celiku F101.6/5.74

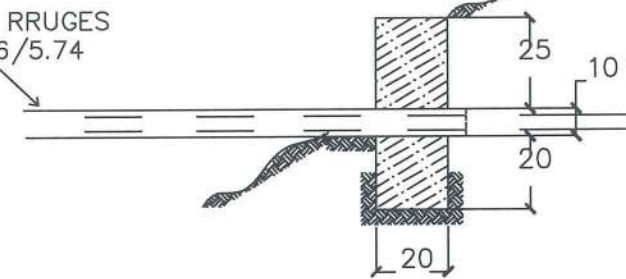

Mbushje me material rrethanor

Detail 2

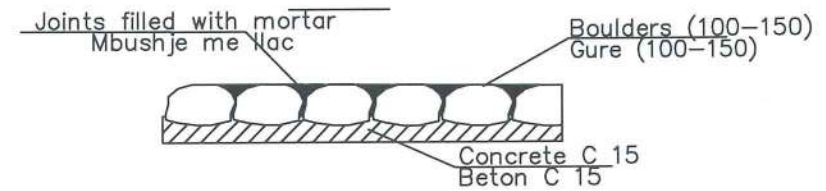

Flap valve
Valvol me lekundes

Subsoil (boulders layed in concrete C15)
Nenshtresa (gure te zhytur ne beton C15)

Block work
Mur guri

Kanali

Pusete Shkarkimi

Tub Celiku F101.6/5.74

Bllok Ankorimi

estimated max WL

actual WL

Unregistered Version - <http://www.cadcam.com>

<= 6 m

Detaj i Tubit
sc 1: 10

Tub Celiku F101.6/5.74

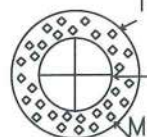

Material Izolues

NATASHA MYRTAJ
PROJEKTIM DREJTIM
KOALIM

KALIM TIP ME TUBACION CELIKU Ø 400/6.3. L=45m (Pk 24 -:- 26)

PRERJA A-A SH. 1:50

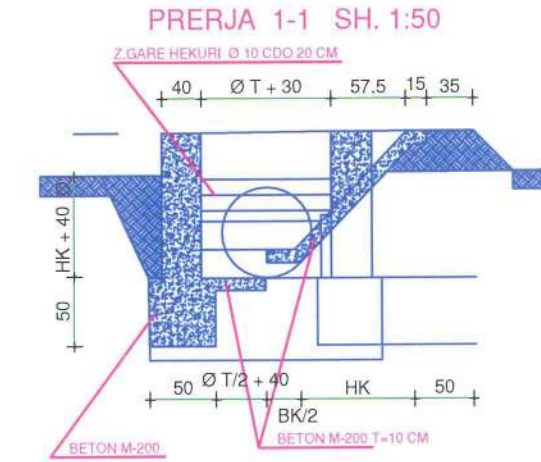
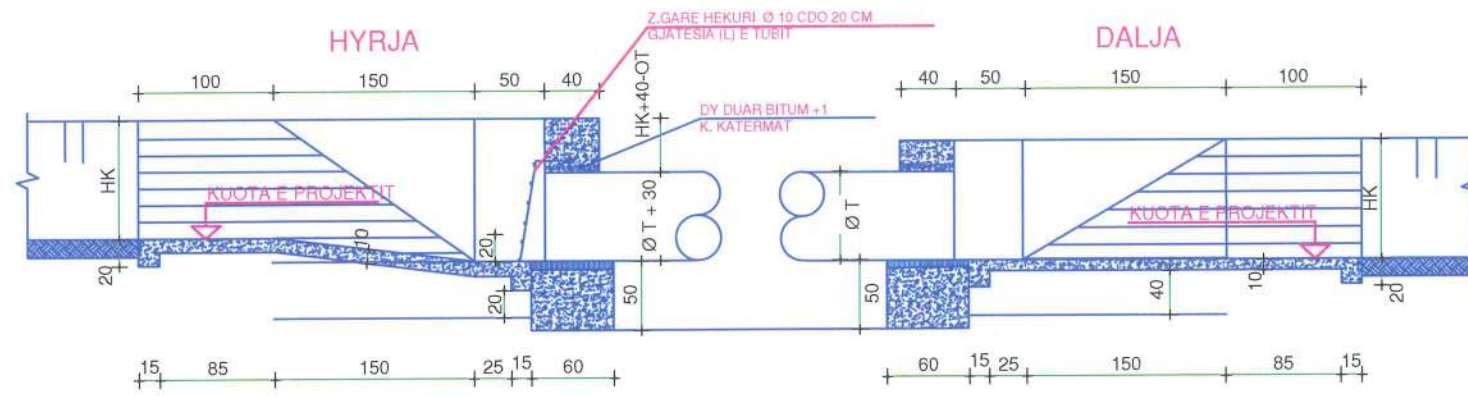

HYRJA

PLANIMETRIA SH. 1:50

DALJA

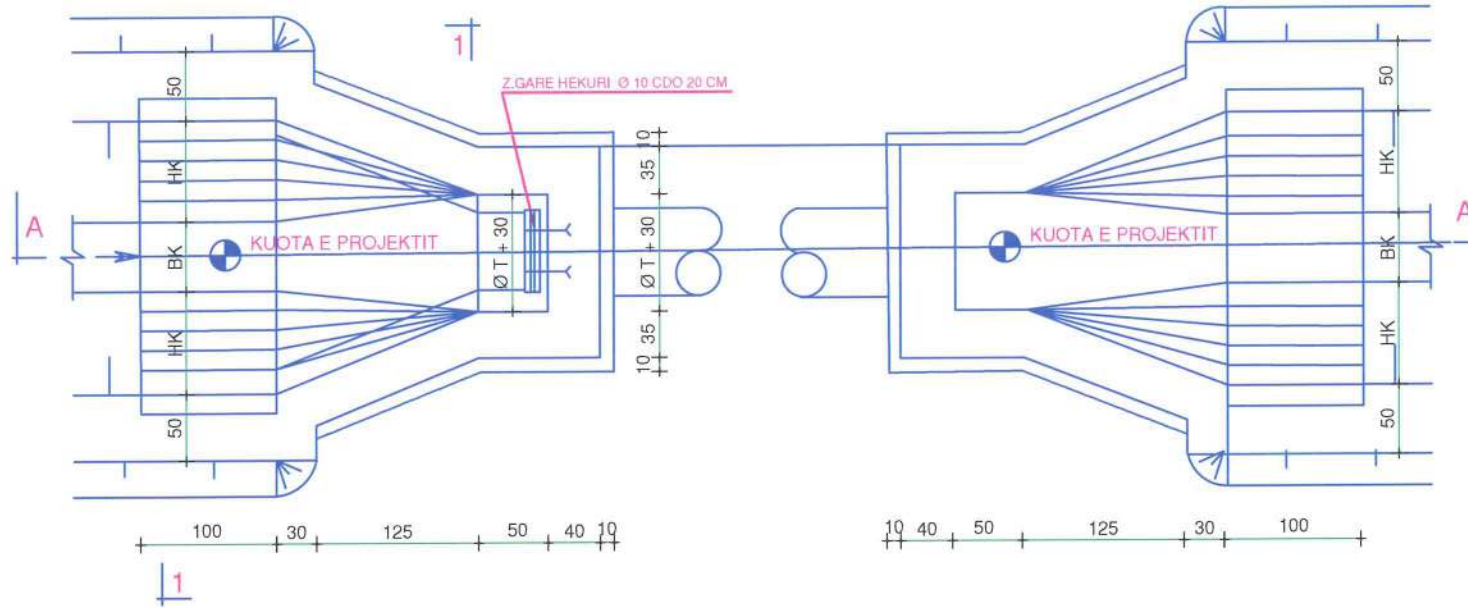

SHENIME:

1. VOLUMET JANE LLOGARITUR PER KANALE HYRJE-DALJE ME KETO PERMASA:
 PER TUB 219 -402 mm BKXHK =40X60 cm
 PER TUB 500 mm BKXHK =40X70 cm
2. PER PERMASA TE NDRYSHME NGA KETO TE BEHET NDRYSHIMI NE ANALIZEN PERKATESE.
3. KUOTA E PROJEKTIT MERREN NE PROFILIN GJATESOR.
4. GJATESIA L E TUB MERREN NE PROFILIN GJATESOR.
5. PER GJATESI TUBI MBI 10 M NDERTOHET PLE. MBESHTETSE (SHIH VIZATIMIN PERKATES)

F.V. tub celiku Ø 400/6.3, L= m (Pk. -:-)

NR	PERSHKRIMI I PUNIMEVE	Nnjesia	Sasia
1	Germim dheu me krahe	m ³	9
2	Mbushje + ngjeshje dheu	m ³	3.5
3	Beton C16/20 per mure themele	m ³	5.6
4	Beton C16/20 per veshje	m ³	1.5
5	F.V tub celiku Ø 609/6.3 L= m (Pk -:-)	kg	7708
6	Lyerje dy duar boj antiruxho	m ²	157
7	Leter katerma + dy duar bitum	m ²	1.9
8	F.V hekur per zgare	kg	5.2

NATASHA MYRTAJ
PROJEKTIM DREJTIM
KOLLEVA

TOMBINO TIP NE KANALE UJITES

PRERJA A-A SH. 1:50



PLANIMETRIA SH. 1:50

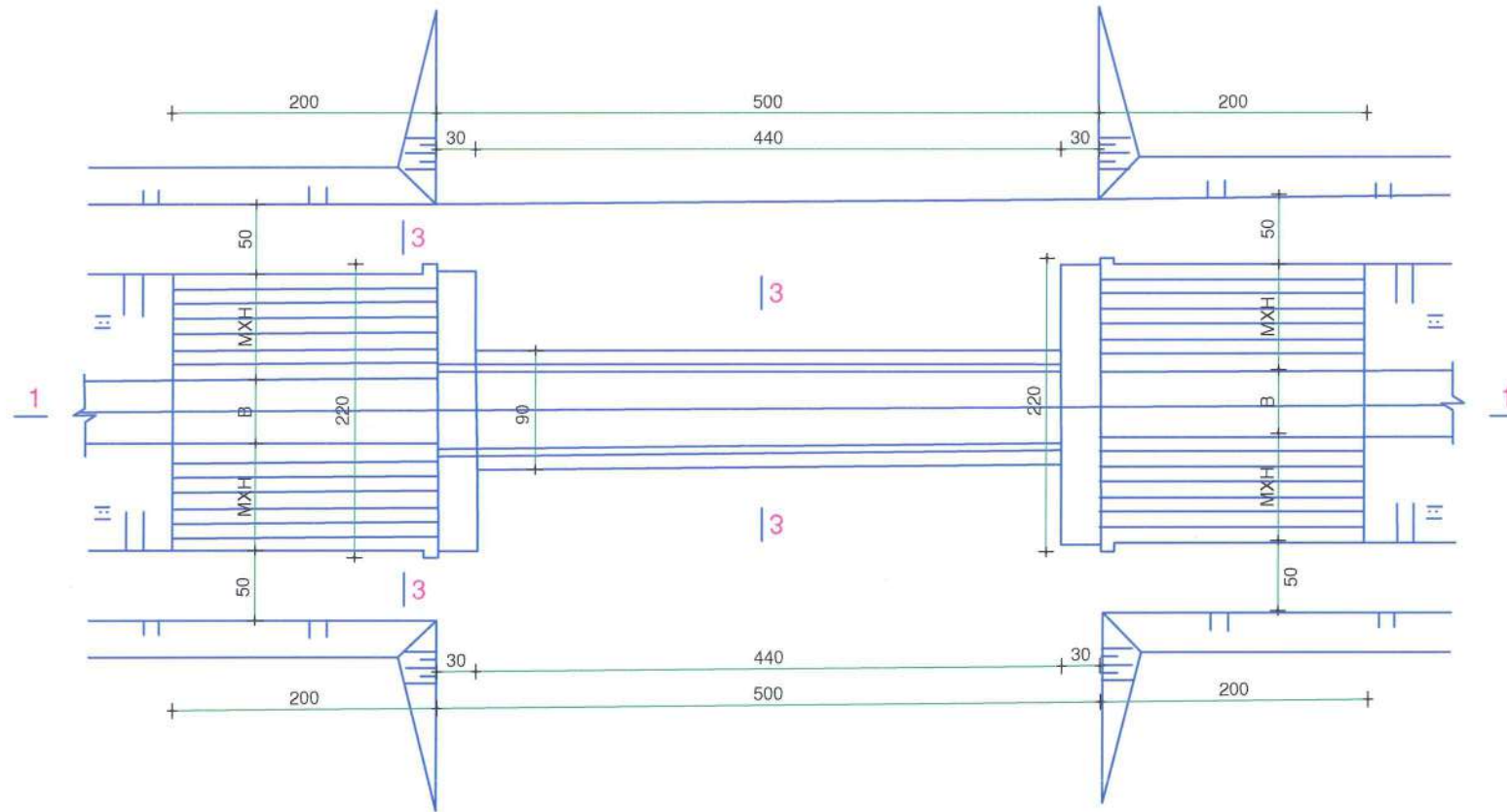

PRERJA A-A SH. 1:50

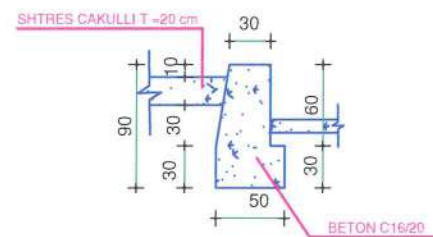

SHENIME:

1. PJERRRESIA E TOMBINOS ESHTË PRANUAR E NJELLOJTE ME ATE TE KANALIT.
2. BANKINA E KANALIT NE HYRJE TE TOMBINOS DUHET TE JETE ME SHUME SE 20 cm MBI RAVANIN E TUBIT $H > \varnothing T + 20$ cm
3. VEAHJA NE HYRJE DHE DALJE DO TE PERSHTATEN ME KUSHTER KONKRETE TE KANALIT. SITUACIONIMI BEHET SIPAS VOLUMEVE FAKTIKE.

PRERJA 2-2 SH. 1:50

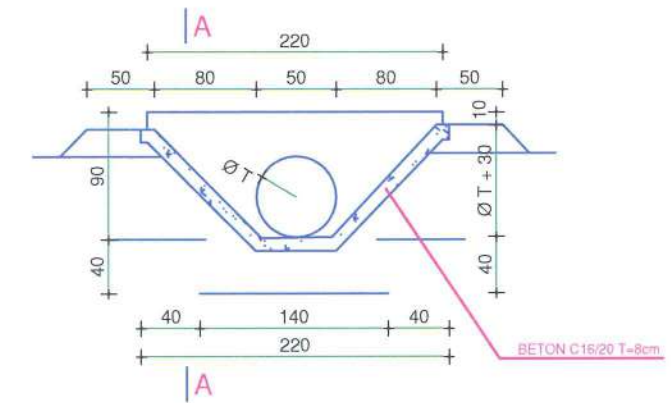

PRERJA 3-3 SH. 1:50

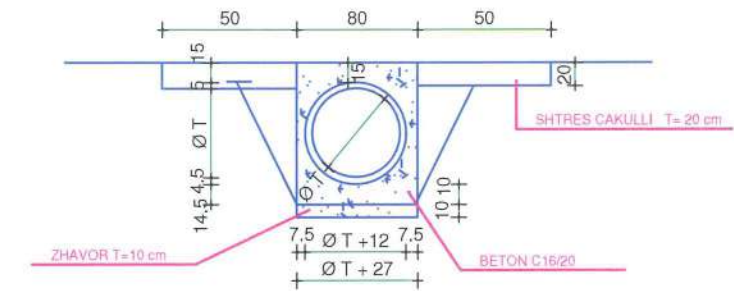

KALIM TUBI ME BETON $\varnothing 800$ mm L = m (PK. :-)

NR	PERSHKRIMI I PUNIMEVE	Nnjesia	Sasia
1	Germim dheu me krahe	m ³	35
2	Mbushje + ngjeshje dheu	m ³	12
3	Beton C16/20 per mure	m ³	1.6
4	Beton C16/20 per nenshtresat	m ³	5.2
5	Beton C16/20 per mbishtresat	m ³	6.3
6	Beton C16/20 per hyrje - dalje	m ³	1.4
6	F.V tub betoni $\varnothing 800$ mm	ml	35
7	Beton C16/20 per unazat e lidhjes	m ³	1.8
8	Beton C16/20 per veshje H + D	m ³	1.4

NATASHA MYRTAJ
PROJEKTIM DREJTIM
KOLAUDIM

PLANIMETRIA E KANALIT UJITES
GALIGAT-CINGAR SIPER- DRIZ



NATASHA MYRTAJ
PROJEKTIM DREJTIM
KOSOVË

Curator

PLANIMETRIA E KANALIT UJITES
GALIGAT-CINGGAR SIPER- DRIZ



NATASHA MYRTAJ
PROJEKTIM DREJTIM
KOLAUBIM

PLANIMETRIA E KANALIT UJITES
GALIGAT-CINGAR SIPER- DRIZ
PK. 1-:- 38

297 m

P1

VASKA

STACIN

P2

PLANIMETRIA E KANALIT UJITES
GALIGAT-CINGAR SIPER- DRIZ
PK. 1-:- 38

P2

P3

P4

P5

P6

PLANIMETRIA E KANALIT UJITES
GALIGAT-CINGAR SIPER- DRIZ
PK. 1-:- 38



PLANIMETRIA E KANALIT UJITES
GALIGAT-CINGAR SIPER- DRIZ
PK. 1-- 38 DHE PK.12 -- 12/3

P12

P12/2

P12/1

P12/3

BASEN PER FSHATIN

PLANIMETRIA E KANALIT UJITES
GALIGAT-CINGAR SIPER- DRIZ
PK. 1-:- 38

PLANIMETRIA E KANALIT UJITES
GALIGAT-CINGAR SIPER- DRIZ
PK. 1-:- 38

P10

P11

P12

PLANIMETRIA E KANALIT UJITES
GALIGAT-CINGAR SIPER- DRIZ
PK. 1-:- 38



PLANIMETRIA E KANALIT UJITES
GALIGAT-CINGAR SIPER- DRIZ
PK. 1-:- 38

TUACINIT TE STACIONIT NR 2NDI I TUB
QAFI E CINGARIT SIPER

TUBE I MBULUAR FI 300

P13

PRIZA

PLANIMETRIA E KANALIT UJITES
GALIGAT-CINGAR SIPER- DRIZ
PK. 1-:- 38



PLANIMETRIA E KANALIT UJITES
GALIGAT-CINGAR SIPER- DRIZ
PK. 1-:- 38

PRIZA

PRIZA

P14

P15

KANAL I HAPUR

P 22

P 21

P16

PLANIMETRIA E KANALIT UJITES
GALIGAT-CINGAR SIPER- DRIZ
PK. 1-:- 38

P 21

P16

P17

PRIZA

P18

P20

PRIZA

P19

TOMBINO

P 21

PLANIMETRIA E KANALIT UJITES
GALIGAT-CINGAR SIPER- DRIZ

PK. 1-- 38

P20 PRIZA
PRIZA

P19
TOMBINDO

P18

P17

P21

P22

P23

KANAL I HAPUR

510 m

NATASHA MYRTAJ
PROJEKTIM DREJTIM
KOLLAJIM

PLANIMETRIA E KANALIT UJITES
GALIGAT-CINGAR SIPER- DRIZ

PK. 1--:38

KANAL I HAPUR

P223

P224

P225

P226

P227

P228

510 m

PROJEKTIM DREJTIM
KO'LAU

Handwritten signature

PLANIMETRIA E KANALIT UJITES
GALIGAT-CINGAR SIPER- DRIZ

PK. 1 :- 38

KANAL I HAPUR

P30
P29

P28



PLANIMETRIA E KANALIT UJITES
GALIGAT-CINGAR SIPER- DRIZ
PK. 1--: 38

PLANIMETRIA E KANALIT UJITES
GALIGAT-CINGAR SIPER- DRIZ
PK. 1-: 38

P36
KANAL I HAPUR

P35

P34
483 m

KONTROL DRENTIM
KOLAUR
Handwritten signature

PLANIMETRIA E KANALIT UJITES
GALIGAT-CINGAR SIPER- DRIZ

PK. 1--38

468

471 m

PRIZA

PRIZA

P37

P36

NATASHA
PROJEKTIM I UJITIM
KOLLEKTIV

Handwritten signature





PLANIMETRIA E KANALIT UJITES
GALIGAT-CINGAR SIPER- DRIZ
PK. 14-:- 58

KANAL I HAPUR

P19

P18

P17

P16

P15

P14

TUACI
QAF A

PRIZA

PRIZA

PROJEKTIM PËRPUTIM
KOLAUDIM

Liby

PLANIMETRIA E KANALIT UJITES
GALIGAT-CINGAR SIPER- DRIZ

PK. 14:- 58

582

P21

P20

P19

KANAL I HAPUR

P18

P1

STASHA MYRTAJ
PROJEKTIM REJTIM
KO-AUDIM

PLANIMETRIA E KANALIT UJITES
GALIGAT-CINGAR SIPER- DRIZ

PK. 14-:- 58

P28

P27

KANAL I HAPUR

P26

P25

P24

P23

P22

P21

567 m

579 m

PROJEKTI I UJITES
KOLAUDIM

Handwritten signature

PLANIMETRIA E KANALIT UJITES
GALIGAT-CINGAR SIPER- DRIZ

PK. 14-- 58

P33

P32

P31

P30

P29

P28

P27 KANALIT HARIB

PROJEKTIM DREJTIM
KOLAUDIM

PLANIMETRIA E KANALIT UJITES
GALIGAT-CINGAR SIPER- DRIZ

PK. 14-:- 58

P37

P36

P35

P34

P33

D 2 2

570 m

576 m

573 m

585 m

Handwritten signature

PLANIMETRIA E KANALIT UJITES
GALIGAT-CINGAR SIPER- DRIZ
PK. 14-:- 58

576 m

585 m
70 m

P40

KANAL I HARUR

P39

P38

P37

PLANIMETRIA E KANALIT UJITES
GALIGAT-CINGAR SIPER- DRIZ
PK. 14-- 58

P42

P41

P40

579 m

PROJEKTI I NJERZEMAJ
PROJEKTI I NJERZEMAJ
KOLAUDIM

PLANIMETRIA E KANALIT UJITES
GALIGAT-CINGAR SIPER- DRIZ

PK. 14-:- 58



SHAH MYRTAJ
PROJEKTIN DREJTIM
KOJAUDIM
Cuba

PLANIMETRIA E KANALIT UJITES
GALIGAT-CINGAR SIPER- DRIZ
PK. 14-- 58



SHAN MYRTAJ
PROJEKTI PREJTIM
KOLAUDIM
Liby

PLANIMETRIA E KANALIT UJITES
GALIGAT-CINGAR SIPER- DRIZ
PK. 14-:- 58

546 m

P58

P57

P56

P55

516 m

RTAD
MILPRTIM
KOLAUDIM

PLANIMETRIA E KANALIT UJITES
GALIGAT-CINGAR SIPER- DRIZ
PK. 20-;- 35

P 24

KANAL I HAPUR

P 23

P 22

P 21

P17

PRIZA

P18

P20

PRIZA

P19

TOMBINO

IA NYRTAJ
KOLEKIM PREJTIM
KOLAUDIM

PLANIMETRIA E KANALIT UJITES
GALIGAT-CINGAR SIPER- DRIZ

PK. 20-:- 35

P 26

P 25

P 24

PROJEKTI I KANALITAJ
PROJEKTI I UJITES
KOLAUDIM

PLANIMETRIA E KANALIT UJITES
GALIGAT-CINGAR SIPER- DRIZ
PK. 20-:- 35



SH. MYRTAJ
PROJEKTIM DREJTIM
KOLAUDIN
Cabri

PLANIMETRIA E KANALIT UJITES
GALIGAT-CINGAR SIPER- DRIZ
PK. 20-;- 35

KANAL I HAPUR

P 28

P 27

PRIZA

PRIZA

LAUDIM
AUTIM

PLANIMETRIA E KANALIT UJITES
GALIGAT-CINGAR SIPER- DRIZ
PK. 20-:- 35

P 30

P 29

KANAL I HAPUR

P 28

MIRZADIM
Cipta

PLANIMETRIA E KANALIT UJITES
GALIGAT-CINGAR SIPER- DRIZ
PK. 20 :- 35

P 32

P 31

P 30

Luhy
KOLAUDIM
KOLAUDIM

P 33

PLANIMETRIA E KANALIT UJITES
GALIGAT-CINGAR SIPER- DRIZ
PK. 20-:- 35

KANAL I HAPUR

P 32

MURTAJ
OBJEKT
KOLAUDIM

PLANIMETRIA E KANALIT UJITES
GALIGAT-CINGAR SIPER- DRIZ
PK. 20-:- 35

P 35

P 34

P 33

PLANIMETRIA E KANALIT UJITES
GALIGAT-CINGAR SIPER- DRIZ
PK. 27 -:- 36



PROJEKTI
PROJEKTIM DREJTIM
KOLAUDIM

PLANIMETRIA E KANALIT UJITES
GALIGAT-CINGAR SIPER- DRIZ
PK. 27 -:- 36



RTAJ
BRTIM
KOLADIM

PLANIMETRIA E KANALIT UJITES
GALIGAT-CINGAR SIPER- DRIZ
PK. 27 -:- 36



Libri
OBJEKTI DREJTIM
KOLAUDIM

PLANIMETRIA E KANALIT UJITES
GALIGAT-CINGAR SIPER- DRIZ
PK. 27 -:- 36

08 m

405 m

402 m

P 36

P 35

IRFAN MURTAJA
KORPORASI
KOLAUDIM

PROFILAT GJATESOR I KANALIT UJITES GALIGAT-CINGAR SIPER- DRIZ PK. 1-:- 38

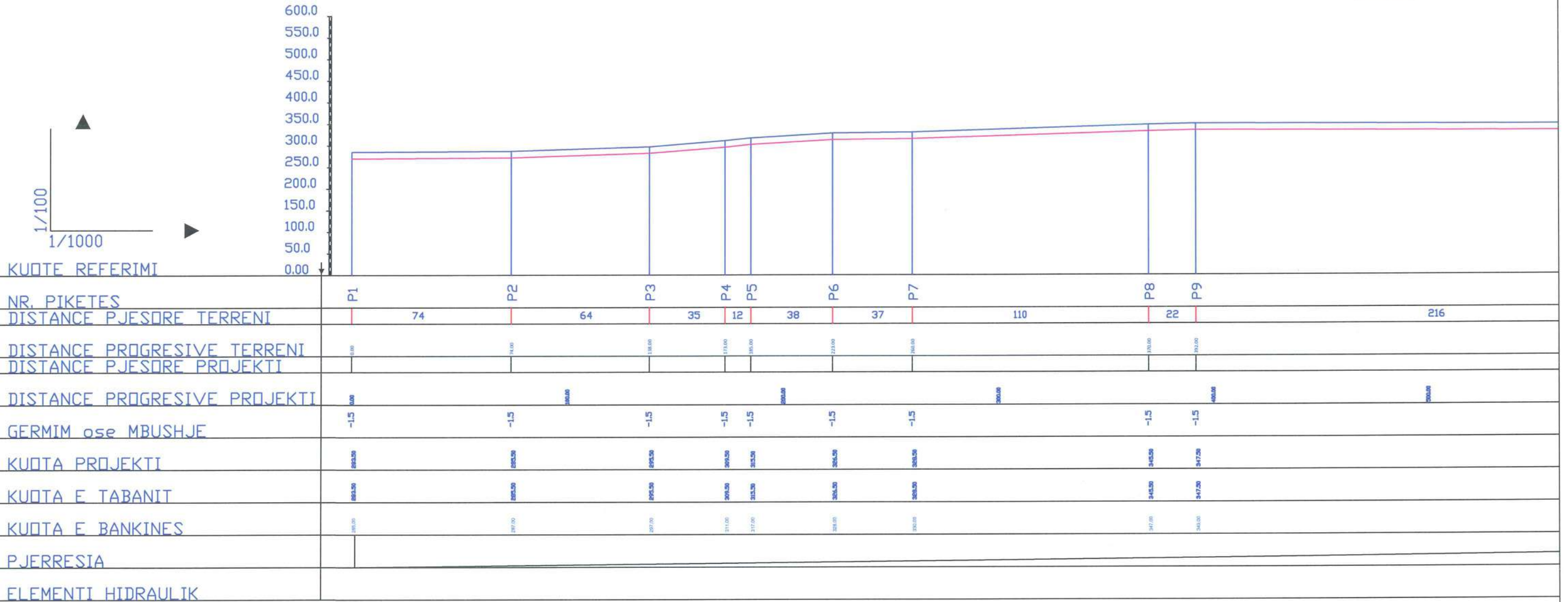

NATASHA KETKESH
 PROJEKTIM I KANALITIM
 KOLAUBIN
Auty

PROFILAT GJATESOR I KANALIT UJITES GALIGAT-CINGAR SIPER- DRIZ PK. 1-:- 38

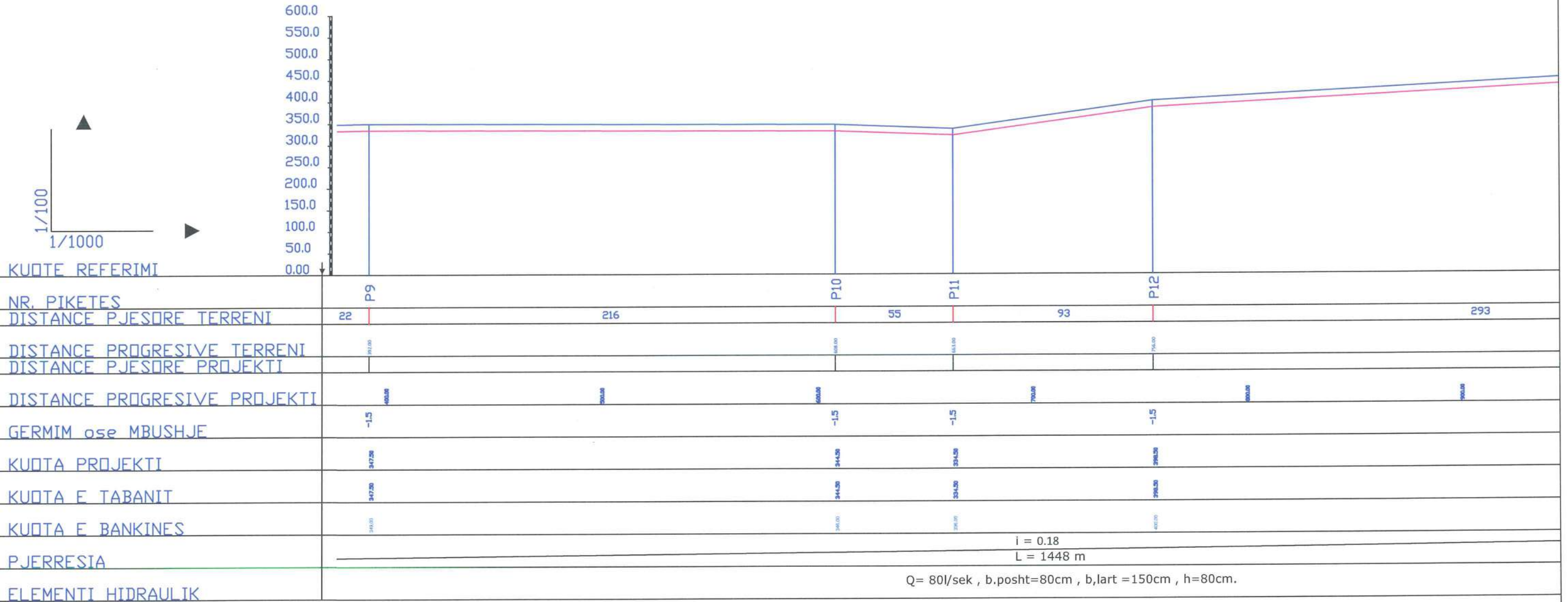

NATASHA MYRTAJ
 PROJEKTORE
 KOLAUDIM

PROFILAT GJATESOR I KANALIT UJITES GALIGAT-CINGAR SIPER- DRIZ PK. 1-:- 38

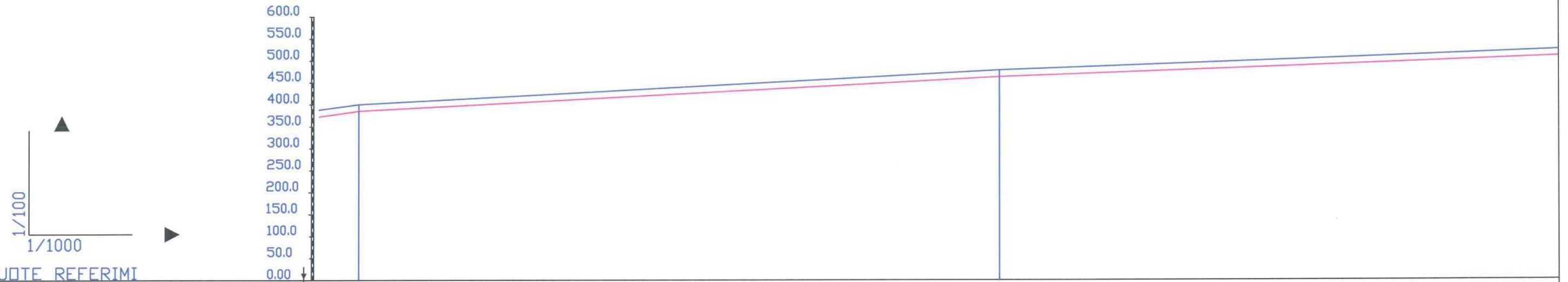

NR. PIKETES	P12	P13
DISTANCE PJESORE TERRENI	293	399
DISTANCE PROGRESIVE TERRENI	293.00	692.00
DISTANCE PJESORE PROJEKTI		
DISTANCE PROGRESIVE PROJEKTI	0.000	399.000
GERMIM ose MBUSHJE	-1.5	-1.5
KUOTA PROJEKTI	476.50	475.50
KUOTA E TABANIT	478.50	473.50
KUOTA E BANKINES	480.00	477.00
PJERRESIA		
ELEMENTI HIDRAULIK	: =150cm , h=80cm.	

NATASHA J. J. J.
 PROJEKTI I UJITIM
 KOLAUCI

PROFILAT GJATESOR I KANALIT UJITES GALIGAT-CINGAR SIPER- DRIZ

PK. 1-:- 38

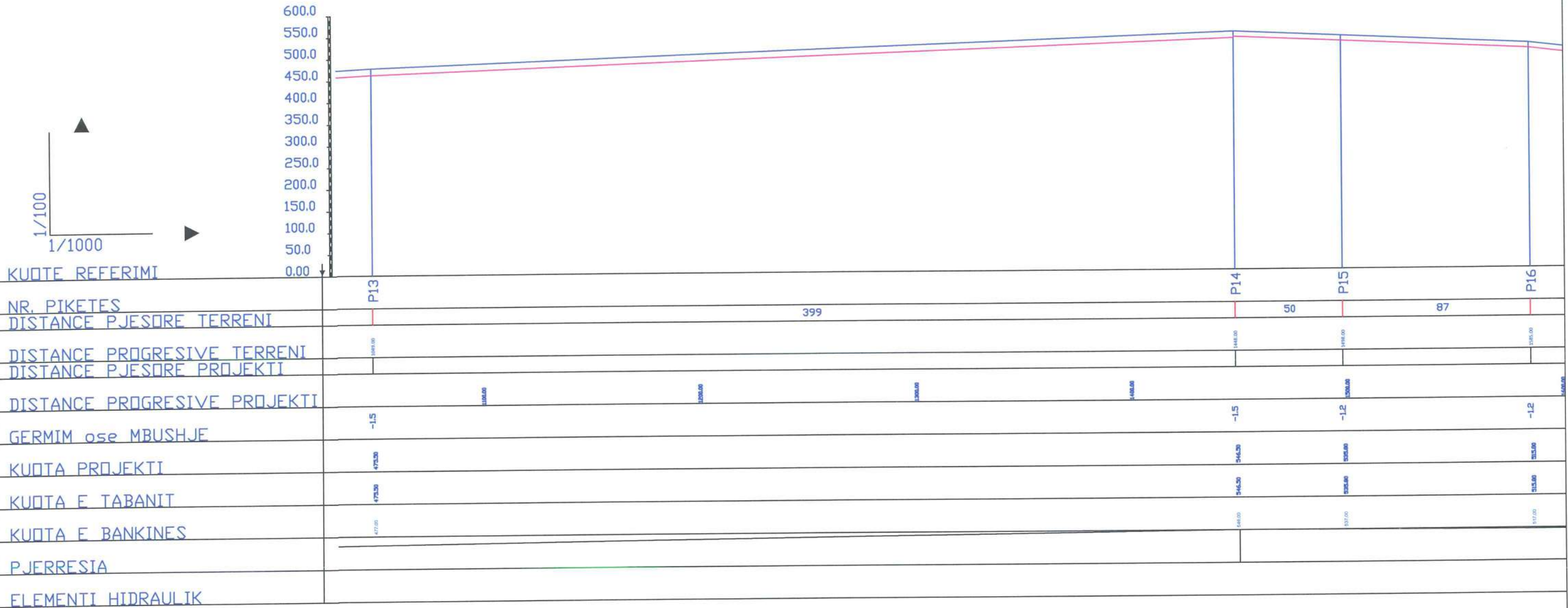

NATASHA HYRTAJ
PROJEKTIM DREJTIM
KOCAJ
Luca

PROFILAT GJATESOR I KANALIT UJITES GALIGAT-CINGAR SIPER- DRIZ PK. 1-:- 38

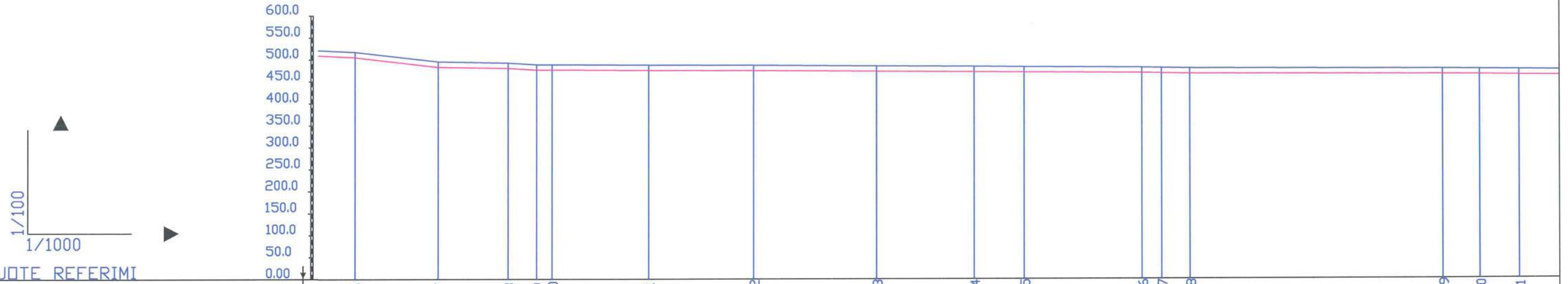
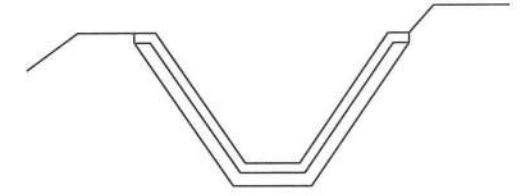

NR. PIKETES	P16	P17	P18	P19	P20	P21	P22	P23	P24	P25	P26	P27	P28	P29	P30	P31
DISTANCE PJESORE TERRENI	38	32	13	7	44	48	56	46	23	54	9	13	116	17	18	31
DISTANCE PROGRESIVE TERRENI	385.00	423.00	436.00	443.00	487.00	535.00	591.00	637.00	660.00	714.00	723.00	736.00	852.00	869.00	887.00	918.00
DISTANCE PJESORE PROJEKTI																
DISTANCE PROGRESIVE PROJEKTI	465.00	507.00	520.00	527.00	571.00	619.00	675.00	721.00	744.00	798.00	807.00	820.00	936.00	953.00	971.00	1002.00
GERMIM ose MBUSHJE	-1.2	-1.2	-1.2	-1.2	-1.2	-1.2	-1.2	-1.2	-1.2	-1.2	-1.2	-1.2	-1.2	-1.2	-1.2	-1.2
KUOTA PROJEKTI	483.00	481.00	475.00	476.00	474.00	465.00	461.00	455.00	452.00	445.00	443.00	442.00	437.00	436.00	435.00	432.00
KUOTA E TABANIT	483.00	483.00	483.00	483.00	483.00	483.00	483.00	483.00	483.00	483.00	483.00	483.00	483.00	483.00	483.00	483.00
KUOTA E BANKINES	487.00	487.00	487.00	487.00	487.00	487.00	487.00	487.00	487.00	487.00	487.00	487.00	487.00	487.00	487.00	487.00
PJERRESIA																
ELEMENTI HIDRAULIK																

NATASHA MYRTAJ
PROJEKTI
KOLAUDIM

PROFILAT GJATESOR I KANALIT UJITES

GALIGAT-CINGAR SIPER- DRIZ

PK. 1-:- 38

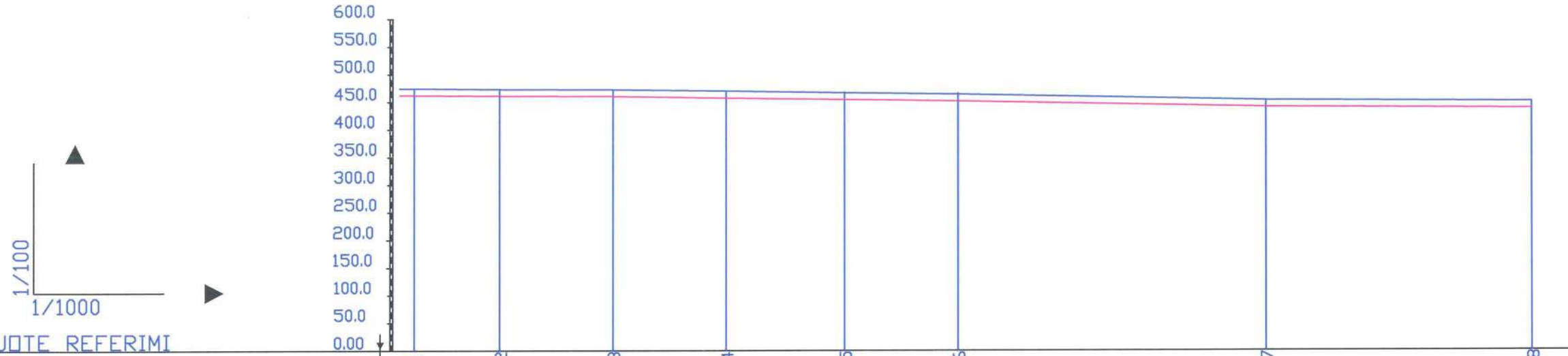
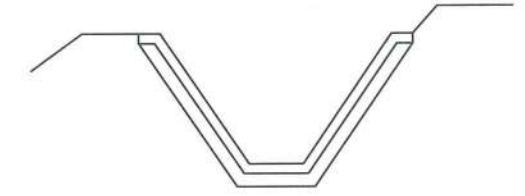

NR. PIKETES	P31	P32	P33	P34	P35	P36	P37	P38
DISTANCE PJESORE TERRENI	31	41	41	43	41	112	97	
DISTANCE PROGRESIVE TERRENI	319.00	350.00	391.00	434.00	475.00	587.00	684.00	781.00
DISTANCE PJESORE PROJEKTI								
DISTANCE PROGRESIVE PROJEKTI			200.00		200.00	200.00	200.00	200.00
GERMIM ose MBUSHJE	-1.2	-1.2	-1.2	-1.2	-1.2	-1.2	-1.2	-1.2
KUOTA PROJEKTI	476.7000	471.00	470.00	467.00	463.00	463.00	450.00	447.00
KUOTA E TABANIT	475.5000	471.00	471.00	467.00	463.00	463.00	450.00	447.00
KUOTA E BANKINES	474.00	471.00	470.00	468.00	465.00	463.00	450.00	448.00
PJERRESIA								
ELEMENTI HIDRAULIK								

NATASHA MYRTAJ
 PROJEKTI-REJTIM
 KO LAUDIM

PROFILAT GJATESOR I KANALIT UJITES GALIGAT-CINGAR SIPER- DRIZ PK. 14-:- 58

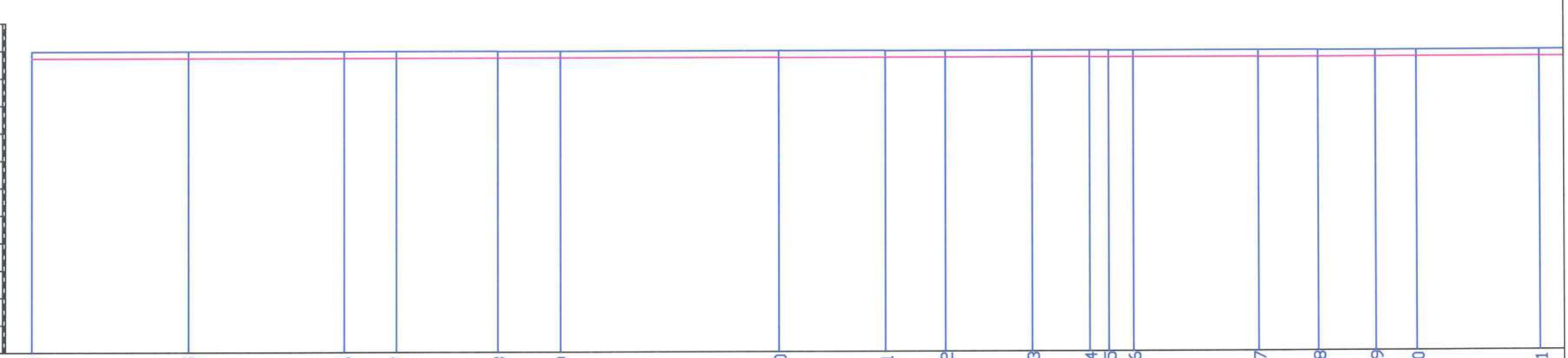
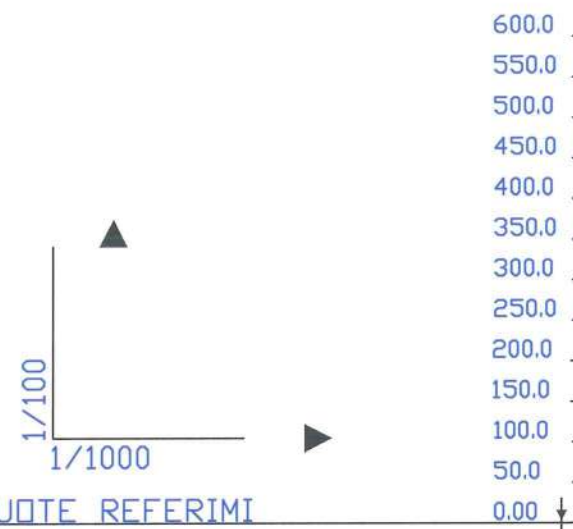
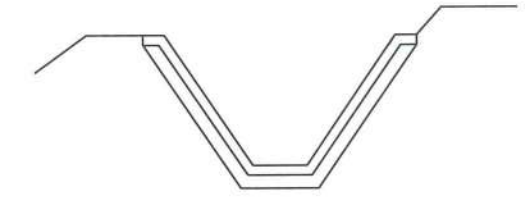

NR. PIKETES	P14	P15	P16	P17	P18	P19	P20	P21	P22	P23	P24	P25	P26	P27	P28	P29	P30	P31
DISTANCE PJESORE TERRENI		57	41	19	37	23	80	39	22	32	21	7	9	46	22	21	15	45
DISTANCE PROGRESIVE TERRENI	0.00	57.00	98.00	117.00	154.00	177.00	257.00	296.00	318.00	350.00	371.00	378.00	387.00	433.00	455.00	476.00	491.00	536.00
DISTANCE PJESORE PROJEKTI																		
DISTANCE PROGRESIVE PROJEKTI	0.00	300.00	300.00	300.00	300.00	300.00	300.00	300.00	300.00	300.00	300.00	300.00	300.00	300.00	300.00	300.00	300.00	300.00
GERMIM ose MBUSHJE	-1.2	-1.2	-1.2	-1.2	-1.2	-1.2	-1.2	-1.2	-1.2	-1.2	-1.2	-1.2	-1.2	-1.2	-1.2	-1.2	-1.2	-1.2
KUOTA PROJEKTI	546.00	546.09	546.28	546.47	546.26	546.25	546.13	546.02	545.91	545.80	545.69	545.58	545.47	545.36	545.24	545.13	545.02	544.91
KUOTA E TABANIT	546.00	546.09	546.28	546.47	546.26	546.25	546.13	546.02	545.91	545.80	545.69	545.58	545.47	545.36	545.24	545.13	545.02	544.91
KUOTA E BANKINES	546.00	547.39	547.78	548.17	547.56	547.44	547.23	547.22	547.11	547.00	546.89	546.78	546.67	546.56	546.44	546.33	546.22	546.11
PJERRESIA																		
ELEMENTI HIDRAULIK																		

NATA
PROJEKTI
Cupis

PROFILAT GJATESOR I KANALIT UJITES GALIGAT-CINGAR SIPER- DRIZ PK. 14:- 58

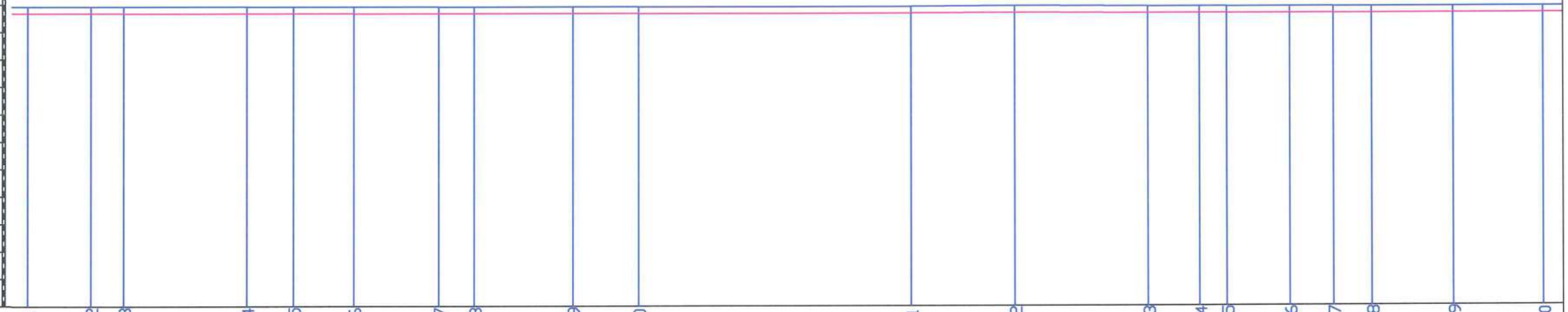
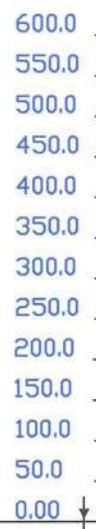
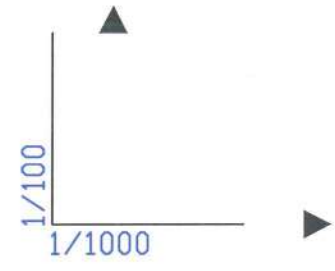
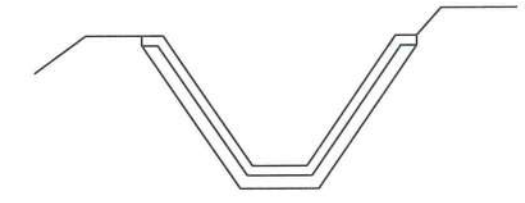

NR. PIKETES	P31	P32	P33	P34	P35	P36	P37	P38	P39	P40	P41	P42	P43	P44	P45	P46	P47	P48	P49	P50		
DISTANCE PJESORE TERRENI		23	12	45	19	22	31	13	36	24	100	38	49	19	10	23	16	14	30	33	12	
DISTANCE PROGRESIVE TERRENI	336.00	359.00	371.00	416.00	435.00	457.00	488.00	501.00	537.00	561.00	661.00	699.00	748.00	767.00	777.00	800.00	816.00	830.00	860.00	893.00	926.00	938.00
DISTANCE PJESORE PROJEKTI																						
DISTANCE PROGRESIVE PROJEKTI			0.00				70.00				90.00		90.00			100.00						100.00
GERMIM ose MBUSHJE	-1.2	-1.2	-1.2	-1.2	-1.2	-1.2	-1.2	-1.2	-1.2	-1.2	-1.2	-1.2	-1.2	-1.2	-1.2	-1.2	-1.2	-1.2	-1.2	-1.2	-1.2	
KUOTA PROJEKTI	544.91	544.80	544.69	544.38	544.17	544.36	544.24	544.14	544.02	543.91	543.80	543.69	543.58	543.47	543.36	543.24	543.13	543.02	542.91	542.80	542.80	542.80
KUOTA E TABANIT	544.91	544.80	544.69	544.38	544.17	544.36	544.24	544.14	544.02	543.91	543.80	543.69	543.58	543.47	543.36	543.24	543.13	543.02	542.91	542.80	542.80	542.80
KUOTA E BANKINES	545.11	545.00	544.89	544.58	544.37	544.56	544.44	544.33	544.22	544.11	544.00	543.89	543.77	543.66	543.55	543.44	543.33	543.22	543.11	543.00	542.89	542.80
PJERRESIA	$i = 0.0038$ $L = 1261 \text{ m}$																					
ELEMENTI HIDRAULIK	$Q = 80 \text{ l/sek}$, $b.\text{posht} = 80 \text{ cm}$, $b.\text{lart} = 150 \text{ cm}$, $h = 80 \text{ cm}$.																					

NATASHA MYRTAZI
PROJEKTORE
Cur

PROFILAT GJATESOR I KANALIT UJITES GALIGAT-CINGAR SIPER- DRIZ PK. 14-:- 58

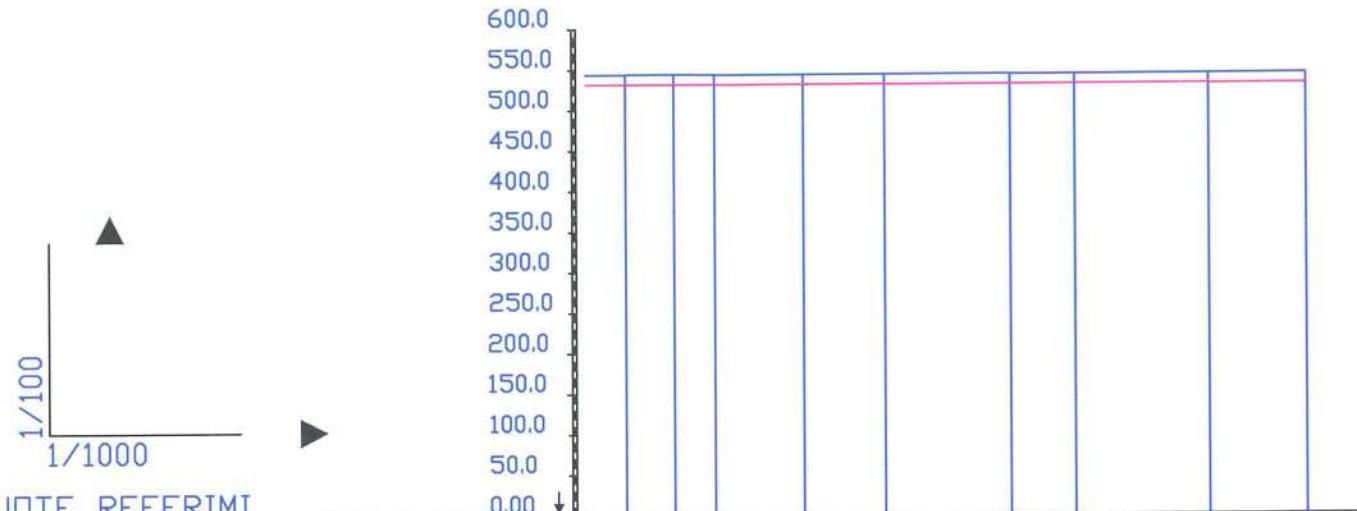
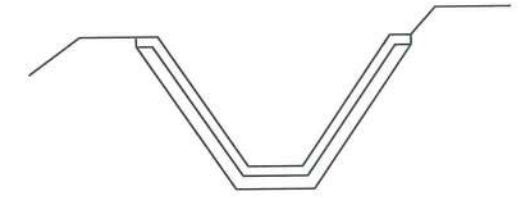

KUOTE REFERIMI

NR. PIKETES	P50	P51	P52	P53	P54	P55	P56	P57	P58
DISTANCE PJESORE TERRENI	12	10	22	20	31	16	33	24	
DISTANCE PROGRESIVE TERRENI	1073.00	1083.00	1105.00	1127.00	1157.00	1173.00	1206.00	1230.00	1254.00
DISTANCE PJESORE PROJEKTI									
DISTANCE PROGRESIVE PROJEKTI	1081.00					1097.00			1109.00
GERMIM ose MBUSHJE	-1.2	-1.2	-1.2	-1.2	-1.2	-1.2	-1.2	-1.2	-1.2
KUOTA PROJEKTI	542.80	542.69	542.28	542.47	542.26	542.24	542.13	542.22	541.91
KUOTA E TABANIT	542.00	542.69	542.28	542.47	542.26	542.24	542.13	542.22	541.91
KUOTA E BANKINES	544.00	543.89	543.78	543.67	543.56	543.45	543.34	543.22	543.11
PJERRESIA									
ELEMENTI HIDRAULIK									

NATASHA MYRTAJ
 PROJEKTI MEZGJITIM
 KO LAUDIM

PROFILAT GJATESOR I KANALIT UJITES

GALIGAT-CINGAR SIPER- DRIZ

PK. 20 -:- 35

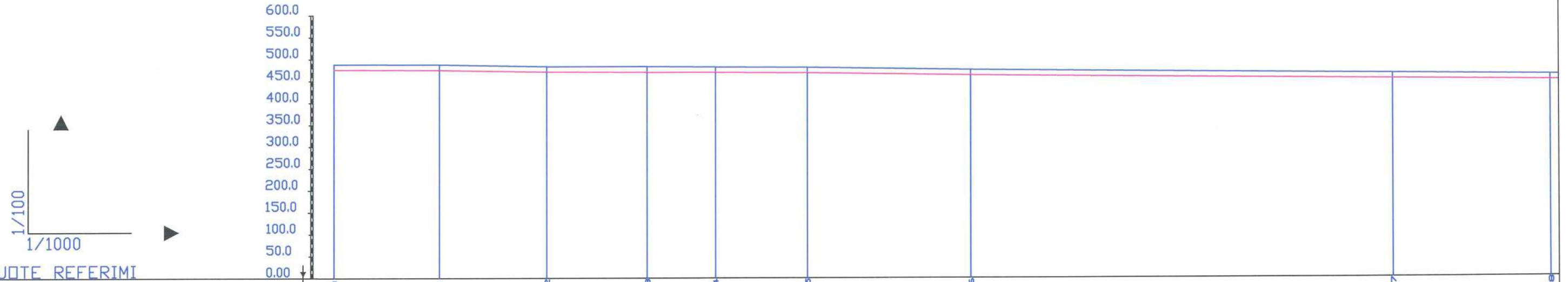
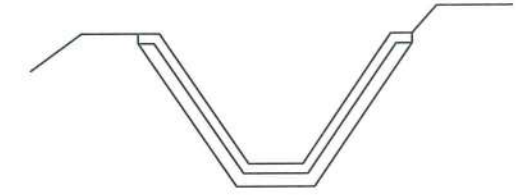

KUDTE REFERIMI	P20	P21	P22	P23	P24	P25	P26	P27	P28
NR. PIKETES									
DISTANCE PJESORE TERRENI	48	49	46	33	42	72	154	72	
DISTANCE PROGRESIVE TERRENI	0.00	48.00	97.00	143.00	176.00	218.00	290.00	362.00	434.00
DISTANCE PJESORE PROJEKTI									
DISTANCE PROGRESIVE PROJEKTI	0.00	48.00	97.00	143.00	176.00	218.00	290.00	362.00	434.00
GERMIM ose MBUSHJE	-1.00	-1.00	-1.00	-1.00	-1.00	-1.00	-1.00	-1.00	-1.00
KUOTA PROJEKTI	450.00	450.00	450.00	450.00	450.00	450.00	450.00	450.00	450.00
KUOTA E TABANIT	450.00	450.00	450.00	450.00	450.00	450.00	450.00	450.00	450.00
KUOTA E BANKINES	450.00	450.00	450.00	450.00	450.00	450.00	450.00	450.00	450.00
PJERRESIA									
ELEMENTI HIDRAULIK									

i = 0.057
L = 1025m

Q= 80l/sek , b.posht=80cm , b,l

NATASHA NYSTAJ
PROJEKTI M. NYSTAJ
KOLAUDIM

PROFILAT GJATESOR I KANALIT UJITES GALIGAT-CINGAR SIPER- DRIZ PK. 20 -:- 35

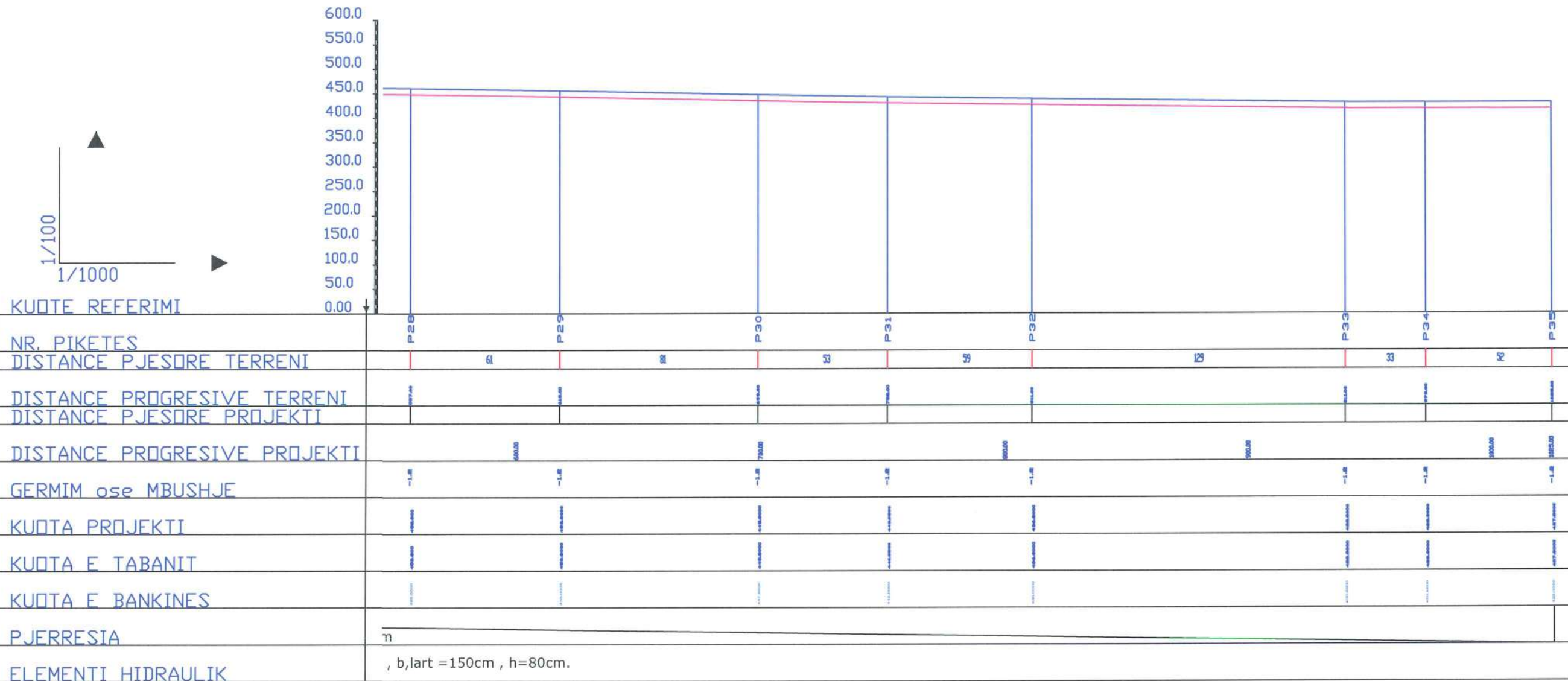
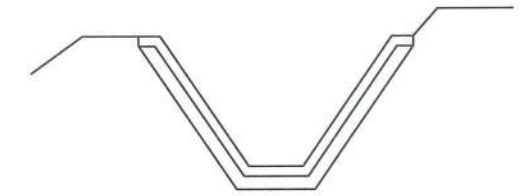

NATASHA MYRTAJ
 PROJEKTIM
 KOVALEVA

PROFILAT GJATESOR I KANALIT UJITES GALIGAT-CINGAR SIPER- DRIZ PK. 27 -:- 36

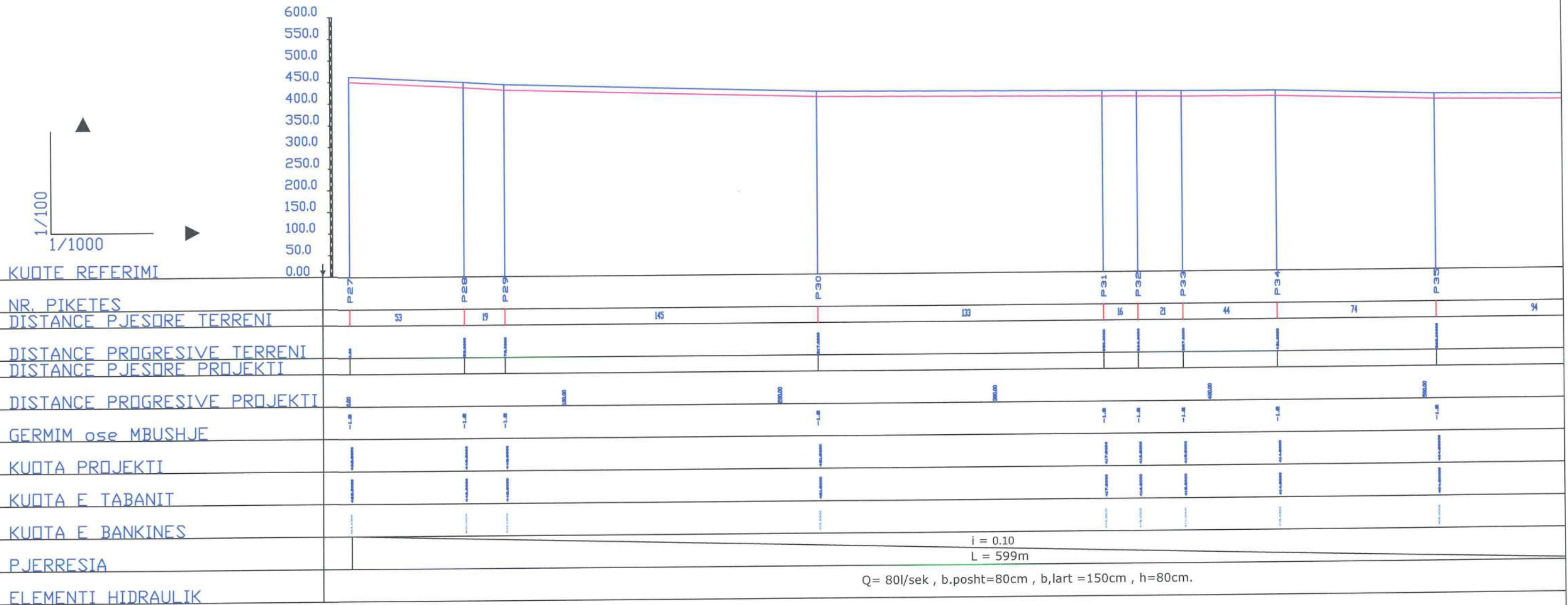

NATASHA MYRTAJ
 PROJEKTIM DREJTIM
 KOLAUDIM

PROFILAT GJATESOR I KANALIT UJITES GALIGAT-CINGAR SIPER- DRIZ PK. 27 -:- 36

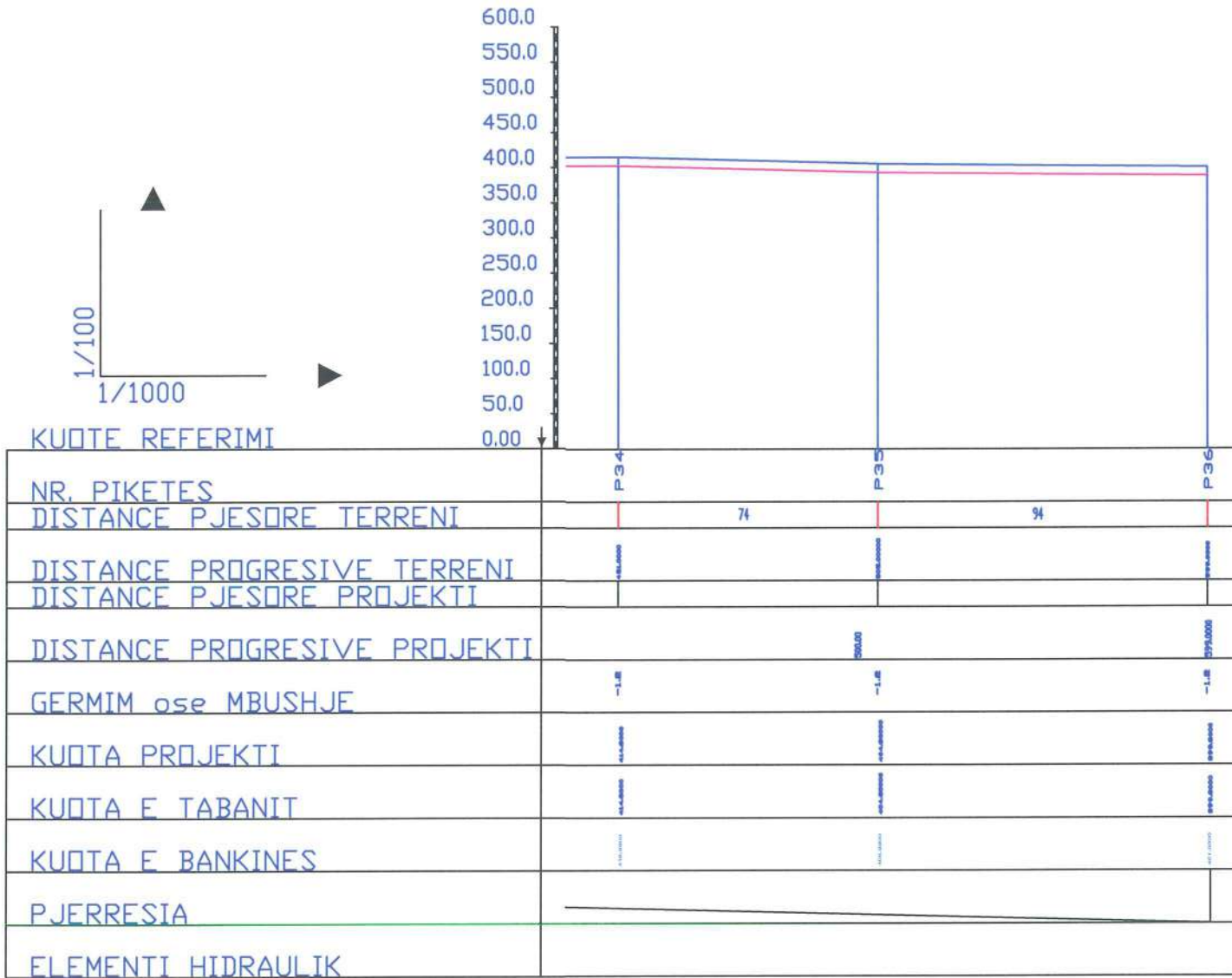

NATASHA MERTAJ
 PROJEKTI
 KOLAUDIM

PROFILAT TERTHORE TE KANALIT
VEPRA E MARJE DERI NE QAFEN E CINGARIT
PK. 1-:- 38

Pk. 1



Pk. 5



Pk. 9



Pk. 13

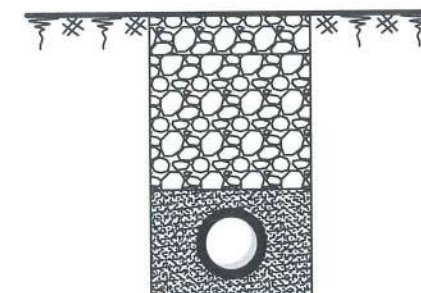

Pk. 2



Pk. 6

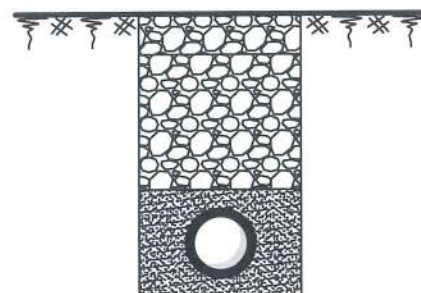

Pk. 10



Pk. 14

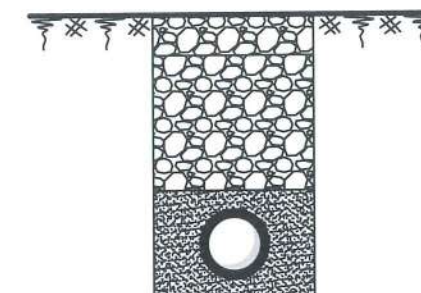

Pk. 3



Pk. 7



Pk. 11

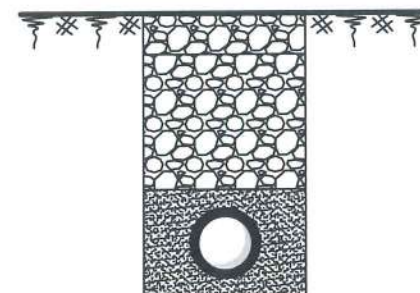

Pk. 4



Pk. 8



Pk. 12

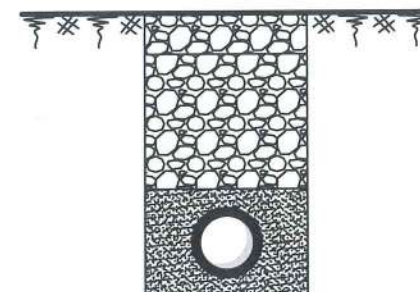

NATASHA MYRTAJ
PROJEKTIN NEJTIM
KONALDIM

PROFILAT TERTHORE TE KANALIT NGA QAFJA E
CINGARIT - DRIZ PK. 1-:- 38

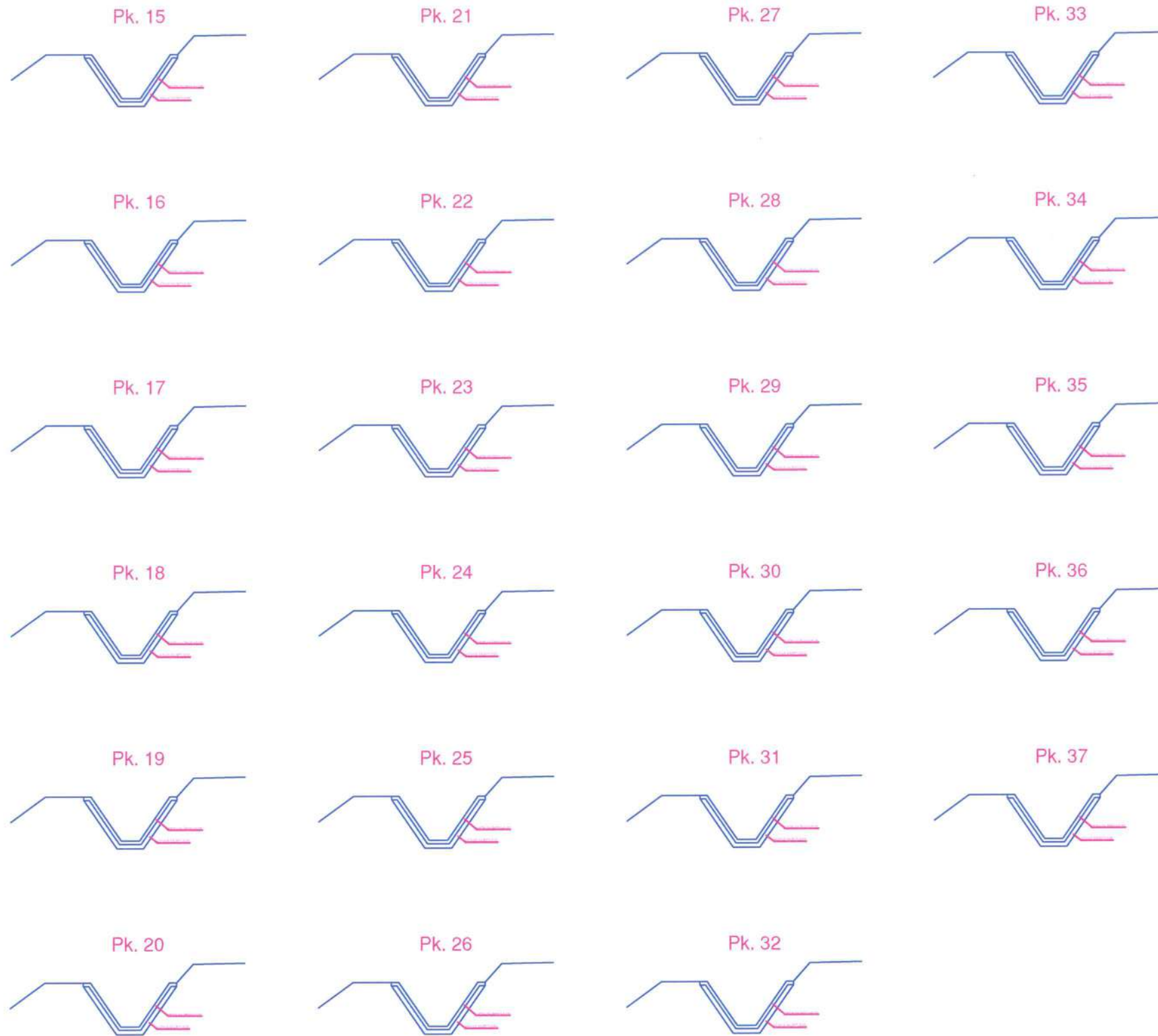

NATASYA
PROJEKTI
KO
Cup

PROFILAT TERTHORE TE KANALIT NGA QAFA E
CINGARIT - LAGJEN E SIPERME PK. 15:- 58

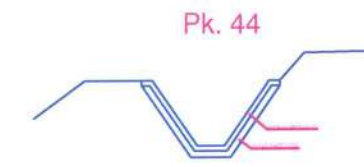
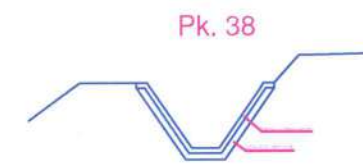
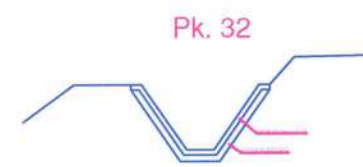
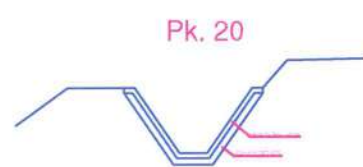
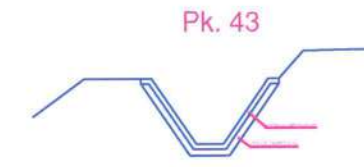
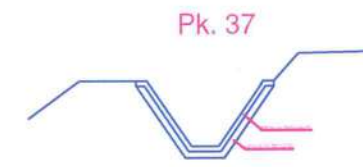
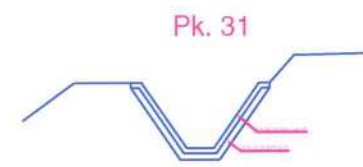
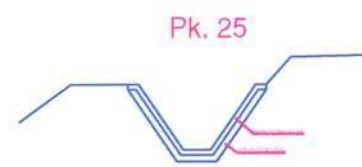
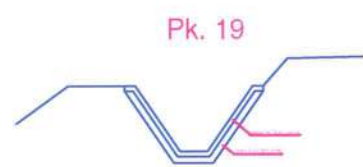
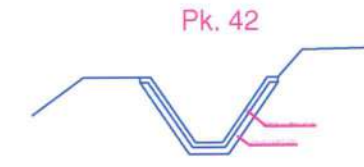
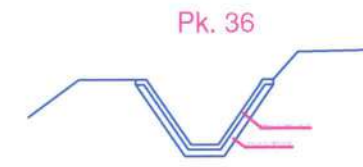
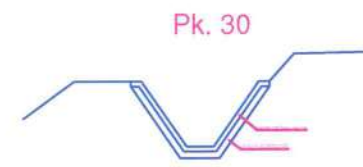
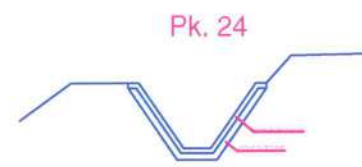
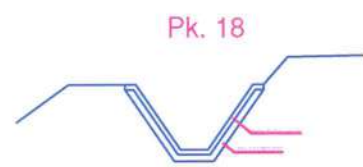
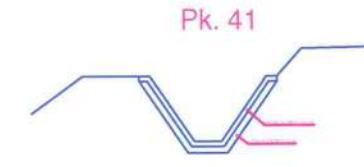
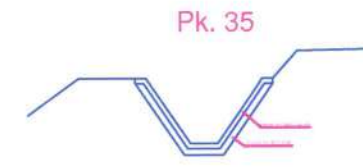
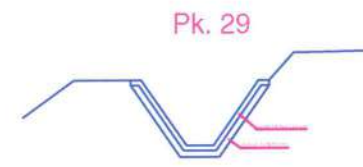
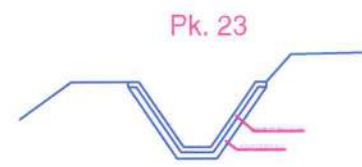
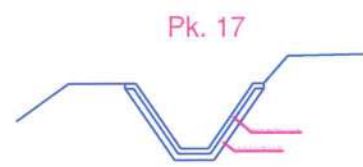
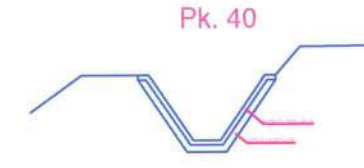
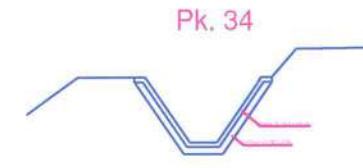
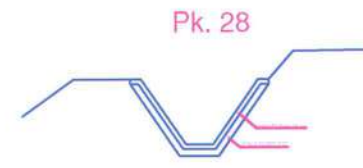
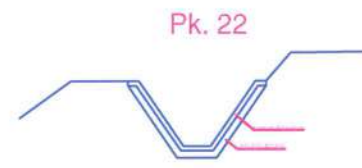
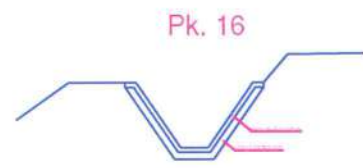
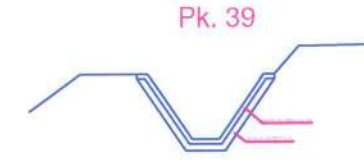
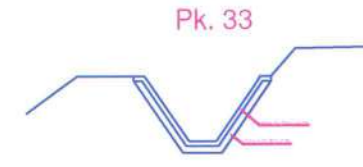
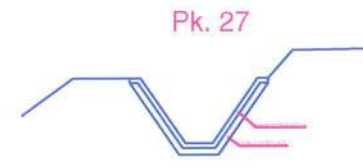
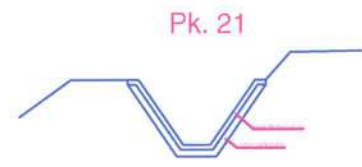
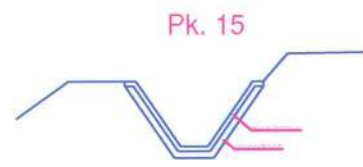

NATASIA NYSTAN
PROJEKTI I CINGARIT
KOLAUN

PROFILAT TERTHORE TE KANALIT NGA QAFJA E
CINGARIT - LAGJEN E SIPERME PK. 15 :- 58

Pk. 45



Pk. 51

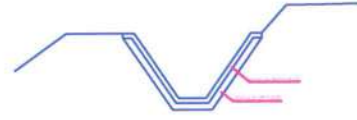

Pk. 57



Pk. 46



Pk. 52



Pk. 58



Pk. 47



Pk. 53



Pk. 48



Pk. 54



Pk. 49



Pk. 55



Pk. 50



Pk. 56

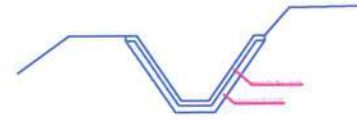

NATASHA MARTINI
PROJEKTI I KANALIT
KOLAON

PROFILAT TERTHORE TE KANALIT NGA QAFJA E
CINGARIT - DRIZ PK. 20 -:- 35

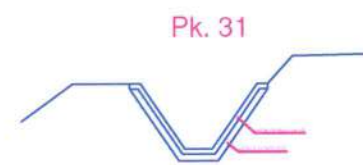
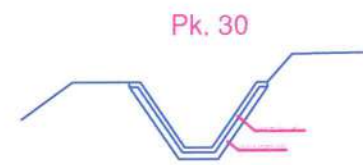
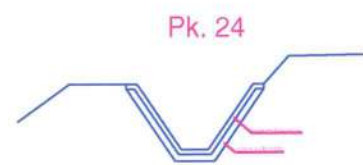
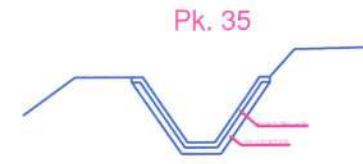
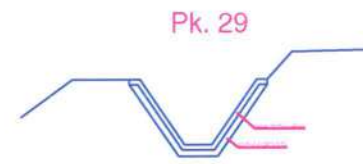
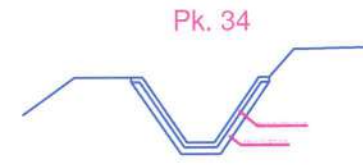
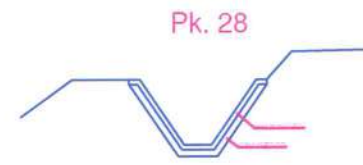
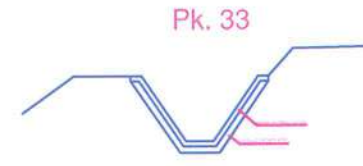
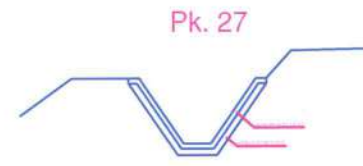
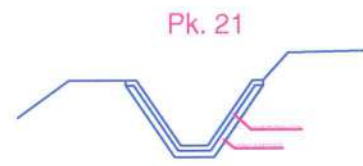
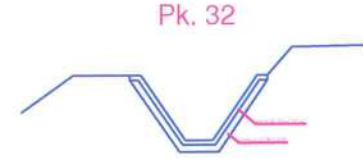
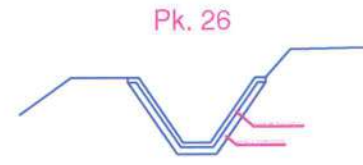
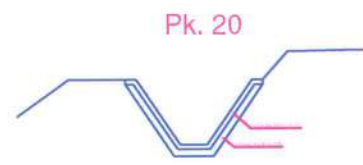

NATISHA NYRTAJ
PROJEKTI
KUROR

PROFILAT TERTHORE TE KANALIT NGA QAFA E
CINGARIT - DRIZ PK. 27 -:- 36



Natasha
NATASHA METAJ
PROJEKTIM DREJTIM
KOLAUDIM

PROFILAT GJATESOR I KANALIT UJITES GALIGAT-CINGAR SIPER- DRIZ PK. 12 -:- 12/3

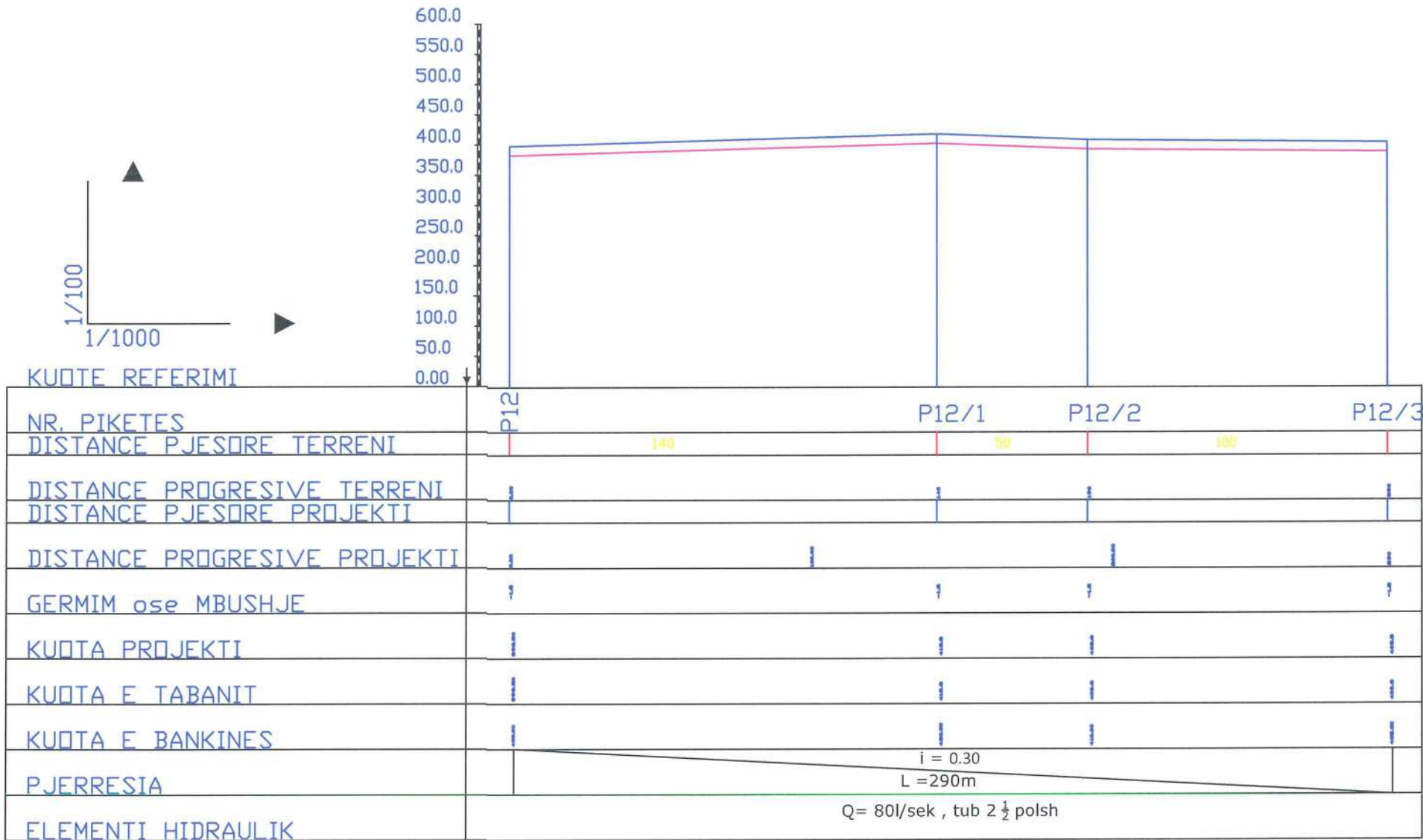

NATAHA NYRDA I
 PROJEKTI
 KOTALLI
Anty