



BASHKIA DURRES

OBJEKTI:
RIKONSTRUKSION SHKOLLA 9 VJECARE "JUSUF PUKA"
"BASHKIA DURRËS"

DURRES, PRILL 2019
NJESIA E PROEJTIT DHE INFRASTRUKTURES



 NJESIA E PROJEKTIT DHE INFRASTRUKTURES	OBJEKTI :RIKONSTRUKSION SHKOLLA 9 VJECARE "JUSUF PUKA"		
	VENDODHJA : DURRES, DURRES	EMER MBIEMER	FIRMA
	PROJEKTI : ARKITEKTURA	Ark. Adnand TOÇILA	Ark. Oltjon GRUÇKA
	FAZA E PROJEKTIT : PROJEKT ZBATIMI	Ing. Diana DEDJA	Ing.elek. Mariglen JAHOLLARI
	EMERTIMI I FLETES : FOTO GJENDJA EKZISTUESE	DATA 04/2019	SHKALLA
	Nr. I FLETES	A1	

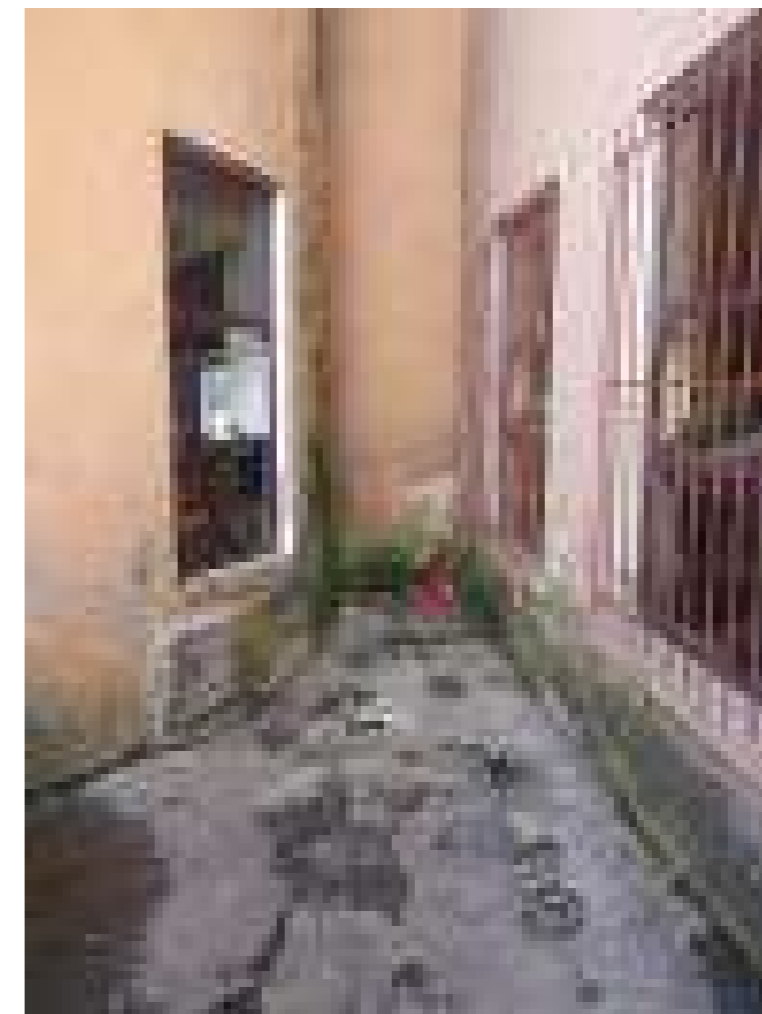
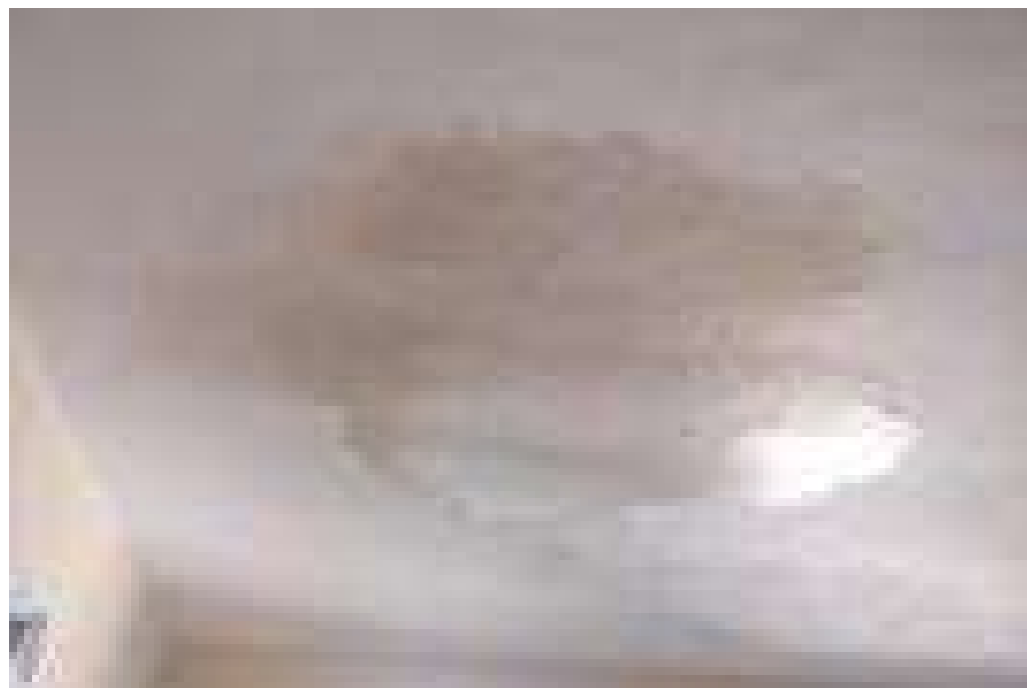

 NJESIA E PROJEKTIT DHE INFRASTRUKTURES	OBJEKTI :RIKONSTRUKSION SHKOLLA 9 VJECARE "JUSUF PUKA"		
	VENDODHJA : DURRES, DURRES	EMER MBIEMER Ark. Adnand TOÇILA	FIRMA
	PROJEKTI : ARKITEKTURA	Ark. Oltjon GRUÇKA	
	FAZAE PROJEKTIT : PROJEKT ZBATIMI	Ing. Diana DEDJA	Ing.elek. Mariglen JAHOLLARI
	EMERTIMI I FLETES : FOTO GJENDJA EKZISTUESE		
	DATA 04/2019	SHKALLA	
	Nr. I FLETES		A12

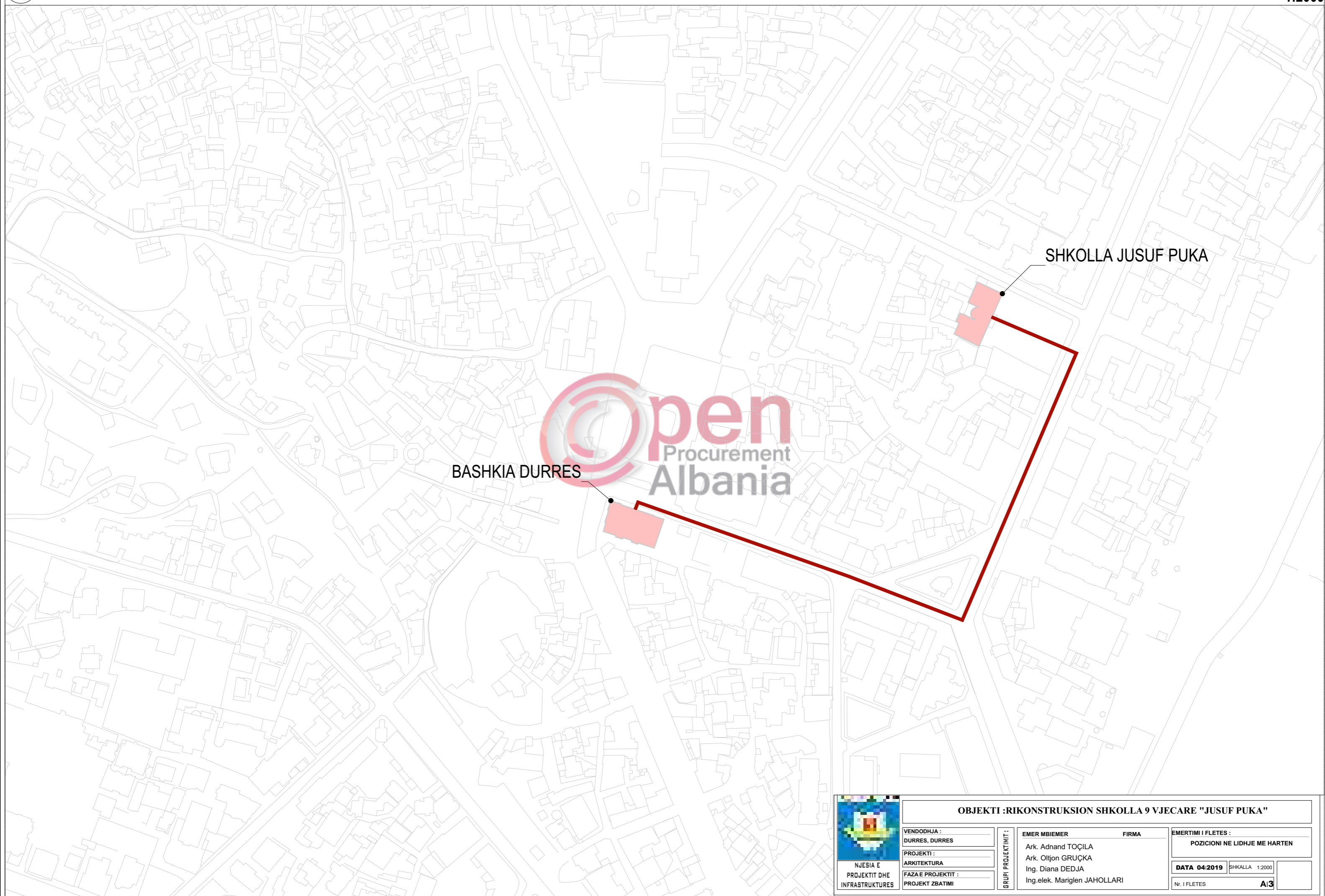

NJESIA E
PROJEKTIT DHE
INFRASTRUKTURES

OBJEKTI :RIKONSTRUKSION SHKOLLA 9 VJECARE "JUSUF PUKA"

VENDODHJA :
DURRES, DURRES
PROJEKTI :
ARKITEKTURA
FAZA E PROJEKTIT :
PROJEKT ZBATIMI

GRUPI PROJEKTIMIT :

EMER MBIEMER
Ark. Adnan TOÇILA
Ark. Oltjon GRUÇKA
Ing. Diana DEDJA
Ing.elek. Mariglen JAHOLLARI

FIRMA

EMERTIMI I FLETES :
POZICIONI NE LIDHJE ME HARTEN

DATA 04/2019 SHKALLA 1:2000
Nr. I FLETES A13

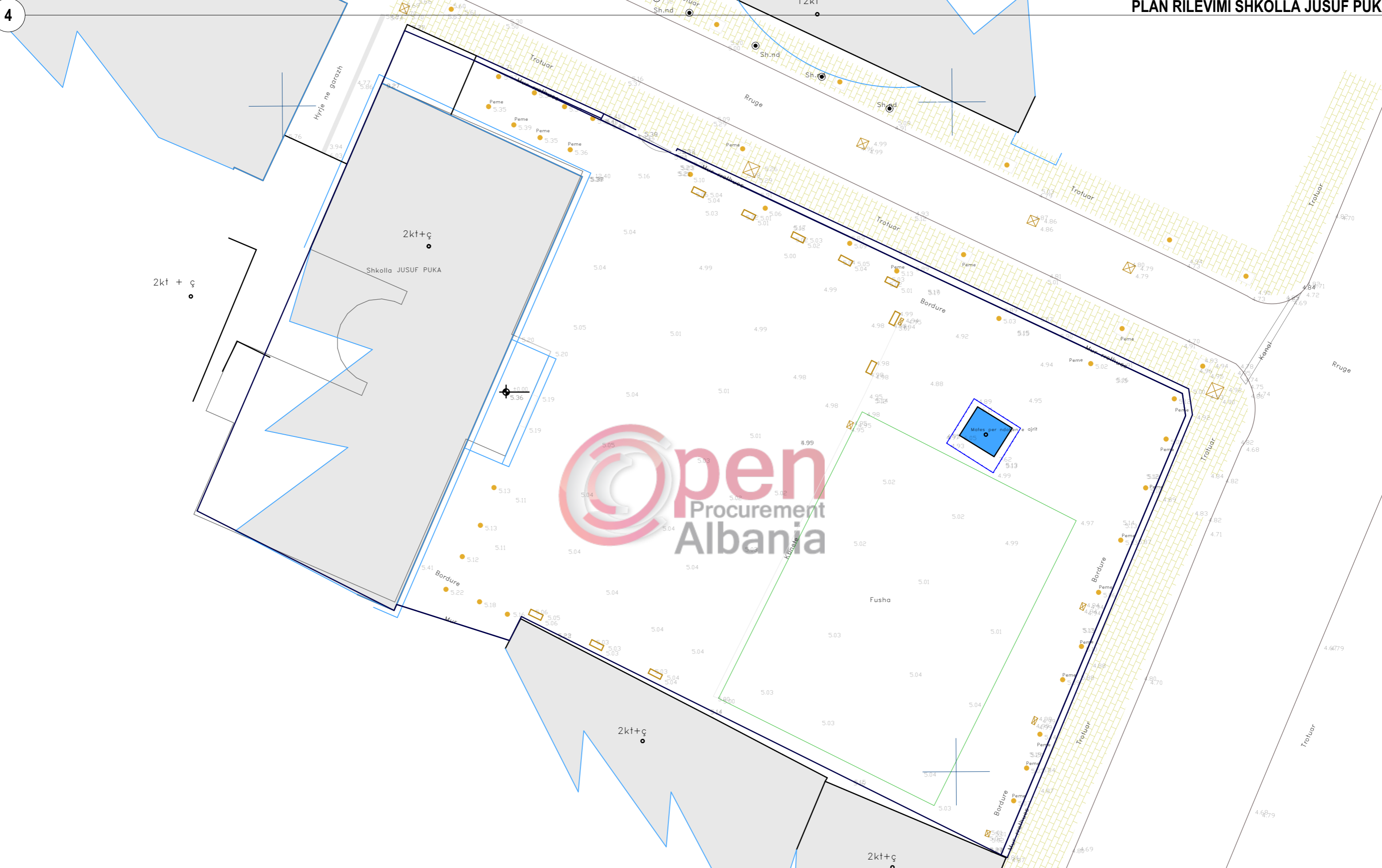

OBJEKTI :RIKONSTRUKSION SHKOLLA 9 VJECARE "JUSUF PUKA"		
VENDODHJA DURRES, DURRES	EMER MBIEMER	FIRMA
PROJEKTI : ARKITECTURA	Ark. Adnand TOÇILA	Ark. Oltjon GRUÇKA
FAZA E PROJEKTIT : PROJEKT ZBATIMI	Ing. Diana DEDJA	Ing.elek. Marigjen JAHOLLARI
EMERTIMI I FLETES : PLAN RILEVIMI SHKOLLA JUSUF PUKA		
DATA 04/2019	SHKALLA	
Nr. I FLETES	A/4	

OBJEKTI QE SHTOHET

70 m²

OBJEKTI EKZISTUES

537 m²

SHKOLLA JUSUF PUKA

OBJEKTI QE SHTOHET

OBJEKTI EKZISTUES

BASHKIA DURRES

SHKOLLA JUSUF PUKA TREGUESIT E ZHVILLIMIT

SIPËRFAQJA E KATIT PERDHE SHKOLLA 607 m² (SIPËRFAQJA QE ESHTË SHTUAR 70 m²)SIPËRFAQJA E KATIT PARE SHKOLLA 607 m² (SIPËRFAQJA QE ESHTË SHTUAR 70 m²)

SHKOLLA NUMERI I KATEVE MBI TOKE 2KT

SIPËRFAQJA E SHESHIT TE NDERTIMIT 2567 m²SIPËRFAQJA E SHEHIT E ZENE NGA STRUKTURA 607 m² (SIPËRFAQJA QE ESHTË SHTUAR 70 m²)SIPËRFAQJA TOTALE E NDËRTIMIT 1214 m² (SIPËRFAQJA E NDËRTIMIT QE ESHTË SHTUAR 140 m²)

KOEFIICIENTI I SHFRYTEZIMIT 22.3 %

H_{max} 9.99 mNJESIA E
PROJEKTIT DHE
INFRASTRUKTURES

OBJEKTI :RIKONSTRUKSION SHKOLLA 9 VJECARE "JUSUF PUKA"			
VENDODHJA : DURRES, DURRES	EMER MBIEMER Ark. Adnand TOÇILA	FIRMA	EMERTIMI I FLETES : PLAN VENDOSJE E ZHVILLIMIT
PROJEKTI : ARKITEKTURA	Ark. Oltjon GRUÇKA		DATA 04/2019 SHKALLA
FAZA E PROJEKTIT : PROJEKT ZBATIMI	Ing. Diana DEDJA		Nr. I FLETES
GRUPI PROJEKTIMIT :	Ing.elek. Marigjen JAHOLLARI		A15

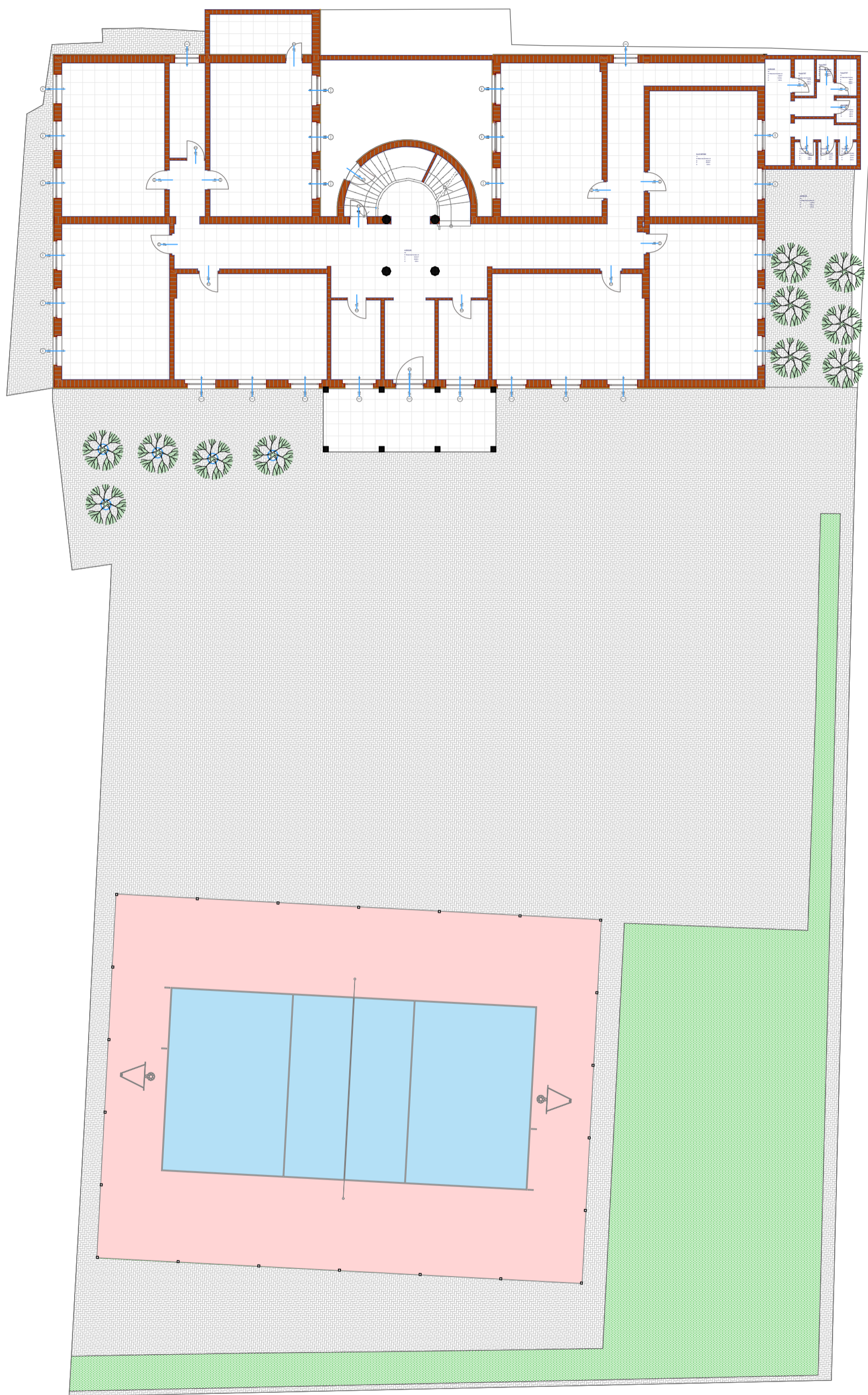

NJESIA E
PROJEKTIIT DHE
INFRASTRUKTURES

OBJEKTI :RIKONSTRUKSION SHKOLLA 9 VJECARE "JUSUF PUKA"

VENDODHJA :
DURRES, DURRES

PROJEKTI :
ARKITEKTURA

FAZA E PROJEKTIIT :
PROJEKT ZBATIMI

GRUPI PROJEKTIIT :

EMER MBIEMER

Ark. Adnand TOÇILA

Ark. Oltjon GRUÇKA

Ing. Diana DEDJA

Ing.elek. Mariglen JAHOLLARI

FIRMA

EMERTIMI I FLETES :

PLANI VENDOSJE GJENDJA EKZISTUESE

DATA 04/2019 SHKALLA 1:200

Nr. I FLETES

A16

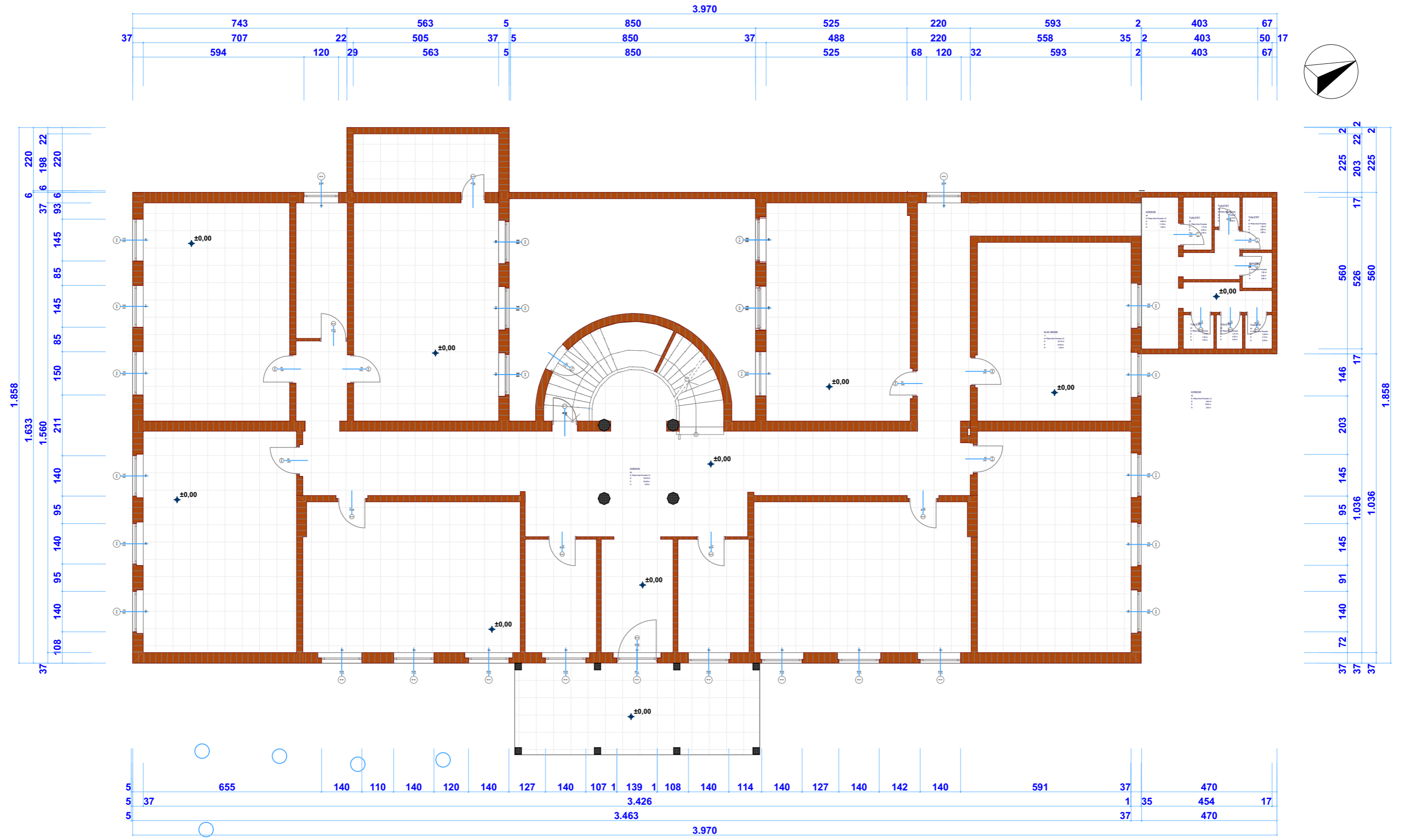

 NJESIA E PROJEKTIT DHE INFRASTRUKTURES	OBJEKTI :RIKONSTRUKSION SHKOLLA 9 VJECARE "JUSUF PUKA"		EMERTIMI I FLETES : PLANI I KATI PERDHE GJENDJA EKZISTUESE		
	VENDODHJA : DURRES, DURRES	EMER MBIEMER Ark. Adnand TOÇILA	FIRMA Ark. Oltjon GRUÇKA	DATA 04/2019 SHKALLA 1:125	
	PROJEKTI : ARKITEKTURA	GRUPI PROJEKTIMIT : Ing. Diana DEDJA		Nr. I FLETES A17	
	FAZA E PROJEKTIT : PROJEKT ZBATIMI	Ing.elek. Mariglen JAHOLLARI			

3.499																
	742	2	563	92	681	83	525	218	595	2						
37	705	22	505	37	92	28	625	28	83	37	488	218	595	2		
	595	120	563	4	88		681		83		525	70	120	28	595	2

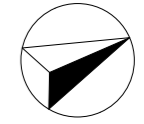

225
203
22
37
93
145
85
145
85
150
211
150
85
150
85
150
99
37
1.633
1.858

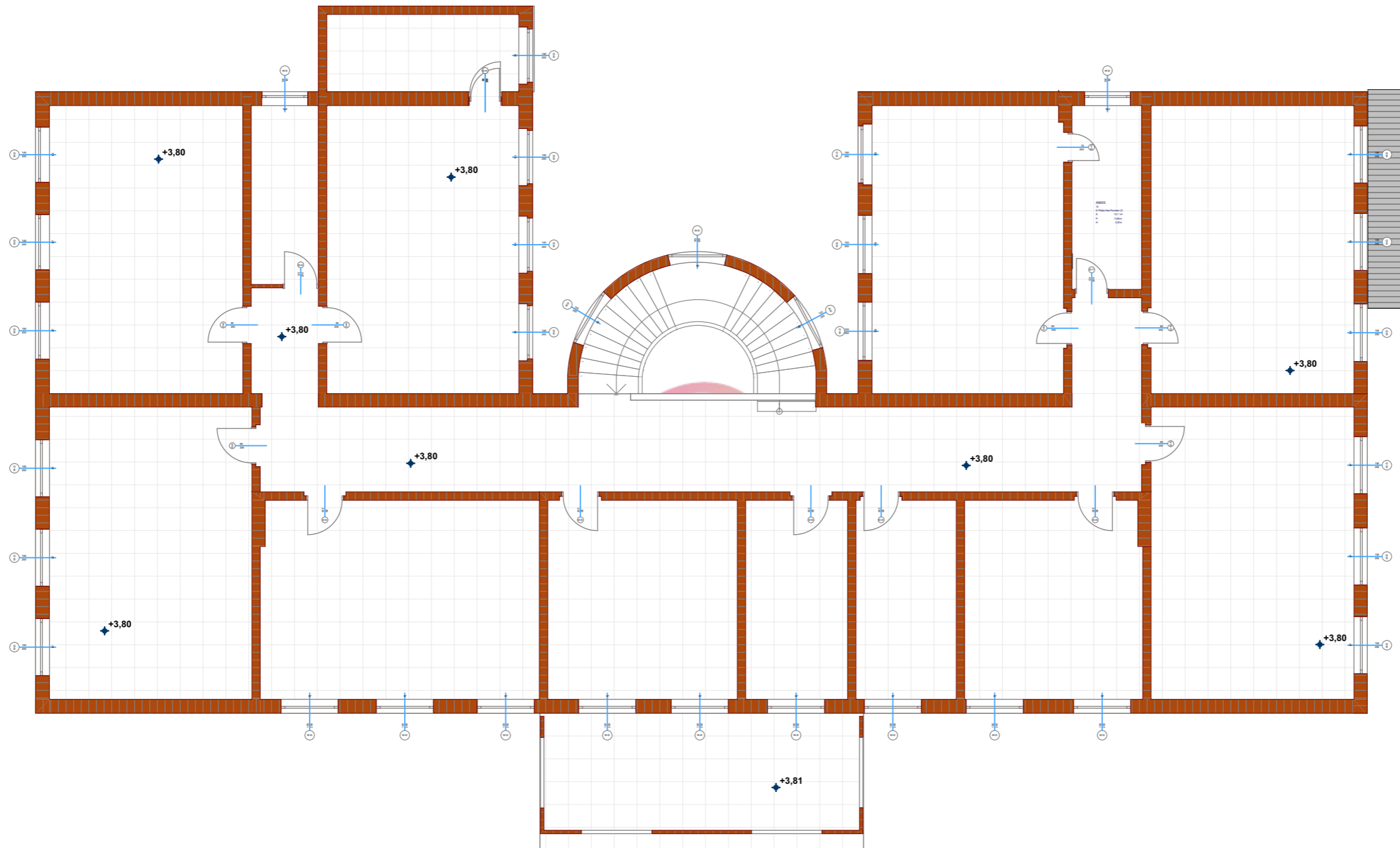

2
22
22
60
140
25
140
37
54
37
203
22
2
37
150
85
153
75
153
75
153
88
113
150
90
150
83
150
803
840
37
1.858

5	645	150	100	150	115	150	117	150	93	150	103	150	104	150	118	150	132	150	623	37	
5	37									3.426											37
5										3.500											
										3.500											

 NJESIA E PROJEKTIT DHE INFRASTRUKTURES	OBJEKTI :RIKONSTRUKSION SHKOLLA 9 VJECARE "JUSUF PUKA"		EMERTIMI I FLETES : PLANI I KATI PARE GJENDJA EKZISTUESE		
	VENDODHJA : DURRES, DURRES	EMER MBIEMER Ark. Adnand TOÇILA	FIRMA	DATA 04/2019 SHKALLA 1:125	
	PROJEKTI : ARKITEKTURA	GRUPI PROJEKTIMIT : Ark. Oltjon GRUÇKA Ing. Diana DEDJA	Nr. I FLETES	A18	
	FAZA E PROJEKTIT : PROJEKT ZBATIMI	Ing.elek. Mariglen JAHOLLARI			

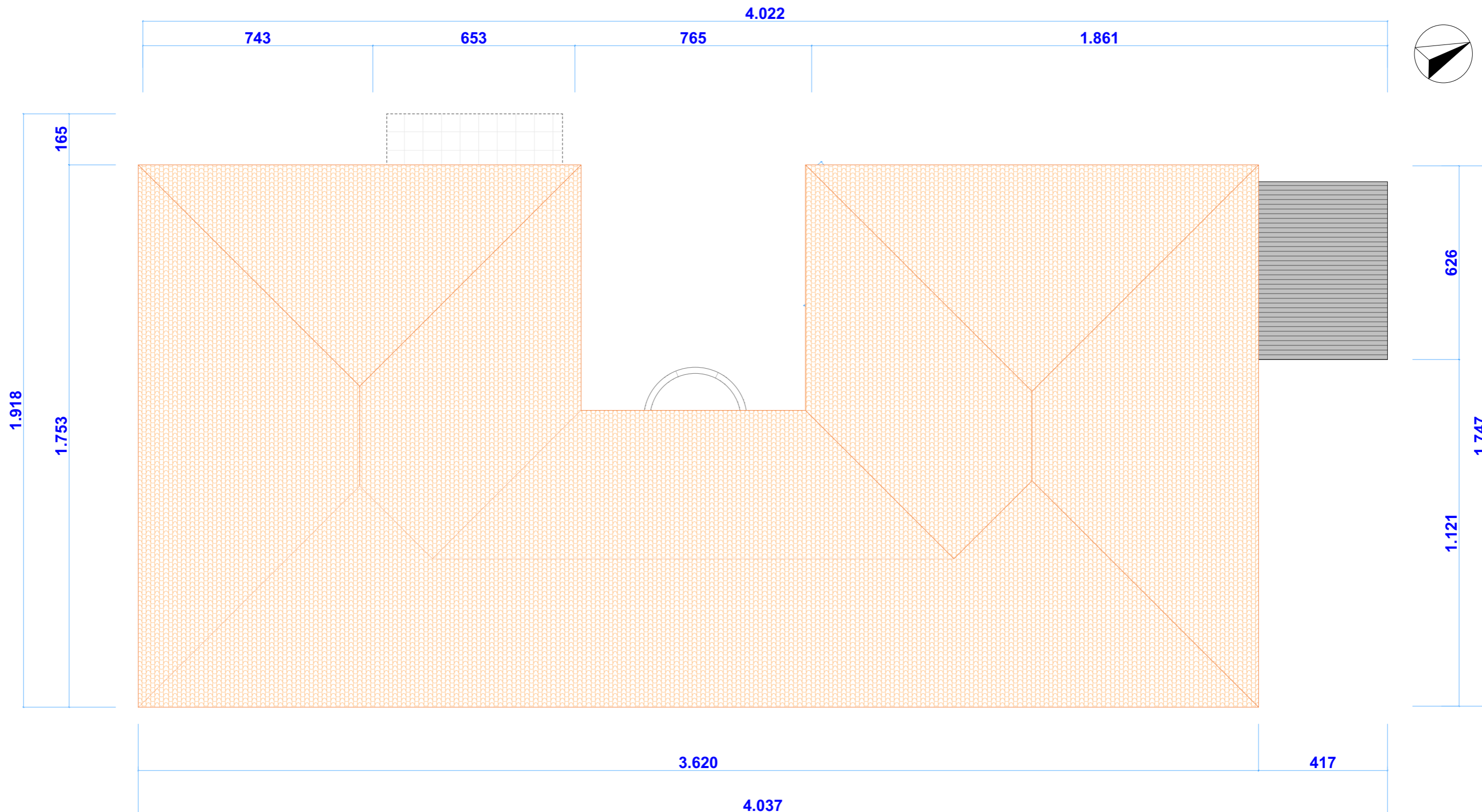

 NJESIA E PROJEKTTIT DHE INFRASTRUKTURES	OBJEKTI :RIKONSTRUKSION SHKOLLA 9 VJECARE "JUSUF PUKA"		
	VENDODHJA : DURRES, DURRES	EMER MBIEMER Ark. Adnand TOÇILA Ark. Oltjon GRUÇKA Ing. Diana DEDJA Ing.elek. Mariglen JAHOLLARI	FIRMA
	PROJEKTI : ARKITEKTURA	GRUPI PROJEKTIMIT :	EMERTIMI I FLETES : PLANI I CATISE GJENDJA EKZISTUESE
	FAZA E PROJEKTTIT : PROJEKT ZBATIMI	DATA 04/2019 SHKALLA 1:125 Nr. I FLETES A19	

10

FASADA JUGORE GJENDJA EKZISTUESE
1:200

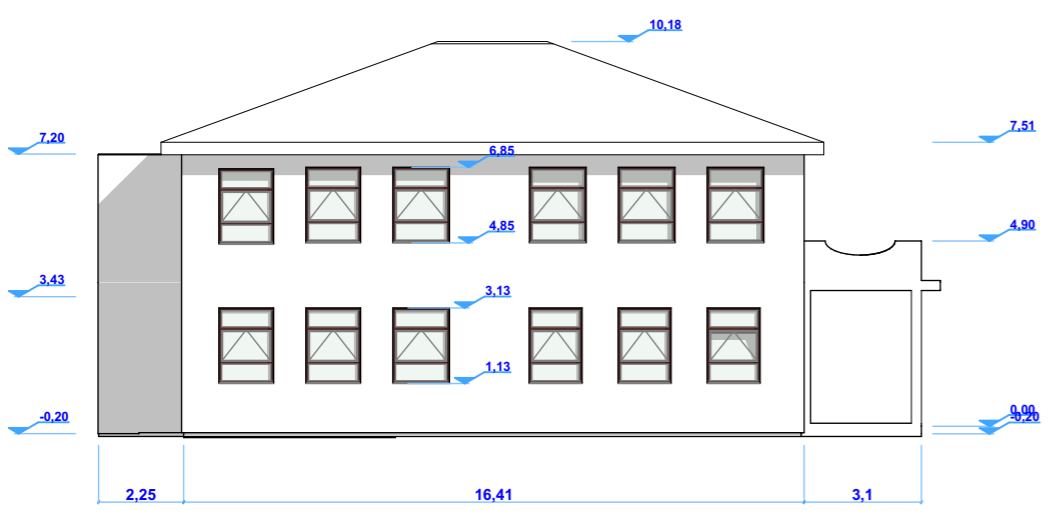

10

FASADA LINDORE GJENDJA EKZISTUESE
1:200

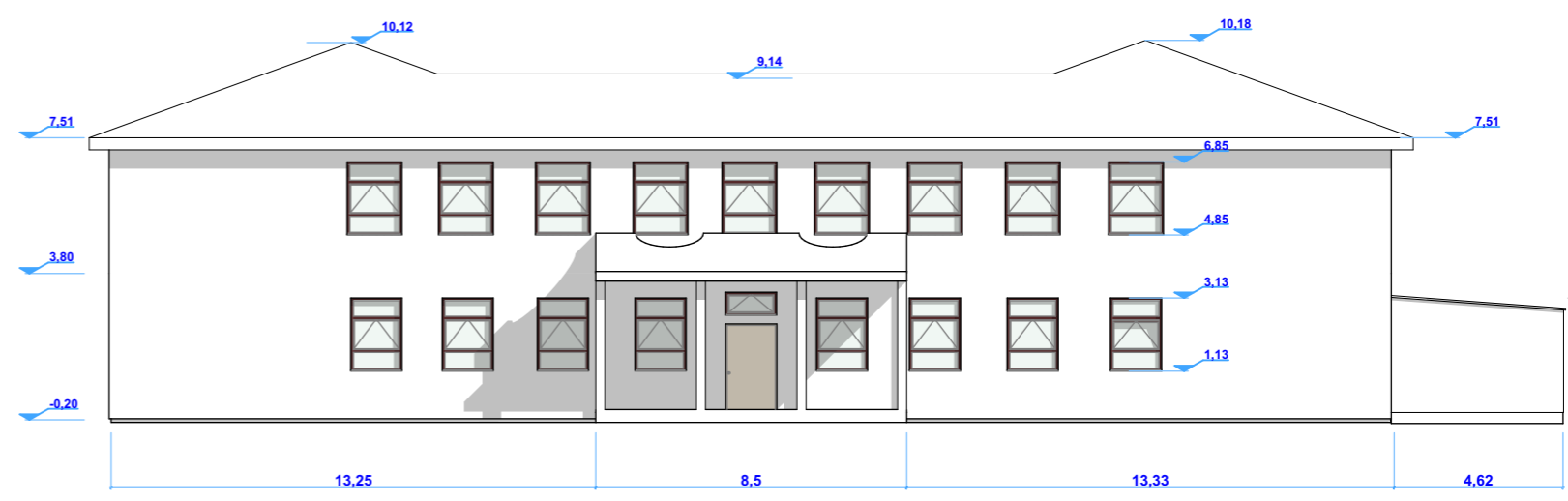

10

FASADA VERIORE GJENDJA EKZISTUESE
1:200

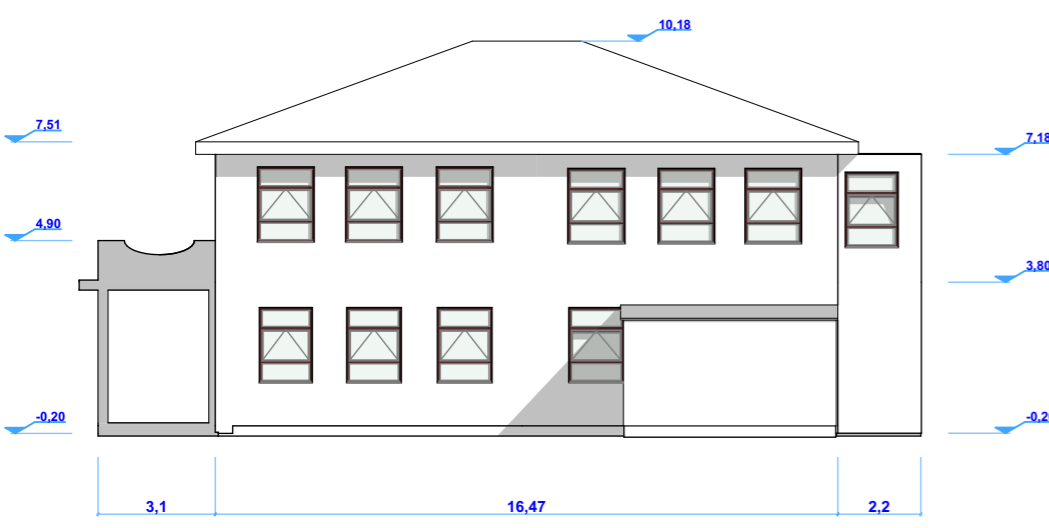

10

FASADA PERENDIMORE GJENDJA EKZISTUESE
1:200

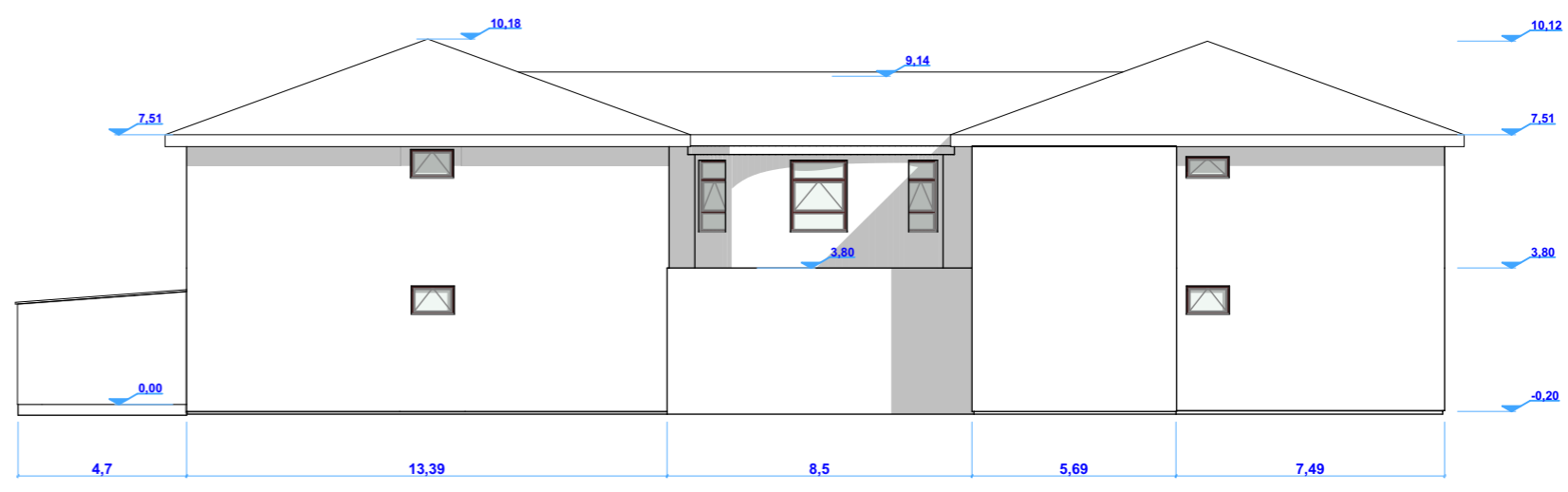

OBJEKTI :RIKONSTRUKSION SHKOLLA 9 VJECARE "JUSUF PUKA"				
 NJESIA E PROJEKTIT DHE INFRASTRUKTURES	VENDODHJA : DURRES, DURRES	GRUPI PROJEKTIMIT : EMER MBIEMER Ark. Adnand TOÇILA Ark. Oltjon GRUÇKA Ing. Diana DEDJA Ing.elek. Mariglen JAHOLLARI	EMERTIMI I FLETES : FASADA GJENDJA EKZISTUESE	
	PROJEKTI : ARKITEKTURA		FIRMA	DATA 04/2019 SHKALLA 1:200
	FAZA E PROJEKTIT : PROJEKT ZBATIMI			Nr. I FLETES
				A 10

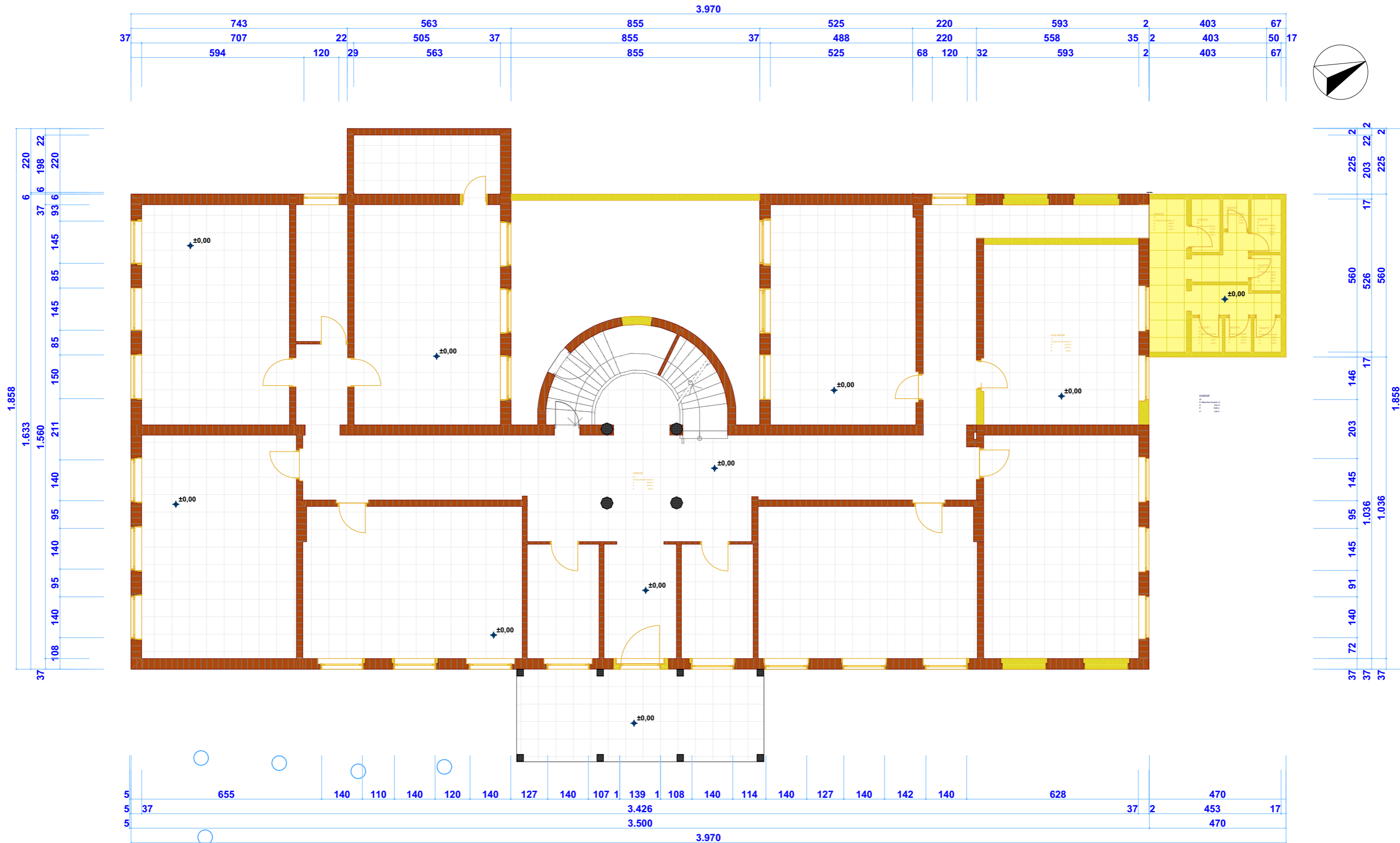

 NJESIA E PROJEKTIT DHE INFRASTRUKTURES	OBJEKTI :RIKONSTRUKSION SHKOLLA 9 VJECARE "JUSUF PUKA"			
	VENDODHJA : DURRES, DURRES	EMER MBIEMER Ark. Adnand TOÇILA	FIRMA Ark. Oltjon GRUÇKA	EMERTIMI I FLETES : PLANI PRISHJEVE KATI PERDHE
	PROJEKTI : ARKITEKTURA	Ing. Diana DEDJA		DATA 04/2019 SHKALLA
	FAZA E PROJEKTIT : PROJEKT ZBATIMI	Ing.elek. Marigjen JAHOLLARI		Nr. I FLETES A11

3.499																
	742	2	563	92	681	83	525	218	595	2						
37	705	22	505	37	92	28	625	28	83	37	488	218	595	2		
	595	120	563	4	88		681		83		525	70	120	28	595	2

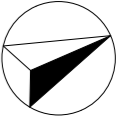

225	225
37	203
	22
37	93
	145
	85
	145
	85
	150
	211
	150
	85
	150
	85
	150
99	85
	150
	37
1.858	
1.633	
1.560	

60	2
140	2
25	140
37	22
	22
37	203
	22
37	225
	2
37	54
	150
	85
	153
	75
	153
	75
	153
	88
	113
	150
	90
	803
	150
	83
	150
	840
104	37
	37
1.858	

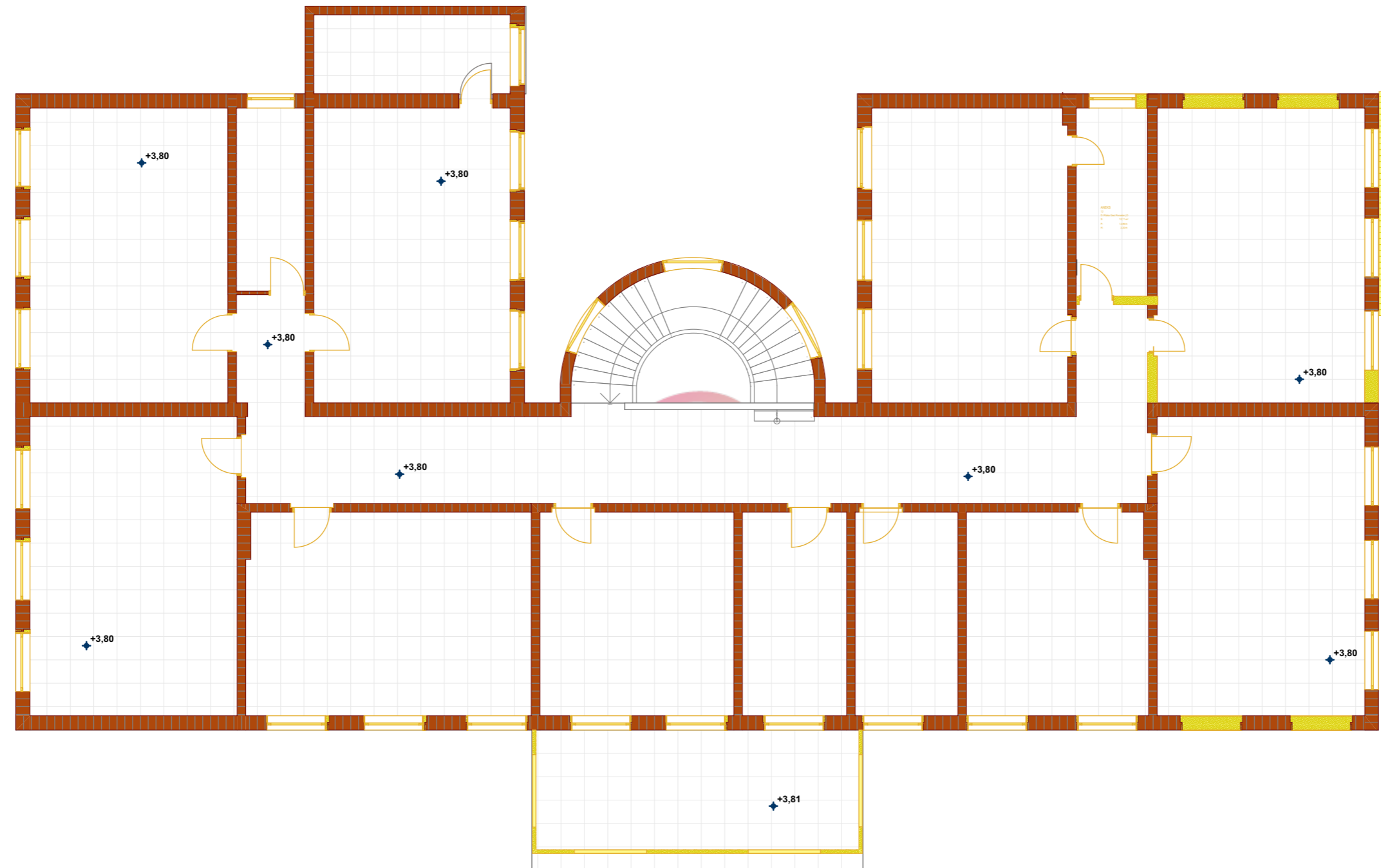

5	645	150	100	150	115	150	117	150	93	150	103	150	104	150	118	150	132	150	623	37	
5	3.426																				37
5	3.500																				
5	3.500																				

OBJEKTI :RIKONSTRUKSION SHKOLLA 9 VJECARE "JUSUF PUKA"

VENDODHJA : DURRES, DURRES PROJEKTI : ARKITEKTURA FAZA E PROJEKTI : PROJEKT ZBATIMI	GRUPI PROJEKTIMIT : EMER MBIEMER : Ark. Adhant TOÇILA FIRMA : Ark. Oltjon GRUÇKA Ing. Diana DEDJA Ing.elek. Mariglen JAHOLLARI	EMERTIMI I FLETES : PLANI PRISHJEVE KATI PARE DATA 04/2019 SHKALLA : Nr. I FLETES : A 12
--	--	--

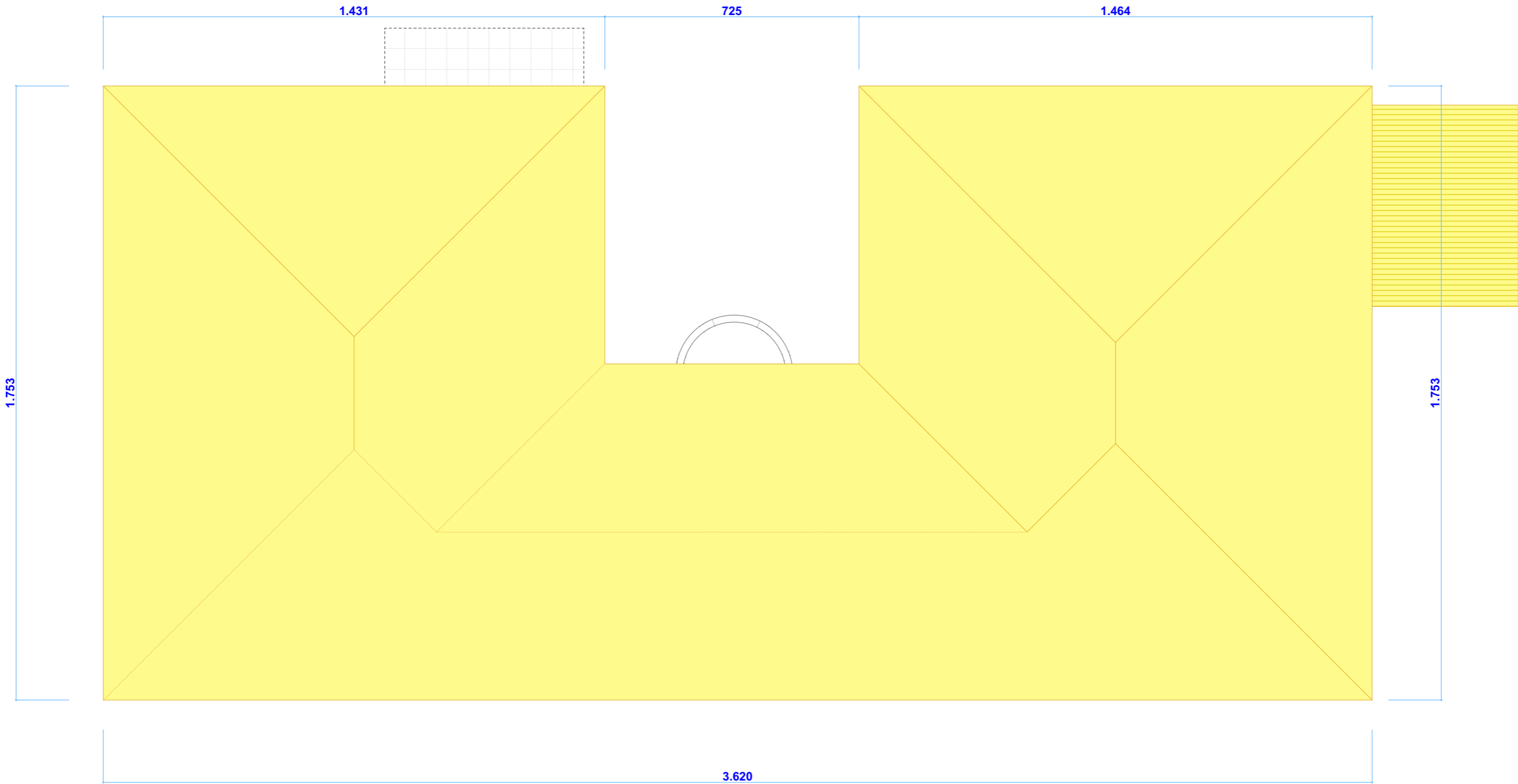
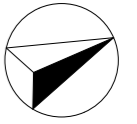

 NJESIA E PROJEKTIT DHE INFRASTRUKTURES	OBJEKTI :RIKONSTRUKSION SHKOLLA 9 VJECARE "JUSUF PUKA"			
	VENDODHJA : DURRES, DURRES	EMER MBIEMER Ark. Adnand TOÇILA	FIRMA	EMERTIMI I FLETES : PLANI PRISHJEVE CATIA
	PROJEKTI : ARKITEKTURA	Ark. Oltjon GRUÇKA		DATA 04/2019 SHKALLA
	FAZAE PROJEKTIT : PROJEKT ZBATIMI	Ing. Diana DEDJA	Ing.elek. Mariglen JAHOLLARI	Nr. I FLETES A 13



 NJESIA E PROJEKTIT DHE INFRASTRUKTURES	OBJEKTI :RIKONSTRUKSION SHKOLLA 9 VJECARE "JUSUF PUKA"		
	VENDODHJA : DURRES, DURRES	EMER MBIEMER	FIRMA
	PROJEKTI : ARKITEKTURA	Ark. Adnan TOÇILA Ark. Oltjon GRUÇKA Ing. Diana DEDJA	EMERTIMI I FLETES : PLANI SISTEMIM
	FAZA E PROJEKTIT : PROJEKT ZBATIMI	Ing.elek. Mariglen JAHOLLARI	DATA 04/2019 SHKALLA 1:250 Nr. I FLETES A 14

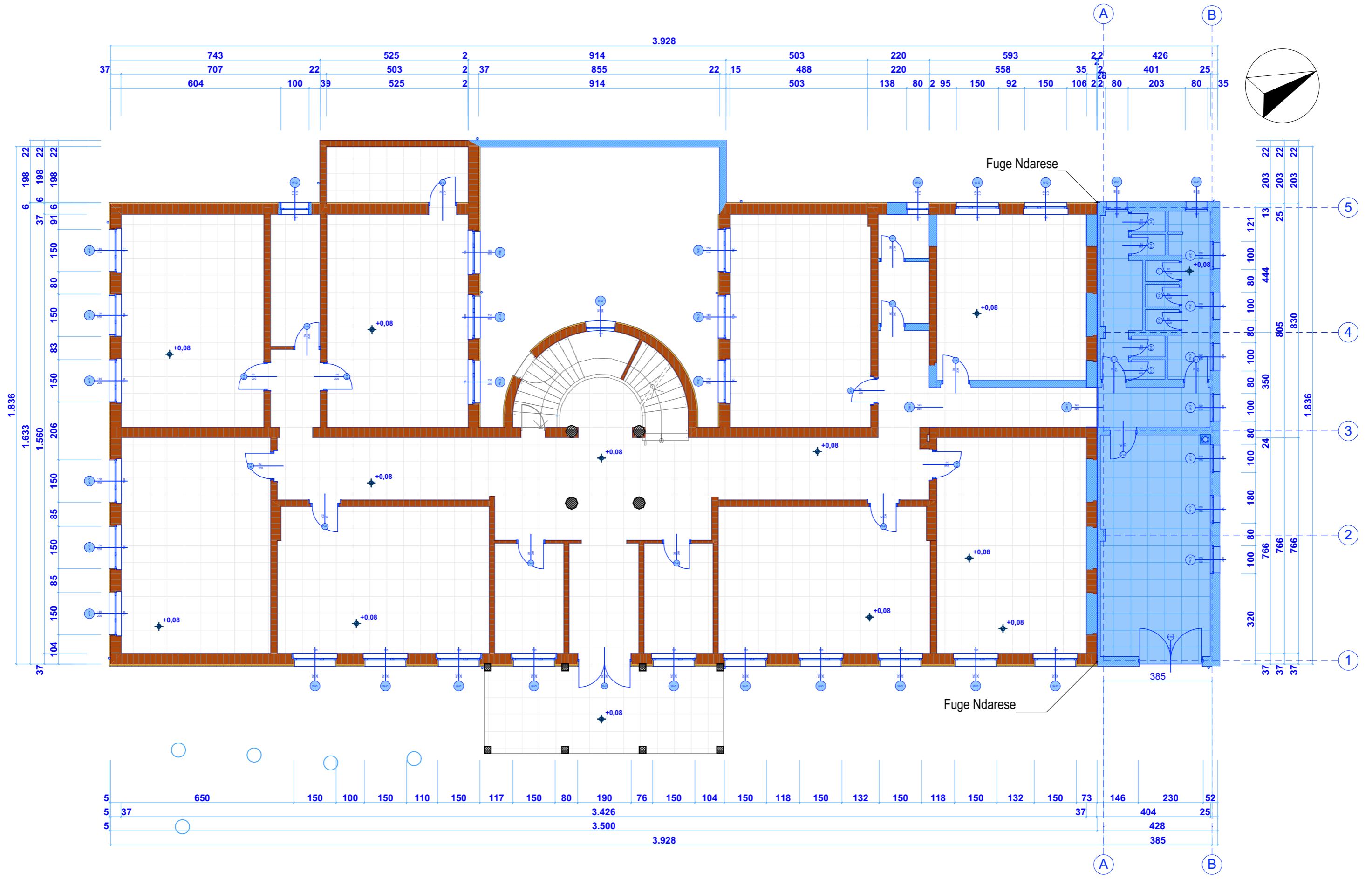

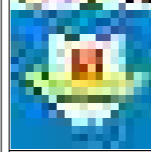
 NJESIA E PROJEKTIT DHE INFRASTRUKTURES	OBJEKTI :RIKONSTRUKSION SHKOLLA 9 VJECARE "JUSUF PUKA"		
	VENDODHJA :	EMER MBIEMER	FIRMA
	DURRES, DURRES	Ark. Adnand TOÇILA	
	PROJEKTI :	Ark. Oltjon GRUÇKA	
ARKITEKTURA	Ing. Diana DEDJA		
FAZA E PROJEKTIT :	Ing.elek. Mariglen JAHOLLARI		
PROJEKT ZBATIMI			
GRUPI PROJEKTIMIT :			
			EMERTIMI I FLETES :
			PLANI I KATI PERDHE PUNIMET E REJA
			DATA 04/2019 SHKALLA
			Nr. I FLETES A15

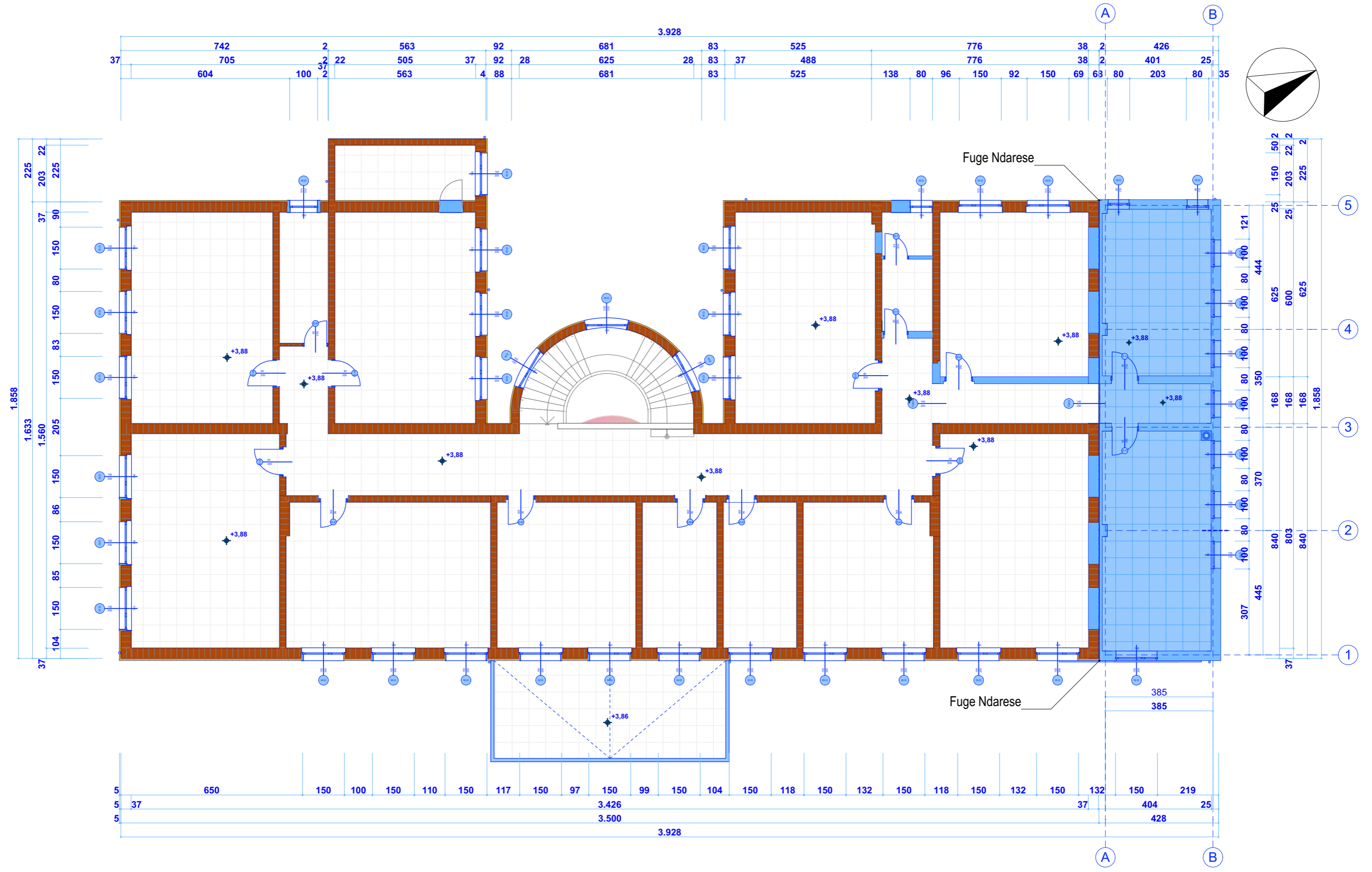

 NJESIA E PROJEKTIT DHE INFRASTRUKTURES	OBJEKTI :RIKONSTRUKSION SHKOLLA 9 VJECARE "JUSUF PUKA"		
	VENDODHJA : DURRES, DURRES	EMER MBIEMER Ark. Adnand TOÇILA	FIRMA
	PROJEKTI : ARKITEKTURA	Ark. Oltjon GRUÇKA	EMERTIMI I FLETES : PLANI I KATI PARE PUNIMET E REJA
	FAZA E PROJEKTIT : PROJEKT ZBATIMI	Ing. Diana DEDJA	Ing.elek. Marigjen JAHOLLARI
	GRUPI PROJEKTIMIT :		DATA 04/2019 SHKALLA Nr. I FLETES A 16

S-02

S-03

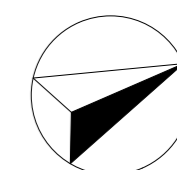



S-01

S-01

S-02

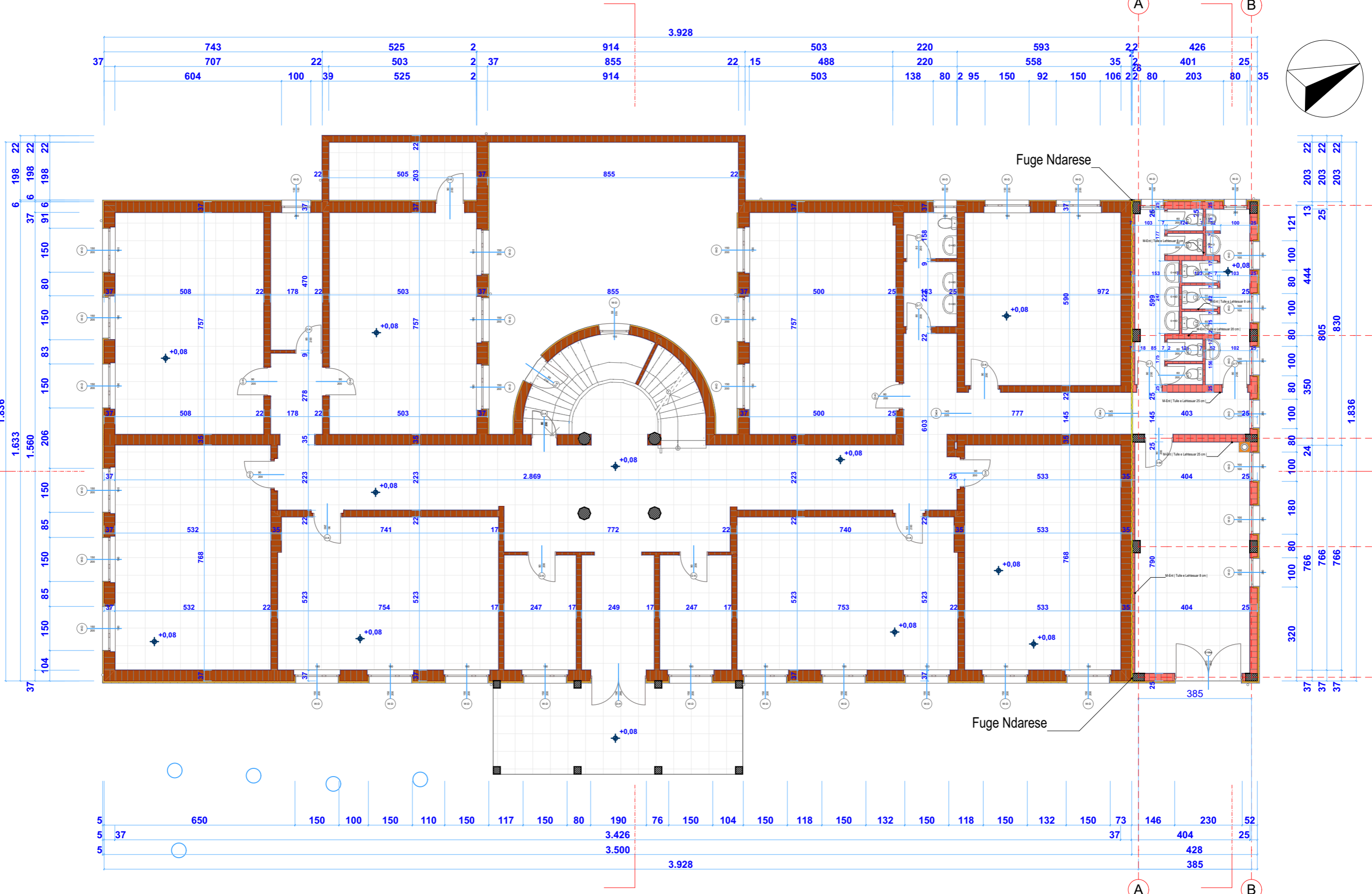
S-03



 NJESIA E PROJEKTIM DHE INFRASTRUKTURES	OBJEKTI :RIKONSTRUKSION SHKOLLA 9 VJECARE "JUSUF PUKA"		
	VENDODHJA :	EMER MBIEMER	FIRMA
	DURRES, DURRES	Ark. Adnand TOÇILA	
	PROJEKTI :	Ark. Oltjon GRUÇKA	
ARKITEKTURA	Ing. Diana DEDJA		
FAZAE PROJEKTIM :	Ing.elek. Marigjen JAHOLLARI		
PROJEKT ZBATIMI			
GRUPI PROJEKTIMIT :	EMERTIMI I FLETES :		
	PLANI I KATI PERDHE TEKNIK		
	DATA 04/2019	SHKALLA 1:125	
	Nr. I FLETES	A117	

S-02

S-03

S-01

S-01

S-02

S-03

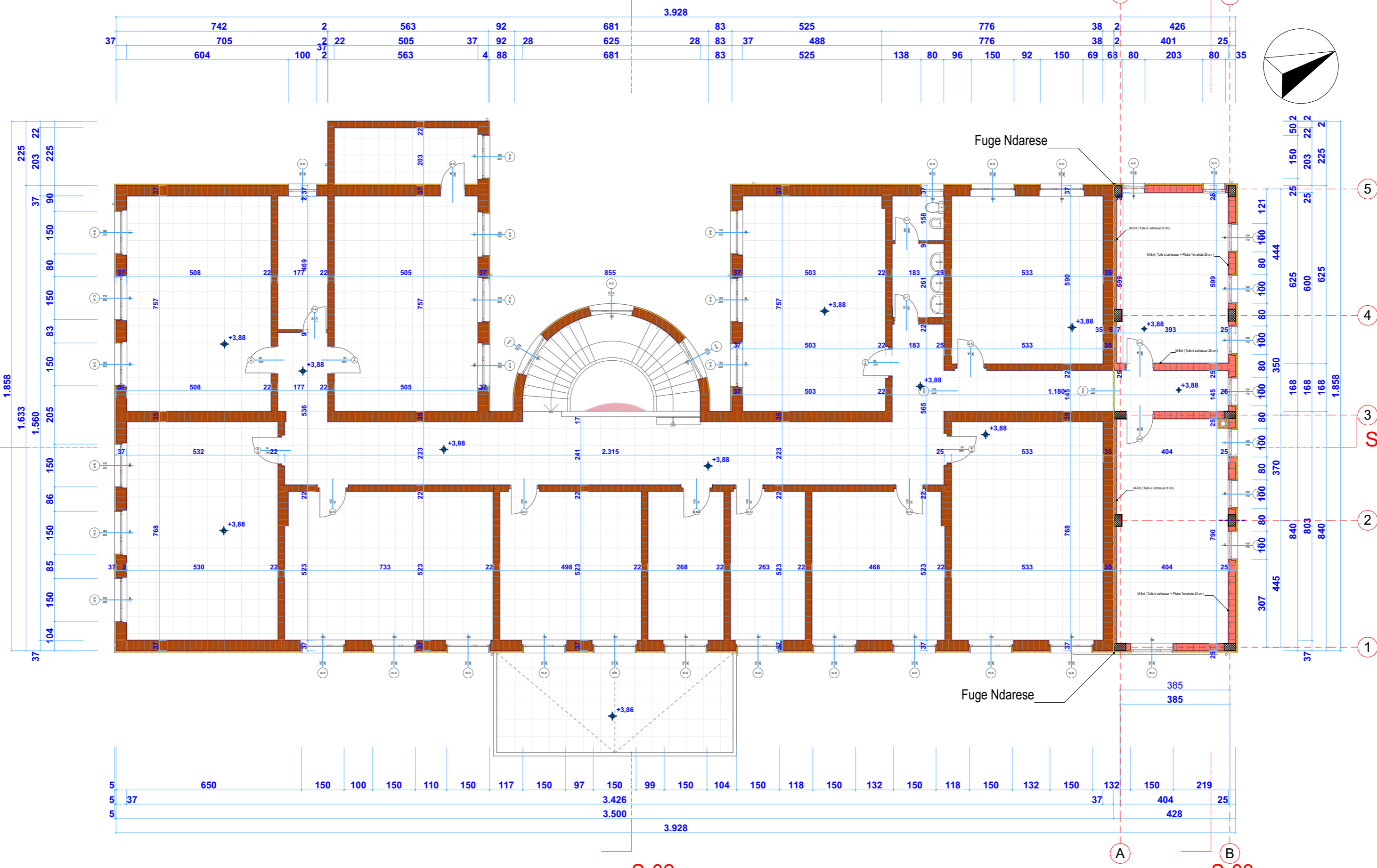

Fuge Ndarese

Fuge Ndarese

 <p>NJESIA E PROJEKTIT DHE INFRASTRUKTURES</p>	<p>OBJEKTI :RIKONSTRUKSION SHKOLLA 9 VJECARE "JUSUF PUKA"</p>			
	<p>VENDODHJA : DURRES, DURRES</p>	<p>EMER MBIEMER Ark. Adnand TOÇILA</p>	<p>FIRMA</p>	<p>EMERTIMI I FLETES : PLANI I KATI PARE TEKNIK</p>
	<p>PROJEKTI : ARKITEKTURA</p>	<p>Ark. Oltjon GRUÇKA Ing. Diana DEDJA</p>		<p>DATA 04/2019 SHKALLA 1:125</p>
	<p>FAZAE PROJEKTIT : PROJEKT ZBATIMI</p>	<p>Ing.elek. Marigjen JAHOLLARI</p>		<p>Nr. I FLETES A 18</p>

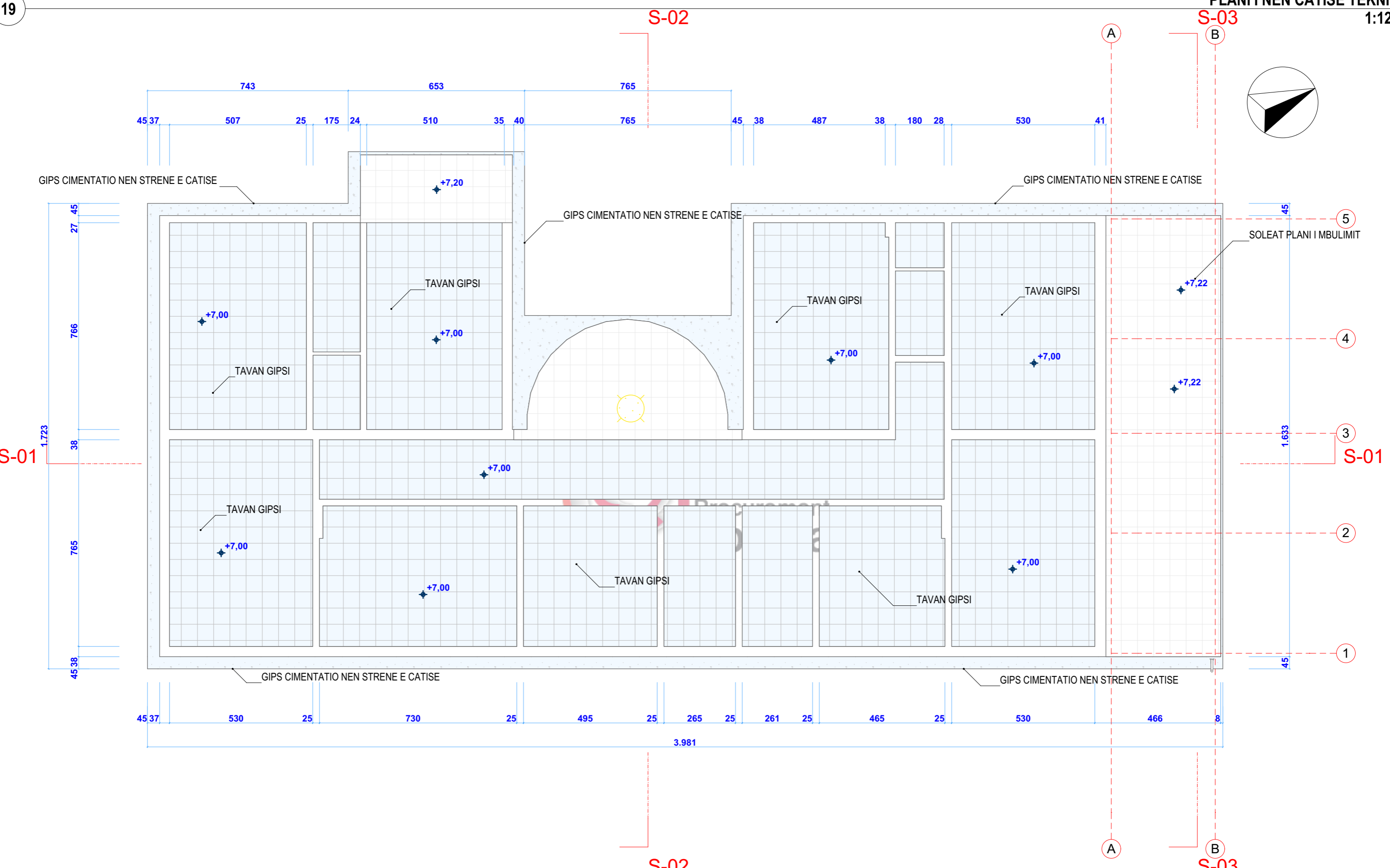
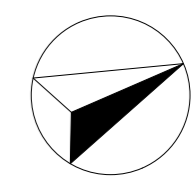

<p>NJESIA E PROJEKTIT DHE INFRASTRUKTURES</p>	<p>OBJEKTI :RIKONSTRUKSION SHKOLLA 9 VJECARE "JUSUF PUKA"</p>		
	<p>VENDODHJA : DURRES, DURRES</p>	<p>EMER MBIEMER Ark. Adnand TOÇILA</p>	<p>FIRMA</p>
	<p>PROJEKTI : ARKITEKTURA</p>	<p>Ark. Oltjon GRUÇKA Ing. Diana DEDJA</p>	<p>EMERTIMI I FLETES : PLANI I NEN CATISE TEKNIK</p>
	<p>FAZA E PROJEKTIT : PROJEKT ZBATIMI</p>	<p>Ing.elek. Mariglen JAHOLLARI</p>	<p>DATA 04/2019 SHKALLA 1:125 Nr. I FLETES A 19</p>

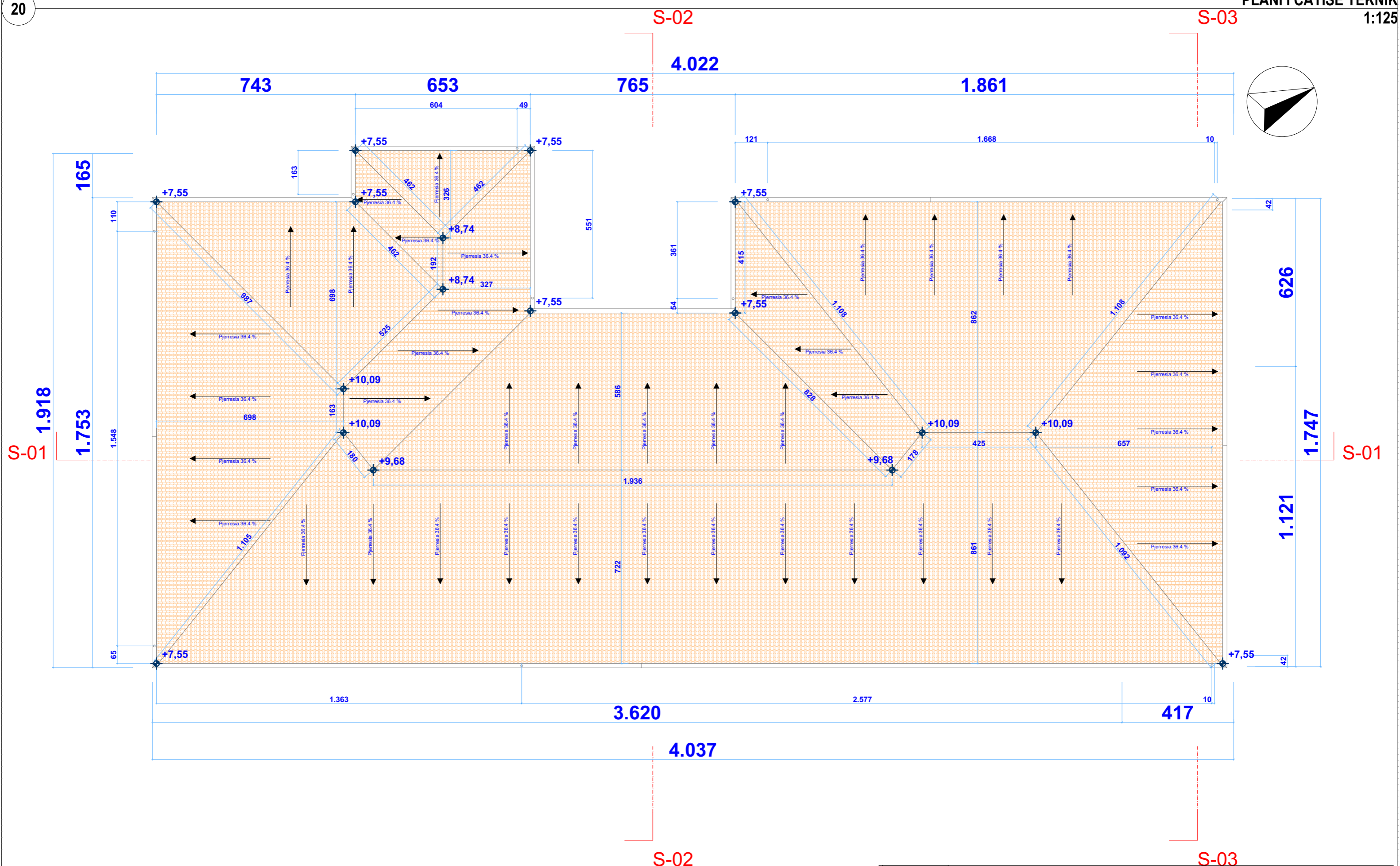

 NJESIA E PROJEKTTIT DHE INFRASTRUKTURES	OBJEKTI :RIKONSTRUKSION SHKOLLA 9 VJECARE "JUSUF PUKA"		
	VENDODHJA : DURRES, DURRES	EMER MBIEMER Ark. Adhand TOÇILA	FIRMA
	PROJEKTI : ARKITEKTURA	GRUPI PROJEKTIMIT : Ark. Oltjon GRUÇKA Ing. Diana DEDJA	EMERTIMI I FLETES : PLANI I CATISE TEKNIK
	FAZA E PROJEKTTIT : PROJEKT ZBATIMI	Ing.elek. Mariglen JAHOLLARI	DATA 04/2019 SHKALLA 1:125 Nr. I FLETES A 20

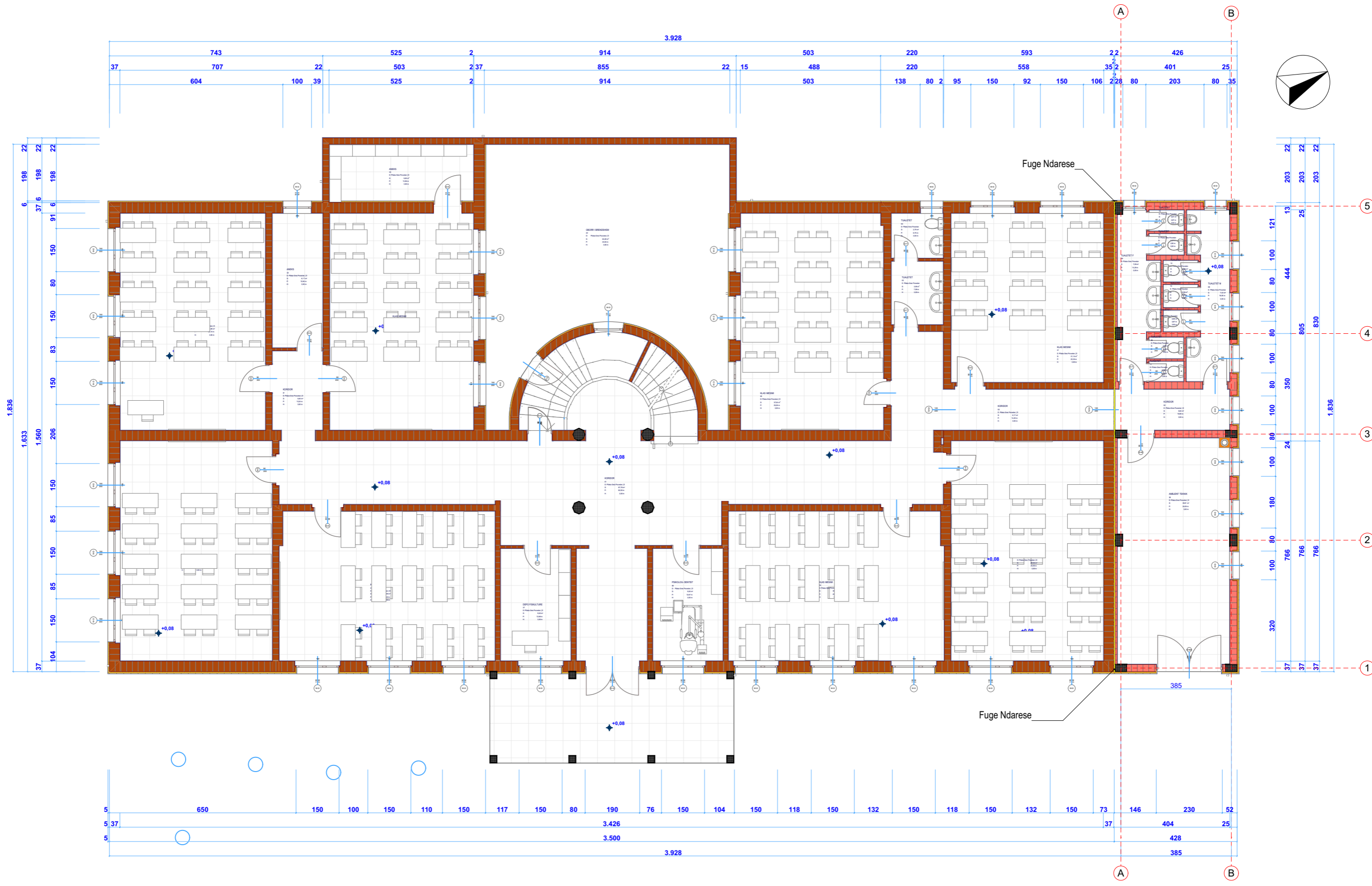

 NJESIA E PROJEKTIT DHE INFRASTRUKTURES	OBJEKTI :RIKONSTRUKSION SHKOLLA 9 VJECARE "JUSUF PUKA"		
	VENDODHJA : DURRES, DURRES	EMER MBIEMER Ark. Adnand TOÇILA	FIRMA
	PROJEKTI : ARKITEKTURA	Ark. Oltjon GRUÇKA	EMERTIMI I FLETES : PLANI I KATI PERDHE MOBILIM
	FAZAE PROJEKTIT : PROJEKT ZBATIMI	Ing. Diana DEDJA	Ing.elek. Marigjen JAHOLLARI
	GRUPI PROJEKTIMIT :		DATA 04/2019 SHKALLA 1:125 Nr. I FLETES A 21

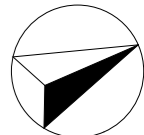

PLANI I KATI PERDHE

01	KORIDOR
01	KORIDOR
02	KORIDOR
02	KORIDOR
02	TUALETET
03	TUALETET
06	TUALETET
07	TUALETET
08	TUALETET M
09	TUALETET F
10	TUALETET
11	TUALETET
12	TUALETET
13	TUALETET
14	TUALETET
16	KLAS MESIMI
17	KLAS MESIMI
20	KLAS MESIMI
21	KLAS MESIMI
22	OBORR I BRENDSHEM
24	KLAS MESIMI
26	KLAS MESIMI
28	KLAS MESIMI
31	KLAS MESIMI
32	ANEKS
33	ANEKS
37	DEPO FISKULTURE
38	AMBJENT TEKNIK
40	PSIKOLOG- DENTIST

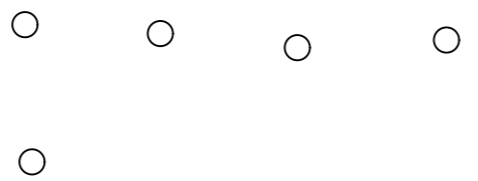

<p>NJESIA E PROJEKTIT DHE INFRASTRUKTURES</p>	OBJEKTI :RIKONSTRUKSION SHKOLLA 9 VJECARE "JUSUF PUKA"		VENDODHJA : DURRES, DURRES		EMER MBIEMER Ark. Adnand TOÇILA Ark. Oltjon GRUÇKA Ing. Diana DEDJA Ing.elek. Mariglen JAHOLLARI	EMERTIMI I FLETES : PLANI KATI PERDHE SKEMA FUNKSIONALE		
	PROJEKTI : ARKITEKTURA		FIRMA			DATA 04/2019	SHKALLA	Nr. I FLETES A 22
	FAZA E PROJEKTIT : PROJEKT ZBATIMI		GRUPI PROJEKTIMIT :					

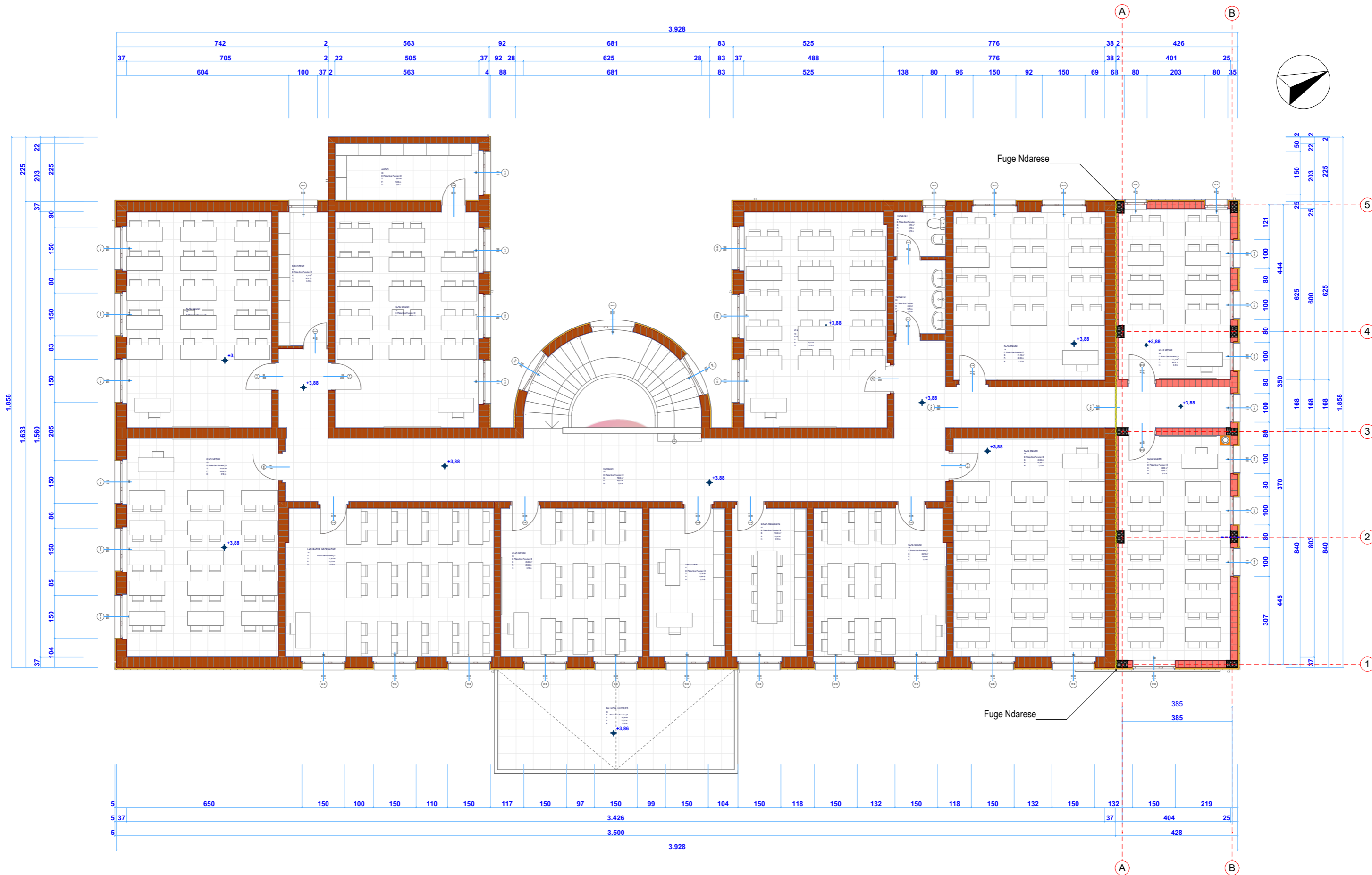

 NJESIA E PROJEKTIM DHE INFRASTRUKTURES	OBJEKTI :RIKONSTRUKSION SHKOLLA 9 VJECARE "JUSUF PUKA"			
	VENDODHJA : DURRES, DURRES	EMER MBIEMER Ark. Adnand TOÇILA	FIRMA	EMERTIMI I FLETES : PLANI I KATI PARE MOBILIM
	PROJEKTI : ARKITEKTURA	GRUPI PROJEKTIMIT : Ark. Oltjon GRUÇKA Ing. Diana DEDJA		DATA 04/2019 SHKALLA 1:125
	FAZA E PROJEKTIMIT : PROJEKT ZBATIMI	Ing.elek. Marigjen JAHOLLARI		Nr. I FLETES A 23

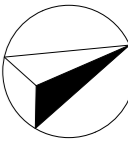
PLANI I KATI PARE

00	KORIDOR
04	TUALETET
05	TUALETET
15	KLAS MESIMI
18	KLAS MESIMI
19	KLAS MESIMI
23	KLAS MESIMI
25	KLAS MESIMI
27	KLAS MESIMI
29	LABURATOR INFORMATIKE
30	BIBLIOTEKE
34	KLAS MESIMI
35	BALLKONI I HYERJES
36	ANEKS
39	KLAS MESIMI
40	KLAS MESIMI
41	DREJTORIA
41	KLAS MESIMI
42	SALLA MESUESVE

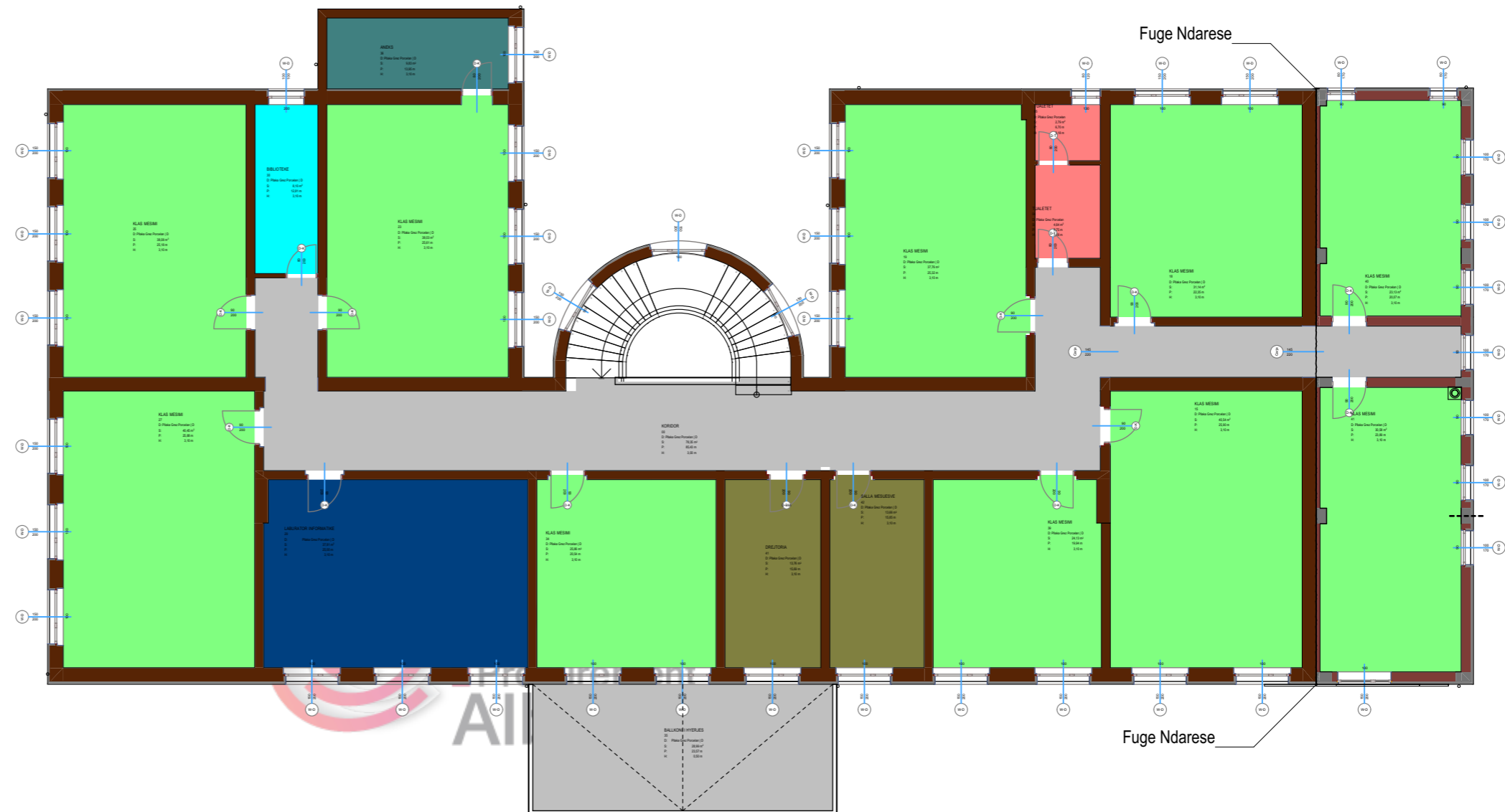

<p>NJESIA E PROJEKTIT DHE INFRASTRUKTURES</p>	OBJEKTI :RIKONSTRUKSION SHKOLLA 9 VJECARE "JUSUF PUKA"		
	VENDODHJA :	EMER MBIEMER	FIRMA
	DURRES, DURRES	Ark. Adnand TOÇILA	
	PROJEKTI :	Ark. Oltjon GRUÇKA	
ARKITEKTURA	Ing. Diana DEDJA		
FAZA E PROJEKTIT :	Ing.elek. Mariglen JAHOLLARI		
PROJEKT ZBATIMI			
GRUPI PROJEKTIMIT :			
		EMERTIMI I FLETES :	
		PLANI KATI PARE SKEMA FUNKSIONALE	
		DATA 04/2019 SHKALLA	
		Nr. I FLETES A 24	

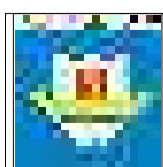
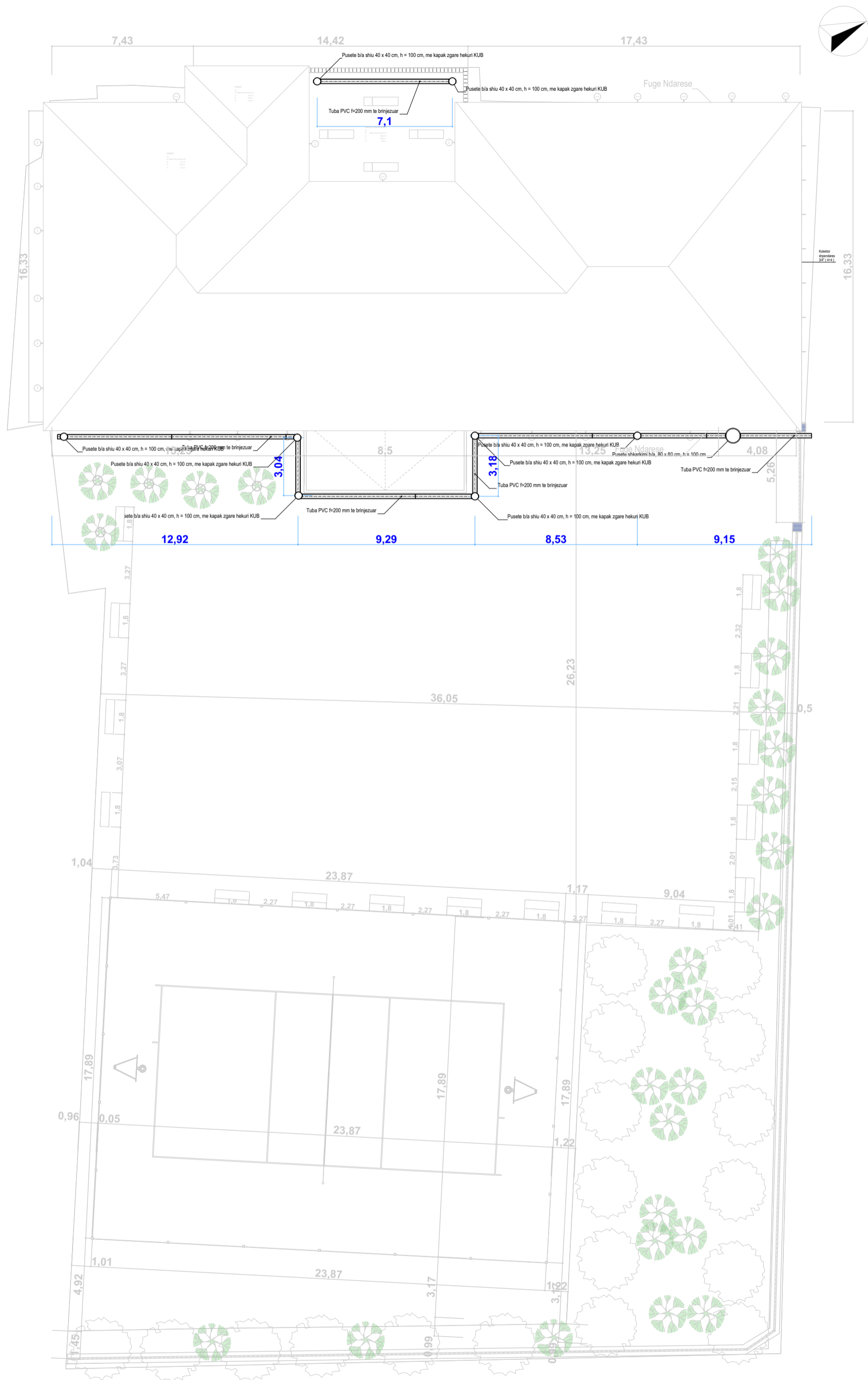

NJESIA E
PROJEKTI DHE
INFRASTRUKTURES

OBJEKTI :RIKONSTRUKSION SHKOLLA 9 VJECARE "JUSUF PUKA"

VENDODHJA :
DURRES, DURRES
PROJEKTI :
ARKITEKTURA
FAZA E PROJEKTI :
PROJEKT ZBATIMI

GRUPI PROJEKTI :
EMER MBIEMER

ARK. Adnand TOÇILA
Ark. Oltjon GRUÇKA
Ing. Diana DEDJA
Ing.elek. Mariglen JAHOLLARI

FIRMA
EMERTIMI I FLETES :
PLANI SISTEMIM SISTEMIMI I UJRAVE

DATA 04/2019 SHKALLA
Nr. I FLETES

A/25

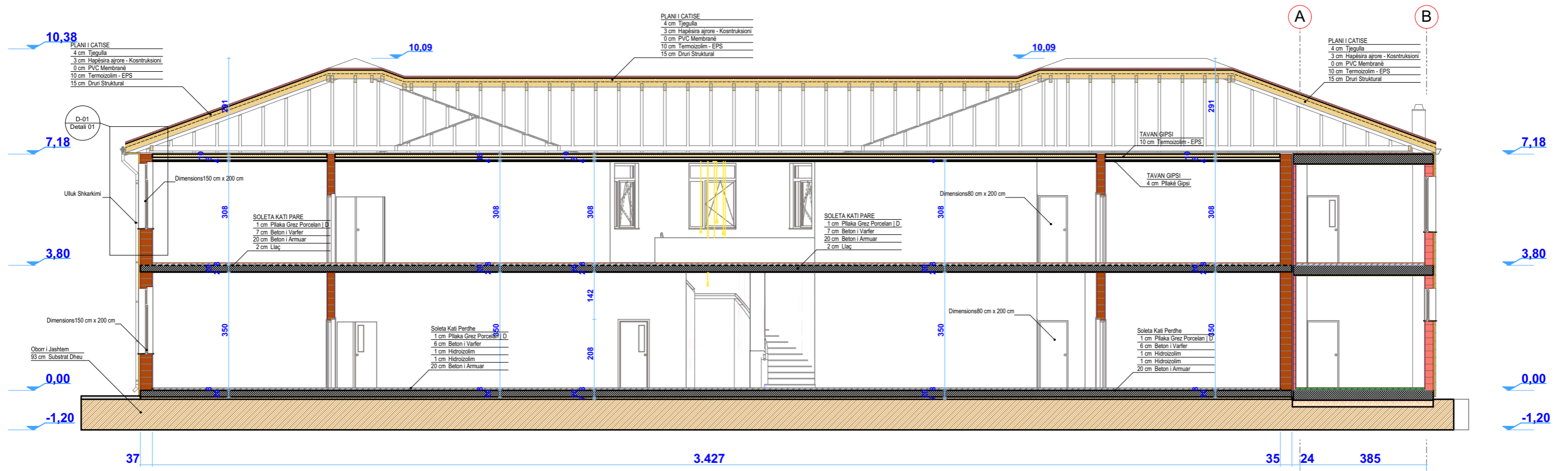

Detali 01

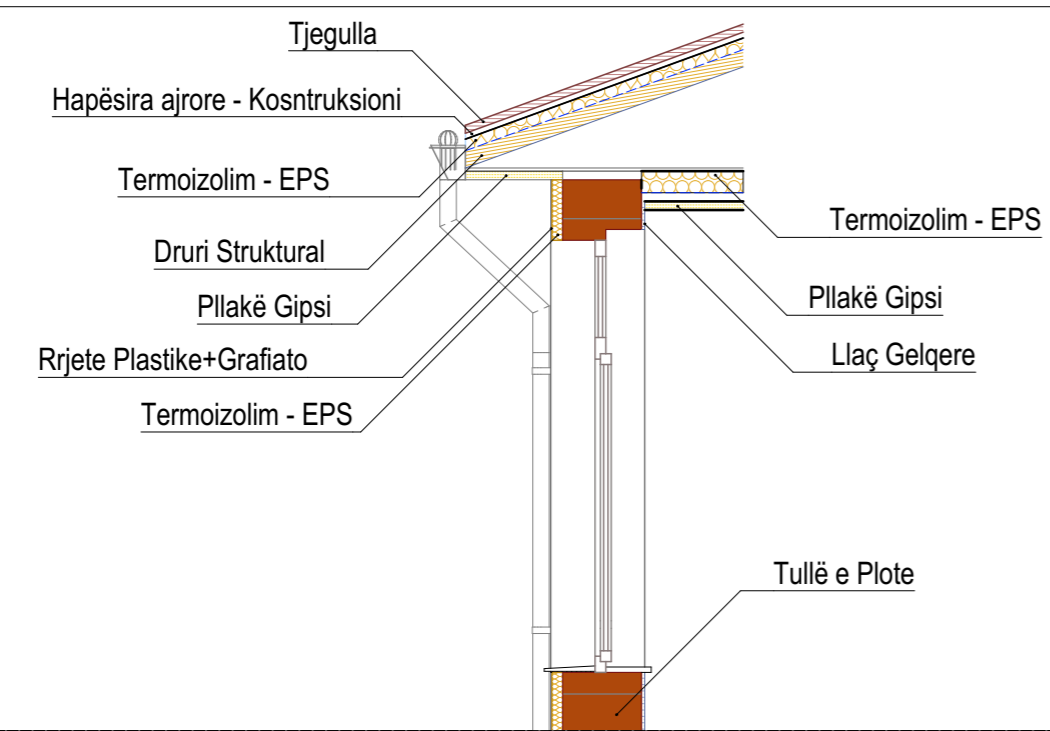

<p>NJESIA E PROJEKTIT DHE INFRASTRUKTURES</p>	<p>OBJEKTI :RIKONSTRUKSION SHKOLLA 9 VJECARE "JUSUF PUKA"</p>		
	<p>VENDODHJA : DURRES, DURRES</p>	<p>EMER MBIEMER Ark. Adnand TOÇILA</p>	<p>FIRMA</p>
	<p>PROJEKTI : ARKITEKTURA</p>	<p>Ark. Oltjon GRUÇKA Ing. Diana DEDJA</p>	<p>EMERTIMI I FLETES : S-01 PRERJA</p>
	<p>FAZA E PROJEKTIT : PROJEKT ZBATIMI</p>	<p>Ing.elek. Mariglen JAHOLLARI</p>	<p>DATA 04/2019 SHKALLA Nr. I FLETES A 26</p>

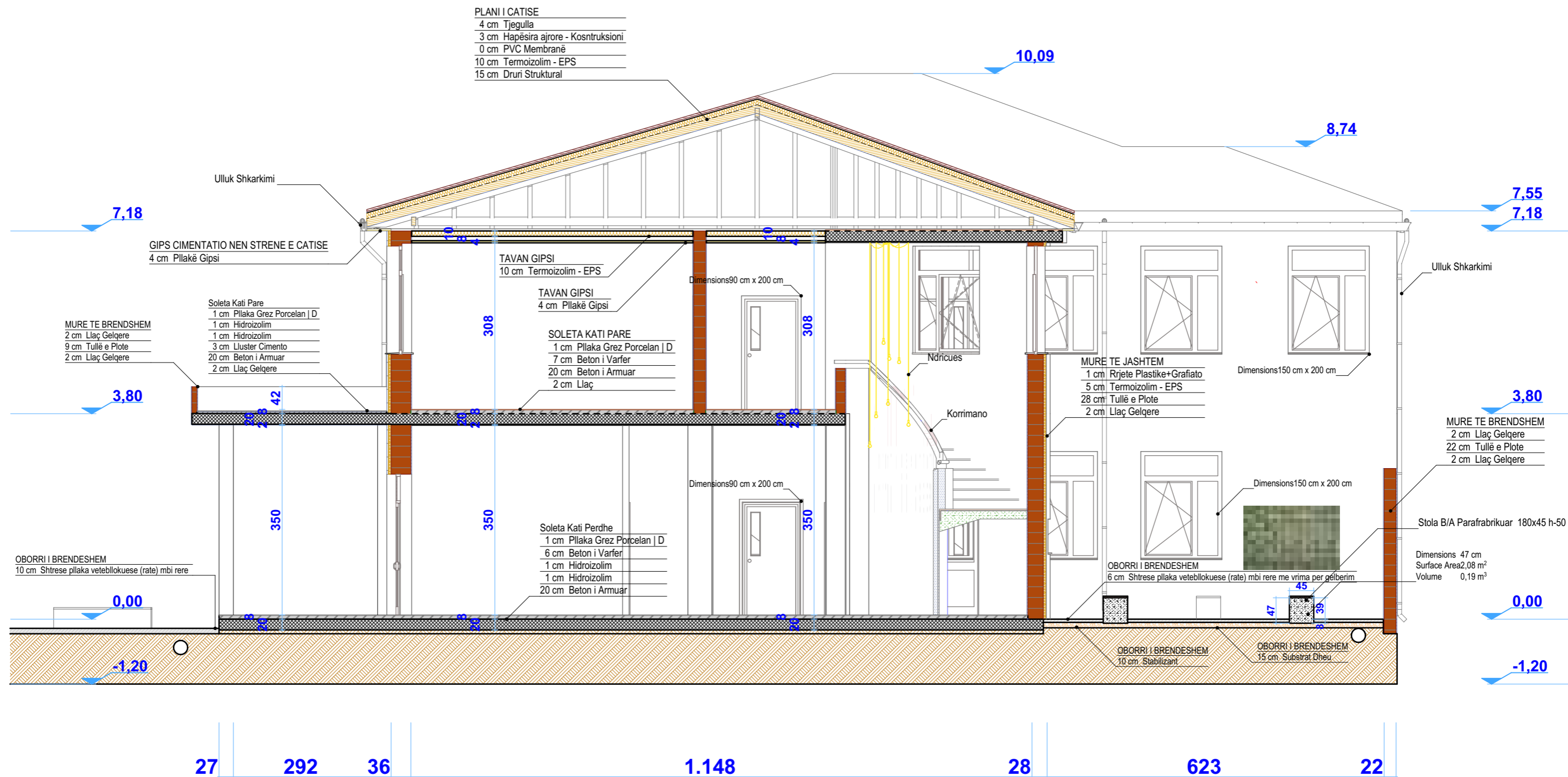

 NJESIA E PROJEKTIT DHE INFRASTRUKTURES	OBJEKTI :RIKONSTRUKSION SHKOLLA 9 VJECARE "JUSUF PUKA"		
	VENDODHJA : DURRES, DURRES	EMER MBIEMER Ark. Adnan TOÇILA	FIRMA
	PROJEKTI : ARKITEKTURA	GRUPI PROJEKTIMIT : Ark. Oltjon GRUÇKA Ing. Diana DEDJA	EMERTIMI I FLETES : S-02 PRERJA
	FAZA E PROJEKTIT : PROJEKT ZBATIMI	Ing.elek. Marigjen JAHOLLARI	DATA 04/2019 SHKALLA 1:75 Nr. I FLETES A 27

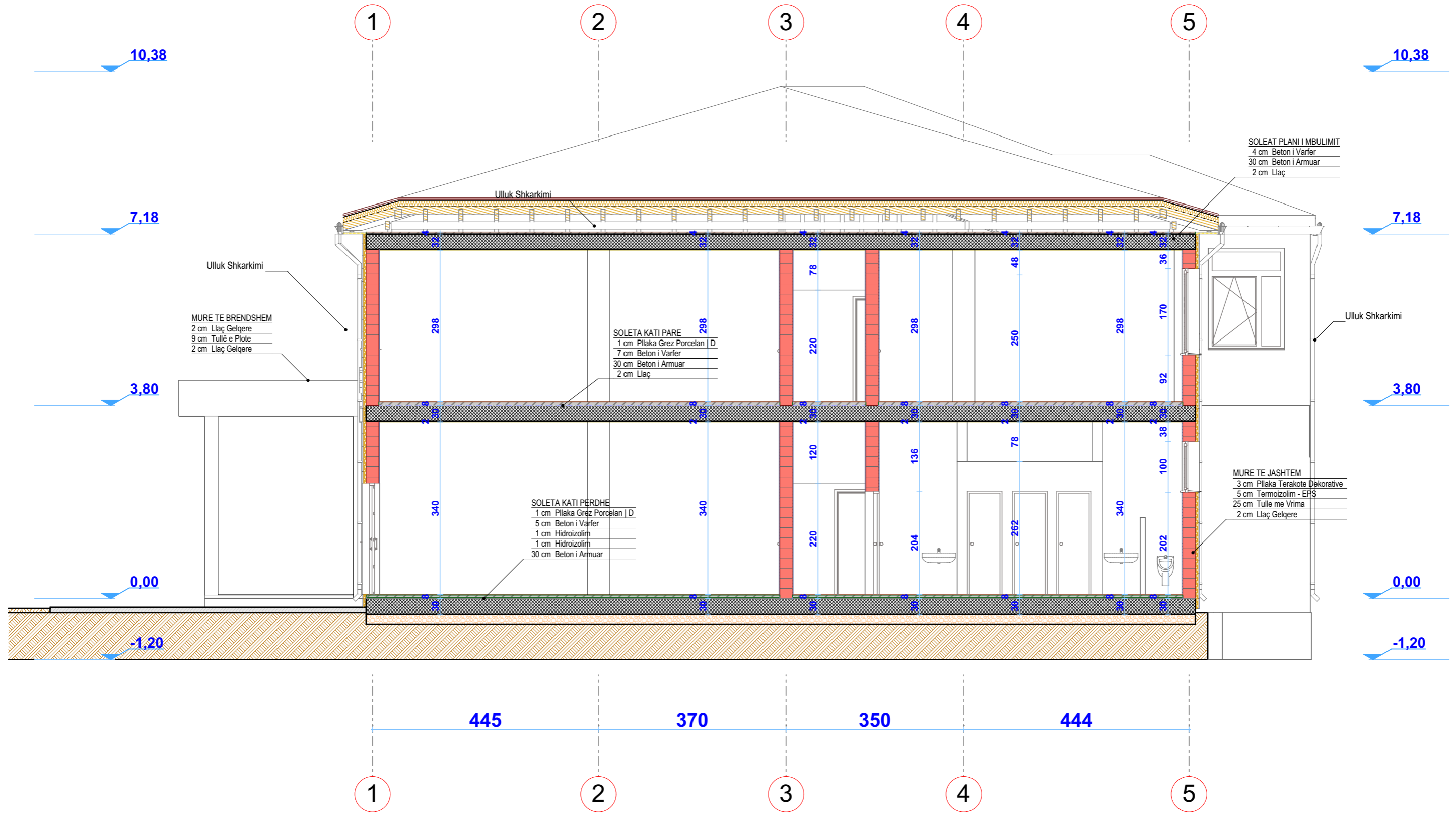

 NJESIA E PROJEKTIT DHE INFRASTRUKTURES	OBJEKTI :RIKONSTRUKSION SHKOLLA 9 VJECARE "JUSUF PUKA"			
	VENDODHJA : DURRES, DURRES	EMER MBIEMER Ark. Adnand TOÇILA	FIRMA	EMERTIMI I FLETES : S-03 PRERJA
	PROJEKTI : ARKITEKTURA	Ark. Oltjon GRUÇKA		DATA 04/2019 SHKALLA
	FAZAE PROJEKTIT : PROJEKT ZBATIMI	Ing. Diana DEDJA		Nr. I FLETES
GRUPI PROJEKTIMIT :	Ing.elek. Marigjen JAHOLLARI		A 28	



 NJESIA E PROJEKTIT DHE INFRASTRUKTURES	OBJEKTI :RIKONSTRUKSION SHKOLLA 9 VJECARE "JUSUF PUKA"		
	VENDODHJA : DURRES, DURRES	EMER MBIEMER Ark. Adnand TOÇILA	FIRMA
	PROJEKTI : ARKITEKTURA	Ark. Oltjon GRUÇKA Ing. Diana DEDJA	EMERTIMI I FLETES : FASADA JUGORE
	FAZA E PROJEKTIT : PROJEKT ZBATIMI	Ing.elek. Mariglen JAHOLLARI	DATA 04/2019 SHKALLA Nr. I FLETES A 29



MURE TE JASHEM
 3 cm Plaka Terakote Dekorative
 5 cm Termoizolim - EPS
 37 cm Tulle e Plote
 2 cm Liqar Gjelqere

MURE TE JASHEM
 3 cm Plaka Terakote Dekorative
 5 cm Termoizolim - EPS
 37 cm Tulle e Plote
 2 cm Liqar Gjelqere

Shkolla 9-Vjecare
 "Jusuf Puka"

 NJESIA E PROJEKTIT DHE INFRASTRUKTURES	OBJEKTI :RIKONSTRUKSION SHKOLLA 9 VJECARE "JUSUF PUKA"			
	VENDODHJA : DURRES, DURRES	EMER MBIEMER Ark. Adnand TOÇILA Ark. Oltjon GRUÇKA Ing. Diana DEDJA Ing.elek. Marigjen JAHOLLARI	FIRMA	EMERTIMI I FLETES : FASADA LINDORE
	PROJEKTI : ARKITEKTURA	GRUPI PROJEKTIMIT :	DATA 04/2019	SHKALLA
	FAZA E PROJEKTIT : PROJEKT ZBATIMI	Nr. I FLETES	A 30	

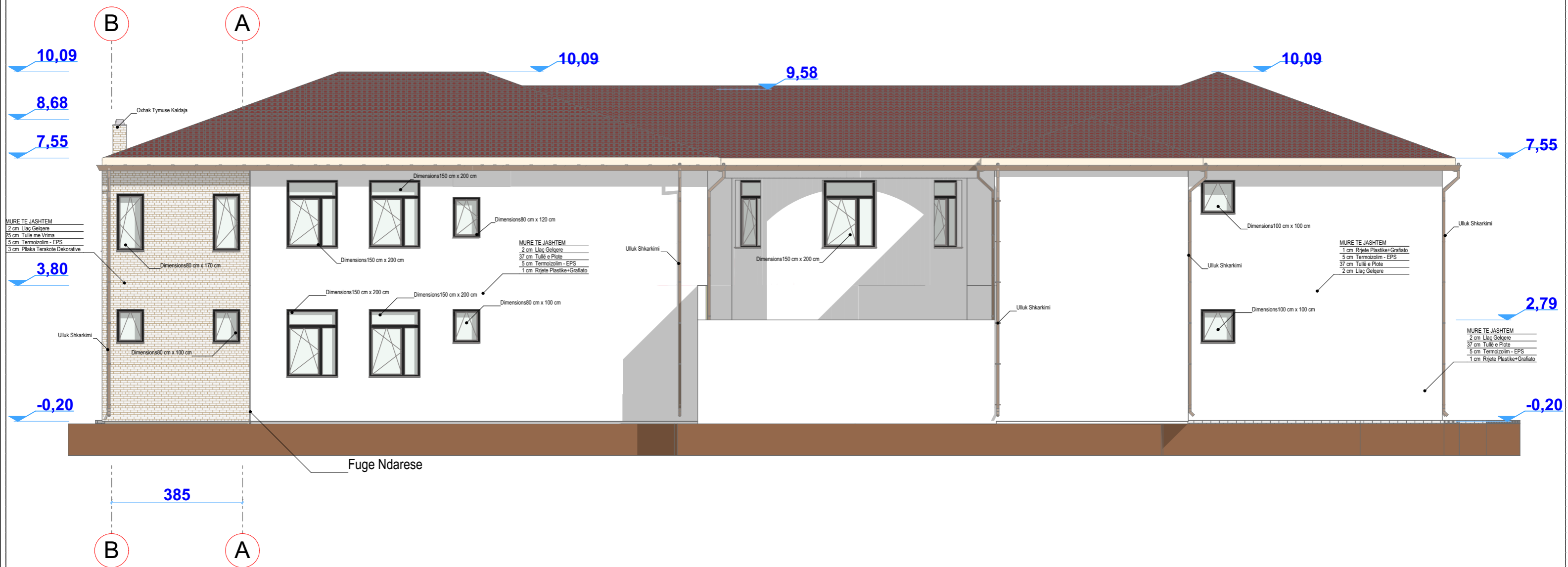

 NJESIA E PROJEKTIT DHE INFRASTRUKTURES	OBJEKTI :RIKONSTRUKSION SHKOLLA 9 VJECARE "JUSUF PUKA"		
	VENDODHJA : DURRES, DURRES	EMER MBIEMER Ark. Adnand TOÇILA	FIRMA
	PROJEKTI : ARKITEKTURA	Ark. Oltjon GRUÇKA	EMERTIMI I FLETES : FASADA PERENDIMORE
	FAZA E PROJEKTIT : PROJEKT ZBATIMI	Ing. Diana DEDJA	Ing.elek. Mariglen JAHOLLARI
	GRUPI PROJEKTIMIT :		DATA 04/2019 SHKALLA Nr. I FLETES A 31

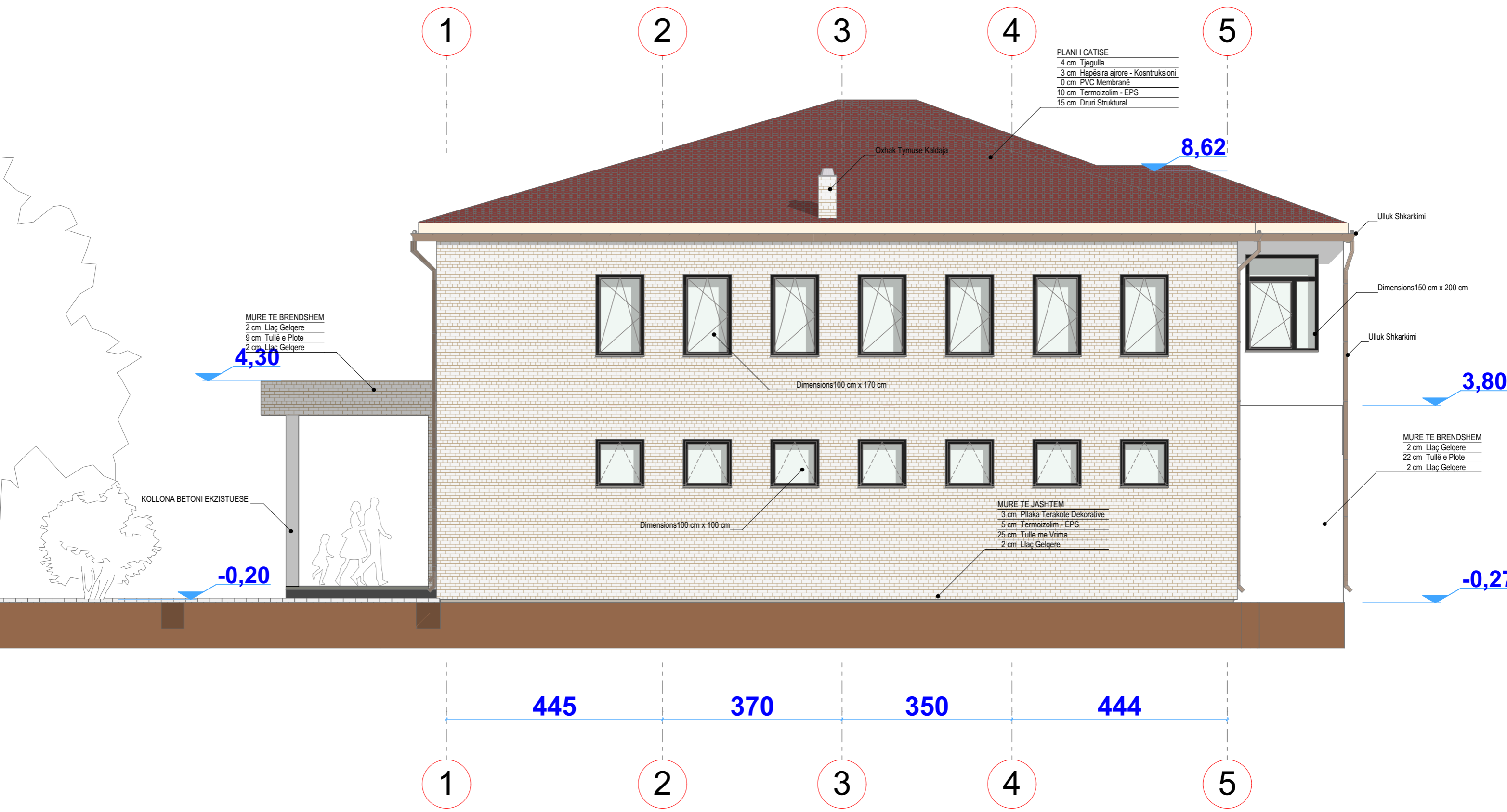

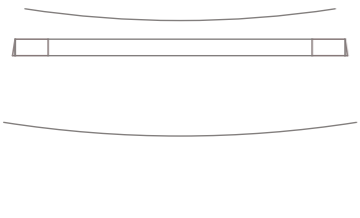
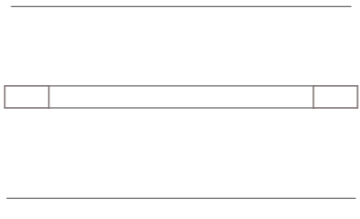
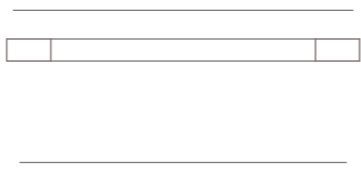
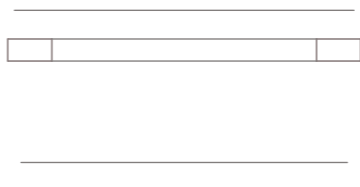
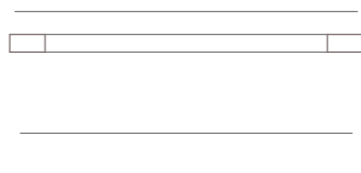
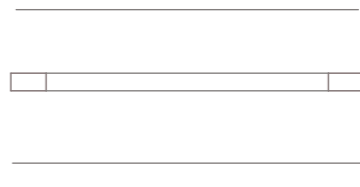
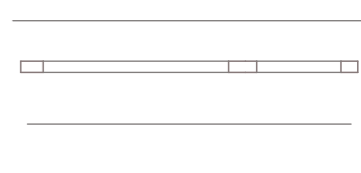
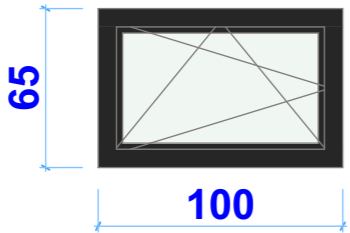
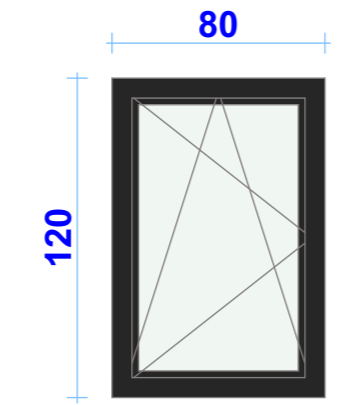
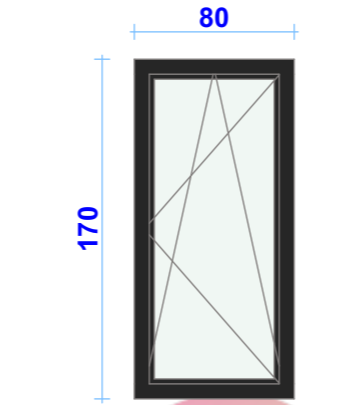
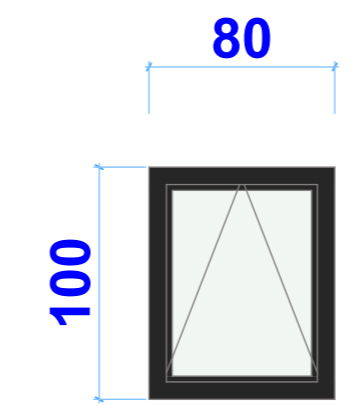
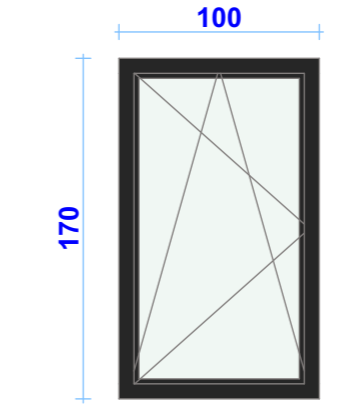
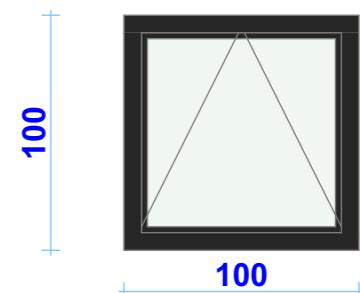
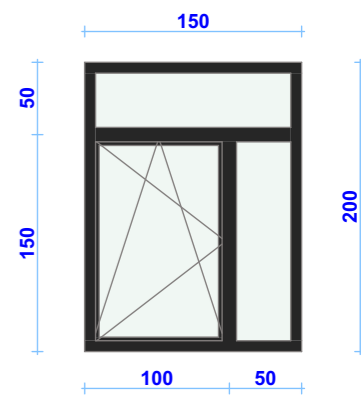

 NJESIA E PROJEKTIT DHE INFRASTRUKTURES	OBJEKTI :RIKONSTRUKSION SHKOLLA 9 VJECARE "JUSUF PUKA"		
	VENDODHJA : DURRES, DURRES	EMER MBIEMER Ark. Adnand TOÇILA	FIRMA
	PROJEKTI : ARKITEKTURA	GRUPI PROJEKTIMIT : Ark. Oltjon GRUÇKA Ing. Diana DEDJA	EMERTIMI I FLETES : FASADA VERIORE
	FAZA E PROJEKTIT : PROJEKT ZBATIMI	Ing.elek. Marigjen JAHOLLARI	DATA 04/2019 SHKALLA Nr. I FLETES A 32

ID Elementit	W-D	W-D	W-D	W-D	W-D	W-D	W-D
Sasia	1	1	2	3	7	9	54
Gjersi x Lartesi	100x65	80x120	80x170	80x100	100x170	100x100	150x200
Simboli 2D							
Pamje Ballore e Hapjes							
Model	F V dritare d/alumini plastike me dopio xham(Me mek Antiribalt Hapje)	F V dritare d/alumini plastike me dopio xham(Me mek Antiribalt Hapje)	F V dritare d/alumini plastike me dopio xham(Me mek Antiribalt Hapje)	F V dritare d/alumini plastike me dopio xham	F V dritare d/alumini plastike me dopio xham(Me mek Antiribalt Hapje)	F V dritare d/alumini plastike me dopio xham	F V dritare d/alumini plastike me dopio xham(Me mek Antiribalt Hapje)

	OBJEKTI :RIKONSTRUKSION SHKOLLA 9 VJECARE "JUSUF PUKA"		
	VENDODHJA : DURRES, DURRES	EMER MBIEMER Ark. Adnan TOÇILA	FIRMA
	PROJEKTI : ARKITEKTURA	Ark. Oltjon GRUÇKA	EMERTIMI I FLETES : SKEMA E DRITAREVE
	FAZA E PROJEKTI : PROJEKT ZBATIMI	Ing. Diana DEDJA	Ing.elek. Marigjen JAHOLLARI
NJESIA E PROJEKTI DHE INFRASTRUKTURES	GRUPI PROJEKTI MIT :	DATA 04/2019	SHKALLA Nr. I FLETES
			A 33

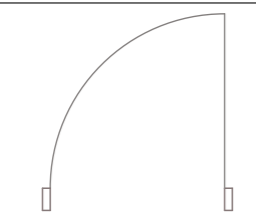
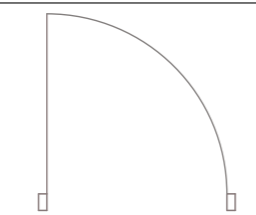
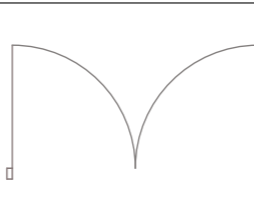
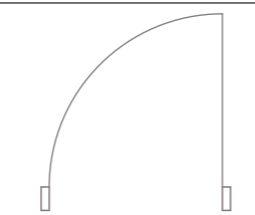
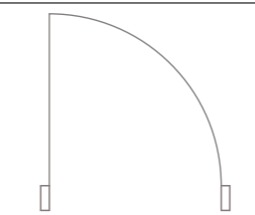
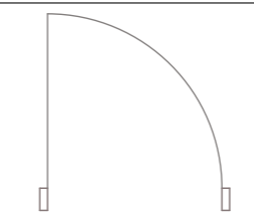
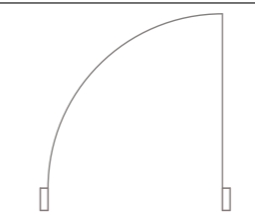
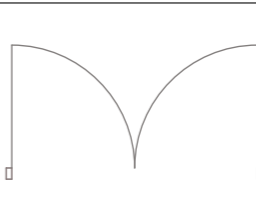
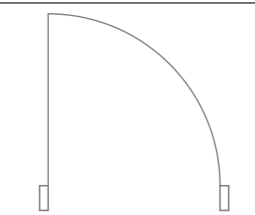
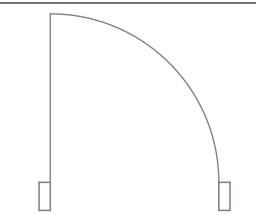
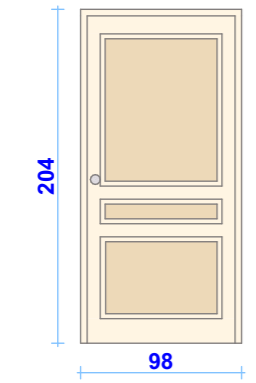
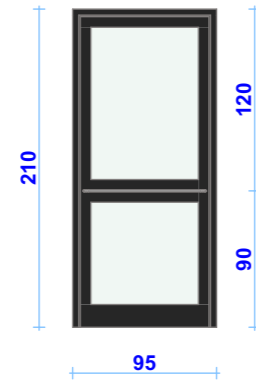
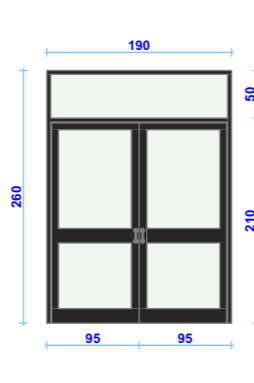
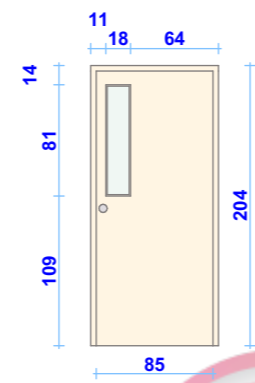
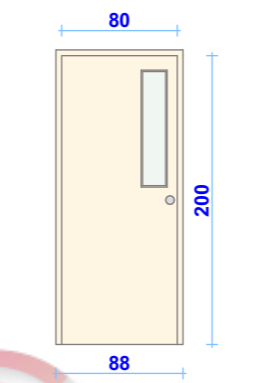
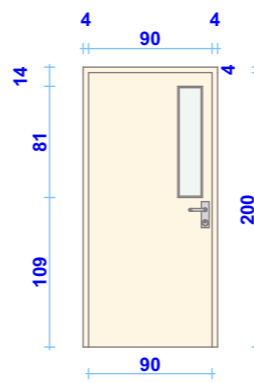
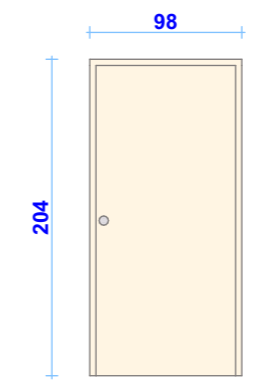
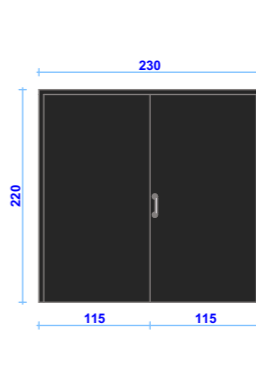
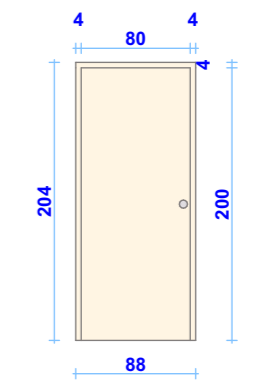
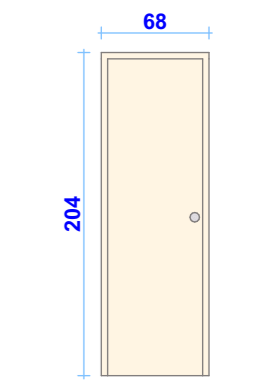
Inventari i Dyerve

ID Elementit	D-Blin	D-E	D-H	D-K	D-K	D-K	D-M	D-Met	D-T	D-T
Emeri i Carjes	Door 22	Storefront 22	Storefront Double Door, Transom 22	Door 22	Door 22	Door 22	Door 22	Garage Double Door 22	Door 22	Door 22
Sasia	1	1	1	1	5	22	1	1	6	7
Gjersi x Lartesi	90x200	95x210	190x260	85x200	80x200	90x200	90x200	230x220	80x200	60x200
Lartesia nga Baza	8	8	8	8	8	8	8	8	8	8
Lartesia Fundore	208	218	268	208	208	208	208	228	208	208
Simboli 2D										
Pamje Ballore e Hapjes										
Siperfaqia e Deres	2,01	2,00	4,94	1,90	1,80	2,00	2,00	5,06	1,80	1,39
Model	Dere e Blinduar Zyra e Drejtorit	F V vetrate d/alumini plastike me dopio xham	F V vetrate d/alumini plastike me dopio xham	F V dyer te brendeshme druri me xham te temperuar per klasat	F V dyer te brendeshme druri importi cilesi e I-re.	F V dyer te brendeshme druri me xham te temperuar per klasat	F V dyer te brendeshme druri importi cilesi e I-re.	F.V. Dyer metalike ne ambiente teknike	F V dyer te brendeshme druri importi cilesi e I-re.	Dere d/alumini pa xham, me mbushje d/a. (Tualetet)

 NJESIA E PROJEKTIT DHE INFRASTRUKTURES	OBJEKTI :RIKONSTRUKSION SHKOLLA 9 VJECARE "JUSUF PUKA"		
	VENDODHJA : DURRES, DURRES	EMER MBIEMER Ark. Adnan TOÇILA	FIRMA
	PROJEKTI : ARKITEKTURA	Ark. Oltjon GRUÇKA	EMERTIMI I FLETES : SKEMA E DYERVE
	FAZA E PROJEKTIT : PROJEKT ZBATIMI	Ing. Diana DEDJA	Ing.elek. Mariglen JAHOLLARI
			DATA 04/2019 SHKALLA Nr. I FLETES A 34

Pamje ballore porta madhe

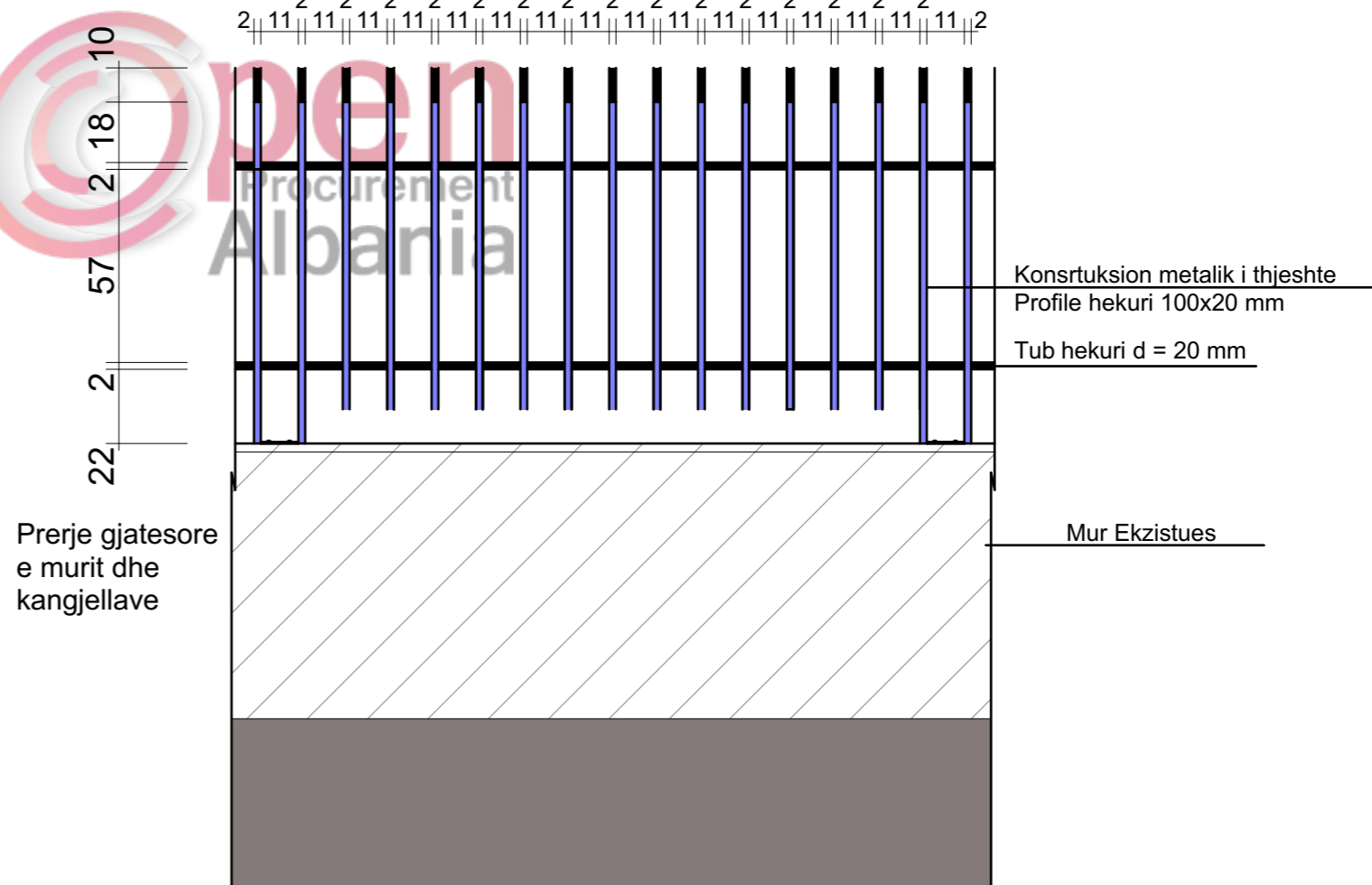
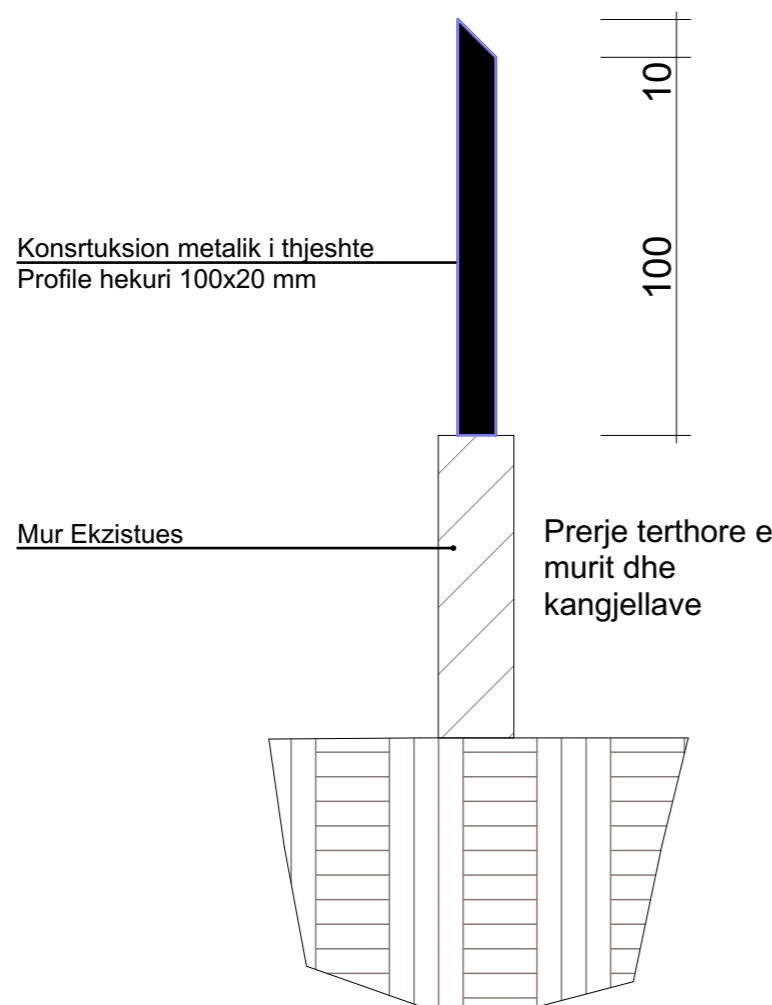
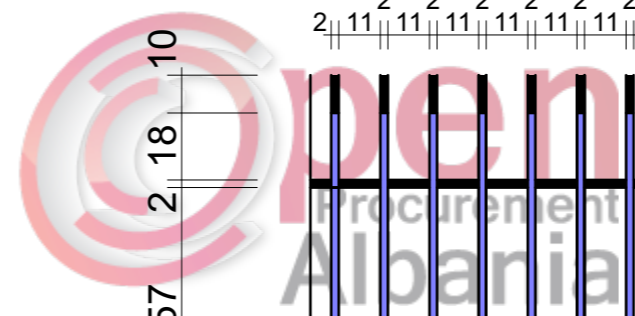
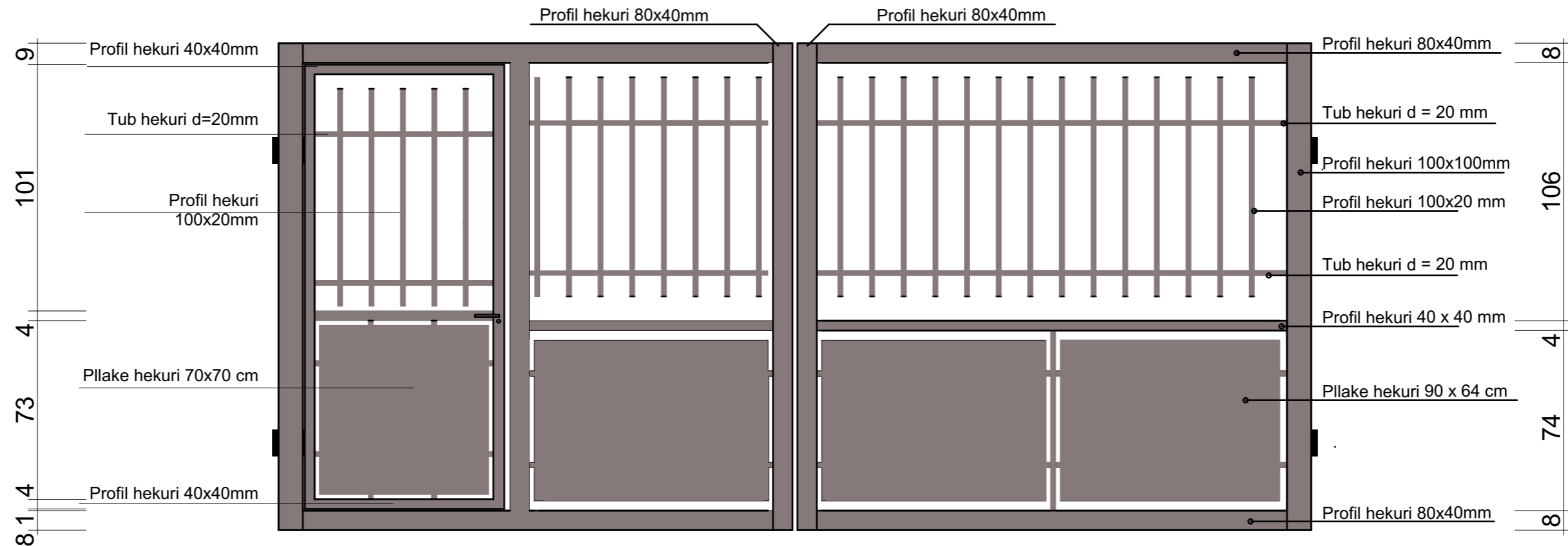

OBJEKTI :RIKONSTRUKSION SHKOLLA 9 VJECARE "JUSUF PUKA"

	VENDODHJA :	DURRES, DURRES	EMER MBIEMER	FIRMA	EMERTIMI I FLETES :	DETAILJE KANGJELLAT+PORTS HYRESE
	PROJEKTI :	ARKITEKTURA	Ark. Adnand TOÇILA	Ark. Olitjon GRUÇKA	DATA 04/2019	SHKALLA
	FAZA E PROJEKMIT :	PROJEKT ZBATIMI	Ing. Diana DEDJA	Ing.elek. Marigjen JAHOLLARI	Nr. I FLETES	A 35
	GRUPI PROJEKIMIT :					

Stola B/A Parafrabrikuar 180x45 h-50
50 cm Betonarme | Parafabrikuar

Stola B/A Parafrabrikuar 180x45 h-50
3 cm Dërrasa

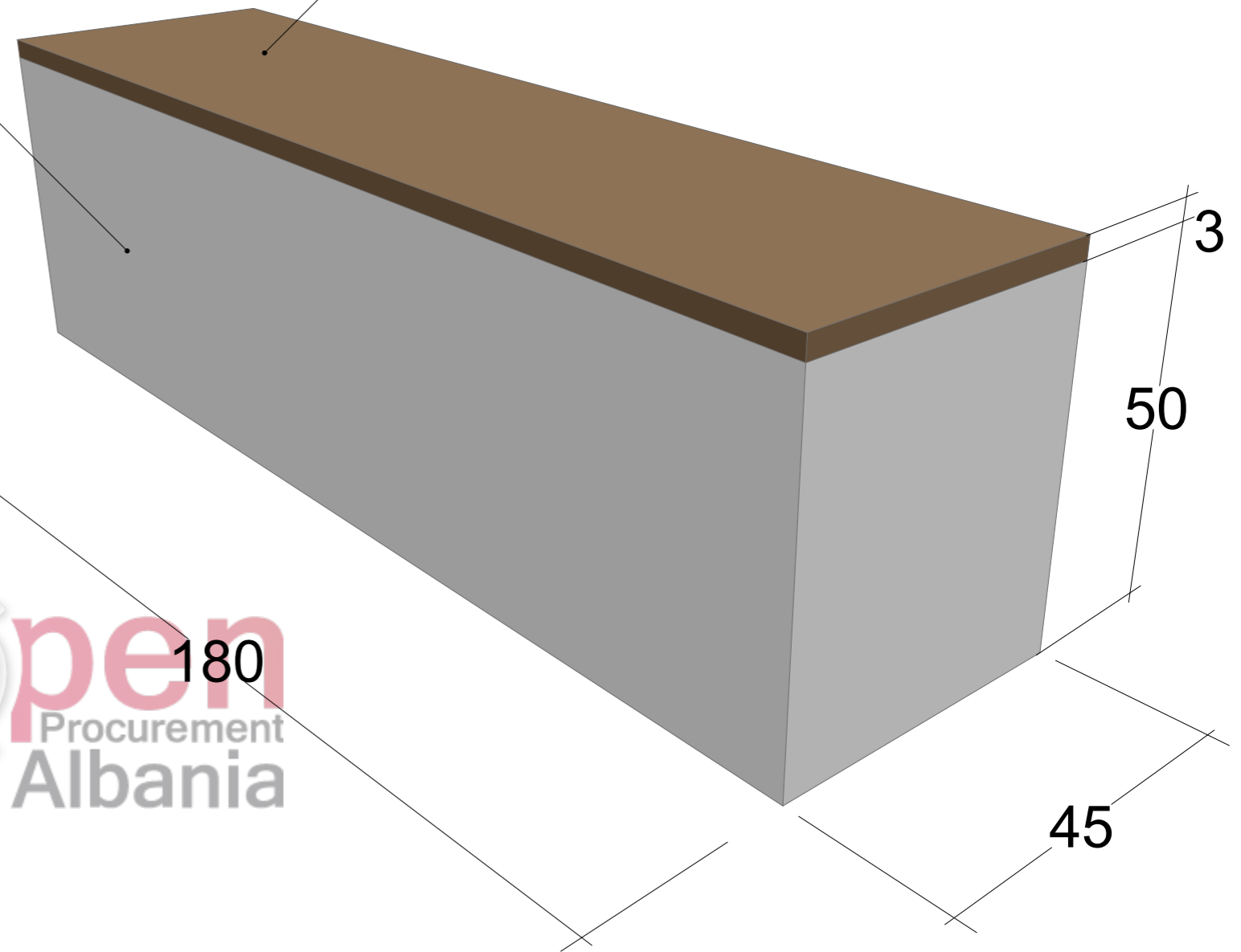
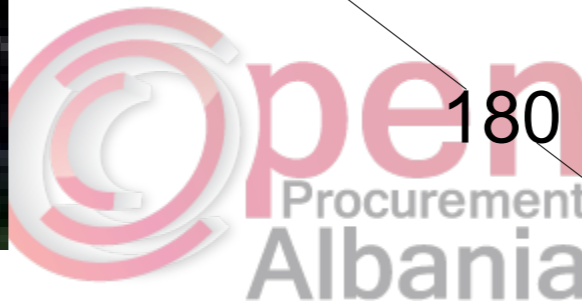

DETAJ I ARMIMIT STOLA B/A 180x45 H-50

Armimi Stolave B/A 180x45 H-50

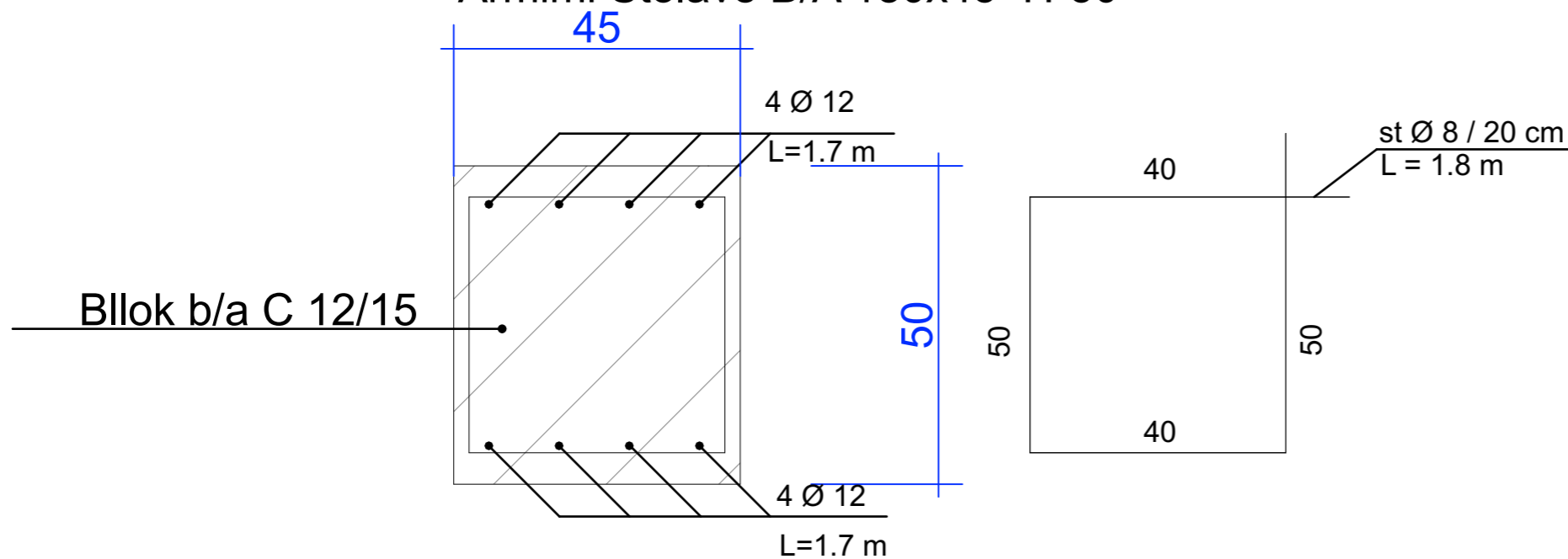

 NJESIA E PROJEKTIT DHE INFRASTRUKTURES	OBJEKTI :RIKONSTRUKSION SHKOLLA 9 VJECARE "JUSUF PUKA"		
	VENDODHJA : DURRES, DURRES	EMER MBIEMER Ark. Adnand TOÇILA Ark. Oltjon GRUÇKA Ing. Diana DEDJA Ing.elek. Mariglen JAHOLLARI	FIRMA
	PROJEKTI : ARKITEKTURA	GRUPI PROJEKTIMIT :	EMERTIMI I FLETES : STOLA B/A 180x45 H-50
	FAZA E PROJEKTIT : PROJEKT ZBATIMI	DATA 04/2019	SHKALLA Nr. I FLETES A 36



OBJEKTI :RIKONSTRUKSION SHKOLLA 9 VJECARE "JUSUF PUKA"			
 NJESIA E PROJEKTTIT DHE INFRASTRUKTURES	VENDODHJA :	EMER MBIEMER	FIRMA
	DURRES, DURRES	Ark. Adnand TOÇILA	
	PROJEKTI :	Ark. Oltjon GRUÇKA	
	ARKITEKTURA	Ing. Diana DEDJA	
FAZA E PROJEKTTIT :	Ing.elek. Mariglen JAHOLLARI		EMERTIMI I FLETES :
PROJEKT ZBATIMI			RENDER 3D
			DATA 04/2019 SHKALLA Nr. I FLETES A 37



OBJEKTI :RIKONSTRUKSION SHKOLLA 9 VJECARE "JUSUF PUKA"			
 NJESIA E PROJEKTI DHE INFRASTRUKTURES	VENDODHJA :	EMER MBIEMER	FIRMA
	DURRES, DURRES	Ark. Adnan TOÇILA	
	PROJEKTI :	Ark. Oltjon GRUÇKA	
	ARKITEKTURA	Ing. Diana DEDJA	
FAZA E PROJEKTI :	Ing.elek. Mariglen JAHOLLARI		
PROJEKT ZBATIMI			
GRUPI PROJEKTIMIT :			EMERTIMI I FLETES :
			RENDER 3D
			DATA 04/2019
			SHKALLA
			Nr. I FLETES
			A 38



OBJEKTI :RIKONSTRUKSION SHKOLLA 9 VJECARE "JUSUF PUKA"			
 NJESIA E PROJEKTTIT DHE INFRASTRUKTURES	VENDODHJA :	EMER MBIEMER	FIRMA
	DURRES, DURRES	Ark. Adnan TOÇILA	
	PROJEKTI :	Ark. Oltjon GRUÇKA	
	ARKITEKTURA	Ing. Diana DEDJA	
FAZE E PROJEKTTIT :	Ing.elek. Mariglen JAHOLLARI		
PROJEKT ZBATIMI			
GRUPI PROJEKTTIMIT :			EMERTIMI I FLETES :
			RENDER 3D
			DATA 04/2019 SHKALLA
			Nr. I FLETES A 39



 NJESIA E PROJEKTI DHE INFRASTRUKTURES	OBJEKTI :RIKONSTRUKSION SHKOLLA 9 VJECARE "JUSUF PUKA"		
	VENDODHJA : DURRES, DURRES	EMER MBIEMER Ark. Adnand TOÇILA Ark. Oltjon GRUÇKA Ing. Diana DEDJA Ing.elek. Mariglen JAHOLLARI	FIRMA
	PROJEKTI : ARKITEKTURA	GRUPI PROJEKTIMIT :	EMERTIMI I FLETES : RENDER 3D
	FAZA E PROJEKTIIT : PROJEKT ZBATIMI		DATA 04/2019 SHKALLA Nr. I FLETES A 40



NJESIA E
PROJEKTIT DHE
INFRASTRUKTURES

OBJEKTI :RIKONSTRUKSION SHKOLLA 9 VJECARE "JUSUF PUKA"

VENDODHJA :
DURRES, DURRES

PROJEKTI :
ARKITEKTURA

FAZA E PROJEKTIT :
PROJEKT ZBATIMI

GRUPI PROJEKTIMIT :

EMER MBIEMER

Ark. Adnand TOÇILA
Ark. Oltjon GRUÇKA

Ing. Diana DEDJA
Ing.elek. Mariglen JAHOLLARI

FIRMA

EMERTIMI I FLETES :

RENDER 3D

DATA 04/2019 SHKALLA

Nr. I FLETES

Ai41



 NJESIA E PROJEKTIT DHE INFRASTRUKTURES	OBJEKTI :RIKONSTRUKSION SHKOLLA 9 VJECARE "JUSUF PUKA"		
	VENDODHJA :	EMER MBIEMER	FIRMA
	DURRES, DURRES	Ark. Adnand TOÇILA	
	PROJEKTI :	Ark. Oltjon GRUÇKA	
ARKITEKTURA	Ing. Diana DEDJA		
FAZA E PROJEKTIT :	Ing.elek. Mariglen JAHOLLARI		
PROJEKT ZBATIMI			
GRUPI PROJEKTIMIT :			EMERTIMI I FLETES :
			RENDER 3D
			DATA 04/2019 SHKALLA
			Nr. I FLETES Ai42



 <p>NJESIA E PROJEKTIT DHE INFRASTRUKTURES</p>	OBJEKTI :RIKONSTRUKSION SHKOLLA 9 VJECARE "JUSUF PUKA"			
	VENDODHJA : DURRES, DURRES	EMER MBIEMER Ark. Adnan TOÇILA	FIRMA	EMERTIMI I FLETES : RENDER 3D
	PROJEKTI : ARKITEKTURA	Ark. Oltjon GRUÇKA		DATA 04/2019 SHKALLA
	FAZA E PROJEKTIT : PROJEKT ZBATIMI	Ing. Diana DEDJA	Ing.elek. Mariglen JAHOLLARI	Nr. I FLETES A 43

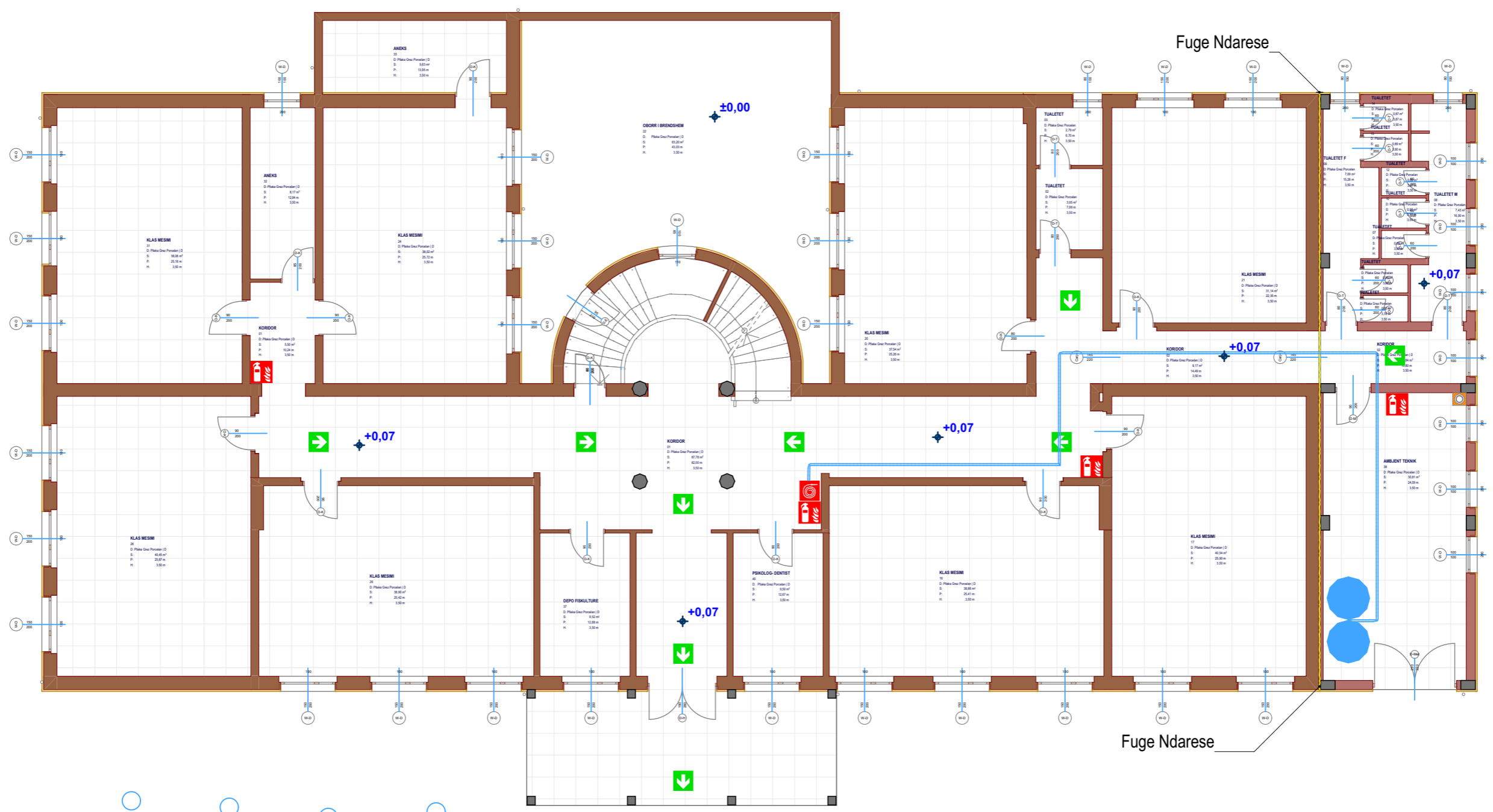
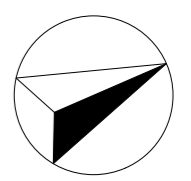

Linja me autopompen

Dysheme

rikese portative

Dysheme

hidrant

Dysheme

LEGJENDA :

- Linja e furnizimit me uje
- Linja e furnizimit me uje te hidranteve te zjarrit
- HZ Kolonat e furnizimit me uje te hidranteve te zjarrit
- Lidhja me autopompen.
- Hidrant zjarri.
- Fikse zjarri bombel
- Saraçineske

SINJALISTIKA :

- Sinjalistike lidhje me autopompen.
- Sinjalistike alarm zjarri.
- Sinjalistike hidrant zjarri.
- Drejtim dalje.
- Fikse zjarri me bombel

**NJESIA E
PROJEKTIT DHE
INFRASTRUKTURES**

OBJEKTI :RIKONSTRUKSION SHKOLLA 9 VJECARE "JUSUF PUKA"

EMERTIMI I FLETES :
PLANI I KATI PERDHE

VENDODHJA : DURRES, DURRES	EMER MBIEMER Ark. Adnand TOÇILA	FIRMA Ark. Oltjon GRUÇKA	EMERTIMI I FLETES : PLANI I KATI PERDHE
PROJEKTI : MNZ	Ing. Diana DEDJA		DATA 04/2019 SHKALLA 1:125
FAZAE PROJEKTI : PROJEKT ZBATIMI	Ing.elek. Mariglen JAHOLLARI		Nr. I FLETES Mnz11

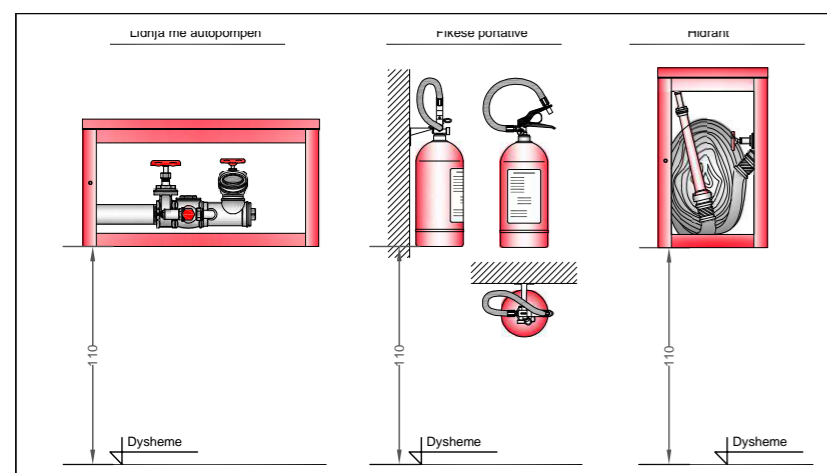
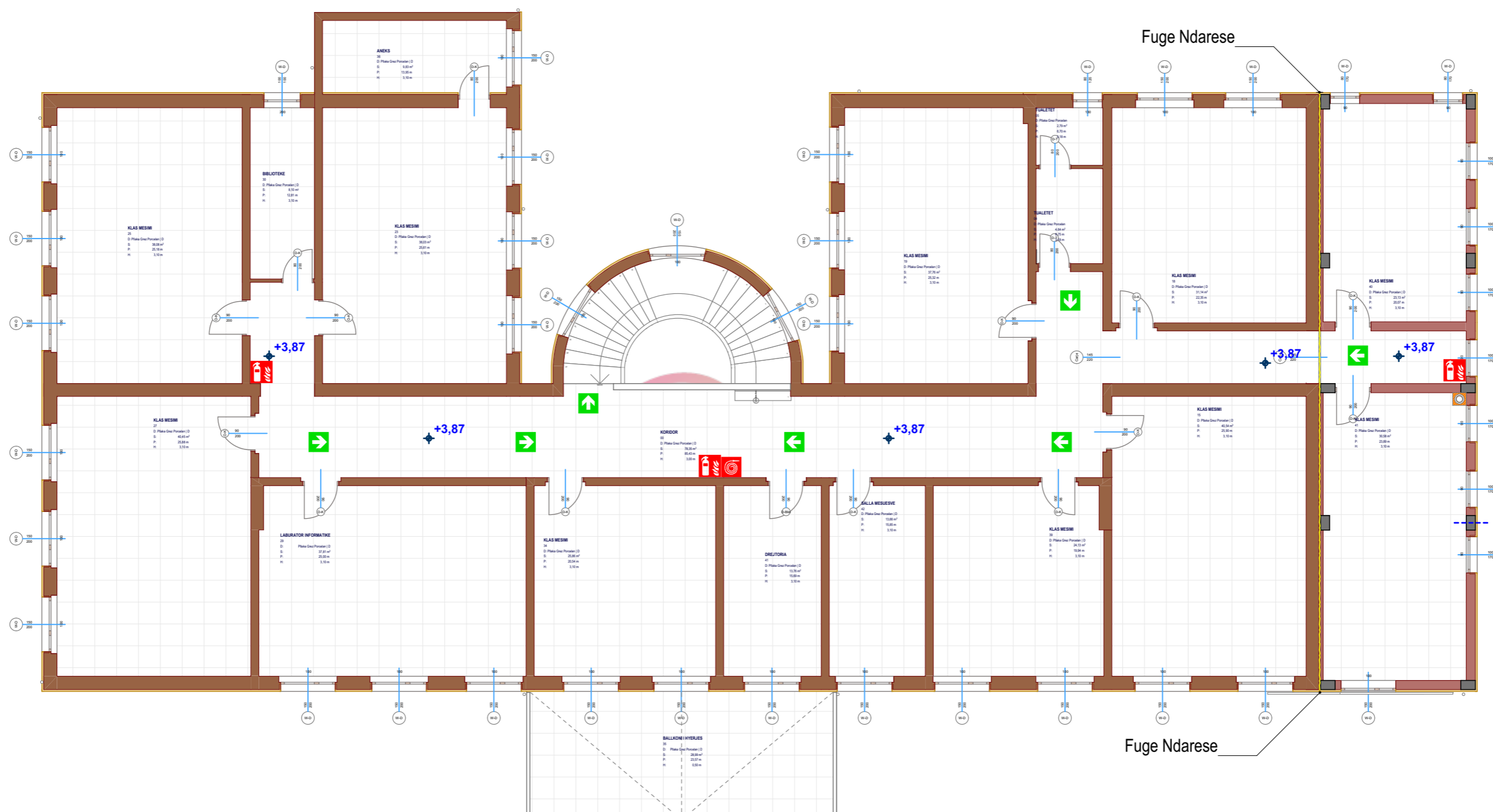
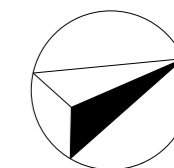

LEGJENDA :

- Linja e furnizimit me uje
- Linja e furnizimit me uje te hidranteve te zjarrit
- HZ Kolonat e furnizimit me uje te hidranteve te zjarrit
- M Lidhja me autopompen.
- H Hidrant zjarri.
- Fikse zjarri bombel
- Saraçineske

SINJALISTIKA :

- M Sinjalistike lidhje me autopompen.
- Sinjalistike alarm zjarri.
- Sinjalistike hidrant zjarri.
- ➔ Drejtim dalje.
- Fikse zjarri me bombel



NJESIA E PROJEKTIT DHE INFRASTRUKTURES

OBJEKTI :RIKONSTRUKSION SHKOLLA 9 VJECARE "JUSUF PUKA"

EMERTIMI I FLETES :
PLANI I KATI PARE

DATA 04/2019 SHKALLA 1:125
Nr. I FLETES **Mnz2**

VENDODHJA : DURRES, DURRES	EMER MBIEMER Ark. Adnand TOÇILA	FIRMA Ark. Oltjon GRUÇKA	EMERTIMI I FLETES : PLANI I KATI PARE
PROJEKTI : MNZ	GRUPI PROJEKTIMIT : Ing. Diana DEDJA Ing.elek. Mariglen JAHOLLARI		Nr. I FLETES Mnz2
FAZAE PROJEKTI : PROJEKT ZBATIMI	Ing.elek. Mariglen JAHOLLARI		

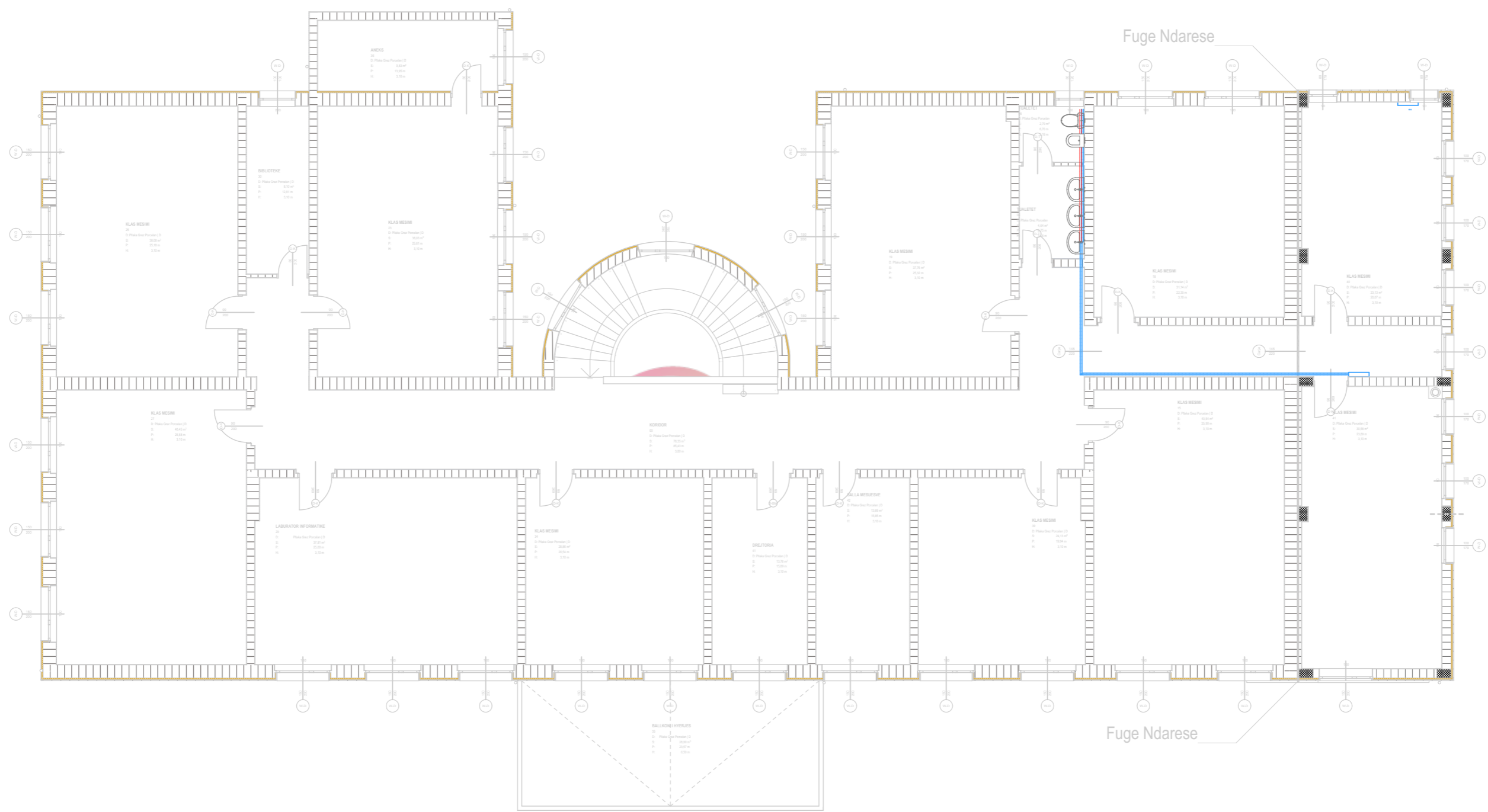
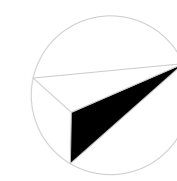

 NJESIA E PROJEKTIT DHE INFRASTRUKTURES	OBJEKTI :RIKONSTRUKSION SHKOLLA 9 VJECARE "JUSUF PUKA"		
	VENDODHJA : DURRES, DURRES	EMER MBIEMER Ark. Adnand TOÇILA Ark. Oltjon GRUÇKA Ing. Diana DEDJA Ing.elek. Mariglen JAHOLLARI	FIRMA
	PROJEKTI : MEKANIK	GRUPI PROJEKTIMIT :	EMERTIMI I FLETES : PLANI I FURNIZIMIT ME UJE KATI PARE
	FAZAE PROJEKTIT : PROJEKT ZBATIMI	DATA 04/2019 SHKALLA 1:125 Nr. I FLETES Mek1	

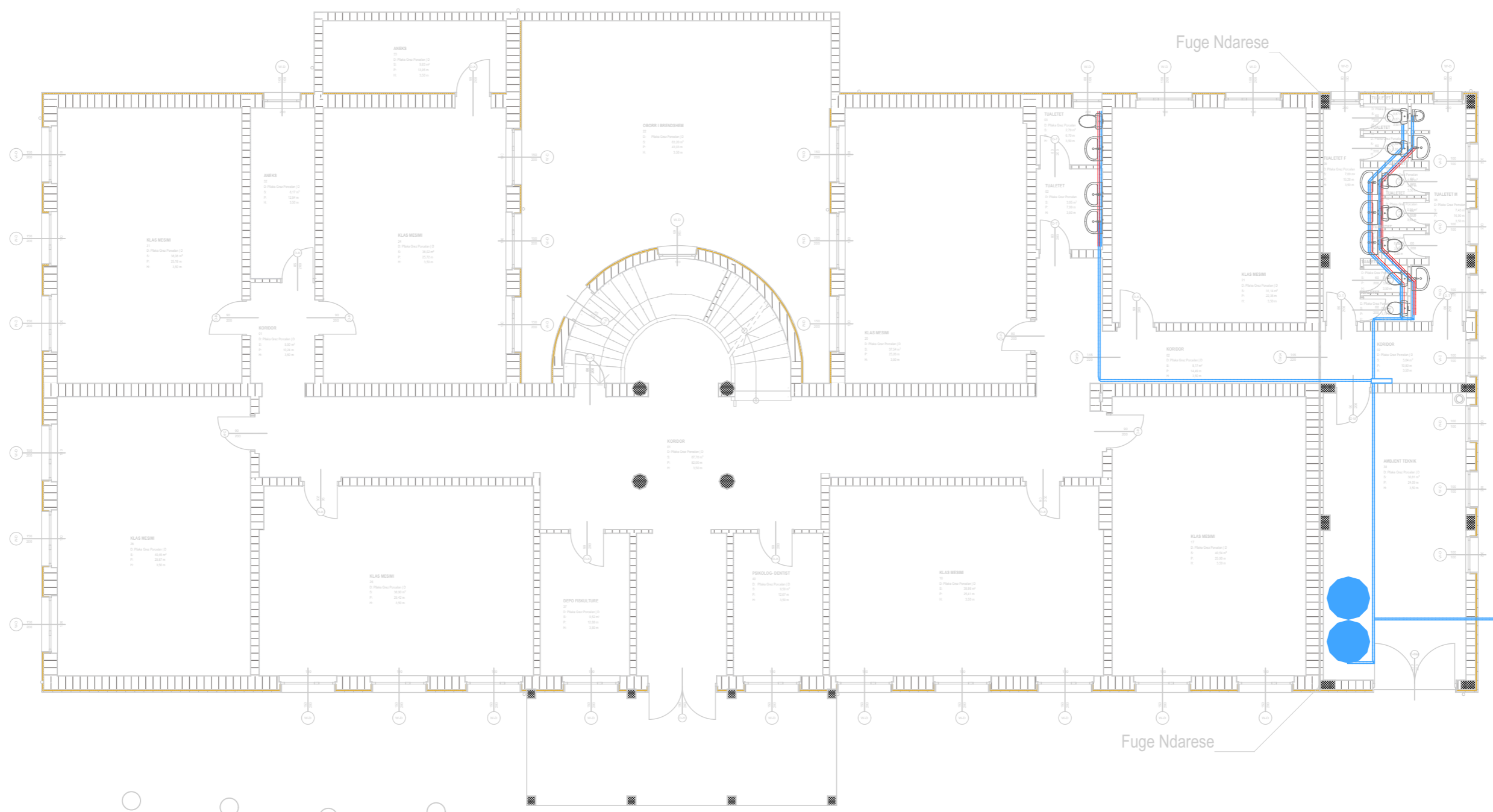
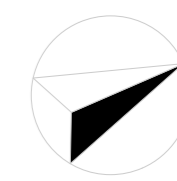

 NJESIA E PROJEKTIT DHE INFRASTRUKTURES	OBJEKTI :RIKONSTRUKSION SHKOLLA 9 VJECARE "JUSUF PUKA"			
	VENDODHJA : DURRES, DURRES	GRUPI PROJEKTIMIT :	EMER MBIEMER Ark. Adnand TOÇILA	FIRMA
	PROJEKTI : MEKANIK		Ark. Oltjon GRUÇKA	
	FAZAE PROJEKTIT : PROJEKT ZBATIMI		Ing. Diana DEDJA	
		Ing.elek. Mariglen JAHOLLARI	EMERTIMI I FLETES : PLANI I FURNIZIMIT ME UJE KATI PERDHE	
			DATA 04/2019 SHKALLA 1:125	
			Nr. I FLETES	Meki2

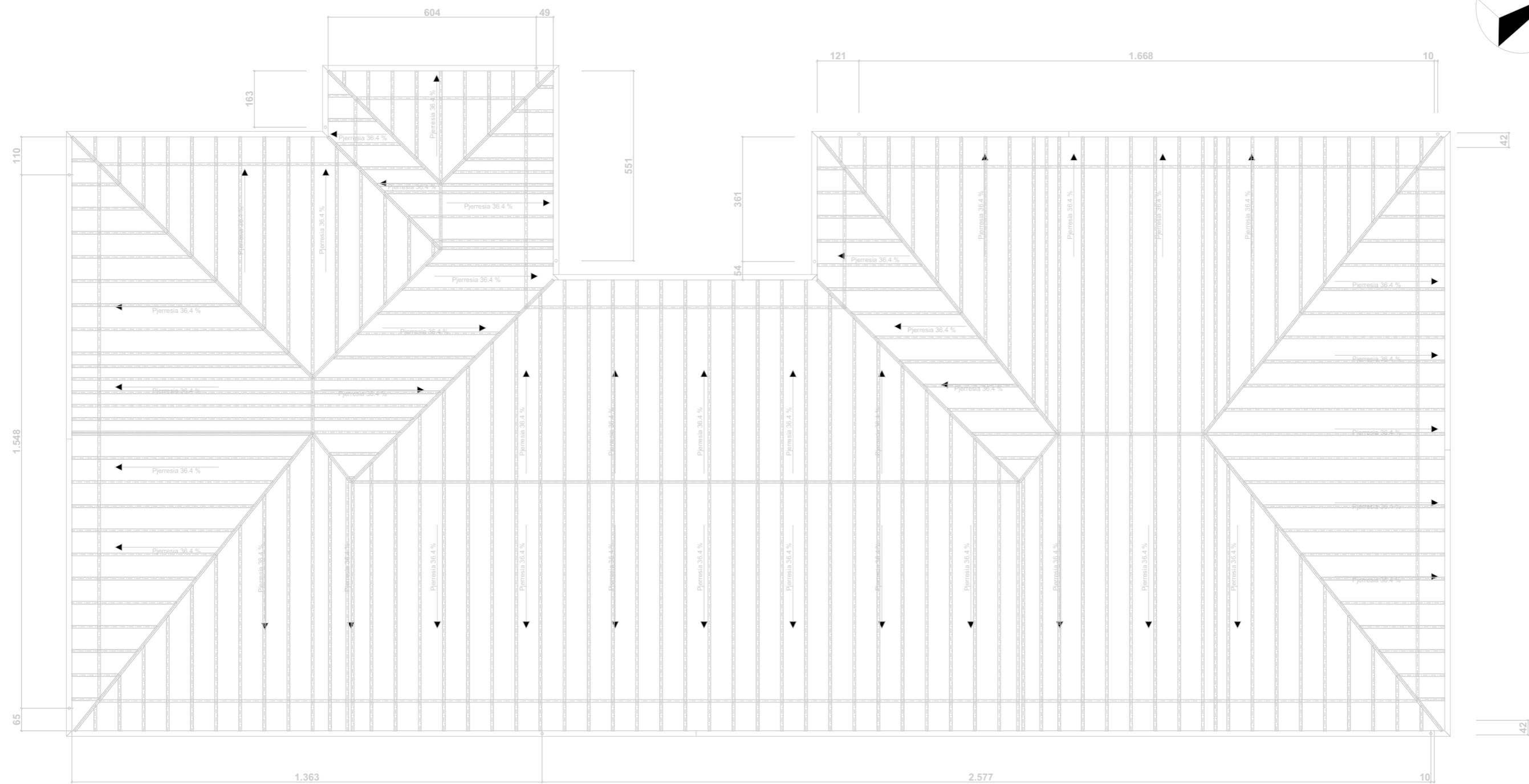

NJESIA E
PROJEKTIT DHE
INFRASTRUKTURES

OBJEKTI :RIKONSTRUKSION SHKOLLA 9 VJECARE "JUSUF PUKA"

VENDODHJA :
DURRES, DURRES

PROJEKTI :
MEKANIK

FAZAE PROJEKTIT :
PROJEKT ZBATIMI

GRUPI PROJEKTIMIT :

EMER MBIEMER
Ark. Adnand TOÇILA
Ark. Oltjon GRUÇKA
Ing. Diana DEDJA
Ing.elek. Mariglen JAHOLLARI

FIRMA

EMERTIMI I FLETES :
PLANI I SHKARKIMEVE I CATISE

DATA 04/2019 SHKALLA

Nr. I FLETES

Meki3

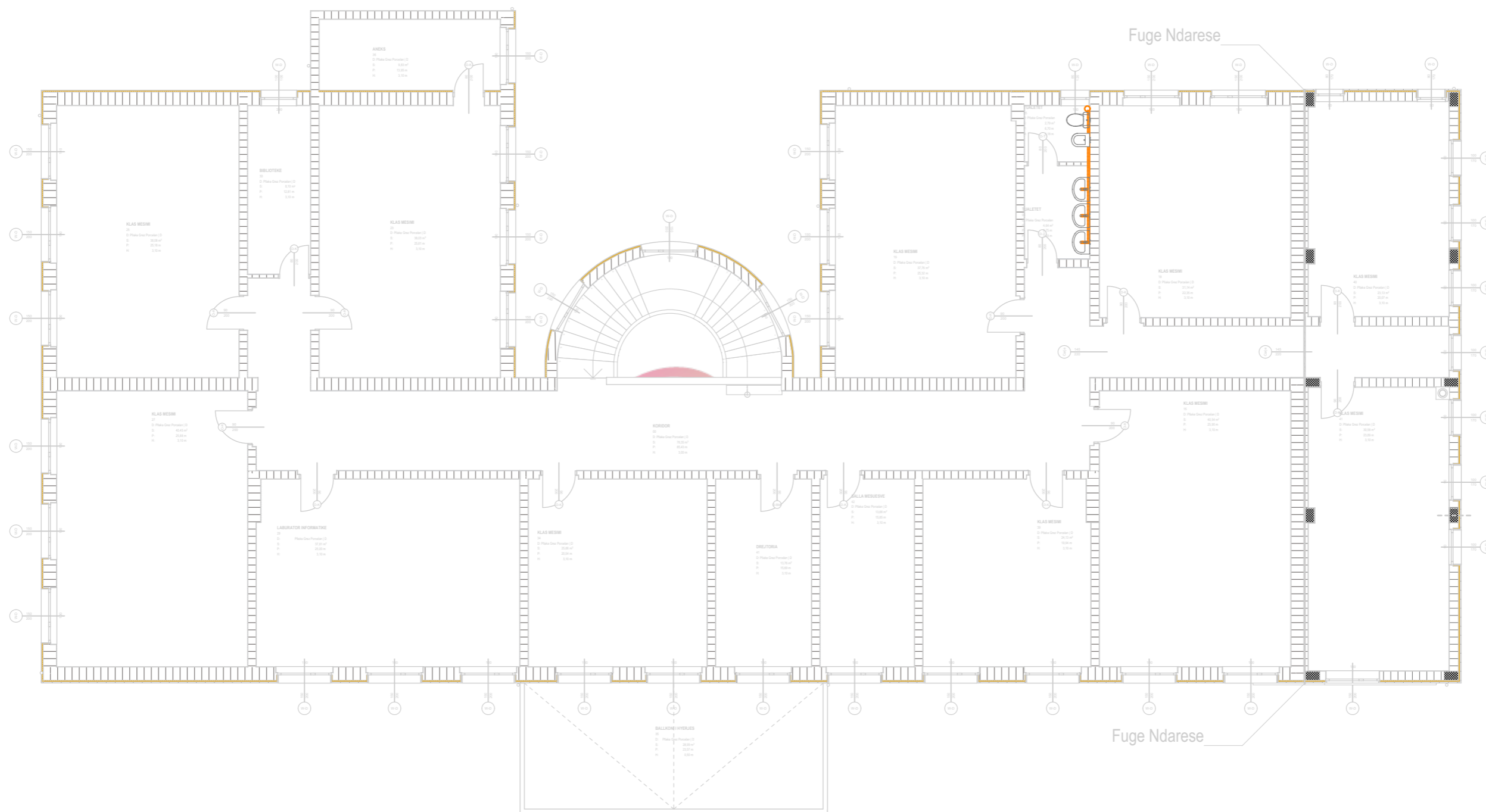
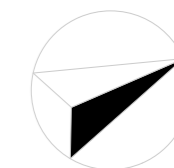

<p>NJËSIA E PROJEKTIT DHE INFRASTRUKTURES</p>	OBJEKTI :RIKONSTRUKSION SHKOLLA 9 VJECARE "JUSUF PUKA"		
	VENDODHJA : DURRES, DURRES	GRUPI PROJEKTIMIT : EMER MBIEMER ARK. Adnand TOÇILA ARK. Oltjon GRUÇKA Ing. Diana DEDJA Ing.elek. Mariglen JAHOLLARI	FIRMA
	PROJEKTI : MEKANIK		
	FAZA E PROJEKTIT : PROJEKT ZBATIMI	DATA 04/2019 SHKALLA	Nr. I FLETES

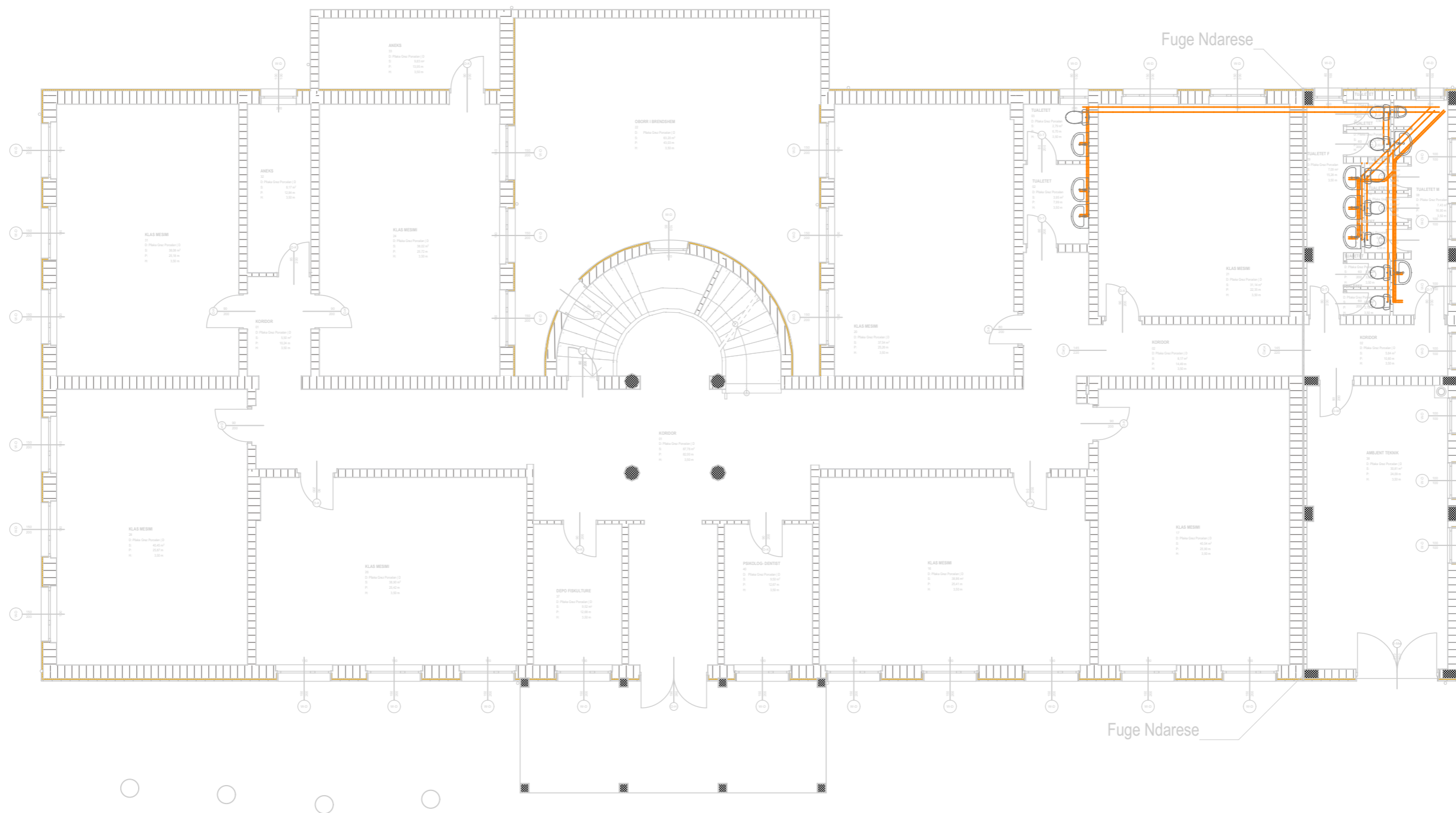
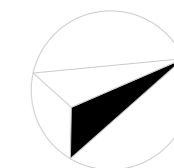

<p>NJESIA E PROJEKTIT DHE INFRASTRUKTURES</p>	OBJEKTI :RIKONSTRUKSION SHKOLLA 9 VJECARE "JUSUF PUKA"		
	VENDODHJA : DURRES, DURRES	EMER MBIEMER Ark. Adnand TOÇILA Ark. Oltjon GRUÇKA Ing. Diana DEDJA Ing.elek. Mariglen JAHOLLARI	FIRMA
	PROJEKTI : MEKANIK		
	FAZAE PROJEKTIT : PROJEKT ZBATIMI	GRUPI PROJEKTIMIT :	EMERTIMI I FLETES : PLANI I SHKARKIMEVE KATI PERDHE
		DATA 04/2019 SHKALLA	Nr. I FLETES Mek5

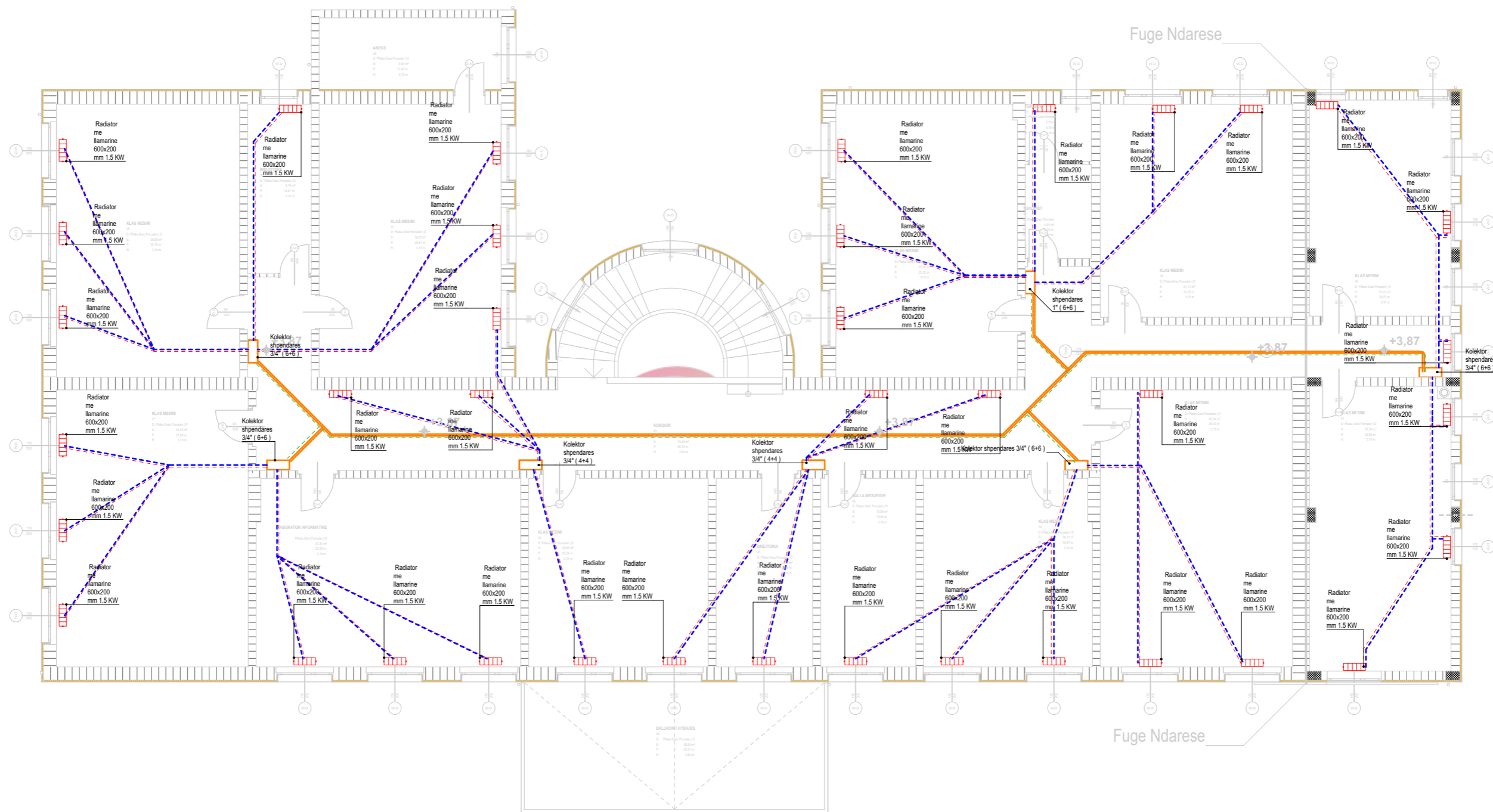
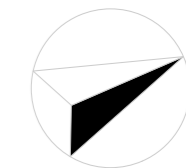

 NJESIA E PROJEKTIT DHE INFRASTRUKTURES	OBJEKTI :RIKONSTRUKSION SHKOLLA 9 VJECARE "JUSUF PUKA"		
	VENDODHJA :	EMER MBIEMER	FIRMA
	DURRES, DURRES	Ark. Adnand TOÇILA	
	PROJEKTI :	Ark. Oltjon GRUÇKA	
MEKANIK	Ing. Diana DEDJA		
FAZAE PROJEKTIT :	Ing.elek. Mariglen JAHOLLARI		
PROJEKT ZBATIMI			
GRUPI PROJEKTIMIT :	EMERTIMI I FLETES :		
	PLANI I KATI PARE NGROHJA		
	DATA 04/2019	SHKALLA	
	Nr. I FLETES	Meki6	

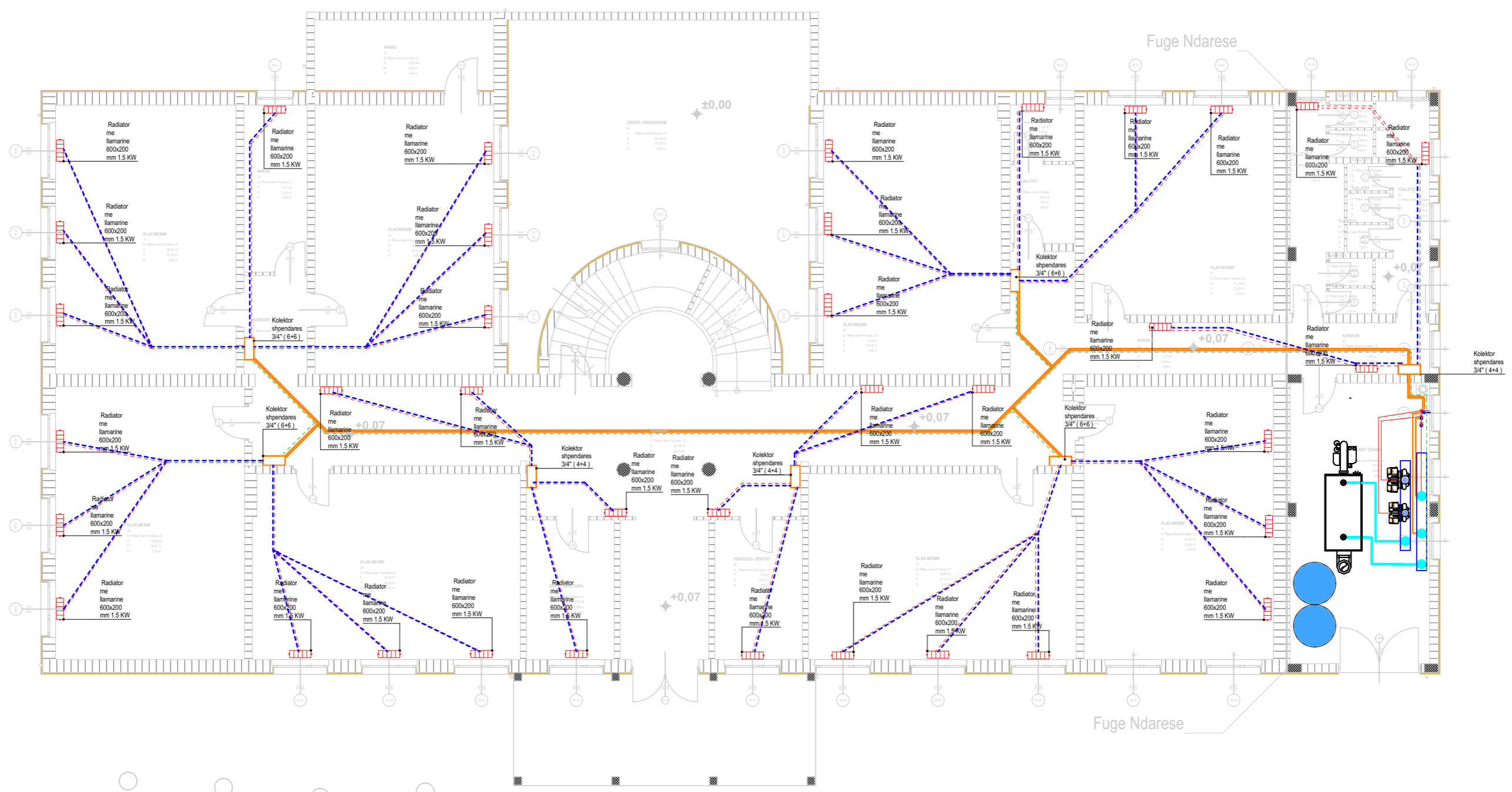
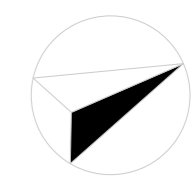

 <p>NJESIA E PROJEKTIT DHE INFRASTRUKTURES</p>	OBJEKTI :RIKONSTRUKSION SHKOLLA 9 VJECARE "JUSUF PUKA"			
	VENDODHJA : DURRES, DURRES	EMER MBIEMER Ark. Adnand TOÇILA	FIRMA	EMERTIMI I FLETES : PLANI I KATI PERDHE NGROHJA
	PROJEKTI : MEKANIK	Ark. Oltjon GRUÇKA		DATA 04/2019 SHKALLA
	FAZAE PROJEKTIT : PROJEKT ZBATIMI	Ing. Diana DEDJA		Nr. I FLETES
	GRUPI PROJEKTIMIT :	Ing.elek. Mariglen JAHOLLARI	Mek7	

ZERAT E PUNES		MUAJT TE NDARE NE 10 DITOR			MUAJT TE NDARE NE 10 DITOR			MUAJT TE NDARE NE 10 DITOR			MUAJT TE NDARE NE 10 DITOR			MUAJT TE NDARE NE 10 DITOR		
NR	Pershkrimi i Punimeve	MUAJI I			MUAJI II			MUAJI III			MUAJI IV			MUAJI V		
		10	10	10	10	10	10	10	10	10	10	10	10	10	10	
	Punime Ndetimore Shkolla															
1	Punime prishje dhe cmontimi	[Red bar]														
2	Punime dheu		[Red bar]													
3	Punime betoni dhe betonarme/hekur betoni		[Red bar]													
4	Punime murature			[Red bar]												
5	Punime catie				[Red bar]											
6	Punime shtresash					[Red bar]										
7	Punime dritare dhe dyer							[Red bar]								
8	Punime suvatimi dhe veshje								[Red bar]							
10	Punime Ndertimi Sheshi Perpara Shkolles															
11	Punime dheu dhe mbushje								[Red bar]							
12	Punime shtresash									[Red bar]						
13	Punime betoni dhe betonarme/hekur betoni											[Red bar]				
14	Punime rrehtimi/gjelberimi												[Red bar]			
15	Pajisje sportive														[Red bar]	
16	Punime instalime Elektrike											[Blue bar]				
17	Punime instalime Mekanike											[Yellow bar]				
18	Punime instalime Mnz											[Red bar]				

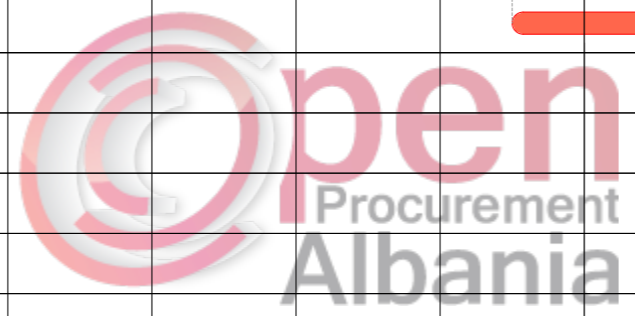

<p>NJESIA E PROJEKTIT DHE INFRASTRUKTURES</p>	OBJEKTI :RIKONSTRUKSION SHKOLLA 9 VJECARE "JUSUF PUKA"			
	VENDODHJA : DURRES, DURRES	EMER MBIEMER Ark. Adnand TOÇILA	FIRMA Ark. Oltjon GRUÇKA	EMERTIMI I FLETES : GRAFIK PUNIMESH 5 MUAJ
	PROJEKTI : ARKITEKTURA	FAZA E PROJEKTIT : PROJEKT ZBATIMI	Ing. Diana DEDJA Ing.elek. Mariglen JAHOLLARI	DATA 04/2019 SHKALLA Nr. I FLETES A



RIKONSTRUKSION SHKOLLA "JUSUF PUKA"

PLANIMETRIA E PLINTAVE TË SHITESES ANËSORE

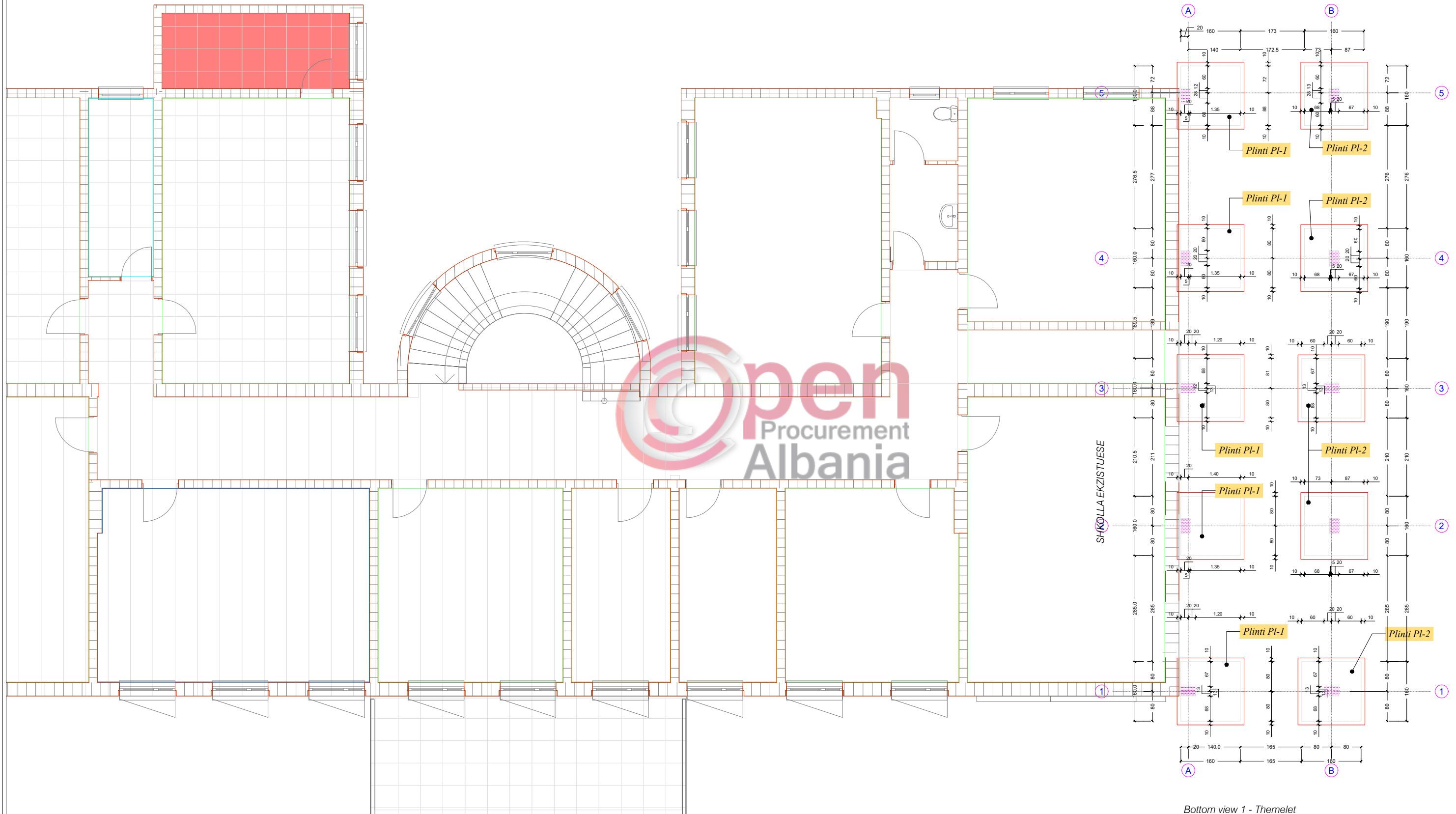
Sh 1:100



Bottom view 1 - Themelet



 BASHKIA DURRES	OBJEKTI: "RIKONSTRUKSION SHKOLLA "JUSUF PUKA"		EMERTIMI I FLETES : PLANIMETRIA E PLINTAVE TE SHITESES ANËSORE		
	VENDODHJA : DURRES	PROJEKTI :KONSTRUKTIV	EMER MBIEMER Ark. Adnand Toçila Ark.Oltion Gruçka Ing.Diana Dedja	FIRMA	DATA . . . 2019
NJESIA E PROJEKTIT DHE INFRASTRUKTURES	FAZA E PROJEKTIT : PROJEKT ZBATIMI	GRUPI PROJEKTIMIT :	SHKALLA 1:100 No. 1 FLETES		
			K-01		

RIKONSTRUKSION SHKOLLA "JUSUF PUKA"

PLANIMETRIA E PLINTAVE TË SHITESES ANËSORE AKSI 1 DERI AKSI 3 SHK 1:50

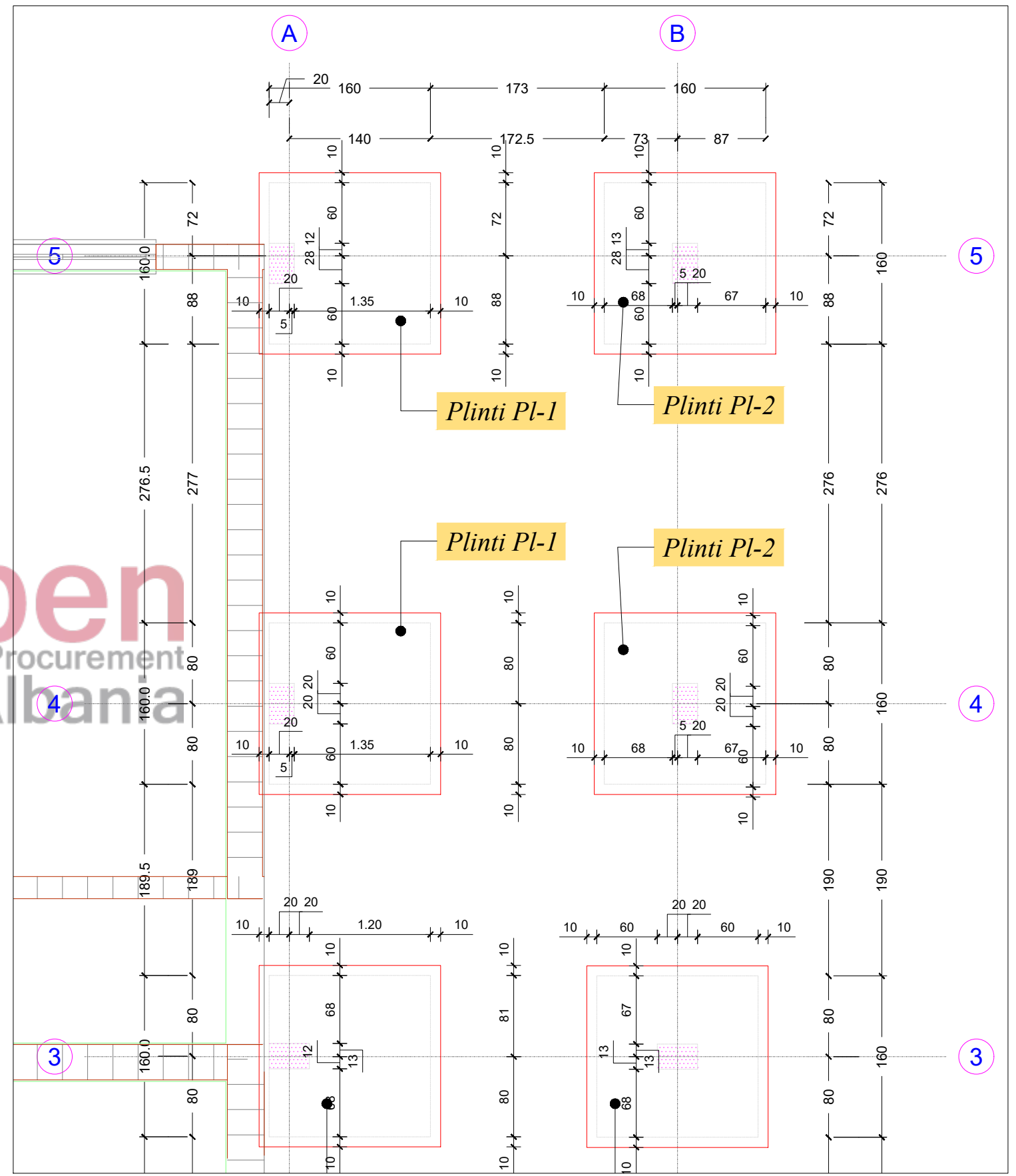
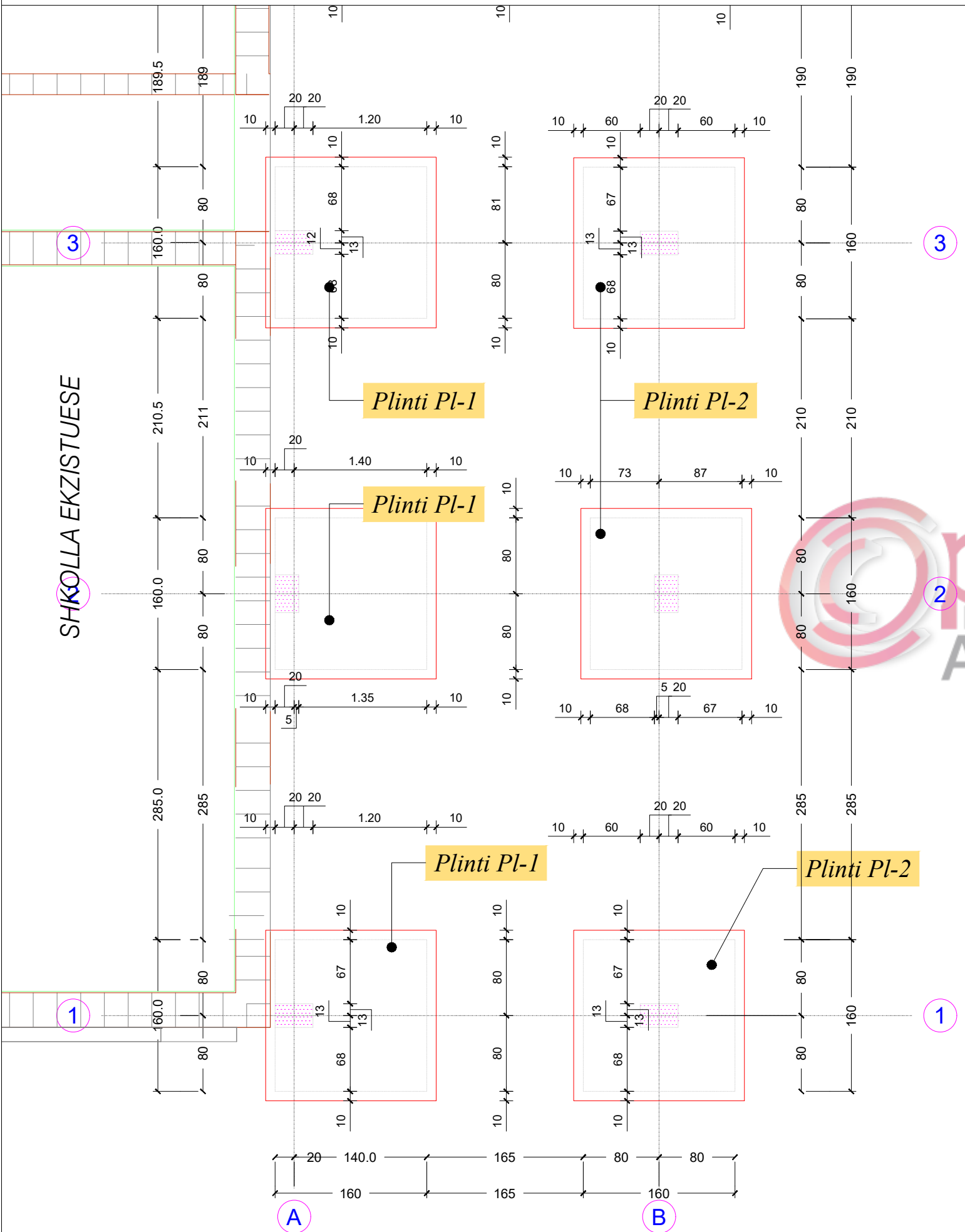
PLANIMETRIA E PLINTAVE TË SHITESES ANËSORE AKSI 3 DERI AKSI 5 SHK 1:50



 <p>BASHKIA DURRES</p>	<p>OBJEKTI: "RIKONSTRUKSION SHKOLLA "JUSUF PUKA"</p>		<p>EMERTIMI I FLETES:</p>	
	<p>VENDODHJA : DURRES</p>		<p>PLANIMETRIA E PLINTAVE TË SHITESES ANËSORE</p>	
	<p>PROJEKTI : KONSTRUKTIV</p>		<p>DATA . . . 2019 SHKALLA 1:50</p>	
	<p>FAZA E PROJEKTIT : PROJEKT ZBATIMI</p>		<p>No. 1 FLETES K-02</p>	
<p>GRUPI PROJEKTIMIT:</p>		<p>EMER MBIEMER</p>	<p>FIRMA</p>	
<p>PROJEKTI: KONSTRUKTIV</p>		<p>Ark. Adnand Toçila</p>	<p>Ark.Oltion Gruçka</p>	
<p>FAZA E PROJEKTIT : PROJEKT ZBATIMI</p>		<p>Ing.Diana Dedja</p>		

ARMIMI I PLINTIT PL-1 SHK 1:30
(COPE 5)

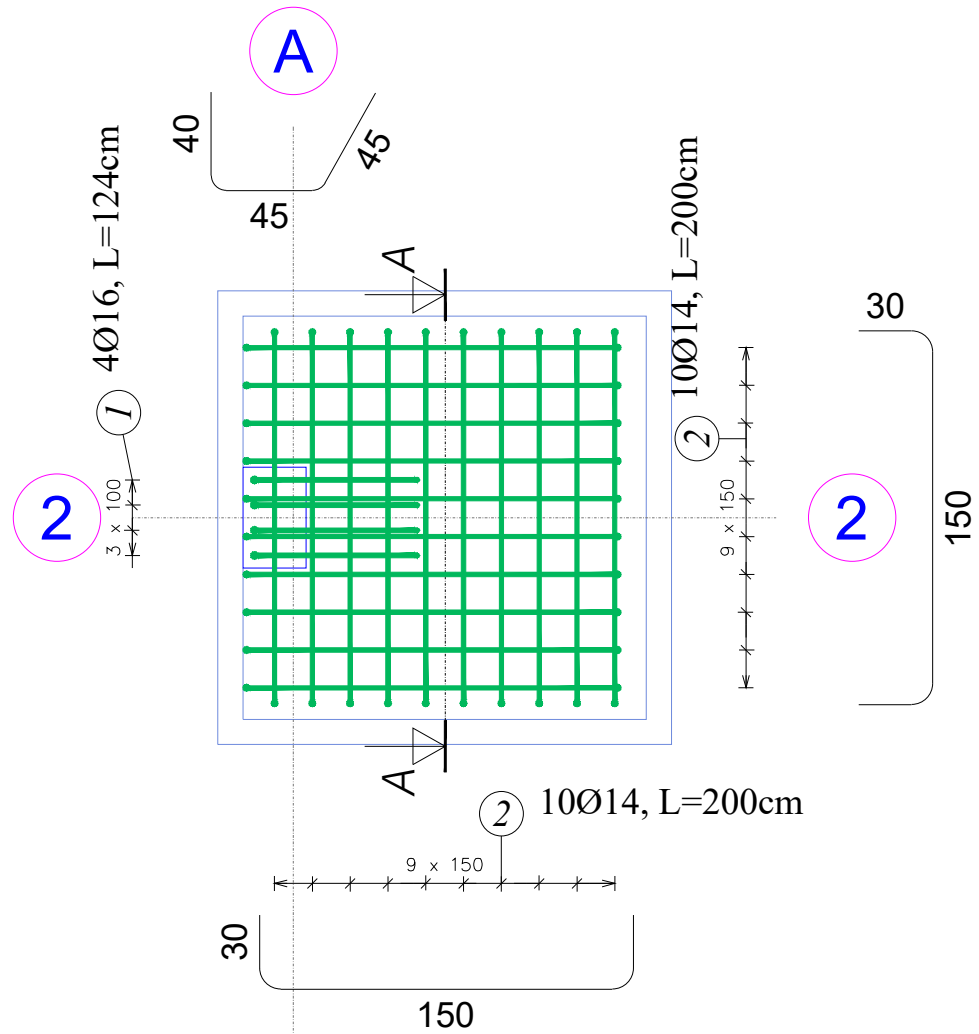

Autodesk* TABELA E HEKURIT PLINTI PL-1						
Nr	Tipi	Sasia	Dimensioni (cm)	Pesha (kg)	Pesha Totale (kg)	Skema
1	HA16	20	124	1.96	39.18	
2	HA14	100	200	2.42	242.00	
Shuma pesha (kg)					281.18	

Autodesk* TABELA E HEKURIT PLINTI PL-2						
Nr	Tipi	Sasia	Dimensioni (cm)	Pesha (kg)	Pesha Totale (kg)	Skema
1	HA14	100	200	2.42	242.00	
2	HA16	20	116	1.83	36.66	
Shuma pesha (kg)					278.66	

PAMJE 3-D E PL-1
SHK 1:30

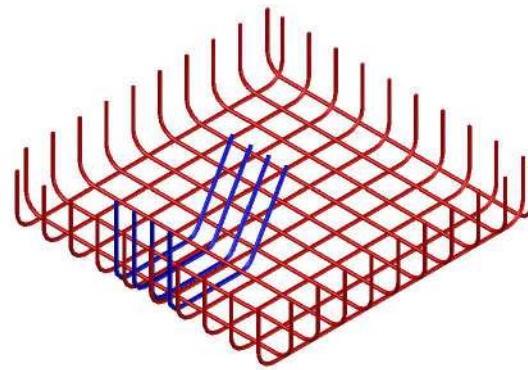

PAMJE 3-D E PL-2
SHK 1:30

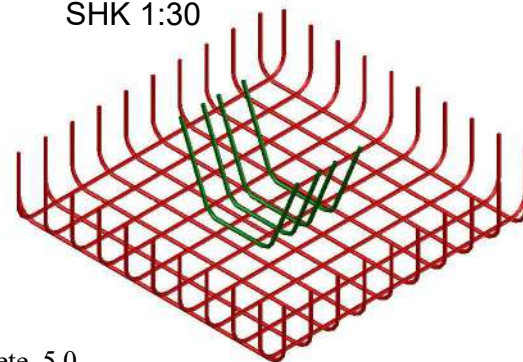

ARMIMI I PLINTIT PL-2 SHK 1:30
(COPE 5)

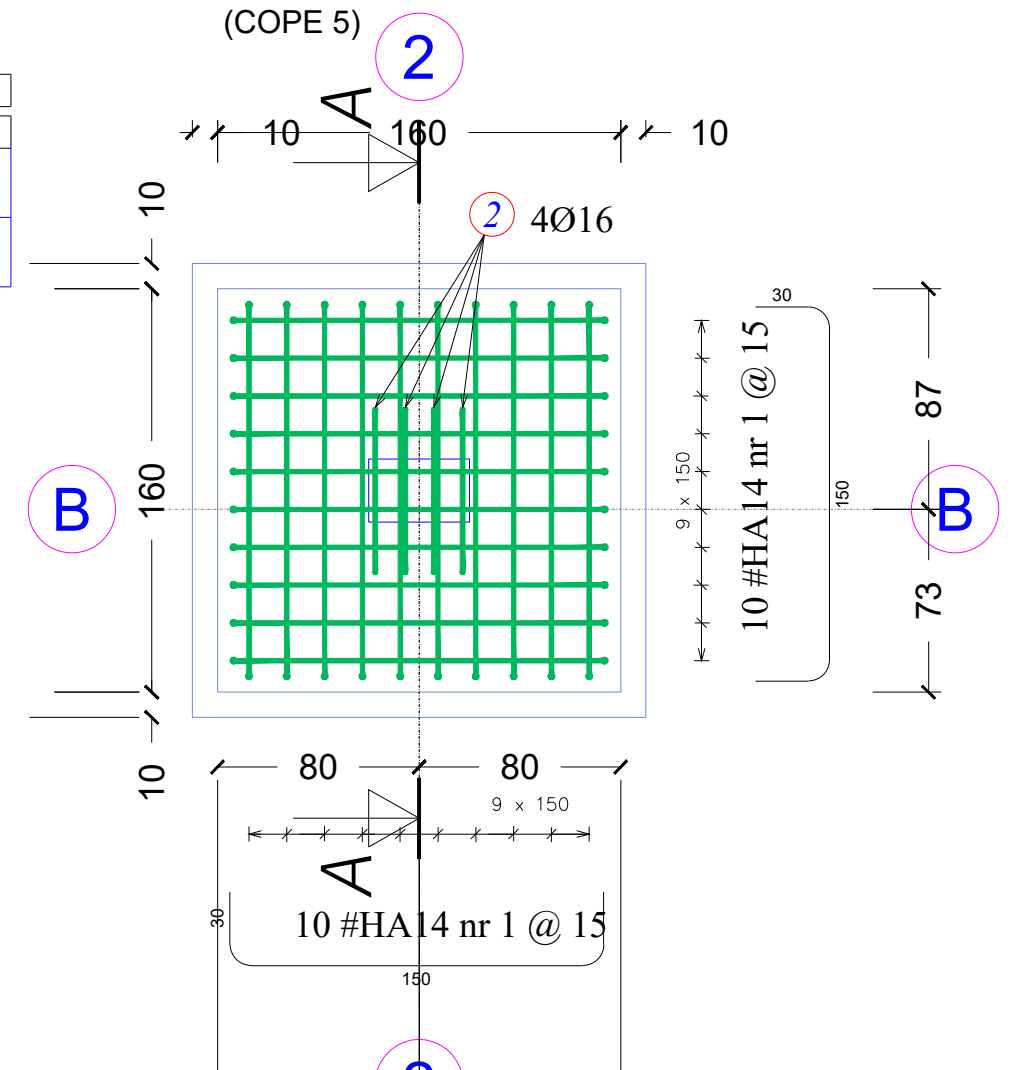

Prerja A-A
SHK 1:30

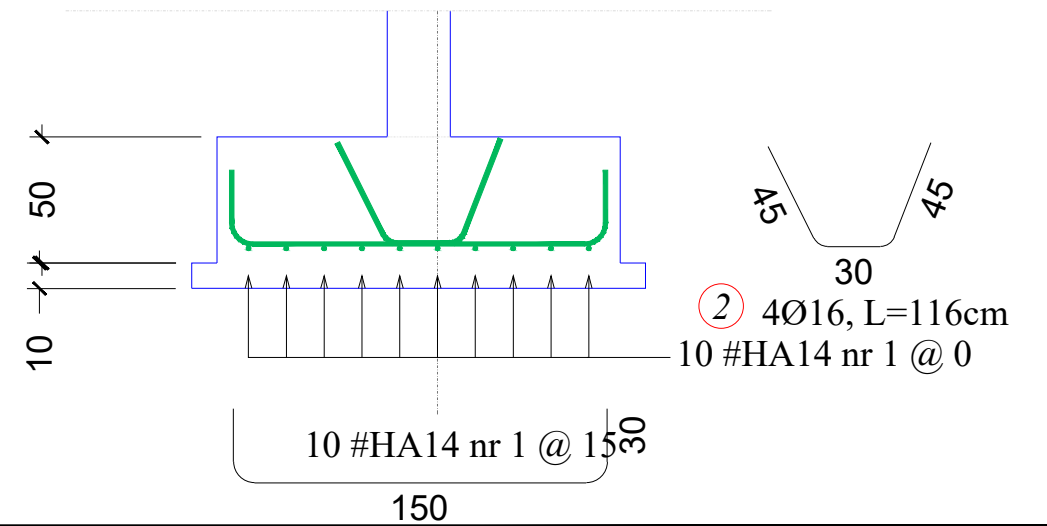

- SHENIME:
1. BETONI I PLINTIT M-250 (C20/25)
 2. ÇELIK FeB44 ME Ra>3700kg/cm
 3. Shtresa mbrojtëse e hekurit per plintin do te jete 5.0 cm

BASHKIA DURRES		OBJEKTI: RIKONSTRUKSION SHKOLLA "JUSUF PUKA"	
		VENDODHJA : DURRES	EMERTIMI I FLETES : ARMIMI I PLINTIT PL-1, PL-2
PROJEKTI : KONSTRUKTIV	EMER MBIEMER : Ark. Adnand Toçila	FIRMA :	DATA : . . . 2019
FAZA E PROJEKTTIT : PROJEKT ZBATIMI	Ark. Oltion Gruçka	No. I FLETES : K-03	
	Ing. Diana Dedja		

RIKONSTRUKSION SHKOLLA "JUSUF PUKA"



PLANIMETRIA E SOLETË NË KATIN PËRDHE TË SHITESES ANËSORE

KUOTA ±0.00

PRERJA A-A SHK 1:50

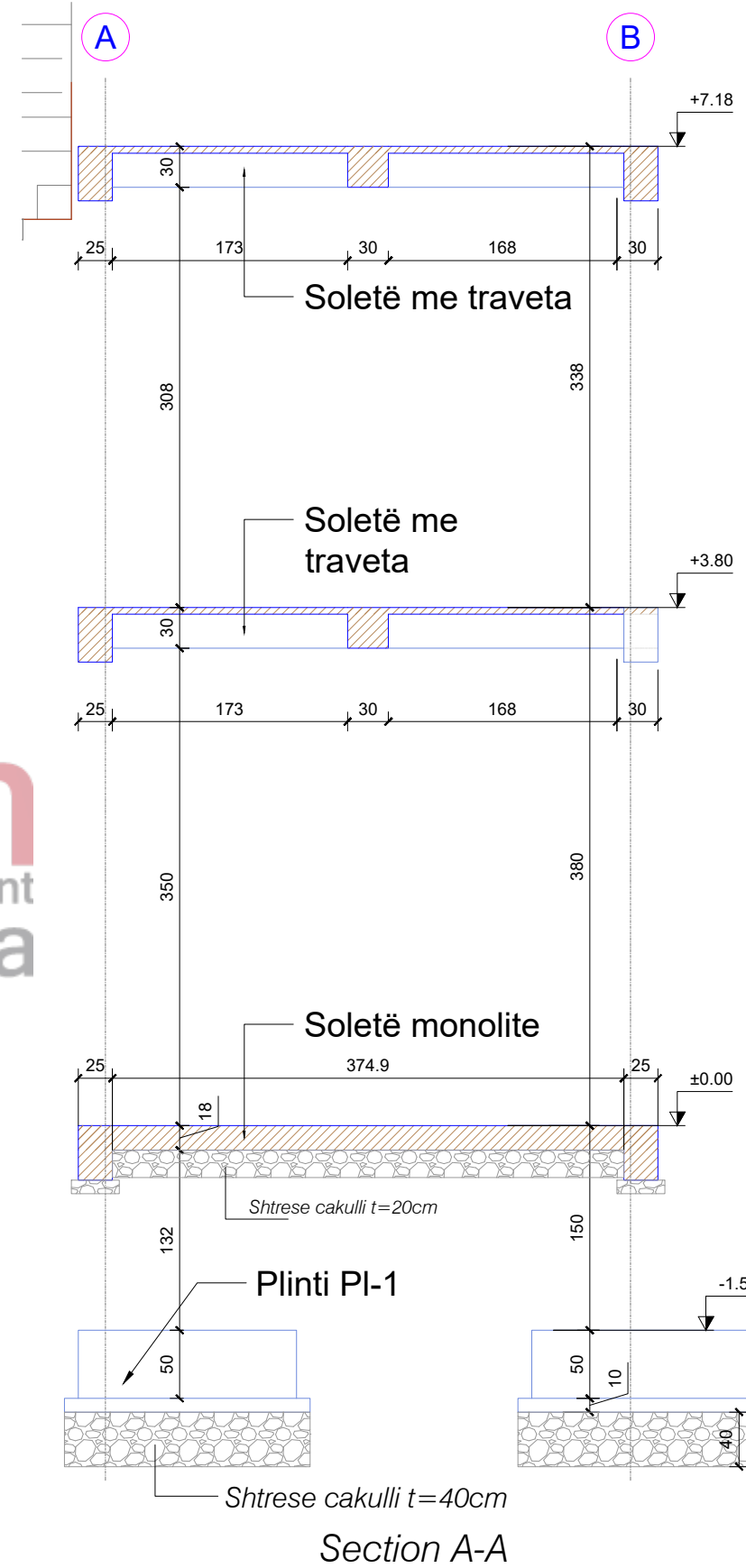
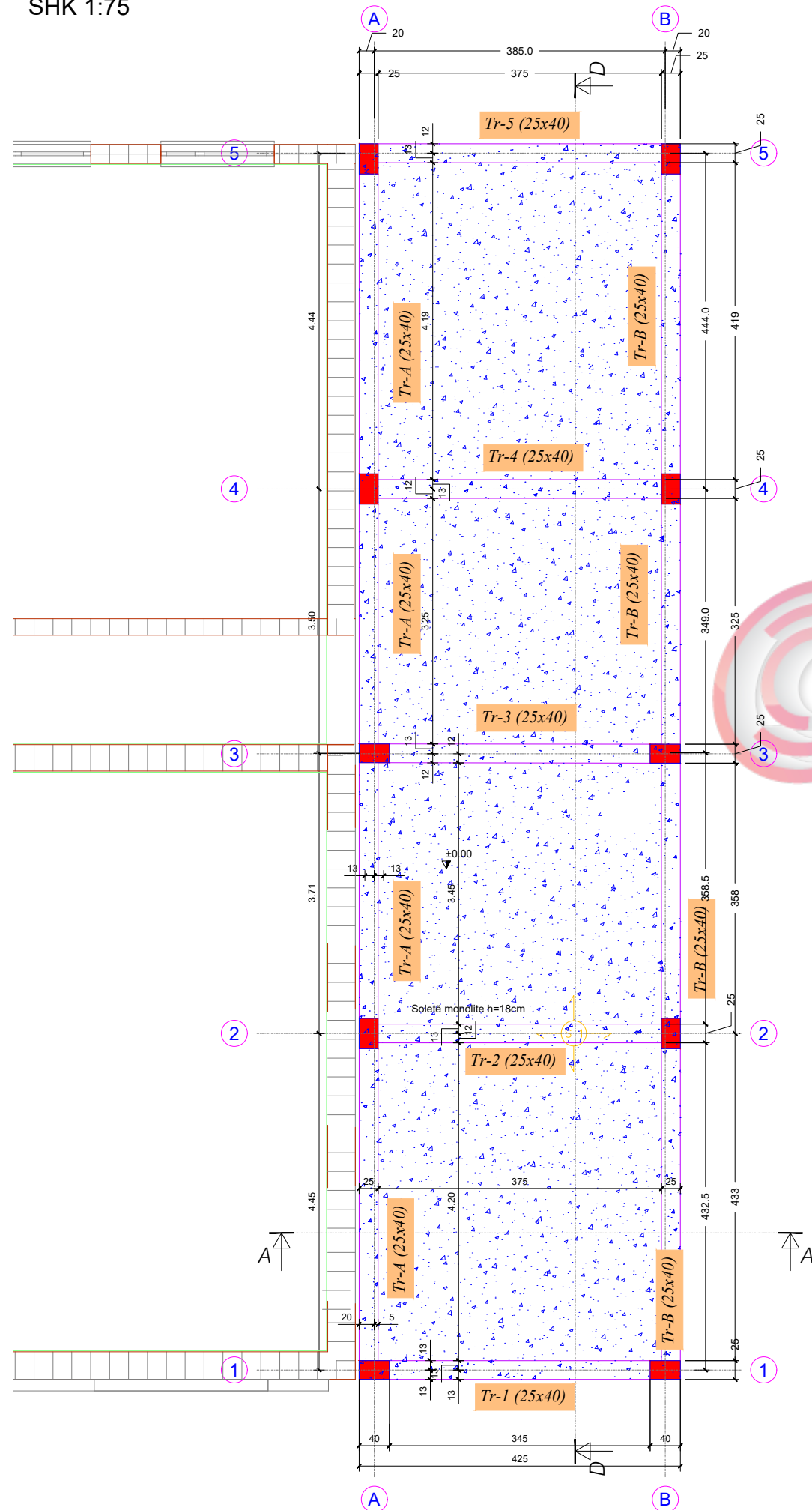
SHK 1:75



 BASHKIA DURRES N J E S I A E PROJEKTIT DHE INFRASTRUKTURES	OBJEKTI: "RIKONSTRUKSION SHKOLLA "JUSUF PUKA"		EMERTIMI I FLETES : PLANIMETRIA E SOLETË NË KATIN PËRDHE TË SHITESES ANËSORE PRERJA A-A	
	VENDODHJA : DURRES	PROJEKTI :KONSTRUKTIV	EMER MBIEMER Ark. Adnand Toçila Ark.Oltion Gruçka Ing.Diana Dedja	FIRMA
FAZA E PROJEKTIT : PROJEKT ZBATIMI	GRUPI PROJEKTIMIT :	K-04		

RIKONSTRUKSION SHKOLLA "JUSUF PUKA"

PRERJA D-D E SHITESES ANËSORE SHK 1:50

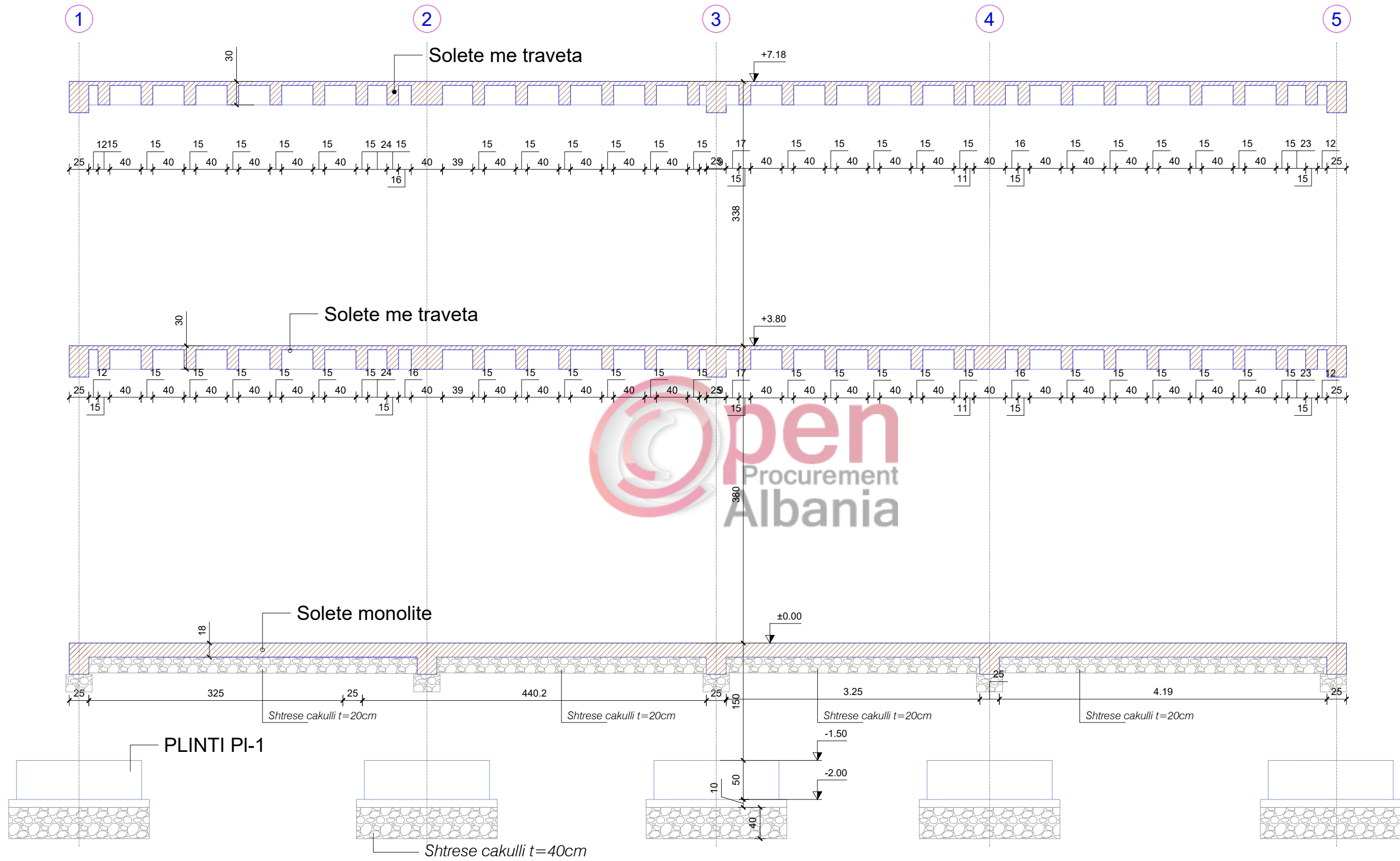

 <p>BASHKIA DURRES</p>	<p>OBJEKTI: "RIKONSTRUKSION SHKOLLA "JUSUF PUKA"</p>		
	<p>VENDODHJA : DURRES</p>	<p>EMER MBIEMER : Ark. Adnand Toçila</p>	<p>FIRMA</p>
<p>PROJEKTI : KONSTRUKTIV</p>	<p>PROJEKTI : Ark. Oltion Gruçka</p>	<p>EMERTIMI I FLETES : PRERJA D-D E SHITESËS ANËSORE</p>	
<p>FAZA E PROJEKTTIT : PROJEKT ZBATIMI</p>	<p>GRUPI PROJEKTTIT :</p>		<p>DATA : . . . 2019 SHKALLA 1:50</p>
<p>INJENIERIA E PROJEKTTIT DHE INFRASTRUKTURES</p>	<p>NO. I FLETES</p>	<p>No. I FLETES</p>	<p>K-05</p>

RIKONSTRUKSION SHKOLLA "JUSUF PUKA"

PLANI I KOLLONAVE NË SHITESËN ANËSORE

SHK 1:75

ARMIMI I KOLLONES K-1

SHK 1:50

Face elevation 1



TABELA E HEKURIT KOLLONA K-1 (10COPE)

Nr	Tipi	Sasia	Dimensioni (cm)	Pesha (kg)	Pesha Totale (kg)	Skema
1	HA16	60	289	4.57	273.97	20
2	HA16	60	457	7.22	433.24	274
3	HA16	60	344	5.44	326.11	329
4	HA8	120	113	0.45	53.56	17
5	HA8	500	125	0.49	246.88	20
Shuma pesha (kg)					1333.76	

<p>BASHKIA DURRES</p>	OBJEKTI: "RIKONSTRUKSION SHKOLLA "JUSUF PUKA"	
	VENDODHJA : DURRES	FIRMA EMER MBIEMER Ark. Adnand Toçila Ark. Oltion Gruçka Ing. Diana Dedja
PROJEKTI : KONSTRUKTIV	FAZA E PROJEKTIT : PROJEKT ZBATIMI	EMERTIMI I FLETES : PLANI I KOLLONAVE DHE ARMIMI NË SHITESËN ANËSORE
No. 1 FLETES	DATA . . . 2019	SHKALLA 1:75 1:50 1:25
K-06		

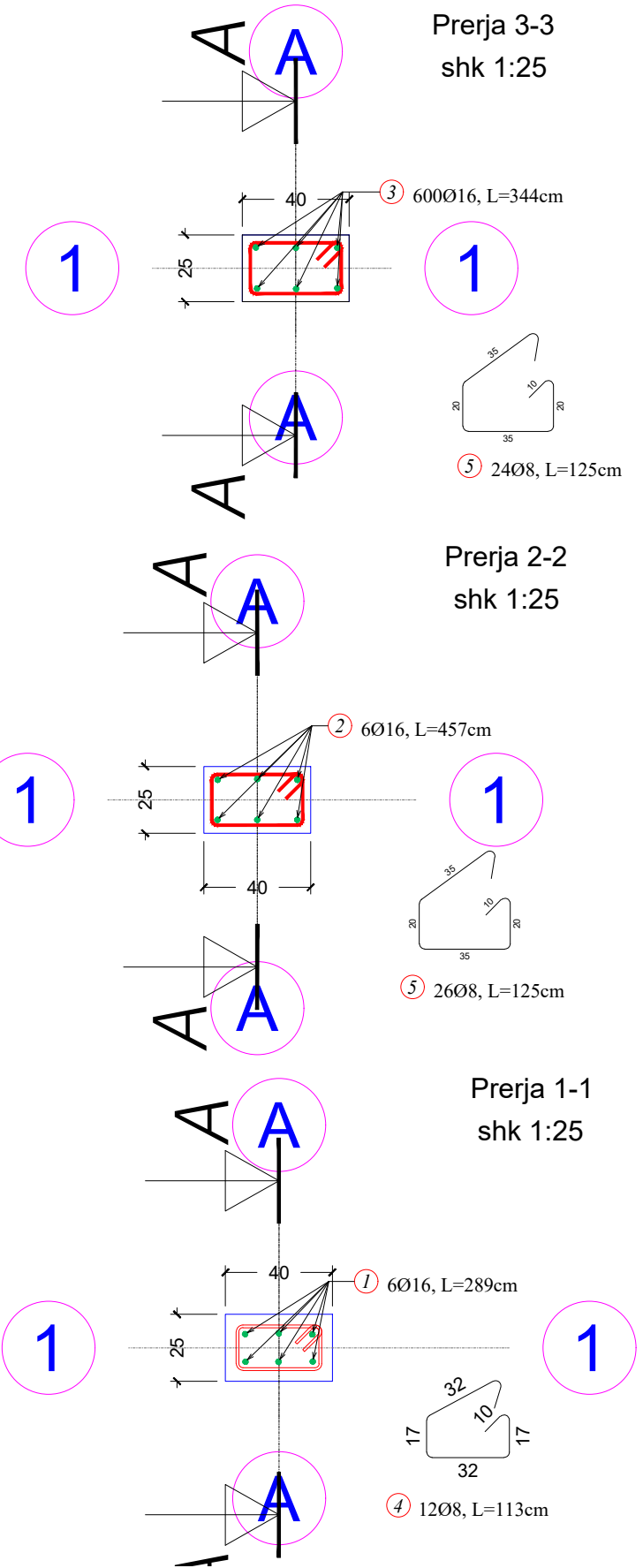
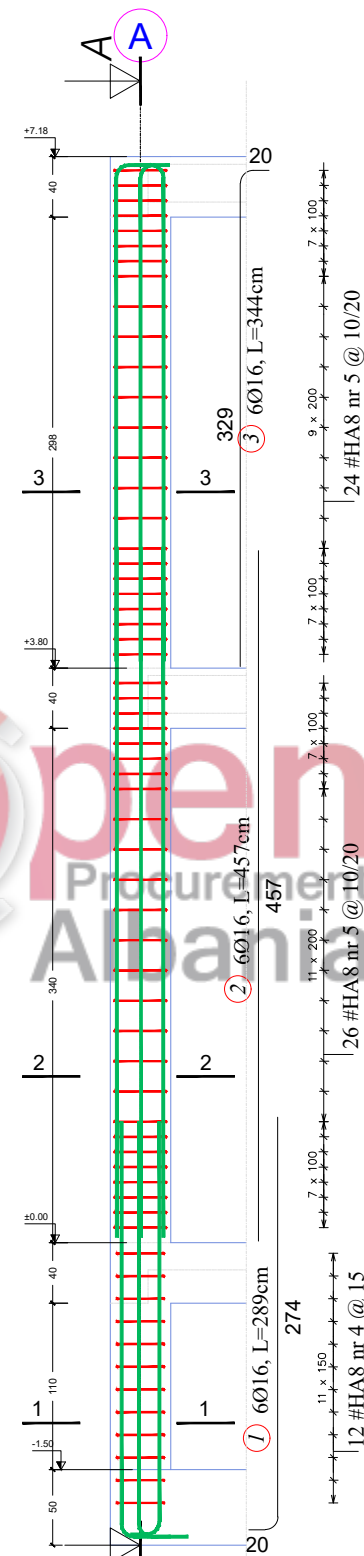
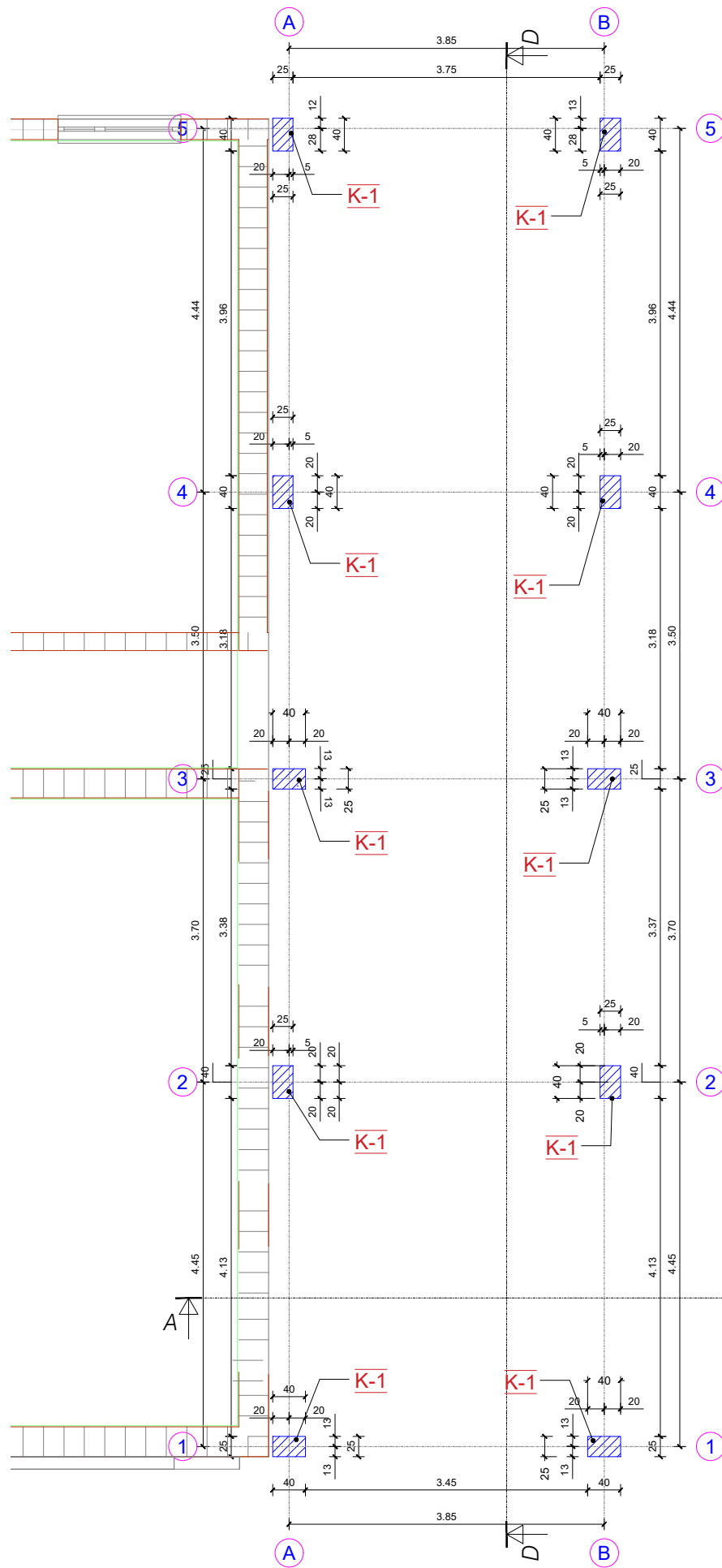

RIKONSTRUKSION SHKOLLA "JUSUF PUKA"

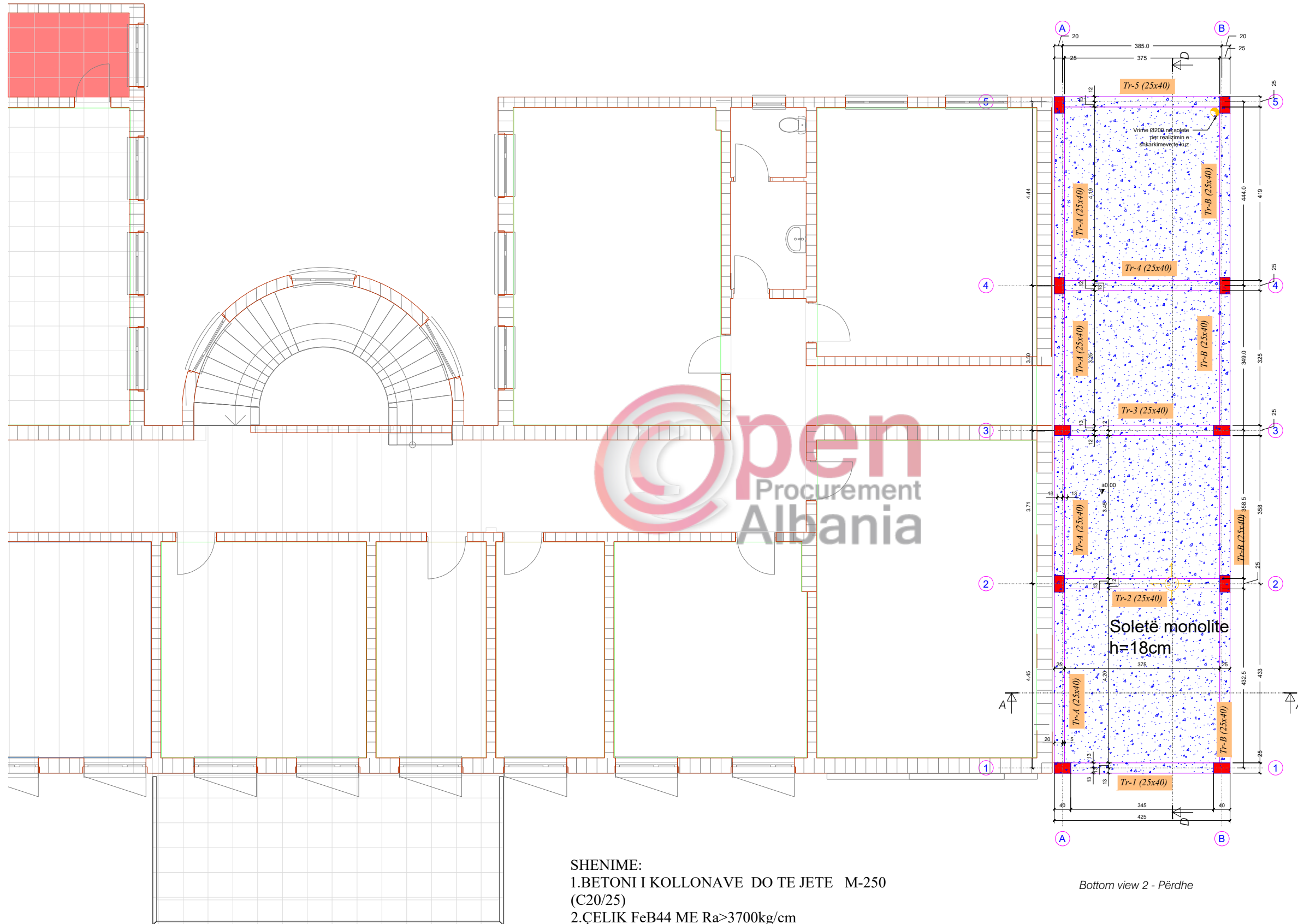
PLANI I SOLETES MONOLITE KUOTA ±0.00 SHK 1:100



- SHENIME:
- 1.BETONI I KOLLONAVE DO TE JETE M-250 (C20/25)
 - 2.ÇELIK FeB44 ME Ra>3700kg/cm
 - 3.Shtresa mbrojtëse e hekurit per soleten monolite do te jete 5.0 cm

Bottom view 2 - Përdhe

 <p>BASHKIA DURRES</p>	<p>OBJEKTI: "RIKONSTRUKSION SHKOLLA "JUSUF PUKA"</p>		<p>EMERTIMI I FLETES : PLANI I SOLETES MONOLITE KUOTA ±0.00</p>	
	<p>VENDODHJA : DURRES</p>	<p>PROJEKTI :KONSTRUKTIV</p>	<p>EMER MBIEMER Ark. Adnand Toçila</p>	<p>FIRMA Ark.Oltion Gruçka</p>
<p>FAZA E PROJEKTIT : PROJEKT ZBATIMI</p>	<p>GRUPI PROJEKTIMIT :</p>	<p>Ing.Diana Dedja</p>	<p>No. I FLETES</p>	<p>SHKALLA 1:50 SHKALLA 1:25</p>
			<p>K-07</p>	

RIKONSTRUKSION SHKOLLA "JUSUF PUKA"

ARMIMI I TRAUT TR-1, TR-2, TR-3, TR-4, TR-5
SHK 1:50
KUOTA 0.00

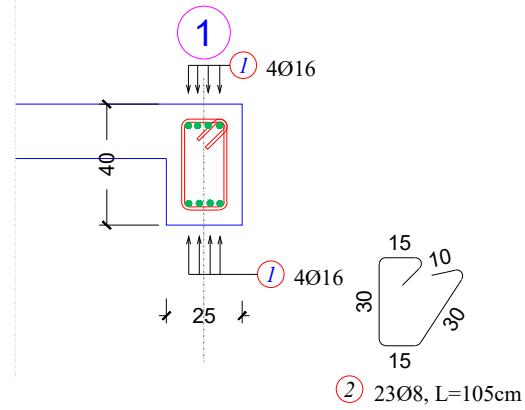
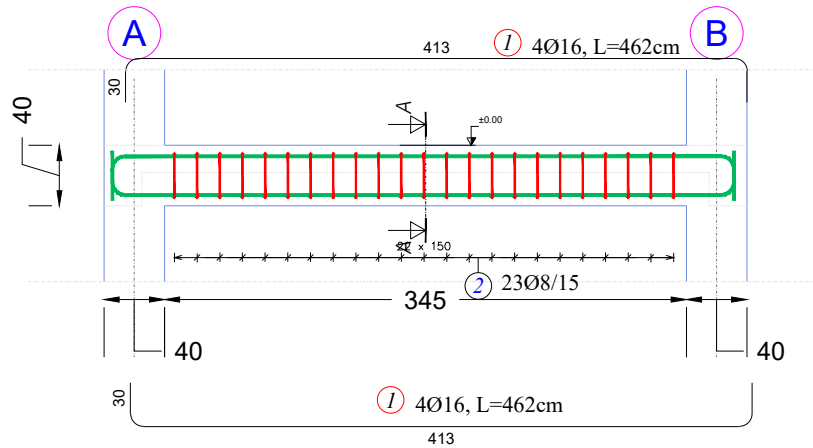

Autodesk TABELA E HEKURIT TRAU TR-1 DERI TR-5						
Nr	Tipi	Sasia	Dimensioni (cm)	Pesha (kg)	Pesha Totale (kg)	Skema
1	HA16	40	462	7.30	291.98	30 413
2	HA8	115	105	0.41	47.70	
Shuma pesha (kg)					339.68	

Autodesk TABELA E HEKURIT TRAU TR-A, TR-B KUOTA 0.00						
Nr	Tipi	Sasia	Dimensioni (cm)	Pesha (kg)	Pesha Totale (kg)	Skema
1	HA16	6	1010	15.96	95.75	25 990
2	HA16	6	730	11.53	69.20	
3	HA16	6	880	13.90	83.42	25 860
4	HA16	6	860	13.59	81.53	
5	HA8	148	105	0.41	61.38	15 30
Shuma pesha (kg)					391.28	

ARMIMI I TRAUT TR-A, TR-B KUOTA 0.00

COPE 2

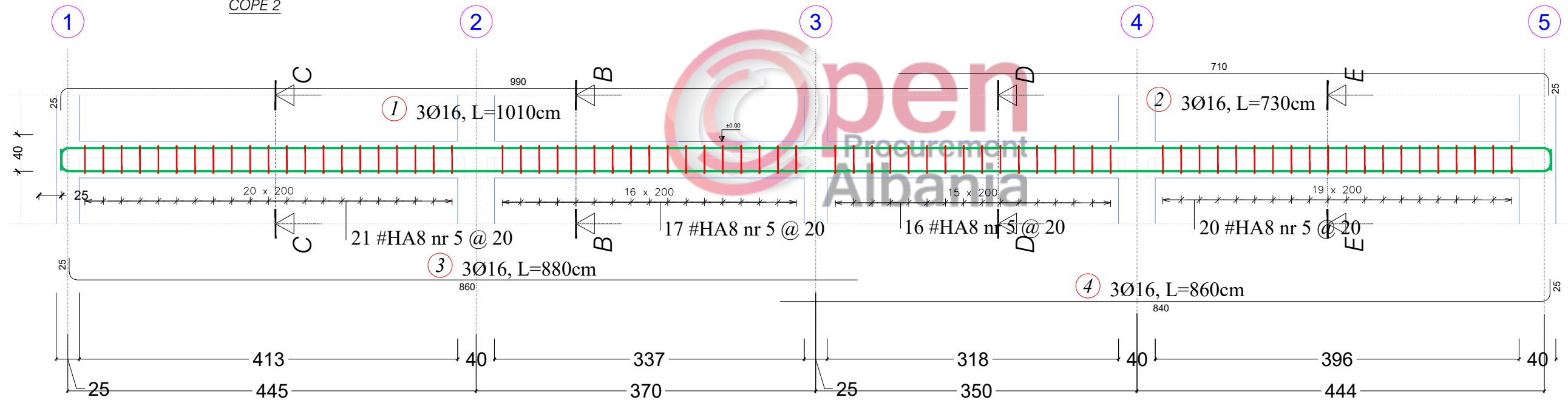

Prerja B-B

Prerja C-C

Prerja D-D

Prerja E-E

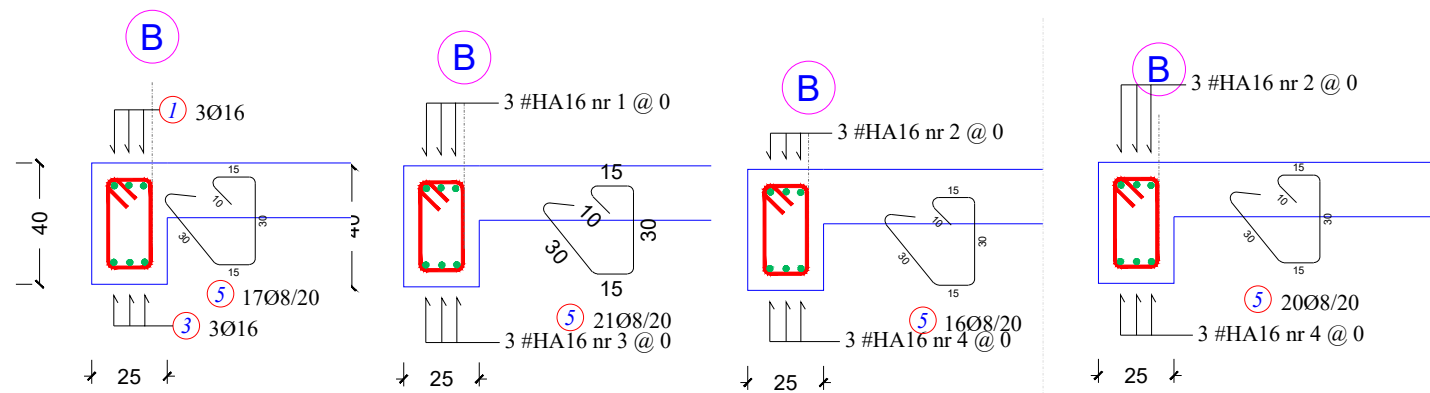

- SHENIME:**
1. BETONI I TRAREVE NE KUOTEN ±0.00 DO TE JETE M-250 (C20/25)
 2. ÇELIK FeB44 ME Ra>3700kg/cm
 3. Shtresa mbrojtëse e hekurit per traret ne kuoten ±0.00 do te jete 5.0 cm

 BASHKIA DURES	OBJEKTI: "RIKONSTRUKSION SHKOLLA "JUSUF PUKA"	
	VENDODHJA : DURES	FIRMA
N J E S T I A E PROJEKTIT DHE INFRASTRUKTURES	FAZA E PROJEKTIT : PROJEKT ZBATIMI	EMERTIMI I FLETES : ARMIMI I TRAUT TR-1, TR-2, TR-3, TR-4, TR-5, TR-A, TR-B NE KUOTEN ±0.00
GRUPI PROJEKTIMIT : EMER MBIEMER : Ark. Adnand Toçila Ing. Oltion Gruçka Ing. Diana Dedja		DATA . . . 2019 SHKALLA 1:50 SHKALLA 1:25 No. I FLETES K-08

RIKONSTRUKSION SHKOLLA "JUSUF PUKA"

ARMIMI I SIPERM DHE I POSHEM I SOLETES MONOLITE KUOTA ±0.00
SHK 1:75



TABELA E HEKURIT

Nr	Tipi	Sasia	Dimensioni (cm)	Pesha (kg)	Pesha Totale (kg)	Skema
1	HA12	164	429	3.81	624.76	10 416
2	HA10	42	1639	10.11	424.73	10 1626
Shuma pesha (kg)					1049.49	

SHENIME:
 1. BETONI I SOLETSE NE KUOTEN ±0.00 DO TE JETE M-250 (C20/25)
 2. ÇELIK FeB44 ME Ra>3700kg/cm
 3. Shtresa mbrojtëse e hekurit per soleten monolite b/a ne kuoten ±0.00 do te jete 5.0 cm

<p>BASHKIA DURES</p>	OBJEKTI: "RIKONSTRUKSION SHKOLLA "JUSUF PUKA"	
	VENDODHJA : DURES	FIRMA
PROJEKTI : KONSTRUKTIV	EMER MBIEMER : Ark. Adnand Toçila	EMERTIMI I FLETES : ARMIMI I ZGARES SE SIPERME DHE POSHTME PRERJA A-A
FAZA E PROJEKTI : PROJEKT ZBATIMI	Ark.Oltion Gruçka Ing.Diana Dedja	
GRUPI PROJEKTIMIT :	DATA . . . 2019	SHKALLA 1:75 SHKALLA 1:25
	No. 1 FLETES	K-09

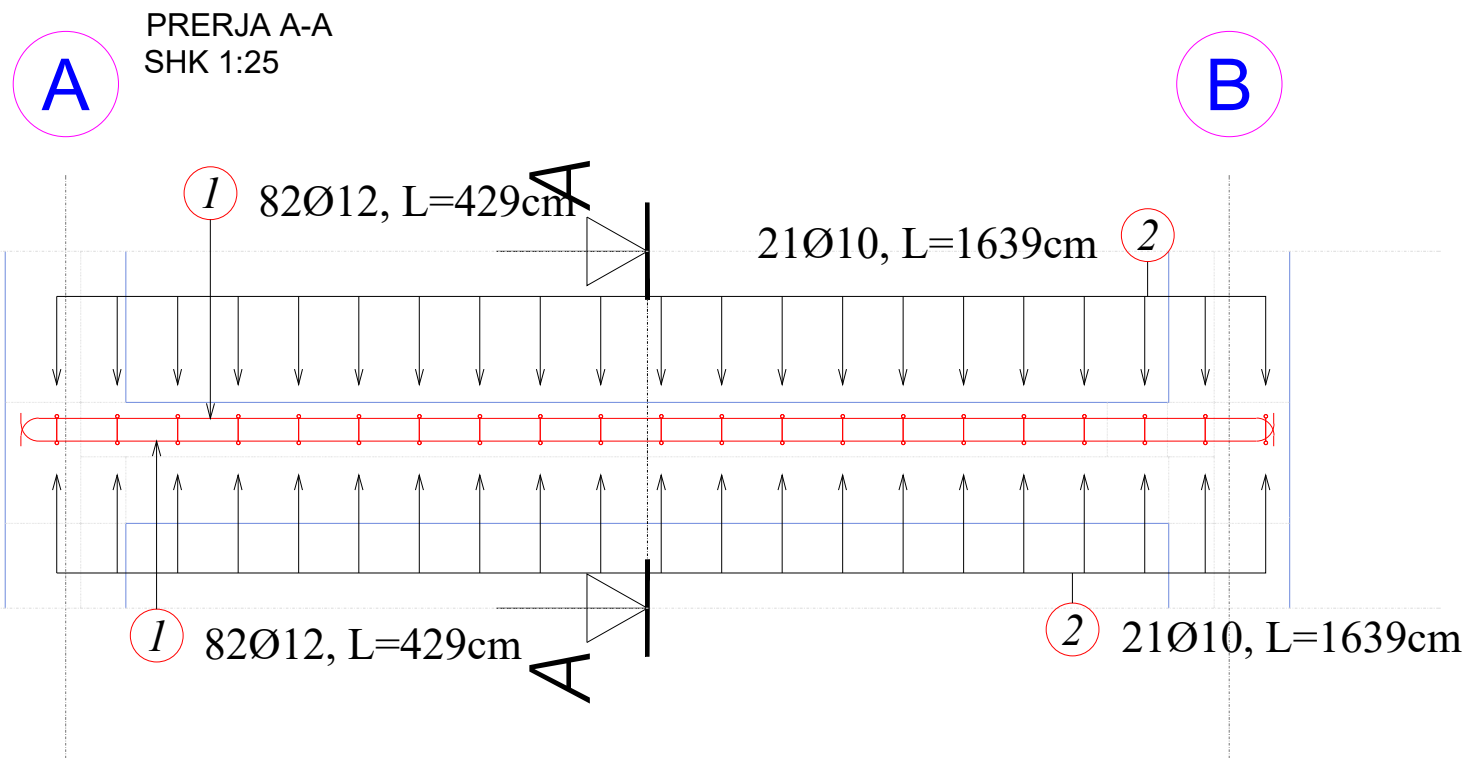
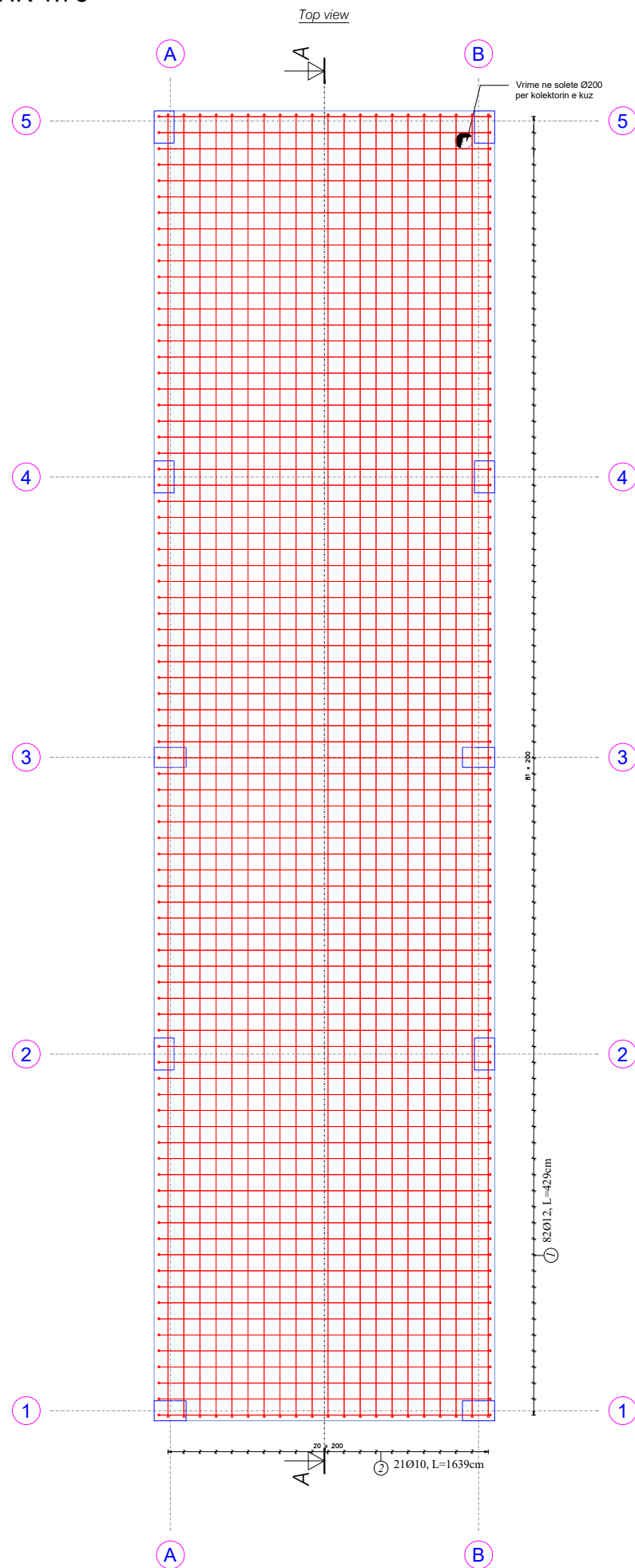

PLANI I SOLETES KUOTA +3.80, +7.18

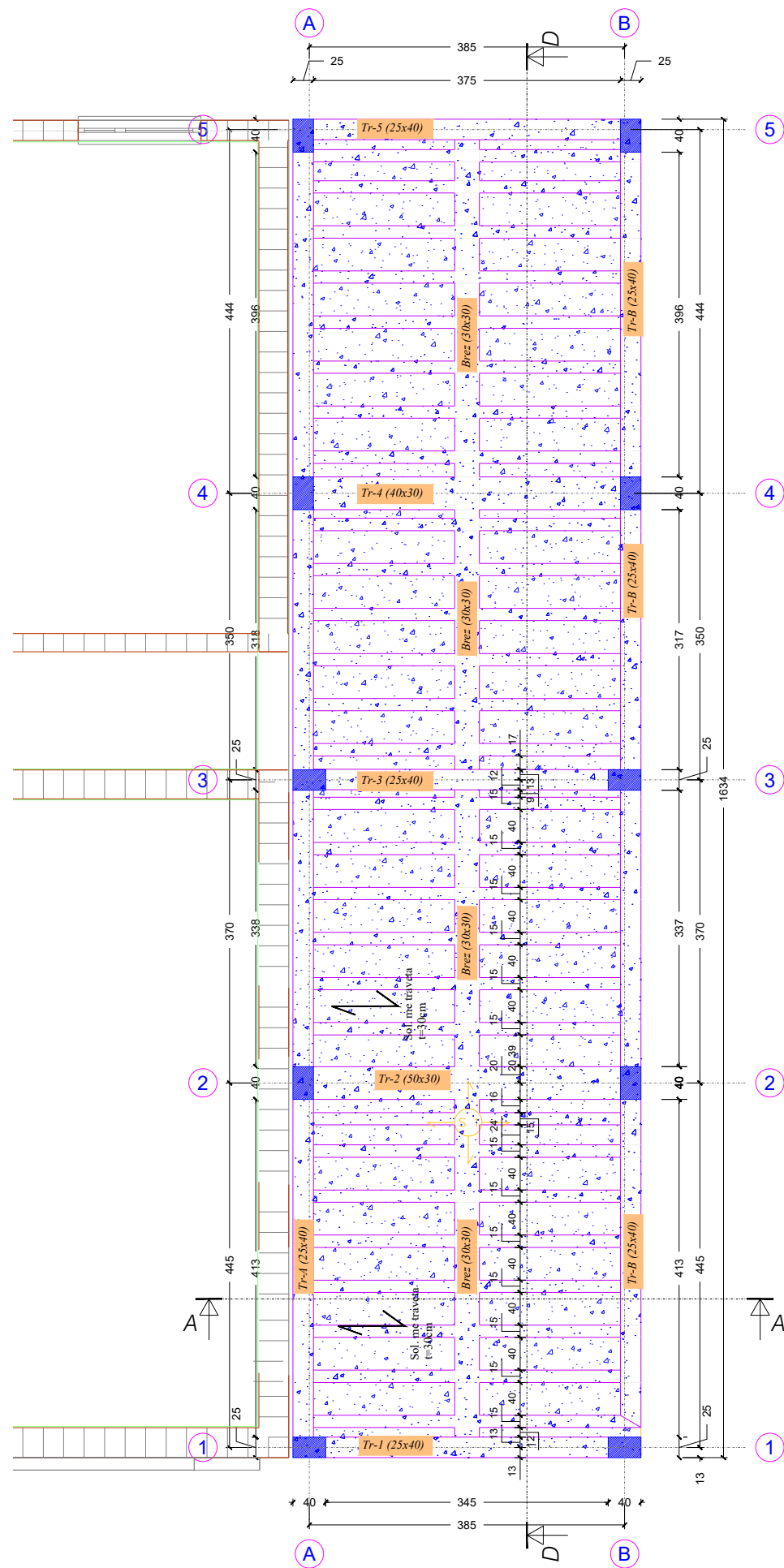
SHK 1:75

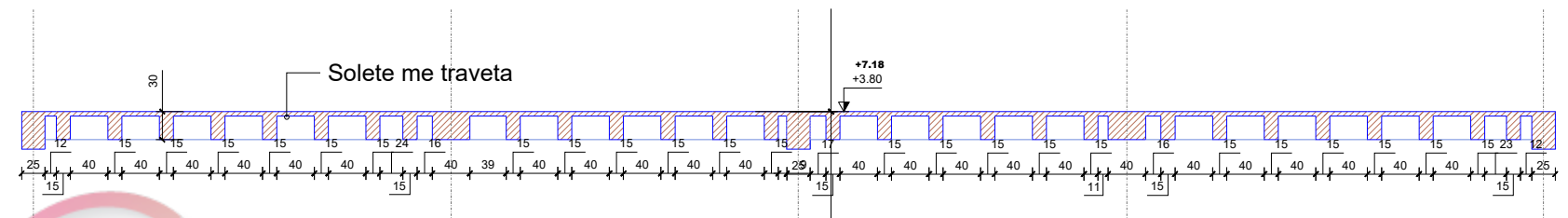

PRERJA A-A E SOLETES KUOTA +3.80, +7.18 SHK 1:75



 BASHKIA DURES N J E S T A E P R O J E K T I T D H E I N F R A S T R U K T U R E S	OBJEKTI: "RIKONSTRUKSION SHKOLLA "JUSUF PUKA"		EMERTIMI I FLETES : PLANI I SOLETES KUOTA +3.80, +7.18 PRERJA A-A	
	VENDODHJA : DURRES	EMER MBIEMER Ark. Adnand Toçila	FIRMA	DATA . . . 2019
PROJEKTI : KONSTRUKTIV	GRUPI PROJEKTIMIT :	Ark.Oltion Gruçka Ing.Diana Dedja	No.1 FLETES	K-10
FAZA E PROJEKTI : PROJEKT ZBATIMI				

ARMIMI I SOLETES KUOTA +3.80, +7.18

SHK 1:75

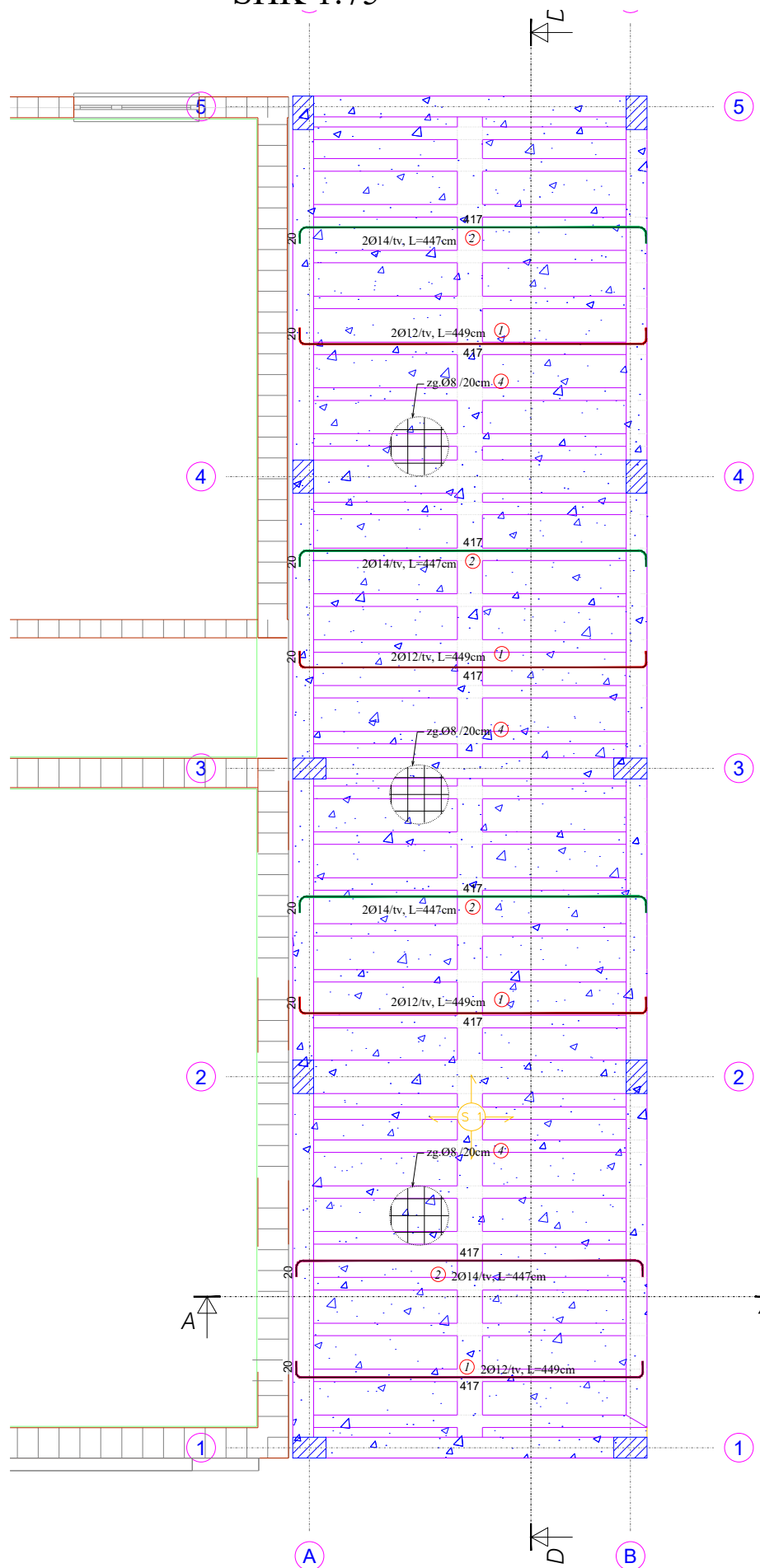

DETAJ TRAVETES KUOTA +3.80, +7.18

SHK 1:20

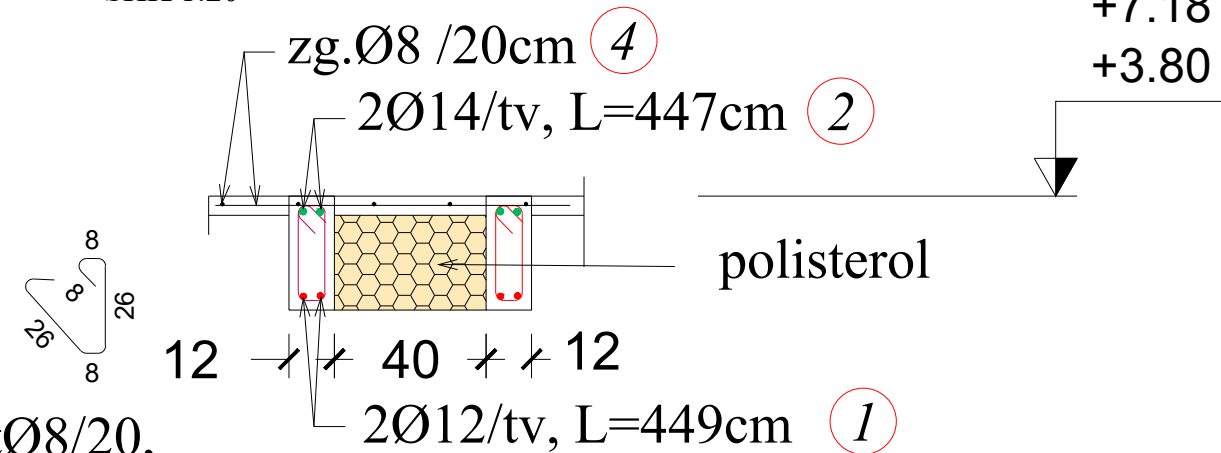

3 stØ8/20, L=78cm

TABELA E HEKURIT TE SOLETES KUOTA +3.80, +7.18

Autodesk*		TABELA E HEKURIT				
Nr	Tipi	Sasia	Dimensioni (cm)	Pesha (kg)	Pesha Totale (kg)	Skema
1	HA12	108	449	3.99	430.61	
2	HA14	108	447	5.41	584.14	
3	HA8	1026	78	0.31	316.11	
Shuma pesha (kg)					1330.86	

SHENIME:

- BETONI I SOLETES ME TRAVETA NE KUOTEN +3.80, +7.18 DO TE JETE M-250 (C20/25)
- ÇELIK FeB44 ME Ra>3700kg/cm
- Shtresa mbrojtëse e hekurit per travetat ne kuoten +3.80, +7.18 do te jete 2.5 cm

<p>BASHKIA DURRËS</p>	OBJEKTI: "RIKONSTRUKSION SHKOLLA "JUSUF PUKA"	
	VENDODHJA : DURRËS	
<p>NJESIA E PROJEKTIT DHE INFRASTRUKTURES</p>	PROJEKTI :KONSTRUKTIV	<p>EMER MBIEMER</p> <p>Ark. Adnand Toçila</p> <p>Ark.Oltion Gruçka</p> <p>Ing.Diana Dedja</p>
	FAZA E PROJEKTIT : PROJEKT ZBATIMI	
		EMERTIMI I FLETES : ARMIMI I SOLETES KUOTA +3.80, +7.18
		DATA . . . 2019
		SHKALLA 1:75 SHKALLA 1:20
		No. 1 FLETES
		K-11

RIKONSTRUKSION SHKOLLA "JUSUF PUKA"

Armimi i traut Tr-1; Tr-3;Tr-5 (kuota +3.60;+7.80)
cope 6

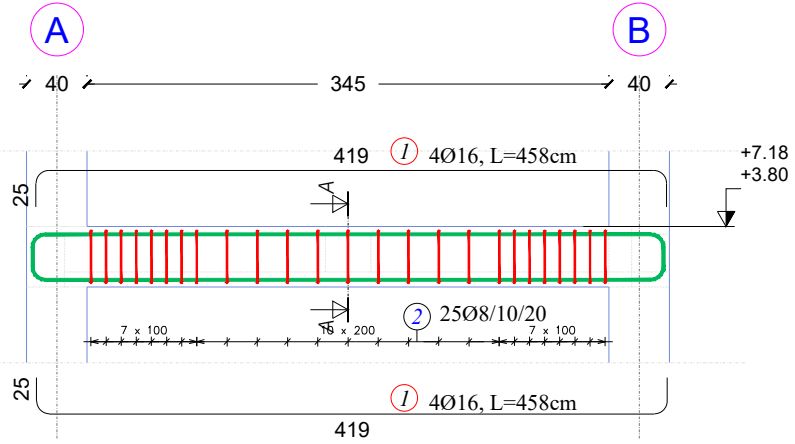

Prerja A-A
shk 1:25

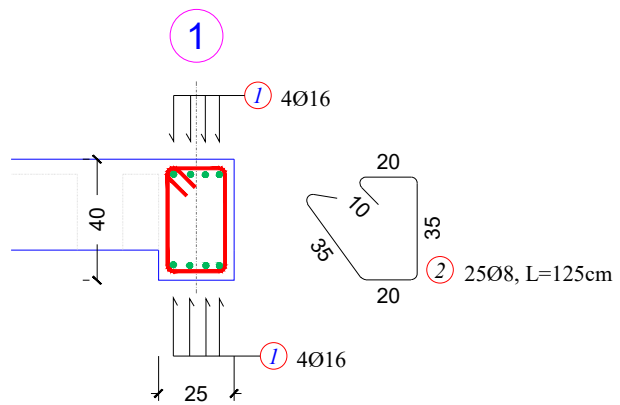

Autodesk TABELA E HEKURIT Tr-1; Tr-3;Tr-5 cope 6

Nr	Tipi	Sasia	Dimensioni (cm)	Pesha (kg)	Pesha Totale (kg)	Skema
1	HA16	48	458	7.24	347.35	
2	HA8	150	125	0.49	74.06	
Shuma pesha (kg)					421.41	

Armimi i traut Tr-2; Tr-4 (kuota +3.80 +7.18)
Cope 4

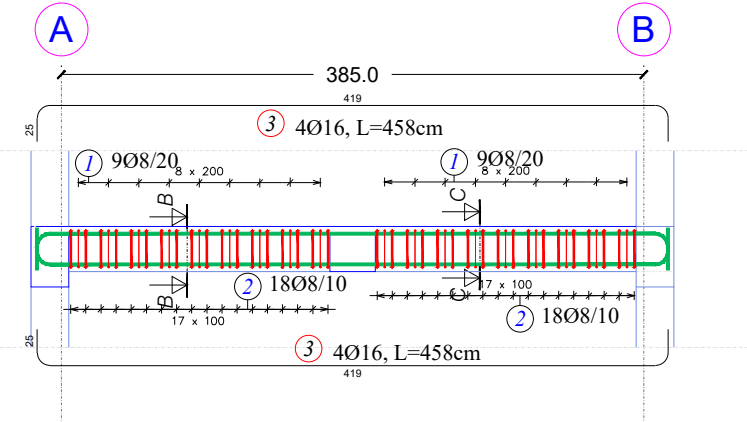

Prerja B-B
shk 1:25

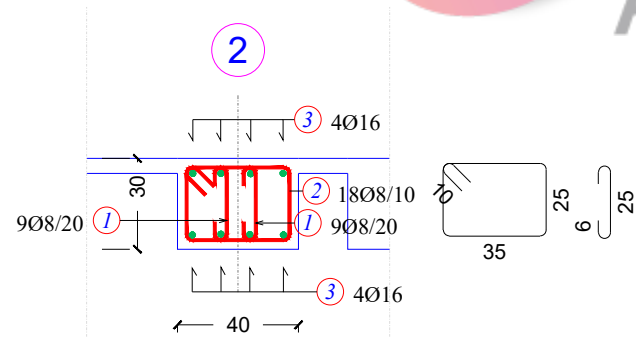

Prerja C-C
shk 1:25

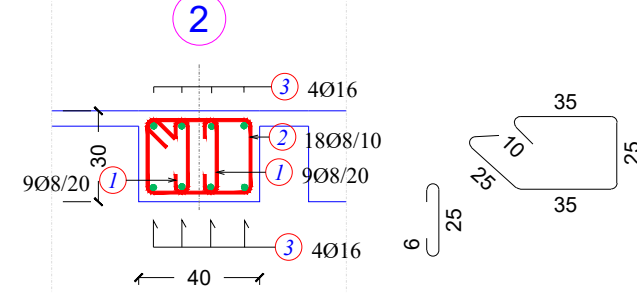

Autodesk TABELA E HEKURIT Tr-2; Tr-4 cope 4

Nr	Tipi	Sasia	Dimensioni (cm)	Pesha (kg)	Pesha Totale (kg)	Skema
1	HA8	144	41	0.16	23.32	
2	HA8	144	135	0.53	76.79	
3	HA16	32	458	7.24	231.56	
Shuma pesha (kg)					331.67	



SHENIME:

- 1.BETONI I TRAREVE NE KUOTEN +3.80, +7.18 DO TE JETE M-250 (C20/25)
- 2.ÇELIK FeB44 ME Ra>3700kg/cm
- 3.Shtresa mbrojtëse e hekurit per traret ne kuoten +3.80, +7.18 do te jete 2.5 cm

 BASHKIA DURRES NJESIA E PROJEKTIT DHE INFRASTRUKTURES	OBJENKT: "RIKONSTRUKSION SHKOLLA "JUSUF PUKA" VENDODHJA : DURRES PROJEKTI : KONSTRUKTIV FAZA E PROJEKTIT : PROJEKT ZBATIMI	EMER MBIEMER : Ark. Adnand Toçila Ark.Oltion Gruçka Ing.Diana Dedja	EMERTIMI I FLETES : ARMIMI I TRAREVE KUOTA +3.80, +7.18 DATA . . . 2019 SHKALLA 1:50 No. I FLETES K-12
	GRUPI PROJEKTIMIT :		

RIKONSTRUKSION SHKOLLA "JUSUF PUKA"

Armimi i traut Tr-A, Tr-B kuota +3.80, +7.18

cope 4

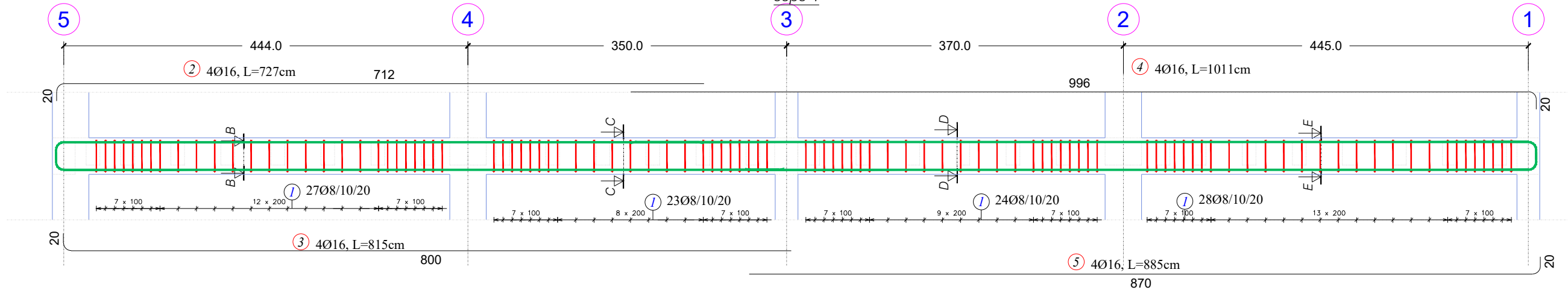

Prerja B-B
shk 1:25

Prerja C-C
shk 1:25

Prerja D-D
shk 1:25

Prerja E-E
shk 1:25

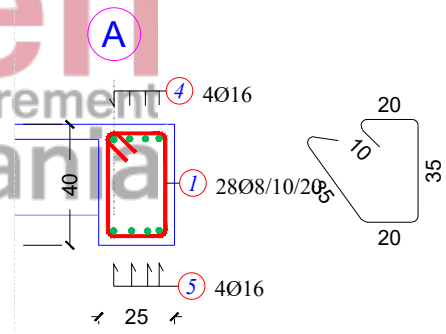
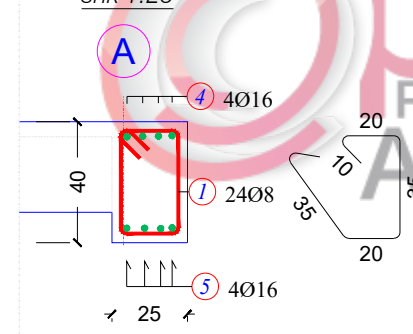
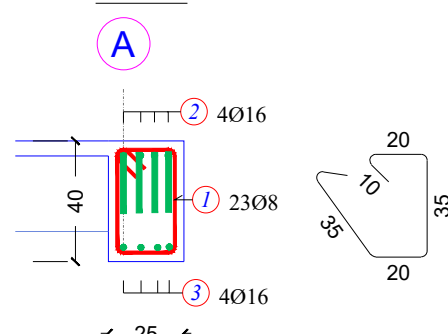
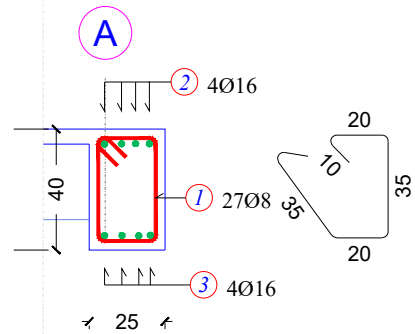

Autodesk* TABELA E HEKURIT Tr-A, Tr-B						
Nr	Tipi	Sasia	Dimensioni (cm)	Pesha (kg)	Pesha Totale (kg)	Skema
1	HA8	408	125	0.49	201.45	
2	HA16	16	727	11.49	183.79	
3	HA16	16	815	12.88	206.03	
4	HA16	16	1011	15.97	255.58	
5	HA16	16	885	13.98	223.73	
Shuma pesha (kg)					1070.58	

SHENIME:

1. BETONI I TRAREVE NE KUOTEN +3.80, +7.18 DO TE JETE M-250 (C20/25)
2. ÇELIK FeB44 ME Ra>3700kg/cm
3. Shtresa mbrojtëse e hekurit per traret ne kuoten +3.80, +7.18 do te jete 3.0 cm

	OBJEKTI: "RIKONSTRUKSION SHKOLLA "JUSUF PUKA"	
	VENDODHJA : DURRES PROJEKTI :KONSTRUKTIV	EMER MBIEMER : Ark. Adnand Toçila FIRMA : Ark.Oltion Gruçka Ing.Diana Dedja
NJESIA E PROJEKTIT DHE INFRASTRUKTURES	FAZA E PROJEKTIT : PROJEKT ZBATIMI	GRUPI PROJEKTIMIT :
EMERTIMI I FLETES : ARMIMI I TRAREVE KUOTA +3.80, +7.18		DATA . . . 2019 SHKALLA 1:50 No.1 FLETES K-13

RIKONSTRUKSION SHKOLLE "JUSUF PUKA" KATI 0

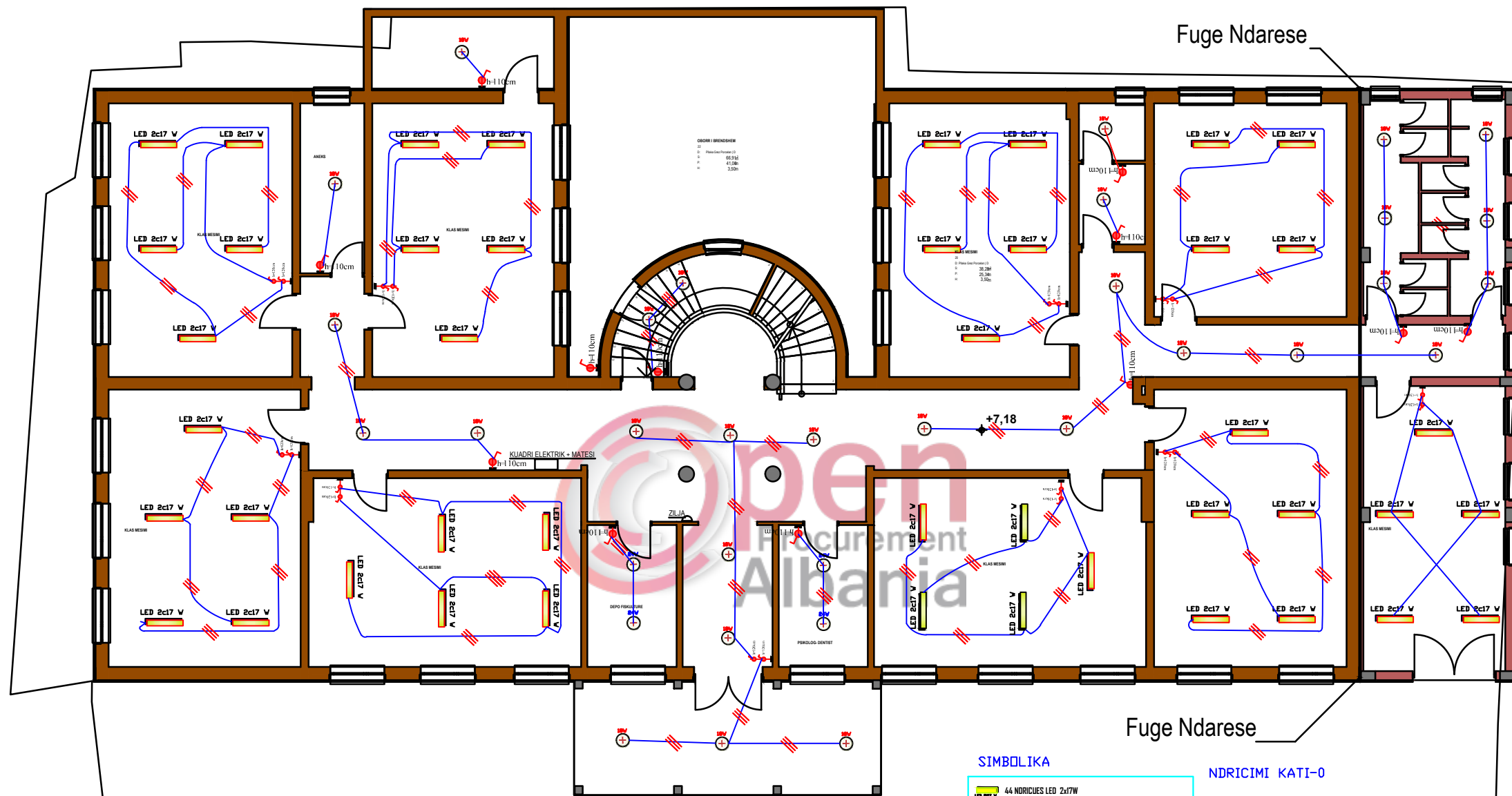

SIMBOLIKA

- 44 NDRICUES LED 2x17W
- 4 NDRICUES KATRORE LED 24W
- 29 NDRICUES PLAFONIERE LED 18W
- 30 ndricimi 10 A 230 v
- Tub PVC Φ 16,percielles 3x1.5 mm2

NDRICIMI KATI-0

- 44 NDRICUES 2X17=1496W
- 4 NDRICUES 1X24w=96 W
- 29 NDRICUES 1X18w=522W
- Pins= 2.1 kw



OBJEKTI:
VENDODHJA :
ARAPAJ ,DURRËS
PROJEKTI: ARKITEKTONIK
FAZA E PROJEKTIT :
PROJEKT ZBATIM

RIKONSTRUKSION SHKOLLE "JUSUF PUKA"

EMER MBIEMER **FIRMA**
Ark. Adnand TOÇILA
Ing .elek. Mariglen JAHOLLARI

INSTALIMET ELEKTRIKE TE NDRICIMIT
PLANIMETRIA E KATIT 0.

2019
 No. Fletes **-01**

RIKONSTRUKSION SHKOLLE "JUSUF PUKA" KATI 1

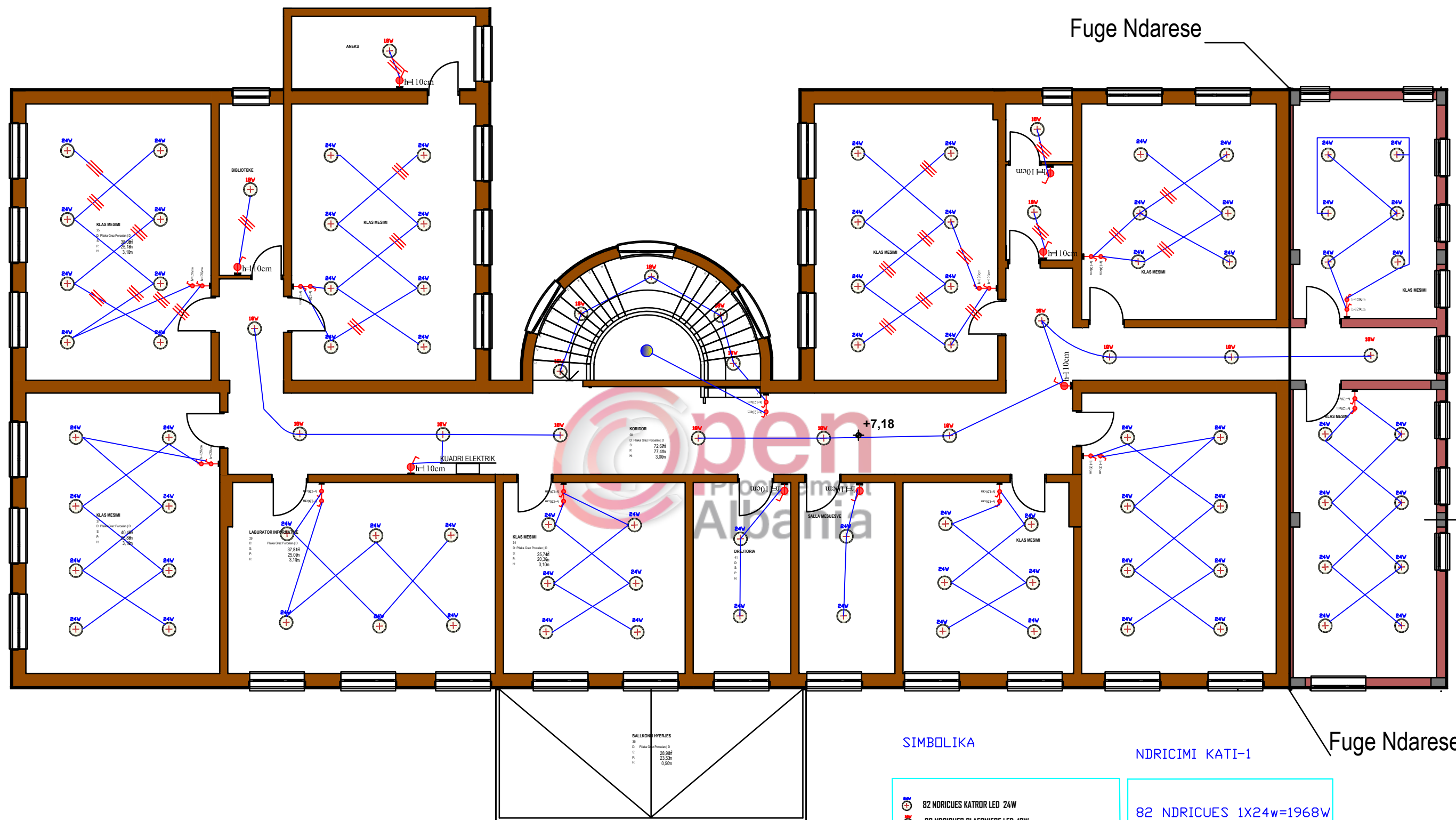

Fuge Ndarese

Fuge Ndarese

SIMBOLIKA

NDRICIMI KATI-1

- 82 NDRICUES KATRORE LED 24W
- 20 NDRICUES PLAFONIERE LED 18W
- 28 ndricimi 10 A 280 v
- Tub PVC Φ 16,percielles 3x1.5 mm2

82 NDRICUES 1X24w=1968W
20 NDRICUES 1X18w=360W
Pins= 2.3 kw

	OBJEKTI: RIKONSTRUKSION SHKOLLE "JUSUF PUKA"		INSTALIMET ELEKTRIKE TE NDRICIMIT PLANIMETRIA E KATIT 1.	
	VENDODHJA : ARAPAJ ,DURRËS	EMER MBIEMER Ark. Adnand TOÇILA Ing .elek. Mariglen JAHOLLARI	FIRMA 	2019
N JESIA E PROJEKTIT DHE INFRASTRUKTURES	PROJEKTI : ARKITEKTONIK	FAZA E PROJEKTIT : PROJEKT ZBATIM	GRUPI PROJEKTIMIT :	No. Fletes <input type="checkbox"/> -02

RIKONSTRUKSION SHKOLLE "JUSUF PUKA" KATI 0

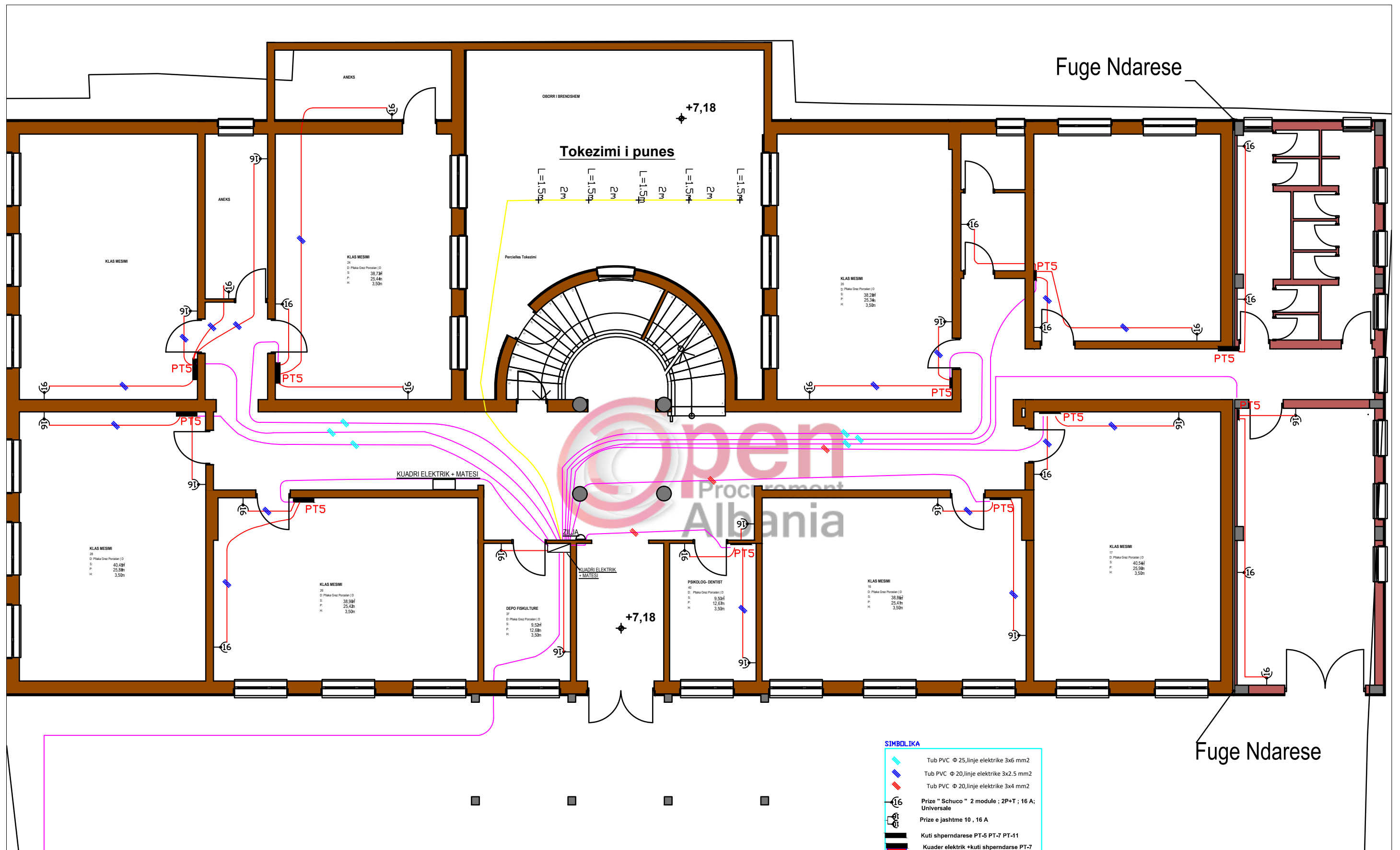

SIMBOLIKA

	Tub PVC Ø 25, linje elektrike 3x6 mm ²
	Tub PVC Ø 20, linje elektrike 3x2.5 mm ²
	Tub PVC Ø 20, linje elektrike 3x4 mm ²
	Prize " Schuco " 2 module ; 2P+T ; 16 A ; Universale
	Prize e jashtme 10 , 16 A
	Kuti shperndarese PT-5 PT-7 PT-11
	Kuader elektrik +kuti shperndarese PT-7

<p>BASHKIA DURRËS</p>	<p>OBJEKTI: RIKONSTRUKSION SHKOLLE "JUSUF PUKA"</p>		<p>INSTALIMET ELEKTRIKE TE FUQIS PLANIMETRIA E KATIT 0.</p>	
	<p>VENDODHJA : ARAPAJ ,DURRËS</p> <p>PROJEKTI : ARKITEKTONIK</p> <p>FAZA E PROJEKTIT : PROJEKT ZBATIM</p>	<p>EMER MBIEMER</p> <p>Ark. Adnand TOÇILA Ing.elek. Mariglen JAHOLLARI</p>	<p>FIRMA</p>	<p>2019</p> <p>No. Fletes <input type="checkbox"/> -03</p>

RIKONSTRUKSION SHKOLLE "JUSUF PUKA" KATI 1

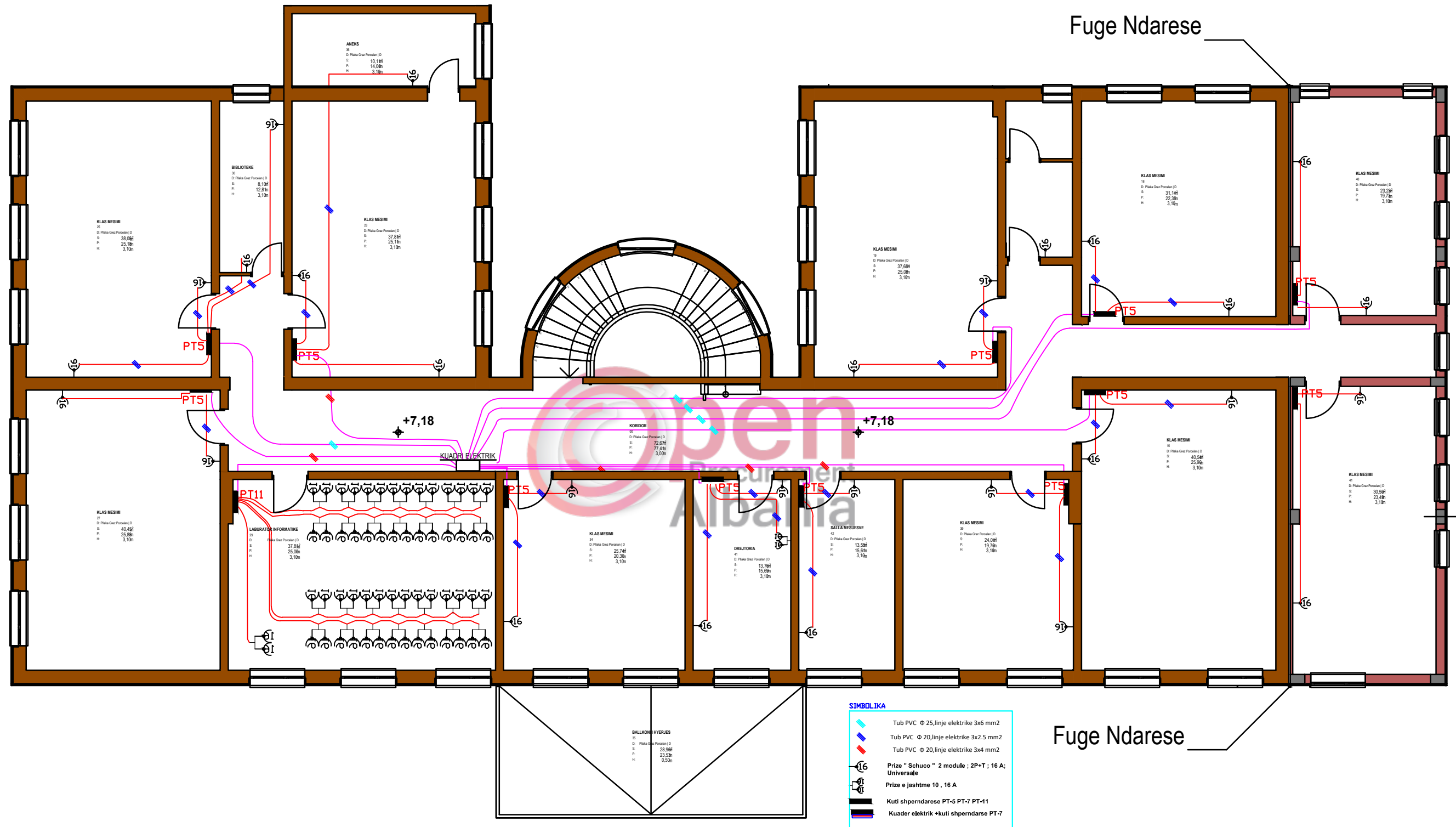

OBJEKTI: RIKONSTRUKSION SHKOLLE "JUSUF PUKA"		FIRMA: EMER MBIEMER		INSTALIMET ELEKTRIKE TE FUQIS PLANIMETRIA E KATIT 1.	
VENDODHJA : ARAPAJ ,DURRËS		GRUPI PROJEKTIMIT : Ark. Adnand TOÇILA Ing .elek. Mariglen JAHOLLARI		2019	
PROJEKTI : ARKITEKTONIK		FAZA E PROJEKTIT : PROJEKT ZBATIM		No. Fletes <input type="checkbox"/> -04	

RIKONSTRUKSION SHKOLLE "JUSUF PUKA"

KATI 0

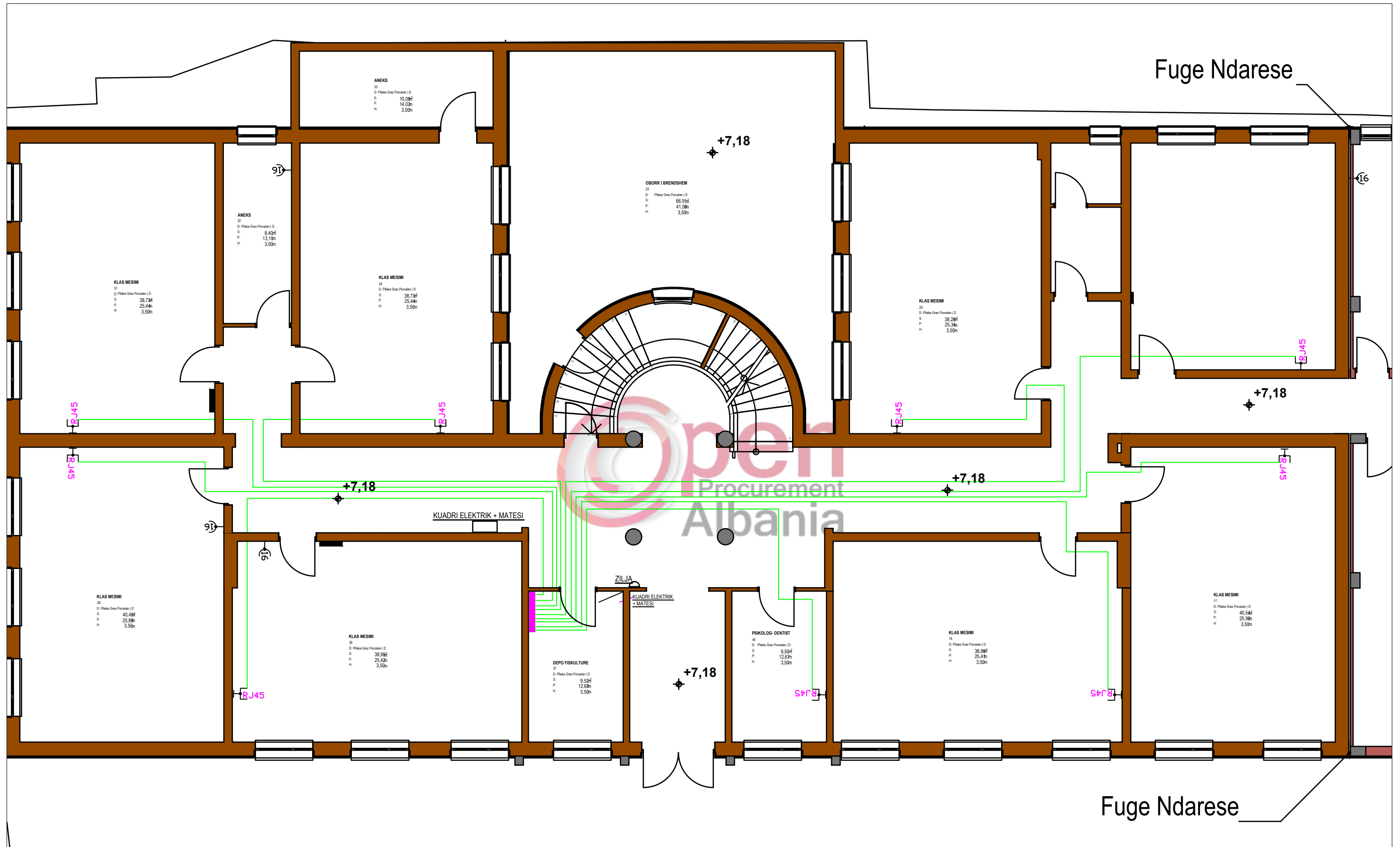

OBJEKTI: RIKONSTRUKSION SHKOLLE "JUSUF PUKA"		FIRMA: EMER MBIEMER		INSTALIMET ELEKTRIKE TE INTERNETIT, PLANIMETRIA E KATIT 0.	
VENDODHJA : ARAPAJ ,DURRËS		GRUPI PROJEKTIMIT : Ark. Adnand TOÇILA Ing .elek. Mariglen JAHOLLARI		2019	
PROJEKTI : ARKITEKTONIK		FAZA E PROJEKTIT : PROJEKT ZBATIM		No. Fletes <input type="checkbox"/> -05	

RIKONSTRUKSION SHKOLLE "SHAQË MAQREKU" KATI 1

KATI PARE

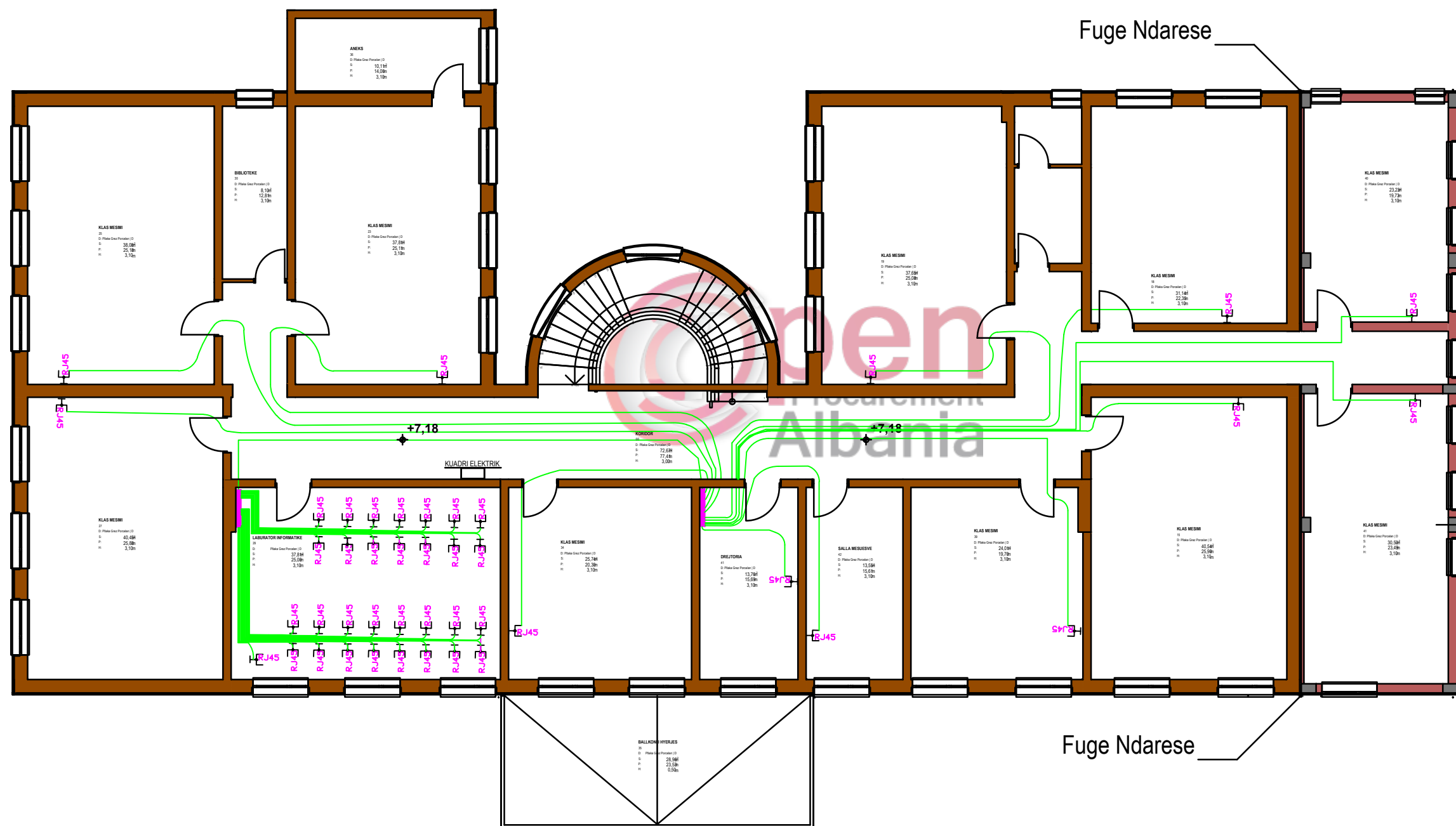

BASHKIA DURRËS		OBJEKTI: RIKONSTRUKSION SHKOLLE "JUSUF PUKA"	
VENDODHJA :	ARAPAJ ,DURRËS	GRUPI PROJEKTIMIT :	EMER MBIEMER
PROJEKTI :	ARKITEKTONIK		FIRMA
FAZA E PROJEKTIT :	PROJEKT ZBATIM	Ark. Adnand TOÇILA Ing .elek. Mariglen JAHOLLARI	
		INSTALIMET ELEKTRIKE TE INTERNETIT, PLANIMETRIA E KATIT1.	
		2019	
		No. Fletes <input type="checkbox"/> -06	

RIKONSTRUKSION SHKOLLE "JUSUF PUKA"

DETAJI I VENDOSJES SE SHUFRAVE TE ZINKUARA TE RRUFEPRITESIT

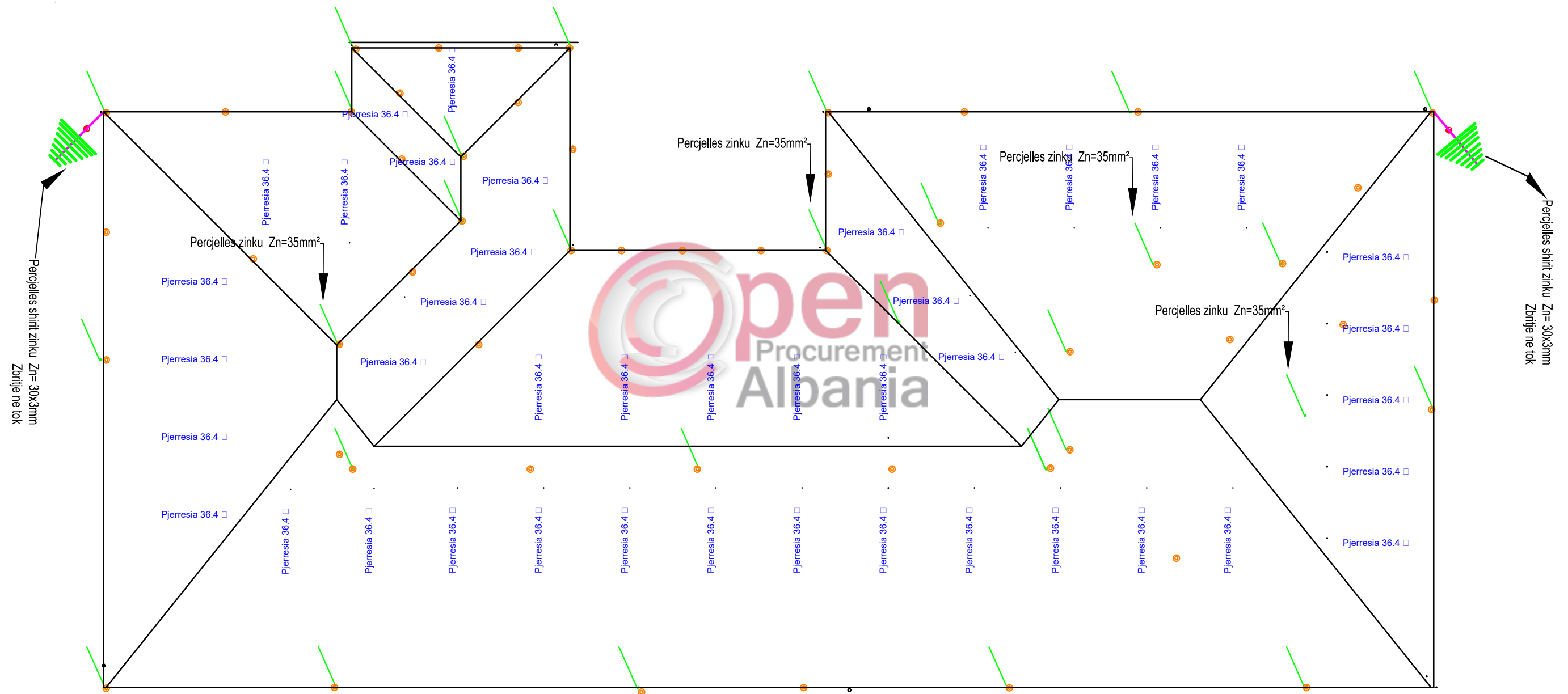

OBJEKTI: RIKONSTRUKSION SHKOLLE "JUSUF PUKA"		INSTALIMET ELEKTRIKE TE , PLANIMETRIA E RRUFEPRITSAVE	
VENDODHJA : ARAPAJ ,DURRËS	EMER MBIEMER	FIRMA	2019
PROJEKTI : ARKITEKTONIK	Ark. Adnand TOÇILA Ing .elek. Mariglen JAHOLLARI		No. Fletes <input type="checkbox"/> -07
FAZA E PROJEKTIT : PROJEKT ZBATIM	GRUPI PROJEKTIMIT :		

RIKONSTRUKSION SHKOLLE "JUSUF PUKA"

DETAJI I VENDOSJES SE SHUFRAVE TE ZINKUARA TE TOKEZIMIT

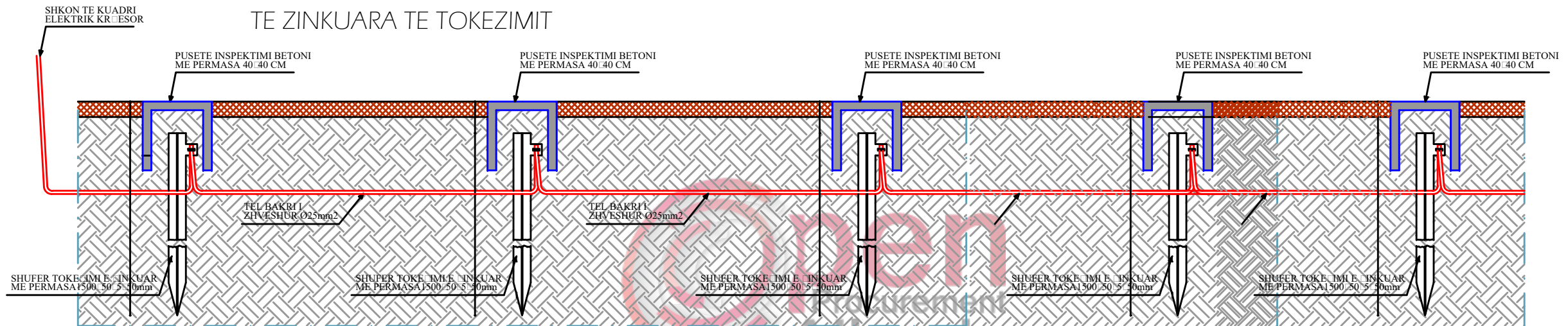

SHENIM: VLERA E TOKEZIMIT
DUHET TE JETE ME EVOJELISE 4 Ω,
NE TE KUNDERT TE SHTOHET
NUMRI I ELEKTRODAVE.



BASHKIA DURRËS		OBJEKTI: RIKONSTRUKSION SHKOLLE "JUSUF PUKA"	
VENDODHJA : ARAPAJ, DURRËS		GRUPI PROJEKTIMIT: EMER MBIEMER FIRMA	INSTALIMET ELEKTRIKE , DETAJE TOKEZIMI
PROJEKTI : ARKITEKTONIK			
FAZA E PROJEKTIT : PROJEKT ZBATIM		Ark. Adnand TOÇILA Ing. elek. Mariglen JAHOLLARI	2019
		No. Fletes	<input type="checkbox"/> -08

RIKONSTRUKSION SHKOLLE "JUSUF PUKA"

Kuadri Elektrik Kryesori Kati perdhe

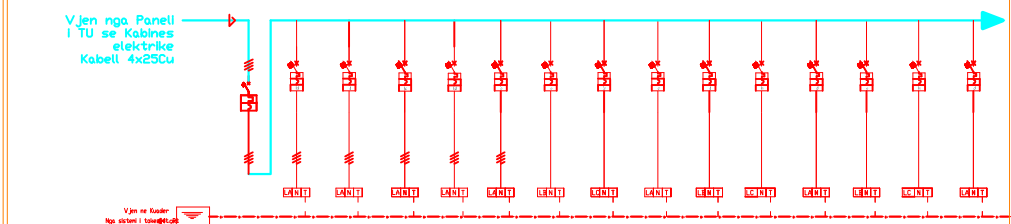

1	2	3	4	5	6	7	8	9	10	11	12	13	14
1	2	3	4	5	6	7	8	9	10	11	12	13	14
1	2	3	4	5	6	7	8	9	10	11	12	13	14
1	2	3	4	5	6	7	8	9	10	11	12	13	14
1	2	3	4	5	6	7	8	9	10	11	12	13	14

Kuadri Elektrik Kati Tip

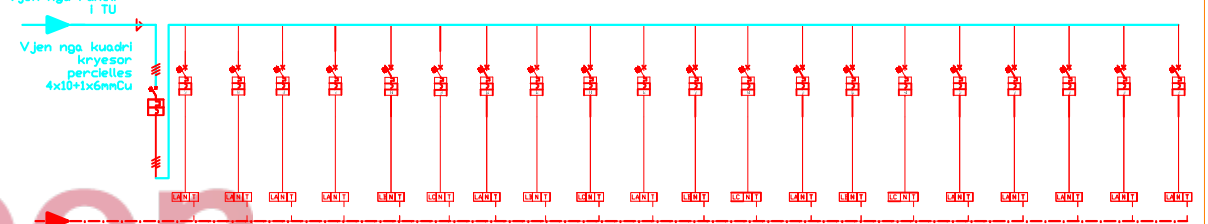

15	16	17	18	19	20	21	22	23	24	25	26	27	28	29	30
15	16	17	18	19	20	21	22	23	24	25	26	27	28	29	30
15	16	17	18	19	20	21	22	23	24	25	26	27	28	29	30
15	16	17	18	19	20	21	22	23	24	25	26	27	28	29	30
15	16	17	18	19	20	21	22	23	24	25	26	27	28	29	30

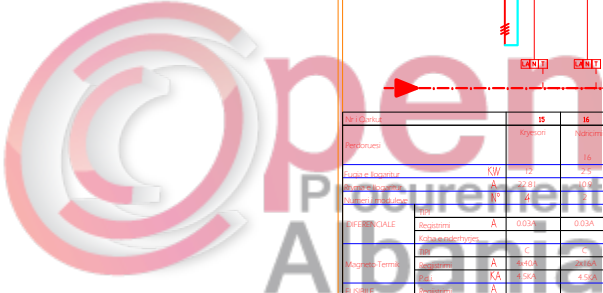

<p>BASHKIA DURRES</p>	OBJEKTI: RIKONSTRUKSION SHKOLLE "JUSUF PUKA"		INSTALIMET ELEKTRIKE TE , PLANIMETRIA E KUADROVE TIP		
	VENDODHJA : ARAPAJ ,DURRES PROJEKTI : ARKITEKTONIK	EMER MBIEMER Ark. Adnand TOÇILA Ing .elek. Mariglen JAHOLLARI		FIRMA EMER MBIEMER	
N J E S T I A E PROJEKTIT DHE INFRASTRUKTURES	FAZA E PROJEKTIT : PROJEKT ZBATIM	GRUPI PROJEKTIMIT :	No. Fletes <input type="checkbox"/> -09		

2019

No. Fletes -09

RIKONSTRUKSION SHKOLLE "JUSUF PUKA"

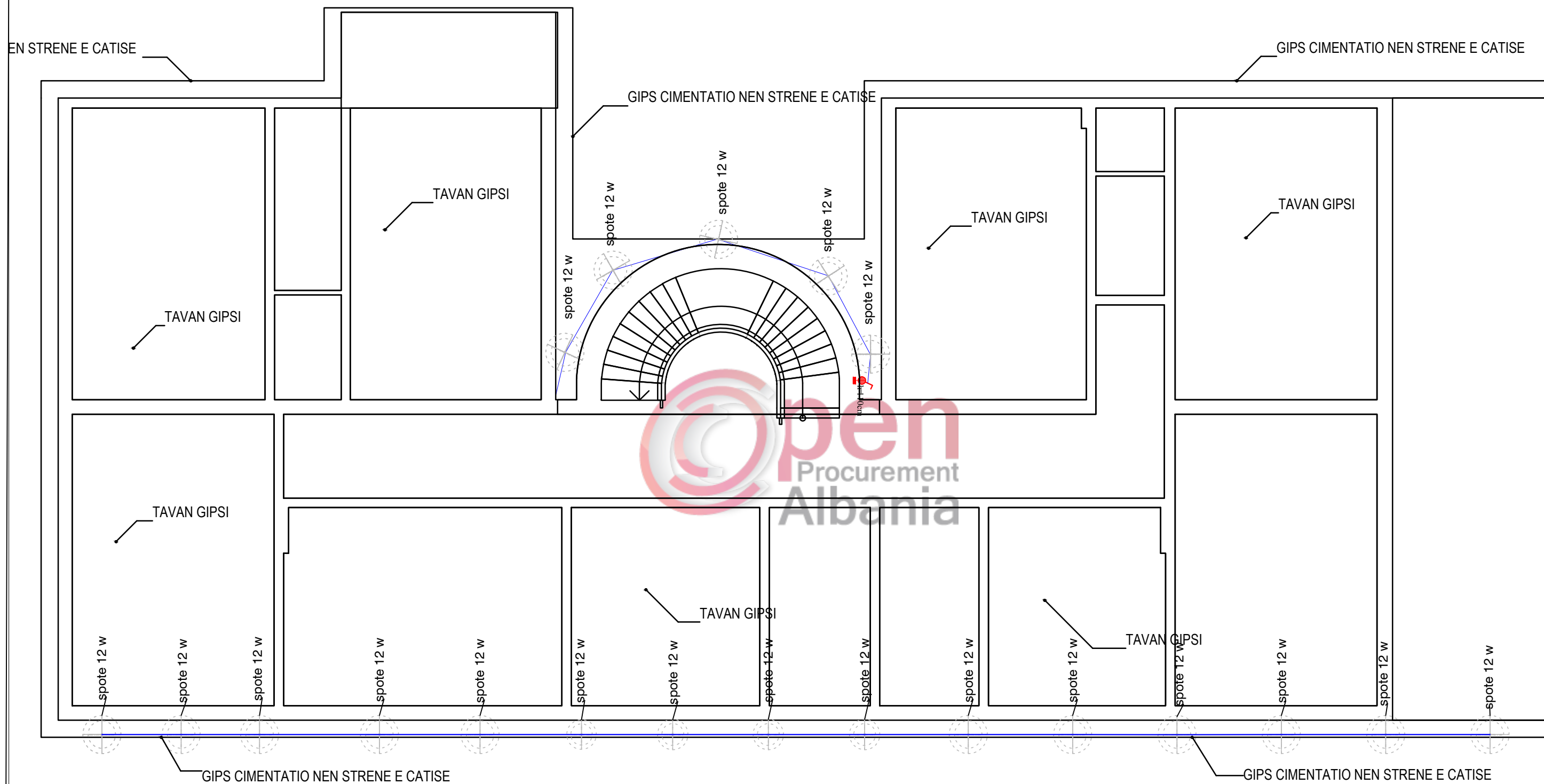

OBJEKTI:		RIKONSTRUKSION SHKOLLE "JUSUF PUKA"	
VENDODHJA :	ARAPAJ ,DURRËS	EMER MBIEMER	FIRMA
PROJEKTI :	ARKITEKTONIK	Ark. Adnand TOÇILA Ing .elek. Mariglen JAHOLLARI	
FAZA E PROJEKTIIT :	PROJEKT ZBATIM	INSTALIMET ELEKTRIKE TE , NDRICIM FASADE	
GRUPI PROJEKTIIT :		2019	
		No. Fletes <input type="checkbox"/> -10	

RIKONSTRUKSION SHKOLLE "JUSUF PUKA" KATI 0

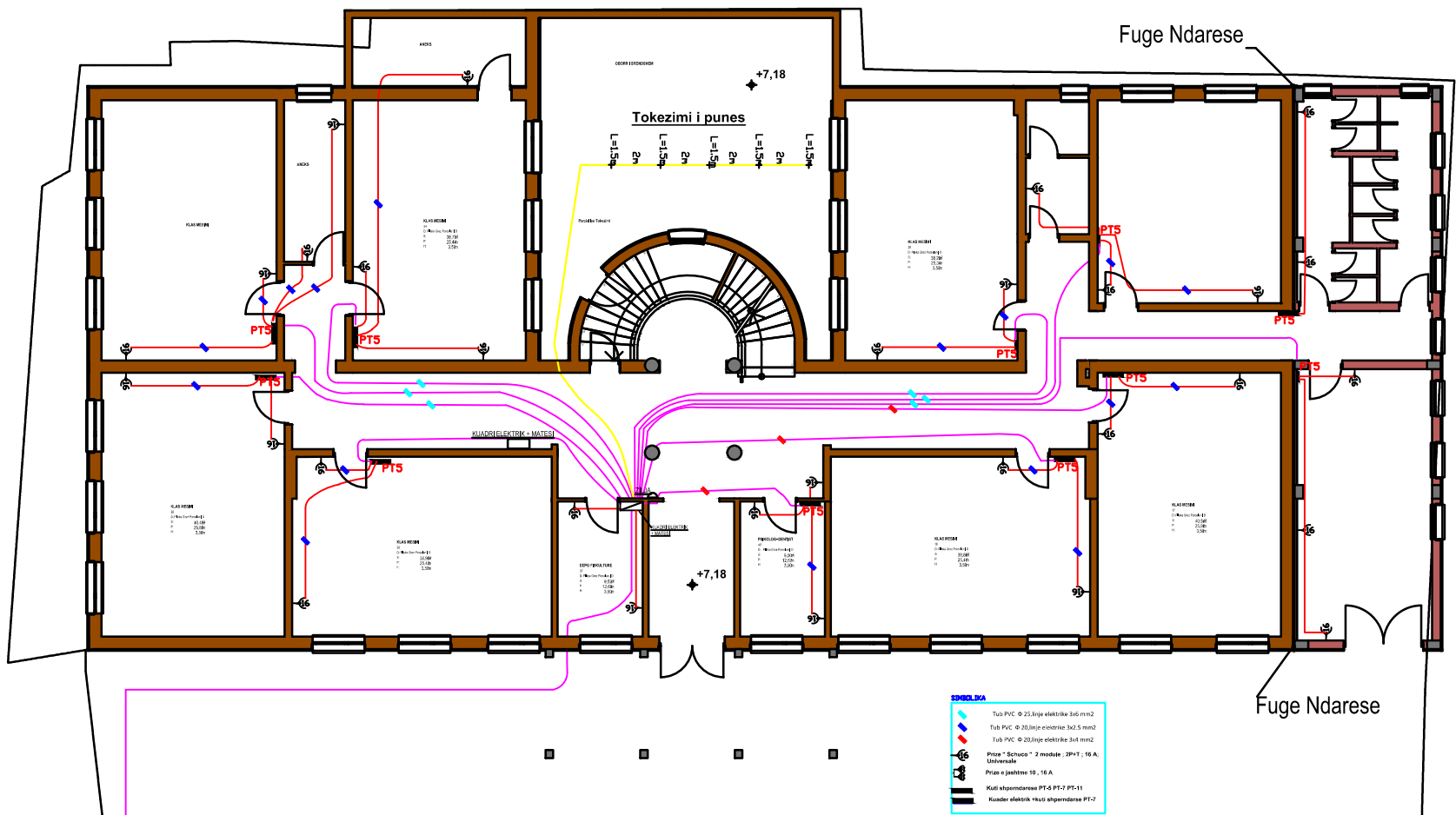

KASSET ELEKTRIKE OSHEE

 BASHKIA DURRËS	OBJEKTI: RIKONSTRUKSION SHKOLLE "JUSUF PUKA"		INSTALIMET ELEKTRIKE , LINJA E FURNIZIMIT	
	VENDODHJA : ARAPAJ ,DURRËS	EMER MBIEMER Ark. Adnand TOÇILA Ing .elek. Mariglen JAHOLLARI	FIRMA	2019
N J E S T I A E P R O J E K T I T D H E I N F R A S T R U K T U R E S	PROJEKTI : ARKITEKTONIK	GRUPI PROJEKTIMIT :	No. Fletes -11	
FAZA E PROJEKTIIT : PROJEKT ZBATIM				