



PARKU TEMATIK
KULTUROR
"TIRANA ART GARDEN"

Shënim

PROJEKTI KONSTRUKTIV

E 01

PARKU TEMATIK KULTUROR TIRANA ART GARDEN



Projektoi	E. BEJLERI
Arktekt	I. BEJLERI
Arktekt	K. DEMAJ
Arktekt	A. HALILAJ
Konstruktuar	M. HALILAJ
Ing. Elektrik	V. HOXHA
Ing. Hidroteknik	E. CANO
Ing. Mekanik	D. BUZI

	K 00
SHKALLA	



PLANIMETRIA EKZISTUESE

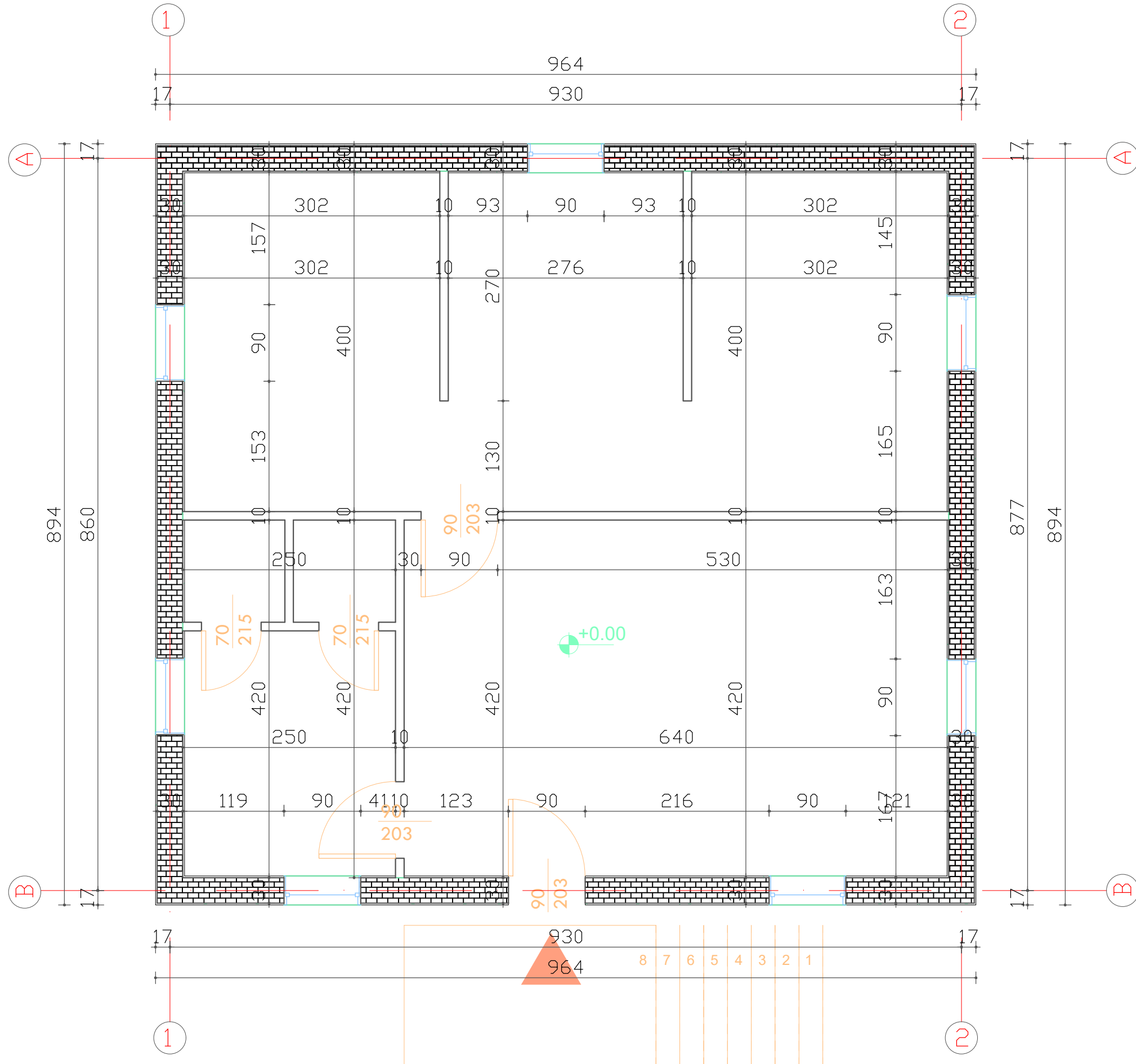

PARKU TEMATIK
KULTUROR
"TIRANA ART GARDEN"

Shënim

Projektant	E. BEJLERI
Arkitekt	I. BEJLERI
Arkitekt	K. DEMAJ
Arkitekt	A. HALILAJ
Konstruktore	M. HALILAJ
Ing. Elektrik	V. HOXHA
Ing. Hidroteknik	E. CANO
Ing. Mekanik	D. BUZI

SHIFALLA
1 : 50

K 01

KKAA

FONDI SHQIPTAR
I ZHVILLIMIT

A&E
ENGINEERING

SON

PLANIMETRIA E PERFORCIMIT

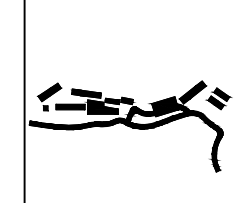

PARKU TEMATIK
KULTUROR
"TIRANA ART GARDEN"

Shënim

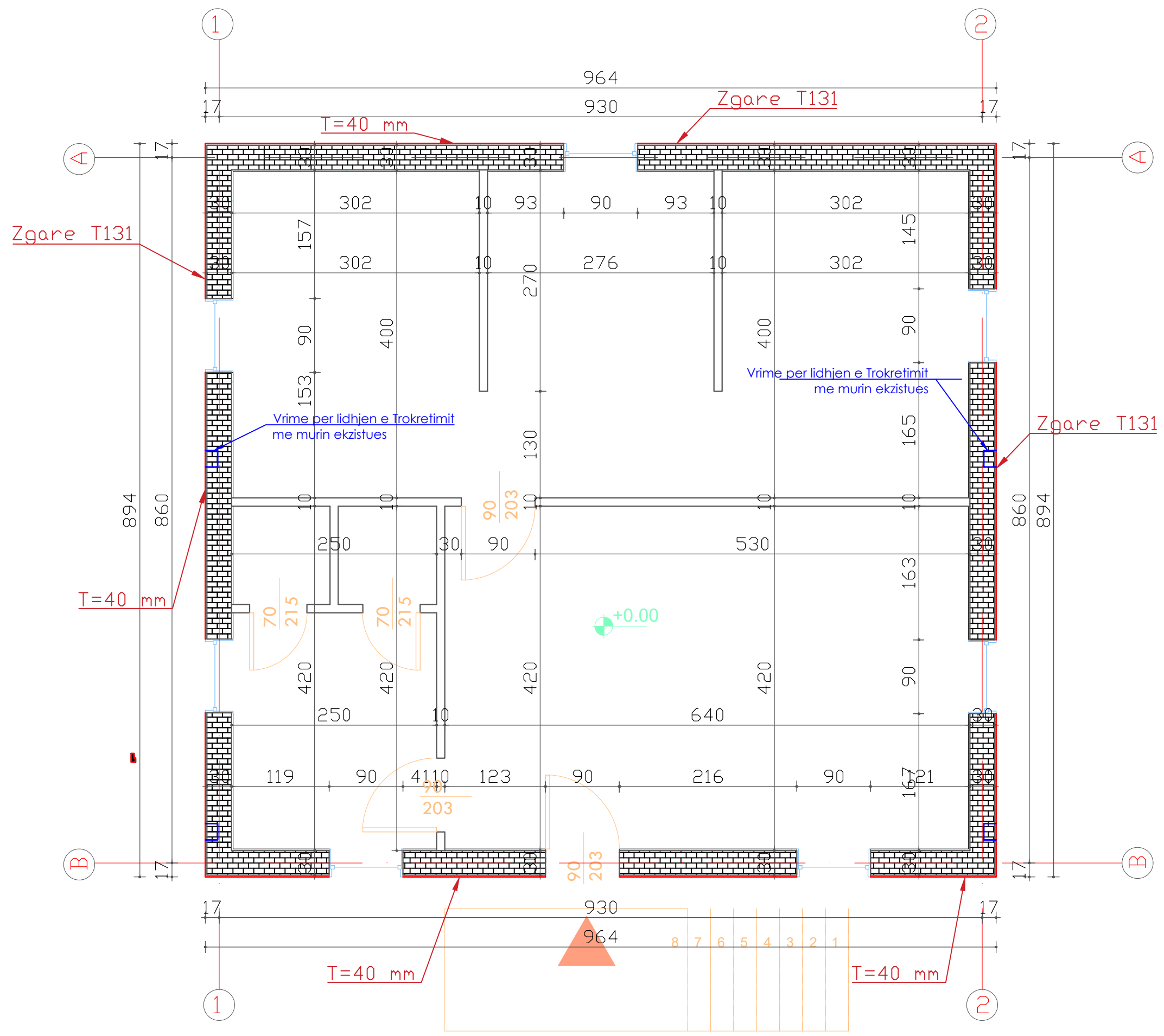

Projektoi	
Arkitekt	E. BEJLERI
Arkitekt	I. BEJLERI
Arkitekt	K. DEMAJ
Arkitekt	A. HALILAJ
Konstruktor	M. HALILAJ
Ing. Elektrik	V. HOXHA
Ing. Hidroteknik	E. CANO
Ing. Mekanik	D. BUZI

SHALLA
1 : 50

K 02



PRERJE STRUKTURORE

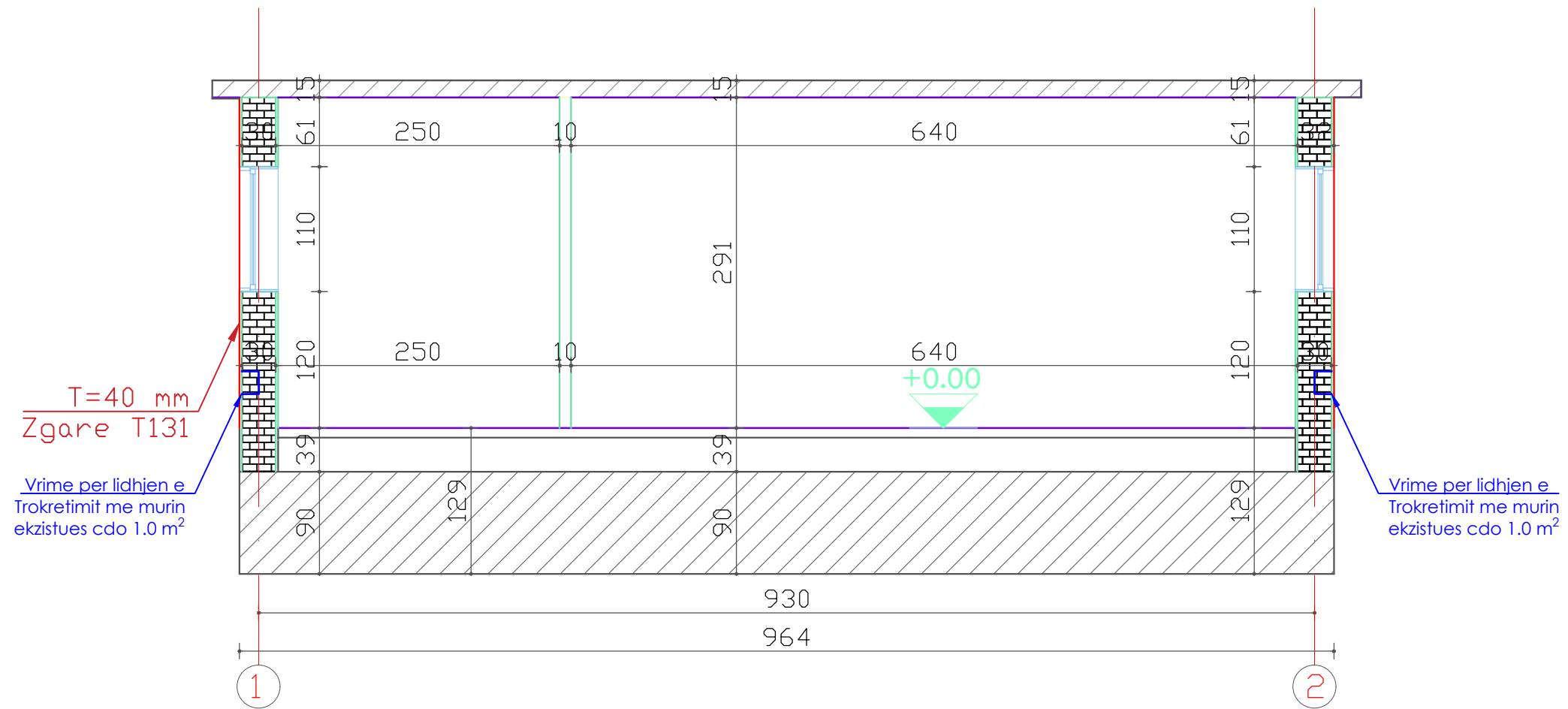

DETAJE TE PERFORCIMIT

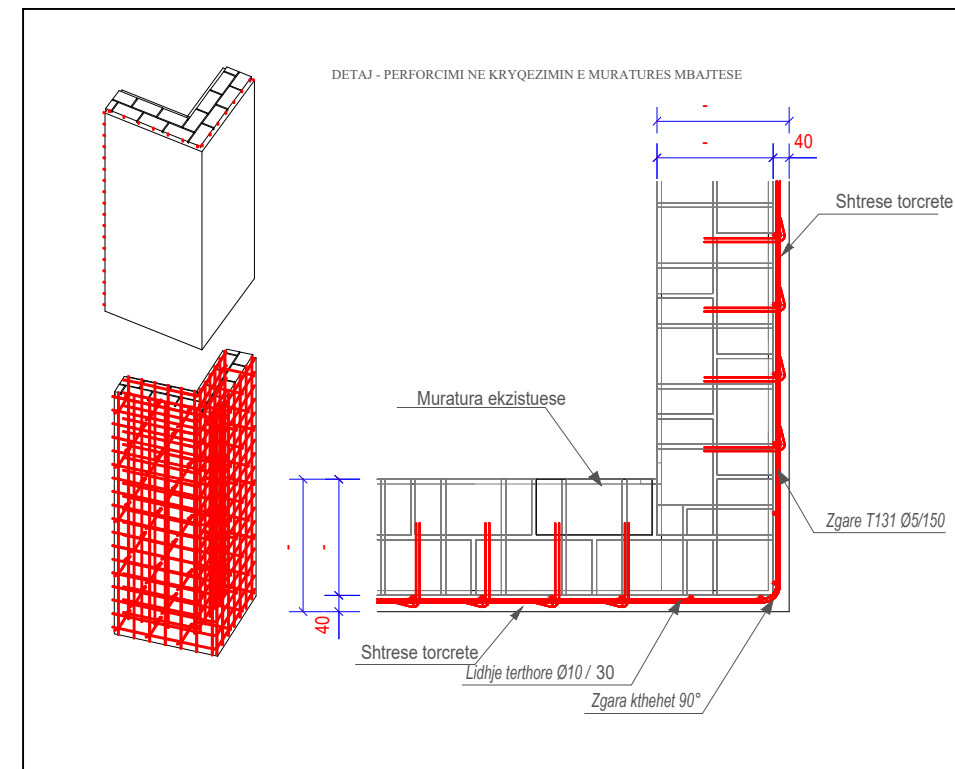
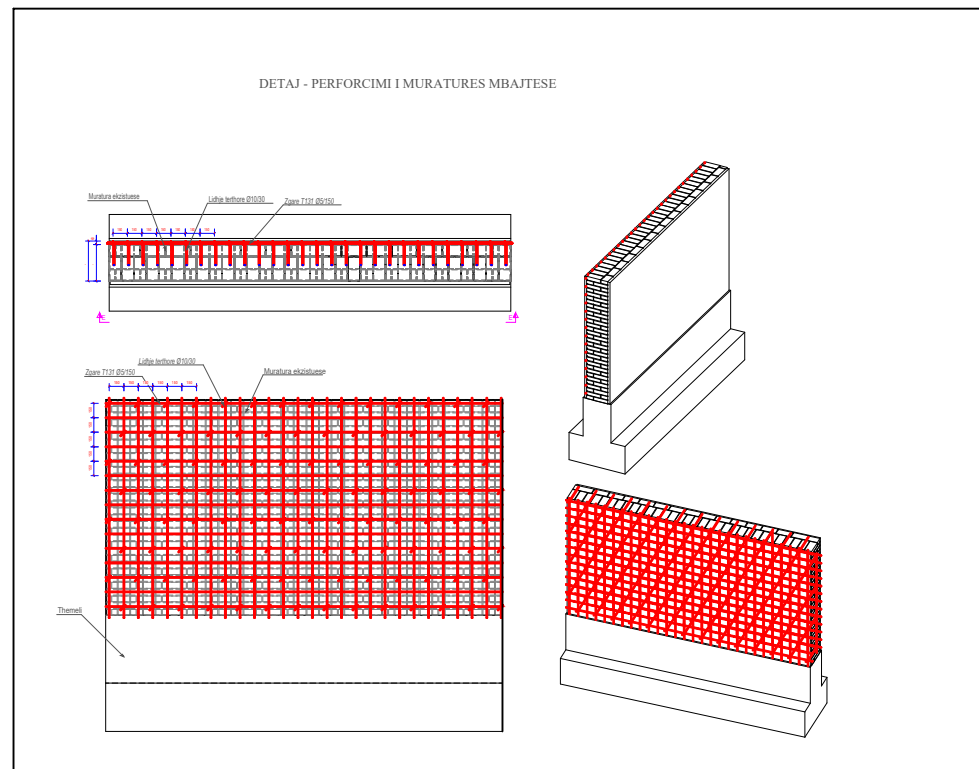

PARKU TEMATIK
KULTOROR
"TIRANA ART GARDEN"

Shënim

Projektant	E. BEJLERI
Arkitekt	I. BEJLERI
Arkitekt	K. DEMAJ
Arkitekt	A. HALILAJ
Konstruktore	M. HALILAJ
Ing. Elektrik	V. HOXHA
Ing. Hidroteknik	E. CANO
Ing. Mekanik	D. BUZI

SHIFALLA
1 : 50
1 : 25

K 03

KKAA

FONDI SHQIPTAR
I ZHVILLIMIT

A&E
ENGINEERING

SON



PARKU TEMATIK
KULTUROR
"TIRANA ART GARDEN"

Shënim

PROJEKTI KONSTRUKTIV

E 02

PARKU TEMATIK KULTUROR TIRANA ART GARDEN



Projektoi	E. BEJLERI
Arktekt	I. BEJLERI
Arktekt	K. DEMAJ
Arktekt	A. HALILAJ
Konstruktuar	M. HALILAJ
Ing. Elektrik	V. HOXHA
Ing. Hidroteknik	E. CANO
Ing. Mekanik	D. BUZI

SHKALLA	K 00
---------	------

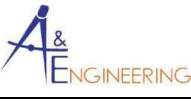

PLANIMETRIA EKZISTUESE



PARKU TEMATIK
KULTUROR
"TIRANA ART GARDEN"

Shënim

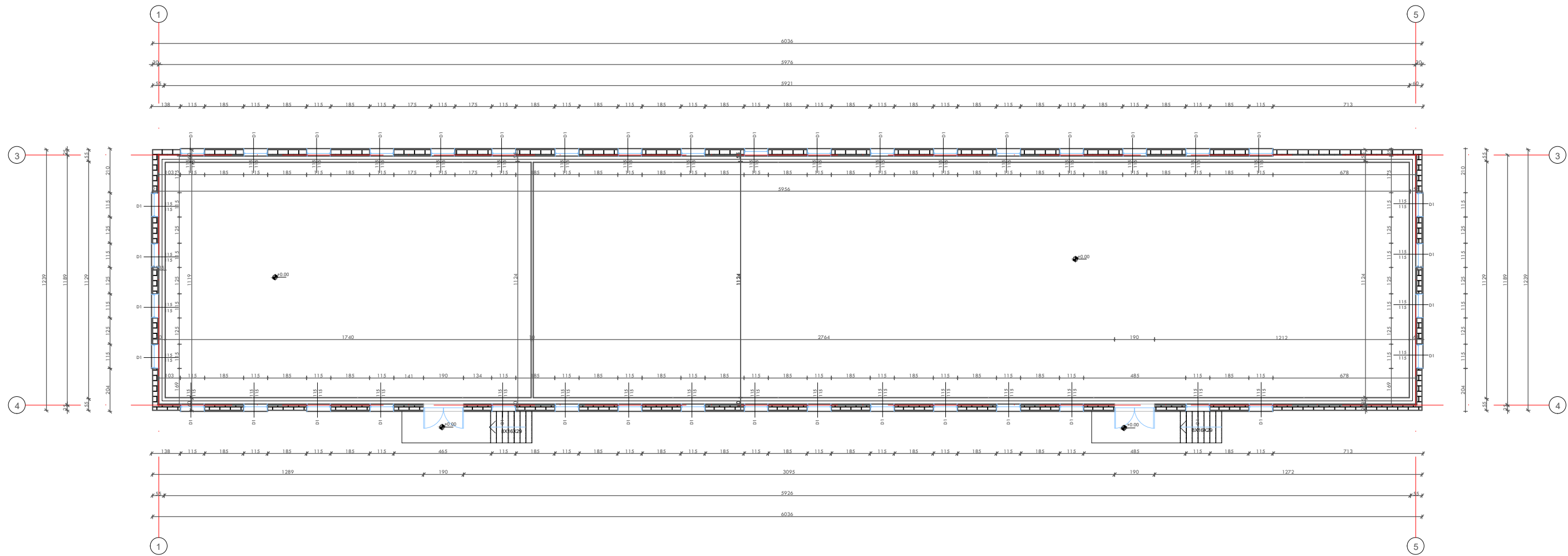

Projektant	E. BEJLERI
Arkitekt	I. BEJLERI
Arkitekt	K. DEMAJ
Arkitekt	A. HALILAJ
Konstruktor	M. HALILAJ
Ing. Elektrik	V. HOXHA
Ing. Hidroteknik	E. CANO
Ing. Mekanik	D. BUZI

SHIFALLA 1 : 200	K 01
---------------------	------

KKAA
KONSTRUKTORI KOMBEDUROR

FONDI SHQIPTAR
I ZHVILLIMIT

A&E
ENGINEERING

SON

PLANIMETRIA E PERFORCIMIT



PARKU TEMATIK
KULTUROR
"TIRANA ART GARDEN"

Shënim

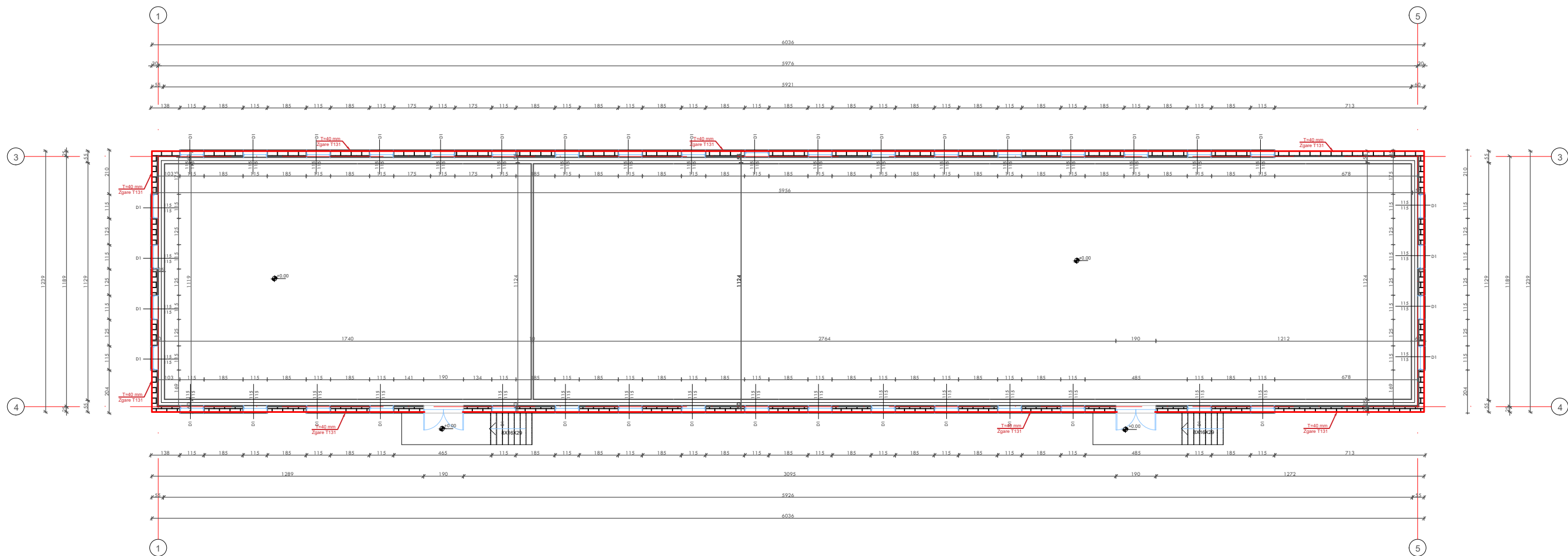

Projektoi	
Arkitekt	E. BEJLERI
Arkitekt	I. BEJLERI
Arkitekt	K. DEMAJ
Arkitekt	A. HALILAJ
Konstruktor	M. HALILAJ
Ing. Elektrik	V. HOXHA
Ing. Hidroteknik	E. CANO
Ing. Mekanik	D. BUZI

SHIFALLA	K 02



PRERJE STRUKTURE



PARKU TEMATIK
KULTUROR
"TIRANA ART GARDEN"

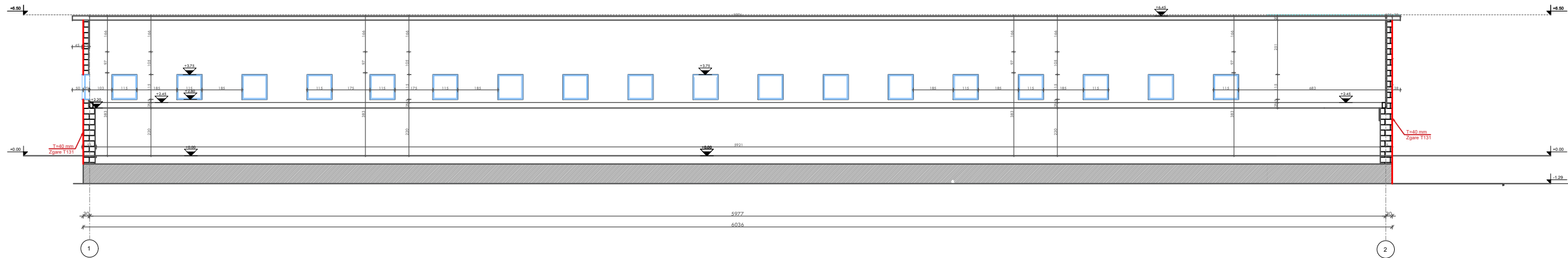

DETAJE TE PERFORCIMIT

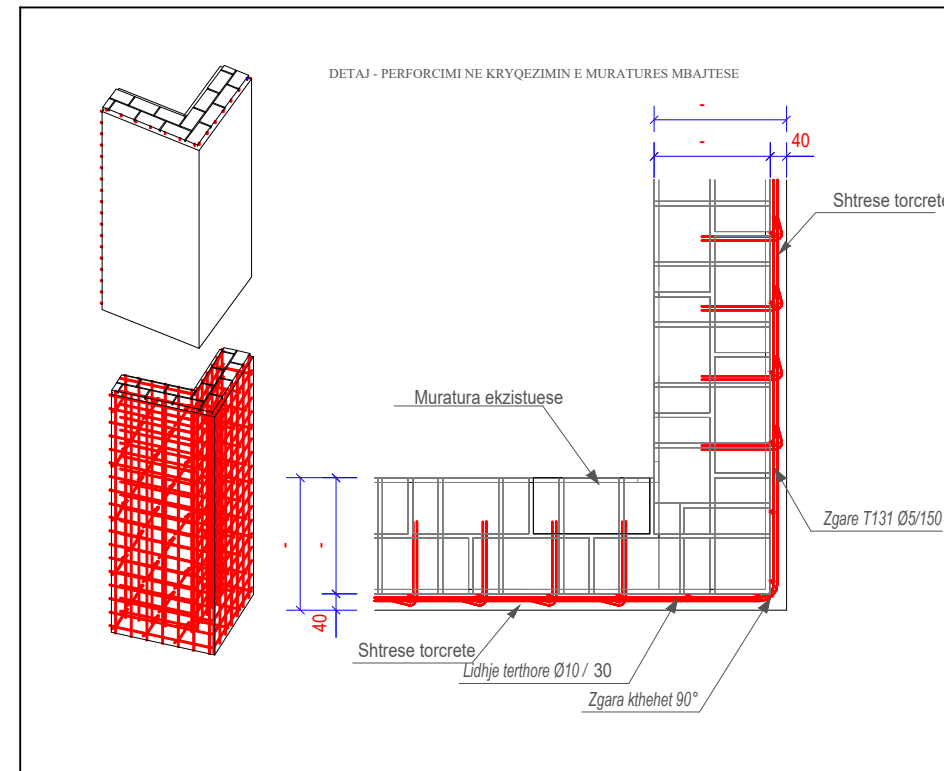
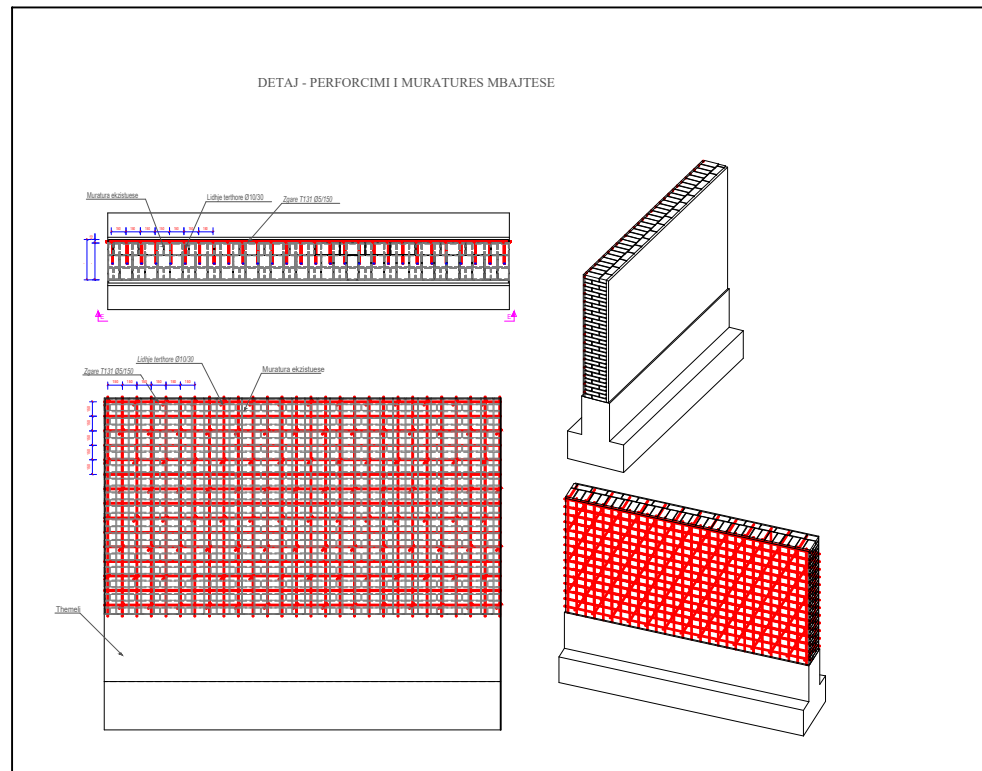

Shënim

Projektimi	E. BEJLERI
Arkititekt	I. BEJLERI
Arkititekt	K. DEMAJ
Arkititekt	A. HALILAJ
Konstruktor	M. HALILAJ
Ing. Elektrik	V. HOXHA
Ing. Hidroteknik	E. CANO
Ing. Mekanik	D. BUZI

K 03

SHALLA
1 : 200
1 : 25

KKAA
FONDI SHQIPTAR
I ZHVILLIMIT

A&E
ENGINEERING

SON



PARKU TEMATIK
KULTUROR
"TIRANA ART GARDEN"

Shënim

PROJEKTI KONSTRUKTIV

E 05

PARKU TEMATIK KULTUROR TIRANA ART GARDEN



Projektoi	E. BEJLERI
Arktekt	I. BEJLERI
Arktekt	K. DEMAJ
Arktekt	A. HALILAJ
Konstruktuar	M. HALILAJ
Ing. Elektrik	V. HOXHA
Ing. Hidroteknik	E. CANO
Ing. Mekanik	D. BUZI

SHKALLA	K 00
---------	------



PLANIMETRIA EKZISTUESE

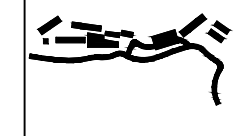
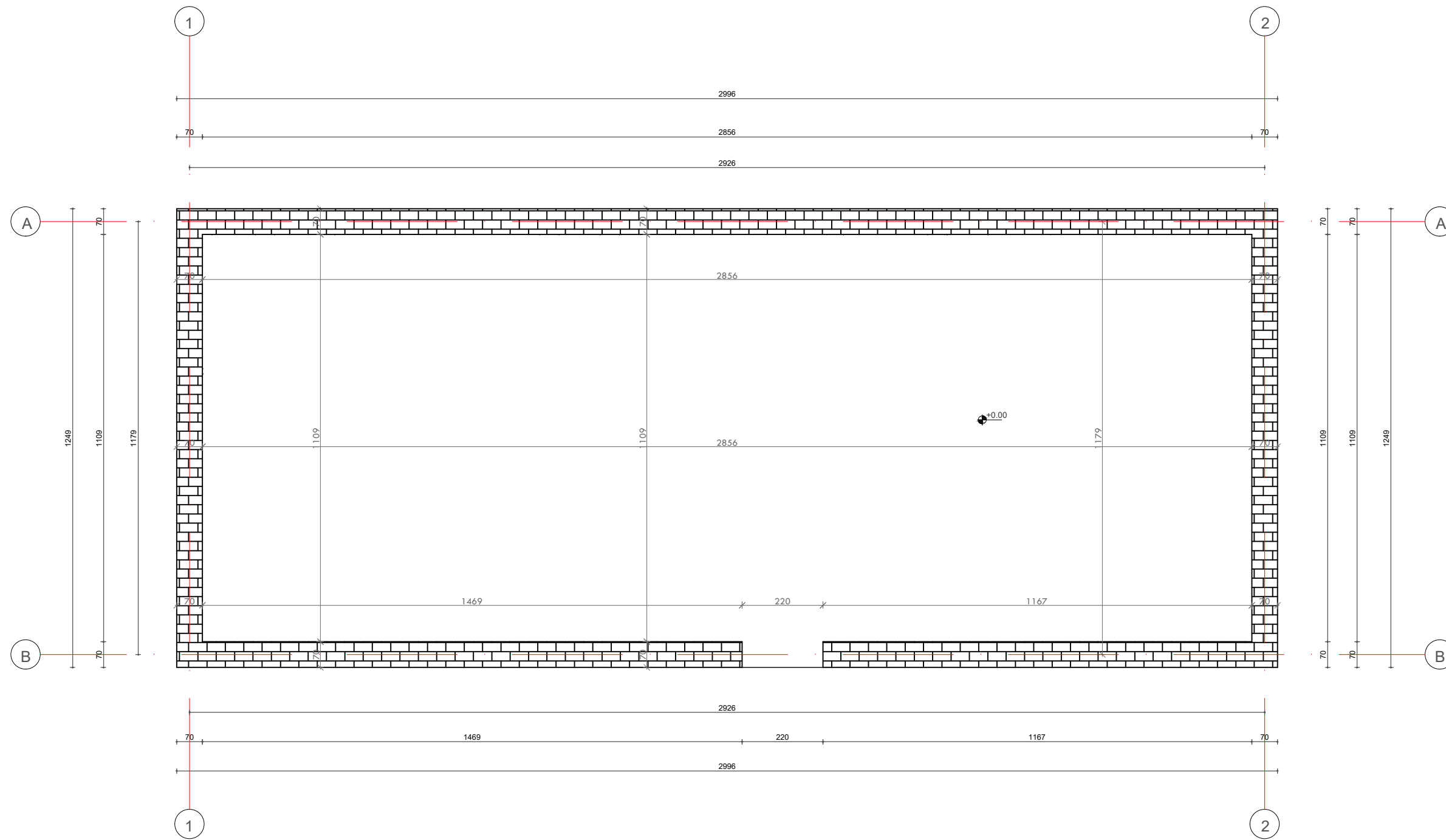

**PARKU TEMATIK
KULTUROR
"TIRANA ART GARDEN"**

Shënim

Projektant	E. BEJLERI
Arkitekt	I. BEJLERI
Arkitekt	K. DEMAJ
Arkitekt	A. HALILAJ
Konstruktor	M. HALILAJ
Ing. Elektrik	V. HOXHA
Ing. Hidroteknik	E. CANO
Ing. Mekanik	D. BUZI

SHIFRA
1 : 125

K 01



PLANIMETRIA E PERFORCIMIT

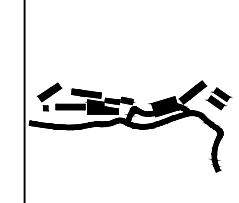
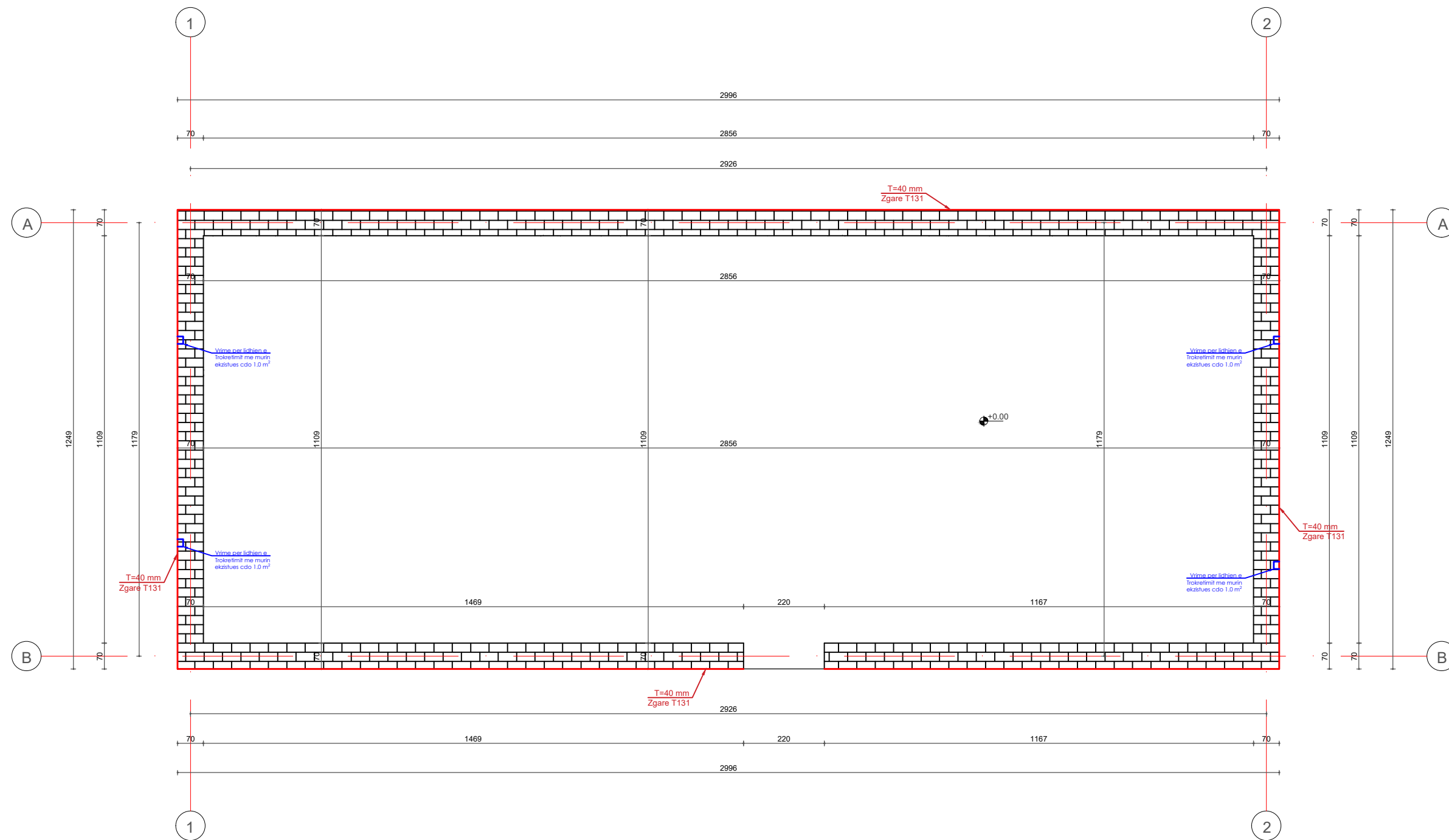

PARKU TEMATIK
KULTUROR
"TIRANA ART GARDEN"

Shënim

Projektant	E. BEJLERI
Arkitekt	I. BEJLERI
Arkitekt	K. DEMAJ
Arkitekt	A. HALILAJ
Konstruktor	M. HALILAJ
Ing. Elektrik	V. HOXHA
Ing. Hidroteknik	E. CANO
Ing. Mekanik	D. BUZI

SHIFALLA
1 : 125

K 02



PRERJE STRUKTURE

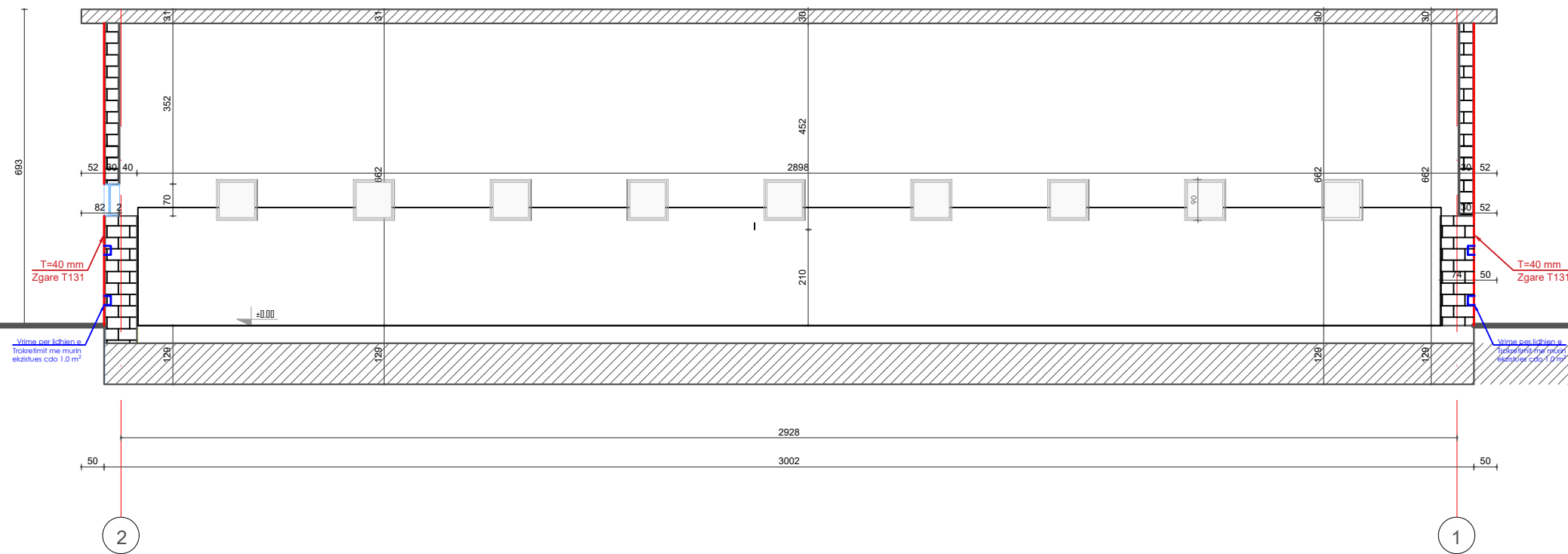

DETAJE TE PERFORCIMIT

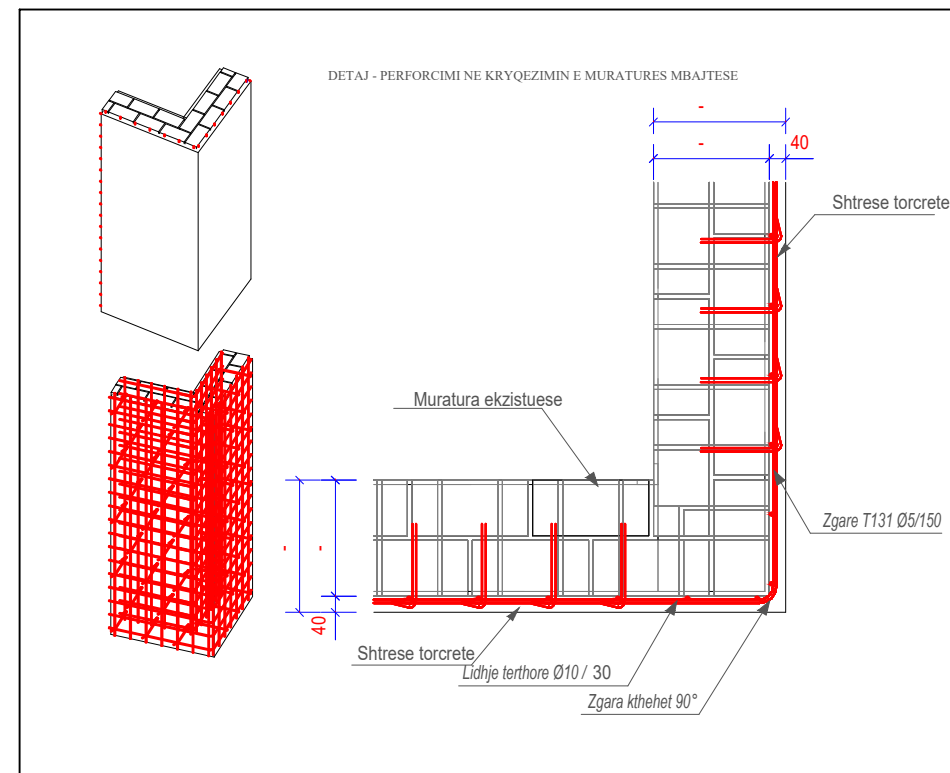
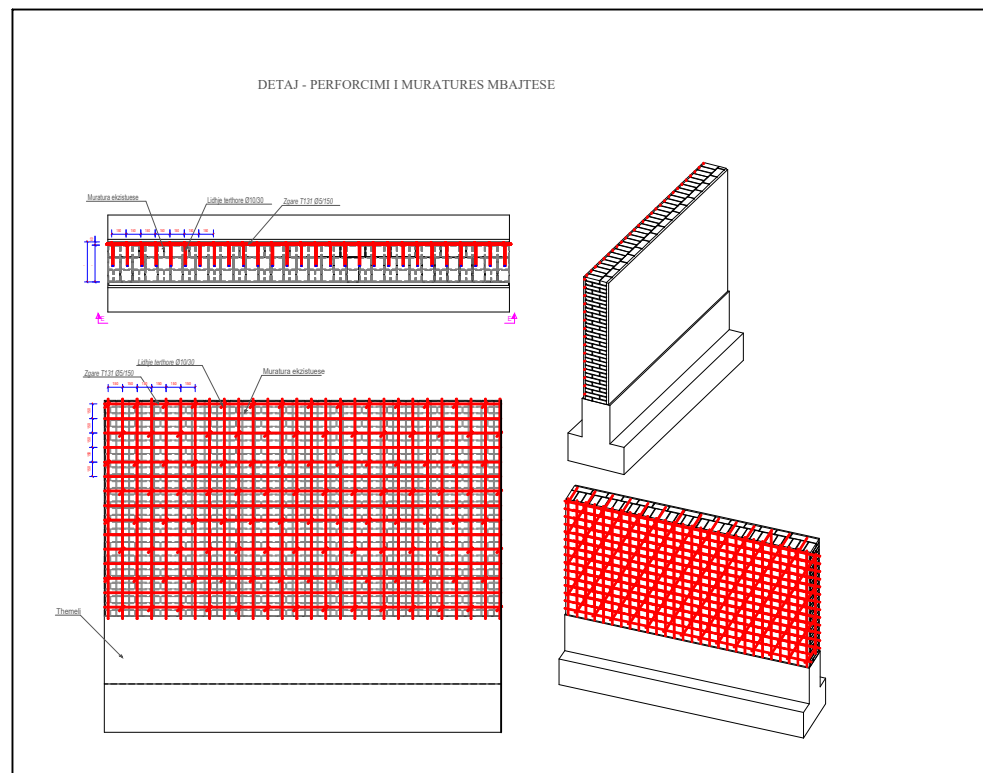

PARKU TEMATIK
KULTUROR
"TIRANA ART GARDEN"

Shënim

Projektimi	E. BEJLERI
Arkitekt	I. BEJLERI
Arkitekt	K. DEMAJ
Arkitekt	A. HALILAJ
Konstruktor	M. HALILAJ
Ing. Elektrik	V. HOXHA
Ing. Hidroteknik	E. CANO
Ing. Mekanik	D. BUZI

K 03

KKAA

FONDI SHQIPTAR
I ZHVILLIMIT

A&E
ENGINEERING

SON



PARKU TEMATIK
KULTUROR
"TIRANA ART GARDEN"

Shënim

PROJEKTI KONSTRUKTIV

E 06

PARKU TEMATIK
KULTUROR
TIRANA ART GARDEN



Projektoi	<i>E. BEJLERI</i>
Arktekt	<i>I. BEJLERI</i>
Arktekt	<i>K. DEMAJ</i>
Arktekt	<i>A. HALILAJ</i>
Konstruktuar	<i>M. HALILAJ</i>
Ing. Elektrik	<i>V. HOXHA</i>
Ing. Hidroteknik	<i>E. CANO</i>
Ing. Mekanik	<i>D. BUZI</i>

	K 00
SHIFALLA	



PLANIMETRIA EKZISTUESE



PARKU TEMATIK
KULTUROR
"TIRANA ART GARDEN"

Shënim

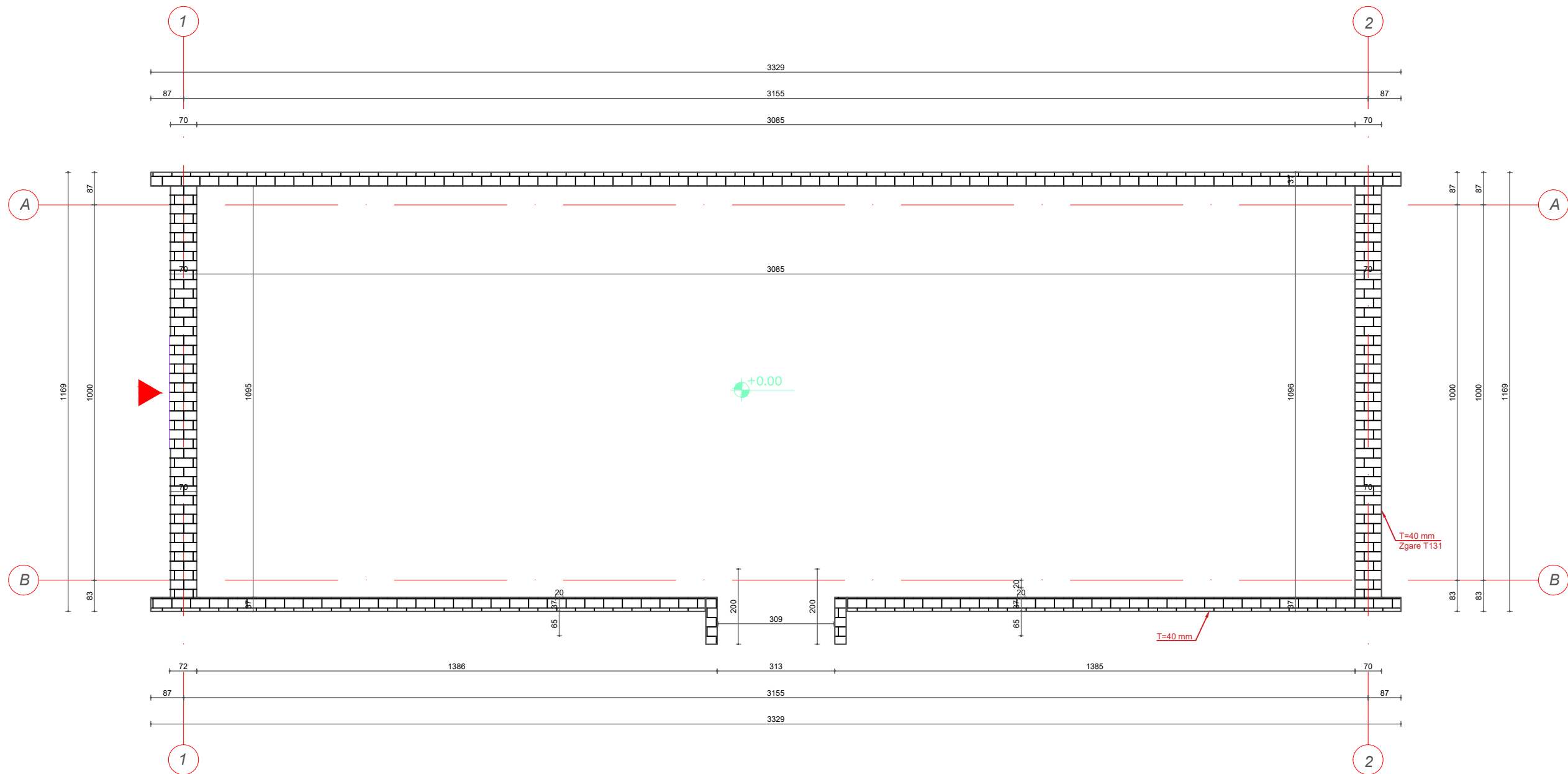

Projektimi	E. BEJLERI
Arkititekt	I. BEJLERI
Arkititekt	K. DEMAJ
Arkititekt	A. HALILAJ
Konstruktori	M. HALILAJ
Ing. Elektrik	V. HOXHA
Ing. Hidroteknik	E. CANO
Ing. Mekanik	D. BUZI

SHIFALLA	K 01
1 : 125	

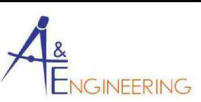

PLANIMETRIA E PERFORCIMIT



PARKU TEMATIK
KULTUROR
"TIRANA ART GARDEN"

Shënim

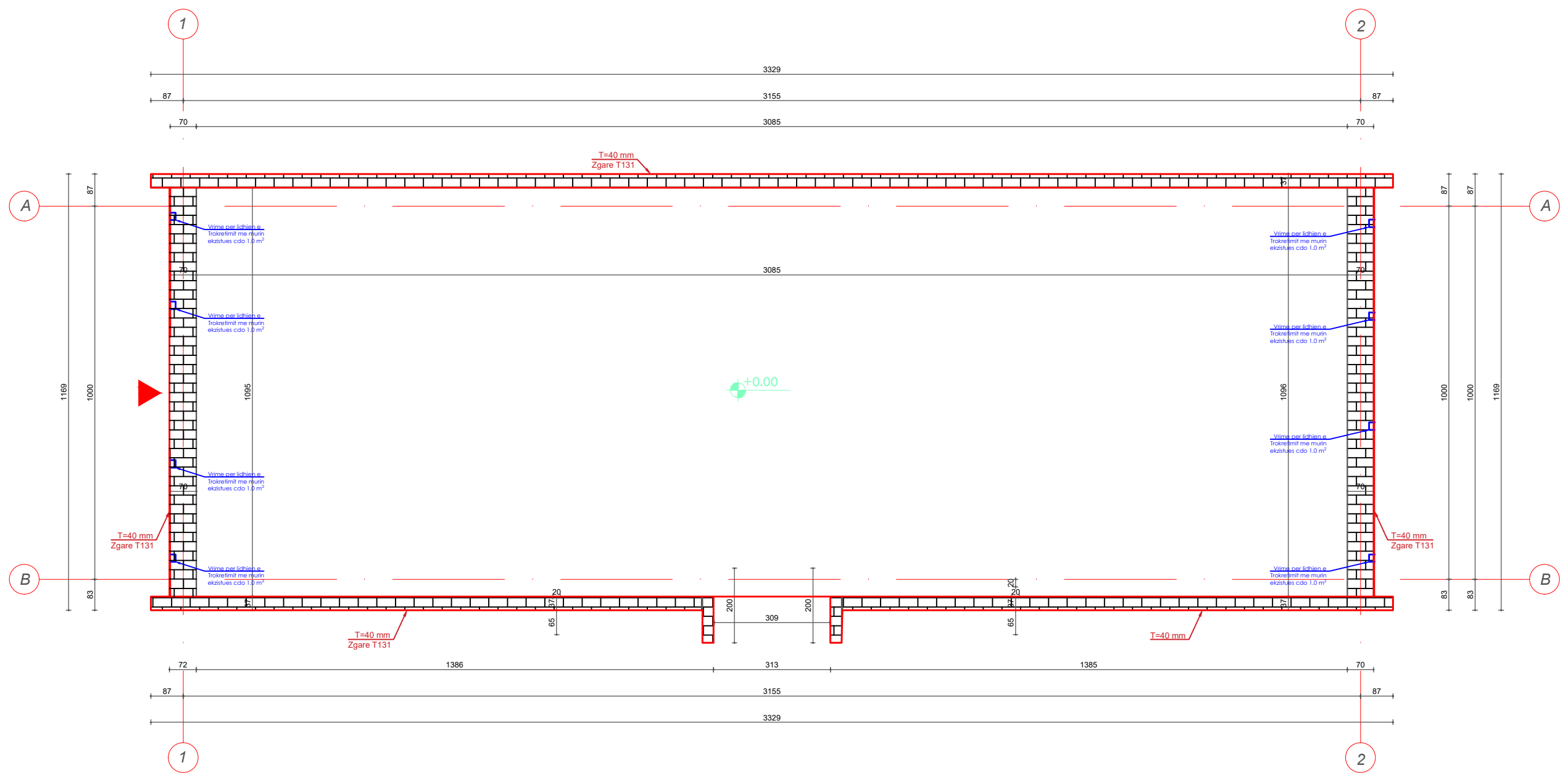

Projektor	E. BEJLERI
Arktekt	I. BEJLERI
Arktekt	K. DEMAJ
Arktekt	A. HALILAJ
Konstruktor	M. HALILAJ
Ing. Elektrik	V. HOXHA
Ing. Hidroteknik	E. CANO
Ing. Mekanik	D. BUZI

SHIFALLA
1 : 125

K 02

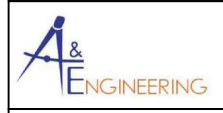

PRERJE STRUKTURE



PARKU TEMATIK
KULTUROR
"TIRANA ART GARDEN"

Shënim

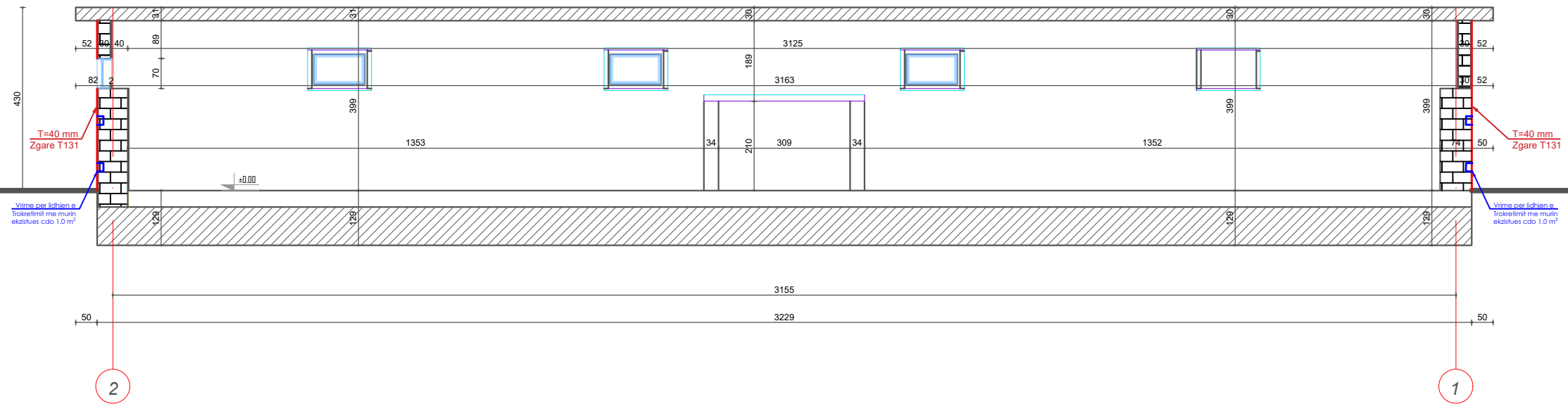

DETAJE TE PERFORCIMIT

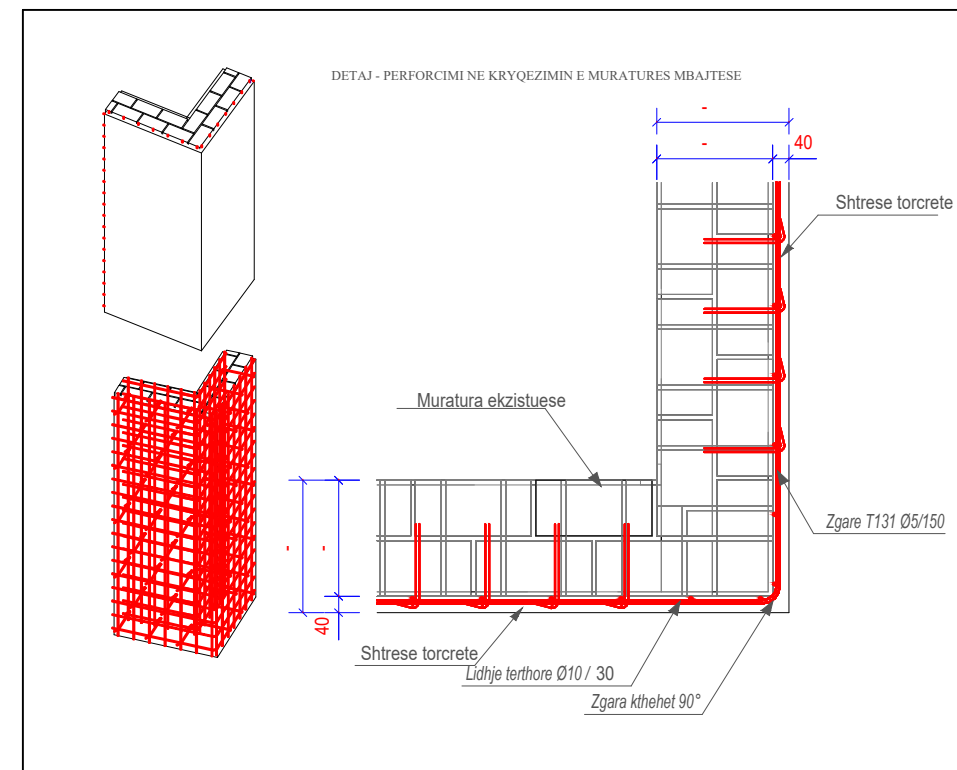
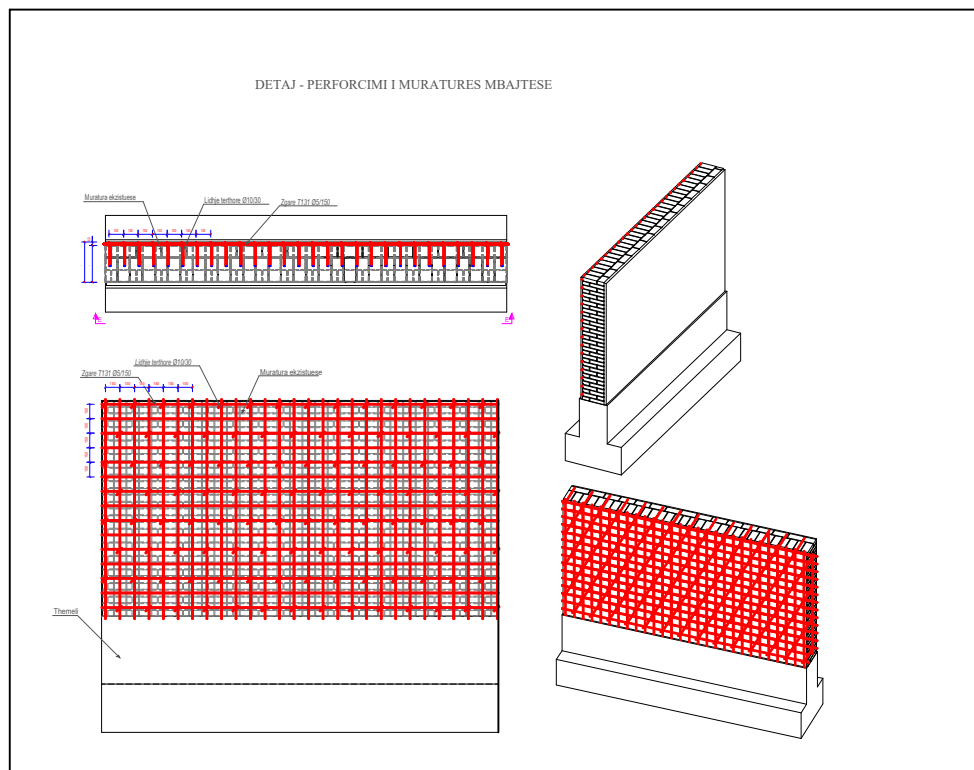

Projektant	E. BEJLERI
Arkitekt	I. BEJLERI
Arkitekt	K. DEMAJ
Arkitekt	A. HALILAJ
Konstruktor	M. HALILAJ
Ing. Elektrik	V. HOXHA
Ing. Hidroteknik	E. CANO
Ing. Mekanik	D. BUZI

K 03

SHALLA
1 : 125
1 : 25

KKAA
FONDI SHQIPTAR
I ZHVILLIMIT

A&ENGINEERING

SON



PARKU TEMATIK
KULTUROR
"TIRANA ART GARDEN"

Shënim

PROJEKTI KONSTRUKTIV

E 07

PARKU TEMATIK
KULTUROR
TIRANA ART GARDEN



Projekti	
Arktekt	E. BEJLERI
Arktekt	I. BEJLERI
Arktekt	K. DEMAJ
Arktekt	A. HALILAJ
Konstrukt	M. HALILAJ
Ing. Elektrik	V. HOXHA
Ing. Hidroteknik	E. CANO
Ing. Mekanik	D. BUZI

	K 00
SHKALLA	



PLANIMETRIA EKZISTUESE



PARKU TEMATIK
KULTUROR
"TIRANA ART GARDEN"

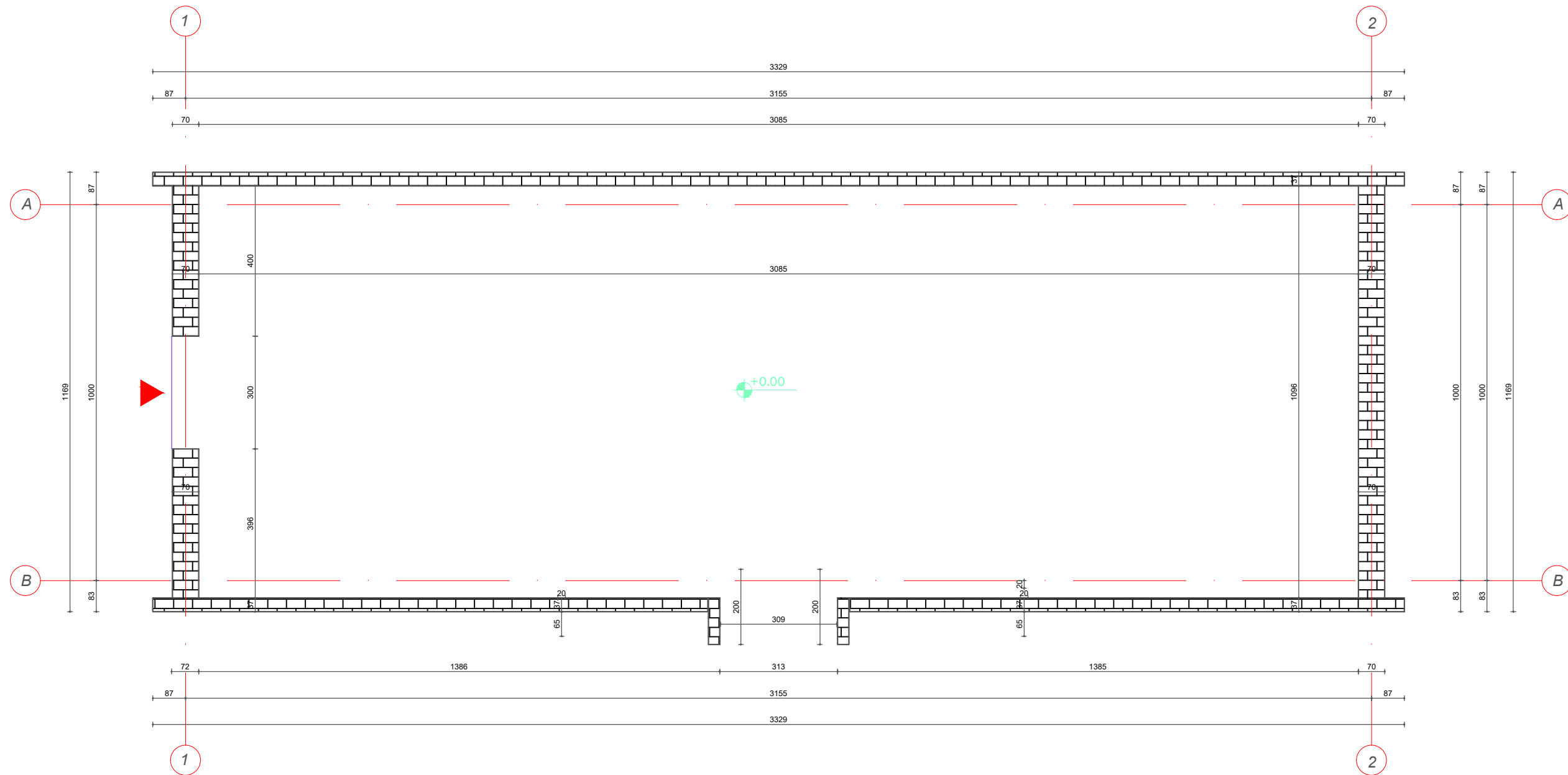

Shënim

Projektoi	
Arkitekt	E. BEJLERI
Arkitekt	I. BEJLERI
Arkitekt	K. DEMAJ
Arkitekt	A. HALILAJ
Konstruktor	M. HALILAJ
Ing. Elektrik	V. HOXHA
Ing. Hidroteknik	E. CANO
Ing. Mekanik	D. BUZI

SHIFALLA	K 01
1 : 125	

KKAA



FONDI SHQIPTAR
I ZHVILLIMIT

A&
ENGINEERING

SON

PLANIMETRIA E PERFORCIMIT



PARKU TEMATIK
KULTUROR
"TIRANA ART GARDEN"

Shënim

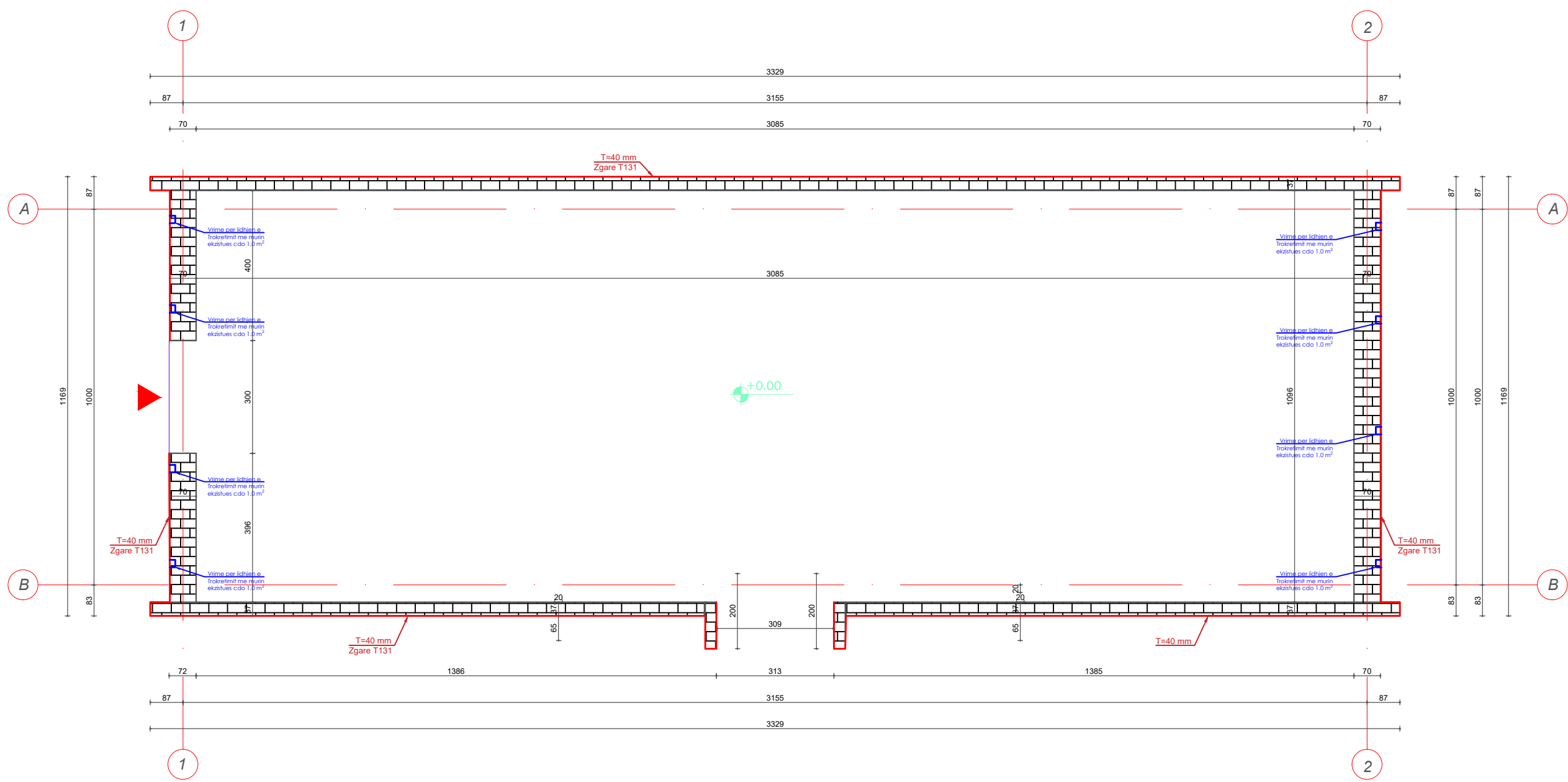

Projektimi	E. BEJLERI
Arkititekt	I. BEJLERI
Arkititekt	K. DEMAJ
Arkititekt	A. HALILAJ
Konstruktor	M. HALILAJ
Ing. Elektrik	V. HOXHA
Ing. Hidroteknik	E. CANO
Ing. Mekanik	D. BUZI

SHIFRA
1 : 125

K 02

KKAA
KONSTRUKTORI KALIBRUE

**FONDI SHQIPTAR
I ZHVILLIMIT**

**A&E
ENGINEERING**

SON

PRERJE STRUKTURE

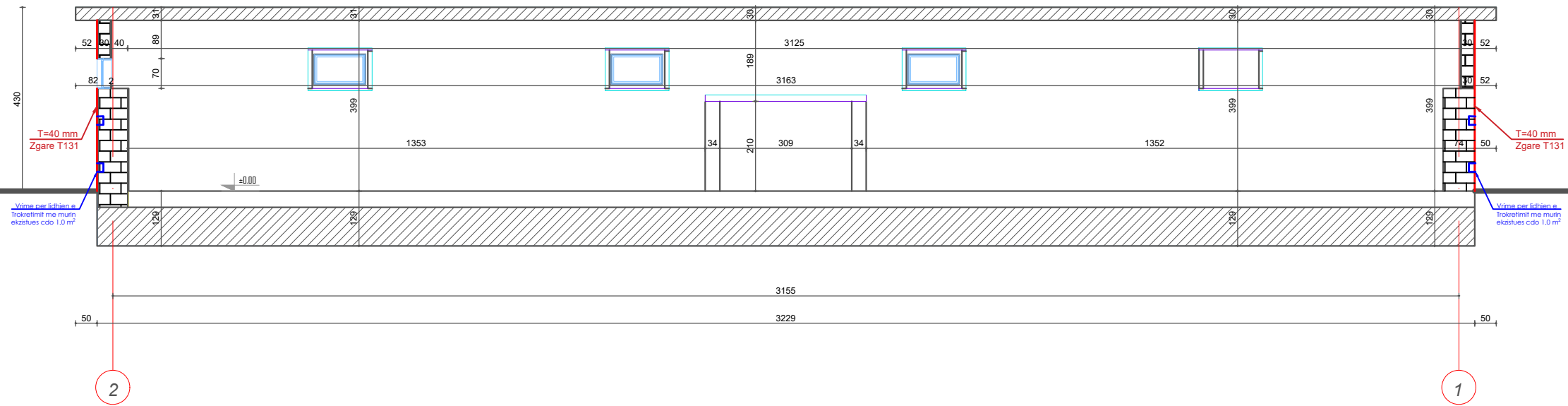

DETAJE TE PERFORCIMIT

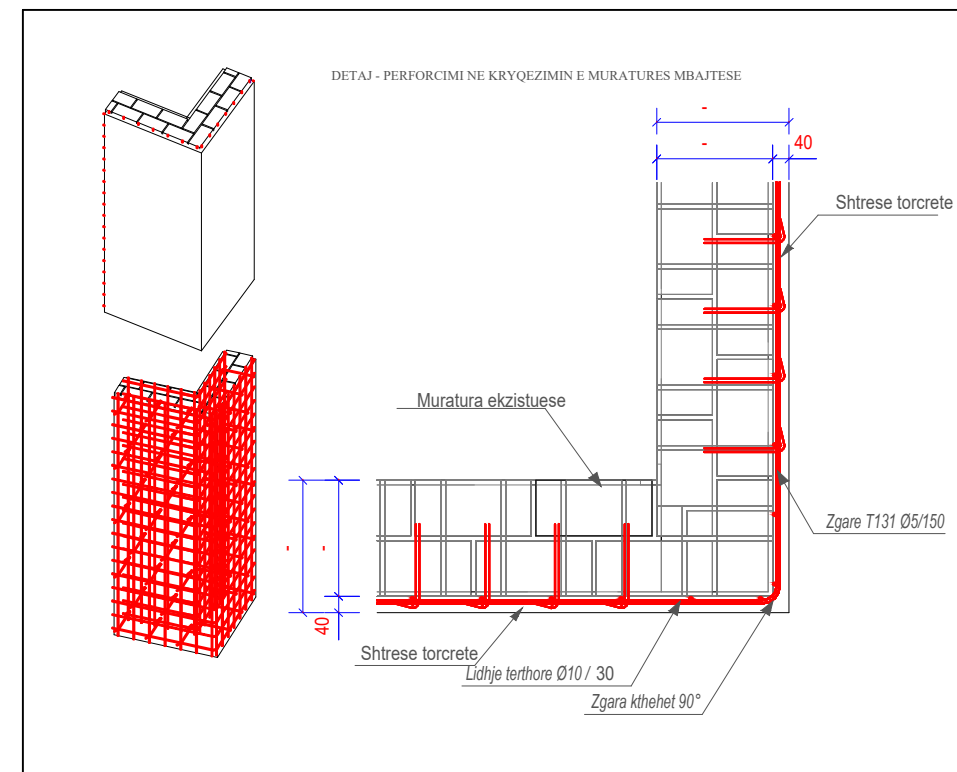
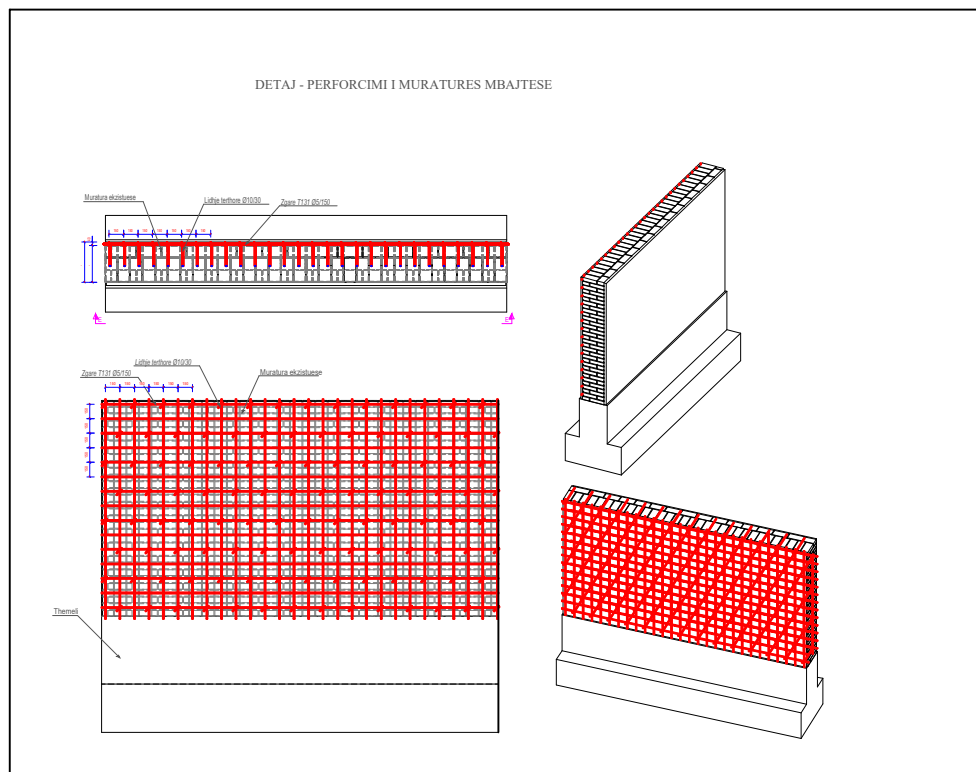

PARKU TEMATIK
KULTUROR
"TIRANA ART GARDEN"

Shënim:

Projektant	E. BEJLERI
Arkitekt	I. BEJLERI
Arkitekt	K. DEMAJ
Arkitekt	A. HALILAJ
Konstruktor	M. HALILAJ
Ing. Elektrik	V. HOXHA
Ing. Hidroteknik	E. CANO
Ing. Mekanik	D. BUZI

K 03

KKAA



FONDI SHQIPTAR
I ZHVILLIMIT

A&E
ENGINEERING

SON