

- ① TELI I RRJETES d≥ 3mm
 - ② SIDE WIRE (CURB)
 - ③ PERDREDHJA DYFISHE
 - ④ AKSI PERDREDHJES DYFISHE
- D - DIAMETRI I HOJES D = 6 cm

DETAJ I HOJEVE

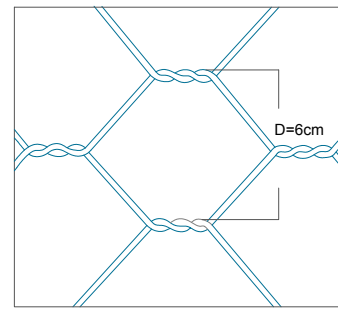

LIDHJA E RRJETAVE ME TEL XINGATO

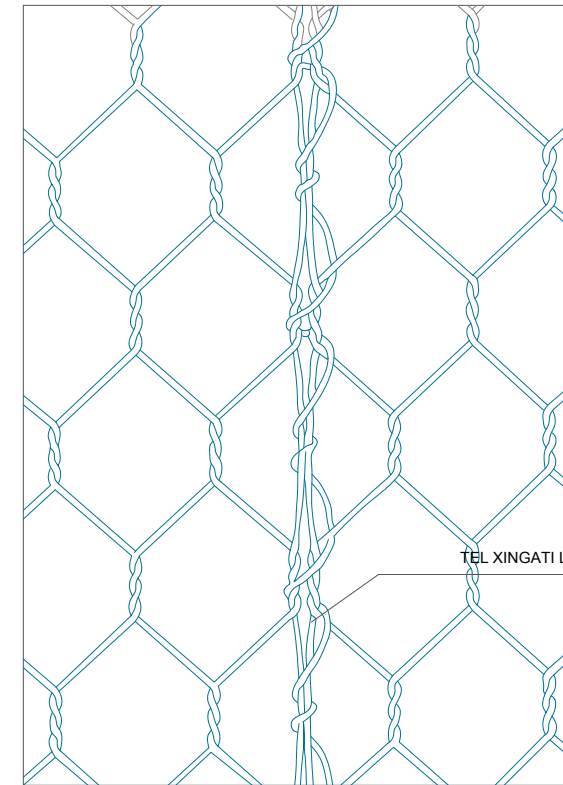

PAMJE E RULONIT TE RRJETES SE GABIONIT

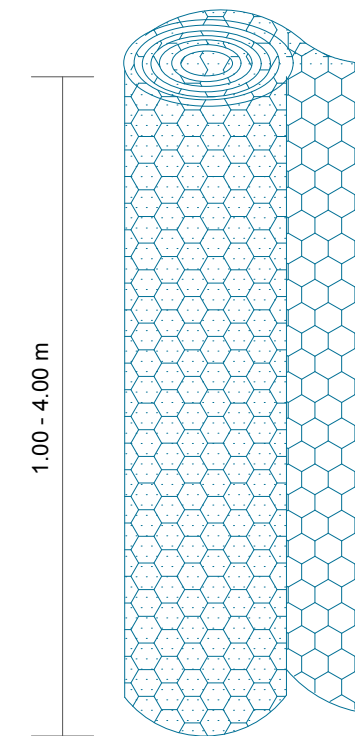

Emërtimi i Objektit
PROJEKT - ZBATIM

HARTIM PROJEKTI MBROJTJA DHE SISTEMIMI ME PRITA MALORE I PËRROIT TË GOMSIQES

Blerësi
Korporata Elektroenergjitike Shqiptare Sh.a

KESH

Adresa: Rruga "Viktor Eftimi" Blloku "Vasil Shanto" Tiranë

Furnizuesi

"NET-GROUP" shpk	"ARABEL STUDIO" shpk
L.72023002P	LS1812001S
Adresa: Rruga "Viktor Eftimi" Blloku "Vasil Shanto" Tiranë	Adresa: Rruga "Viktor Eftimi" Blloku "Vasil Shanto" Tiranë

GRUPI I PROJEKTIMIT

Ing. Gjeolog Valter Begaj GJ. 0324/2	Ing. Ndërtimi Ilirian Kokalari K. 1008/3
Ing. Hidroteknik Luljeta Kuci K. 2022/1	Ing. Ndërtimi Luca Falasca K. 2774
Arkitekt Diana Mitrusi A. 0212/4	Ing. Mjedisi Gentjana Luka M. 1613
Ing. Elektrik Burhan Demneri E. 1049/2	Arkitekt Aldo Dushi A. 1982/1
Ing. Mekanik Gjergji Kotori M. 0579/1	Ing. Gjeoinformatik Elfat Shehu T. 1577
Ing. Gjeodet Shqiponja Civici T. 1268	Ing. Gjeodet Marsilda Ferko T. 1582
Ing. Ndërtimi Ermal Spahiu K. 1084/1	Ing. Gjeodet Dimitër Kono T. 1609

Emërtimi i Fletes

Lidhja e rrjetave me tel xingato

Shkalla
1 :

P1SH-06-2023

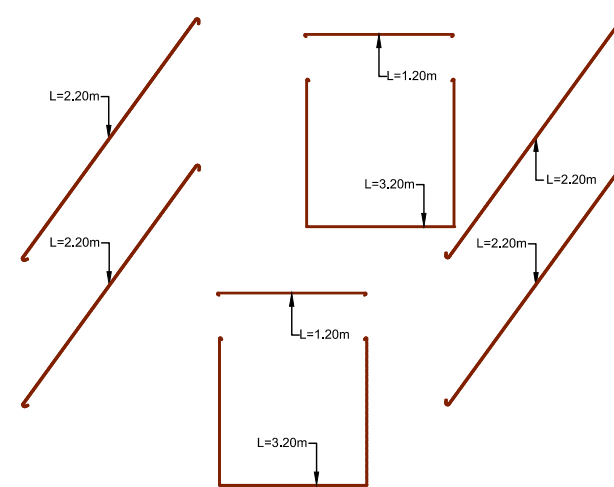
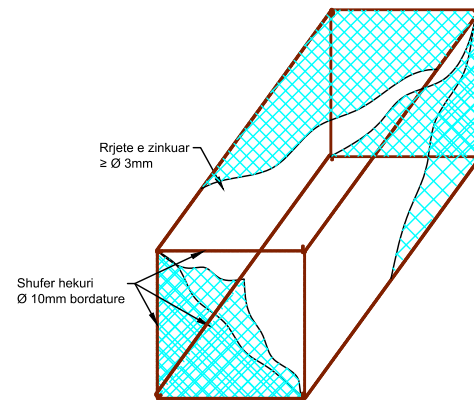
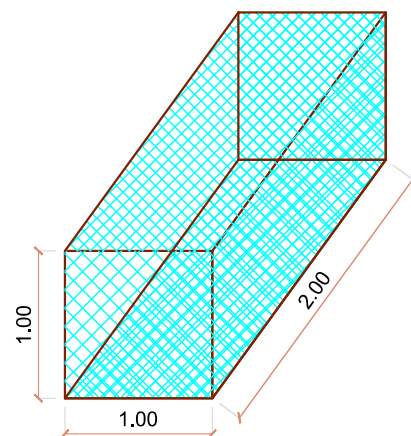
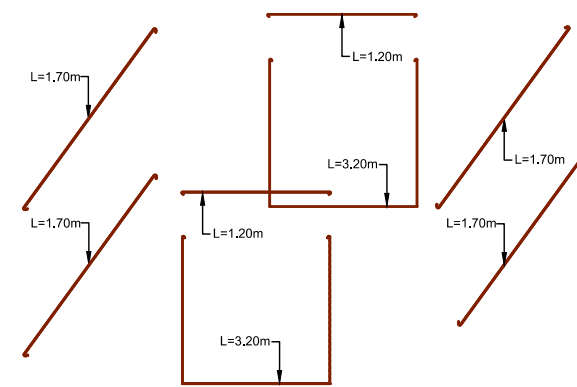
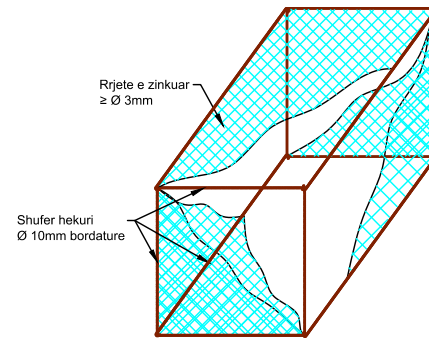
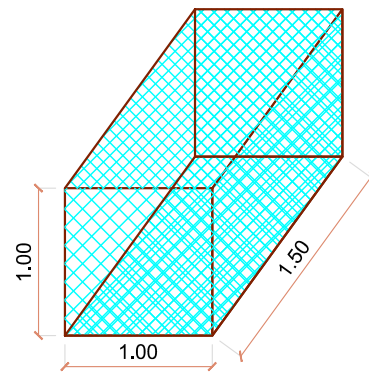
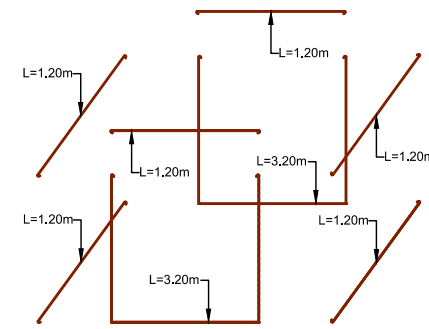
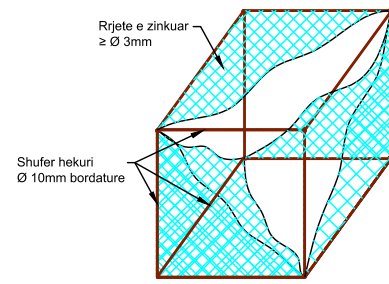
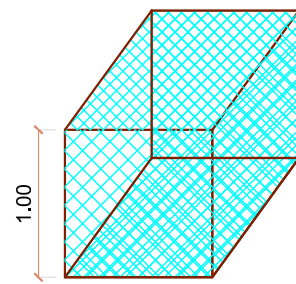

Emërtimi i Objektivit
PROJEKT - ZBATIM

HARTIM PROJEKTI MBROJTJA DHE SISTEMIMI ME PRITA MALORE I PËRROIT TË GOMSIQES

Blerësi
Korporata Elektroenergjitike Shqiptare Sh.a

Adresa: Rruga "Viktor Eftimi" Blloku "Vasil Shanto" Tiranë

Furnizuesi

"NET-GROUP" shpk	"ARABEL STUDIO" shpk
L.72023002P	LS1812001S
Adresa: Rruga "Viktor Eftimi" Blloku "Vasil Shanto" Tiranë	Adresa: Rruga "Viktor Eftimi" Blloku "Vasil Shanto" Tiranë

GRUPI I PROJEKTIMIT

Ing. Gjeolog Valter Begaj GJ. 0324/2	Ing. Ndërtimi Ilirian Kokalari K. 1008/3
Ing. Hidroteknik Luljeta Kuci K. 2022/1	Ing. Ndërtimi Luca Falasca K. 2774
Arkitekt Diana Mitrushi A. 0212/4	Ing. Mjedis Gentjana Luka M. 1613
Ing. Elektrik Burhan Demneri E. 1049/2	Arkitekt Aldo Dushi A. 1982/1
Ing. Mekanik Gergji Kotori M. 0579/1	Ing. Gjeoinformatik Elfat Shehu T. 1577
Ing. Gjeodet Shqiponja Civici T. 1268	Ing. Gjeodet Marsilda Ferko T. 1582
Ing. Ndërtimi Ermal Spahiu K. 1084/1	Ing. Gjeodet Dimitër Kono T. 1609

Emërtimi i Fletes

Elementet e karkases se gabionave

Shkalla
1 :

P1SH - 07-2023

Betonim i shkalleve ne kontakt me prurjet lumore me pllaka te derdhura ne vend (1x2)m me fuge 2cm

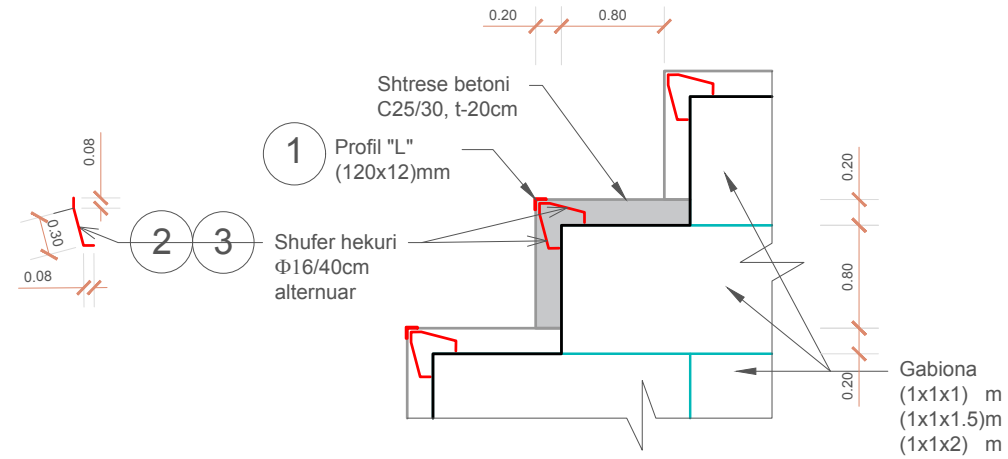

Shkallet e kaperderdhesit me pllaka betoni (1x2)m - konstrukcion hekuri / ml

ELEMENTI		Numri elementit	Φ mm / profil L	Gjatesia cm	Sasia cope	Gjatesia totale ml	Armatura Permbledhese				
Iloji	cope						Φ mm / profil L	gjatesia ml	Pesha kg	Totali Kg	
Pllaka b/a, shtrese betoni 20cm, beton C25/30	1 cope, dim.(1+1)2 m	1	120x12	200	1	2	120x12	2	21,478	42,956	
		2	16	46	2,5	1,15	16	2,3	1,58	3,634	
		3	16	46	2,5	1,15					
							Hekur	kg		46,590	
							b/a C25/30	m3			0,80
Sasia per 1 ml, ose (1+1)1m											
	ml							Hekur	kg		23,295
						b/a C25/30	m3			0,40	

Shenime Teknike:

Betoni qe do te perdoret per veshjen e pragut te kaperderdhesit dhe pergjate renjes se pragut, si dhe pragu i portalit te pusit te shuarjes se energjise te jete i klases C25/30, kurse hekuri S500.

Emërtimi i Objektit PROJEKT - ZBATIM	Blerësi Korporata Elektroenergjitike Shqiptare Sh.a KESH Adresa: Rruga "Viktor Eftimi" Blloku "Vasil Shanto" Tiranë	Furnizuesi		GRUPI I PROJEKTIMIT				Emërtimi i Fletes Detaji i betonimit te shkalleve ne kontakt me prurjet lumore	Shkalla 1 : 50
		"NET-GROUP" shpk  L.72023002P Adresa: Rruga "Viktor Eftimi" Blloku "Vasil Shanto" Tiranë	"ARABEL STUDIO" shpk  LS1812001S Adresa: Rruga "Viktor Eftimi" Blloku "Vasil Shanto" Tiranë	Ing. Gjeolog Valter Begaj GJ. 0324/2 Ing. Hidroteknik Luljeta Kuci K. 2022/1 Arkitekt Diana Mitrusi A. 0212/4 Ing. Elektrik Burhan Demneri E. 1049/2 Ing. Mekanik Gjegji Kotori M. 0579/1 Ing. Gjeodet Shqiponja Civici T. 1268 Ing. Ndërtimi Ermal Spahiu K. 1084/1	Ing. Ndërtimi Ilirian Kokalari K. 1008/3 Ing. Ndërtimi Luca Falasca K. 2774 Ing. Mjedisi Gentjana Luka M. 1613 Arkitekt Aldo Dushi A. 1982/1 Ing. Gjeoinformatik Elfat Shehu T. 1577 Ing. Gjeodet Marsilda Ferko T. 1582 Ing. Gjeodet Dimitër Kono T. 1609	P1SH - 08-2023			

PLAN VENDOSJE MBI ORTOFOTO PRITA E PROJEKTUAR NR.7

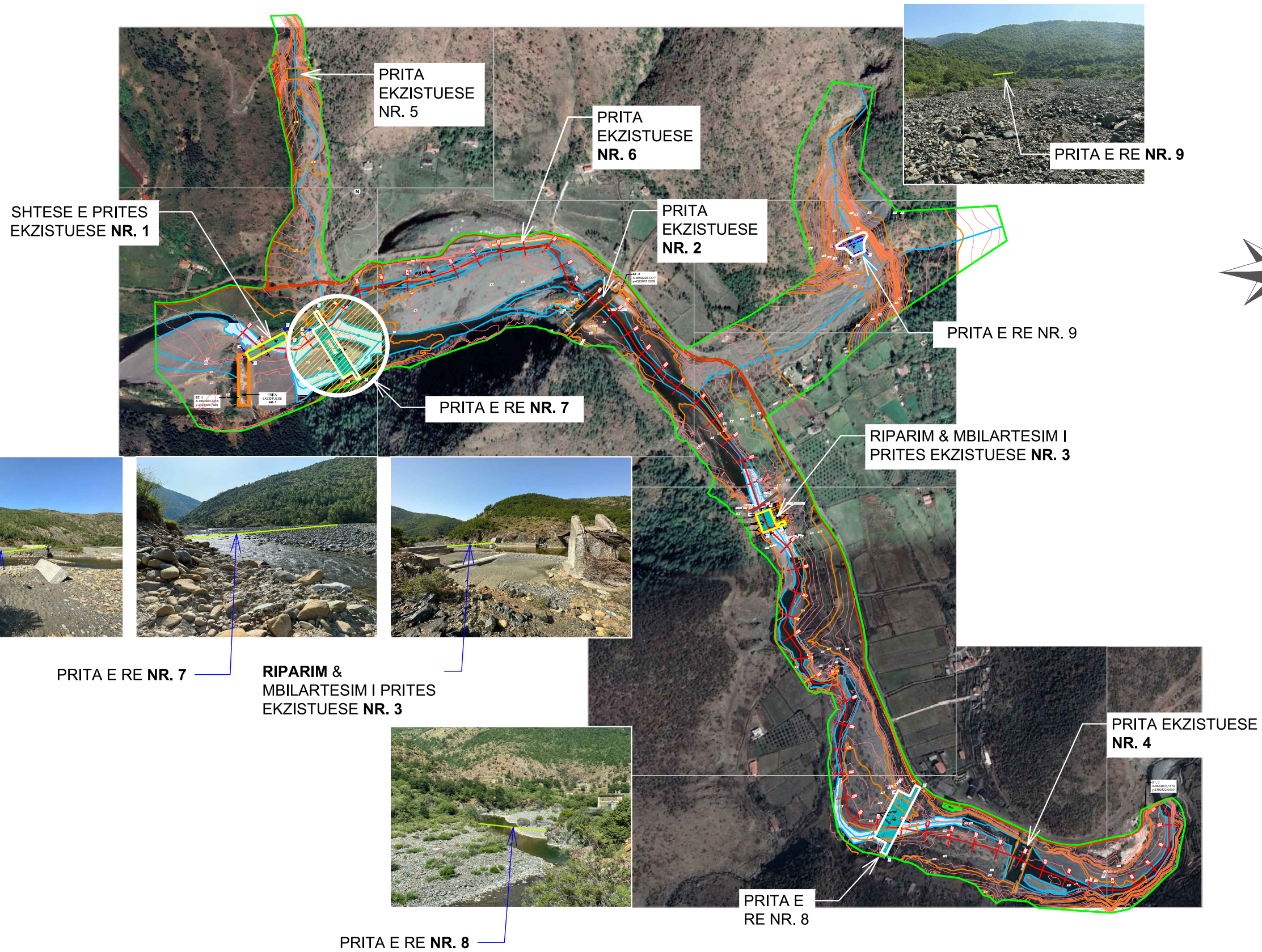

SHTESE E PRITES EKZISTUESE NR. 1

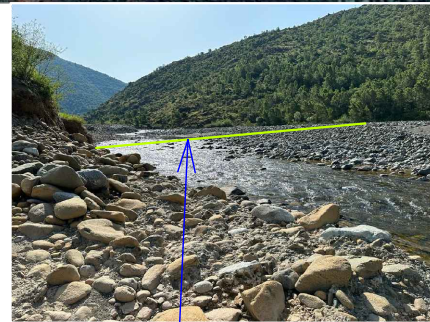

PRITA E RE NR. 7



RIPARIM & MBILARTESIM I PRITES EKZISTUESE NR. 3

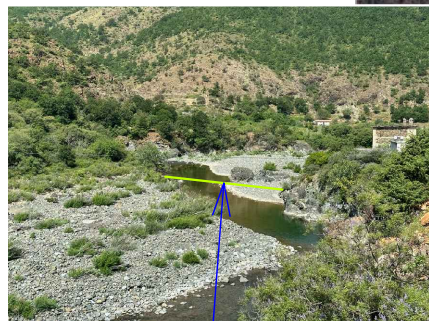

PRITA E RE NR. 8



PRITA E RE NR. 9

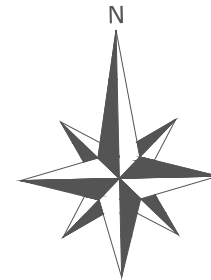

Emërtimi i Objektit PROJEKT-ZBATIM	Blerësi Korporata Elektroenergjitike Shqiptare Sh.a	Furnizuesi		GRUPI I PROJEKTIMIT				Emërtimi i Fletes Plan Vendosje mbi ortofoto, Prita e projektuar Nr.7	Shkalla 1 : 2000
	HARTIM PROJEKTI MBROJTJA DHE SISTEMIMI ME PRITA MALORE I PËRROIT TË GOMSIQES		"NET-GROUP" shpk 	"ARABEL STUDIO" shpk 	Ing. Gjeolog Valter Begaj GJ. 0324/2	Ing. Ndërtimi Ilirian Kokalari K. 1008/3	Ing. Ndërtimi Luca Falasca K. 2774		
	Adresa: Rruga "Viktor Eftimiu" Blloku "Vasil Shanto" Tiranë	L.72023002P Adresa: Rruga "Viktor Eftimiu" Blloku "Vasil Shanto" Tiranë	LS1812001S Adresa: Rruga "Viktor Eftimiu" Blloku "Vasil Shanto" Tiranë	Ing. Hidroteknik Luljeta Kuci K. 2022/1	Ing. Ndërtimi Gentjana Luka M. 1613	Ing. Ndërtimi Aldo Dushi A. 1982/1			
				Arkitekt Diana Mitrushi A. 0212/4	Ing. Mjedisi Elfat Shehu T. 1577	Arkitekt Marsilda Ferko T. 1582			
				Ing. Elektrik Burhan Demneri E. 1049/2	Ing. Gjeoinformatik Shqiponja Civici T. 1268	Ing. Gjeodet Ermal Spahiu K. 1084/1			
				Ing. Mekanik Gjeorgji Kotori M. 0579/1	Ing. Gjeodet Dimitër Kono T. 1609				

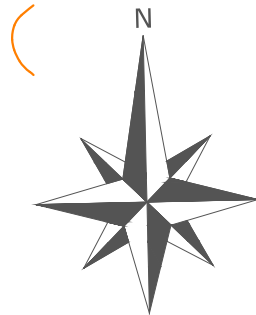

PRITA E RE NR. 7
Planimetria, Sh-1:500

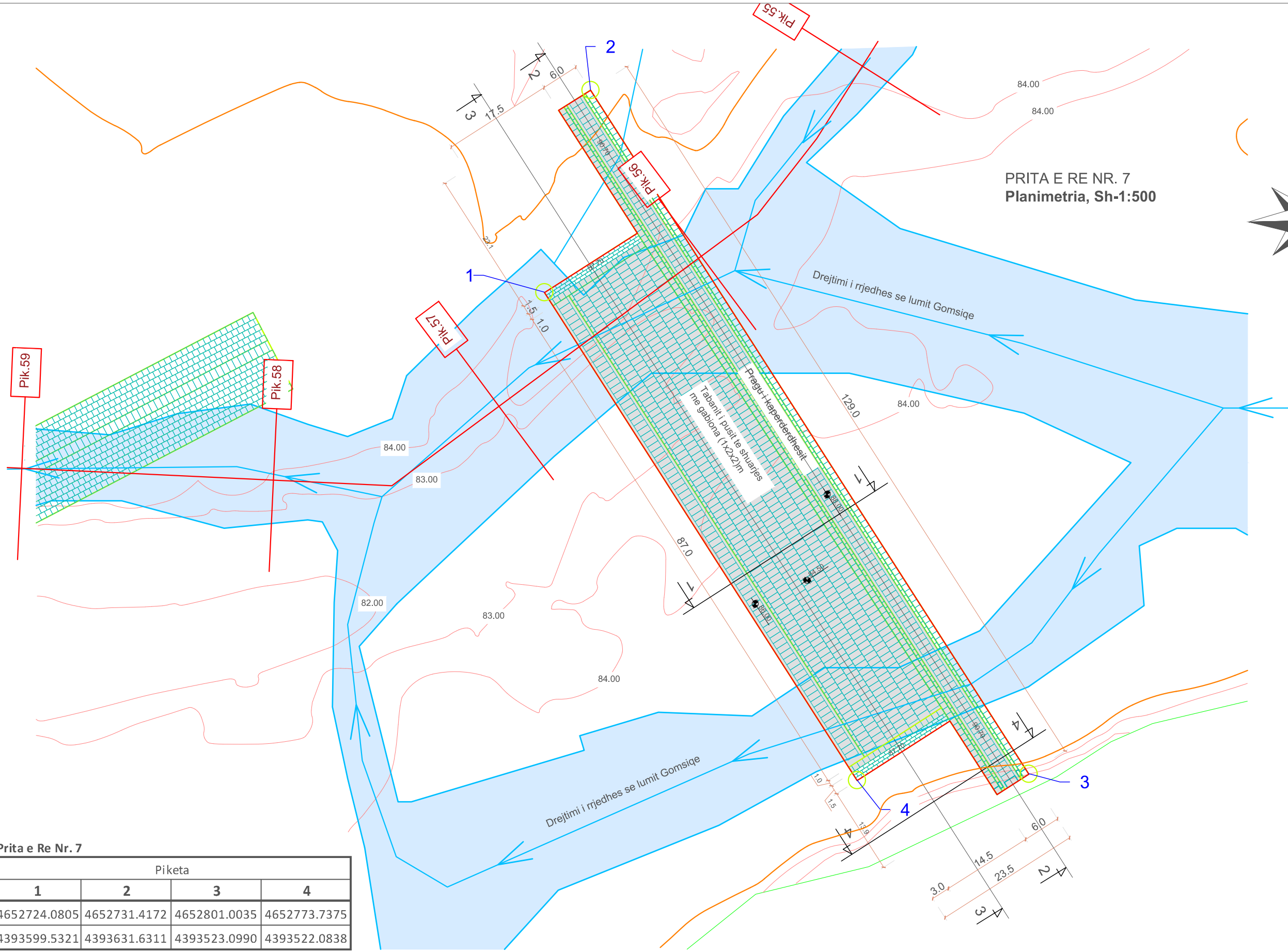

Prita e Re Nr. 7

Orientimi	Piketa			
	1	2	3	4
X	4652724.0805	4652731.4172	4652801.0035	4652773.7375
Y	4393599.5321	4393631.6311	4393523.0990	4393522.0838

Emërtimi i Objektit PROJEKT-ZBATIM HARTIM PROJEKTI MBROJTJA DHE SISTEMIMI ME PRITA MALORE I PËRROIT TË GOMSIQES	Blerësi Korporata Elektroenergjitike Shqiptare Sh.a  Adresa: Rruga "Viktor Eftimi" Blloku "Vasil Shanto" Tiranë	Furnizuesi "NET-GROUP" shpk  L72023002P Adresa: Rruga "Viktor Eftimi" Blloku "Vasil Shanto" Tiranë		"ARABEL STUDIO" shpk  LS1812001S Adresa: Rruga "Viktor Eftimi" Blloku "Vasil Shanto" Tiranë		GRUPI I PROJEKTIMIT <table border="0"> <tr> <td>Ing. Gjeolog Valter Begaj GJ. 0324/2</td> <td>Ing. Ndërtimi Ilirian Kokalari K. 1008/3</td> </tr> <tr> <td>Ing. Hidroteknik Luljeta Kuci K. 2022/1</td> <td>Ing. Ndërtimi Luca Falasca K. 2774</td> </tr> <tr> <td>Arkitekt Diana Mitrushi A. 0212/4</td> <td>Ing. Mjedisi Gentjana Luka M. 1613</td> </tr> <tr> <td>Ing. Elektrik Burhan Demneri E. 1049/2</td> <td>Arkitekt Aldo Dushi A. 1982/1</td> </tr> <tr> <td>Ing. Mekanik Gjegji Kotori M. 0579/1</td> <td>Ing. Gjeoinformatik Elfat Shehu T. 1577</td> </tr> <tr> <td>Ing. Gjeodet Shqiponja Civiçi T. 1268</td> <td>Ing. Gjeodet Marsilda Ferko T. 1582</td> </tr> <tr> <td>Ing. Ndërtimi Ermal Spahiu K. 1084/1</td> <td>Ing. Gjeodet Dimitër Kono T. 1609</td> </tr> </table>		Ing. Gjeolog Valter Begaj GJ. 0324/2	Ing. Ndërtimi Ilirian Kokalari K. 1008/3	Ing. Hidroteknik Luljeta Kuci K. 2022/1	Ing. Ndërtimi Luca Falasca K. 2774	Arkitekt Diana Mitrushi A. 0212/4	Ing. Mjedisi Gentjana Luka M. 1613	Ing. Elektrik Burhan Demneri E. 1049/2	Arkitekt Aldo Dushi A. 1982/1	Ing. Mekanik Gjegji Kotori M. 0579/1	Ing. Gjeoinformatik Elfat Shehu T. 1577	Ing. Gjeodet Shqiponja Civiçi T. 1268	Ing. Gjeodet Marsilda Ferko T. 1582	Ing. Ndërtimi Ermal Spahiu K. 1084/1	Ing. Gjeodet Dimitër Kono T. 1609	Emërtimi i Fletes PRITA NR.7 PLANIMETRIA	Shkalla 1 : 500 P7 - 02-2023
		Ing. Gjeolog Valter Begaj GJ. 0324/2	Ing. Ndërtimi Ilirian Kokalari K. 1008/3																				
Ing. Hidroteknik Luljeta Kuci K. 2022/1	Ing. Ndërtimi Luca Falasca K. 2774																						
Arkitekt Diana Mitrushi A. 0212/4	Ing. Mjedisi Gentjana Luka M. 1613																						
Ing. Elektrik Burhan Demneri E. 1049/2	Arkitekt Aldo Dushi A. 1982/1																						
Ing. Mekanik Gjegji Kotori M. 0579/1	Ing. Gjeoinformatik Elfat Shehu T. 1577																						
Ing. Gjeodet Shqiponja Civiçi T. 1268	Ing. Gjeodet Marsilda Ferko T. 1582																						
Ing. Ndërtimi Ermal Spahiu K. 1084/1	Ing. Gjeodet Dimitër Kono T. 1609																						

Shenime Teknike:

- Gabionat e parashikuar ne projekt me permasa (1x1x1)m, (1x1x1.5)m dhe (1x1x2)m te mbushen me gure te sistemuar, si mure guri i rregullt ne te thate, ku guret je jene te lidhura ne menyre te rregullt dhe te jene te permasave 12-40cm. Ne qoshet e gabionave te vendosen gure me dimension te madh, kurse guret me dimensione me te vogla te perdoren per te bere lidhjen dhe mbushjen e boshlleqeve.
- Kubiket e gabioneve te vendosen ne menyre te alternuar ne drejtimin terthor te prites, gabariti gjatesor i tyre te jete paralel sipas aksit terthor te pritave.
- Masa vellimore e murit te perfunduar ne gabiona te jete 1.7 ton/m3.
- Betoni qe do te perdoret per veshjen e pragut te kaperderdhesit dhe pergjate renjes se pragut, si dhe pragu i portalit te pusit te shuarjes se energjise te jete i klases C25/30, kurse hekuri S500.

Legjenda:

-  Prita me gabiona (1x1x1)m
-  Prita me gabiona (1x1x1.5)m
-  Prita me gabiona (1x1x2)m
-  Shkemb rrenjesor
-  Zhavorre te depozituara
-  Mbushje me shkemb te germuar me pare

Prita Nr.7

OBJEKTI:

HARTIM PROJEKTI MBROJTJA DHE SISTEMIMI
ME PRITA MALORE I PËRROIT TË GOMSIQES



2023

Emërtimi i Objektit	Blerësi	Furnizuesi		GRUPI I PROJEKTIMIT				Emërtimi i Fletes	Shkalla
PROJEKT-ZBATIM	Korporata Elektroenergjitike Shqiptare Sh.a	"NET-GROUP" shpk	"ARABEL STUDIO" shpk	Ing. Gjeolog Valter Begaj GJ. 0324/2	Ing. Ndërtimi Ilirian Kokalari K. 1008/3				
				Ing. Hidroteknik Luljeta Kuci K. 2022/1	Ing. Ndërtimi Luca Falasca K. 2774				
				Arkitekt Diana Mitrushi A. 0212/4	Ing. Mjedis Gentjana Luka M. 1613				
				Ing. Elektrik Burhan Demneri E. 1049/2	Arkitekt Aldo Dushi A. 1982/1				
				Ing. Mekanik Gjergji Kotori M. 0579/1	Ing. Gjeoinformatik Elfat Shehu T. 1577				
				Ing. Gjeodet Shqiponja Civici T. 1268	Ing. Gjeodet Marsilda Ferko T. 1582				
				Ing. Ndërtimi Ermal Spahiu K. 1084/1	Ing. Gjeodet Dimitër Kono T. 1609				
HARTIM PROJEKTI MBROJTJA DHE SISTEMIMI ME PRITA MALORE I PËRROIT TË GOMSIQES	 Adresa: Rruga "Viktor Eftimi" Blloku "Vasil Shanto" Tiranë	 L.72023002P Adresa: Rruga "Viktor Eftimi" Blloku "Vasil Shanto" Tiranë	 L.51812001S Adresa: Rruga "Viktor Eftimi" Blloku "Vasil Shanto" Tiranë					KAPAK - Prita Nr.7	P7 - 00-2023

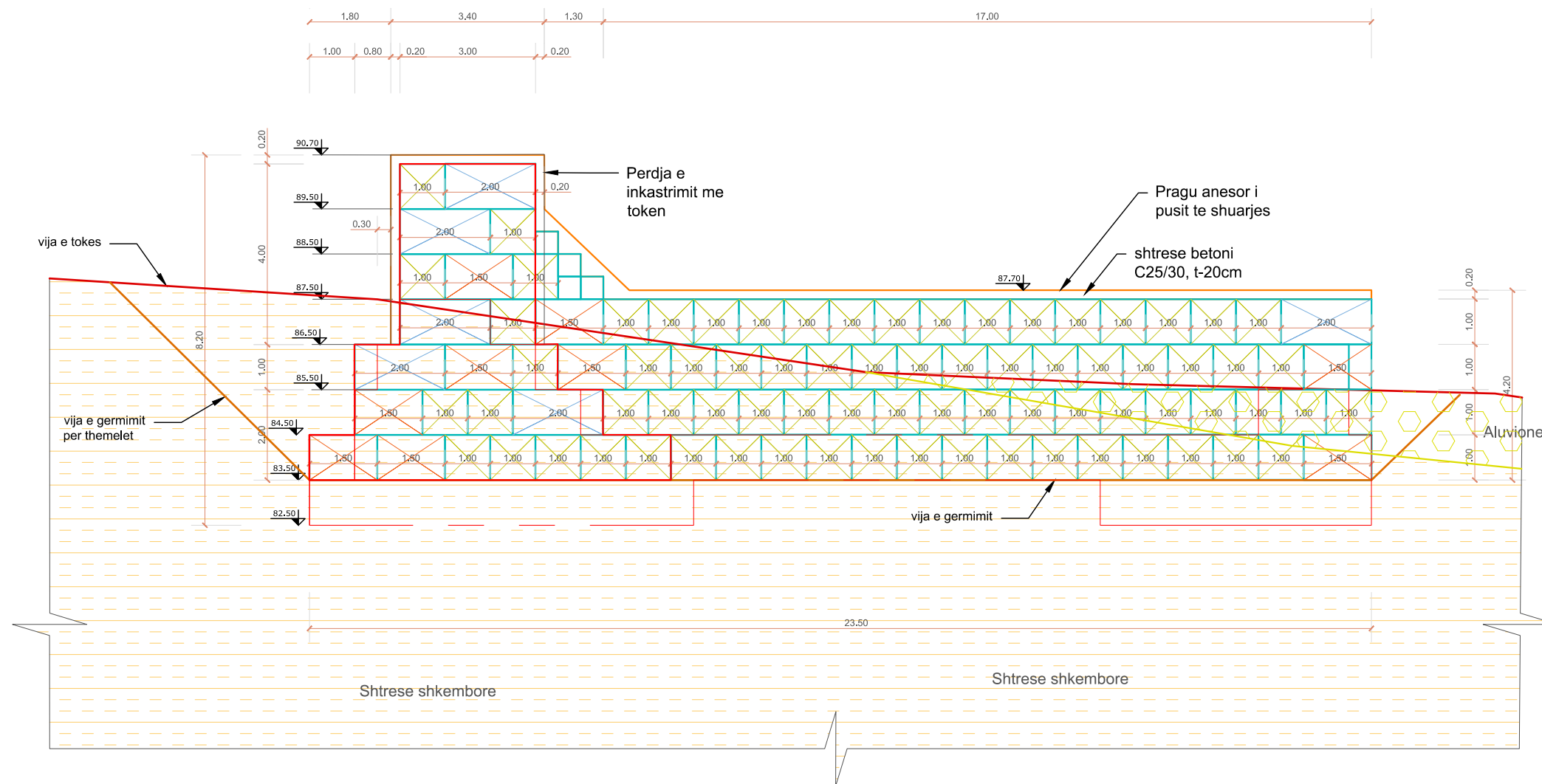
PRITA NR. 7
Prerje terthore "4-4", Sh. 1:100



Nr. Piketes	s-1	s-2	s-3	s-4	s-5	s-6	s-7	s-8	s-9	s-10	s-11	s-12	s-13	s-14	
Distanca Progressive		2.00	4.00	6.00	8.00	10.00	12.00	14.00	16.00	18.00	20.00	22.00	24.00	26.00	28.00
Distanca Pjesore	2.00	2.00	2.00	2.00	2.00	2.00	2.00	2.00	2.00	2.00	2.00	2.00	2.00	2.00	
Kuota e Tokes	97.74					86.57					85.64			84.93	

Emërtimi i Objektit PROJEKT-ZBATIM HARTIM PROJEKTI MBROJTJA DHE SISTEMIMI ME PRITA MALORE I PËRROIT TË GOMSIQES	Blerësi Korporata Elektroenergjitike Shqiptare Sh.a  Adresa: Rruga "Viktor Eftimi" Blloku "Vasil Shanto" Tiranë	Furnizuesi "NET-GROUP" shpk  L72023002P Adresa: Rruga "Viktor Eftimi" Blloku "Vasil Shanto" Tiranë		"ARABEL STUDIO" shpk  L51812001S Adresa: Rruga "Viktor Eftimi" Blloku "Vasil Shanto" Tiranë		GRUPI I PROJEKTIMIT <table border="0"> <tr> <td>Ing. Gjeolog Valter Begaj GJ. 0324/2</td> <td>Ing. Ndërtimi Ilirian Kokalari K. 1008/3</td> </tr> <tr> <td>Ing. Hidroteknik Luljeta Kuci K. 2022/1</td> <td>Ing. Ndërtimi Luca Falasca K. 2774</td> </tr> <tr> <td>Arkitekt Diana Mitrushaj A. 0212/4</td> <td>Ing. Mjedisi Gentjana Luka M. 1613</td> </tr> <tr> <td>Ing. Elektrik Burhan Demneri E. 1049/2</td> <td>Arkitekt Aldo Dushi A. 1982/1</td> </tr> <tr> <td>Ing. Mekanik Gjerqji Kotori M. 0579/1</td> <td>Ing. Gjeoinformatik Elfat Shehu T. 1577</td> </tr> <tr> <td>Ing. Gjeodet Shqiponja Civici T. 1268</td> <td>Ing. Gjeodet Marsilda Ferko T. 1582</td> </tr> <tr> <td>Ing. Ndërtimi Ermal Spahiu K. 1084/1</td> <td>Ing. Gjeodet Dimitër Kono T. 1609</td> </tr> </table>				Ing. Gjeolog Valter Begaj GJ. 0324/2	Ing. Ndërtimi Ilirian Kokalari K. 1008/3	Ing. Hidroteknik Luljeta Kuci K. 2022/1	Ing. Ndërtimi Luca Falasca K. 2774	Arkitekt Diana Mitrushaj A. 0212/4	Ing. Mjedisi Gentjana Luka M. 1613	Ing. Elektrik Burhan Demneri E. 1049/2	Arkitekt Aldo Dushi A. 1982/1	Ing. Mekanik Gjerqji Kotori M. 0579/1	Ing. Gjeoinformatik Elfat Shehu T. 1577	Ing. Gjeodet Shqiponja Civici T. 1268	Ing. Gjeodet Marsilda Ferko T. 1582	Ing. Ndërtimi Ermal Spahiu K. 1084/1	Ing. Gjeodet Dimitër Kono T. 1609	Emërtimi i Fletes PRITA NR.7 PRERJA "4-4"	Shkalla 1 : 100 P7 - 04-2023
		Ing. Gjeolog Valter Begaj GJ. 0324/2	Ing. Ndërtimi Ilirian Kokalari K. 1008/3																						
Ing. Hidroteknik Luljeta Kuci K. 2022/1	Ing. Ndërtimi Luca Falasca K. 2774																								
Arkitekt Diana Mitrushaj A. 0212/4	Ing. Mjedisi Gentjana Luka M. 1613																								
Ing. Elektrik Burhan Demneri E. 1049/2	Arkitekt Aldo Dushi A. 1982/1																								
Ing. Mekanik Gjerqji Kotori M. 0579/1	Ing. Gjeoinformatik Elfat Shehu T. 1577																								
Ing. Gjeodet Shqiponja Civici T. 1268	Ing. Gjeodet Marsilda Ferko T. 1582																								
Ing. Ndërtimi Ermal Spahiu K. 1084/1	Ing. Gjeodet Dimitër Kono T. 1609																								

Prita me gabiona Nr.7
Prerje "2-2", Sh. 1:300

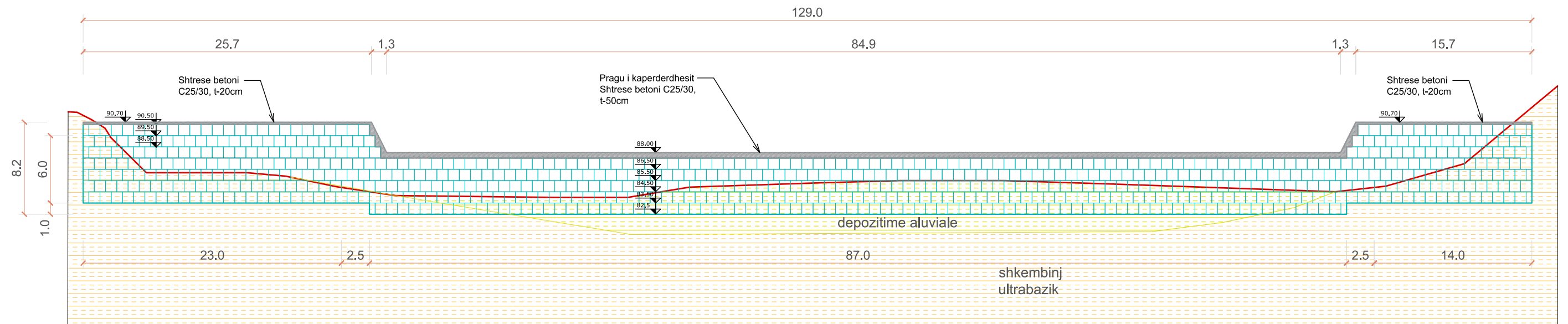

Nr. Piketes	s-1	s-2	s-3	s-4	s-5	s-6	s-7	s-8	s-9	s-10	s-11	s-12	s-13	s-14	s-15	s-16	s-17	s-18	s-19	s-20	s-21	s-22	s-23	s-24	s-25	s-26
Distanca Progressive		5.00	10.00	15.00	20.00	25.00	30.00	35.00	40.00	45.00	50.00	55.00	60.00	65.00	70.00	75.00	80.00	85.00	90.00	95.00	100.00	105.00	110.00	115.00	120.00	125.00
Distanca Pjesore		10.00		10.00		10.00		10.00		10.00		10.00		10.00		10.00		10.00		10.00		10.00		10.00		10.00
Kuota e Tokes	91.30		86.20		85.40		87.54		87.54		87.54		87.54		87.54		87.54		87.54		87.54		87.54		87.54	

Treguesit fiziko-mekanik te aluvioneve	
Pesha vellimore ne gjendje natyrale	2,1 t/m ³
Kendi i ferkimit te brendshem	38°
Moduli i deformacionit	E=(200-250) kg/cm ²
Kohezioni	0,0 kg/cm ²
Koeficienti i ferkimit ndermjet gureve	f=0,5
Ngarkesa e lejuar ne shtypje	σ=(200-250) kg/cm ²

Treguesit fiziko-mekanik te shkembinjve ultrabazik	
Pesha vellimore ne gjendje natyrale	2,58 t/m ³
Pesha specifike	2,85 gr/cm ³
Poroziteti	2%
Moduli i deformimit	500 kg/cm ²
Koeficienti i Puasonit	0,2
Koeficienti i Protodiakonovit	6-7
Rezistenca ne shtypje njeaksiale	800 kg/cm ²
Ngarkesa e lejuar	300-400 kg/cm ²
Koeficienti i filtrimit	1°10-3 cm/sek
Grupimi gjeoteknik	Te forte

Shenime Teknike:

- Gabionat e parashikuar ne projekt me permasa (1x1x1)m, (1x1x1.5)m dhe (1x1x2)m te mbushen me gure te sistemuar, si mure guri i rregullt ne te thate, ku guret je jene te lidhura ne menyre te rregullt dhe te jene te permasave 12-40cm. Ne qoshet e gabionave te vendosen gure me dimension te madh, kurse guret me dimensione me te vogla te perdoren per te bere lidhjen dhe mbushjen e boshlleqeve.
- Kubiket e gabioneve te vendosen ne menyre te alternuar ne drejtimin terthor te prites, gabariti gjatesor i tyre te jete paralel sipas aksit terthor te pritave.
- Masa vellimore e murit te perfunduar ne gabiona te jete 1.7 ton/m3.
- Betoni qe do te perdoret per veshjen e pragut te kaperderdhesit dhe pergjate renjes se pragut, si dhe pragu i portalit te pusit te shuarjes se energjise te jete i klases C25/30, kurse hekurit S500.

Nr	Pershkrimi i Punimeve	Njesia	Sasia					Shuma
			Pragu i kaperderdh.	Pusi i Shuarjes	Portali i Pusit te Shuarjes	Pragu anesor i Pusi te Shuarjes	Perdja e Inkastrimit	
1	Gabiona me rrjete teli te zinkuar gure kave 1x1x1 m	m ³	783	0	0	58	555	1396
2	Gabiona me rrjete teli te zinguar gure kave 1x1x1.5 m	m ³	522	130,5	261	87	388,5	1389
3	Gabiona me rrjete teli te zinguar gure kave 1x1x2 m	m ³	696	1218	348	58	518	2838
4	Struktura te holla monolite betoni C25/30	m ³	242,73	0,00	207,93	32,35	83,99	567,00
5	F V hekur betoni i zakonshem Ø > 12mm (per betoni min e pllakave te portalit kaperderdhes dhe pusit te shuarjes se energjise dhe bordurat e Gabioneve)	Ton	18,053	7,473	12,459	0	11,454	49,439
6	Konstruksione metalike te thjeshta	Ton	0,000	0,000	0,000	0		0,000

Emërtimi i Objektivit PROJEKT-ZBATIM	Blerësi Korporata Elektroenergjitike Shqiptare Sh.a Adresa: Rruga "Viktor Eftimi" Blloku "Vasil Shanto" Tiranë	Furnizuesi		GRUPI I PROJEKTIMIT				Emërtimi i Fletes PRITA NR.7 PRERJA "2-2"	Shkalla 1 : 200
		"NET-GROUP" shpk L.72023002P Adresa:Rruga "Viktor Eftimi"Blloku "Vasil Shanto" Tiranë	"ARABEL STUDIO" shpk LS1812001S Adresa:Rruga "Viktor Eftimi"Blloku "Vasil Shanto" Tiranë	Ing. Gjeolog Valter Begaj GJ. 0324/2 Ing. Hidroteknik Luljeta Kuci K. 2022/1 Arkitekt Diana Mitrushi A. 0212/4 Ing. Elektrik Burhan Demneri E. 1049/2 Ing. Mekanik Gjergji Kotori M. 0579/1 Ing. Gjeodet Shqiponja Civiçi T. 1268 Ing. Ndërtimi Ermal Spahiu K. 1084/1	Ing. Ndërtimi Ilirian Kokalari K. 1008/3 Ing. Ndërtimi Luca Falasca K. 2774 Ing. Mjedis Gentjana Luka M. 1613 Arkitekt Aldo Dushi A. 1982/1 Ing. Gjeoinformatik Elfat Shehu T. 1577 Ing. Gjeodet Marsilda Ferko T. 1582 Ing. Gjeodet Dimitër Kono T. 1609	P7 - 05-2023			

Prita me gabiona Nr.7
Prerje "3-3", Sh. 1:300

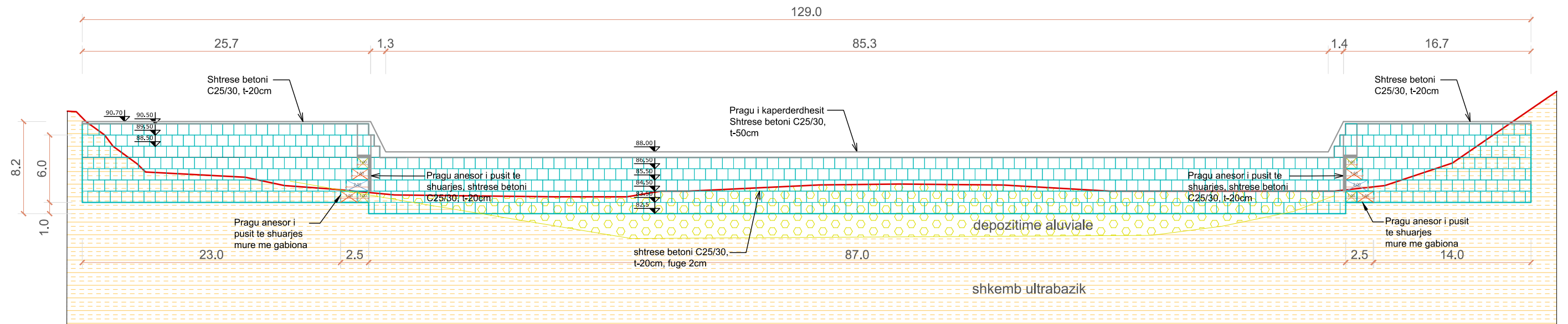

Nr. Piketes	s-1	s-2	s-3	s-4	s-5	s-6	s-7	s-8	s-9	s-10	s-11	s-12	s-13	s-14	s-15	s-16	s-17	s-18	s-19	s-20	s-21	s-22	s-23	s-24	s-25	s-26	
Distanca Progressive		5.00	10.00	15.00	20.00	25.00	30.00	35.00	40.00	45.00	50.00	55.00	60.00	65.00	70.00	75.00	80.00	85.00	90.00	95.00	100.00	105.00	110.00	115.00	120.00	125.00	
Distanca Pjesore		10.00		10.00		10.00		10.00		10.00		10.00		10.00		10.00		10.00		10.00		10.00		10.00		10.00	
Kuota e Tokes	91.30		86.20		85.40		87.54		87.54		87.54		87.54		87.54		87.54		87.54		87.54		87.54		87.54		87.54

Emërtimi i Objektit PROJEKT-ZBATIM	Blerësi Korporata Elektroenergjitike Shqiptare Sh.a KESH Adresa: Rruga "Viktor Eftimi" Blloku "Vasil Shanto" Tiranë	Furnizuesi		GRUPI I PROJEKTIMIT								Emërtimi i Fletes PRITA NR.7 PRERJA "3-3"	Shkalla 1 : 200
		"NET-GROUP" shpk  L.72023002P Adresa: Rruga "Viktor Eftimi" Blloku "Vasil Shanto" Tiranë	"ARABEL STUDIO" shpk  L.51812001S Adresa: Rruga "Viktor Eftimi" Blloku "Vasil Shanto" Tiranë	Ing. Gjeolog Valter Begaj GJ. 0324/2 Ing. Hidroteknik Luljeta Kuci K. 2022/1 Arkitekt Diana Mitrushi A. 0212/4 Ing. Elektrik Burhan Demneri E. 1049/2 Ing. Mekanik Gjergji Kotori M. 0579/1 Ing. Gjeodet Shqiponja Civici T. 1268 Ing. Ndërtimi Ermal Spahiu K. 1084/1	Ing. Ndërtimi Ilirian Kokalari K. 1008/3 Ing. Ndërtimi Luca Falasca K. 2774 Ing. Mjedis Gentjana Luka M. 1613 Arkitekt Aldo Dushi A. 1982/1 Ing. Gjeoinformatik Elfat Shehu T. 1577 Ing. Gjeodet Marsilda Ferko T. 1582 Ing. Gjeodet Dimitër Kono T. 1609	P7 - 06-2023							

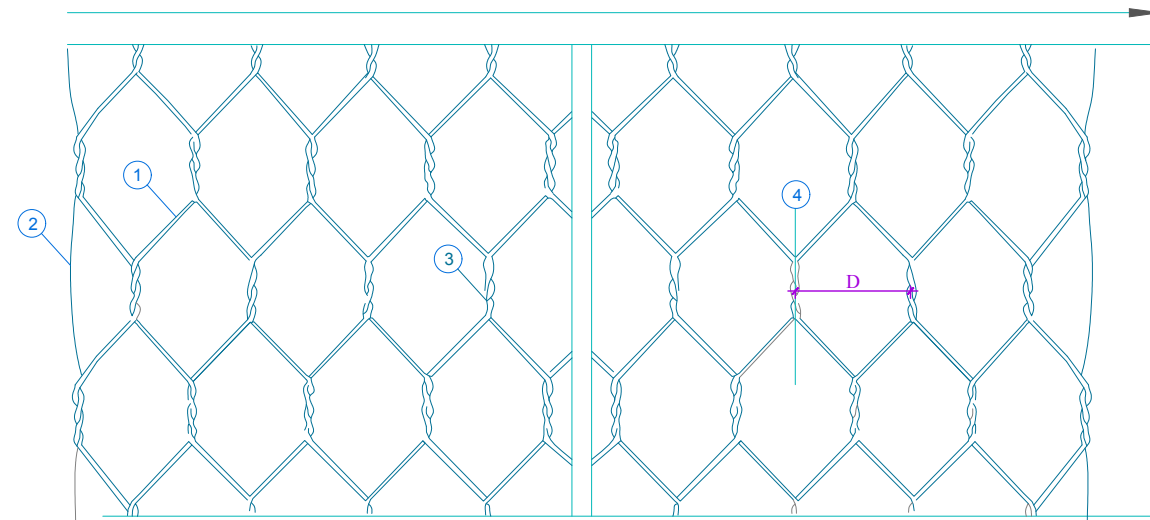

- ① TELI I RRJETES $d \geq 3\text{mm}$
 - ② SIDE WIRE (CURB)
 - ③ PERDREDHJA DYFISHE
 - ④ AKSI PERDREDHJES DYFISHE
- D - DIAMETRI I HOJES D = 6 cm

DETAJ I HOJEVE

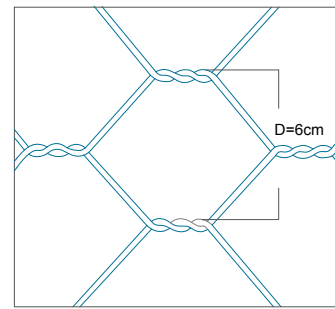

LIDHJA E RRJETAVE ME TEL XINGATO

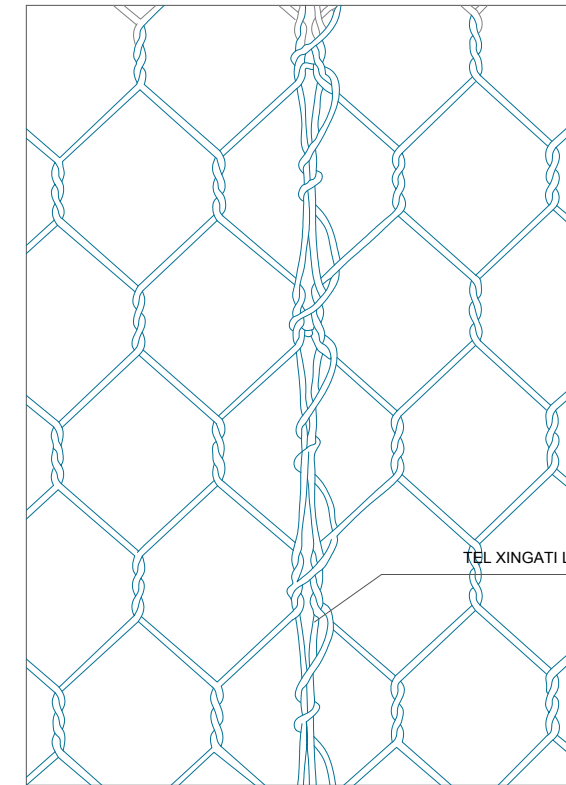

PAMJE E RULONIT TE RRJETES SE GABIONIT

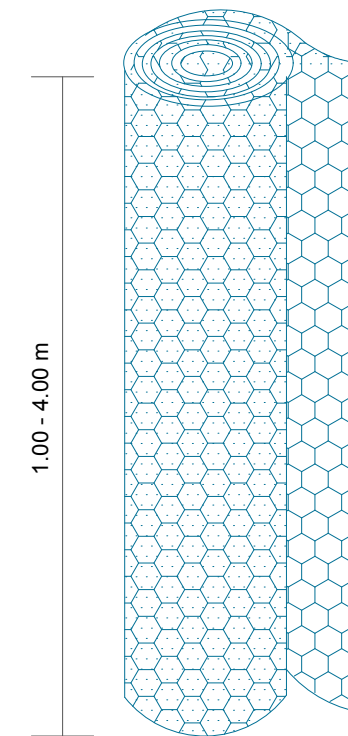

<p>Emërtimi i Objektit PROJEKT-ZBATIM</p>	<p>Blerësi Korporata Elektroenergjitike Shqiptare Sh.a</p>	<p>Furnizuesi</p> <p>"NET-GROUP" shpk "ARABEL STUDIO" shpk</p>		<p>GRUPI I PROJEKTIMIT</p>				<p>Emërtimi i Fletes</p>	<p>Shkalla 1 :</p>
<p>HARTIM PROJEKTI MBROJTJA DHE SISTEMIMI ME PRITA MALORE I PËRROIT TË GOMSIQES</p>	<p>Adresa: Rruga "Viktor Eftimi" Blloku "Vasil Shanto" Tiranë</p>	<p>L72023002P Adresa: Rruga "Viktor Eftimi" Blloku "Vasil Shanto" Tiranë</p>	<p>L51812001S Adresa: Rruga "Viktor Eftimi" Blloku "Vasil Shanto" Tiranë</p>	<p>Ing. Gjeolog Valter Begaj GJ. 0324/2 Ing. Hidroteknik Luljeta Kuci K. 2022/1 Arkitekt Diana Mitrusi A. 0212/4 Ing. Elektrik Burhan Demneri E. 1049/2 Ing. Mekanik Gjergji Kotori M. 0579/1 Ing. Gjeodet Shqiponja Civici T. 1268 Ing. Ndërtimi Ermal Spahiu K. 1084/1</p>	<p>Ing. Ndërtimi Ilirian Kokalari K. 1008/3 Ing. Ndërtimi Luca Falasca K. 2774 Ing. Mjedis Gentjana Luka M. 1613 Arkitekt Aldo Dushi A. 1982/1 Ing. Gjeoinformatik Elfat Shehu T. 1577 Ing. Gjeodet Marsilda Ferko T. 1582 Ing. Gjeodet Dimitër Kono T. 1609</p>	<p>Lidhja e rrjetave me tel xingato</p>	<p>P7-08-2023</p>		

TIPE MURESH PREJ GABIONI

PAMJE GJATESORE E MURIT ME GABIONA

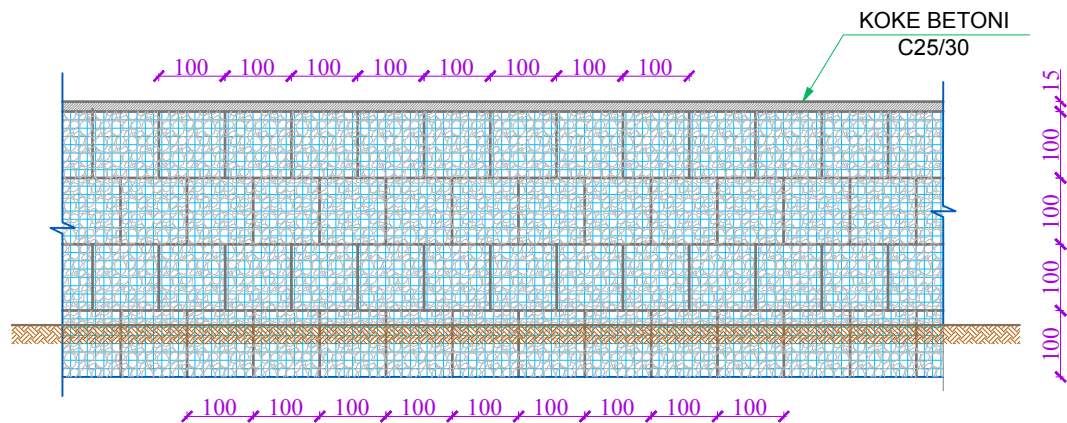

"DETAJ A"

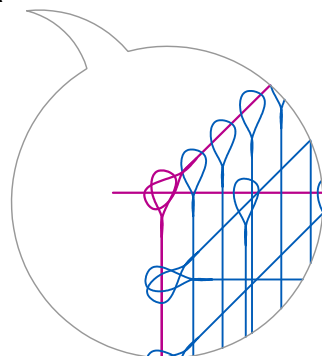

Shenim:

- Mbushja e koshave te gabionit behet me gure te permasave 120-400 mm.
- Gabionet do te vendosen te alternuara, ne menyre qe xhuntoja e bashkimit te mos bjere ne te njejtin drejtim si ne drejtim gjatesor edhe ne ate terthor.
- Per seksionet terthore duhet ti referoheni profilave tip.

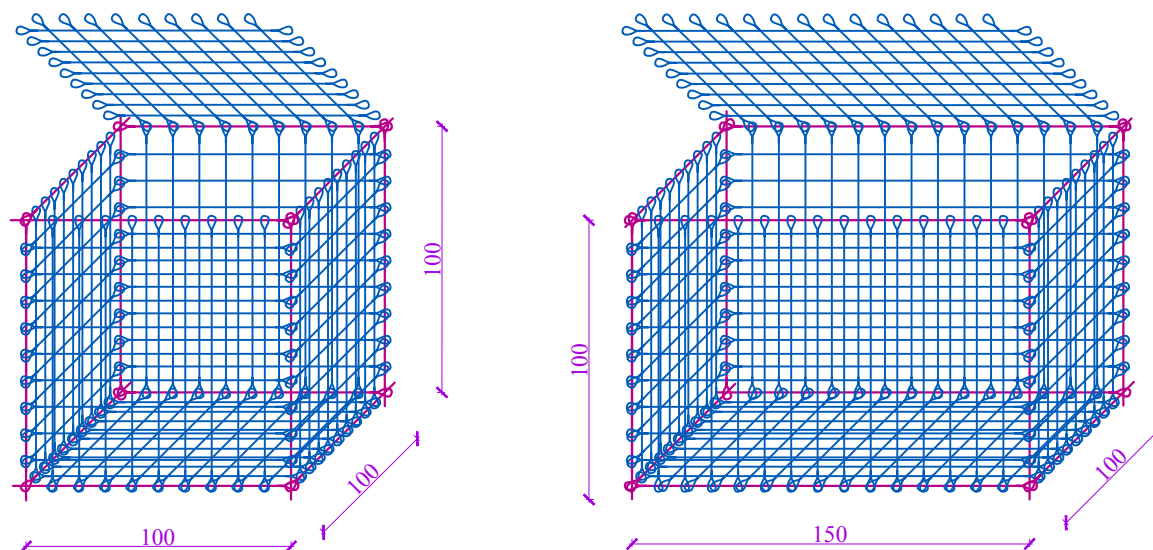

DETAJE MONTIMI TE KOSHAVE TE GABIONIT

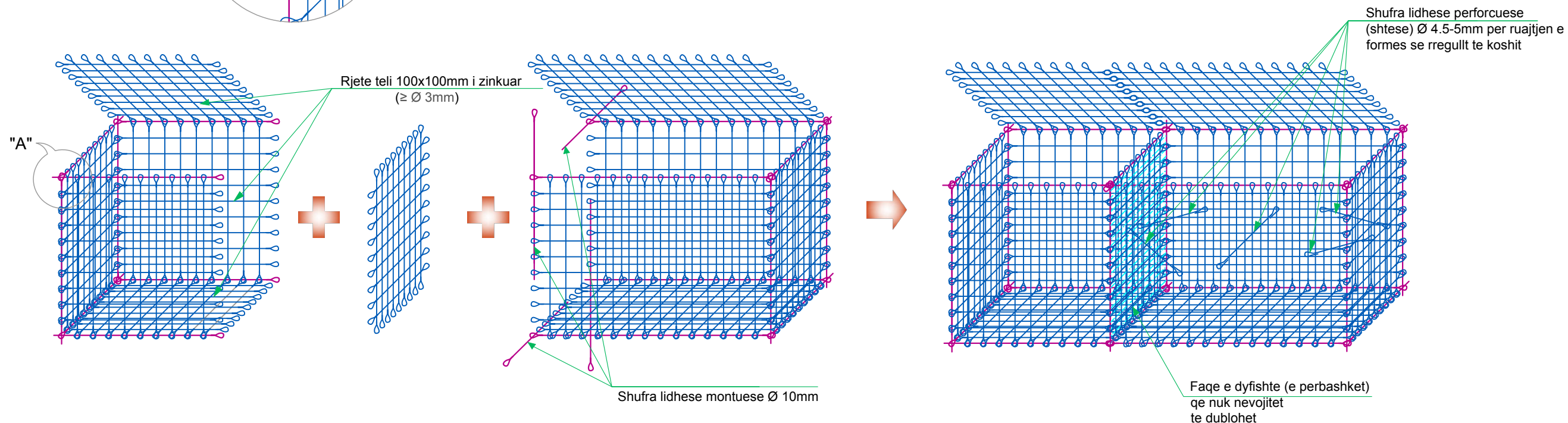

Emërtimi i Objektivit PROJEKT-ZBATIM HARTIM PROJEKTI MBROJTJA DHE SISTEMIMI ME PRITA MALORE I PËRROIT TË GOMSIQES	Blerësi Korporata Elektroenergjitike Shqiptare Sh.a 	Furnizuesi "NET-GROUP" shpk "ARABEL STUDIO" shpk 		GRUPI I PROJEKTIMIT <table border="0"> <tr> <td>Ing. Gjeolog</td> <td>Valter Begaj</td> <td>GJ. 0324/2</td> <td>Ing. Ndërtimi</td> <td>Ilirian Kokalari</td> <td>K. 1008/3</td> </tr> <tr> <td>Ing. Hidroteknik</td> <td>Luljeta Kuci</td> <td>K. 2022/1</td> <td>Ing. Ndërtimi</td> <td>Luca Falasca</td> <td>K. 2774</td> </tr> <tr> <td>Arkitekt</td> <td>Diana Mitrushi</td> <td>A. 0212/4</td> <td>Ing. Mjedisi</td> <td>Gentjana Luka</td> <td>M. 1613</td> </tr> <tr> <td>Ing. Elektrik</td> <td>Burhan Demneri</td> <td>E. 1049/2</td> <td>Arkitekt</td> <td>Aldo Dushi</td> <td>A. 1982/1</td> </tr> <tr> <td>Ing. Mekanik</td> <td>Gjergji Kotori</td> <td>M. 0579/1</td> <td>Ing. Gjeoinformatik</td> <td>Elfat Shehu</td> <td>T. 1577</td> </tr> <tr> <td>Ing. Gjeodet</td> <td>Shqiponja Civici</td> <td>T. 1268</td> <td>Ing. Gjeodet</td> <td>Marsilda Ferko</td> <td>T. 1582</td> </tr> <tr> <td>Ing. Ndërtimi</td> <td>Ermal Spahiu</td> <td>K. 1084/1</td> <td>Ing. Gjeodet</td> <td>Dimitër Kono</td> <td>T. 1609</td> </tr> </table>				Ing. Gjeolog	Valter Begaj	GJ. 0324/2	Ing. Ndërtimi	Ilirian Kokalari	K. 1008/3	Ing. Hidroteknik	Luljeta Kuci	K. 2022/1	Ing. Ndërtimi	Luca Falasca	K. 2774	Arkitekt	Diana Mitrushi	A. 0212/4	Ing. Mjedisi	Gentjana Luka	M. 1613	Ing. Elektrik	Burhan Demneri	E. 1049/2	Arkitekt	Aldo Dushi	A. 1982/1	Ing. Mekanik	Gjergji Kotori	M. 0579/1	Ing. Gjeoinformatik	Elfat Shehu	T. 1577	Ing. Gjeodet	Shqiponja Civici	T. 1268	Ing. Gjeodet	Marsilda Ferko	T. 1582	Ing. Ndërtimi	Ermal Spahiu	K. 1084/1	Ing. Gjeodet	Dimitër Kono	T. 1609	Emërtimi i Fletes Tipë muresh prej gabioni	Shkalla 1 : P7 - 07-2023
	Ing. Gjeolog	Valter Begaj	GJ. 0324/2	Ing. Ndërtimi	Ilirian Kokalari	K. 1008/3																																													
Ing. Hidroteknik	Luljeta Kuci	K. 2022/1	Ing. Ndërtimi	Luca Falasca	K. 2774																																														
Arkitekt	Diana Mitrushi	A. 0212/4	Ing. Mjedisi	Gentjana Luka	M. 1613																																														
Ing. Elektrik	Burhan Demneri	E. 1049/2	Arkitekt	Aldo Dushi	A. 1982/1																																														
Ing. Mekanik	Gjergji Kotori	M. 0579/1	Ing. Gjeoinformatik	Elfat Shehu	T. 1577																																														
Ing. Gjeodet	Shqiponja Civici	T. 1268	Ing. Gjeodet	Marsilda Ferko	T. 1582																																														
Ing. Ndërtimi	Ermal Spahiu	K. 1084/1	Ing. Gjeodet	Dimitër Kono	T. 1609																																														
Adresa: Rruga "Viktor Eftimi" Blloku "Vasil Shanto" Tiranë		Adresa: Rruga "Viktor Eftimi" Blloku "Vasil Shanto" Tiranë																																																	

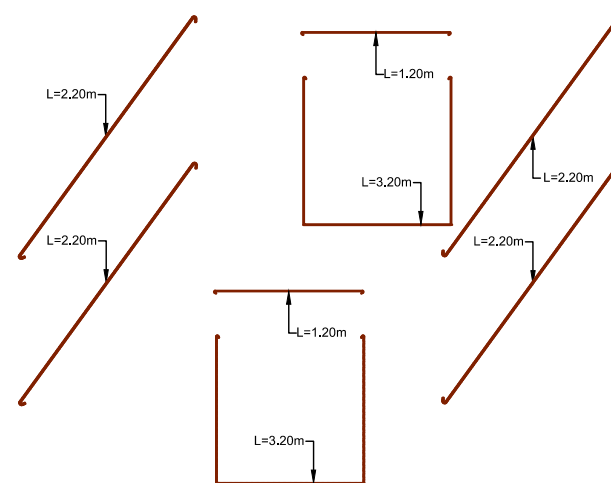
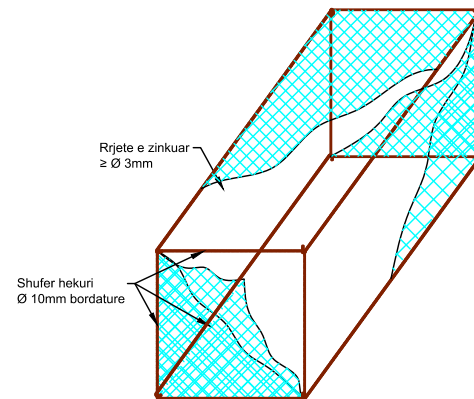
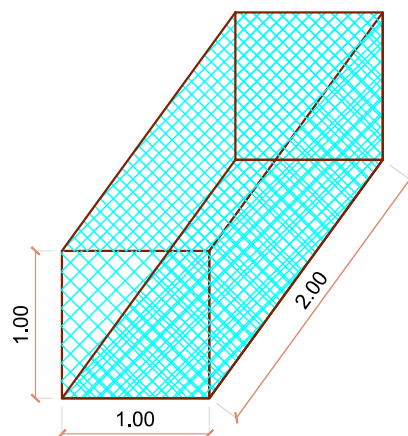
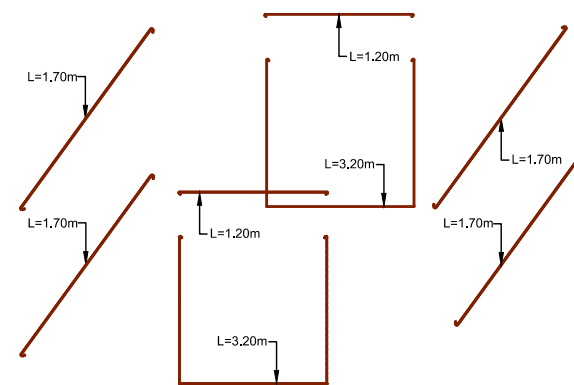
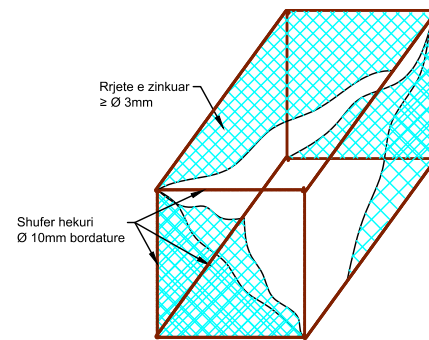
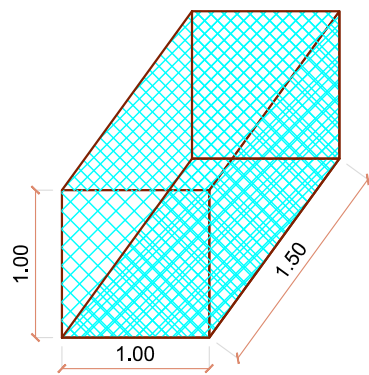
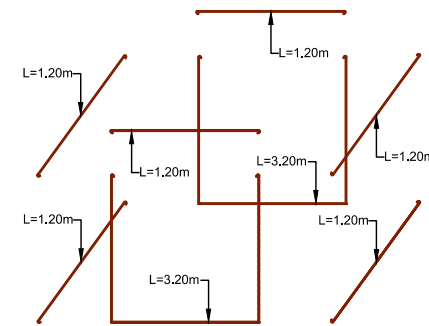
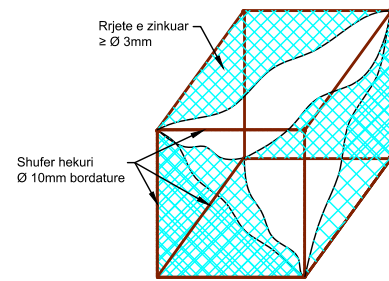
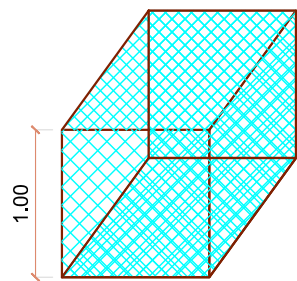

Emërtimi i Objektit
PROJEKT-ZBATIM

Blerësi
Korporata Elektroenergjitike Shqiptare Sh.a

Furnizuesi

"NET-GROUP" shpk

"ARABEL STUDIO" shpk

GRUPI I PROJEKTIMIT

Emërtimi i Fletes

Shkalla
1 :

HARTIM PROJEKTI MBROJTJA DHE SISTEMIMI ME PRITA MALORE I PËRROIT TË GOMSIQES



Adresa: Rruga "Viktor Eftimi" Blloku "Vasil Shanto" Tiranë



L.72023002P

Adresa: Rruga "Viktor Eftimi" Blloku "Vasil Shanto" Tiranë



L.51812001S

Adresa: Rruga "Viktor Eftimi" Blloku "Vasil Shanto" Tiranë

Ing. Gjeolog Valter Begaj GJ. 0324/2
Ing. Hidroteknik Luljeta Kuci K. 2022/1
Arkitekt Diana Mitrushi A. 0212/4
Ing. Elektrik Burhan Demneri E. 1049/2
Ing. Mekanik Gergji Kotori M. 0579/1
Ing. Gjeodet Shqiponja Civici T. 1268
Ing. Ndërtimi Ermal Spahiu K. 1084/1

Ing. Ndërtimi Ilirian Kokalari K. 1008/3
Ing. Ndërtimi Luca Falasca K. 2774
Ing. Mjedis Gentjana Luka M. 1613
Arkitekt Aldo Dushi A. 1982/1
Ing. Gjeoinformatik Elfat Shehu T. 1577
Ing. Gjeodet Marsilda Ferko T. 1582
Ing. Gjeodet Dimitër Kono T. 1609

Elementet e karkases se gabionave

P7 - 09-2023

PUSI I SHUARJES SE ENERGJISE

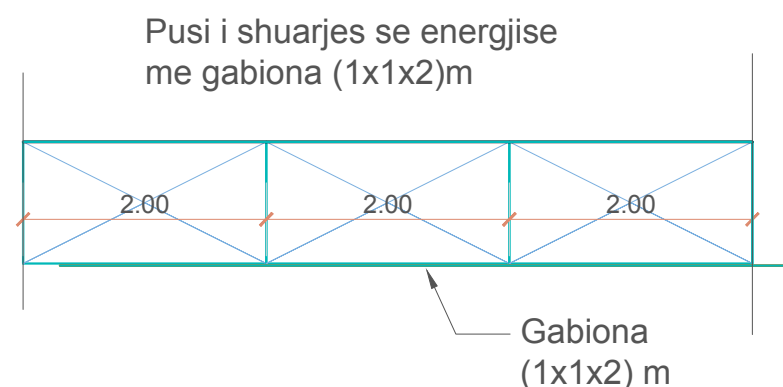

Pllaka ne shkallet e kaperderdhesit, te derdhura ne vend (1x2)m me fuge cdo 2cm

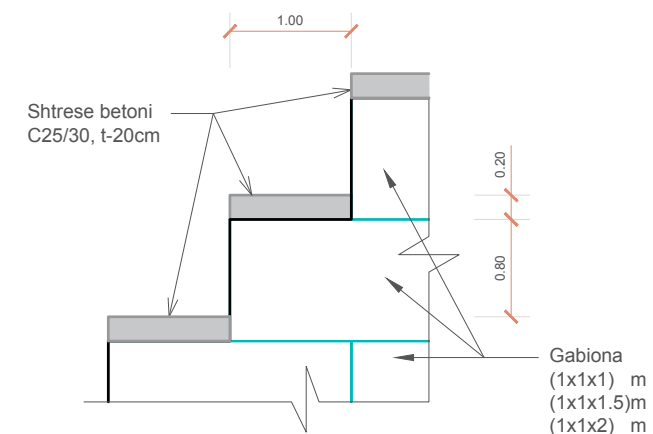

PRERJA 1-1



PLANIMETRIA

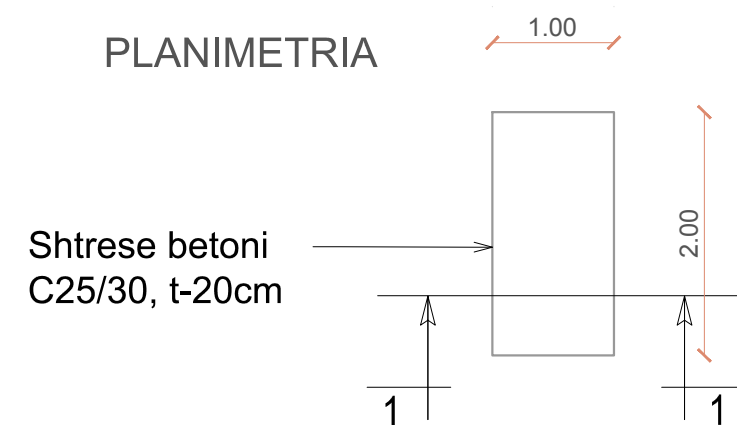

Shenime Teknike:

Betoni qe do te perdoret per veshjen e pragut te kaperderdhesit dhe pergjate renjes se pragut, si dhe pragu i portalit te pusit te shuarjes se energjise te jete i klases C25/30, kurse hekuri S500.

Emërtimi i Objektit PROJEKT-ZBATIM	Blerësi Korporata Elektroenergjitike Shqiptare Sh.a	Furnizuesi		GRUPI I PROJEKTIMIT				Emërtimi i Fletes	Shkalla 1 : 50
		"NET-GROUP" shpk	"ARABEL STUDIO" shpk	Ing. Gjeolog Valter Begaj GJ. 0324/2	Ing. Ndërtimi Ilirian Kokalari K. 1008/3	Ing. Hidroteknik Luljeta Kuci K. 2022/1	Ing. Ndërtimi Luca Falasca K. 2774		
HARTIM PROJEKTI MBROJTJA DHE SISTEMIMI ME PRITA MALORE I PËRROIT TË GOMSIQES	 Adresa: Rruga "Viktor Eftimi" Blloku "Vasil Shanto" Tiranë	 L.72023002P Adresa: Rruga "Viktor Eftimi" Blloku "Vasil Shanto" Tiranë	 LS1812001S Adresa: Rruga "Viktor Eftimi" Blloku "Vasil Shanto" Tiranë	Arkitekt Diana Mitrushi A. 0212/4	Ing. Mjedis Gentjana Luka M. 1613	Ing. Elektrik Burhan Demneri E. 1049/2	Arkitekt Aldo Dushi A. 1982/1	P7 - 10-2023	
				Ing. Mekanic Gjergji Kotori M. 0579/1	Ing. Gjeoinformatik Elfat Shehu T. 1577	Ing. Gjeodet Shqiponja Civici T. 1268	Ing. Gjeodet Marsilda Ferko T. 1582		
				Ing. Gjeodet Ermal Spahiu K. 1084/1	Ing. Gjeodet Dimitër Kono T. 1609				

Betonim i portalit dales te pusit te shuarjes me pllaka te derdhura ne vend (3x2)m me fuge 2cm

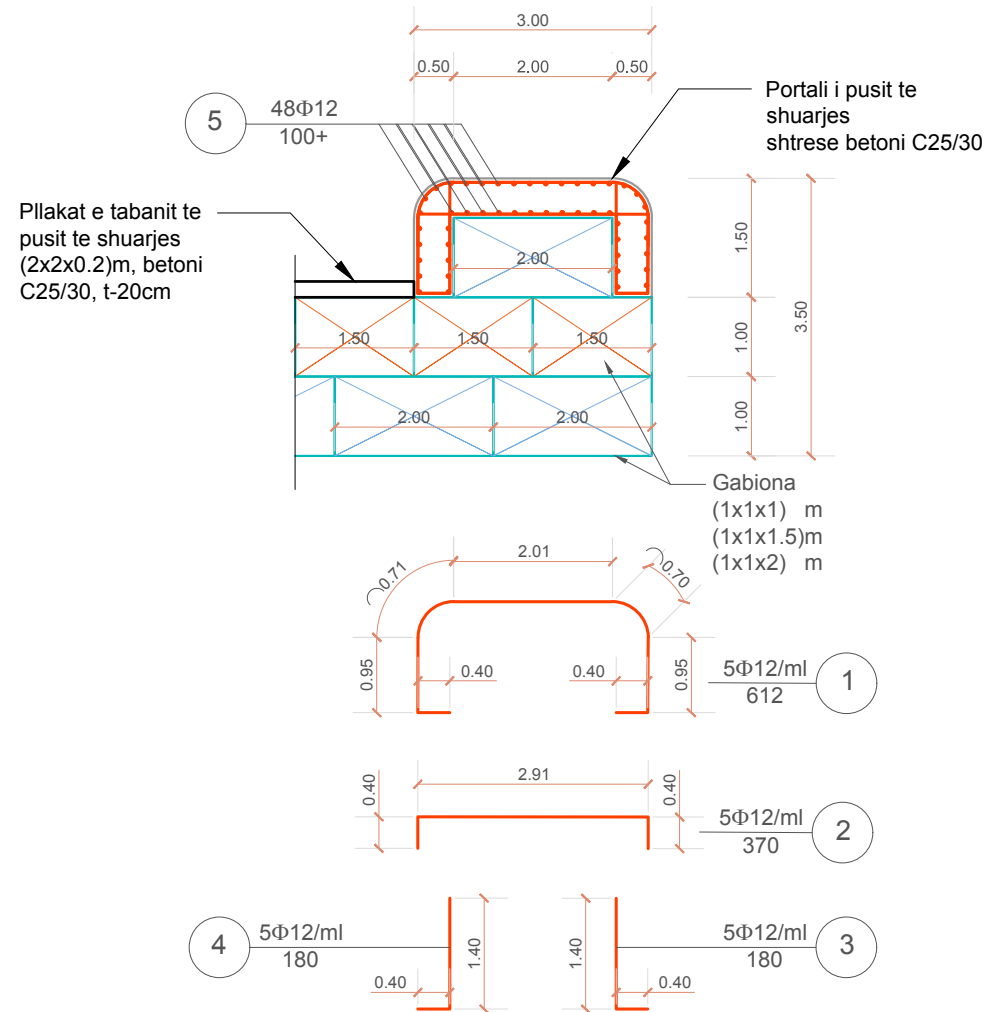

Portali dales i Pusit te Shuarjes (3x2x0,5)m - armatura e hekurit / 1 ml

ELEMENTI		Numri elementit	Φ mm	Gjatesia cm	Sasia cope	Gjatesia totale ml	Armatura Permbledhese			
Iloji	cope						Φ mm	gjatesia ml	Pesha kg	Totali Kg
Portali i pusit te shuarjes ,betoni C25/30, t-50cm	Çdo 2m duhet te zbatohet fuge	1	12	612	5	30,6	12	115,1	0,888	102,2088
		2	12	370	5	18,5				
		3	12	180	5	9				
		4	12	180	5	9				
		5	12	100	48	48				
						Hekur	kg			102,209
						b/a C25/30	m3			2,39

Betonim i pragut te kaperderdhesit me pllaka te derdhura ne vend (3x2)m me fuge 2cm

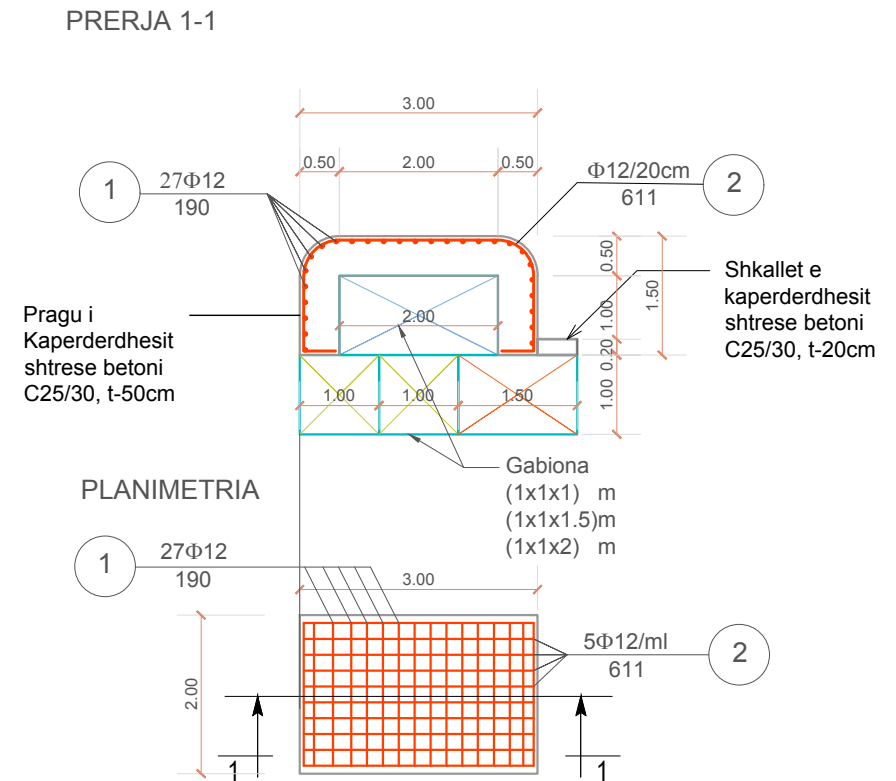

Pragu i Kaperderdhesit (3x2x0,5)m - armatura e hekurit / cope







ELEMENTI	Iloji	cope	Numri elementit	Φ mm	Gjatesia cm	Sasia cope	Gjatesia totale ml	Armatura Permbledhese			
								Φ mm	gjatesia ml	Pesha kg	Totali Kg
Pragu i Kaperderdhesit, C25/30	1 cop me gjatesi 2m	1	12	190	27	51,3	12	112,4	0,888	99,8112	
		2	12	611	10	61,1					
								Hekur	kg		99,811
						b/a C25/30	m3			5,28	
						Sasia per 1 ml					
						Hekur	kg			49,906	
						b/a C25/30	m3			2,64	

Emërtimi i Objektivit PROJEKT-ZBATIM	Blerësi Korporata Elektroenergjitike Shqiptare Sh.a	Furnizuesi		GRUPI I PROJEKTIMIT				Emërtimi i Fletes Detaje te ndryshme	Shkalla 1 : 75
	HARTIM PROJEKTI MBROJTJA DHE SISTEMIMI ME PRITA MALORE I PËRROIT TË GOMSIQES		"NET-GROUP" shpk	"ARABEL STUDIO" shpk	Ing. Gjeolog Valter Begaj GJ. 0324/2	Ing. Ndërtimi Ilirian Kokalari K. 1008/3	Ing. Hidroteknik Luljeta Kuci K. 2022/1		
	Adresa: Rruga "Viktor Eftimi" Blloku "Vasil Shanto" Tiranë			Arkitekt Diana Mitrushi A. 0212/4	Ing. Mjedisi Gentjana Luka M. 1613	Ing. Elektrik Burhan Demneri E. 1049/2	Arkitekt Aldo Dushi A. 1982/1	P7 - 11-2023	
		L72023002P	L51812001S	Ing. Mekanik Gjergji Kotori M. 0579/1	Ing. Gjeoinformatik Elfat Shehu T. 1577	Ing. Gjeodet Shqiponja Civici T. 1268	Ing. Gjeodet Marsilda Ferko T. 1582		
				Ing. Gjeodet Dimitër Kono T. 1609					

Shenime Teknike:

- Gabionat e parashikuar ne projekt me permasa (1x1x1)m, (1x1x1.5)m dhe (1x1x2)m te mbushen me gure te sistemuar, si mure guri i rregullt ne te thate, ku guret je jene te lidhura ne menyre te rregullt dhe te jene te permasave 12-40cm. Ne qoshet e gabionave te vendosen gure me dimension te madh, kurse guret me dimensione me te vogla te perdoren per te bere lidhjen dhe mbushjen e boshlleqeve.
- Kubiket e gabioneve te vendosen ne menyre te alternuar ne drejtimin terthor te prites, gabariti gjatesor i tyre te jete paralel sipas aksit terthor te pritave.
- Masa vellimore e murit te perfunduar ne gabiona te jete 1.7 ton/m3.
- Betoni qe do te perdoret per veshjen e pragut te kaperderdhesit dhe pergjate renjes se pragut, si dhe pragu i portalit te pusit te shuarjes se energjise te jete i klases C25/30, kurse hekuri S500.

Legjenda:



-  Prita me gabiona (1x1x1)m
-  Prita me gabiona (1x1x1.5)m
-  Prita me gabiona (1x1x2)m
-  Shkemb rrenjesor
-  Zhavorre te depozituara
-  Mbushje me shkemb te germuar me pare

Prita Nr.3 (Mbilartesim)

OBJEKTI:

HARTIM PROJEKTI MBROJTJA DHE SISTEMIMI
ME PRITA MALORE I PËRROIT TË GOMSIQES

2023

Emërtimi i Objektit	Blerësi	Furnizuesi		GRUPI I PROJEKTIMIT				Emërtimi i Fletes	Shkalla
PROJEKT-ZBATIM	Korporata Elektroenergjitike Shqiptare Sh.a	"NET-GROUP" shpk	"ARABEL STUDIO" shpk	Ing. Gjeolog Valter Begaj GJ. 0324/2	Ing. Ndërtimi Ilirian Kokalari K. 1008/3			KAPAK - Prita Nr.3	P3M - 00-2023
HARTIM PROJEKTI MBROJTJA DHE SISTEMIMI ME PRITA MALORE I PËRROIT TË GOMSIQES	 Adresa: Rruga "Viktor Eftimi" Blloku "Vasil Shanto" Tiranë	 L.72023002P Adresa: Rruga "Viktor Eftimi" Blloku "Vasil Shanto" Tiranë	 L.51812001S Adresa: Rruga "Viktor Eftimi" Blloku "Vasil Shanto" Tiranë	Ing. Hidroteknik Luljeta Kuci K. 2022/1	Ing. Ndërtimi Luca Falasca K. 2774	Ing. Mjedis Gentjana Luka M. 1613	Arkitekt Aldo Dushi A. 1982/1		
				Ing. Elektrik Burhan Demneri E. 1049/2	Ing. Gjeoinformatik Elfat Shehu T. 1577	Ing. Gjeodet Marsilda Ferko T. 1582	Ing. Gjeodet Dimitër Kono T. 1609		
				Ing. Mekanik Gjergji Kotori M. 0579/1					
				Ing. Gjeodet Shqiponja Civici T. 1268					
				Ing. Ndërtimi Ermal Spahiu K. 1084/1					

PLAN VENDOSJE MBI ORTOFOTO PRITA E PROJEKTUAR NR.3 (MBILARTESIM)

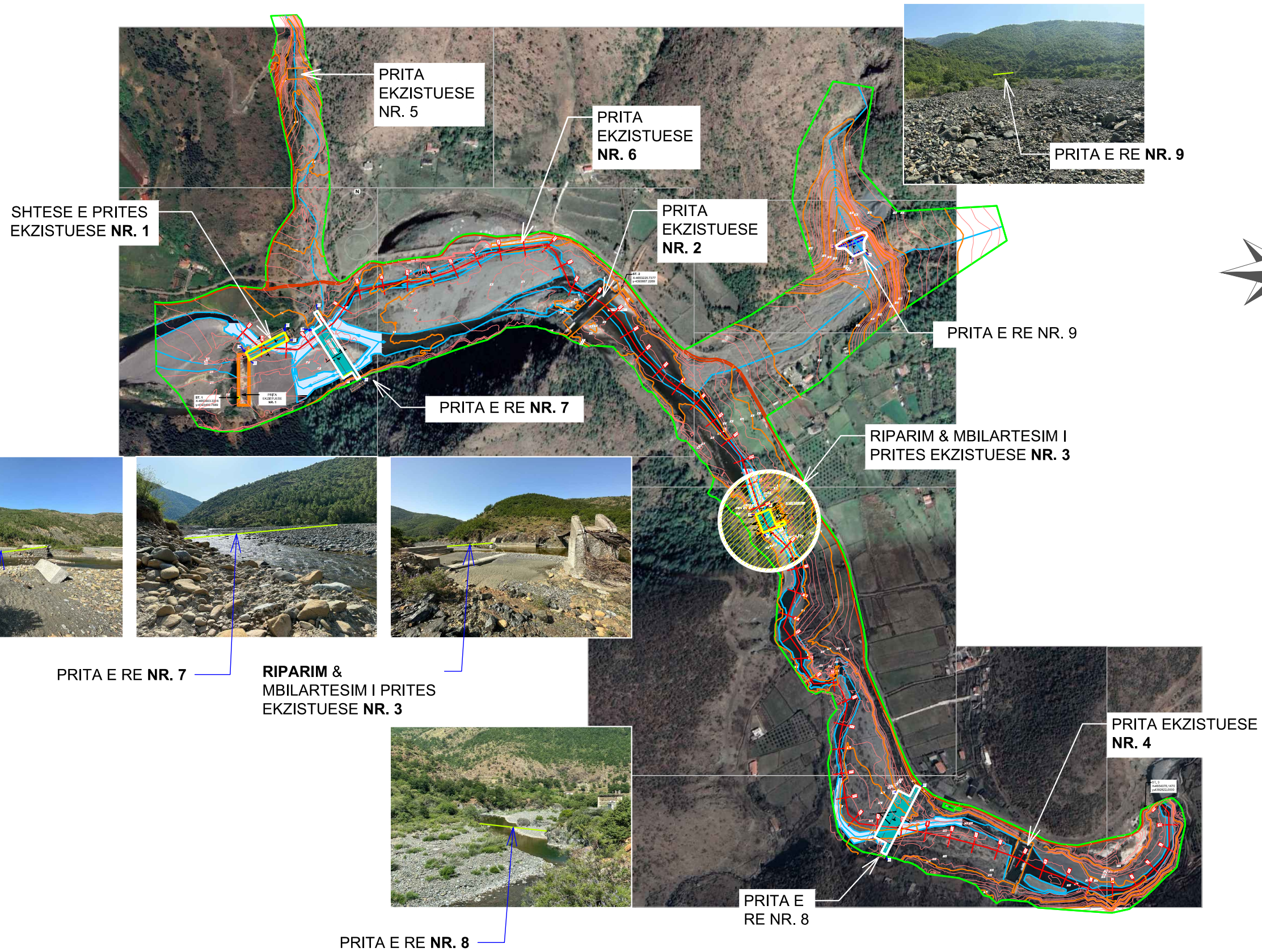

SHTESE E PRITES EKZISTUESE NR. 1

PRITA E RE NR. 7

RIPARIM & MBILARTESIM I PRITES EKZISTUESE NR. 3

PRITA E RE NR. 8

PRITA E RE NR. 8

PRITA EKZISTUESE NR. 4

Emërtimi i Objektit PROJEKT-ZBATIM	Blerësi Korporata Elektroenergjitike Shqiptare Sh.a	Furnizuesi		GRUPI I PROJEKTIMIT				Emërtimi i Fletes Plan Vendosje mbi ortofoto, Prita e projektuar Nr.3 (Mbilartesim)	Shkalla 1 : 2000
	HARTIM PROJEKTI MBROJTJA DHE SISTEMIMI ME PRITA MALORE I PËRROIT TË GOMSIQES		"NET-GROUP" shpk 	"ARABEL STUDIO" shpk 	Ing. Gjeolog Valter Begaj GJ. 0324/2	Ing. Ndërtimi Ilirian Kokalari K. 1008/3	Ing. Ndërtimi Luca Falasca K. 2774		
	Adresa: Rruga "Viktor Eftimi" Blloku "Vasil Shanto" Tiranë	L.72023002P Adresa: Rruga "Viktor Eftimi" Blloku "Vasil Shanto" Tiranë	LS1812001S Adresa: Rruga "Viktor Eftimi" Blloku "Vasil Shanto" Tiranë	Ing. Hidroteknik Luljeta Kuci K. 2022/1	Ing. Ndërtimi Gentjana Luka M. 1613	Ing. Ndërtimi Aldo Dushi A. 1982/1			
				Arkitekt Diana Mitrushi A. 0212/4	Ing. Mjedisi Elfat Shehu T. 1577	Arkitekt Marsilda Ferko T. 1582			
				Ing. Elektrik Burhan Demneri E. 1049/2	Ing. Gjeoinformatik Marsilda Ferko T. 1582	Ing. Gjeodet Dimitër Kono T. 1609			
				Ing. Mekanik Gergji Kotori M. 0579/1					
				Ing. Gjeodet Shqiponja Civici T. 1268					
				Ing. Ndërtimi Ermal Spahiu K. 1084/1					

MBILARTESIM I PRITES NR. 3 (EKZISTUESE)
Planimetria, Sh-1:500

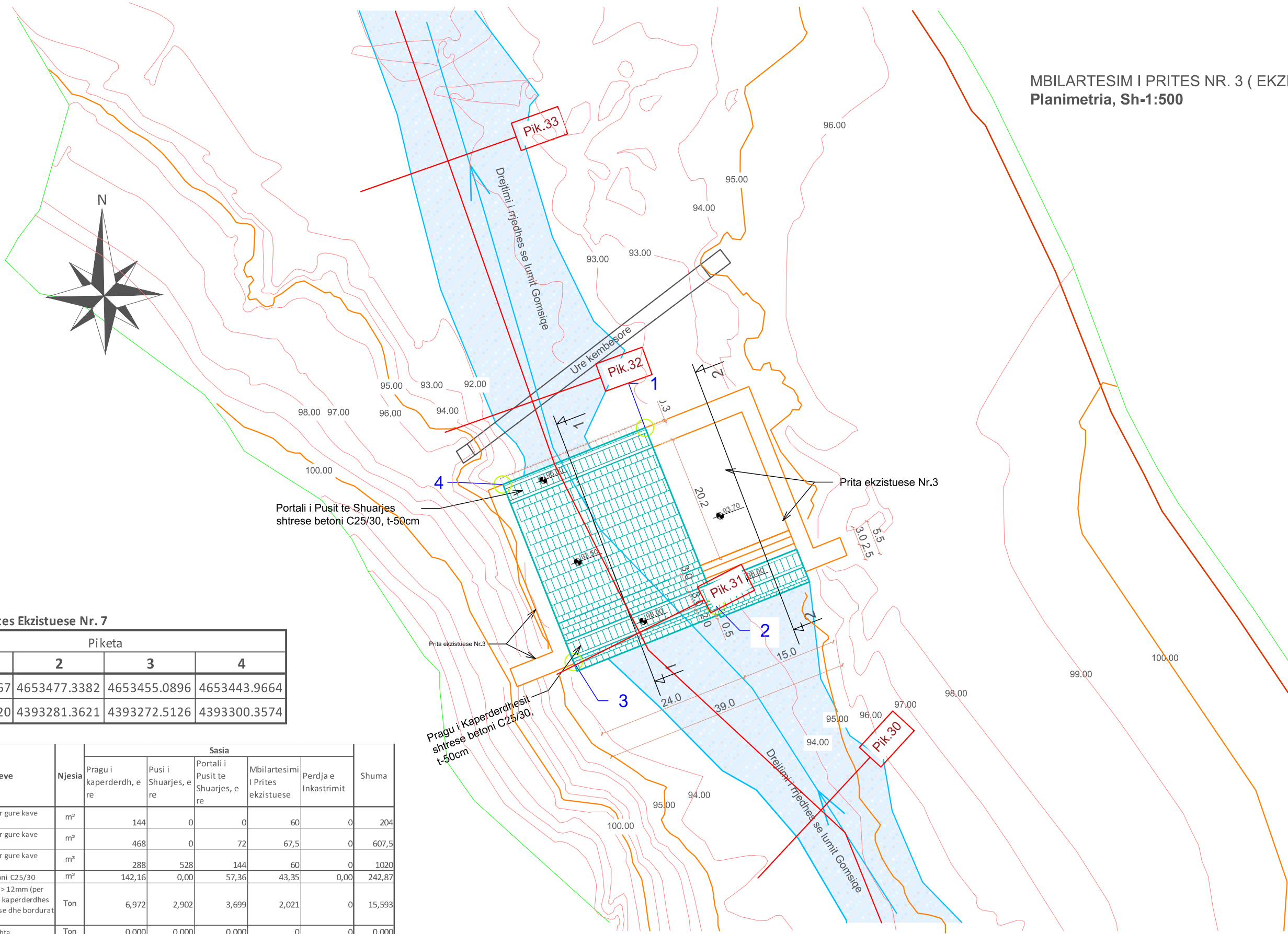

Riparim i Prites Ekzistuese Nr. 7

Orjentimi	Piketa			
	1	2	3	4
X	4653466.2867	4653477.3382	4653455.0896	4653443.9664
Y	4393309.2520	4393281.3621	4393272.5126	4393300.3574

Nr	Pershkrimi i Punimeve	Njesia	Sasia				Shuma	
			Pragu i kaperderdh, e re	Pusi i Shuarjes, e re	Portali i Pusit te Shuarjes, e re	Mbilartesimi i Prites ekzistuese		
1	Gabiona me rrjete teli te zinkuar gure kave 1x1x1 m	m ³	144	0	0	60	0	204
2	Gabiona me rrjete teli te zinguar gure kave 1x1x1.5 m	m ³	468	0	72	67,5	0	607,5
3	Gabiona me rrjete teli te zinguar gure kave 1x1x2 m	m ³	288	528	144	60	0	1020
4	Struktura te holla monolite betoni C25/30	m ³	142,16	0,00	57,36	43,35	0,00	242,87
5	F V hekur betoni i zakonshem Ø > 12mm (per betonimin e pllaka ve te portalit kaperderdhes dhe pusit te shuarjes se energjise dhe bordurat e Gabioneve)	Ton	6,972	2,902	3,699	2,021	0	15,593
6	Konstruksione metalike te thjeshta	Ton	0,000	0,000	0,000	0	0	0,000

Emërtimi i Objektivit PROJEKT-ZBATIM HARTIM PROJEKTI MBROJTJA DHE SISTEMIMI ME PRITA MALORE I PËRROIT TË GOMSIQËS	Blerësi Korporata Elektroenergjitike Shqiptare Sh.a Adresa: Rruga "Viktor Eftimi" Blloku "Vasil Shanto" Tiranë	Furnizuesi "NET-GROUP" shpk L72023002P Adresa: Rruga "Viktor Eftimi" Blloku "Vasil Shanto" Tiranë		"ARABEL STUDIO" shpk LS1812001S Adresa: Rruga "Viktor Eftimi" Blloku "Vasil Shanto" Tiranë		GRUPI I PROJEKTIMIT <table border="0"> <tr> <td>Ing. Gjeolog</td> <td>Valter Begaj</td> <td>GJ. 0324/2</td> <td>Ing. Ndërtimi</td> <td>Ilirian Kokalari</td> <td>K. 1008/3</td> </tr> <tr> <td>Ing. Hidroteknik</td> <td>Luljeta Kuci</td> <td>K. 2022/1</td> <td>Ing. Ndërtimi</td> <td>Luca Falasca</td> <td>K. 2774</td> </tr> <tr> <td>Arkitekt</td> <td>Diana Mitrushi</td> <td>A. 0212/4</td> <td>Ing. Mjedisi</td> <td>Gentjana Luka</td> <td>M. 1613</td> </tr> <tr> <td>Ing. Elektrik</td> <td>Burhan Demneri</td> <td>E. 1049/2</td> <td>Arkitekt</td> <td>Aldo Dushi</td> <td>A. 1982/1</td> </tr> <tr> <td>Ing. Mekanik</td> <td>Gjergji Kotori</td> <td>M. 0579/1</td> <td>Ing. Gjeoinformatik</td> <td>Elfat Shehu</td> <td>T. 1577</td> </tr> <tr> <td>Ing. Gjeodet</td> <td>Shqiponja Civici</td> <td>T. 1268</td> <td>Ing. Gjeodet</td> <td>Marsilda Ferko</td> <td>T. 1582</td> </tr> <tr> <td>Ing. Ndërtimi</td> <td>Ermal Spahiu</td> <td>K. 1084/1</td> <td>Ing. Gjeodet</td> <td>Dimitër Kono</td> <td>T. 1609</td> </tr> </table>				Ing. Gjeolog	Valter Begaj	GJ. 0324/2	Ing. Ndërtimi	Ilirian Kokalari	K. 1008/3	Ing. Hidroteknik	Luljeta Kuci	K. 2022/1	Ing. Ndërtimi	Luca Falasca	K. 2774	Arkitekt	Diana Mitrushi	A. 0212/4	Ing. Mjedisi	Gentjana Luka	M. 1613	Ing. Elektrik	Burhan Demneri	E. 1049/2	Arkitekt	Aldo Dushi	A. 1982/1	Ing. Mekanik	Gjergji Kotori	M. 0579/1	Ing. Gjeoinformatik	Elfat Shehu	T. 1577	Ing. Gjeodet	Shqiponja Civici	T. 1268	Ing. Gjeodet	Marsilda Ferko	T. 1582	Ing. Ndërtimi	Ermal Spahiu	K. 1084/1	Ing. Gjeodet	Dimitër Kono	T. 1609	Emërtimi i Fletes PRITA NR.3, MBILARTESIM PLANIMETRIA	Shkalla 1 : 500 P3M - 02-2023
		Ing. Gjeolog	Valter Begaj	GJ. 0324/2	Ing. Ndërtimi	Ilirian Kokalari	K. 1008/3																																														
Ing. Hidroteknik	Luljeta Kuci	K. 2022/1	Ing. Ndërtimi	Luca Falasca	K. 2774																																																
Arkitekt	Diana Mitrushi	A. 0212/4	Ing. Mjedisi	Gentjana Luka	M. 1613																																																
Ing. Elektrik	Burhan Demneri	E. 1049/2	Arkitekt	Aldo Dushi	A. 1982/1																																																
Ing. Mekanik	Gjergji Kotori	M. 0579/1	Ing. Gjeoinformatik	Elfat Shehu	T. 1577																																																
Ing. Gjeodet	Shqiponja Civici	T. 1268	Ing. Gjeodet	Marsilda Ferko	T. 1582																																																
Ing. Ndërtimi	Ermal Spahiu	K. 1084/1	Ing. Gjeodet	Dimitër Kono	T. 1609																																																