



NOTES:

LEGEND:

Implementuar nga:



Konsulent:



Projekti: OFRIMI I SHERBIMEVE PROFESIONALE - SHERBIME KONSULENCE PER PROJEKTIN E EMERGJENCES NE SHQIPERI COVID 19 (LOT2)

NDERTIMI I LABORATORIT TE RI - TIRANE, SHQIPERI

Titulli i vizatimit:

Pamjet 3D

Perpjesa:	Vizatuar nga:	Kontrolloi:	Data:
	A.K; R.T; D.M; A.G	O.Z	Mar. 2023

Nr. i vizatimit: A.31

Vendi:	Faza e projektit:	Nr.serik:	Rev.:
Shqiperi	Projekti kryesor	A.31	R.05

FORMATI I FLETES : A3

F-01 Detal i Dyshemesë

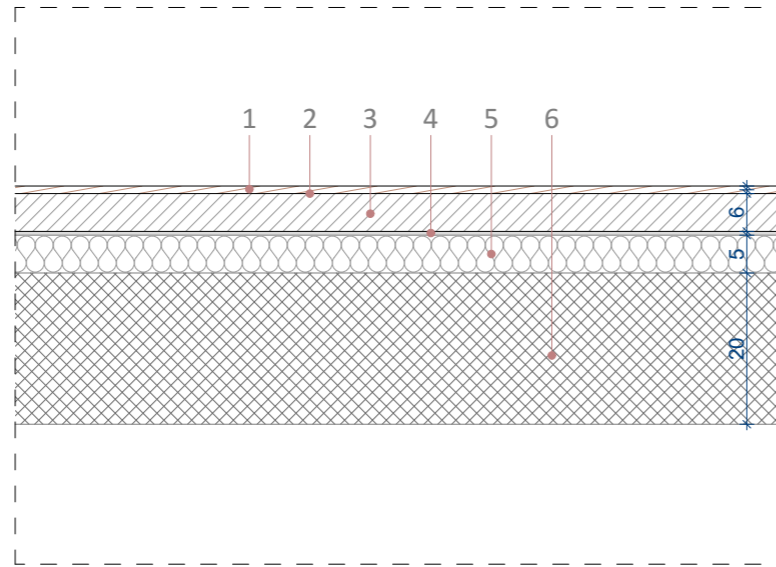

- 1.Vinil konduktiv 2mm
- 2.Shtresa vetënivelizuese
- 3.Estrih 60mm
- 4.PVC Folie
- 5.XPS-Izolim termik 50mm
6. Pllakë betonarme 200mm

F-02 Detal i Dyshemesë

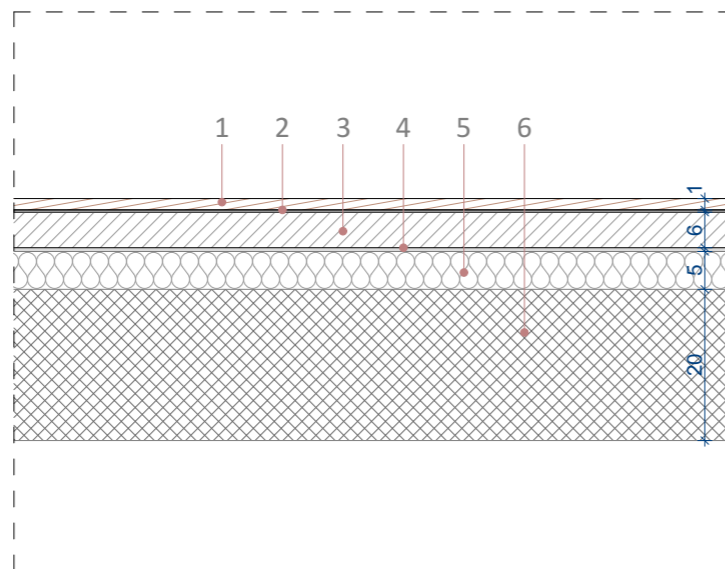

- 1.Granit Artificial 10mm
- 2.Ngjitës
- 3.Estrih 60mm
- 4.PVC Folie
- 5.XPS-Izolim termik 50mm
- 6.Pllakë betonarme 200mm

NOTES:

LEGEND:

Implementuar nga:



Konsulent:



Projekti: OFRIMI I SHERBIMEVE PROFESIONALE - SHERBIME KONSULENCE PER PROJEKTIN E EMERGJENCES NE SHQIPERI COVID 19 (LOT2)

NDERTIMI I LABORATORIT TE RI - TIRANE, SHQIPERI

Titulli i vizatimit:

Detajet e dyshemes F-01, F-02

Perpjesa:	Vizuar nga:	Kontrolloi:	Data:
1:10	A.K; R.T; D.M; A.G	O.Z	Mar. 2023

Nr. i vizatimit: A.32

Vendi:	Faza e projektit:	Nr.serik:	Rev.:
Shqiperi	Projekti kryesor	A.32	R.05

FORMATI I FLETES : A3

F-03 Detal i Dyshemesë

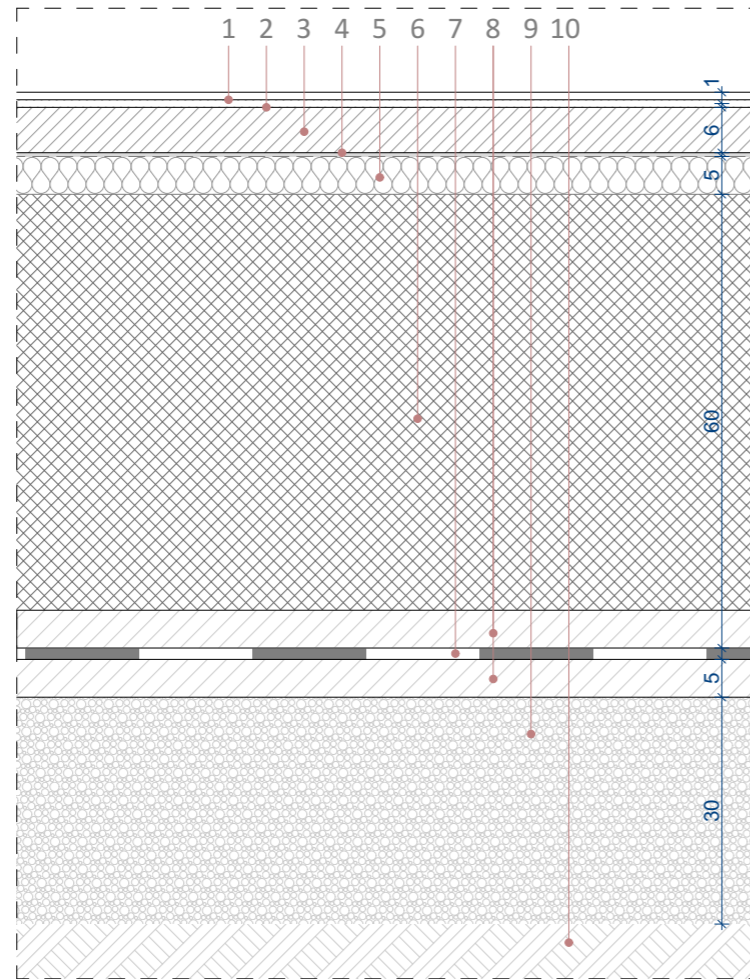

1. Pllaka Qeramike 10mm
2. Ngjitës
3. Estrih 60mm
4. PVC Folie
5. XPS-Izolim termik 50mm
6. Pllakë betonarme 600mm
7. Hidroizolim 2x4mm
8. Beton i varfer 50mm
9. Zhavor 300mm
10. Dhe i ngjeshur

F-04 Detal i Dyshemesë

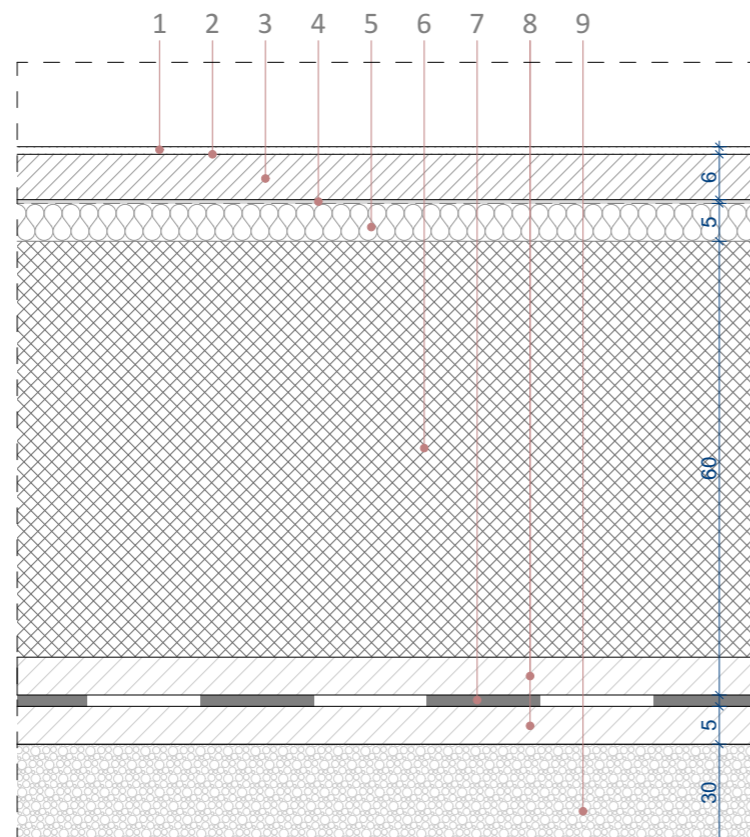

1. Epoksi 2mm
2. Shtresë vetënivelizuese
3. Estrih 60mm
4. PVC Folie
5. XPS-Izolim termik 50mm
6. Pllakë betonarme 600mm
7. Hidroizolim 3mm
8. Beton i varfër 50mm
9. Zhavor 300mm

NOTES:

LEGEND:

Implementuar nga:



Konsulent:



Projekti: OFRIMI I SHERBIMEVE PROFESIONALE - SHERBIME KONSULENCE PER PROJEKTIN E EMERGJENCES NE SHQIPERI COVID 19 (LOT2)

NDERTIMI I LABORATORIT TE RI - TIRANE, SHQIPERI

Titulli i vizatimit:

Detajet e dyshemes F-03, F-04

Perpjesa:	Vizatuar nga:	Kontrolloi:	Data:
1:10	A.K; R.T; D.M; A.G	O.Z	Mar. 2023

Nr. i vizatimit: A.33

Vendi:	Faza e projektit:	Nr.serik:	Rev.:
Shqiperi	Projekti kryesor	A.33	R.05

FORMATI I FLETES : A3

F-05 Detal i Dyshemesë

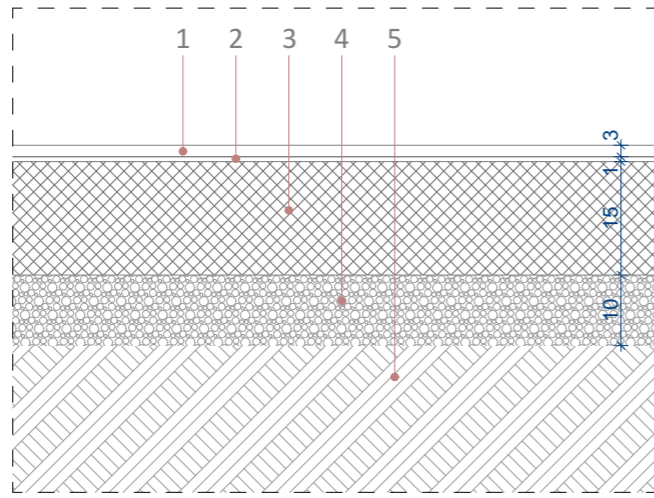

- 1.Granit Natyral 30mm
- 2.Ngjitës
- 3.Pllakë betonarme 150mm
- 4.Zhavor 100mm
- 5.Dhe

F-06 Detal i Dyshemesë

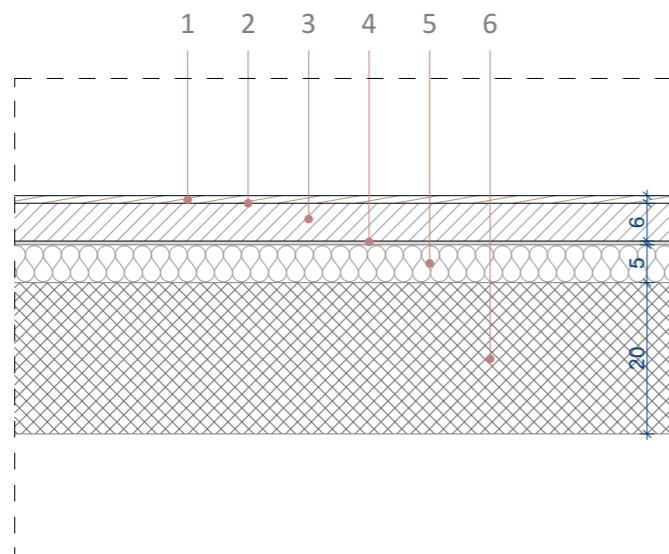

- 1.Epoksi 2mm
- 2.Shtresë vetënivelizuese
- 3.Estrih 60mm
- 4.PVC Folie
- 5.XPS-Izolim termik 50mm
- 6.Pllakë betonarme 600mm

NOTES:

LEGEND:

Implementuar nga:



Konsulent:



Projekti: OFRIMI I SHERBIMEVE PROFESIONALE - SHERBIME KONSULENCE PER PROJEKTIN E EMERGJENCES NE SHQIPERI COVID 19 (LOT2)

NDERTIMI I LABORATORIT TE RI - TIRANE, SHQIPERI

Titulli i vizatimit:

Detajet e dyshemes F-05, F-06

Perpjesa:	Vizatuar nga:	Kontrolloi:	Data:
1:10	A.K; R.T; D.M; A.G	O.Z	Mar. 2023

Nr. i vizatimit: A.34

Vendi:	Faza e projektit:	Nr.serik:	Rev.:
Shqiperi	Projekti kryesor	A.34	R.05

FORMATI I FLETES : A3

F-07 Floor Detail

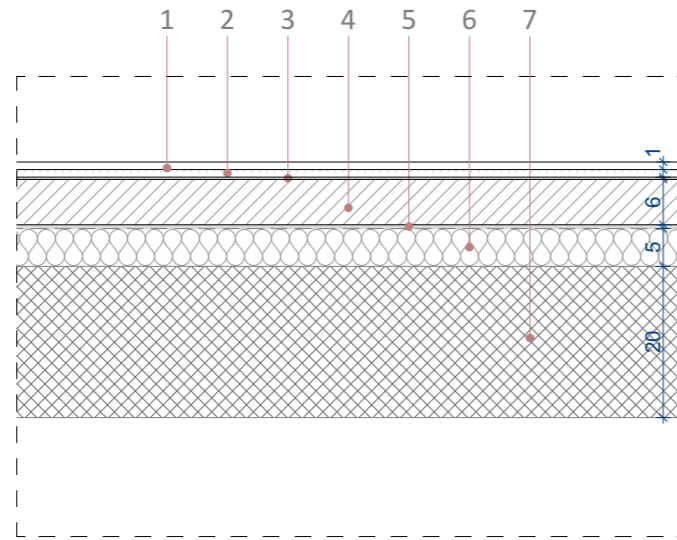

- 1.Ceramic Tiles 10mm
- 2.Adhesive Mortar
- 3.Cold waterproof layer
- 4.Cement Screed 60mm
- 5.PVC Foil
- 6.XPS-Thermal insulation 50mm
- 7.Reinforced Concrete slab 200mm

F-08 Detal i Dyshemesë

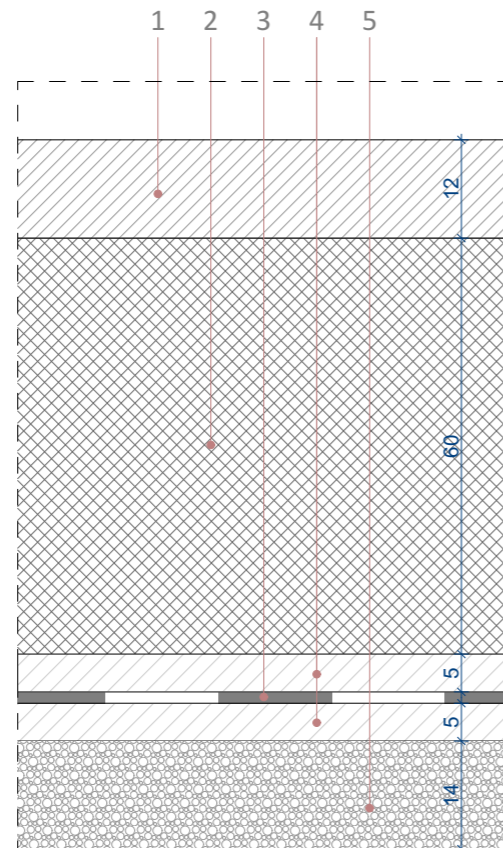

- 1.Ferrobeton 120mm
- 2.Pllakë betonarme 600mm
- 3.Hidroizolim 3mm
- 4.Beton i varfër 50mm
- 5.Zhavor 300mm

NOTES:

LEGEND:

Implementuar nga:



Konsulent:



Projekti: OFRIMI I SHERBIMEVE PROFESIONALE - SHERBIME KONSULENCE PER PROJEKTIN E EMERGJENCES NE SHQIPERI COVID 19 (LOT2)

NDERTIMI I LABORATORIT TE RI - TIRANE, SHQIPERI

Titulli i vizatimit:

Detajet e dyshemes F-07, F-08

Perpjesa:	Vizatuar nga:	Kontrolloi:	Data:
1:10	A.K; R.T; D.M; A.G	O.Z	Mar. 2023

Nr. i vizatimit: A.35

Vendi:	Faza e projektit:	Nr.serik:	Rev.:
Shqiperi	Projekti kryesor	A.35	R.05

FORMATI I FLETES : A3

PRERJA E KAFAZIT TË SHKALLËVE 1:50

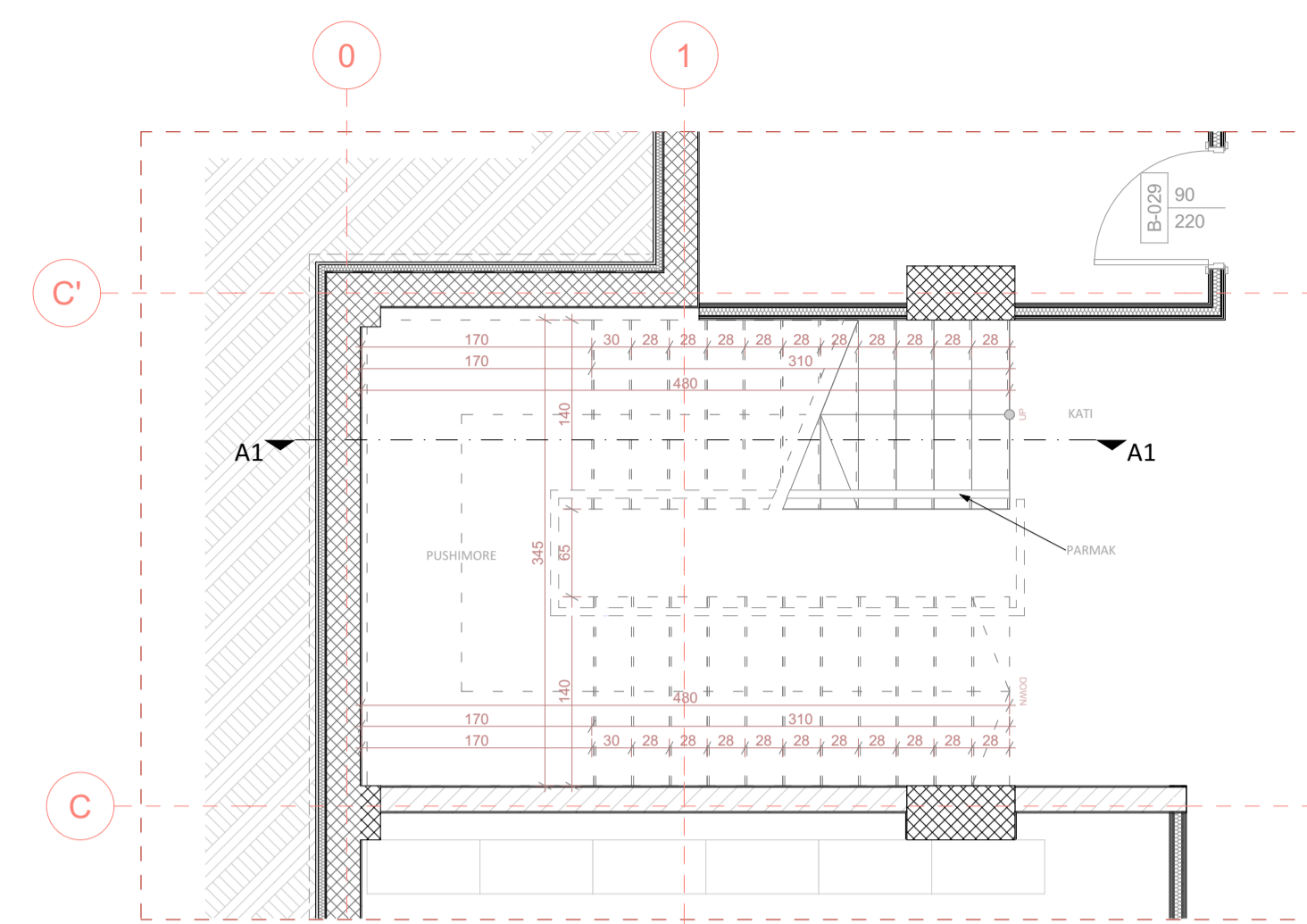
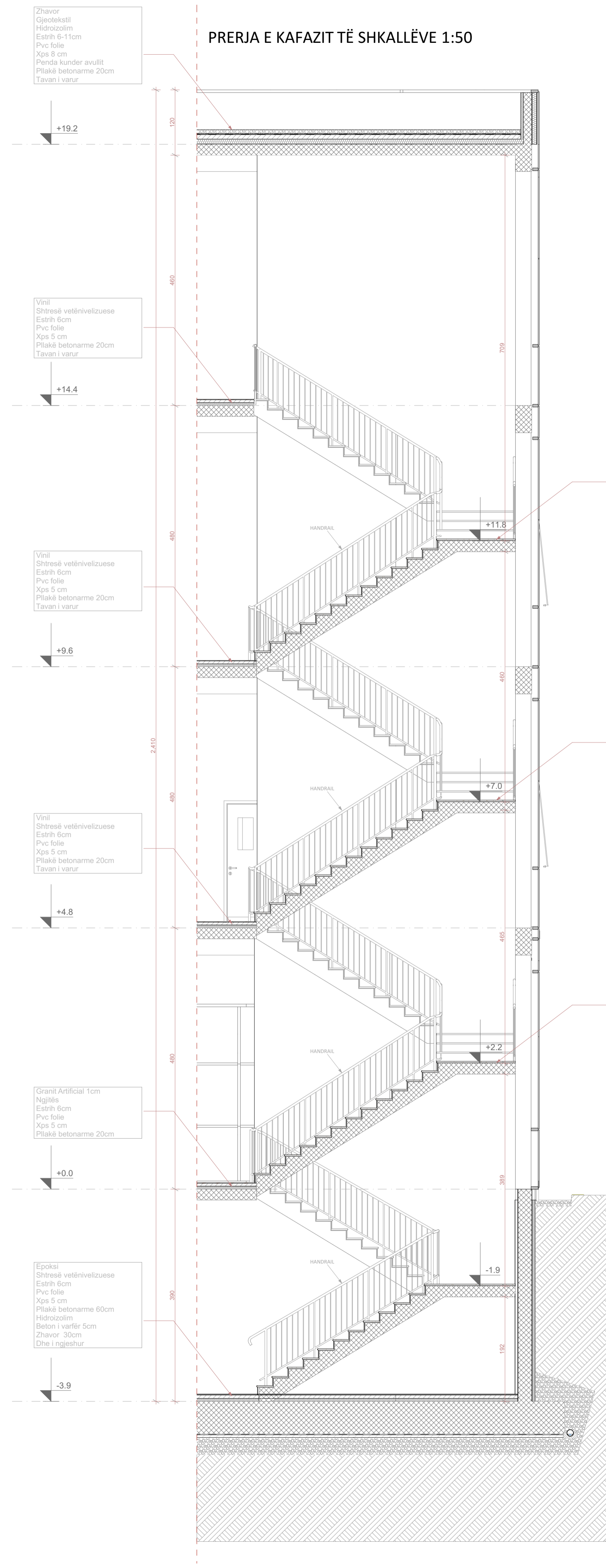

BAZA E BODRUMIT 1:50

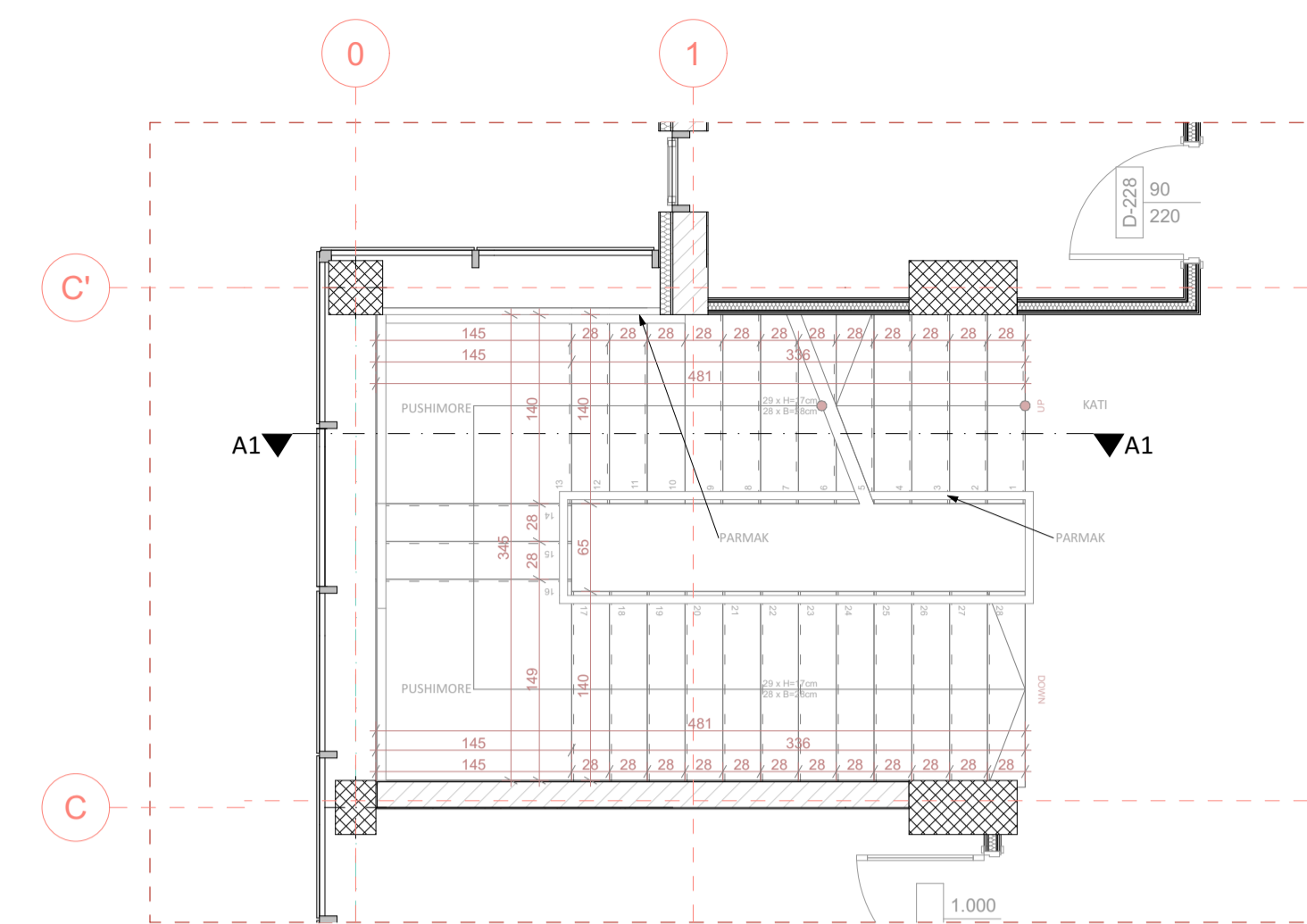

BAZA E KATIT KARAKTERISTIK 1:50

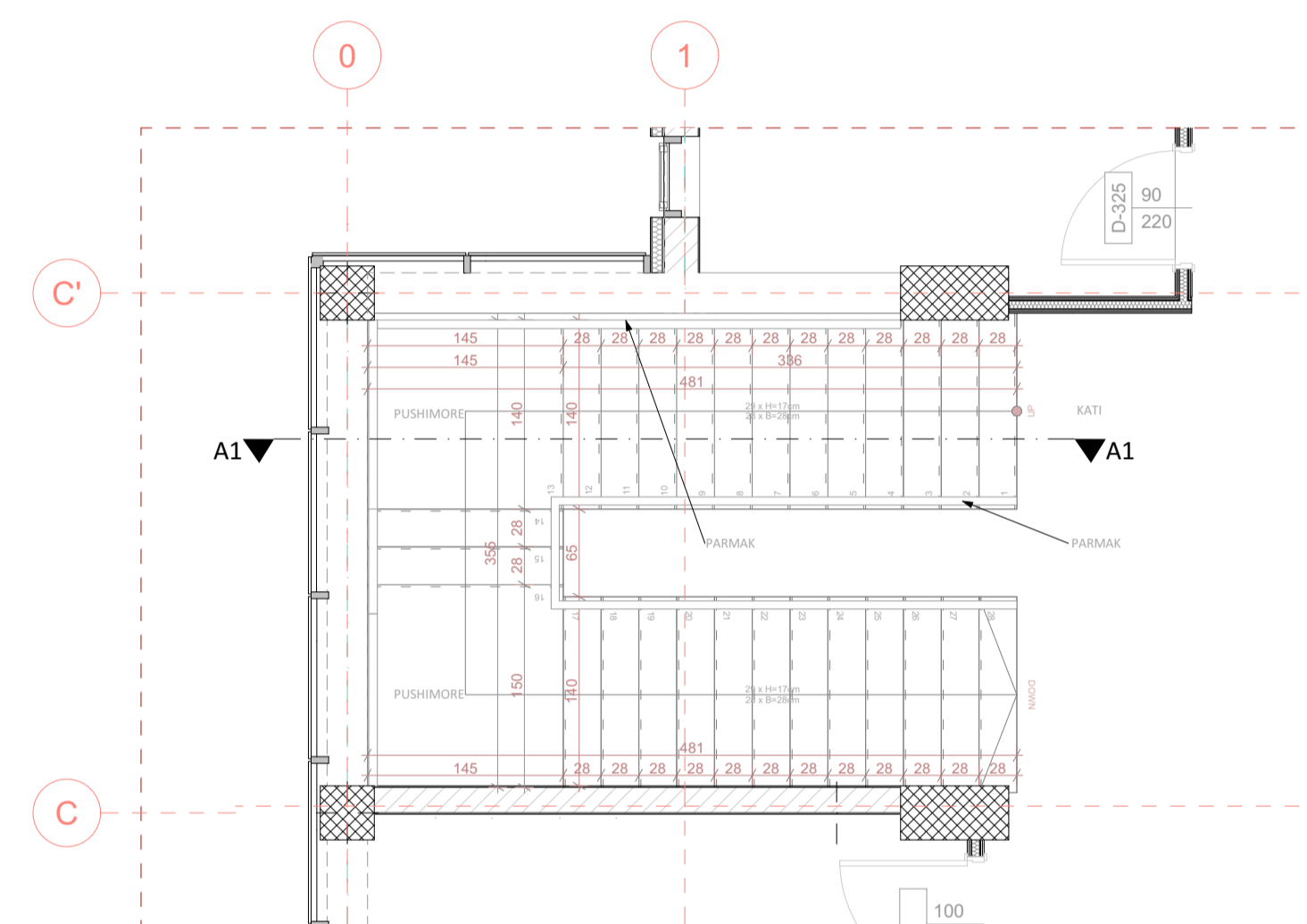

BAZA E KULMIT 1:50

FASADA TIPIKE E PARMAKUT NË MUR 1:30

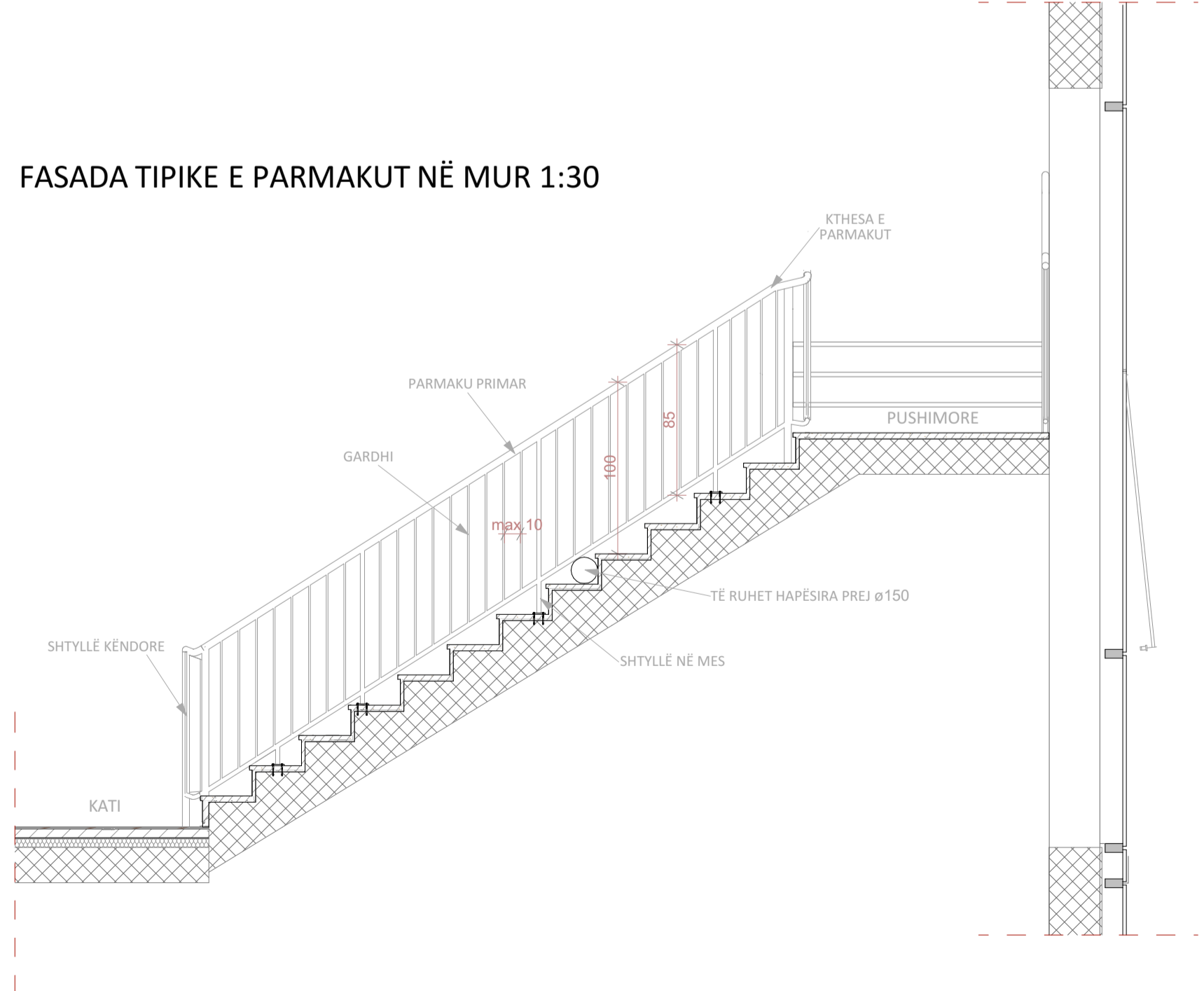

DETALI TIPIK I SHKALLËVE 1:10

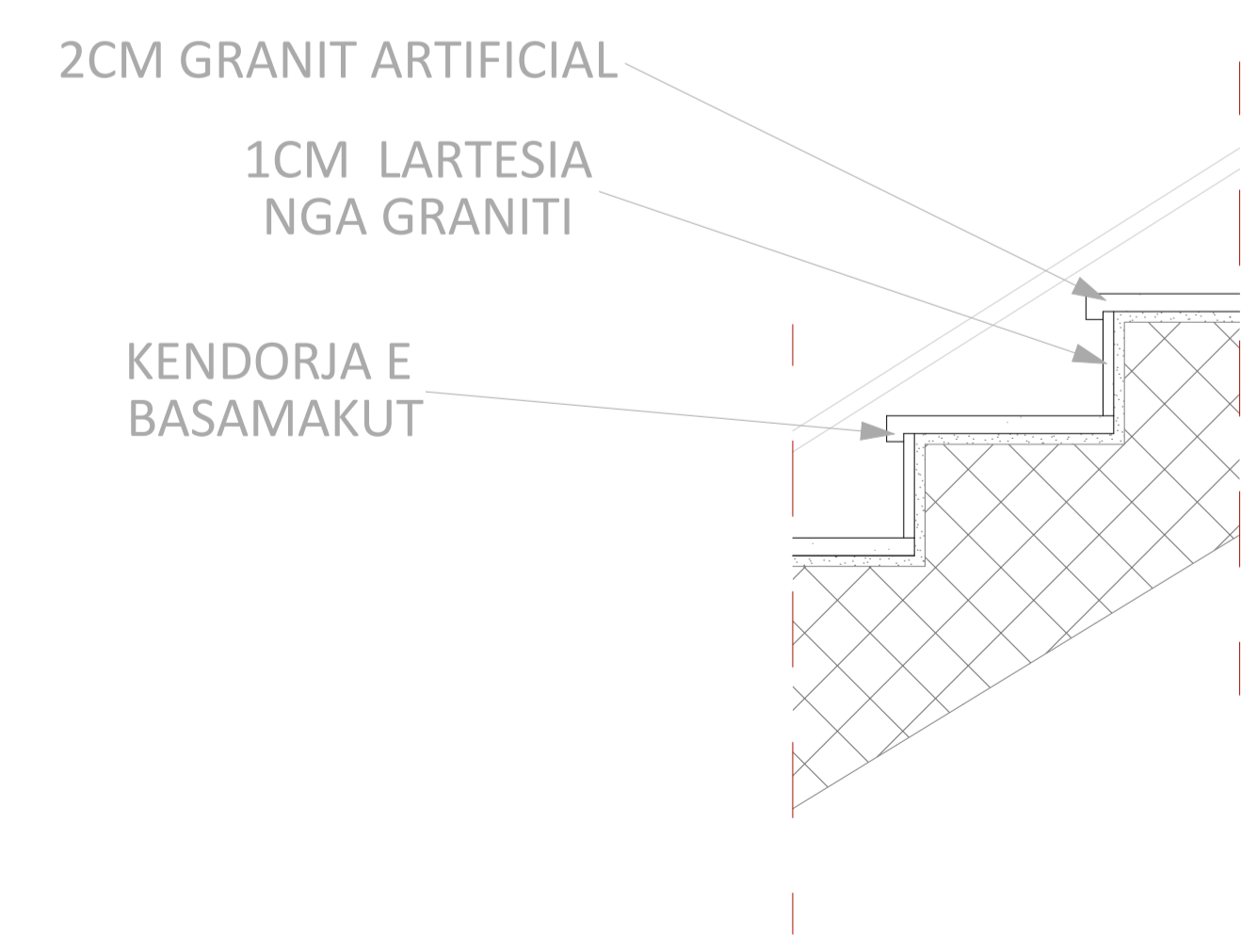

SHENIME:

LEJENDA:

Implementuar nga: **UNOPS**

Konsulent: **ALB-ARCHITECT**
ACTI

Projekti: OFRIMI I SHËRBIMEVE PROFESIONALE - SHËRBIME KONSULENCE PËR PROJEKTIN E EMERGENCËS NË SHQIPËRI COVID 19 (LOT2)
 NËKËTIMI I LABORATORIT TË EL - TIRANË, SHQIPËRI

Titulli i vizatimit: **Detaji i gardhit dhe shkallëve**

Përzgjedhja: 1:50	Vizatuesi nga: A.K; R.T; D.M; A.G	Kontrollori: O.Z	Data: Mar 2023
Nr. i vizatimit: A.36			
Vendi: Shqiperi	Faza e projektit: Projekt kryesor	Nr. serik: A.36	Rev.: R.05

FORMATI I FLETES : A1

R-01 Detal i parapetit të kulmit

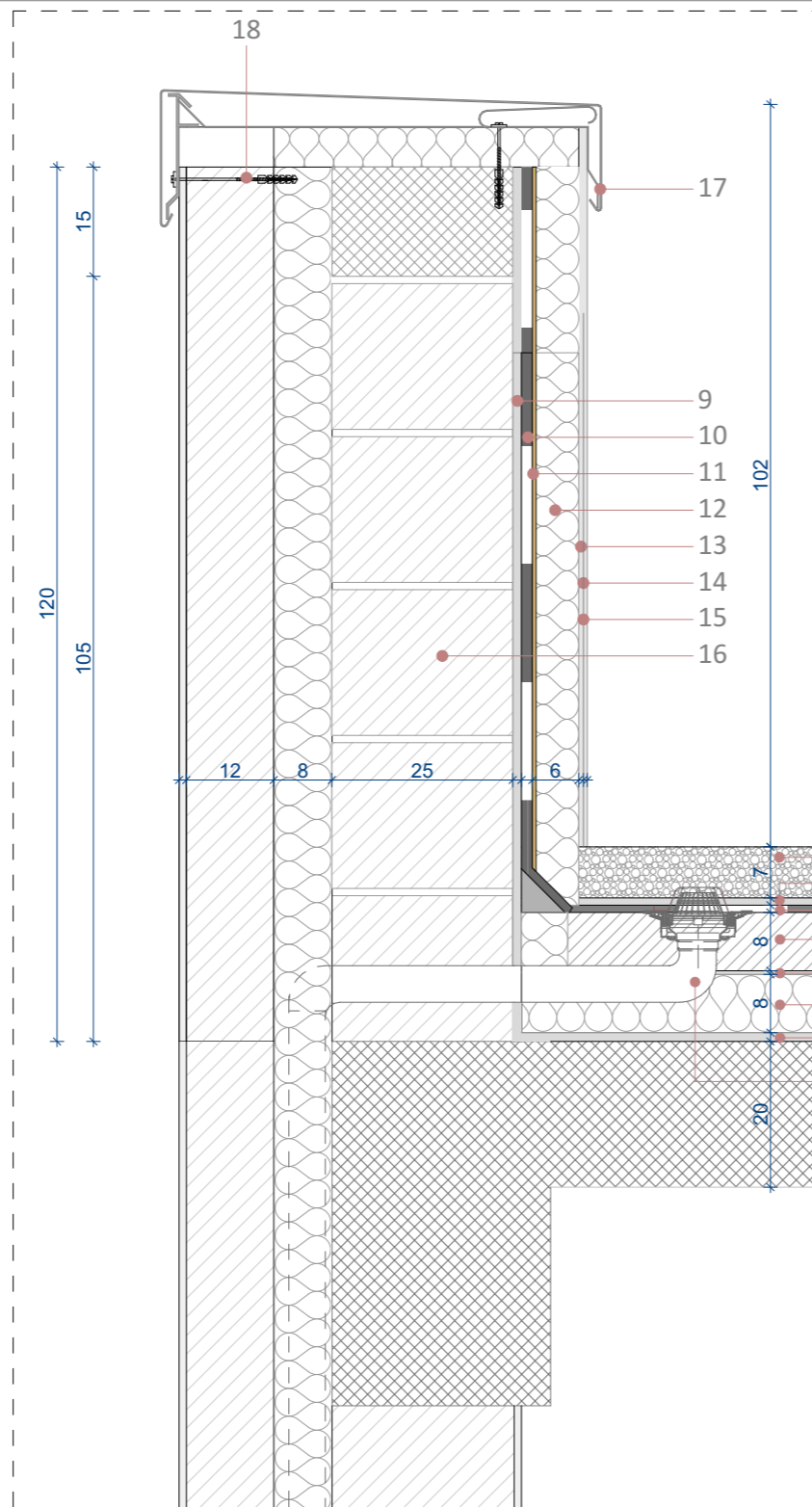

1. Zhavor 70mm
2. Gjeotekstil 10mm
3. Shtresë hidroizolimi PVC 10mm
4. Estrih 60-160mm
5. PVC Folie
6. XPS Izolim termik 80mm
7. Pendë kunder avullit 10mm
8. Ujëmbledhës
9. Pendë kunder avullit
10. Hidroizolim
11. Shkumë
12. XPS Izolim termik 80mm
13. Ngjitës+Rrjetë
14. Ngjitës
15. Shtresë bazë+Fasadë
16. Blok argjile 250mm
17. Llamarinë
18. Tiplla

NOTES:

LEGEND:

Implementuar nga:



Konsulent:



Projekti: OFRIMI I SHERBIMEVE PROFESIONALE - SHERBIME KONSULENCE PER PROJEKTIN E EMERGJENCES NE SHQIPERI COVID 19 (LOT2)

NDERTIMI I LABORATORIT TE RI - TIRANE, SHQIPERI

Titulli i vizatimit:

Detaji i kulmit R-01

Perpjesa:	Vizuar nga:	Kontrollor:	Data:
1:10	A.K; R.T; D.M; A.G	O.Z	Mar. 2023

Nr. i vizatimit: A.37

Vendi:	Faza e projektit:	Nr.serik:	Rev.:
Shqiperi	Projekti kryesor	A.37	R.05

FORMATI I FLETES : A3

R-02 Detali i parapetit të kulmit

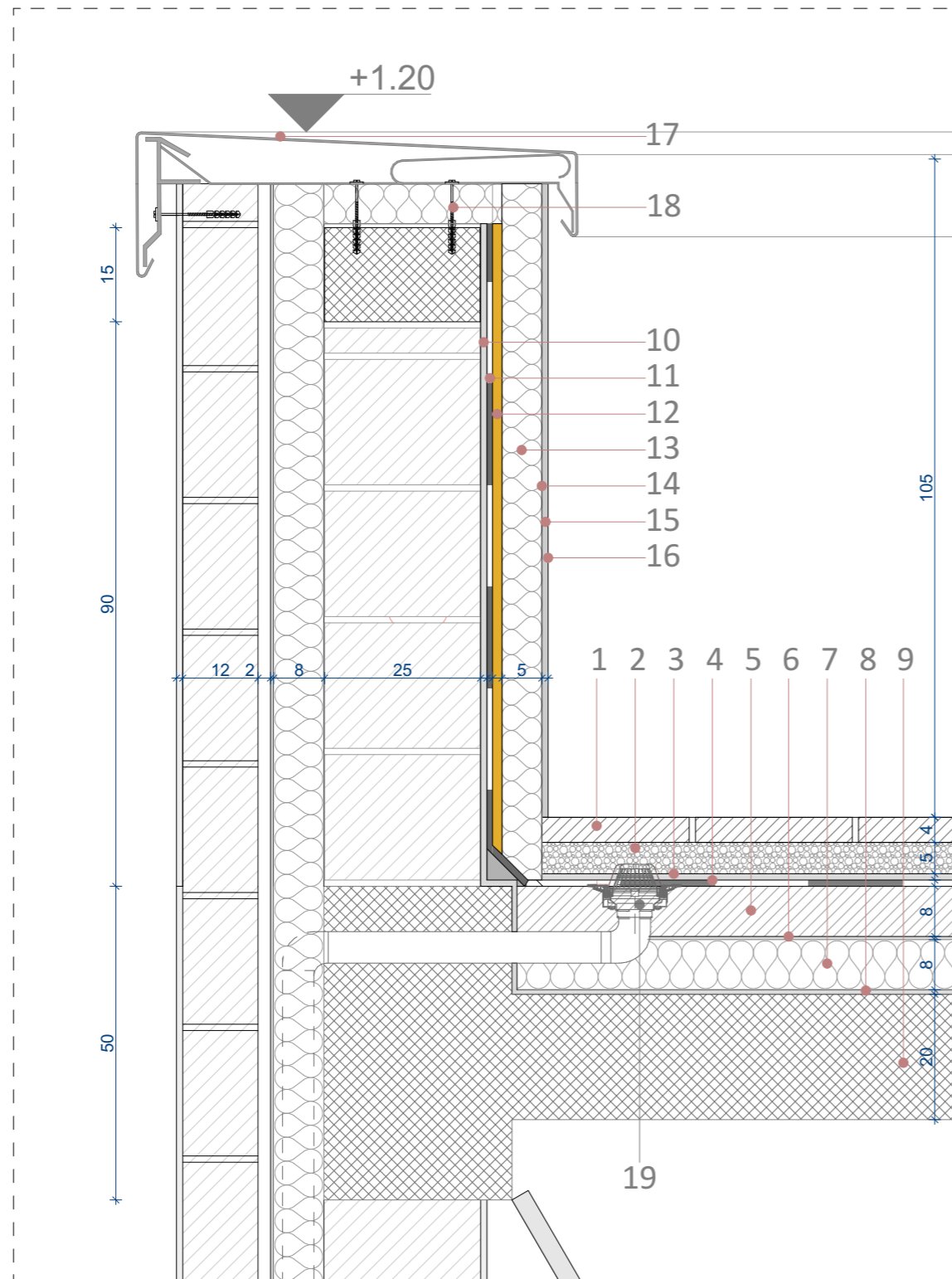

1. Pllaka Betoni 40mm
2. Zhavor 50mm
3. Gjeotekstil
4. Hidroizolim
5. Estrih 60-110mm
6. PVC Folie
7. XPS-Izolim termik 80mm
8. Pendë kunder avullit
9. Pllakë betonarme
10. Pendë kunder avullit
11. Hidroizolim
12. Shkumë
13. XPS-Izolim termik 50mm
14. Ngjitës+Rrjetë
15. Ngjitës
16. Shtresë bazë+Fasadë
17. Llamarinë
18. Tipla
19. Ujëmbledhës

NOTES:

LEGEND:

Implementuar nga:



Konsulent:



Projekti: OFRIMI I SHERBIMEVE PROFESIONALE - SHERBIME KONSULENCE PER PROJEKTIN E EMERGJENCES NE SHQIPERI COVID 19 (LOT2)

NDERTIMI I LABORATORIT TE RI - TIRANE, SHQIPERI

Titulli i vizatimit:

Detaji i kulmit R-02

Perpjesa:	Vizuar nga:	Kontrolloi:	Data:
1:10	A.K; R.T; D.M; A.G	O.Z	Mar. 2023

Nr. i vizatimit: A.38

Vendi:	Faza e projektit:	Nr.serik:	Rev.:
Shqiperi	Projekti kryesor	A.38	R.05

FORMATI I FLETES : A3

G-01 Detali i cokllës

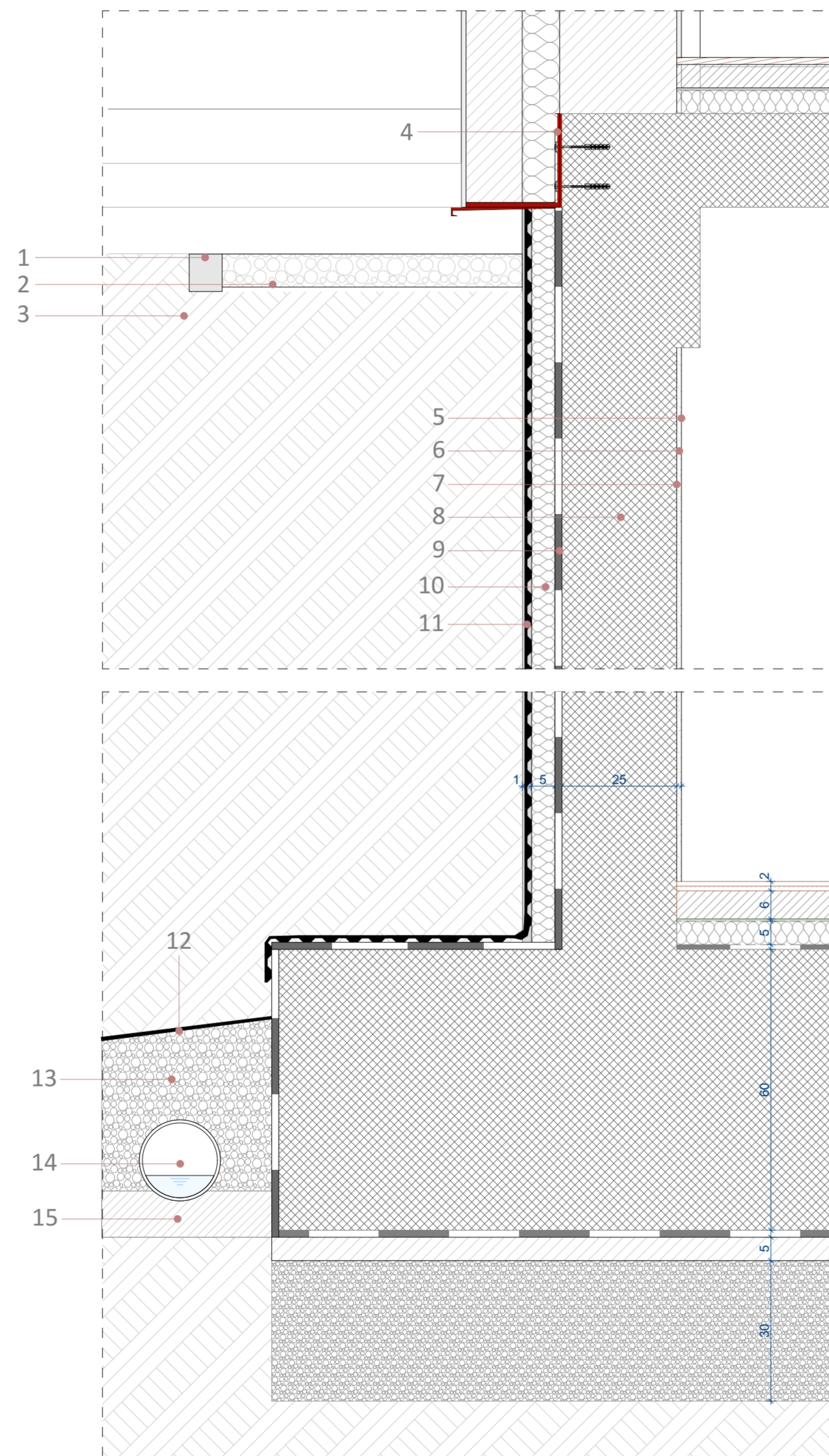

- 1.Element anësor
- 2.Zhavor
- 3.Dhe i ngjeshur
- 4.Profil metalik L
- 5.Suvatim
- 6.Ngjitës+Rrjetë
7. Llaç çimentoje
- 8.Muri betonarme 250mm
- 9.Hidroizolim
- 10.XPS izolim termik 50mm
- 11.Fondalina
- 12.Gjeotekstil
- 13.Zhavor
- 14.Gyp drenazhimi DN 160mm
- 15.Beton

SHENIME:

LEGIENDA:

Implementuar nga:



Konsulent:



Projekti: OFRIMI I SHERBIMEVE PROFESIONALE - SHERBIME KONSULENCE PER PROJEKTIN E EMERGJENCES NE SHQIPERI COVID 19 (LOT2)

NDERTIMI I LABORATORIT TE RI - TIRANE, SHQIPERI

Titulli i vizatimit:

Detaji i themeleve G-01

Perpjesa:	Vizatuar nga:	Kontrolloi:	Data:
1:10	A.K; R.T; D.M; A.G	O.Z	Mar. 2023



Nr. i vizatimit: A.39

Vendi:	Faza e projektit:	Nr.serik:	Rev.:
Shqiperi	Projekti kryesor	A.39	R.05

FORMATI I FLETES : A2

Trajtet mbështetëse në mure
 b/h=20/20cm, b/h=12/20cm, C 25/30, B 500B, a=2.0cm

Legjenda

Ngjyra	Kodi
	Armatura gjatësore
	Stafa

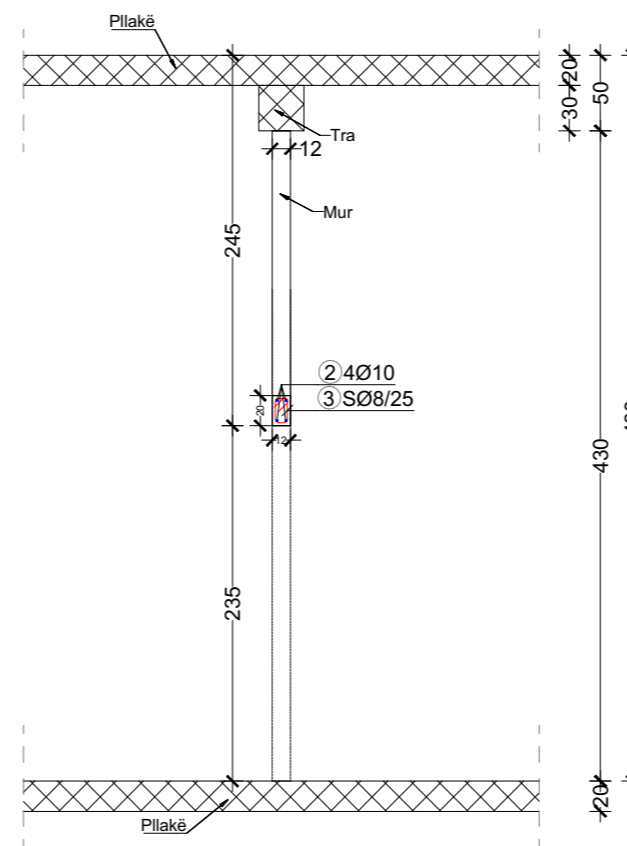
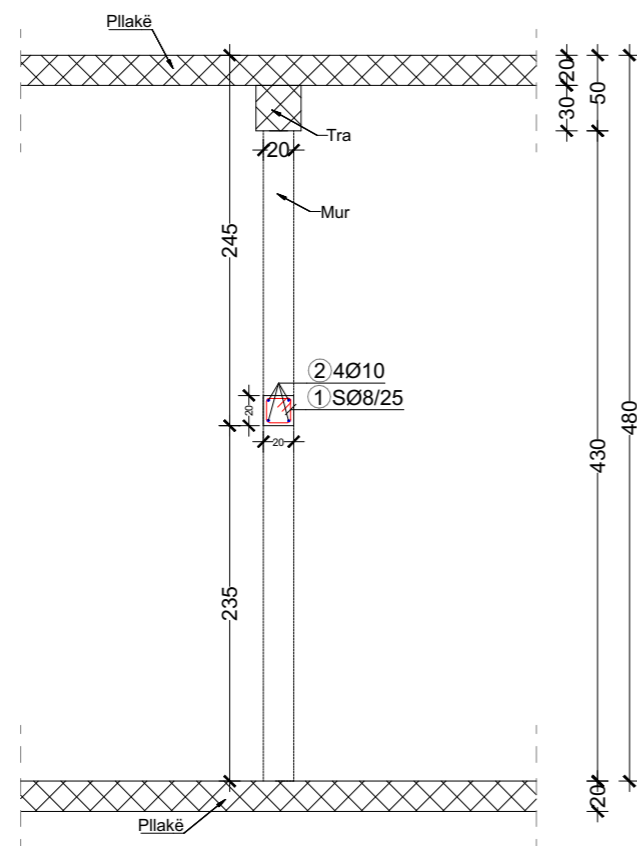

NOTES:

LEGEND:

Implementuar nga:



Konsulent:



Projekti: OFRIMI I SHERBIMEVE PROFESIONALE - SHERBIME KONSULENCE PER PROJEKTIN E EMERGJENCES NE SHQIPERI COVID 19 (LOT2)

NDERTIMI I LABORATORIT TE RI - TIRANE, SHQIPERI

Titulli i vizatimit:

Muri i brendshem ndares

Perpjesa:	Vizatuar nga:	Kontrolloi:	Data:
1:50	A.K; R.T; D.M; A.G	O.Z	Mar. 2023

Nr. i vizatimit: A.40

Vendi:	Faza e projektit:	Nr.serik:	Rev.:
Shqiperi	Projekti kryesor	A.40	R.05

FORMATI I FLETES : A3

EW-03 Detali i murit

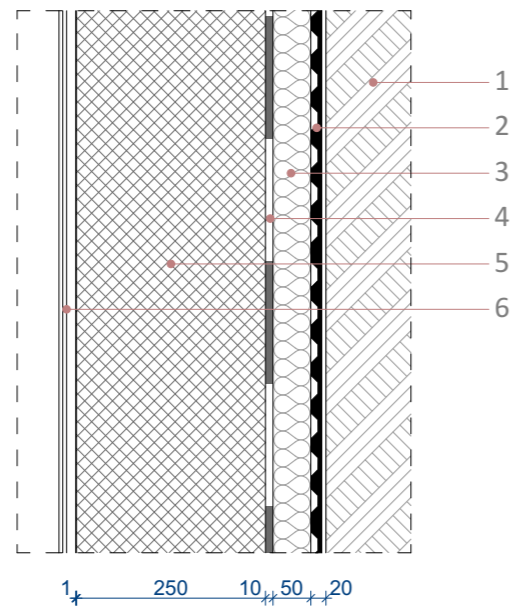

- 1.Dhe
- 2.Fondalina
3. XPS Izolim termik 50mm
- 4.Hidroizolim 4mm
- 5.Mur i betonit 250mm
- 6.Suvatim

EW-04 Detal i murit

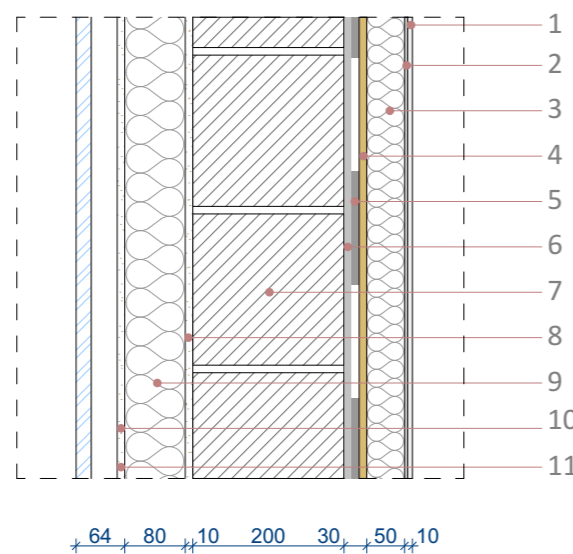

- 1.Shtresë bazë + Fasadë
- 2.Ngjitës + Rrjetë
- 3.XPS Izolim termik 50mm
- 4.Shkumë
- 5.Hidroizolim
- 6.Pendë avulli
- 7.Blllok argjile 200mm
- 8.Ngjitës
- 9.Lesh guri 80mm
- 10.Folie difuzive
- 11.Fasadë e ventiluar

NOTES:

LEGEND:

Implementuar nga:



Konsulent:



Projekti: OFRIMI I SHERBIMEVE PROFESIONALE - SHERBIME KONSULENCE PER PROJEKTIN E EMERGJENCES NE SHQIPERI COVID 19 (LOT2)

NDERTIMI I LABORATORIT TE RI - TIRANE, SHQIPERI

Titulli i vizatimit:

Detajet e mureve EW-03, EW-04

Perpjesa:	Vizatuar nga:	Kontrolloi:	Data:
1:10	A.K; R.T; D.M; A.G	O.Z	Mar. 2023

Nr. i vizatimit: **A.40.1**

Vendi:	Faza e projektit:	Nr.serik:	Rev.:
Shqiperi	Projekti kryesor	A.40.1	R.05

FORMATI I FLETES : A3

EW-01 Detali i murit

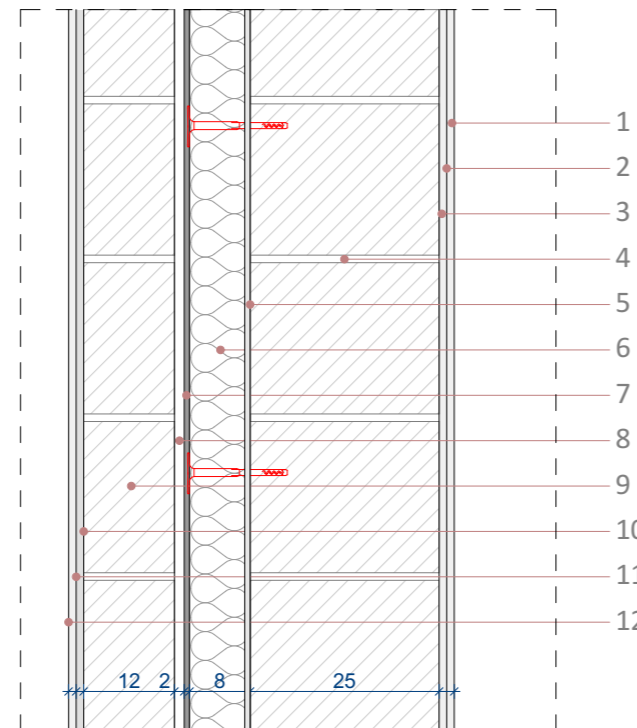

1. Suvatim antibakteriale
2. Shtresë bazë+Rrjetë
3. Llaç çimentoje
4. Bllok argjile 250mm
5. Ngjitës
6. Lesh guri-Izolim termik 80mm
7. Folie Difusive
8. Hapësirë ajri 20mm
9. Bllok argjile 120mm
10. Llaç çimentoje
11. Ngjitës+Rrjetë
12. Shtresë bazë+Fasadë

EW-02 Detali i murit

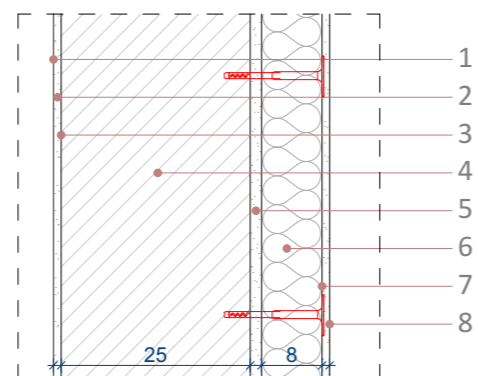

1. Suvatim
2. Shtresë bazë+Rrjetë
3. Llaç çimentoje
4. Bllok argjile 250mm
5. Shtresë bazë+Ngjitës
6. Lesh guri-Izolim termik 80mm
7. Ngjitës+Rrjetë
8. Shtresë bazë+Fasadë

NOTES:

LEGEND:

Implementuar nga:



Konsulent:



Projekti: OFRIMI I SHERBIMEVE PROFESIONALE - SHERBIME KONSULENCE PER PROJEKTIN E EMERGJENCES NE SHQIPERI COVID 19 (LOT2)

NDERTIMI I LABORATORIT TE RI - TIRANE, SHQIPERI

Titulli i vizatimit:

Detajet e mureve EW-01, EW-02

Perpjesa:	Vizatuar nga:	Kontrolloi:	Data:
1:10	A.K; R.T; D.M; A.G	O.Z	Mar. 2023

Nr. i vizatimit: A.41

Vendi:	Faza e projektit:	Nr.serik:	Rev.:
Shqiperi	Projekti kryesor	A.41	R.05

FORMATI I FLETES : A3

IW-01 Detal i murit

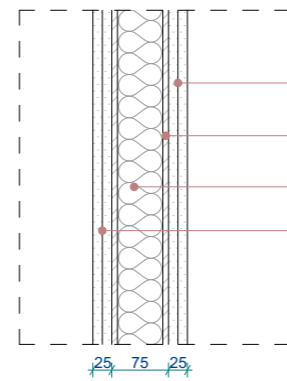

1. Gipsplakë e dyfishtë 2x12.5 mm
2. Profili CW 75 mm
3. Izolim i murit - Lesh Guri 60 mm
4. Gipsplakë 2x12.5 mm

iW-01
Detali i murit CW 75

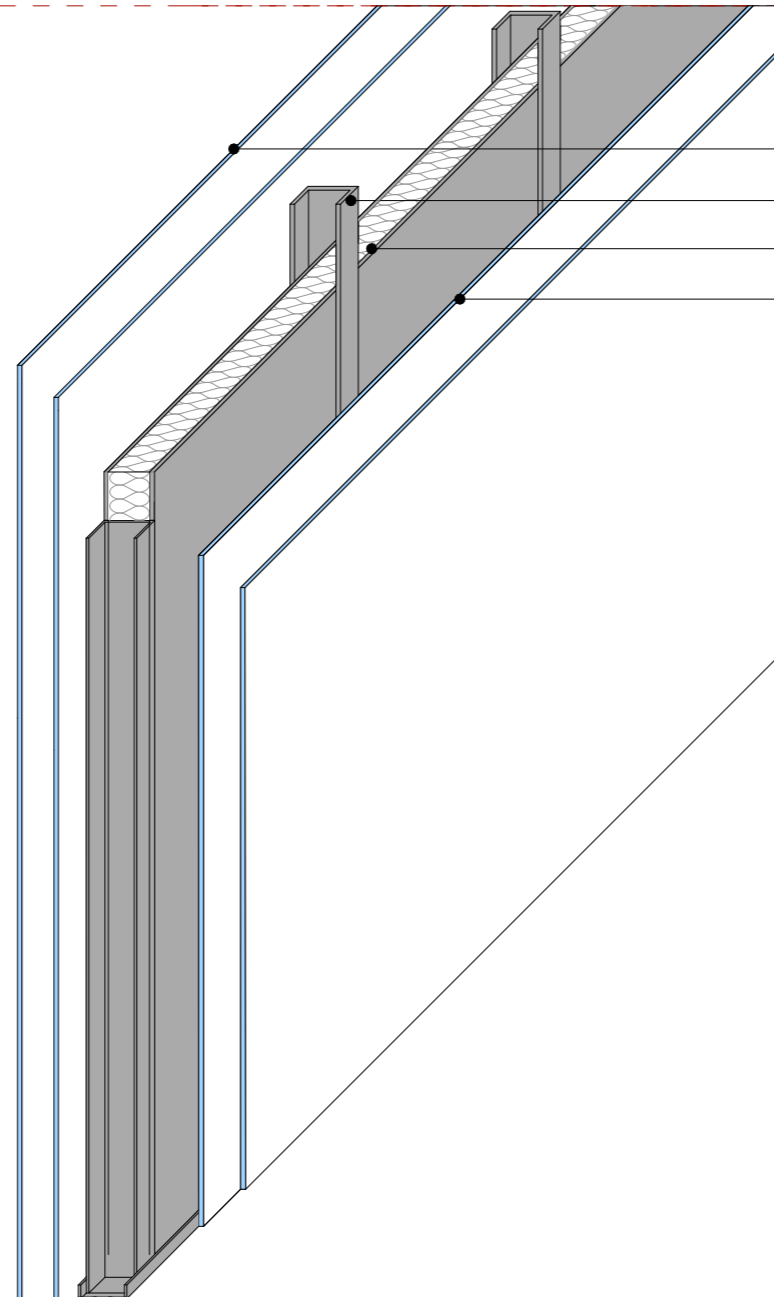

- 1 - Panele të thata me fibra 2x12.5mm
- 2 - Profil metalik
- 3 - Izolim termik - Lesh Guri 60mm
- 4 - Panele të thata me fibra 2x12.5mm

NOTES:

LEGEND:

Implementuar nga:



Konsulent:



Projekti: OFRIMI I SHERBIMEVE PROFESIONALE - SHERBIME KONSULENCE PER PROJEKTIN E EMERGJENCES NE SHQIPERI COVID 19 (LOT2)

NDERTIMI I LABORATORIT TE RI - TIRANE, SHQIPERI

Titulli i vizatimit:

Detali i Murit te brendshem IW-01

Perpjesa:	Vizatuar nga:	Kontrolloi:	Data:
1:10	A.K; R.T; D.M; A.G	O.Z	Mar. 2023

Nr. i vizatimit: A.42

Vendi:	Faza e projektit:	Nr.serik:	Rev.:
Shqiperi	Projekti kryesor	A.42	R.05

FORMATI I FLETES : A3

IW-03 Detal i murit

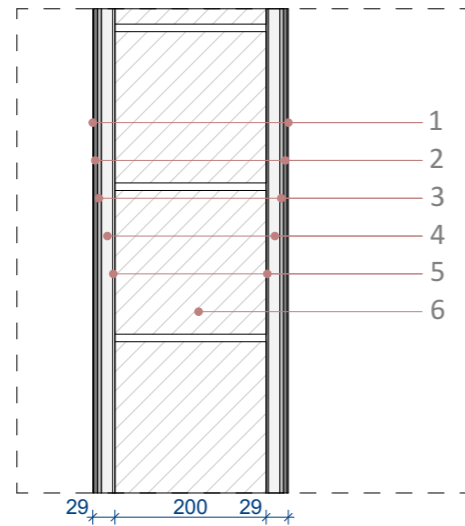

1. Ngjyrë antibakteriale
2. Suva gjipsi 3mm
3. Ngjitës + Rrjetë
4. Suvatim 15mm
5. Shtresë bazë
6. Bllok Argjile 200mm

IW-04 Detal i murit

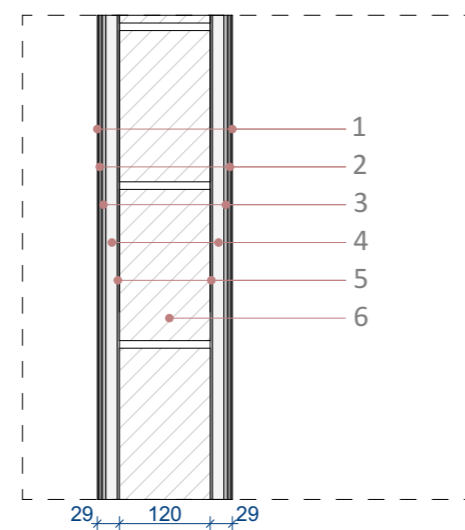

1. Ngjyrë antibakteriale
2. Suva gjipsi 3mm
3. Ngjitës + Rrjetë
4. Suvatim 15mm
5. Shtresë bazë
6. Bllok Argjile 120mm

NOTES:

LEGEND:

Implementuar nga:



Konsulent:



Projekti: OFRIMI I SHERBIMEVE PROFESIONALE - SHERBIME KONSULENCE PER PROJEKTIN E EMERGJENCES NE SHQIPERI COVID 19 (LOT2)

NDERTIMI I LABORATORIT TE RI - TIRANE, SHQIPERI

Titulli i vizatimit:

Muret e brendsheme IW-03, IW-04

Perpjesa:	Vizuar nga:	Kontrolloi:	Data:
1:10	A.K; R.T; D.M; A.G	O.Z	Mar. 2023

Nr. i vizatimit: A.42.1

Vendi:	Faza e projektit:	Nr.serik:	Rev.:
Shqiperi	Projekti kryesor	A.42.1	R.05

FORMATI I FLETES : A3

IW-05 Detal i murit

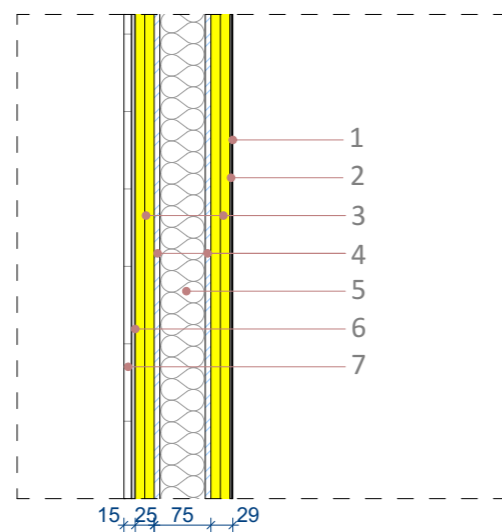

1. Ngjyrë antibakteriale
2. Suva gjipsi 3mm
3. Gipsplakë 2x12.5 mm
Rezistent ndaj lagështisë
4. Profili CW 75 mm
5. Lesh Guri 60mm
6. Ngjitës i pllakës
7. Pllaka Qeramike

Vërejtje:
Ky lloj i murit është i veshur me pllaka qeramike ose me gipsplaka në varësi nga hapësirat që i ndan.

IW-06 Detal i murit

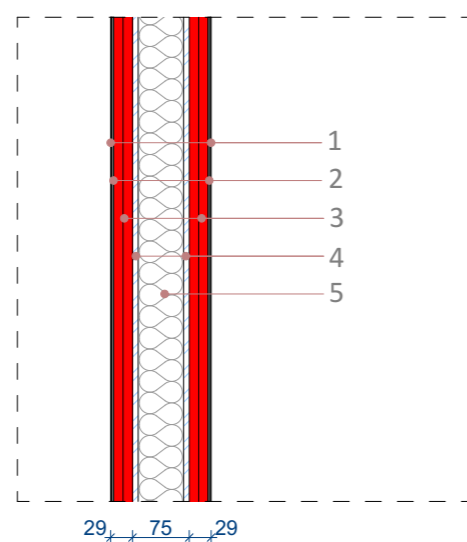

1. Ngjyrë antibakteriale
2. Suva gjipsi 3mm
3. Gipsplaka 2x12.5 mm
Rezistent ndaj zjarrit 120min
4. Profili CW 75 mm
5. Lesh guri 60mm

NOTES:

LEGEND:

Implementuar nga:



Konsulent:



Projekti: OFRIMI I SHERBIMEVE PROFESIONALE - SHERBIME KONSULENCE PER PROJEKTIN E EMERGJENCES NE SHQIPERI COVID 19 (LOT2)

NDERTIMI I LABORATORIT TE RI - TIRANE, SHQIPERI

Titulli i vizatimit:

Muret e brendsheme IW -05, IW -06

Perpjesa:	Vizuar nga:	Kontrolloi:	Data:
1:10	A.K; R.T; D.M; A.G	O.Z	Mar. 2023

Nr. i vizatimit: A.42.2

Vendi:	Faza e projektit:	Nr.serik:	Rev.:
Shqiperi	Projekti kryesor	A.42.2	R.05

FORMATI I FLETES : A3

IW-07 Detal i murit

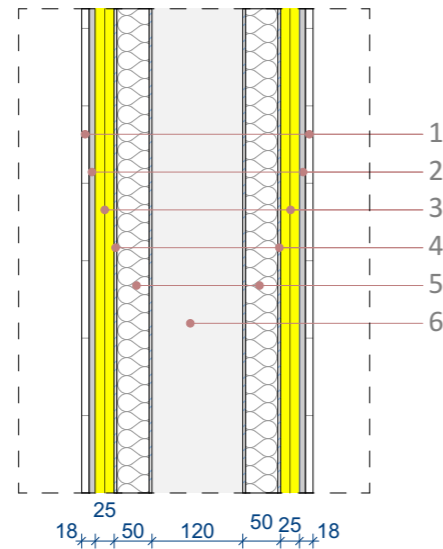

1. Pllakë Qeramike 10mm
2. Ngjitës i pllakës
3. Gipsplaka 2x12.5 mm
4. Profili CW 50 mm
5. Lesh Guri 50mm
6. Hapësirë ajri

IW-08 Detal i murit

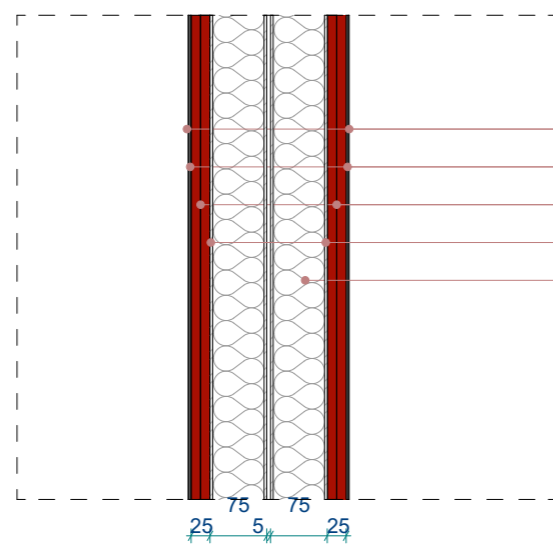

1. Ngjyrë antibakteriale
2. Suva gjipsi 3mm
3. Gipsplaka 2x12.5 mm
4. CW 75 mm
5. Izolim i murit - Lesh Guri 60 mm

NOTES:

LEGEND:

Implementuar nga:



Konsulent:



Projekti: OFRIMI I SHERBIMEVE PROFESIONALE - SHERBIME KONSULENCE PER PROJEKTIN E EMERGJENCES NE SHQIPERI COVID 19 (LOT2)

NDERTIMI I LABORATORIT TE RI - TIRANE, SHQIPERI

Titulli i vizatimit:

Muret e brendshme IW-07, IW-08

Perpjesa:	Vizuar nga:	Kontrolloi:	Data:
1:10	A.K; R.T; D.M; A.G	O.Z	Mar. 2023

Nr. i vizatimit: A.42.3

Vendi:	Faza e projektit:	Nr.serik:	Rev.:
Shqiperi	Projekti kryesor	A.42.3	R.05

FORMATI I FLETES : A3

IW-02 Detali i murit

Muri ndarës i dyfishtë

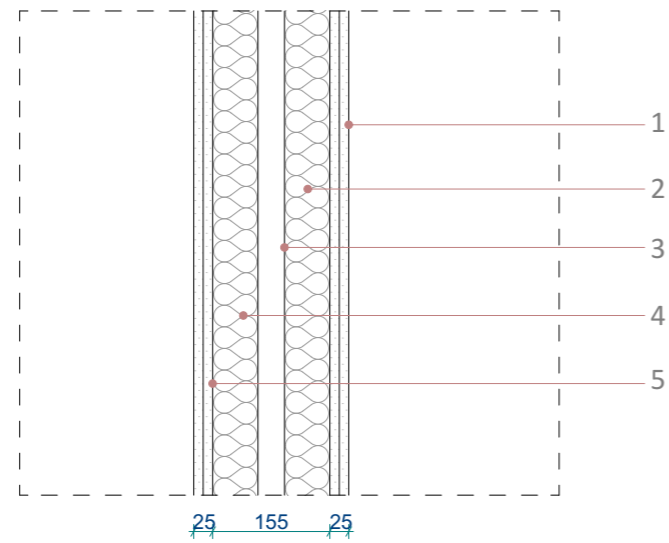

1. Gipsplaka 2x12.5 mm
2. Izolim muri - Lesh Guri 60 mm
3. CW 75 mm
4. Izolim muri - Lesh Guri 60 mm
5. Gipsplaka 2x12.5 mm

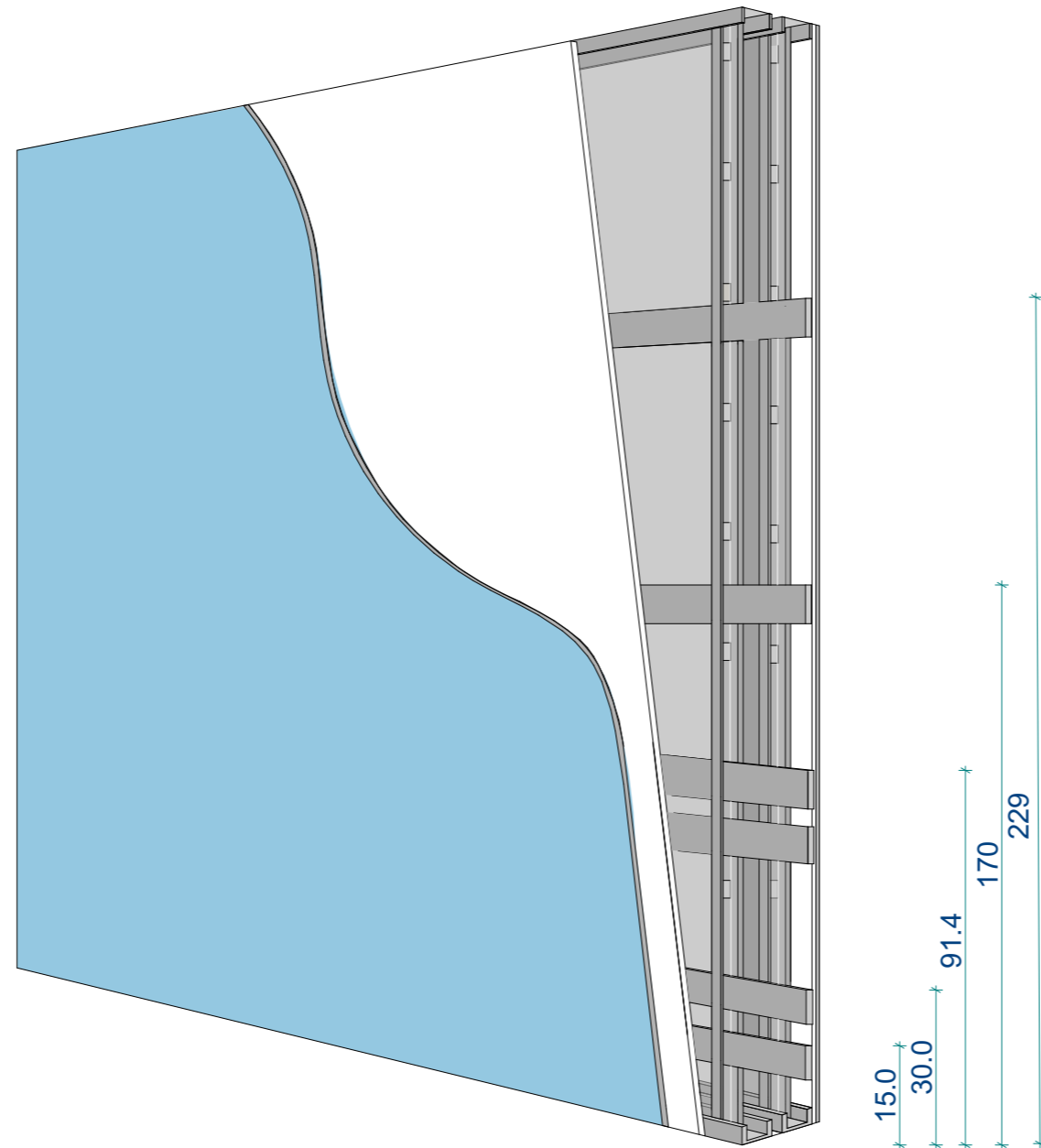

NOTES:

LEGEND:

Implementuar nga:



Konsulent:



Projekti: OFRIMI I SHERBIMEVE PROFESIONALE - SHERBIME KONSULENCE PER PROJEKTIN E EMERGJENCES NE SHQIPERI COVID 19 (LOT2)

NDERTIMI I LABORATORIT TE RI - TIRANE, SHQIPERI

Titulli i vizatimit:

Muret e brendshme IW-02

Perpjesa: Vizatuar nga:

1:10 A.K; R.T; D.M; A.G

Kontrolloi: Data:

O.Z Mar. 2023

Nr. i vizatimit: A.43

Vendi: Shqiperi
Faza e projektit: Projekti kryesor

Nr.serik: A.43

Rev.: R.05

FORMATI I FLETES : A3

VT-01 Detali i fasadës ventiluese

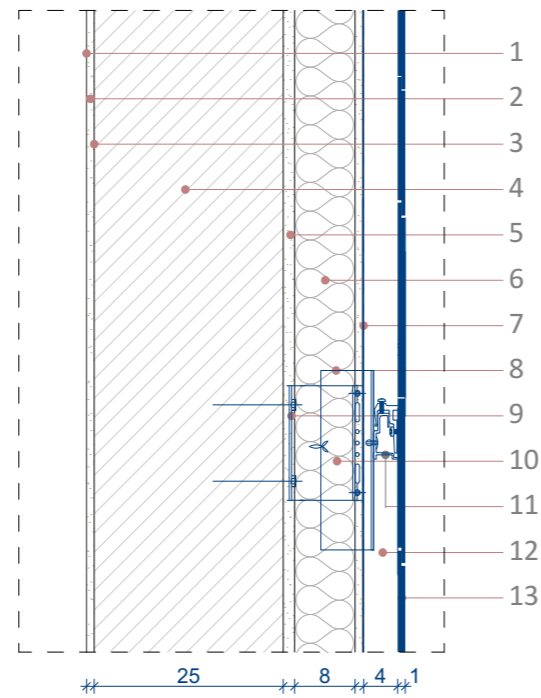

- 1.Suvatim
- 2.Shtresë bazë+Rrjetë
- 3.Llaç çimentoje
- 4.Bllok Argjile 250mm
- 5.Shtresë bazë+Ngjitës
- 6.Lesh Guri-Izolim termik 80mm
- 7.Folie Difusive
- 8.Kllapa të murit nga alumini
- 9.Kllapa varëse
- 10.Profil alumini vertikal
- 11.Profil alumini horizontal
- 12.Hapësirë ajri
- 13.Fasadë me pllaka qeramike (ventiluese)

VT-01 Detali i fasadës ventiluese

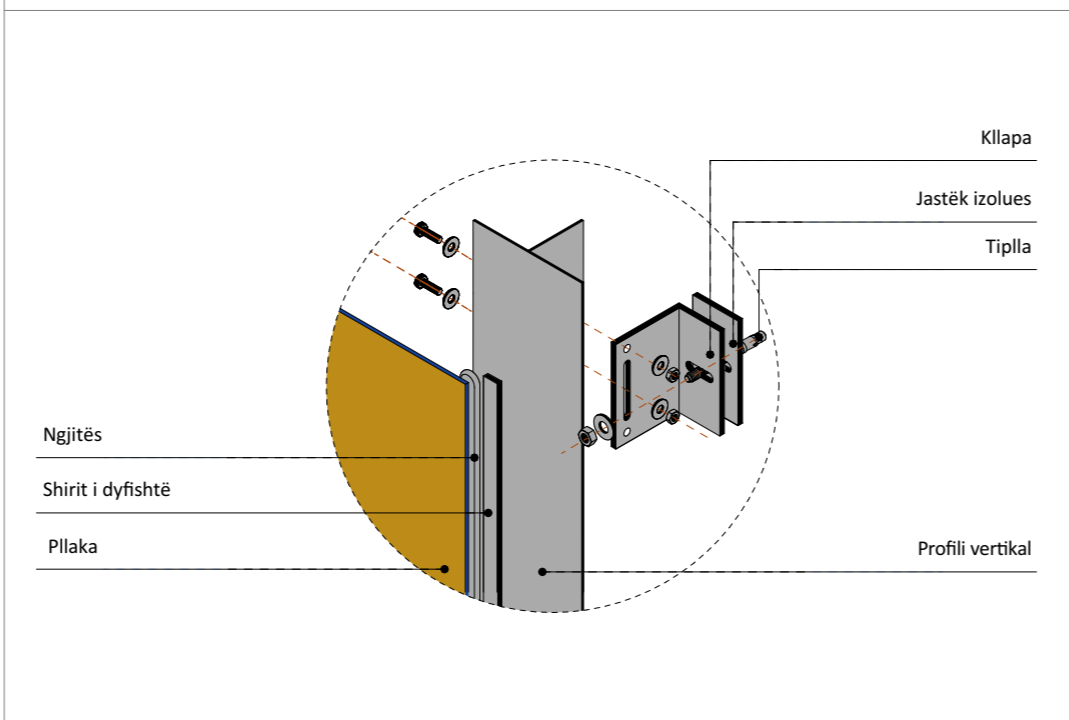

NOTES:

LEGEND:

Implementuar nga:



Konsulent:



Projekti: OFRIMI I SHERBIMEVE PROFESIONALE - SHERBIME KONSULENCE PER PROJEKTIN E EMERGJENCES NE SHQIPERI COVID 19 (LOT2)

NDERTIMI I LABORATORIT TE RI - TIRANE, SHQIPERI

Titulli i vizatimit:

Detaji i fasades ventiluese VT-01

Perpjesa: 1:20 1:10	Vizatuar nga: A.K; R.T; D.M; A.G	Kontrolloi: O.Z	Data: Mar. 2023
---------------------------	-------------------------------------	--------------------	--------------------

Nr. i vizatimit: A.44

Vendi: Shqiperi	Faza e projektit: Projekti kryesor	Nr.serik: A.44	Rev.: R.05
--------------------	---------------------------------------	-------------------	---------------

FORMATI I FLETES : A3

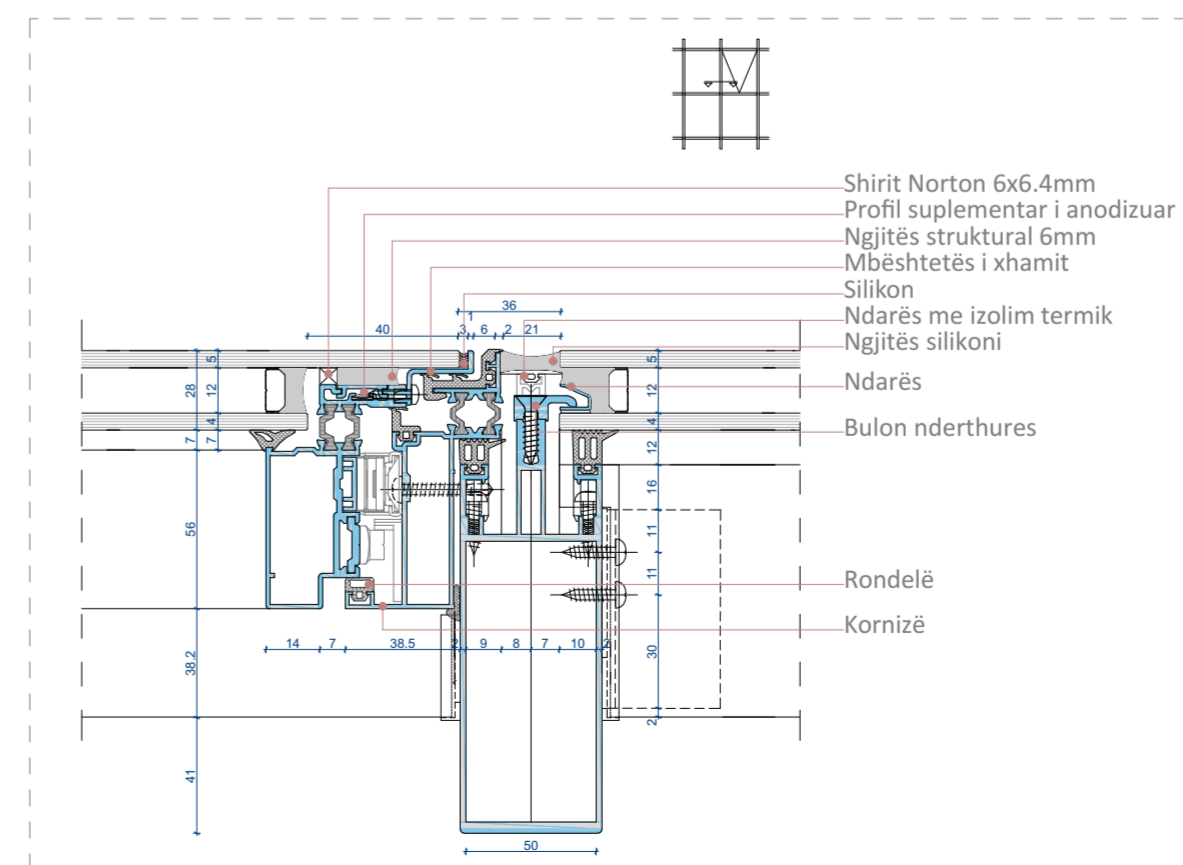
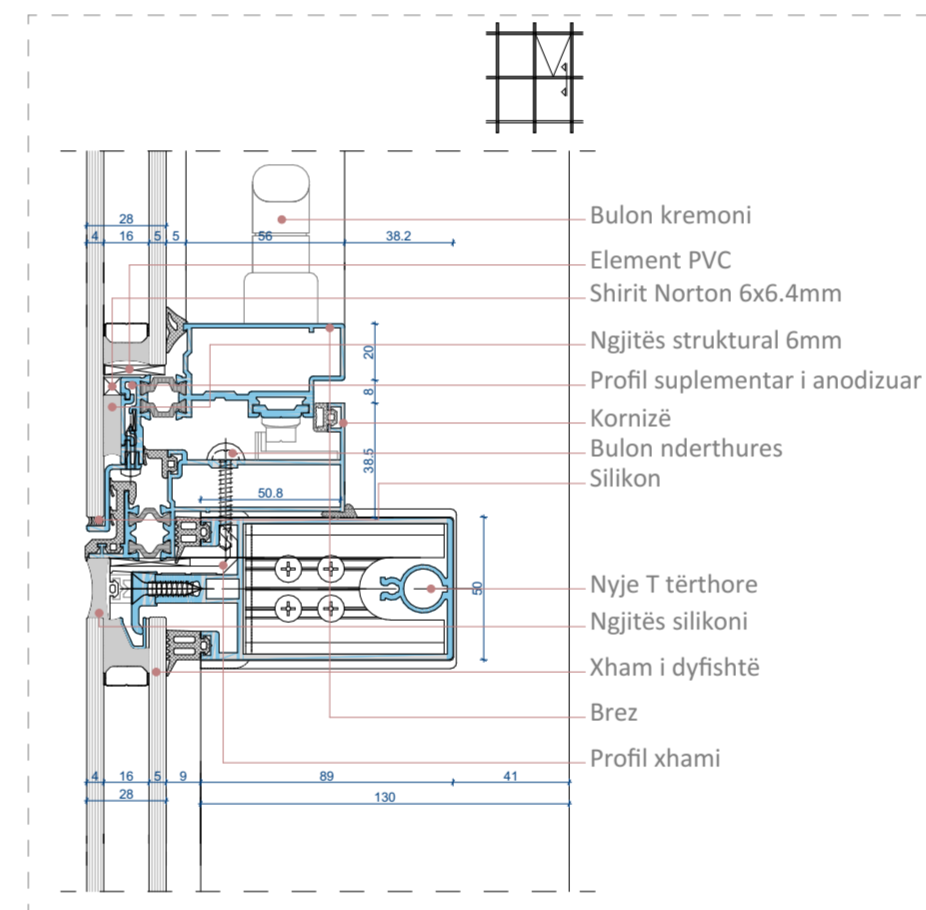
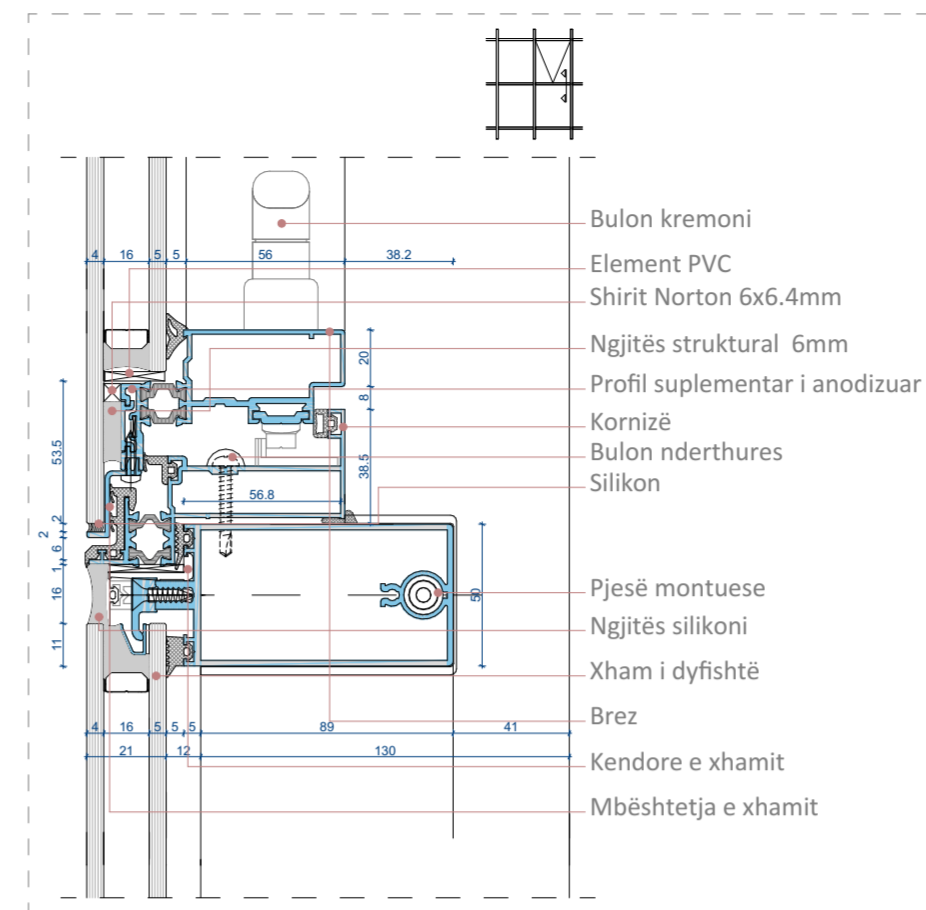
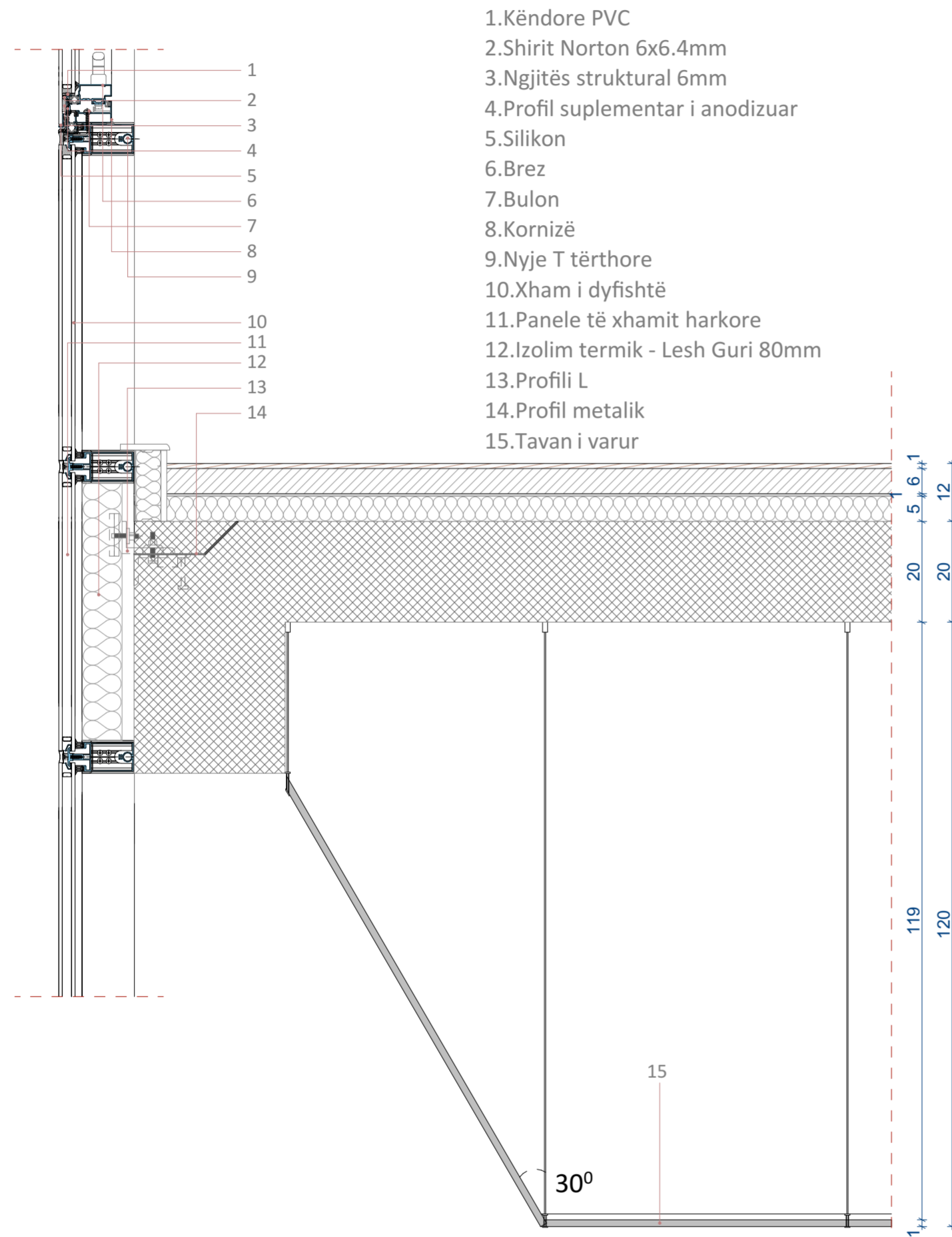

SHENIME:

LEGIENDA:



Projekti: OFRIMI I SHERBIMEVE PROFESIONALE - SHERBIME KONSULENCE PER PROJEKTIN E EMERGENCES NE SHQIPERI COVID 19 (LOT2)
 NDERTIMI I LABORATORIT TE RI - TIRANE, SHQIPERI

Titulli i vizatimit:
Fasada strukturale & Detaji i pllafonit ST-01

Skala: 1:20
 Vizuar nga: A.K; R.T; D.M; A.G
 Kontrolluar nga: O.Z
 Data: Mar. 2023

Nr. i vizatimit: **A.45**
 Vendi: Shqiperi
 Faza e projektit: Projekti kryesor
 Nr.serik: A.45
 Rev.: R.05

FORMATI I FLETES : A2