



RRUGA E VARREZAVE TE VJETRA





		Emertimi i Projektit:		Emertimi i Fletes:		Projektoi: "XH & MILLER" SHPK		Kapitulli:	Projekt Zbatimi
		Rikonstruksioni dhe rehabilitimi i rrugëve te varrezave te vjetra, lagjia Kaluç dhe pallati katerkatesh		<i>Planvendosje rruga lagjia "Kalluç"</i>		ADM: XHULJETA DURO		Nr. Fletes:	A - 21
Faza	Projekt Zbatimi	Shkalla:	1 : 1000				Data:	Janar 2023	

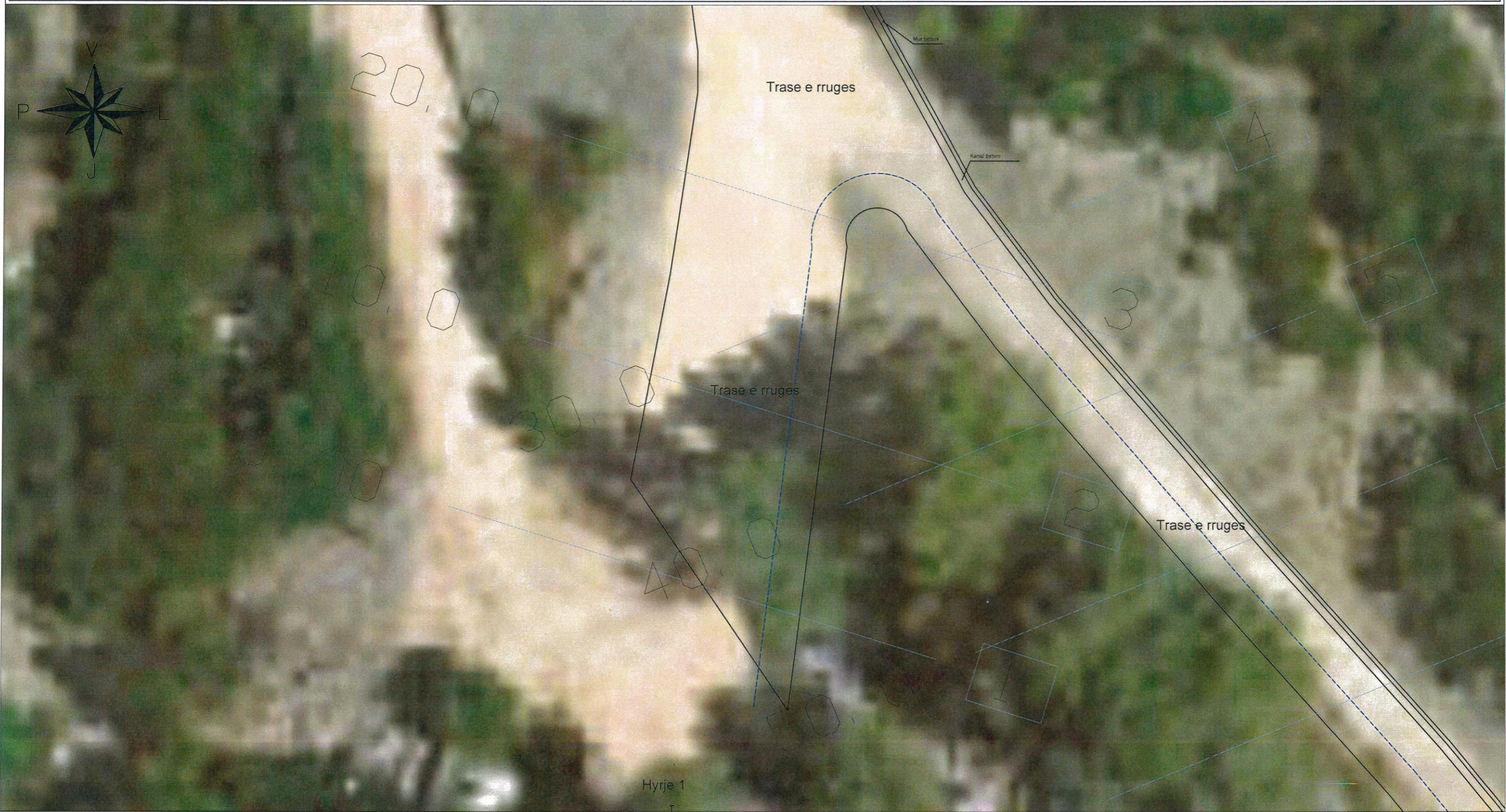

RRUGA E VARREZAVE TE VJETRA





		Emertimi i Projektit:		Emertimi i Fletes:		Projektoi:		Kapitulli:	Projekt Zbatimi
		Rikonstruksioni dhe rehabilitimi i rrugëve te varrezave te vjetra, lagjia Kaluç dhe pallati katerkatesh		Planvendosje rruga lagjia "Kaluç"		"XH & MILLER" SHPK		Nr. Fletes:	A - 21-1
Faza	Projekt Zbatimi	Shkalla:	1 : 200	ADM: XHULJETA DURO		Data:		Janar 2023	



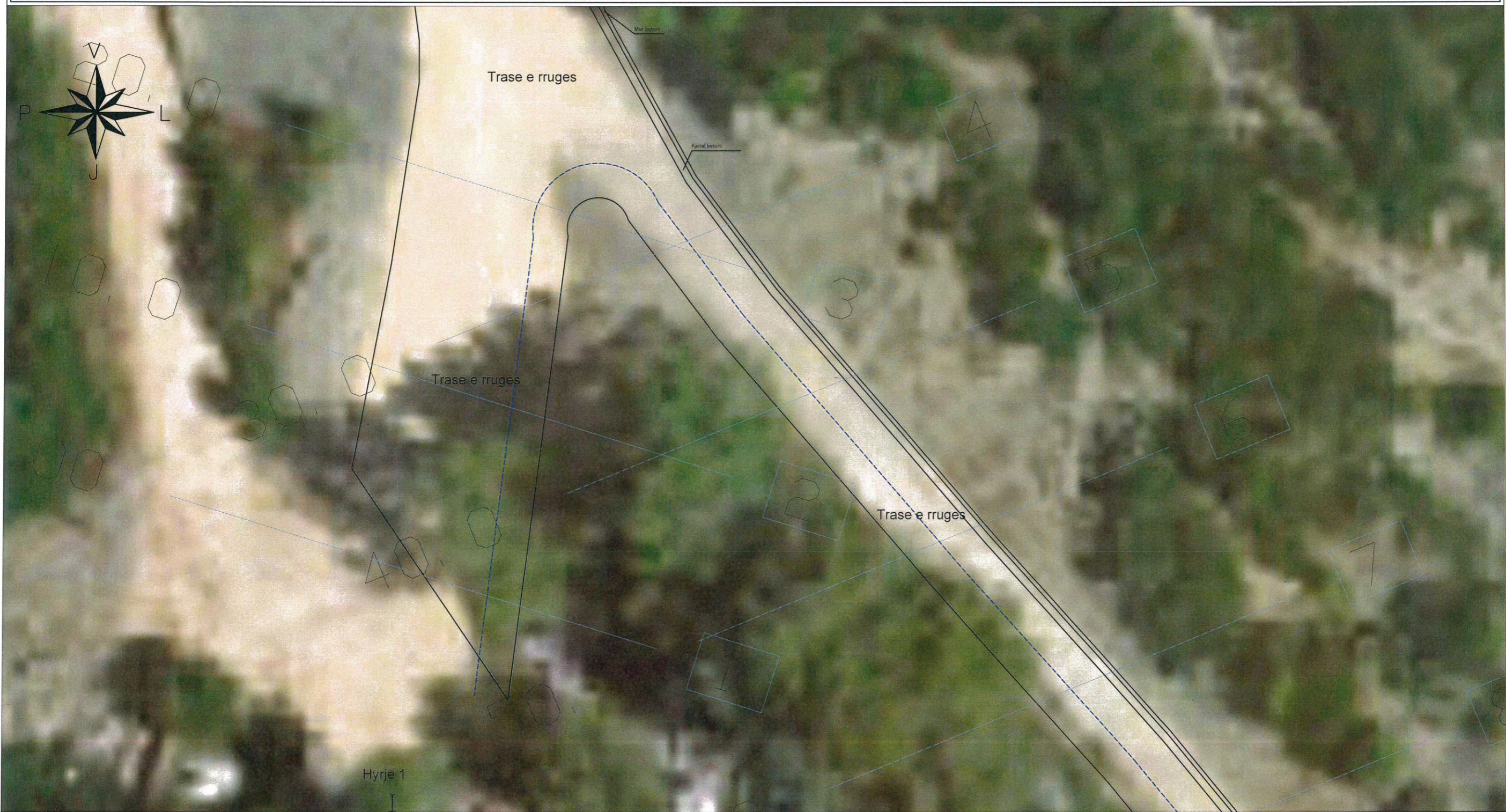



RRUGA E VARREZAVE TE VJETRA

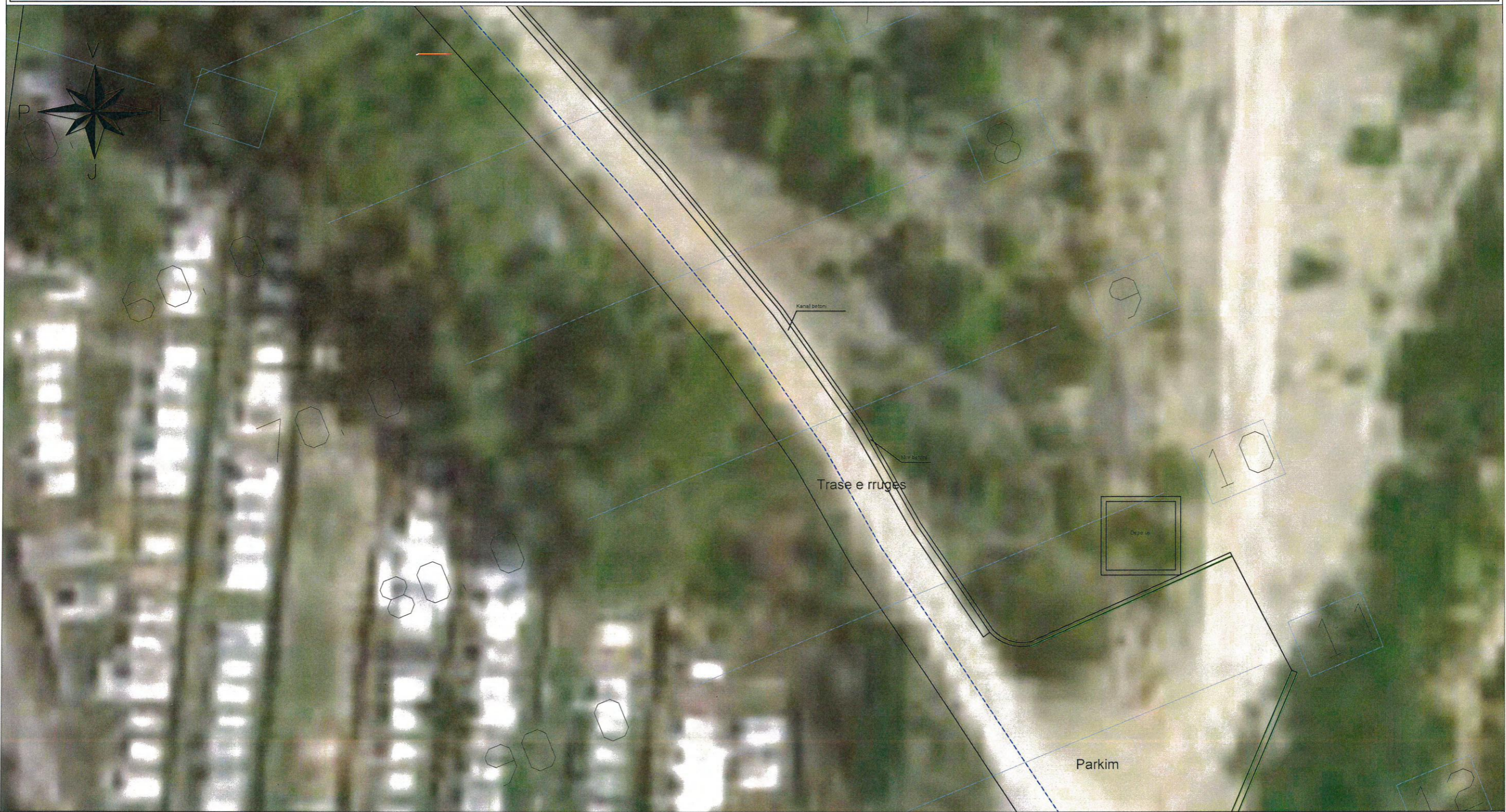

		Emertimi i Projektit:		Emertimi i Fletes:		Projektoi: "XH & MILLER" SHPK ADM. XHULJETA DURO 	Kapitulli:	Projekt Zbatimi
		Rikonstruksioni dhe rehabilitimi i rrugëve te varrezave te vjetra, lagjia Kaluç dhe pallati katerkatësh		Planvendosje rruga lagjia "Kaluç"			Nr. Fletes:	A - 21-2
		Faza	Projekt Zbatimi	Shkalla:	1 : 200		Data:	Janar 2023



RRUGA E VARREZAVE TE VJETRA



		Emertimi i Projektit:		Emertimi i Fletes:		Projektoi: "XH & MILLER" SHPK ADM: XHULJETA DURO 	Kapitulli:	Projekt Zbatimi
		Rikonstruksioni dhe rehabilitimi i rrugeve te varrezave te vjetra, lagjia Kaluç dhe pallati katerkatësh		Planvendosje rruga lagjia "Kaluç"			Nr. Fletes:	A - 21-3
Faza	Projekt Zbatimi	Shkalla:	1 : 200	Data:	Janar 2023			

RRUGA E VARREZAVE TE VJETRA



		Emertimi i Projektit:		Emertimi i Fletes:		Projekttoi:		Kapitulli:	Projekt Zbatimi
		Rikonstruksioni dhe rehabilitimi i rrugeve te varrezave te vjetra, lagjia Kaluç dhe pallati katerkatesh		Planvendosje rruga lagjia "Kaluç"		"XH & MILLER" SHPK		Nr. Fletes:	A - 21-4
Faza	Projekt Zbatimi	Shkalla:	1 : 200	ADM: XHULJETA DURO				Data:	Janar 2023

RRUGA E VARREZAVE TE VJETRA

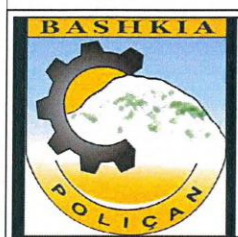
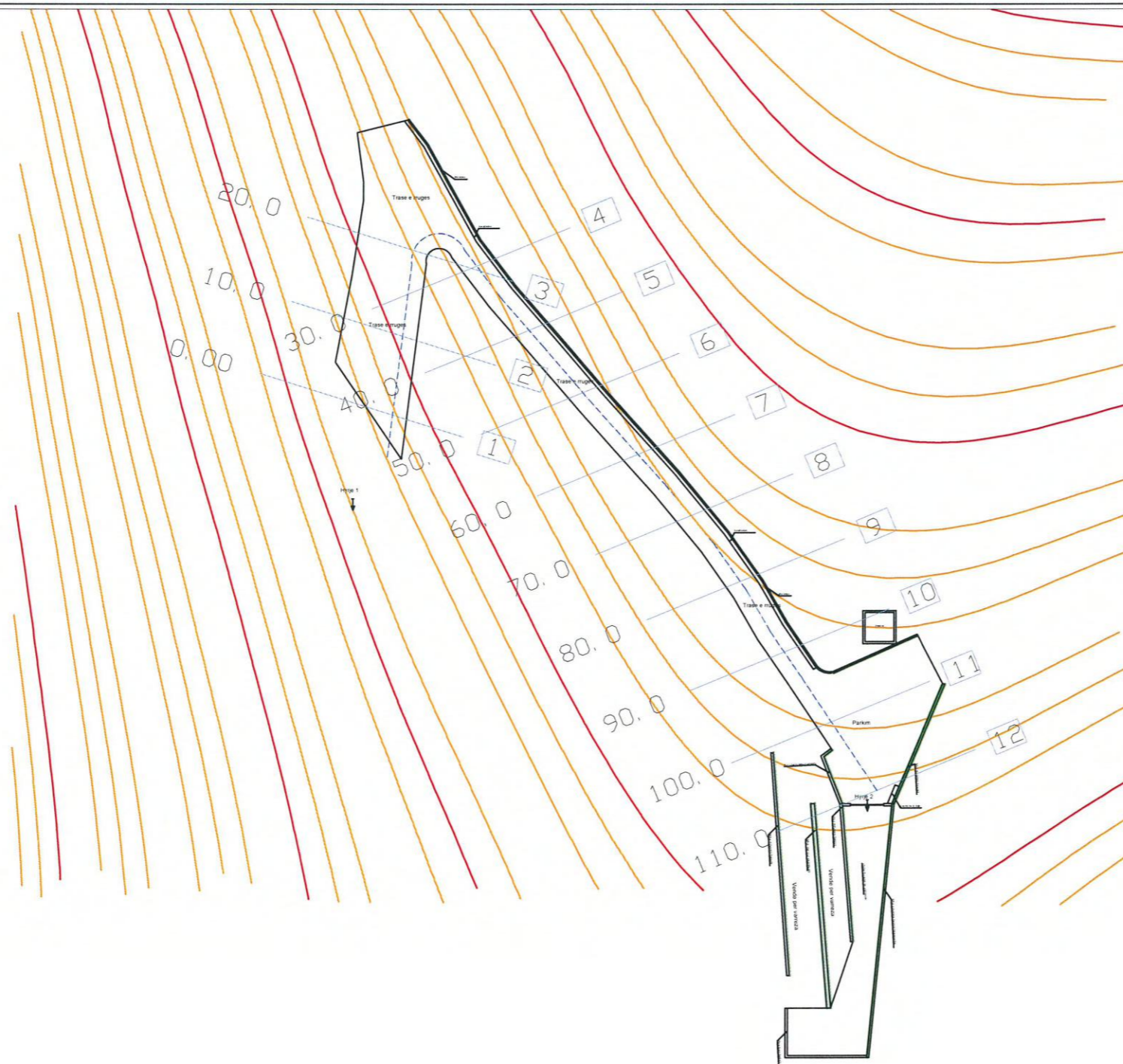
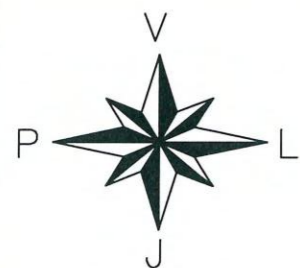

Emertimi i Projektit:	
Rikonstruksioni dhe rehabilitimi i rrugëve te varrezave te vjetra, lagjia Kaluç dhe pallati katerkatesh	
Faza	Projekt Zbatimi

Emertimi i Fletes:	
Planvendosje rruga lagjia "Kaluç"	
Shkalla:	1 : 1000

Projekttoi:	"XH & MILLER" SHPK
ADM:	XHULJETA DURO



Kapitulli:	Projekt Zbatimi
Nr. Fletes:	A - 22
Data:	Janar 2023

RRUGA E VARREZAVE TE VJETRA

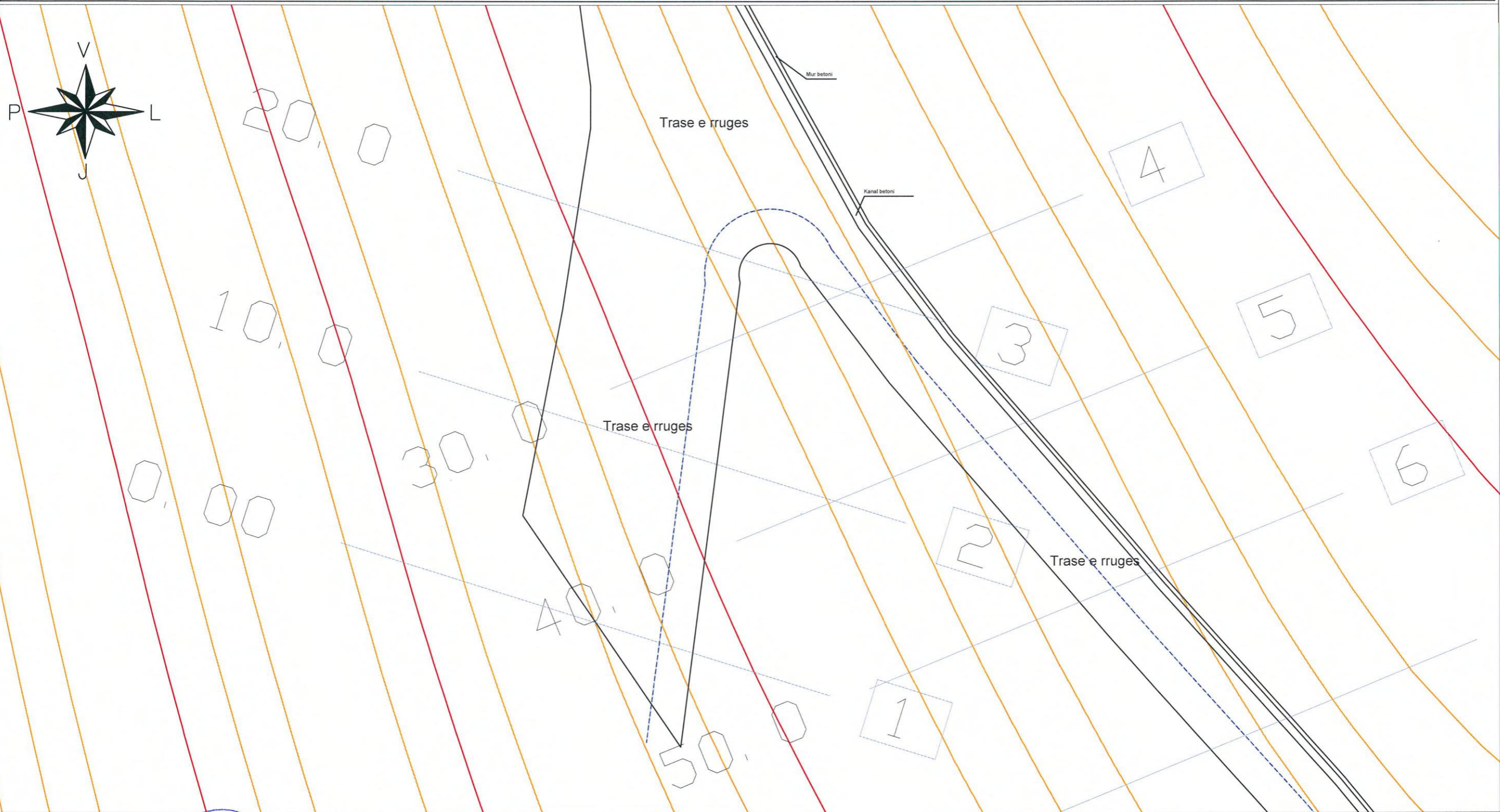

Emertimi i Projektit:	
Rikonstruksioni dhe rehabilitimi i rrugëve te varrezave te vjetra, lagjia Kaluç dhe pallati katerkatesh	
Faza	Projekt Zbatimi

Emertimi i Fletes:	
Planvendosje rruga lagjia "Kaluç"	
Shkalla:	1 : 200



Projekttoi:	"XH & MILLER" SHPK
ADM:	XHULJETA DURO



Kapitulli:	Projekt Zbatimi
Nr. Fletes:	A - 22-1
Data:	Janar 2023

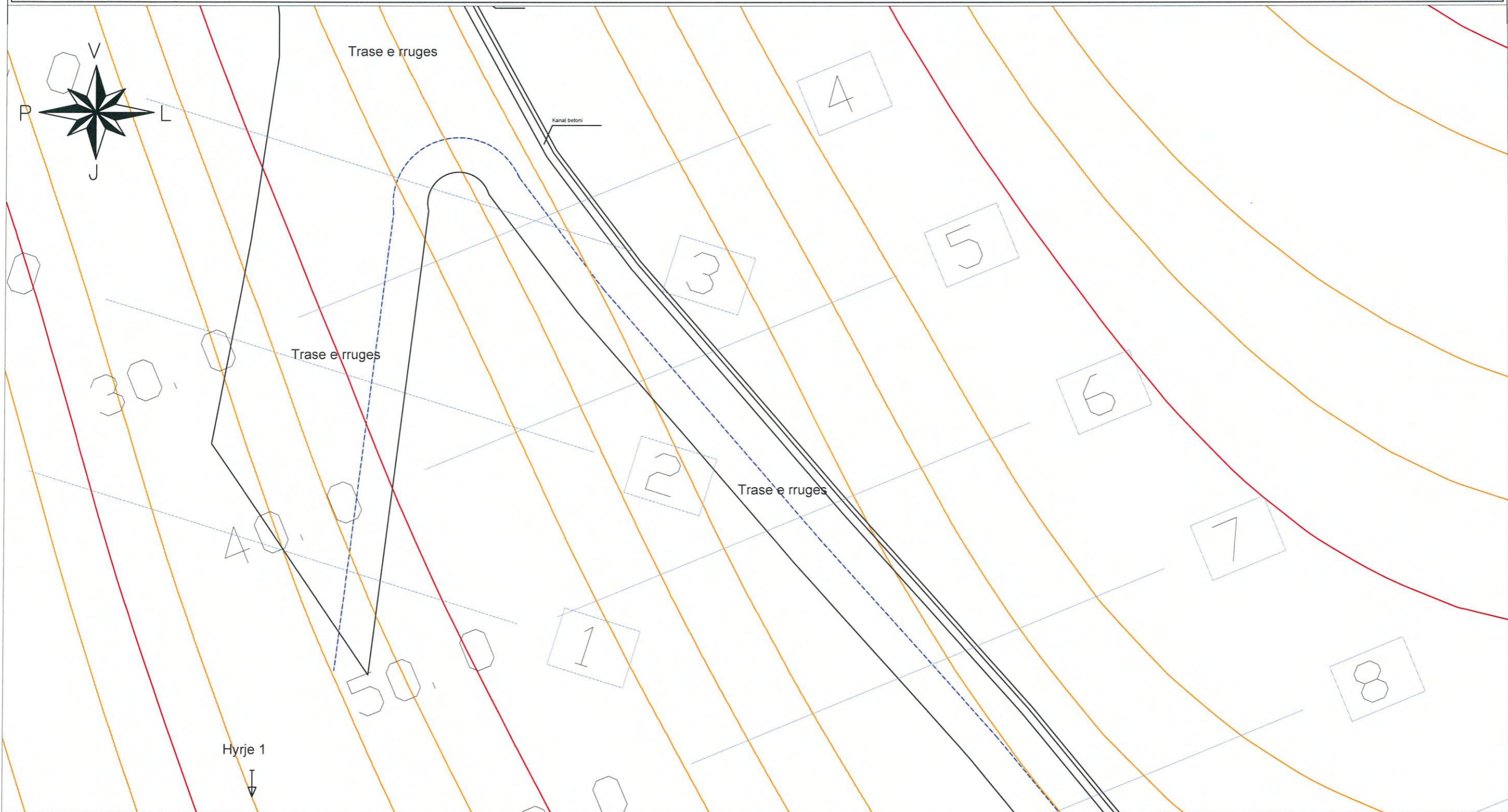

RRUGA E VARREZAVE TE VJETRA

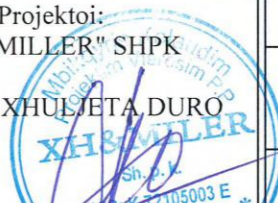

		Emertimi i Projektit:		Emertimi i Fletes:		Projektoi: "XH & MILLER" SHPK ADM: XHULJETA DURO 	Kapitulli:	Projekt Zbatimi
		Rikonstruksioni dhe rehabilitimi i rrugeve te varrezave te vjetra, lagjia Kaluç dhe pallati katerkatesh		Planvendosje rruga lagjia "Kaluç"			Nr. Fletes:	A - 22-2
Faza	Projekt Zbatimi	Shkalla:	1 : 200	Data:	Janar 2023			

RRUGA E VARREZAVE TE VJETRA

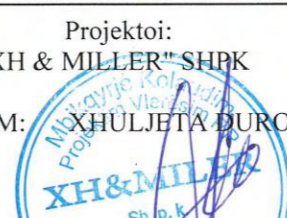

		Emertimi i Projektit:		Emertimi i Fletes:		Projektoi: "XH & MILLER" SHPK ADM: XHËLJETA DËURO 	Kapitulli:	Projekt Zbatimi
		Rikonstruksioni dhe rehabilitimi i rrugeve te varrezave te vjetra, lagjia Kaluç dhe pallati katerkatesh		Planvendosje rruga lagjia "Kaluç"			Nr. Fletes:	A - 22-3
Faza	Projekt Zbatimi	Shkalla:	1 : 200	Data:	Janar 2023			

RRUGA E VARREZAVE TE VJETRA

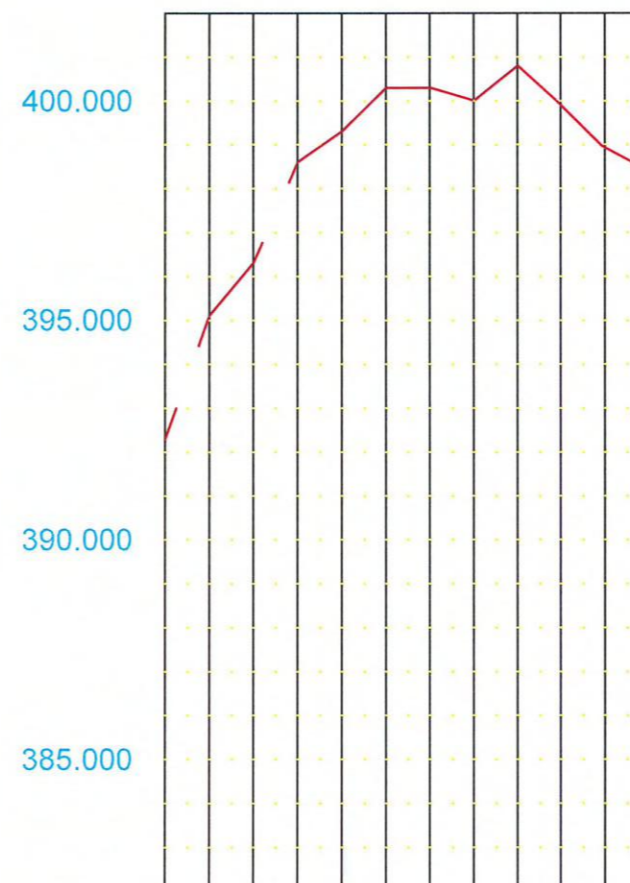
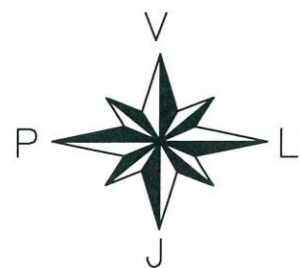

Grade Elev.	
Ground Elev.	392.300 396.300 398.600 399.300 400.300 400.300 400.000 400.800 399.900 399.800 398.400
STATION	0+00 0+020 0+030 0+040 0+050 0+060 0+070 0+080 0+090 0+100 0+110



Emertimi i Projektit:	
Rikonstruksioni dhe rehabilitimi i rrugeve te varrezave te vjetra, lagjia Kaluç dhe pallati katerkatesh	
Faza	Projekt Zbatimi

Emertimi i Fletes:	
<i>Profili Gjatesor i Rruges</i>	
Shkalla:	1 : 1000

Projekttoi:	
"XH & MILLER" SHPK	
ADM: XHULJETA DURO	



Kapitulli:	Projekt Zbatimi
Nr. Fletes:	A - 23
Data:	Janar 2023

RRUGA E VARREZAVE TE VJETRA

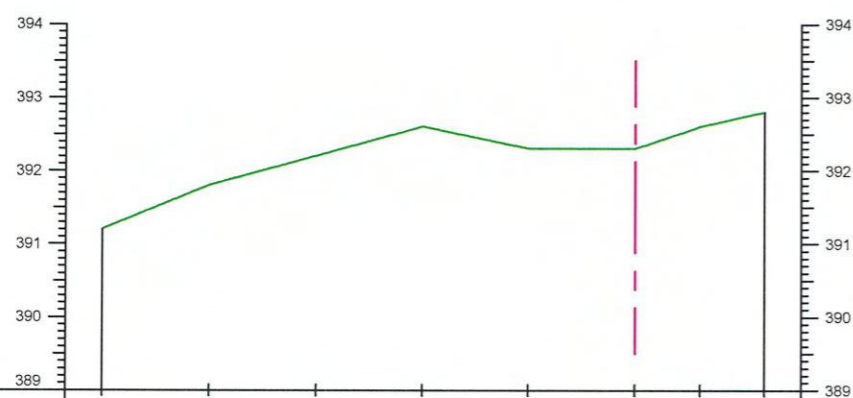
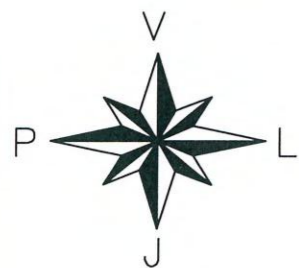

DATUM	EXISTING LEVEL (m)	DISTANCE (m)
	391.200	7.25
	391.800	5.80
	392.200	4.35
	392.600	2.90
	392.300	1.45
	392.300	0.00
	392.600	0.88
	392.800	1.75

0+000.00

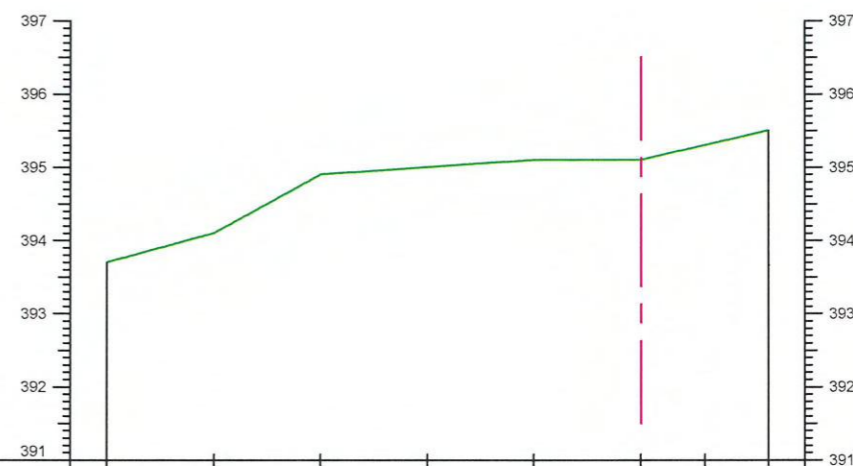

DATUM	EXISTING LEVEL (m)	DISTANCE (m)
	393.700	7.25
	394.100	5.80
	394.900	4.35
	395.000	2.90
	395.100	1.45
	395.100	0.00
	395.300	0.88
	395.500	1.75

0+010.00



Emertimi i Projektit:	
Rikonstruksioni dhe rehabilitimi i rrugeve te varrezave te vjetra, lagjia Kaluç dhe pallati katerkatesh	
Faza	Projekt Zbatimi

Emertimi i Fletes:	
<i>Profili Terthor i Rruges</i>	
Shkalla:	1 : 1000

Projekttoi:	"XH & MILLER" SHPK
ADM:	XHULJETA DURO



Kapitulli:	Projekt Zbatimi
Nr. Fletes:	A - 24
Data:	Janar 2023

RRUGA E VARREZAVE TE VJETRA

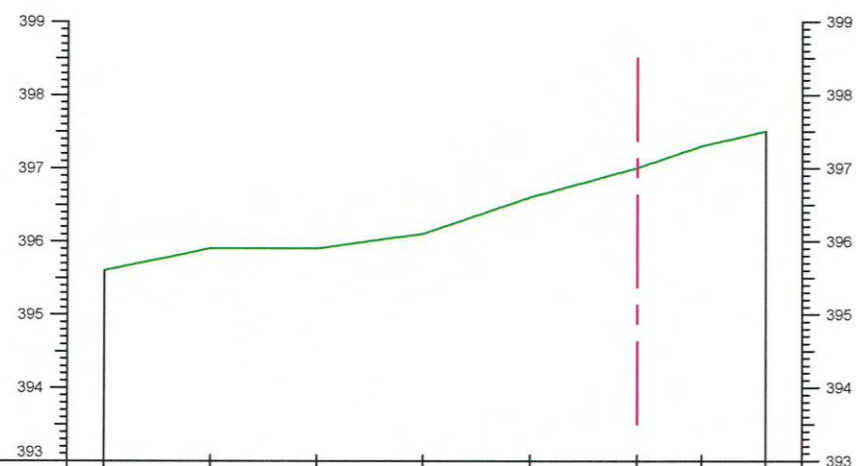
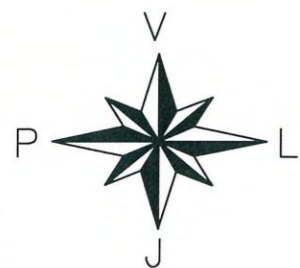

DATUM	
EXISTING LEVEL (m)	395.600 395.900 395.900 396.100 396.600 397.000 397.300 397.500
DISTANCE (m)	7.25 5.80 4.35 2.90 1.45 0.00 0.88 1.75

0+020.00

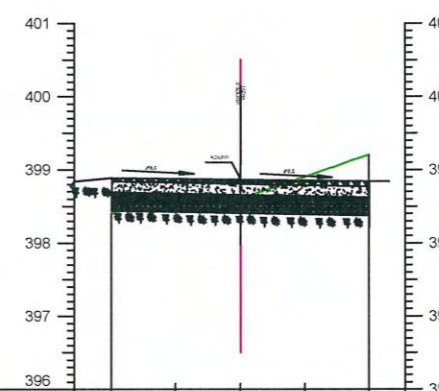

DATUM	
EXISTING LEVEL (m)	398.400 398.600 398.600 398.900 399.200
DISTANCE (m)	1.75 0.88 0.00 0.88 1.75

0+030.00



Emertimi i Projektit:	
Rikonstruksioni dhe rehabilitimi i rrugeve te varrezave te vjetra, lagjia Kaluç dhe pallati katerkatesh	
Faza	Projekt Zbatimi

Emertimi i Fletes:	
<i>Profili Terthor i Rruges</i>	
Shkalla:	1 : 1000

Projekttoi:	"XH & MILLER" SHPK
ADM:	XHULJETA DURO



Kapitulli:	Projekt Zbatimi
Nr. Fletes:	A - 25
Data:	Janar 2023

RRUGA E VARREZAVE TE VJETRA

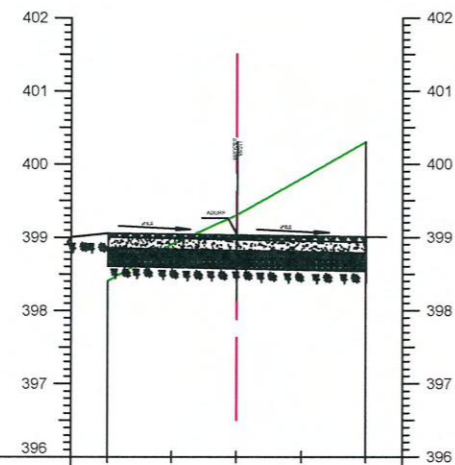
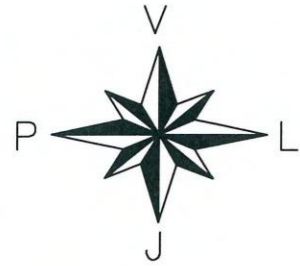

DATUM	396	397	398	399	400	401	402
EXISTING LEVEL (m)	398.400	398.900	399.300	399.800	400.300		
DISTANCE (m)	1.75	0.88	0.00	0.88	1.75		

0+040.00

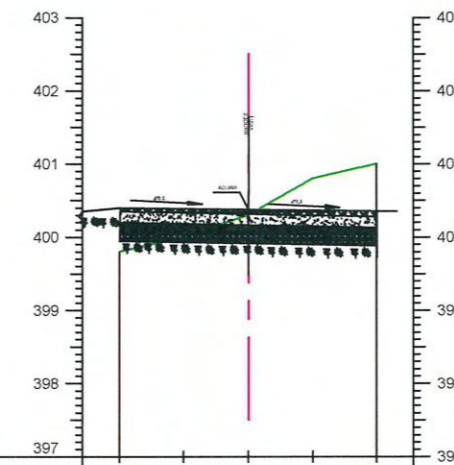

DATUM	397	398	399	400	401	402	403
EXISTING LEVEL (m)	399.800	400.000	400.300	400.800	401.000		
DISTANCE (m)	1.75	0.88	0.00	0.88	1.75		

0+050.00



Emertimi i Projektit:	
Rikonstruksioni dhe rehabilitimi i rrugeve te varrezave te vjetra, lagjia Kaluç dhe pallati katerkatesh	
Faza	Projekt Zbatimi

Emertimi i Fletes:	
<i>Profili Terthor i Rruges</i>	
Shkalla:	1 : 1000

Projekttoi:	"XH & MILLER" SHPK
ADM:	XHUMETA DURO



Kapitulli:	Projekt Zbatimi
Nr. Fletes:	A - 26
Data:	Janar 2023

RRUGA E VARREZAVE TE VJETRA

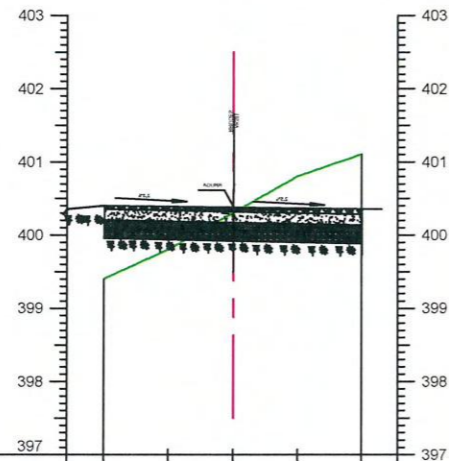
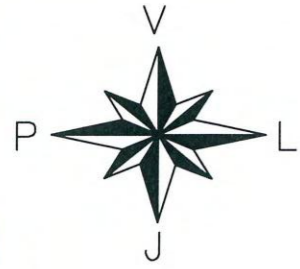

DATUM	
EXISTING LEVEL (m)	399.400 399.800 400.300 400.800 401.100
DISTANCE (m)	1.75 0.88 0.00 0.88 1.75

0+060.00

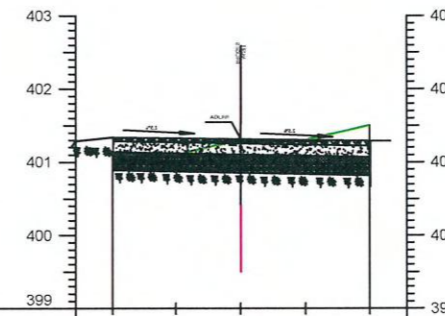

DATUM	
EXISTING LEVEL (m)	401.100 401.100 401.300 401.300 401.500
DISTANCE (m)	1.75 0.88 0.00 0.88 1.75

0+070.00



Emertimi i Projektit:	
Rikonstruksioni dhe rehabilitimi i rrugeve te varrezave te vjetra, lagjia Kaluç dhe pallati katerkatesh	
Faza	Projekt Zbatimi

Emertimi i Fletes:	
<i>Profili Terthor i Rruges</i>	
Shkalla:	1 : 1000

Projekttoi:	"XH & MILLER" SHPK
ADM:	XHULJETA DURO



Kapitulli:	Projekt Zbatimi
Nr. Fletes:	A - 27
Data:	Janar 2023

RRUGA E VARREZAVE TE VJETRA

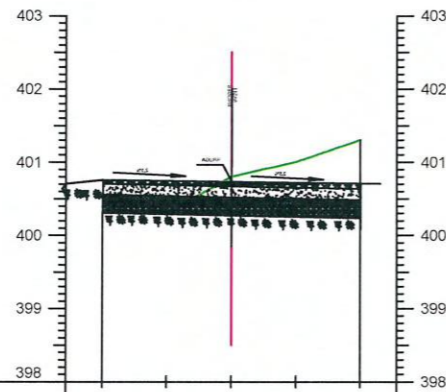
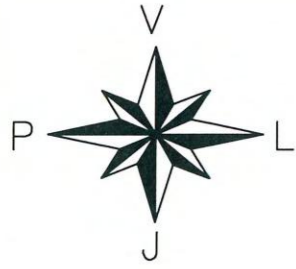

DATUM	403	402	401	400	399	398
EXISTING LEVEL (m)	400.300	400.300	400.800	401.000	401.300	
DISTANCE (m)	1.75	0.88	0.00	0.88	1.75	

0+080.00

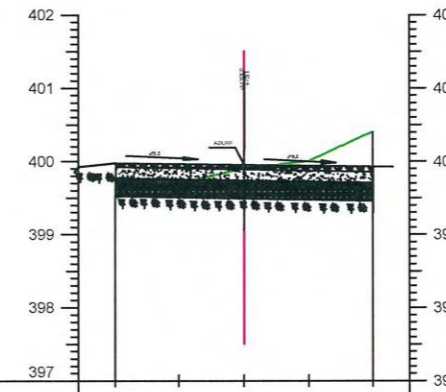

DATUM	402	401	400	399	398	397
EXISTING LEVEL (m)	399.500	399.700	399.900	400.000	400.400	
DISTANCE (m)	1.75	0.88	0.00	0.88	1.75	

0+090.00

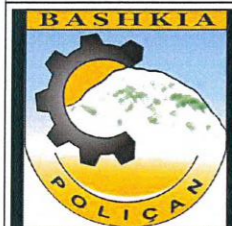

Emertimi i Projektit:	
Rikonstruksioni dhe rehabilitimi i rrugeve te varrezave te vjetra, lagjia Kaluç dhe pallati katerkatesh	
Faza	Projekt Zbatimi

Emertimi i Fletes:	
<i>Profili Terthor i Rruges</i>	
Shkalla:	1 : 1000

Projektoi:
"XH & MILLER" SHPK
ADM: XHULJETA DURQ



Kapitulli:	Projekt Zbatimi
Nr. Fletes:	A - 28
Data:	Janar 2023

RRUGA E VARREZAVE TE VJETRA

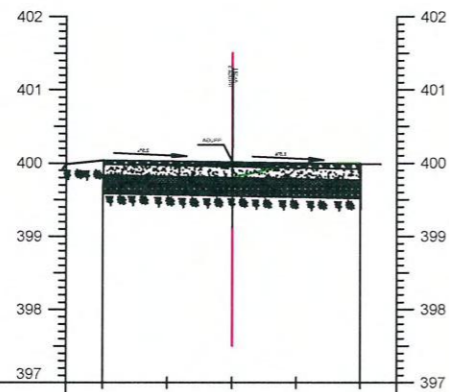
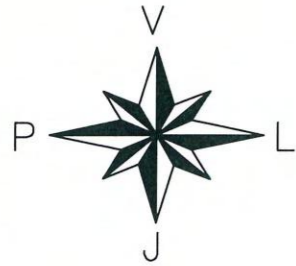

DATUM	
EXISTING LEVEL (m)	399.700 399.700 399.800 400.000 400.000
DISTANCE (m)	1.75 0.88 0.00 0.88 1.75

0+100.00

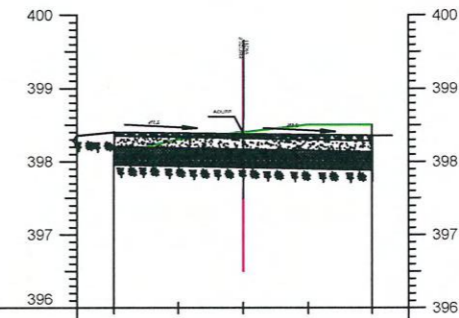

DATUM	
EXISTING LEVEL (m)	398.100 398.300 398.400 398.500 398.500
DISTANCE (m)	1.75 0.88 0.00 0.88 1.75

0+110.00



REPUBLIKA E SHQIPËRISË
BASHKIA E POLIÇAN



Emertimi i Projektit:

Rikonstruksioni dhe rehabilitimi i rrugeve te varrezave te vjetra, lagjia Kaluç dhe pallati katerkatesh

Faza

Projekt Zbatimi

Emertimi i Fletes:

Profili Terthor i Rruges

Shkalla:

1 : 1000

Projektoi:
"XH & MILLER" SHPK
ADM: XHULJETA DËURO



Kapitulli:

Projekt Zbatimi

Nr. Fletes:

A - 29

Data:

Janar 2023

RRUGA E VARREZAVE TE VJETRA

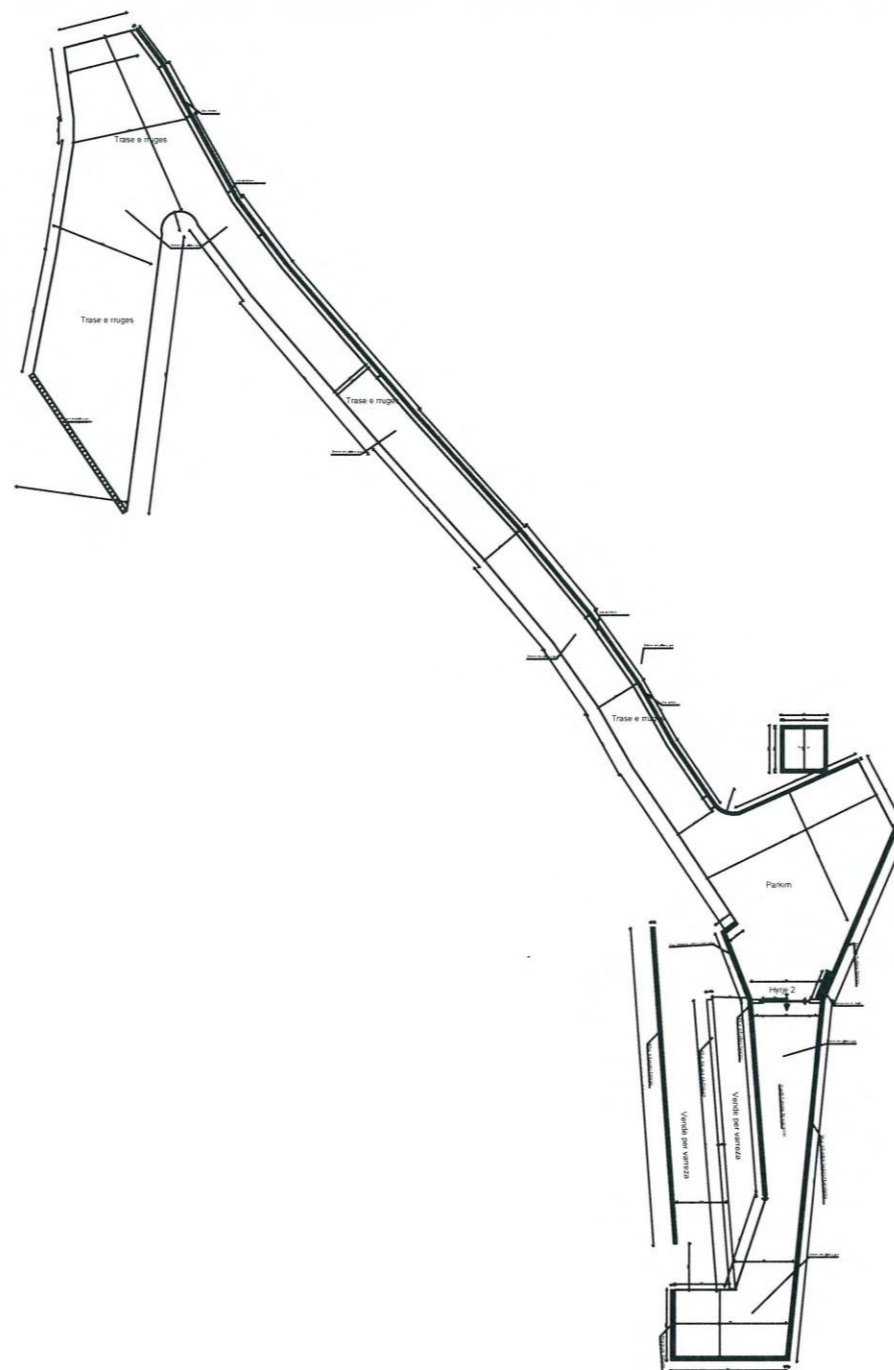
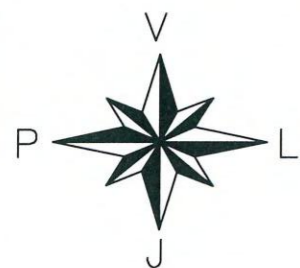

Emertimi i Projektit:	
Rikonstruksioni dhe rehabilitimi i rrugëve te varrezave te vjetra, lagjia Kaluç dhe pallati katerkatesh	
Faza	Projekt Zbatimi

Emertimi i Fletes:	
<i>Dimensioni ne Plan</i>	
Shkalla:	1 : 1000

Projektoi:
"XH & MILLER" SHPK
ADM: XHULJETA DÛRO



Kapitulli:	Projekt Zbatimi
Nr. Fletes:	A - 30
Data:	Janar 2023

RRUGA E VARREZAVE TE VJETRA

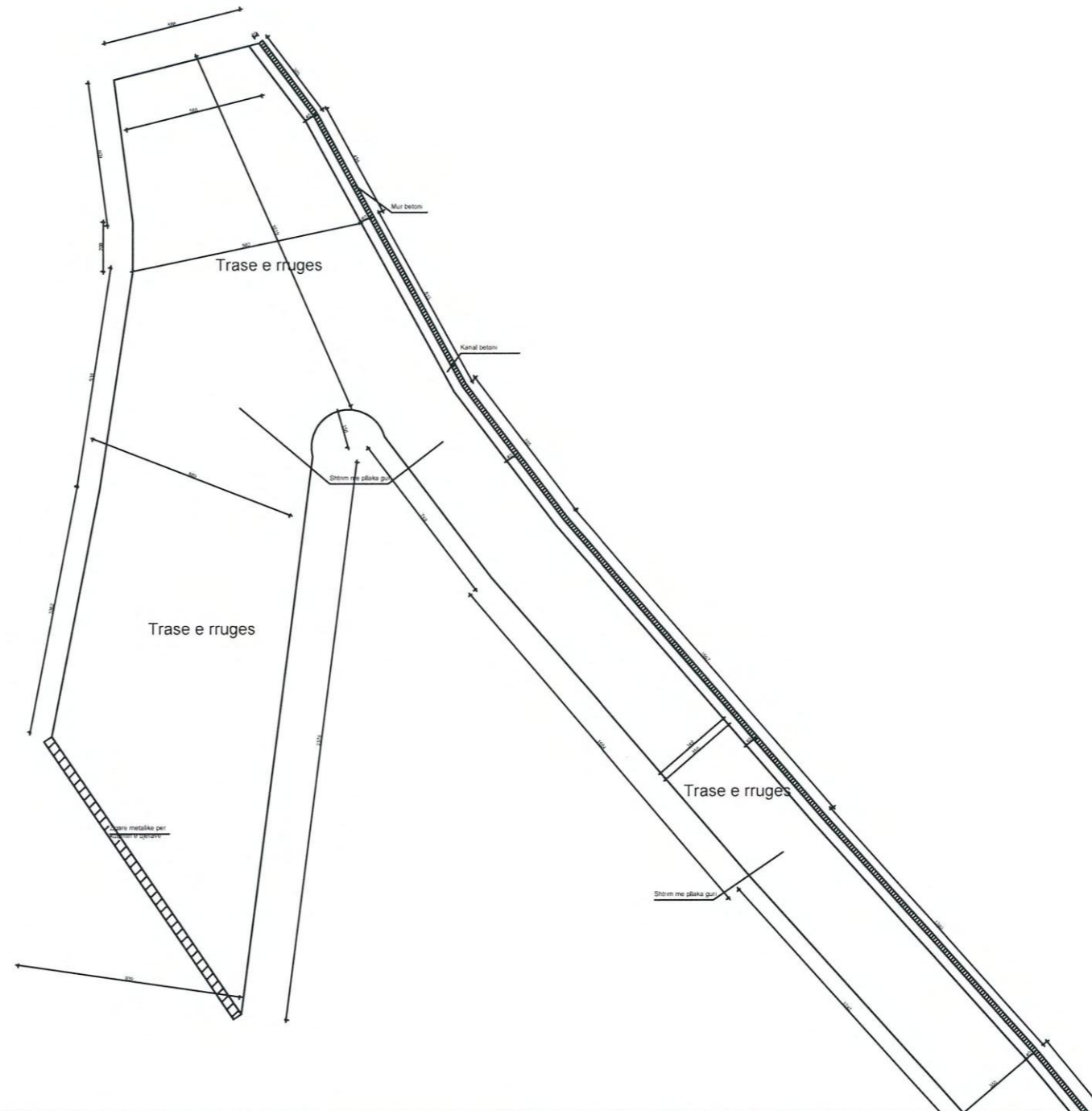
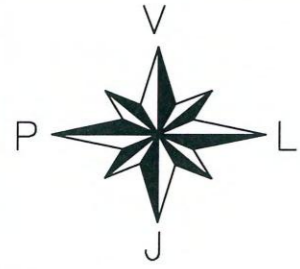

Emertimi i Projektit:		Emertimi i Fletes:		Projektoi: "XH & MILLER" SHPK ADM: XHULJETA DURO	Kapitulli:	Projekt Zbatimi
Rikonstruksioni dhe rehabilitimi i rrugëve te varrezave te vjetra, lagjia Kaluç dhe pallati katerkatesh		Dimensioni ne Plan			Nr. Fletes:	A - 30-1
Faza	Projekt Zbatimi	Shkalla:	1 : 250	Data:	Janar 2023	

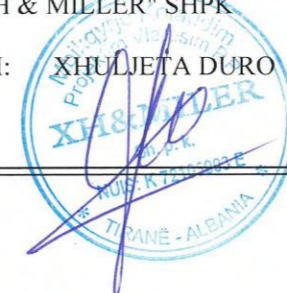

RRUGA E VARREZAVE TE VJETRA

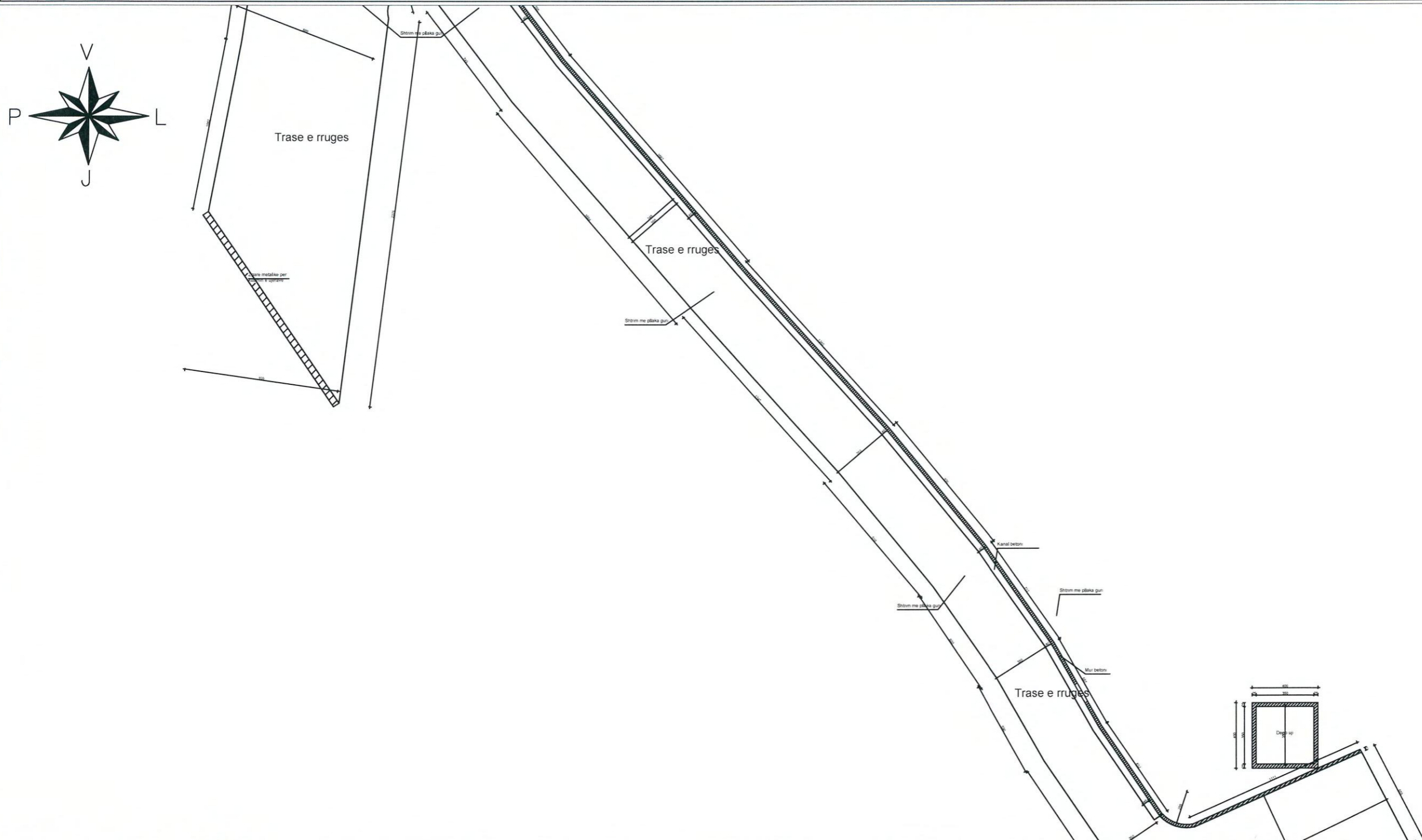

Emertimi i Projektit:	
Rikonstruksioni dhe rehabilitimi i rrugëve te varrezave te vjetra, lagjia Kaluç dhe pallati katerkatesh	
Faza	Projekt Zbatimi

Emertimi i Fletes:	
<i>Dimensioni ne Plan</i>	
Shkalla:	1 : 250

Projekttoi:
"XH & MILLER" SHPK
ADM: XHULJETA DURO

Kapitulli:	Projekt Zbatimi
Nr. Fletes:	A - 30-2
Data:	Janar 2023

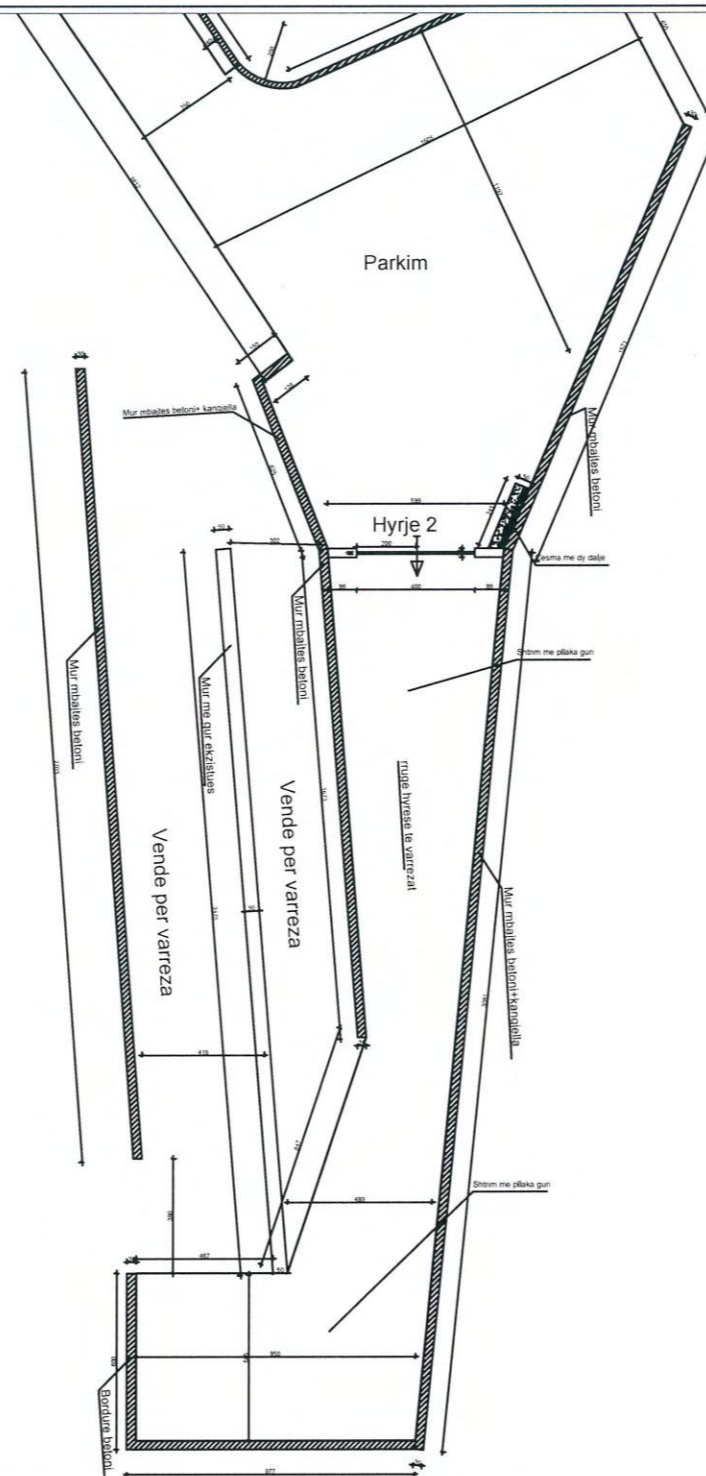
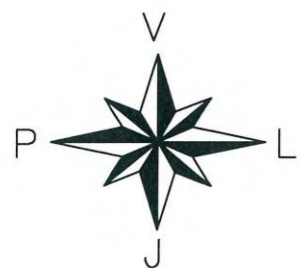

RRUGA E VARREZAVE TE VJETRA

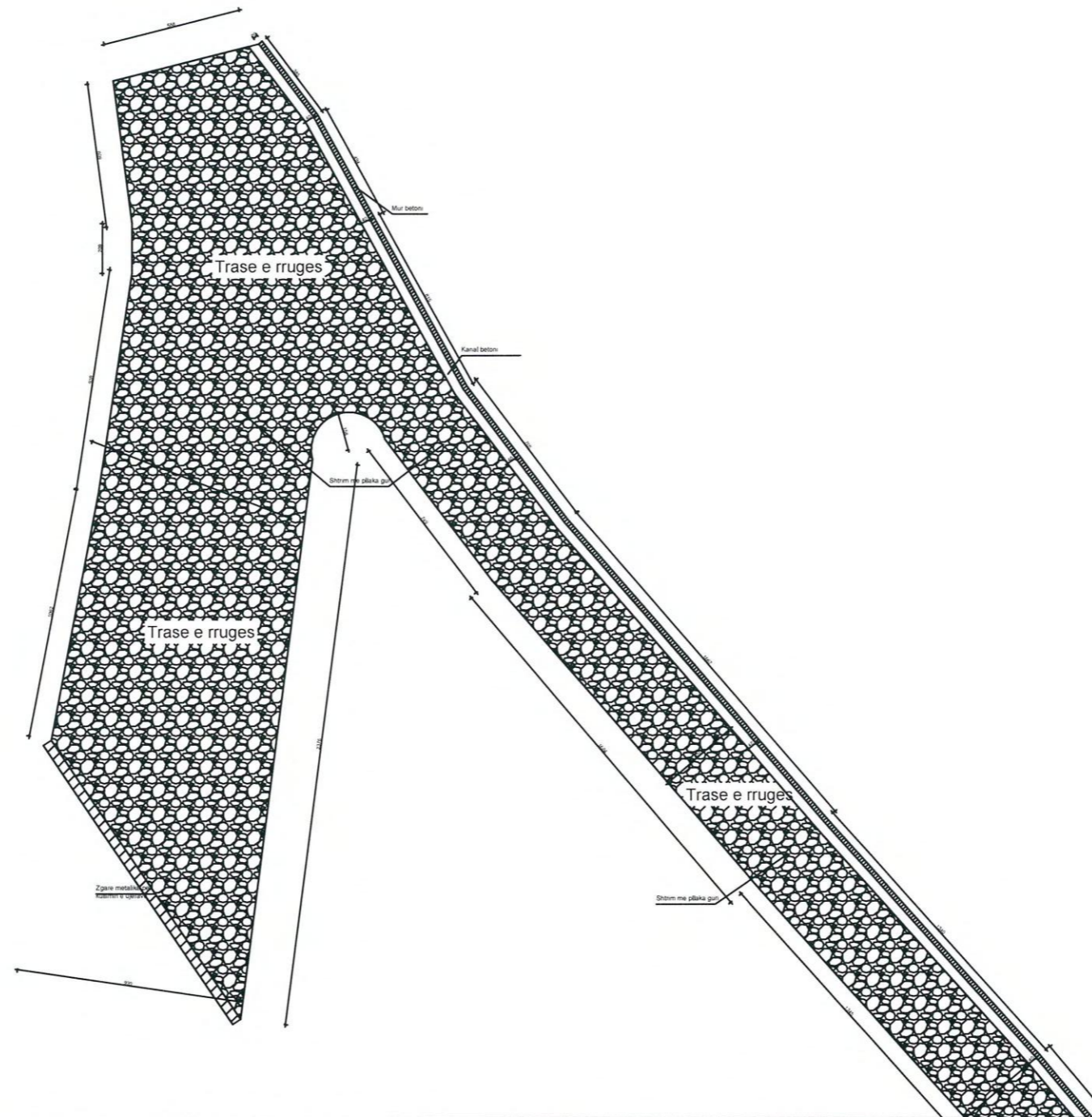
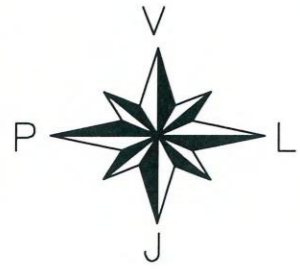

Emertimi i Projektit:		Emertimi i Fletes:		Projektoi: "XH & MILLER" SHPK ADM: XHULJETA DURO 	Kapitulli:	Projekt Zbatimi
Rikonstruksioni dhe rehabilitimi i rrugëve te varrezave te vjetra, lagjia Kaluç dhe pallati katerkatësh		Dimensioni ne Plan			Nr. Fletes:	A - 30-3
Faza	Projekt Zbatimi	Shkalla:	1 : 250		Data:	Janar 2023

RRUGA E VARREZAVE TE VJETRA



		Emertimi i Projektit:		Emertimi i Fletes:		Projektoi: "XH & MILLER" SHPK ADM: XHULJETA DURO 	Kapitulli:	Projekt Zbatimi
		Rikonstruksioni dhe rehabilitimi i rrugëve te varrezave te vjetra, lagjia Kaluç dhe pallati katerkatësh		Planimetri e Pergjithshme			Nr. Fletes:	A - 31-1
Faza	Projekt Zbatimi	Shkalla:	1 : 250	Data:	Janar 2023			

RRUGA E VARREZAVE TE VJETRA

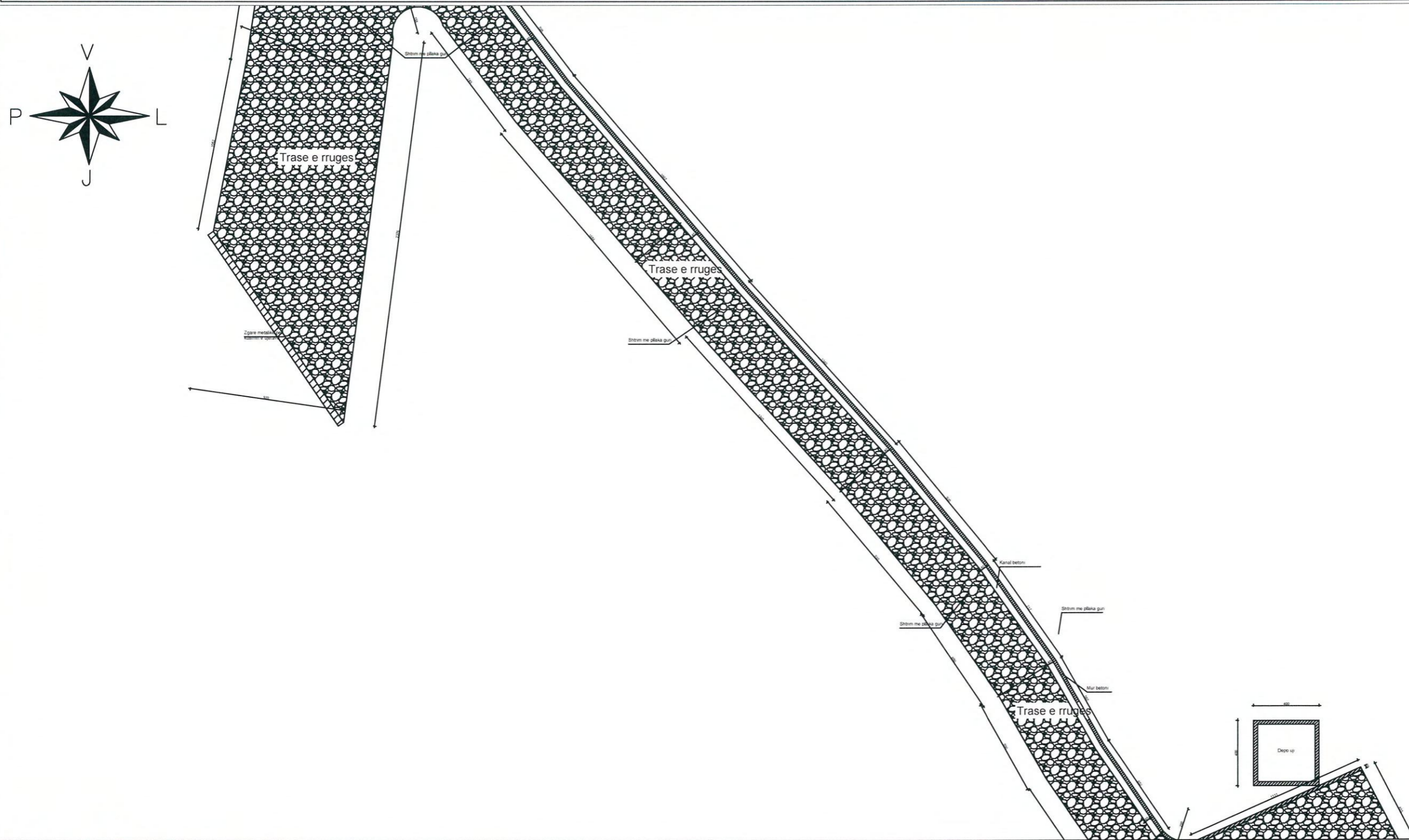

		Emertimi i Projektit:		Emertimi i Fletes:		Projektoi: "XH & MILLER" SHPK ADM: XHULJETA DURO 	Kapitulli:	Projekt Zbatimi
		Rikonstruksioni dhe rehabilitimi i rrugëve te varrezave te vjetra, lagjia Kaluç dhe pallati katerkatesh		Planimetri e Pergjithshme			Nr. Fletes:	A - 31-2
		Faza	Projekt Zbatimi	Shkalla:	1 : 250		Data:	Janar 2023

RRUGA E VARREZAVE TE VJETRA

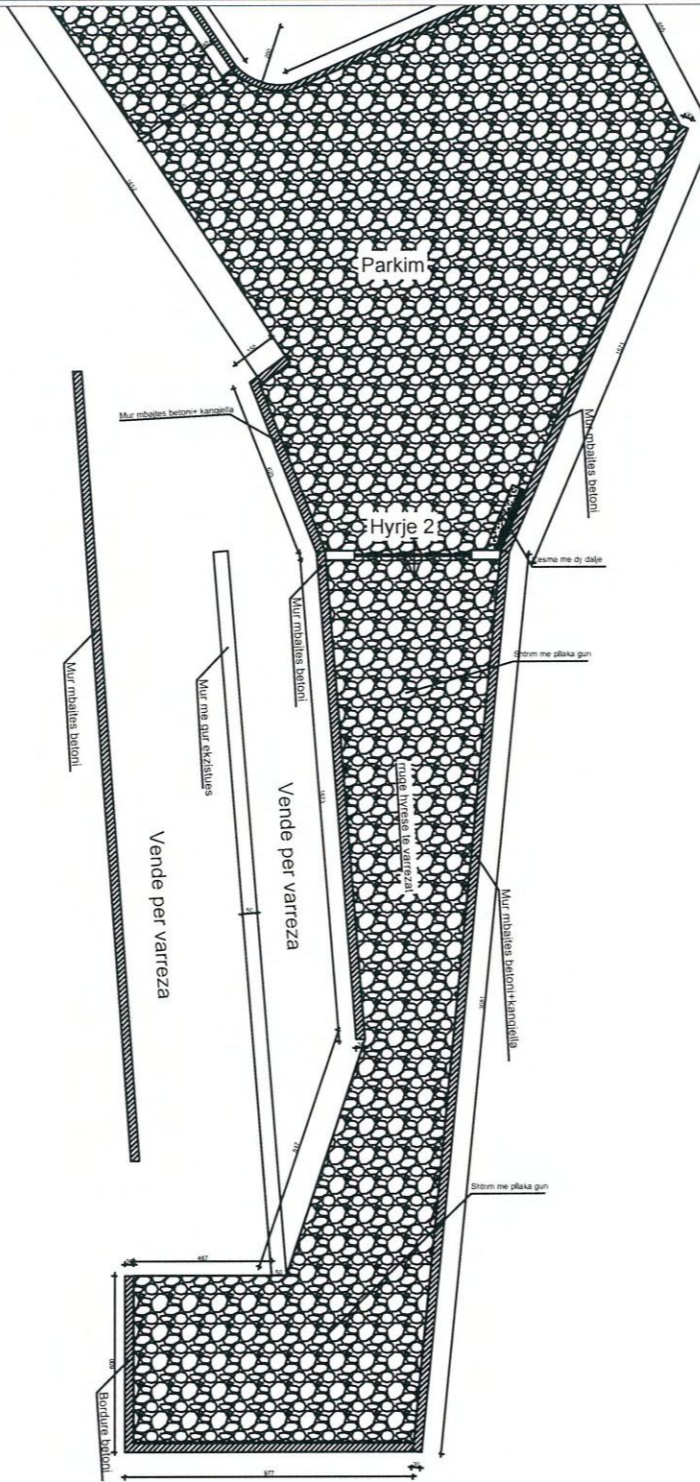
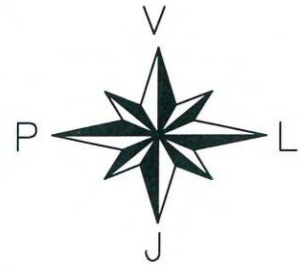

Emertimi i Projektit:		Emertimi i Fletes:		Projektoi: "XH & MILLER" SHPK ADM: XHULJETA DURO	Kapitulli:	Projekt Zbatimi
Rikonstruksioni dhe rehabilitimi i rrugeve te varrezave te vjetra, lagjia Kaluç dhe pallati katerkatesh		Planimetri e Pergjithshme			Nr. Fletes:	A - 31-3
Faza	Projekt Zbatimi	Shkalla:	1 : 250	Data:	Janar 2023	





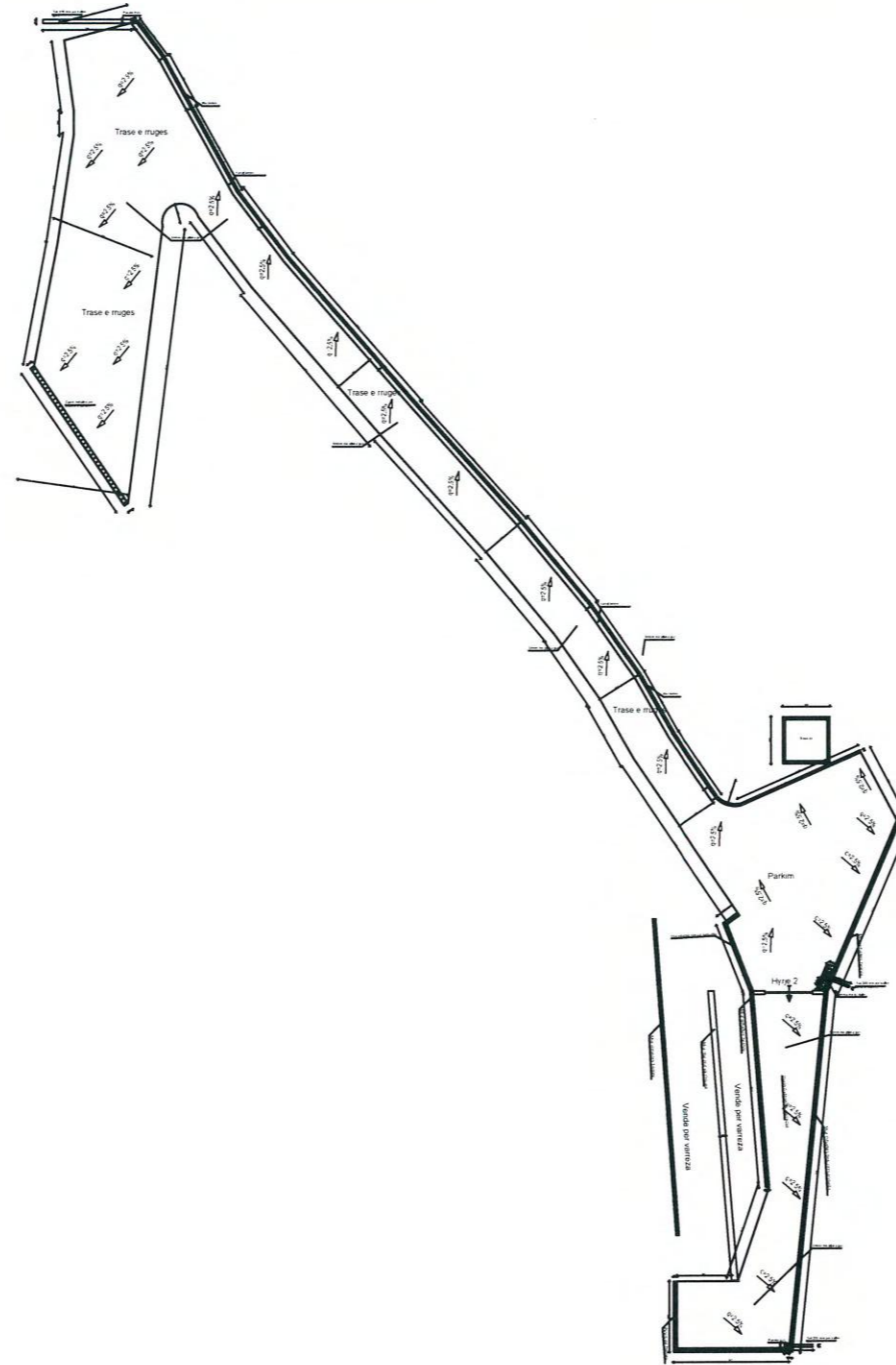
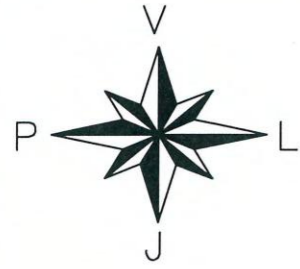

RRUGA E VARREZAVE TE VJETRA

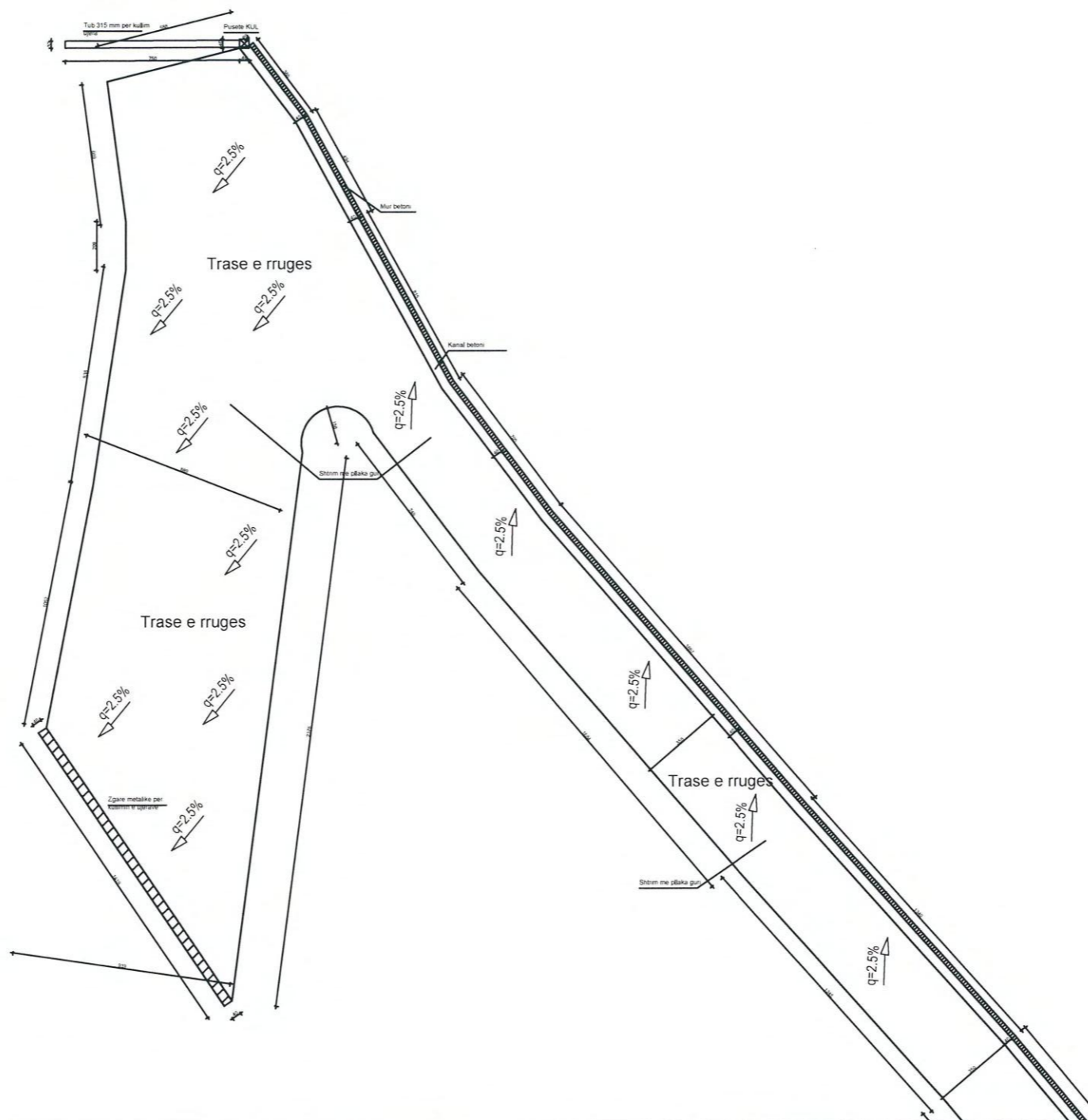
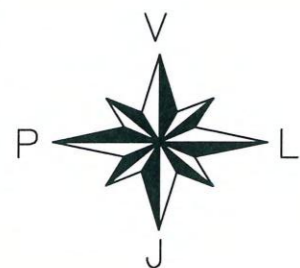

Emertimi i Projektit:		Emertimi i Fletes:		Projektoi: "XH & MILLER" SHPK ADM: XHULJETA DURO 	Kapitulli:	Projekt Zbatimi
Rikonstruksioni dhe rehabilitimi i rrugeve te varrezave te vjetra, lagjia Kaluç dhe pallati katerkatesh		Plani i Kullimit			Nr. Fletes:	A - 32
Faza	Projekt Zbatimi	Shkalla:	1 : 1000		Data:	Janar 2023

RRUGA E VARREZAVE TE VJETRA



		Emertimi i Projektit:		Emertimi i Fletes:		Projektoi: "XH & MILLER" SHPK ADM: XHULJETA DURO 	Kapitulli:	Projekt Zbatimi
		Rikonstruksioni dhe rehabilitimi i rrugeve te varrezave te vjetra, lagjia Kaluç dhe pallati katerkatesh		Plani i Kullimit			Nr. Fletes:	A - 32-1
		Faza	Projekt Zbatimi	Shkalla:	1 : 250		Data:	Janar 2023

RRUGA E VARREZAVE TE VJETRA

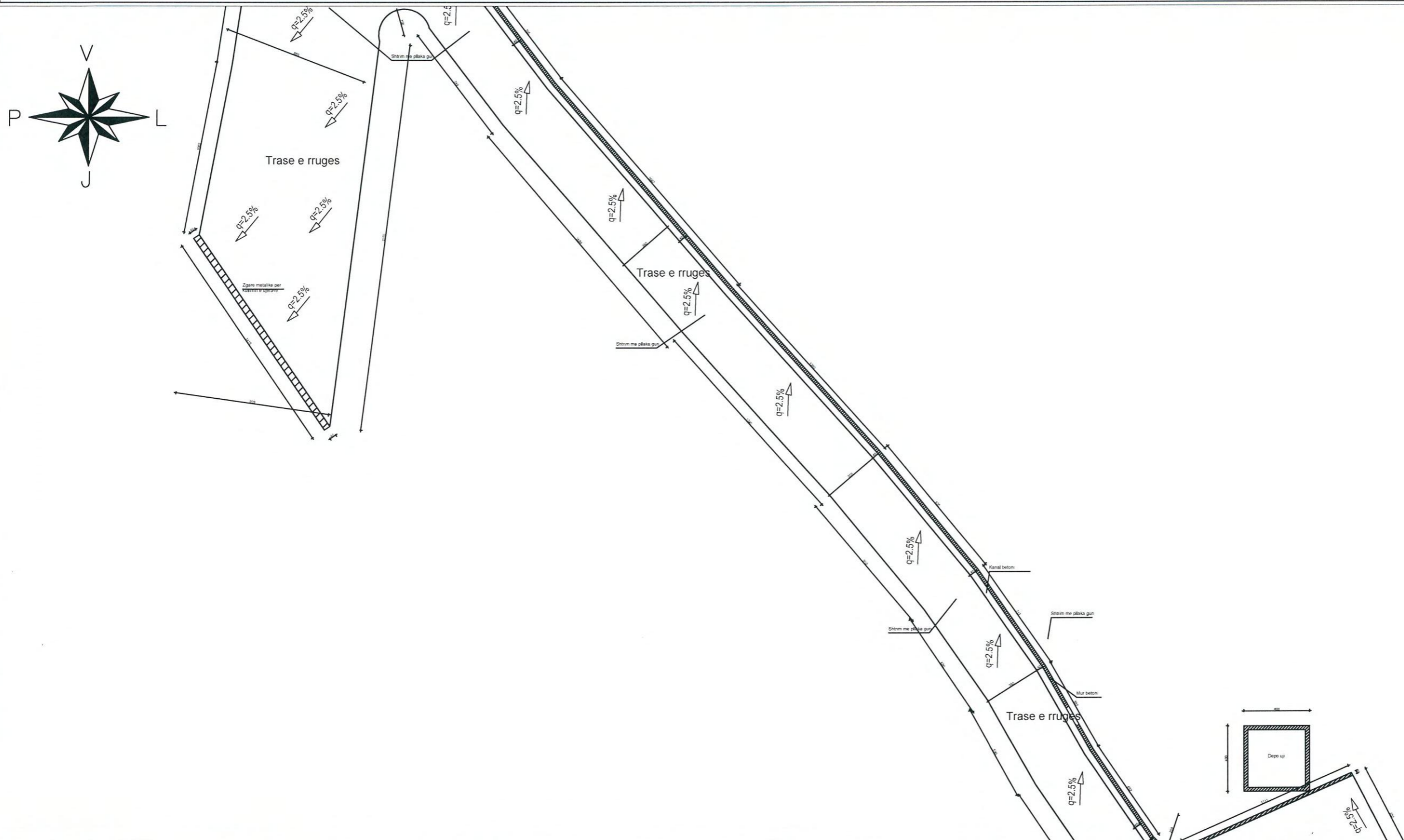

REPUBLIKA E SHQIPËRISE
BASHKIA E POLICAN

Emertimi i Projektit:		Emertimi i Fletes:		Projektoi: "XH & MILLER" SHPK ADM: XHUIJETA DURO	Kapitulli:	Projekt Zbatimi
Rikonstruksioni dhe rehabilitimi i rrugeve te varrezave te vjetra, lagjia Kaluç dhe pallati katerkatesh		Plani i Kullimit			Nr. Fletes:	A - 32-2
Faza	Projekt Zbatimi	Shkalla:	1 : 250	Data:	Janar 2023	



RRUGA E VARREZAVE TE VJETRA

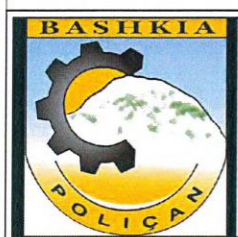
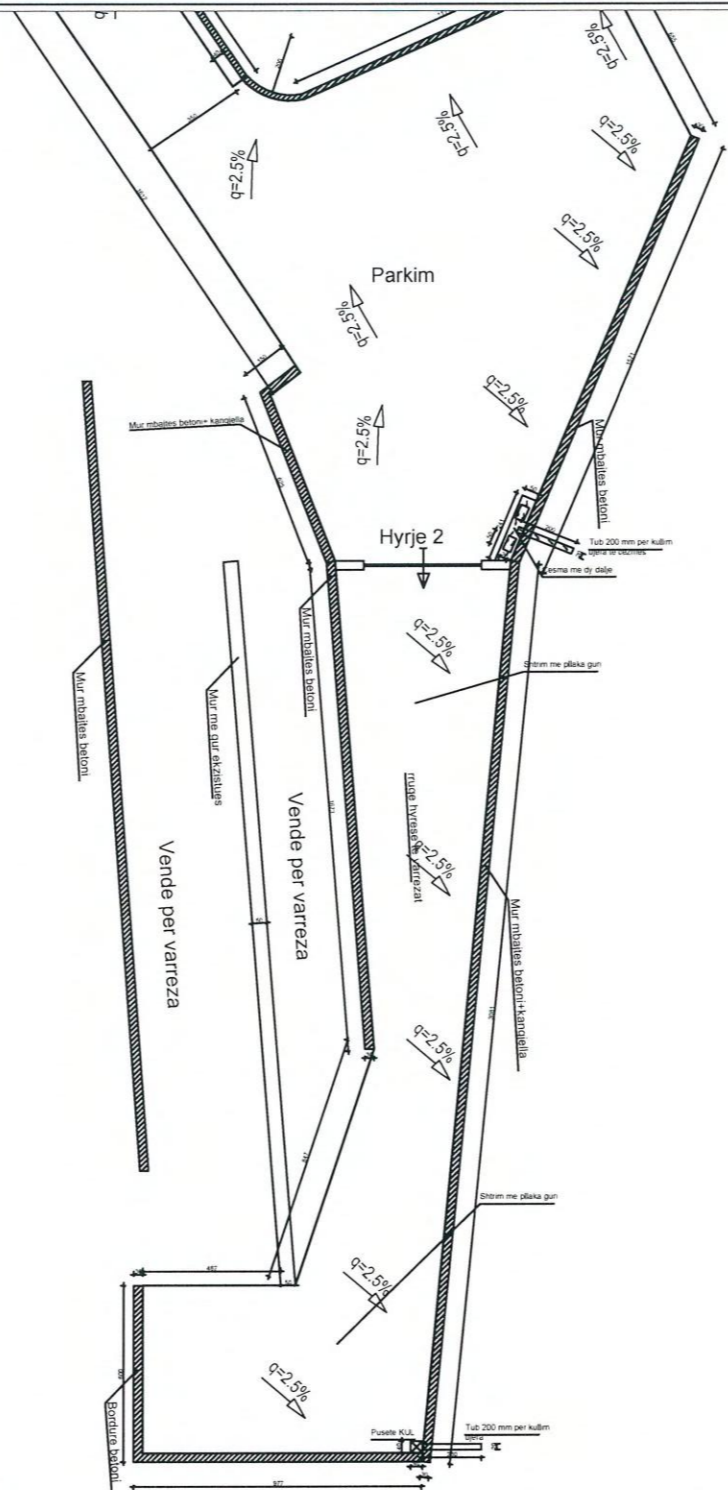
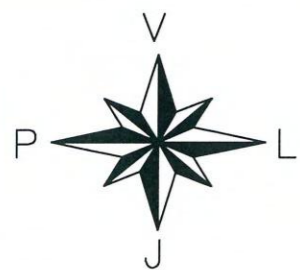

REPUBLIKA E SHQIPËRISË
BASHKIA POLIÇAN

Emertimi i Projektit:	
Rikonstruksioni dhe rehabilitimi i rrugeve te varrezave te vjetra, lagjia Kaluç dhe pallati katerkatesh	
Faza	Projekt Zbatimi

Emertimi i Fletes:	
Piani i Kullimit	
Shkalla:	1 : 250

Projektoi:
"XH & MILLER" SHPK
ADM: XHULJETA DURO



Kapitulli:	Projekt Zbatimi
Nr. Fletes:	A - 32-3
Data:	Janar 2023

RRUGA E VARREZAVE TE VJETRA

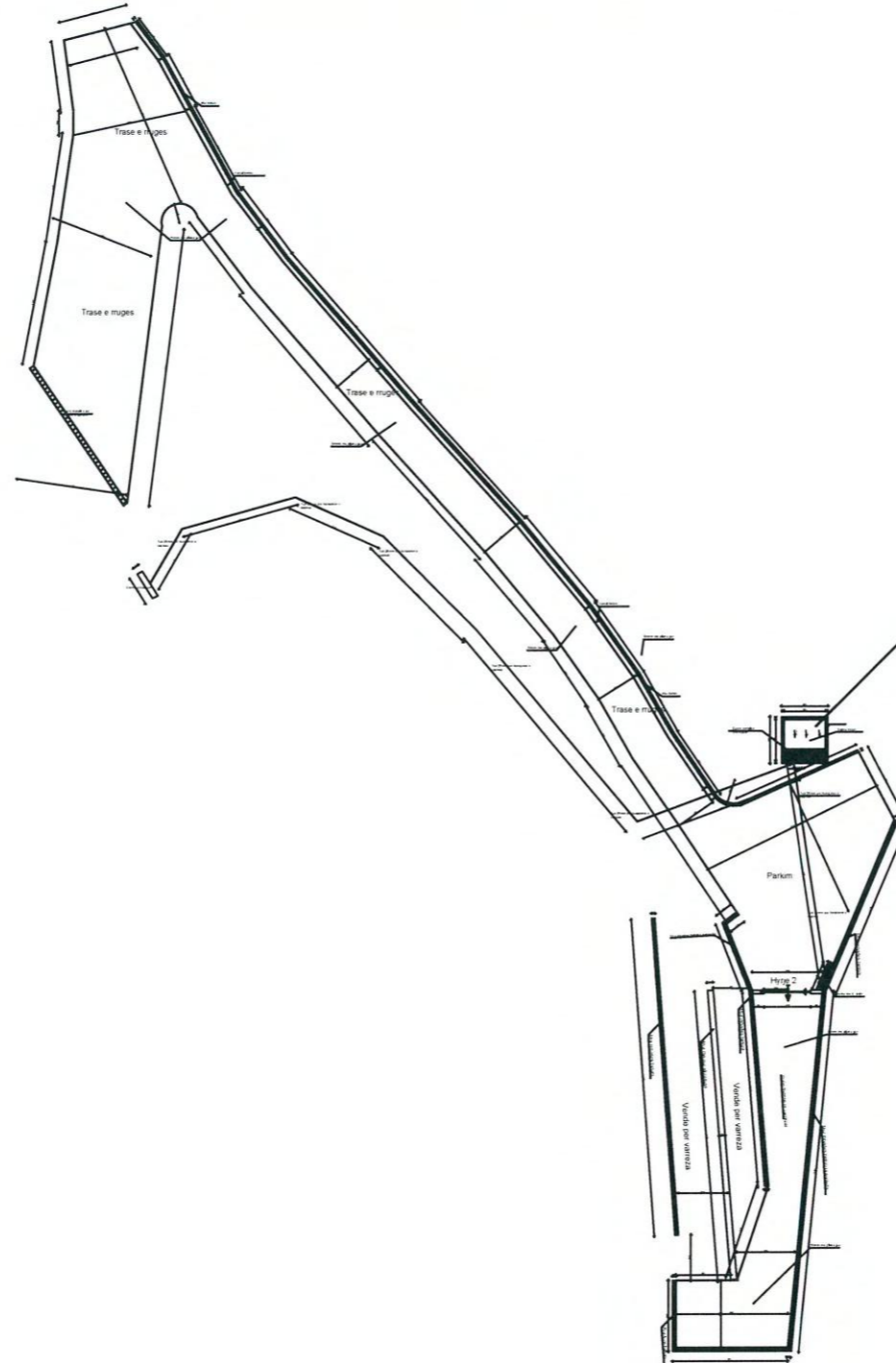
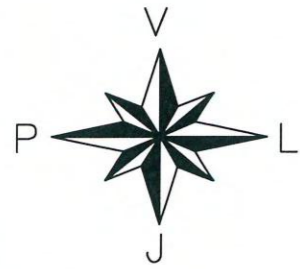

Emertimi i Projektit:		Emertimi i Fletes:		Projektoi: "XH & MILLER" SHPK ADM: XHULJETA DURO	Kapitulli:	Projekt Zbatimi
Rikonstruksioni dhe rehabilitimi i rrugeve te varrezave te vjetra, lagjia Kaluç dhe pallati katerkatesh		Furnizimi me uje			Nr. Fletes:	A - 33
Faza	Projekt Zbatimi	Shkalla:	1 : 1000	Data:	Janar 2023	



RRUGA E VARREZAVE TE VJETRA

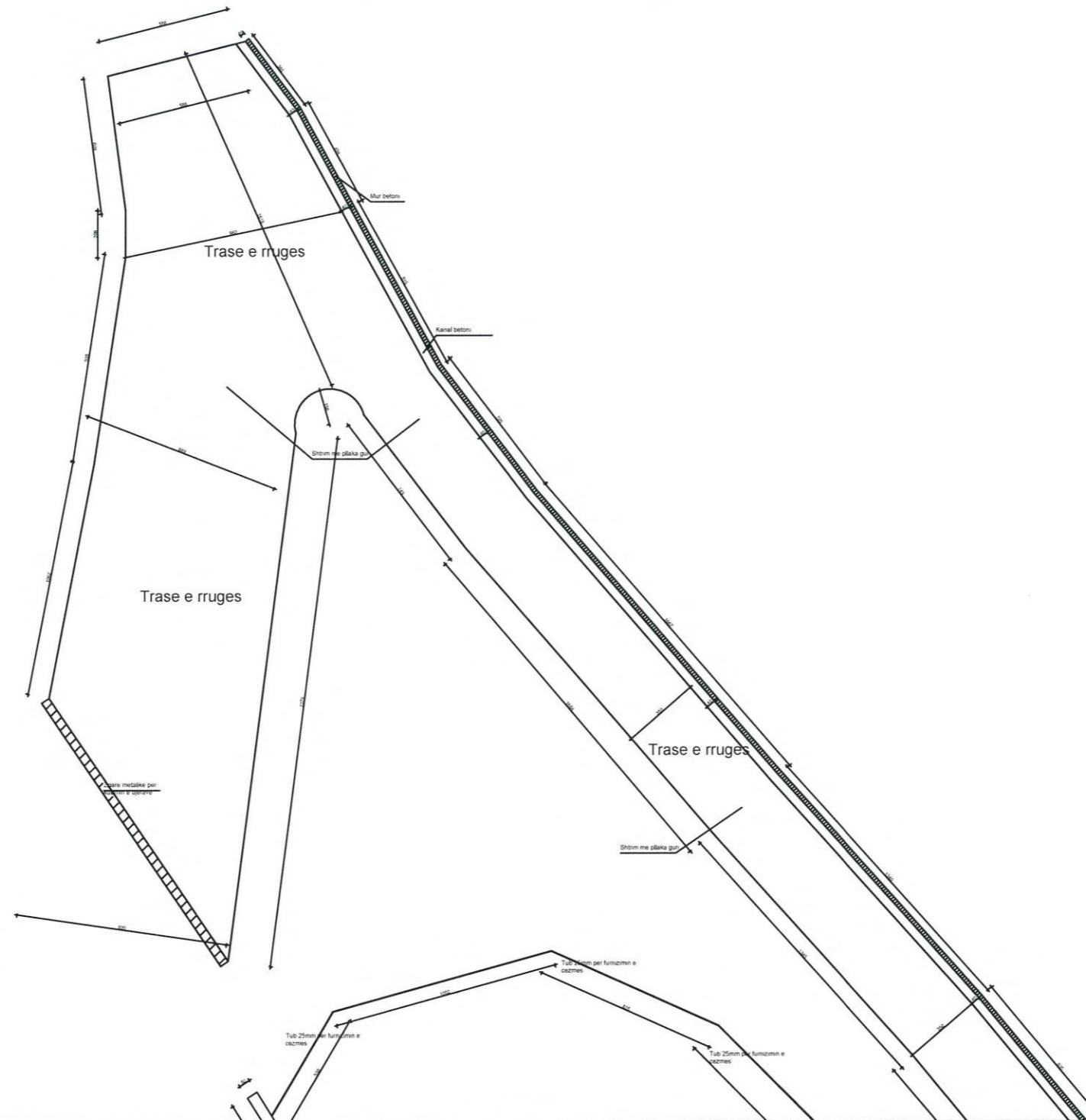
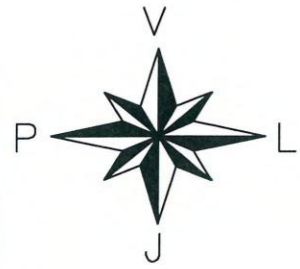

REPUBLIKA E SHqipërisë
BASHKIA E POLICAN

Emertimi i Projektit:	
Rikonstruksioni dhe rehabilitimi i rrugëve te varrezave te vjetra, lagjia Kaluç dhe pallati katerkatesh	
Faza	Projekt Zbatimi

Emertimi i Fletes:	
Furnizimi me uje	
Shkalla:	1 : 250

Projekttoi:
"XH & MILLER" SHPK
ADM: XHULJETA DURO
Sh. p. k.
NUIS: K 72105001E
TIRANE - ALBANI

Kapitulli:	Projekt Zbatimi
Nr. Fletes:	A - 33-1
Data:	Janar 2023

RRUGA E VARREZAVE TE VJETRA

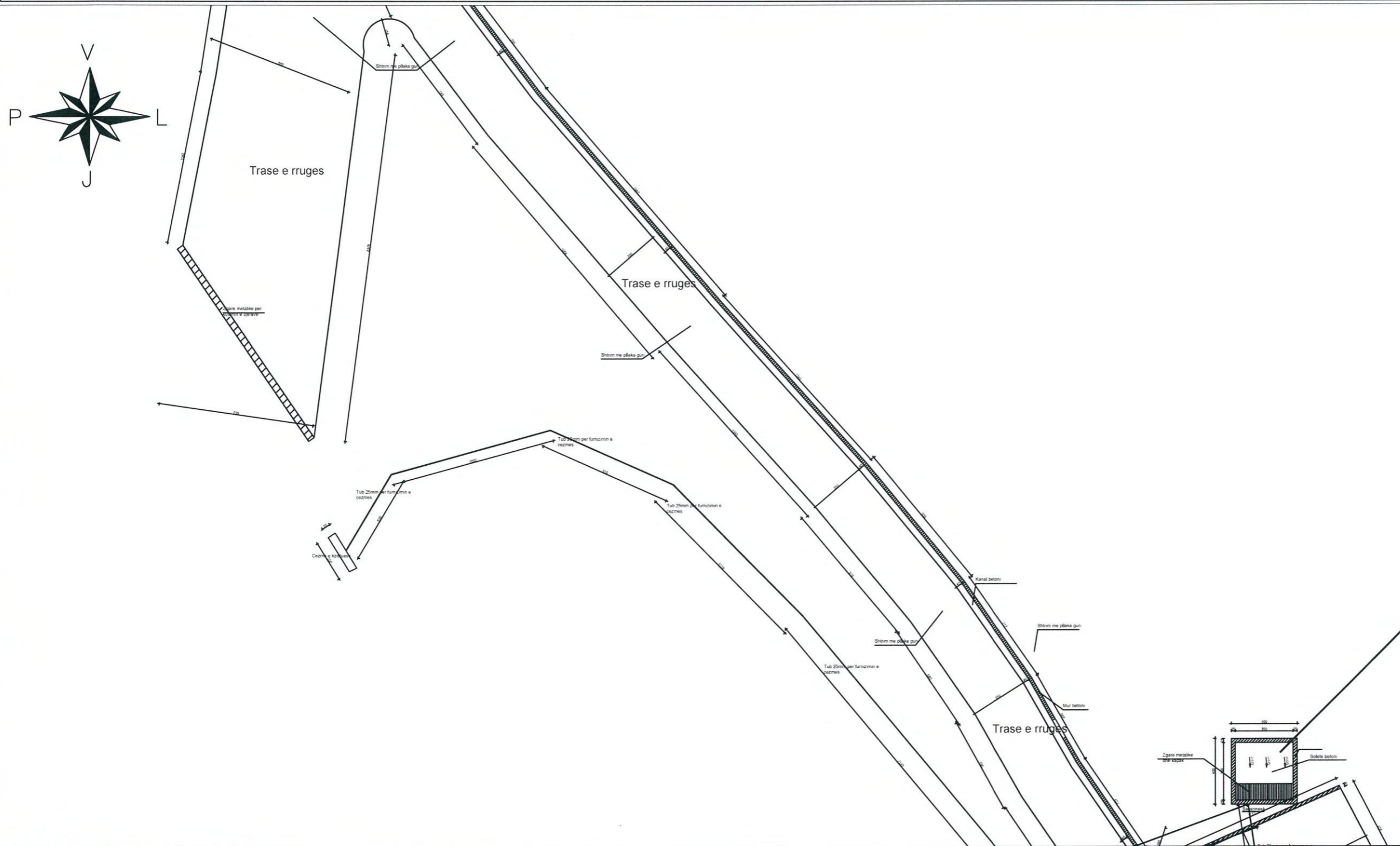

Emertimi i Projektit:	
Rikonstruksioni dhe rehabilitimi i rrugëve te varrezave te vjetra, lagjia Kaluç dhe pallati katerkatesh	
Faza	Projekt Zbatimi

Emertimi i Fletes:	
Furnizimi me uje	
Shkalla:	1 : 250

Projektoi:	"XH & MILLER" SHPK
ADM:	XHULJETA DURO



Kapitulli:	Projekt Zbatimi
Nr. Fletes:	A - 33-2
Data:	Janar 2023

RRUGA E VARREZAVE TE VJETRA

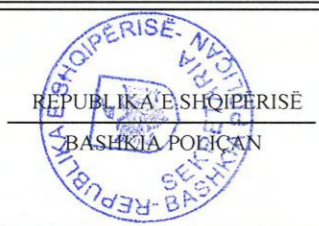
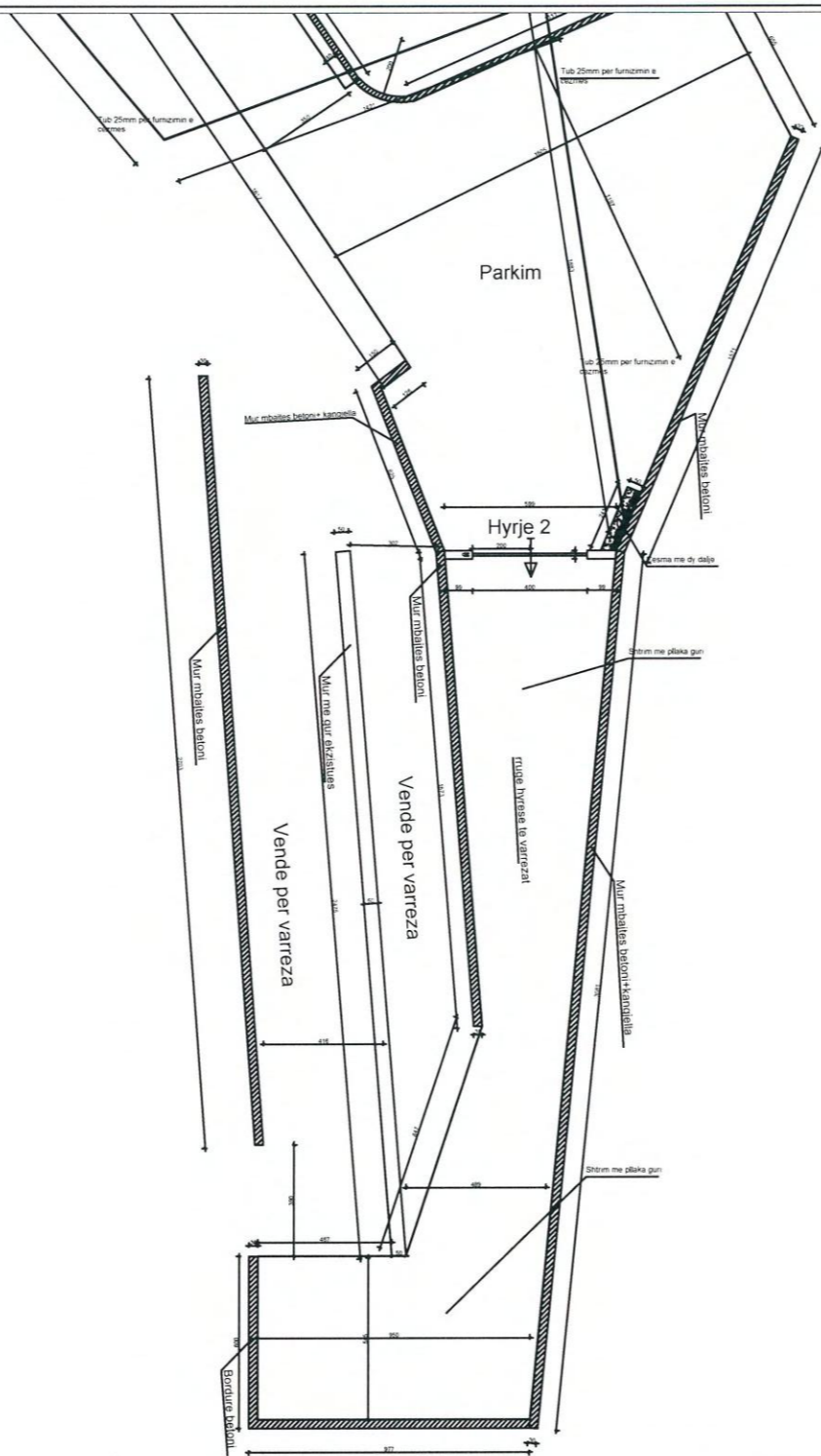
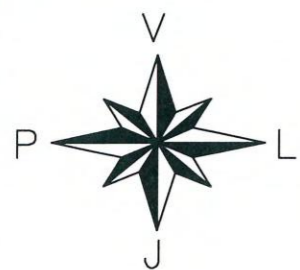

Emertimi i Projektit:	
Rikonstruksioni dhe rehabilitimi i rrugeve te varrezave te vjetra, lagjia Kaluç dhe pallati katerkatesh	
Faza	Projekt Zbatimi

Emertimi i Fletes:	
Furnizimi me uje	
Shkalla:	1 : 250

Projektoi:
"XH & MILLER" SHPK
ADM: XHULJETA DURO



Kapitulli:	Projekt Zbatimi
Nr. Fletes:	A - 33-3
Data:	Janar 2023

RRUGA E VARREZAVE TE VJETRA

SHK. 1:20

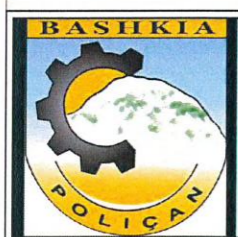
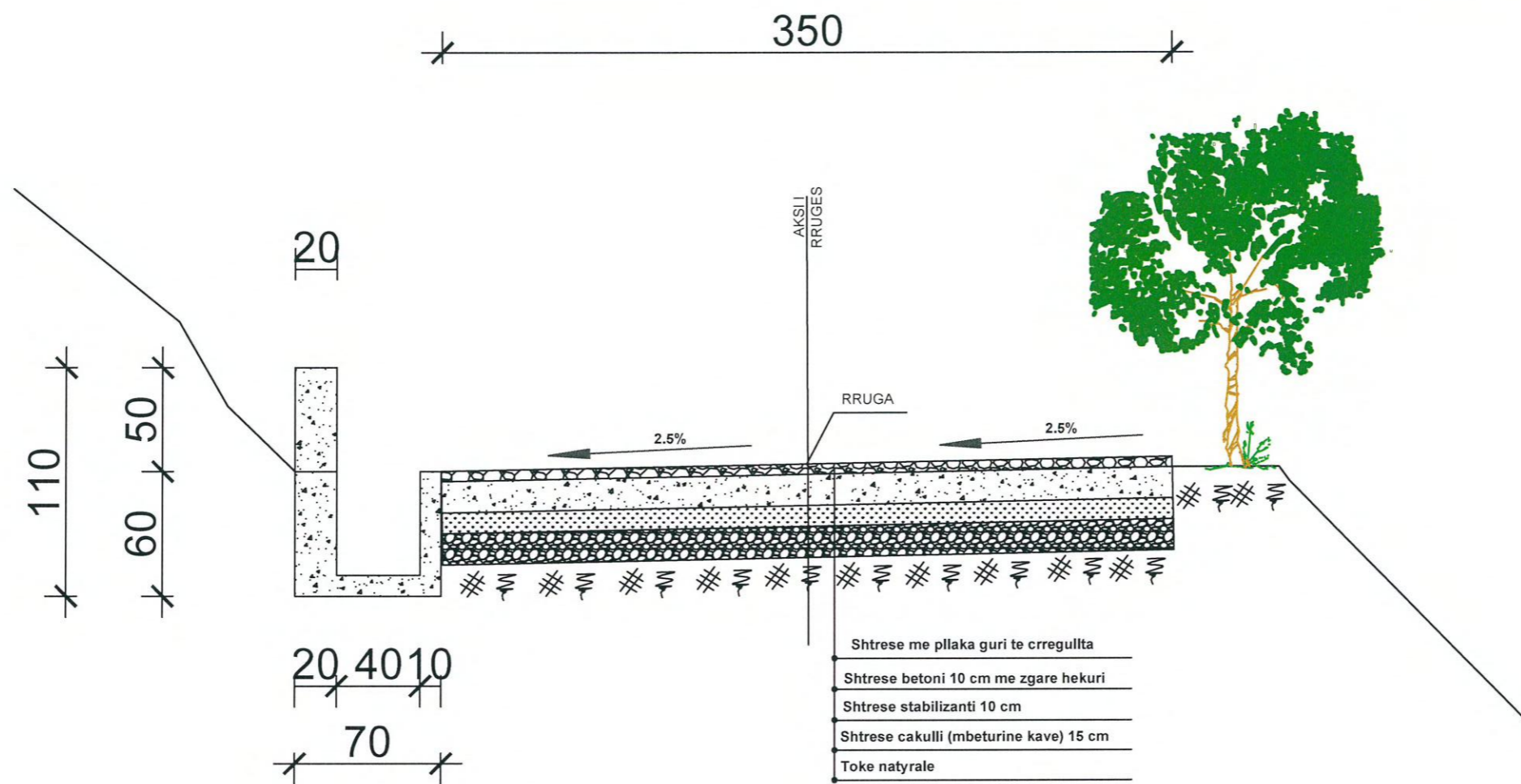
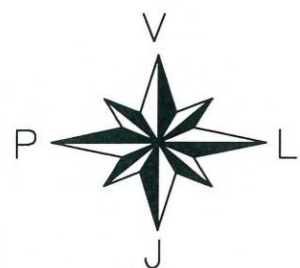

Emertimi i Projektit:	
Rikonstruksioni dhe rehabilitimi i rrugeve te varrezave te vjetra, lagjia Kaluç dhe pallati katerkatesh	
Faza	Projekt Zbatimi

Emertimi i Fletes:	
Prejje terthore Tip	
Shkalla:	1 : 1000

Projektoi:	"XH & MILLER" SHPK
ADM:	XHULJETA DURO



Kapitulli:	Projekt Zbatimi
Nr. Fletes:	A - 34
Data:	Janar 2023

RRUGA E VARREZAVE TE VJETRA

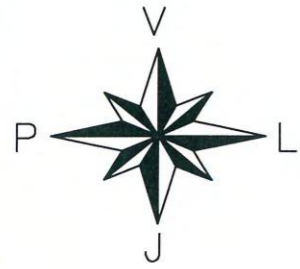

350

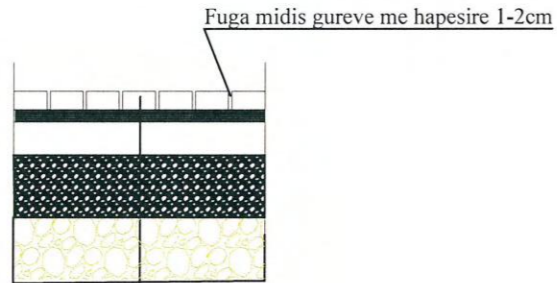

gur i crregullt dekorativ t=3-5 cm
 Shtrese llaci me vendosjen e gurit
 Shtrese betoni me trashei t=10cm
 Shtrese stabilizanti kave t=10 cm
 Shtrese mbeturine kave t=15 cm

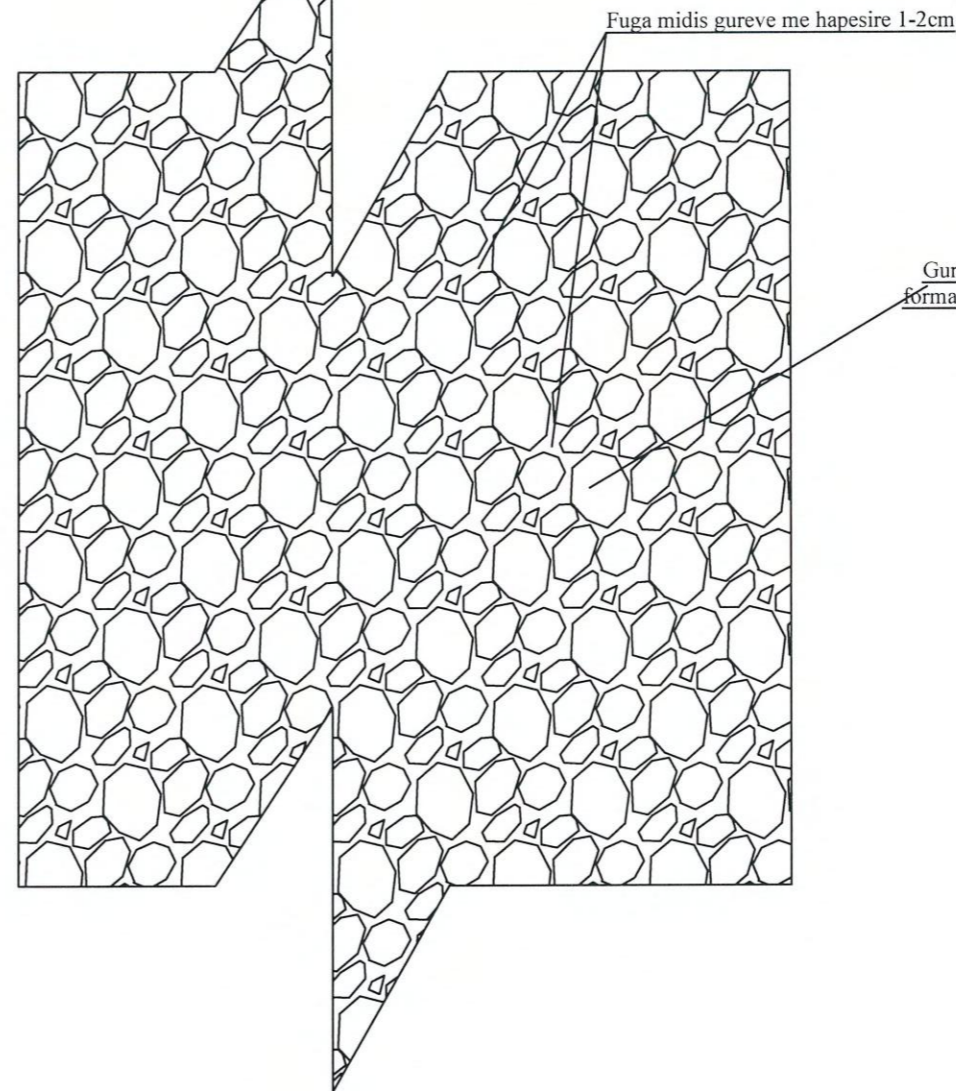

Emertimi i Projektit:	
Rikonstruksioni dhe rehabilitimi i rrugeve te varrezave te vjetra, lagjia Kaluç dhe pallati katerkatesh	
Faza	Projekt Zbatimi

Emertimi i Fletes:	
Detaje Teknike Shtresat e rruges	
Shkalla:	1 : 1000

Projekttoi:	"XH & MILLER" SHPK
ADM:	XHULJETA DURO

Kapitulli:	Projekt Zbatimi
Nr. Fletes:	A - 35
Data:	Janar 2023

RRUGA E VARREZAVE TE VJETRA

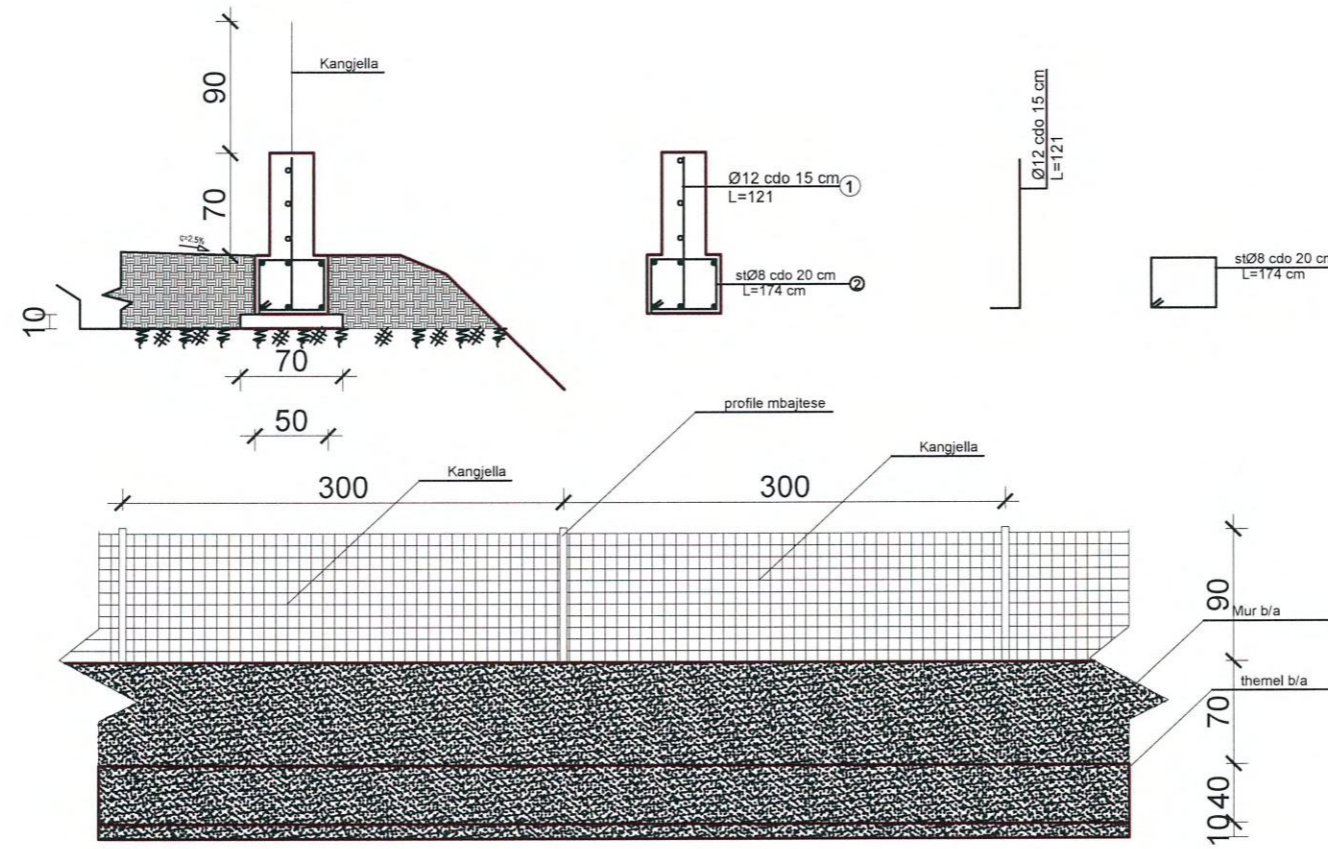
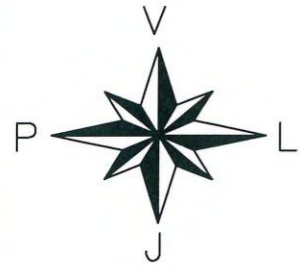

Emertimi i Projektit:	
Rikonstruksioni dhe rehabilitimi i rrugeve te varrezave te vjetra, lagjia Kaluç dhe pallati katerkatesh	
Faza	Projekt Zbatimi

Emertimi i Fletes:	
Detaje Teknike Muri Mbajtes 1	
Shkalla:	1 : 1000

Projekttoi:	"XH & MILLER" SHPK
ADM:	XHULJETA DURO

Kapitulli:	Projekt Zbatimi
Nr. Fletes:	A - 36
Data:	Janar 2023



RRUGA E VARREZAVE TE VJETRA

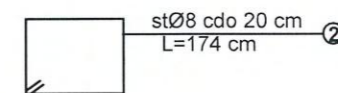
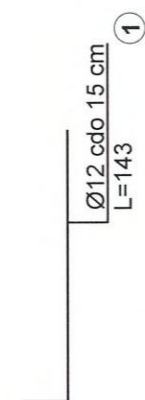
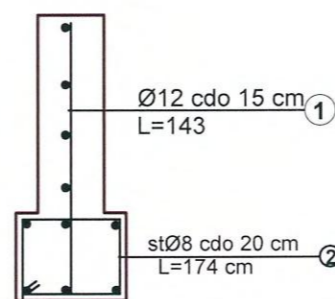
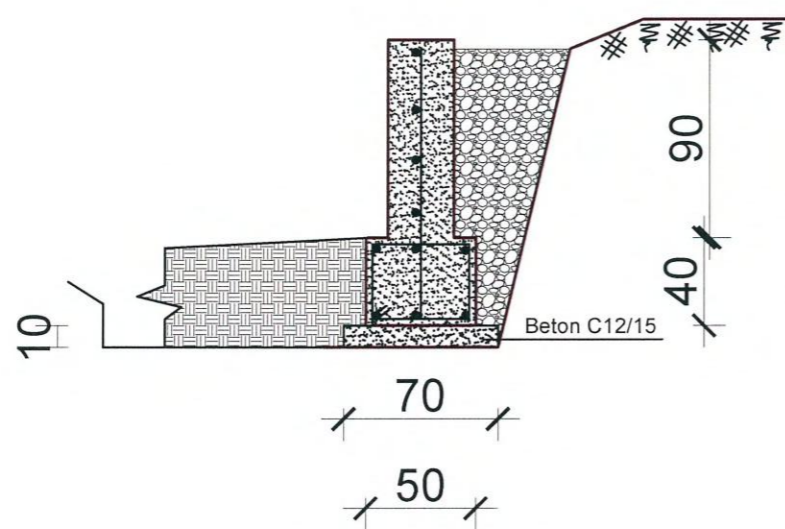
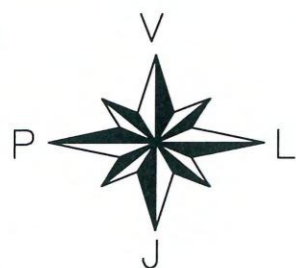

Emertimi i Projektit:		Emertimi i Fletes:		Projektoi:		Kapitulli:	Projekt Zbatimi
Rikonstruksioni dhe rehabilitimi i rrugeve te varrezave te vjetra, lagjia Kaluç dhe pallati katerkatesh		Detaje Teknike Muri Mbatjes 2		"XH & MILLER" SHPK		Nr. Fletes:	A - 37
Faza	Projekt Zbatimi	Shkalla:	1 : 1000	ADM: XHULJETA DURO		Data:	Janar 2023



RRUGA E VARREZAVE TE VJETRA

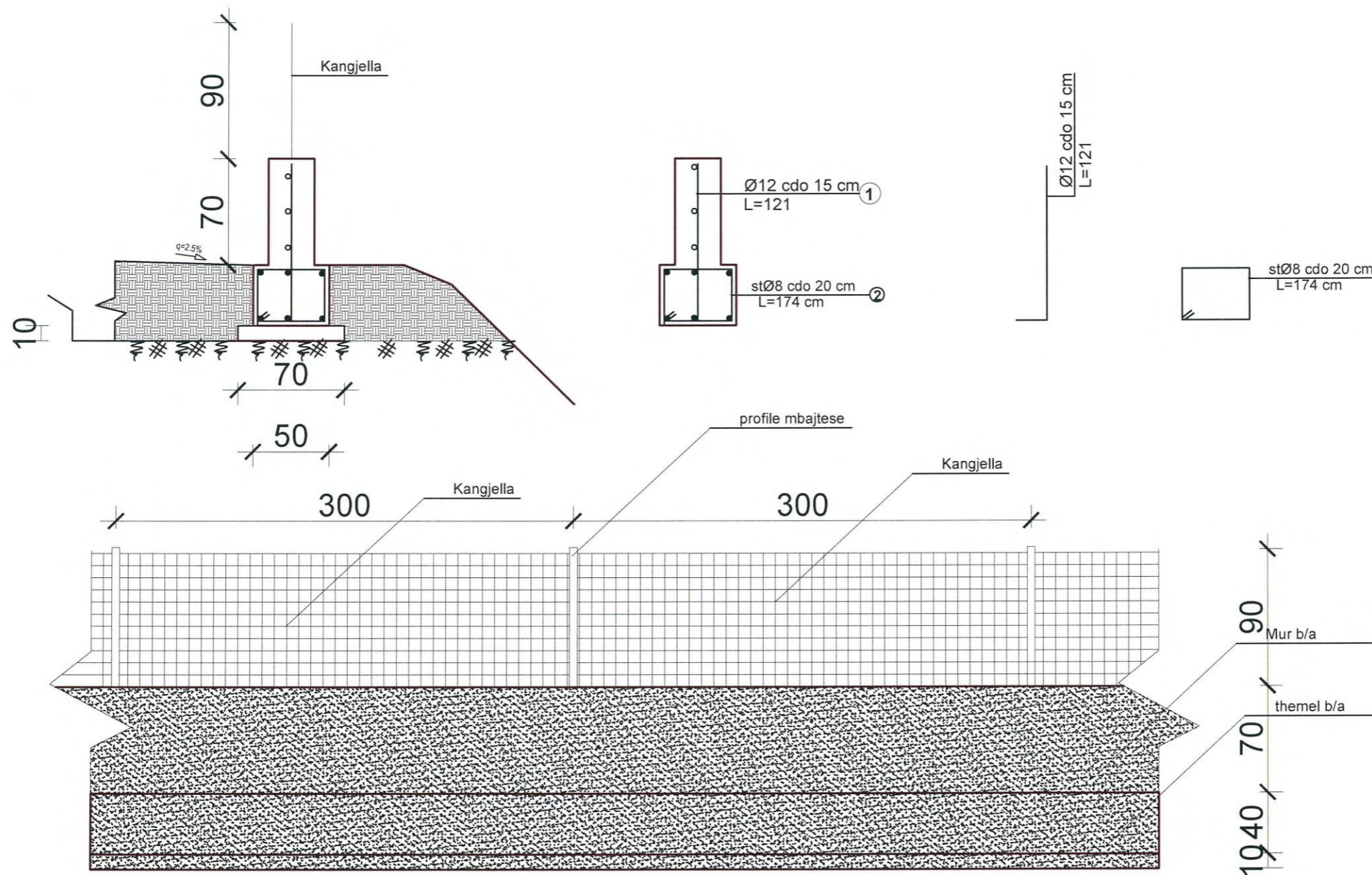
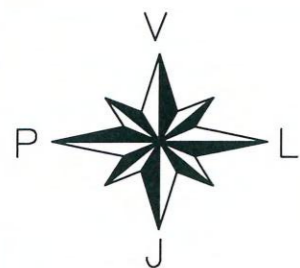

Emertimi i Projektit:	
Rikonstruksioni dhe rehabilitimi i rrugeve te varrezave te vjetra, lagjia Kaluç dhe pallati katerkatesh	
Faza	Projekt Zbatimi

Emertimi i Fletes:	
Detaje Teknike Muri Mbajtes 3	
Shkalla:	1 : 1000

Projekttoi:	"XH & MILLER" SHPK
ADM:	XHULJETA DURO

Kapitulli:	Projekt Zbatimi
Nr. Fletes:	A - 38
Data:	Janar 2023



RRUGA E VARREZAVE TE VJETRA

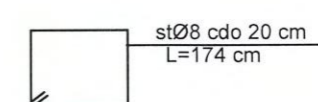
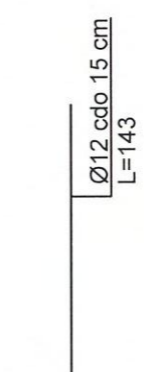
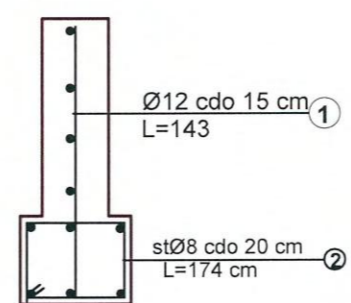
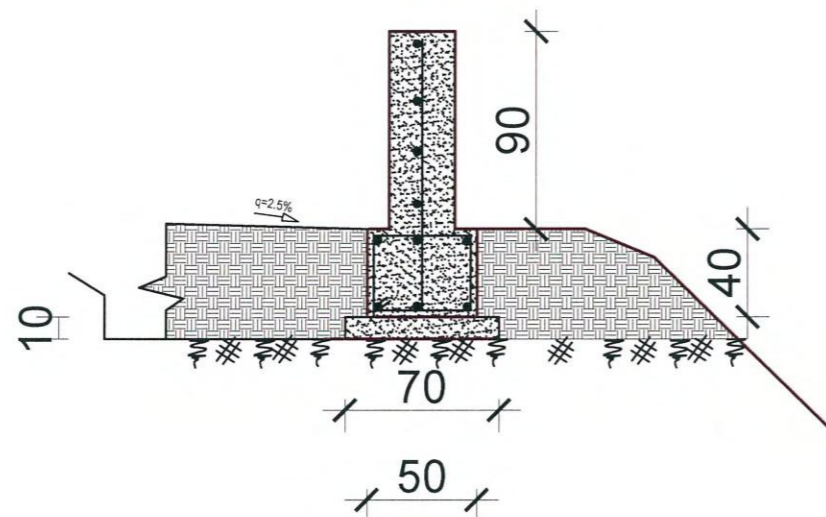
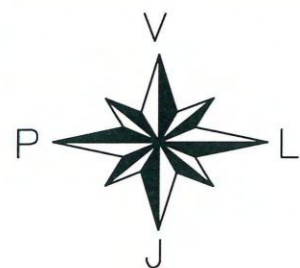

Emertimi i Projektit:	
Rikonstruksioni dhe rehabilitimi i rrugeve te varrezave te vjetra, lagjia Kaluç dhe pallati katerkatesh	
Faza	Projekt Zbatimi

Emertimi i Fletes:	
Detaje Teknike Muri Mbatjes 4	
Shkalla:	1 : 1000

Projekttoi:	"XH & MILLER" SHPK
ADM:	XHULJETA DURO



Kapitulli:	Projekt Zbatimi
Nr. Fletes:	A - 39
Data:	Janar 2023

RRUGA E VARREZAVE TE VJETRA

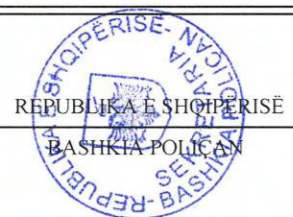
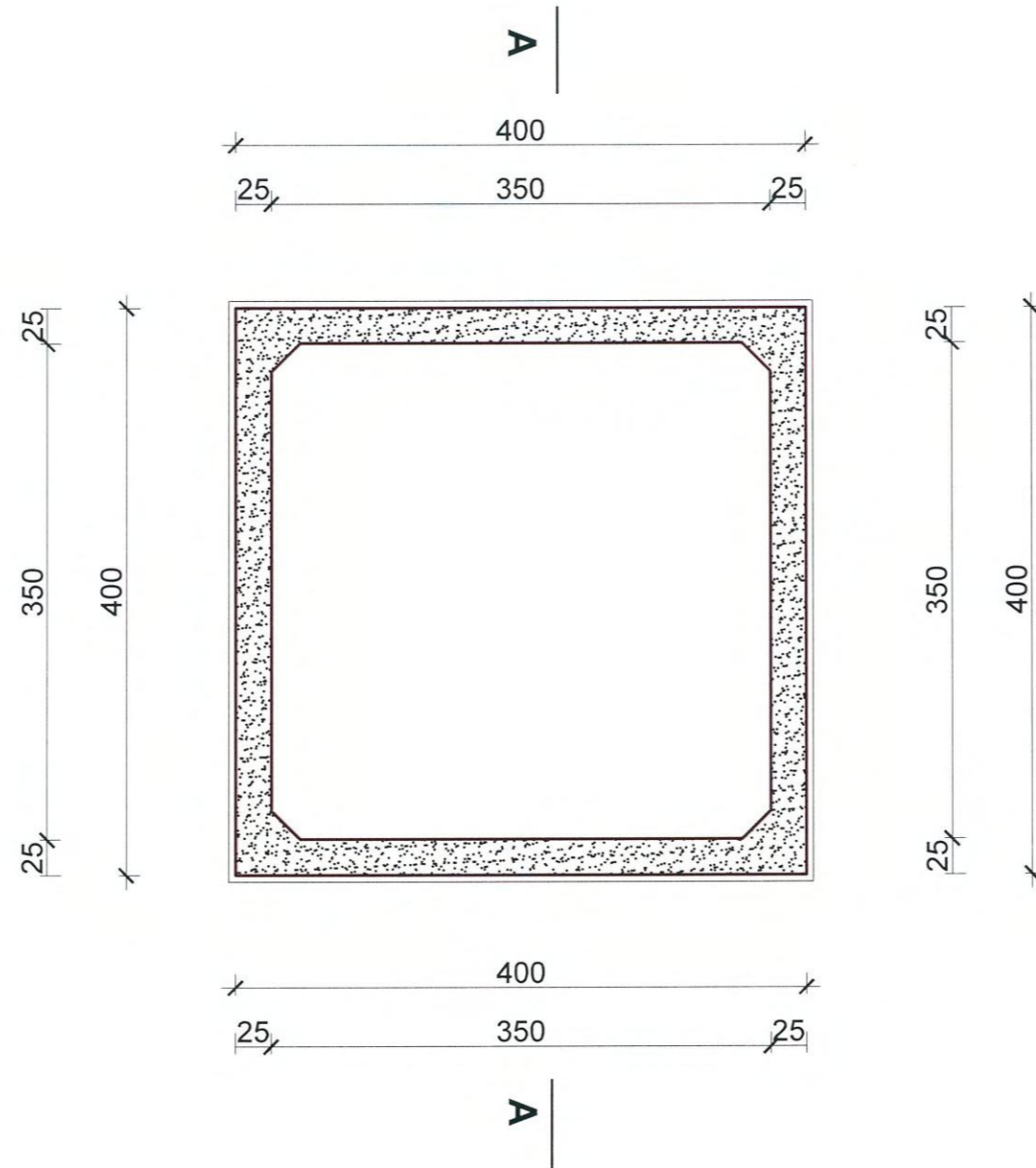
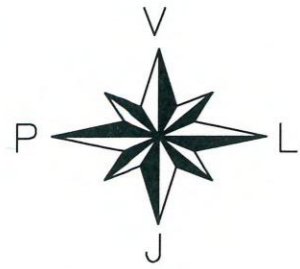

Emertimi i Projektit:		Emertimi i Fletes:		Projektoi:		Kapitulli:	Projekt Zbatimi
Rikonstruksioni dhe rehabilitimi i rrugeve te varrezave te vjetra, lagjia Kaluç dhe pallati katerkatesh		Planimetria e Depos se Ujit		ADM: XHULJETA DURO		Nr. Fletes:	A - 40
						Data:	Janar 2023
Faza	Projekt Zbatimi	Shkalla:	1 : 1000				

RRUGA E VARREZAVE TE VJETRA

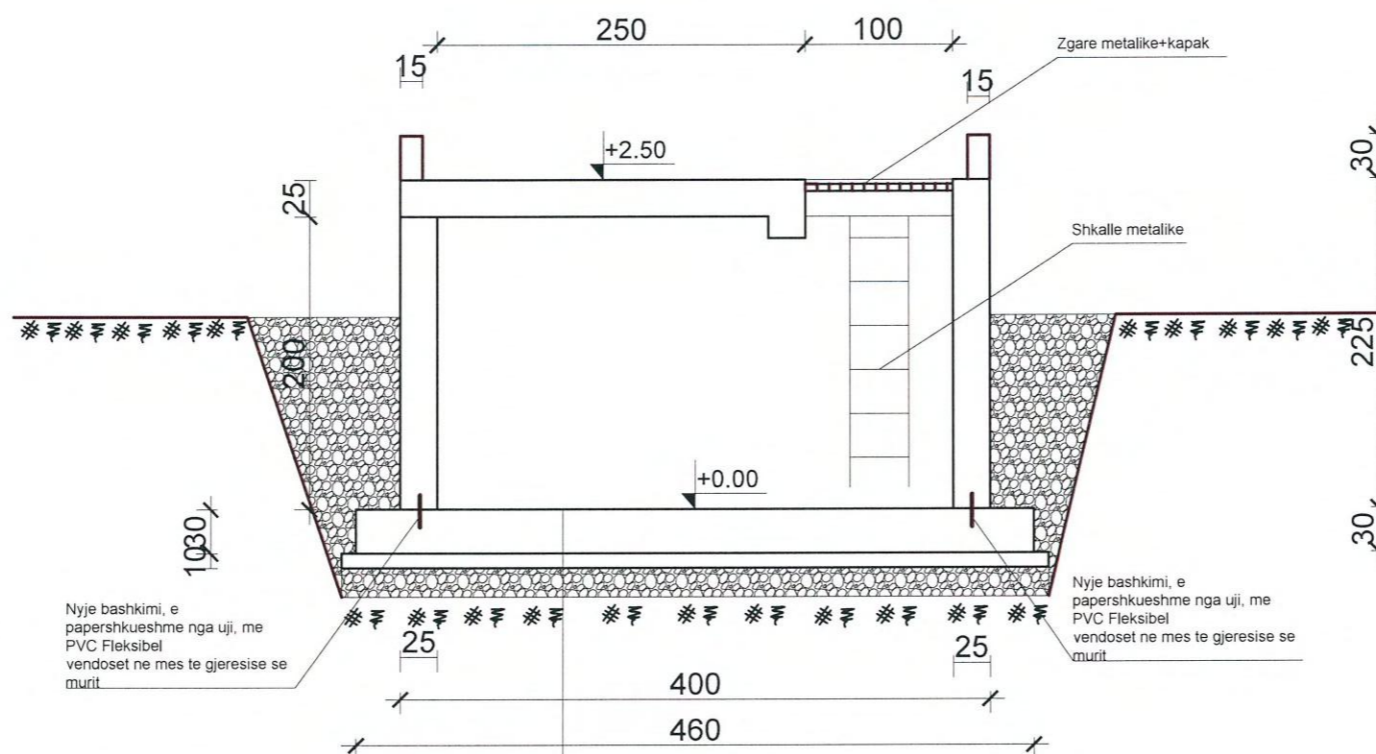
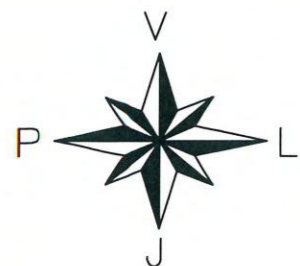

Beton me pjerresi 2% (min 4 cm)
 Beton arme i papaershkueshem nga uji C30/37, 30 cm
 Izolim me asfalt 2 cm
 Beton C12/15, 10 cm
 Zhavorr 20 cm



REPUBLIKA E SHQIPËRISË
BASHKIA E POLIÇAN



Emertimi i Projektit:		Emertimi i Fletes:		Projektoi:	Kapitulli:	Projekt Zbatimi
Rikonstruksioni dhe rehabilitimi i rrugeve te varrezave te vjetra, lagjia Kaluç dhe pallati katerkatesh		Depos se Ujit Prerje Terthore		"XH & MILLER" SHPK	Nr. Fletes:	A - 41
Faza	Projekt Zbatimi	Shkalla:	1 : 1000	ADM: XHULJETA DURO	Data:	Janar 2023



RRUGA E VARREZAVE TE VJETRA

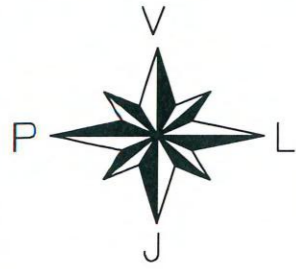

Hekurat Posht

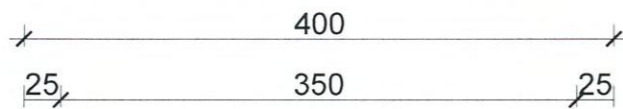
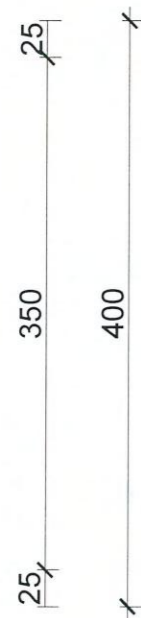
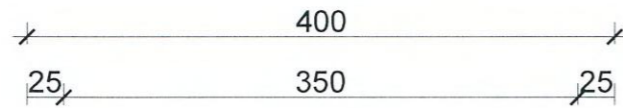

Hekurat Lart

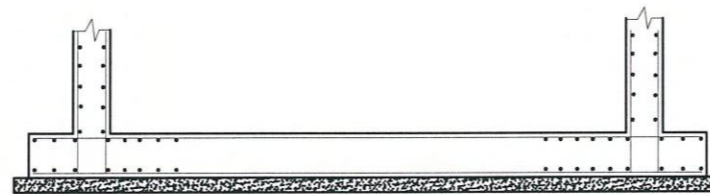
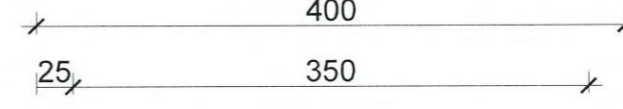
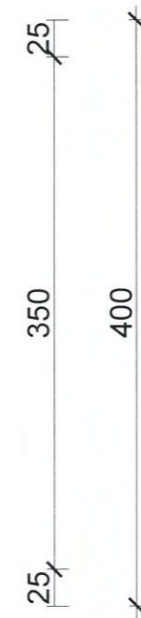
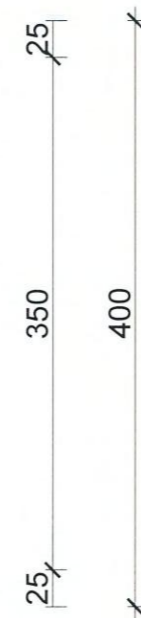
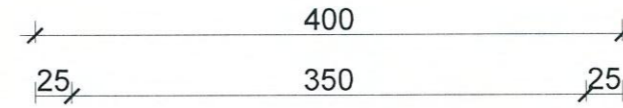

Emertimi i Projektit:	
Rikonstruksioni dhe rehabilitimi i rrugëve te varrezave te vjetra, lagjia Kaluç dhe pallati katerkatesh	
Faza	Projekt Zbatimi

Emertimi i Fletes:	
Armimi i Dyshemese te Depos se Ujit	
Shkalla:	1 : 1000

Projekttoi:	"XH & MILLER" SHPK
ADM:	XHULJETA DURO



Kapitulli:	Projekt Zbatimi
Nr. Fletes:	A - 42
Data:	Janar 2023

RRUGA E VARREZAVE TE VJETRA

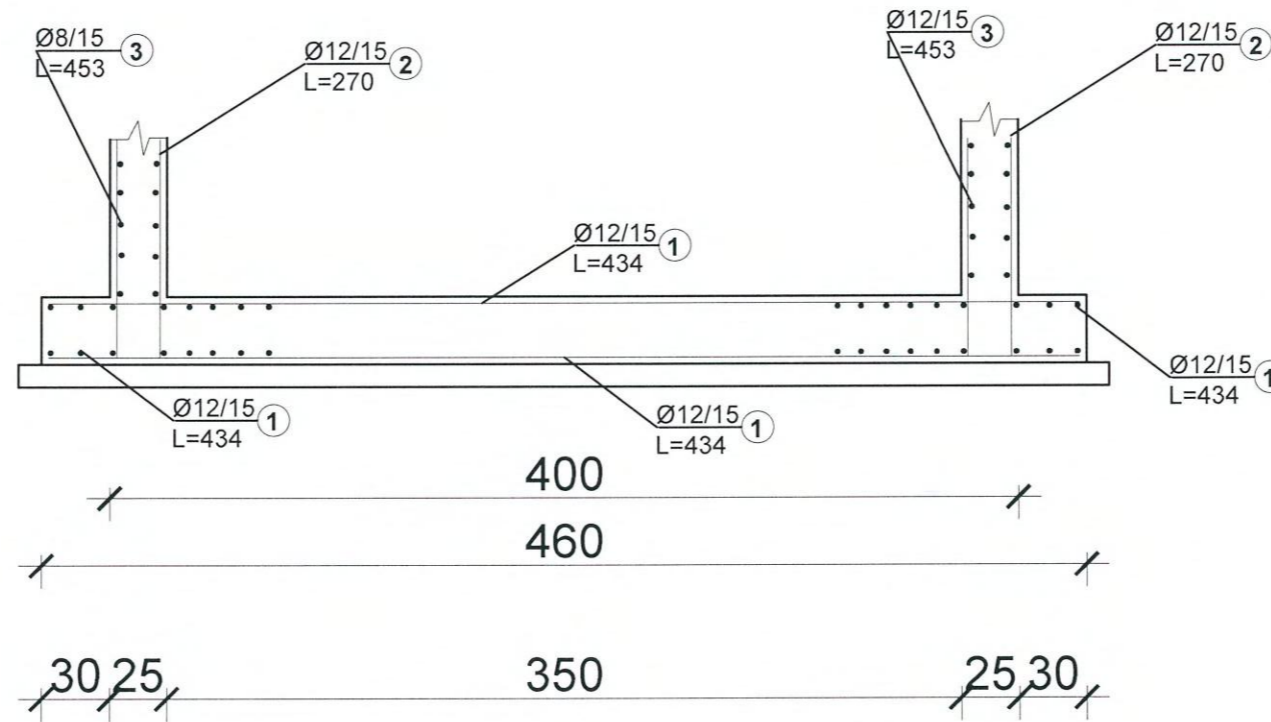
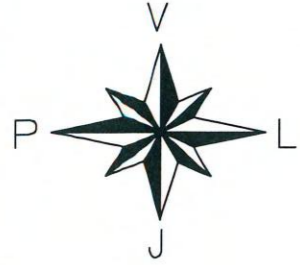

REPUBLIKA E SHQIPËRISË
BASHKIA E POLIÇAN



Emertimi i Projektit:	
Rikonstruksioni dhe rehabilitimi i rrugeve te varrezave te vjetra, lagjia Kaluç dhe pallati katerkatesh	
Faza	Projekt Zbatimi

Emertimi i Fletes:	
Armimi i Dyshemesë te Depos së Ujit	
Shkalla:	1 : 1000

Projekttoi:	"XH & MILLER" SHPK
ADM:	XHULJETA DÛRO



Kapitulli:	Projekt Zbatimi
Nr. Fletes:	A - 43
Data:	Janar 2023

RRUGA E VARREZAVE TE VJETRA

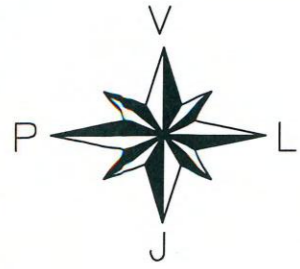

Armimi i mureve

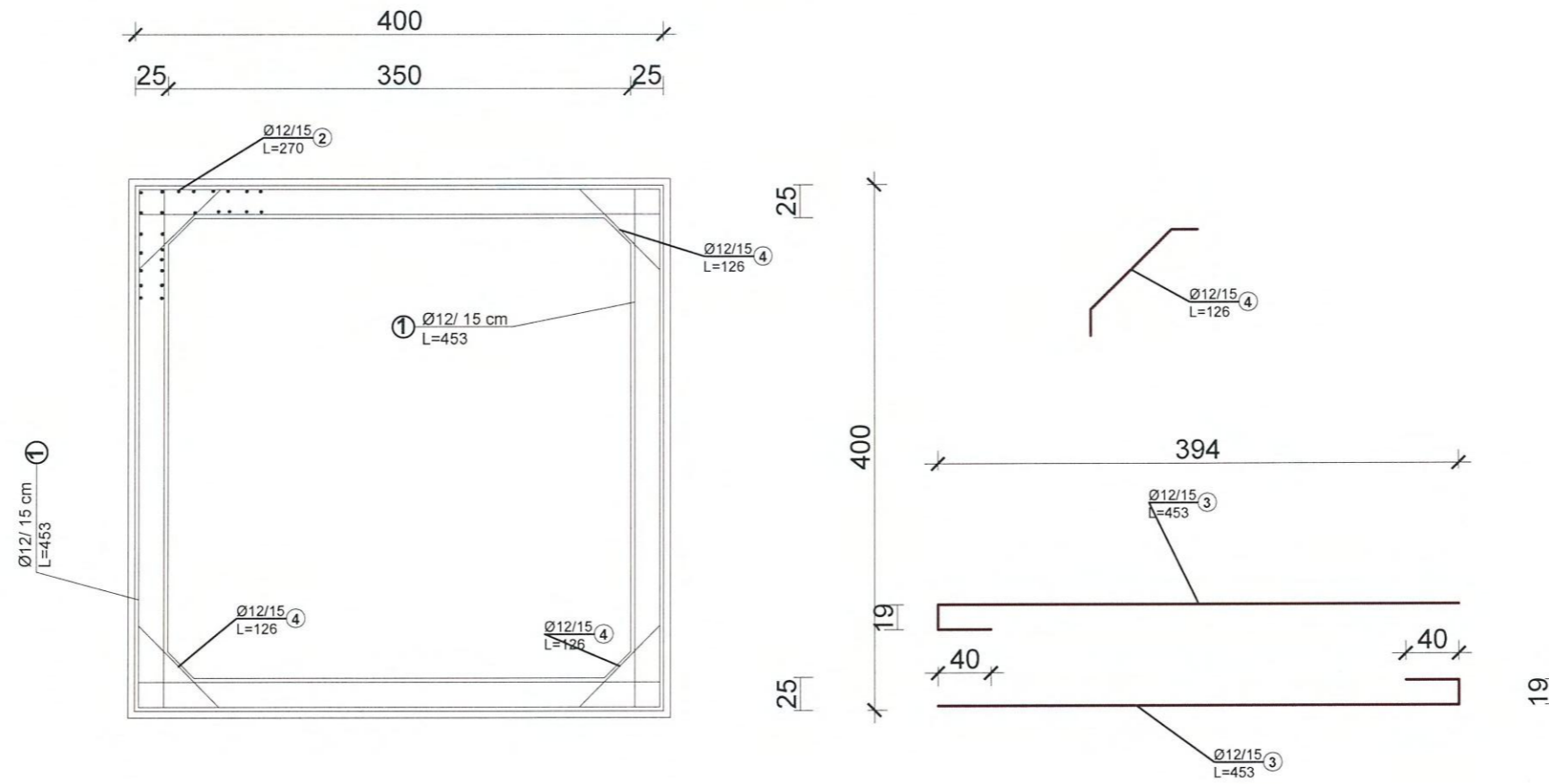

Emertimi i Projektit:	
Rikonstruksioni dhe rehabilitimi i rrugeve te varrezave te vjetra, lagjia Kaluç dhe pallati katerkatesh	
Faza	Projekt Zbatimi

Emertimi i Fletes:	
Armim i Mureve te depos se Ujit	
Shkalla:	1 : 1000

Projektoi:	"XH & MILLER" SHPK
ADM:	XHULJETA DÛRO

Kapitulli:	Projekt Zbatimi
Nr. Fletes:	A - 44
Data:	Janar 2023

