

PROFILI TERTHOR

CS - 41
PROG - 0+800.0

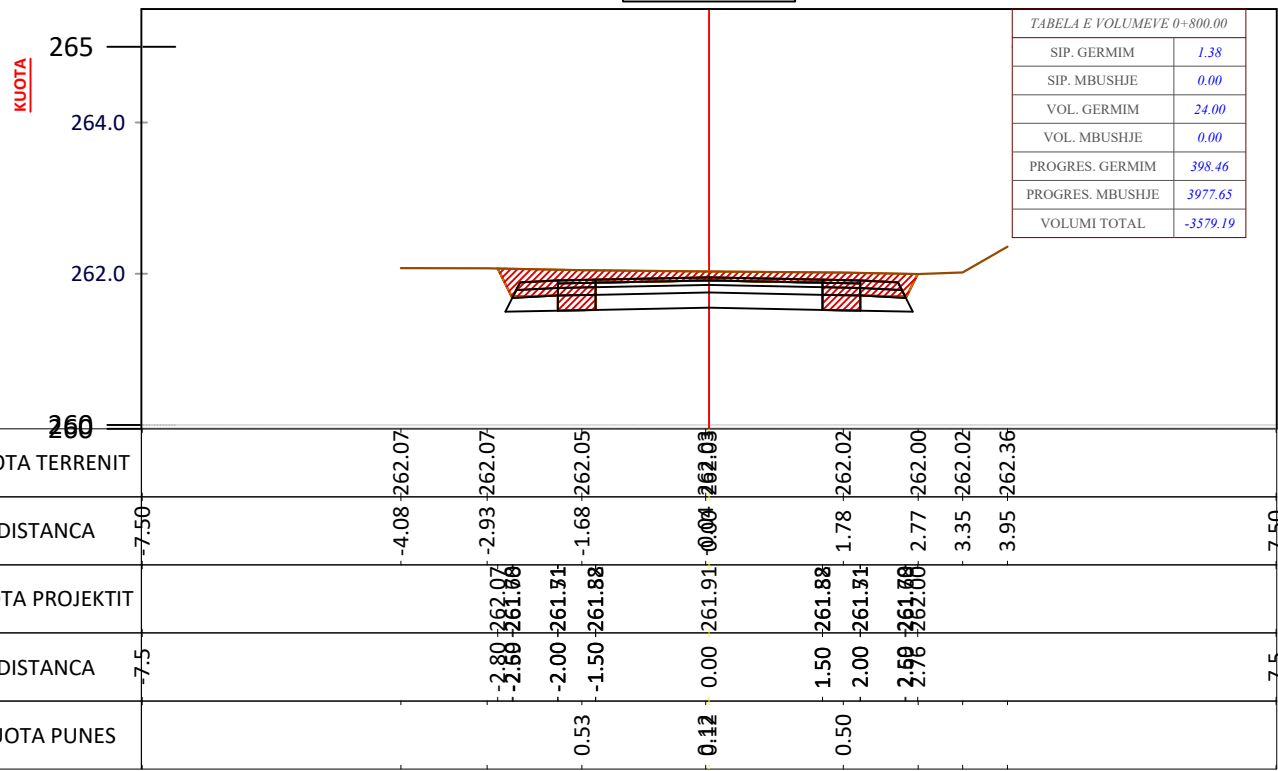

CS - 43
PROG - 0+840.0

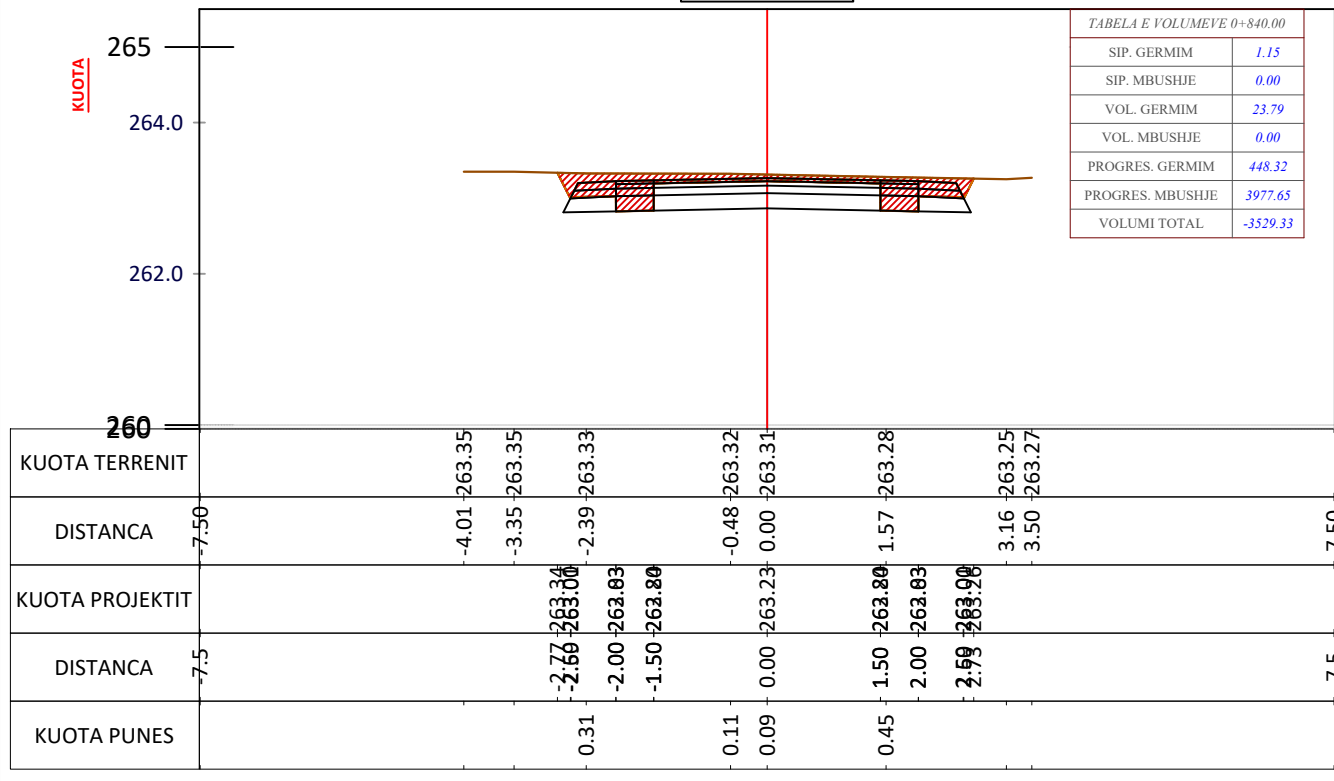

CS - 42
PROG - 0+820.0

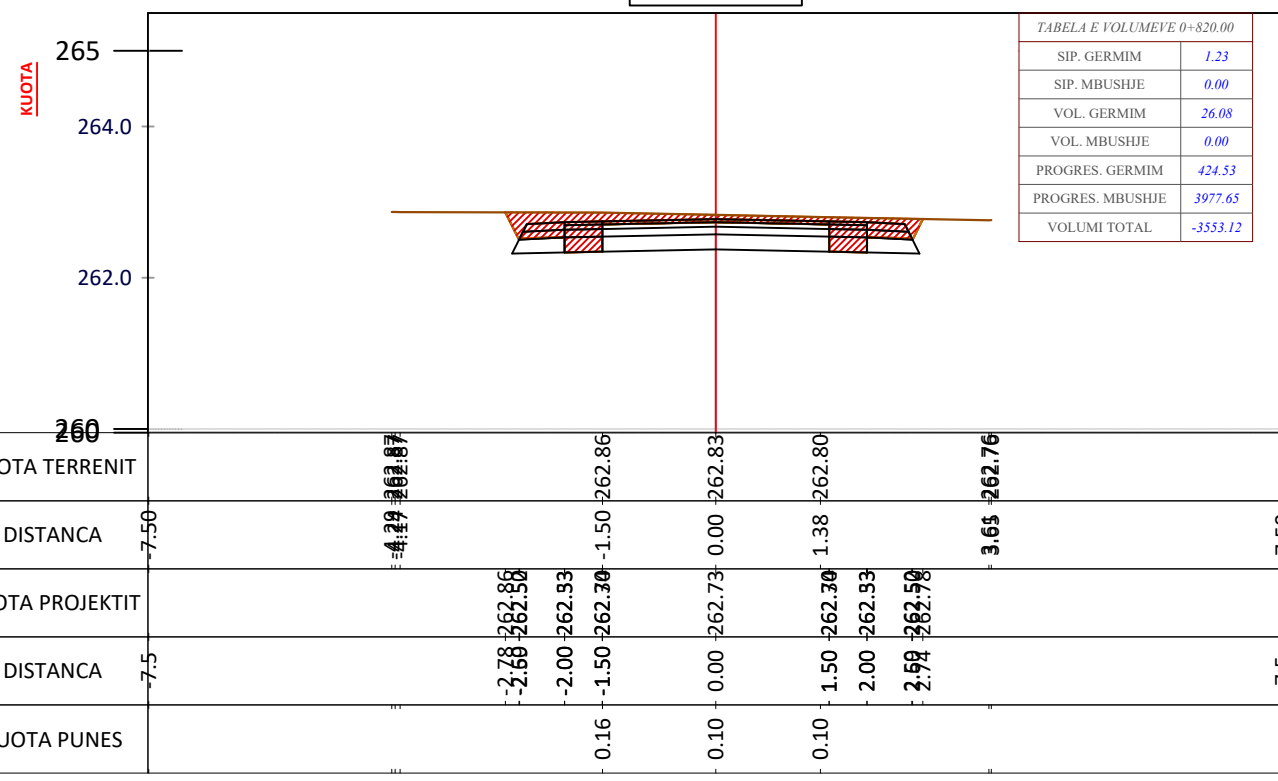

CS - 44
PROG - 0+860.0

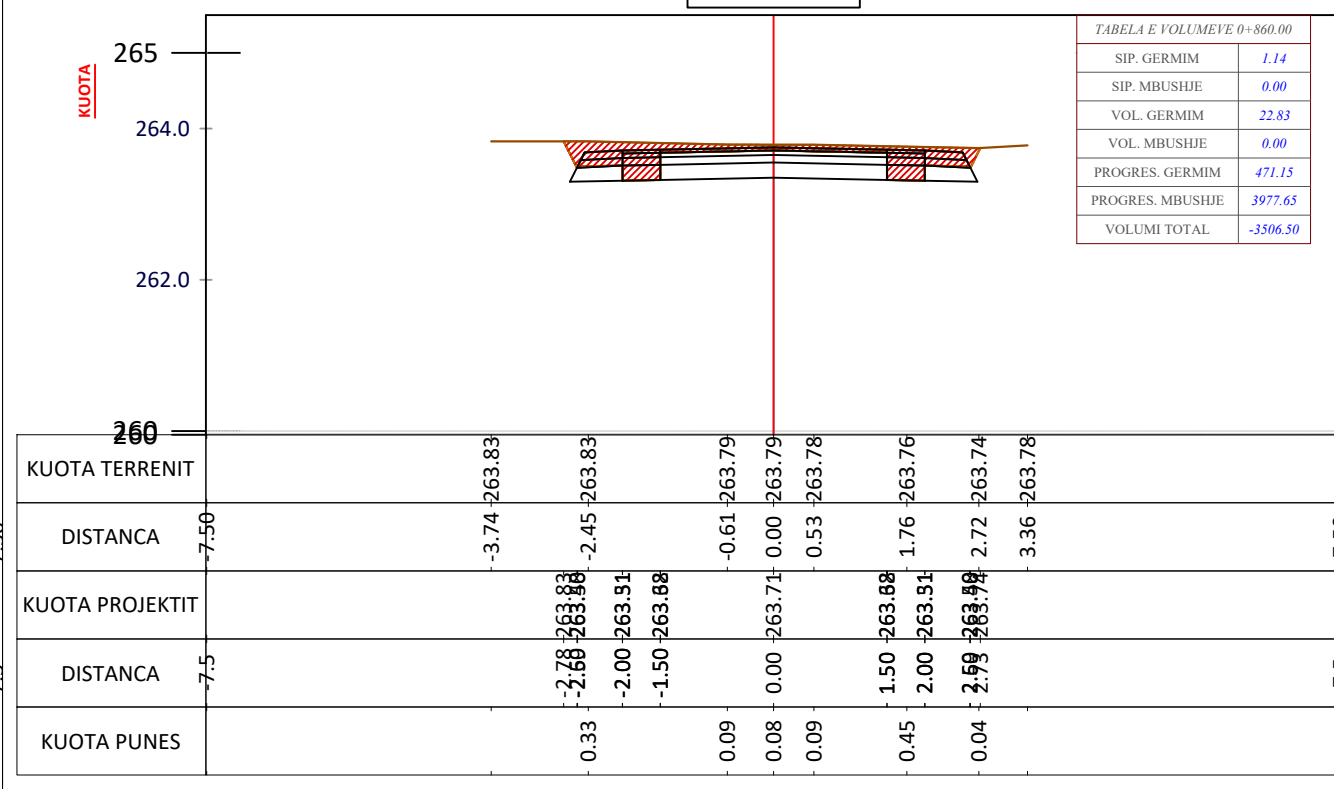

Porositës:
**BASHKIA MALËSI
E MADHE**

Titulli i Projektit
**SISTEMIMI ASFALTIM RRUGA
DEGEZIM I RRUGES
KOPLIK-RAZEM PER TEK RRUGA
E REÇIT**

Faza
PROJEKT ZBATIMI

Vula
Autor
"NOVATECH STUDIO" SHPK

ADMIN ING. EMIL NOVA

Grupi projektimit:
ING. NDERTIMI MIMOZA TOMCO
ARKITEKT GERTA NOVA
ING. HIDROTEKNIK KLODJAN NDOJ
ING. HIDROTEKNIK KOSTANDIN NOVA
ING. GJEOLOGJIK ANTONELA BAZHDARI
ING. NDERTIMI PETRIKA DOKU

Kapitulli
PROJEKT ARKITEKTONIK

Titulli i Vizatimit
PROFILI TERTHOR

Realizuar **DHJETOR 2022** Shkalla **1:100**

Emërtimi i Fletës
A 1 - 54

PROFILI TERTHOR

CS - 45
PROG - 0+880.0

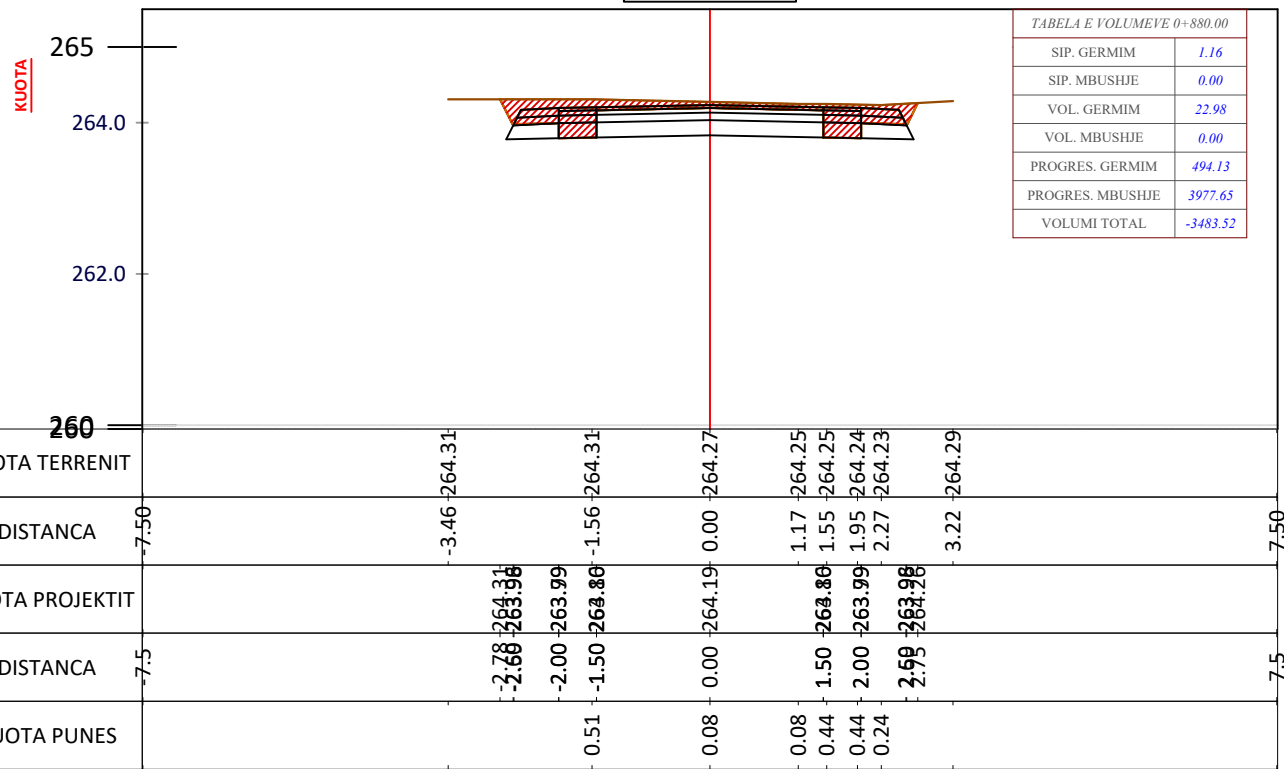

CS - 47
PROG - 0+920.0

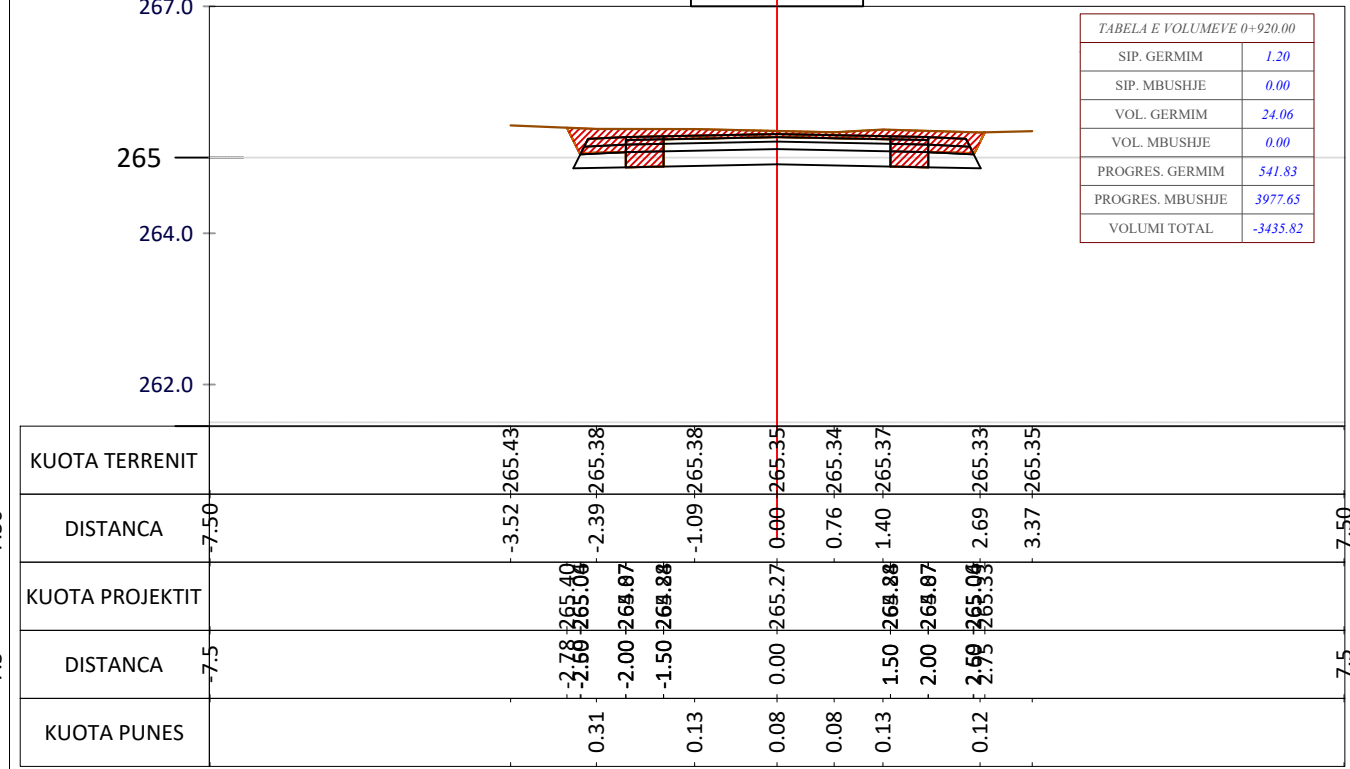

CS - 46
PROG - 0+900.0

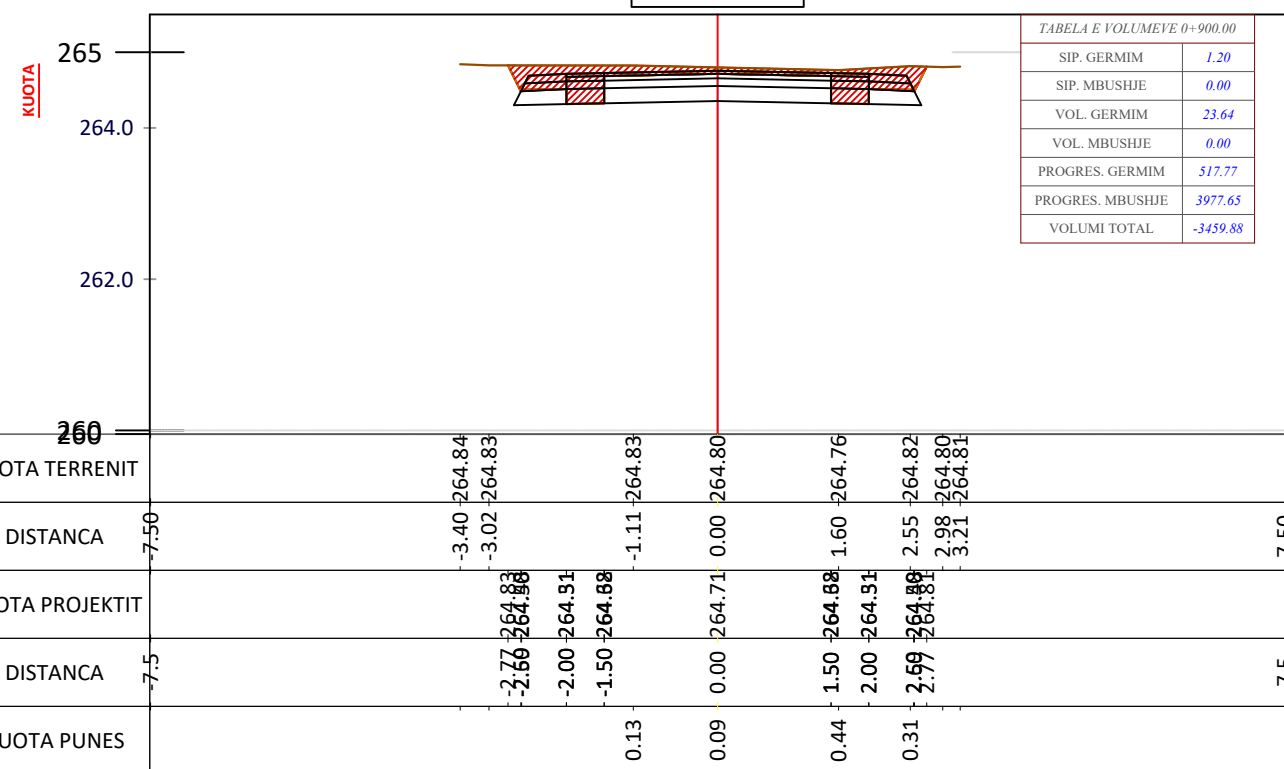

CS - 48
PROG - 0+940.0

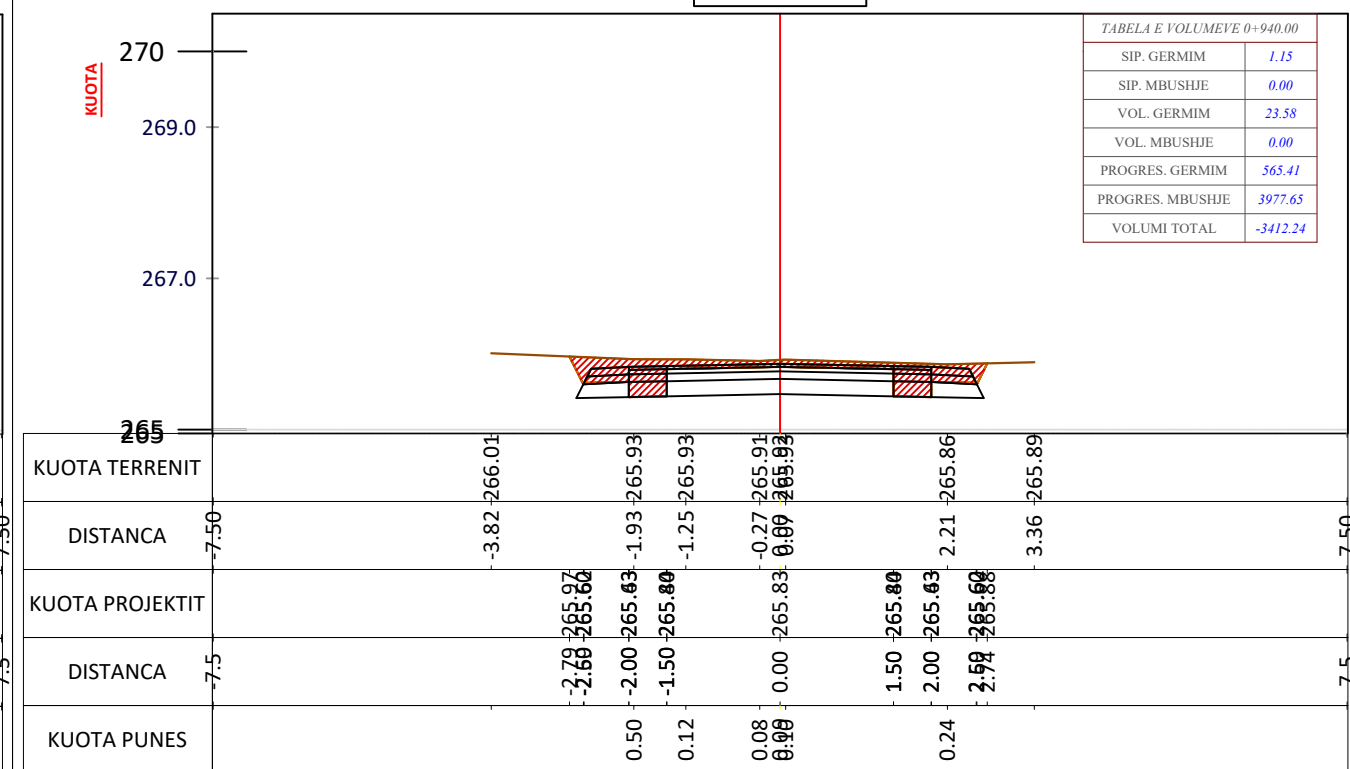

Porositës:

BASHKIA MALËSI
E MADHE

Titulli i Projektit

SISTEMIMI ASFALTIM RRUGA
DEGEZIM I RRUGES
KOPLIK-RAZEM PER TEK RRUGA
E REÇIT

Faza

PROJEKT ZBATIMI

Vula

Autor "NOVATECH STUDIO" SHPK



Grupi projektimit:

ING. NDERTIMI MIMOZA TOMCO
ARKITEKT GERTA NOVA
ING. HIDROTEKNIK KLODJAN NDOJ
ING. HIDROTEKNIK KOSTANDIN NOVA
ING. GJEOLOGJIK ANTONELA BAZHDARI
ING. NDERTIMI PETRIKA DOKU

Vula

Kapitulli

PROJEKT ARKITEKTONIK

Titulli i Vizatimit

PROFILI TERTHOR

Realizuar DHJETOR 2022 Shkalla 1:100

Emërtimi i Fletës

A 1 - 55

PROFILI TERTHOR

CS - 49
PROG - 0+960.0



TABELA E VOLUMEVE 0+960.00	
SIP. GERMIM	1.25
SIP. MBUSHJE	0.00
VOL. GERMIM	24.02
VOL. MBUSHJE	0.00
PROGRES. GERMIM	589.43
PROGRES. MBUSHJE	3977.65
VOLUMI TOTAL	-3388.22

CS - 51
PROG - 1+000.0

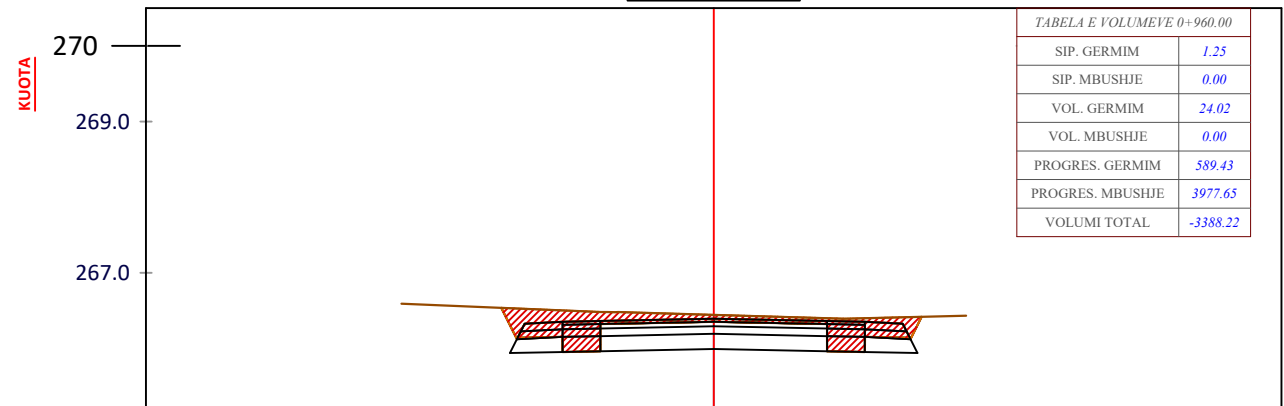

TABELA E VOLUMEVE 1+000.00	
SIP. GERMIM	1.09
SIP. MBUSHJE	0.00
VOL. GERMIM	16.58
VOL. MBUSHJE	1.44
PROGRES. GERMIM	624.19
PROGRES. MBUSHJE	3980.52
VOLUMI TOTAL	-3356.33

CS - 50
PROG - 0+980.0

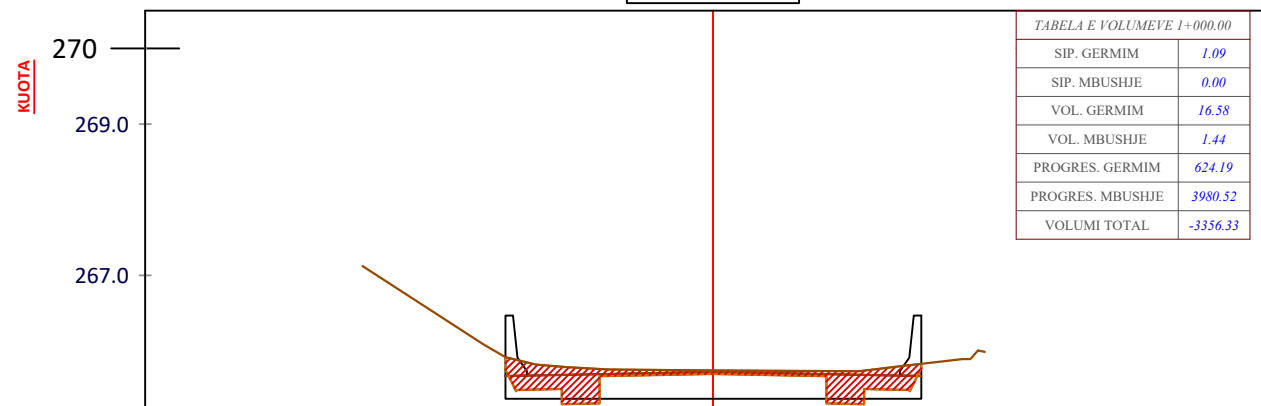

TABELA E VOLUMEVE 0+980.00	
SIP. GERMIM	0.57
SIP. MBUSHJE	0.14
VOL. GERMIM	18.18
VOL. MBUSHJE	1.44
PROGRES. GERMIM	607.61
PROGRES. MBUSHJE	3979.09
VOLUMI TOTAL	-3371.47

CS - 52
PROG - 1+020.0

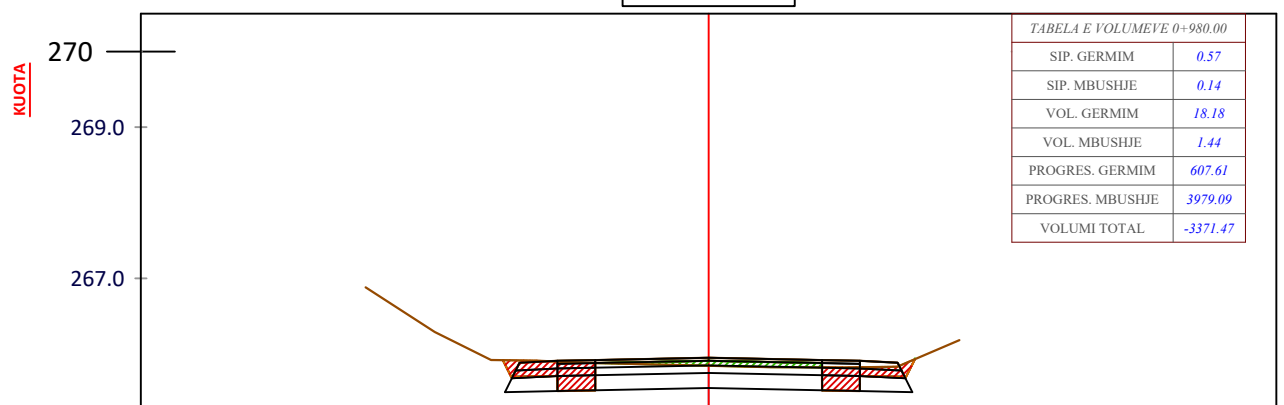

TABELA E VOLUMEVE 1+020.00	
SIP. GERMIM	1.79
SIP. MBUSHJE	0.00
VOL. GERMIM	28.76
VOL. MBUSHJE	0.00
PROGRES. GERMIM	652.95
PROGRES. MBUSHJE	3980.52
VOLUMI TOTAL	-3327.58

Porositës:
**BASHKIA MALËSI
E MADHE**

Titulli i Projektit
**SISTEMIMI ASFALTIM RRUGA
DEGEZIM I RRUGES
KOPLIK-RAZEM PER TEK RRUGA
E REÇIT**

Faza
PROJEKT ZBATIMI

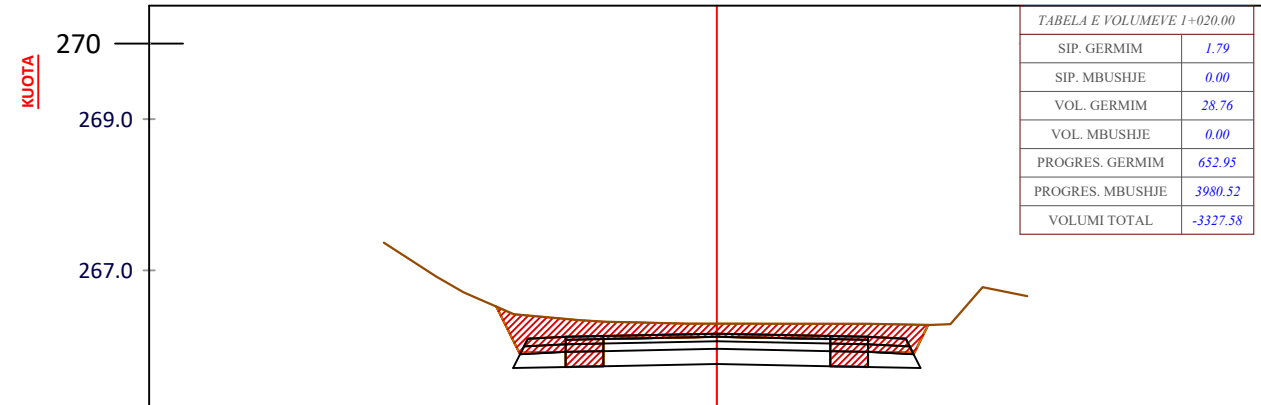
Vula
Autor
"NOVATECH STUDIO" SHPK

ADMIN ING. EMIL NOVA

Grupi projektimit:
ING. NDERTIMI Mimoza TOMCO
ARKITEKT Gerta NOVA
ING. HIDROTEKNIK Klodjan NDOJ
ING. HIDROTEKNIK Kostandin NOVA
ING. GJEOLOGJIK Antonela BAZHDARI
ING. NDERTIMI Petrika DOKU

Kapitulli
PROJEKT ARKITEKTONIK

Titulli i Vizatimit
PROFILI TERTHOR

Realizuar **DHJETOR 2022** Shkalla **1:100**

Emërtimi i Fletës
A 1 - 56

PROFILI TERTHOR

CS - 53
PROG - 1+040.0



TABELA E VOLUMEVE 1+040.00	
SIP. GERMIM	1.30
SIP. MBUSHJE	0.00
VOL. GERMIM	30.88
VOL. MBUSHJE	0.00
PROGRES. GERMIM	683.83
PROGRES. MBUSHJE	3980.52
VOLUMI TOTAL	-3296.69

CS - 55
PROG - 1+080.0

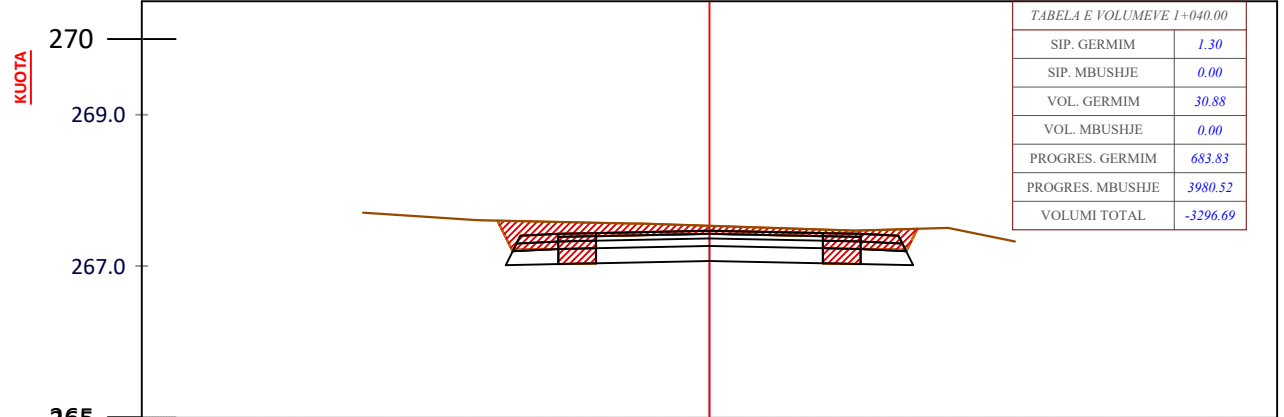

TABELA E VOLUMEVE 1+080.00	
SIP. GERMIM	1.31
SIP. MBUSHJE	0.00
VOL. GERMIM	26.29
VOL. MBUSHJE	0.00
PROGRES. GERMIM	736.25
PROGRES. MBUSHJE	3980.52
VOLUMI TOTAL	-3244.27

CS - 54
PROG - 1+060.0

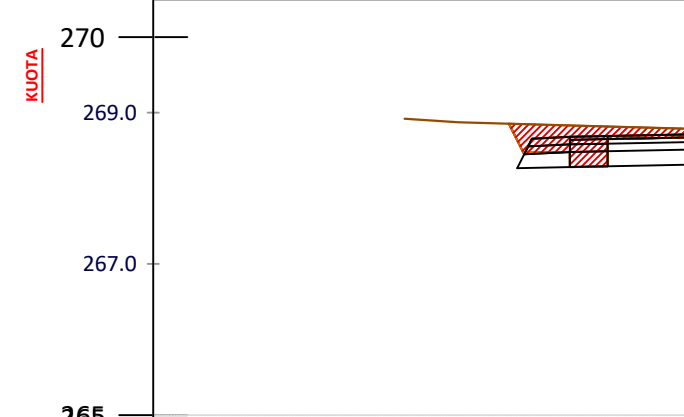

TABELA E VOLUMEVE 1+060.00	
SIP. GERMIM	1.31
SIP. MBUSHJE	0.00
VOL. GERMIM	26.14
VOL. MBUSHJE	0.00
PROGRES. GERMIM	709.96
PROGRES. MBUSHJE	3980.52
VOLUMI TOTAL	-3270.56

CS - 56
PROG - 1+100.0

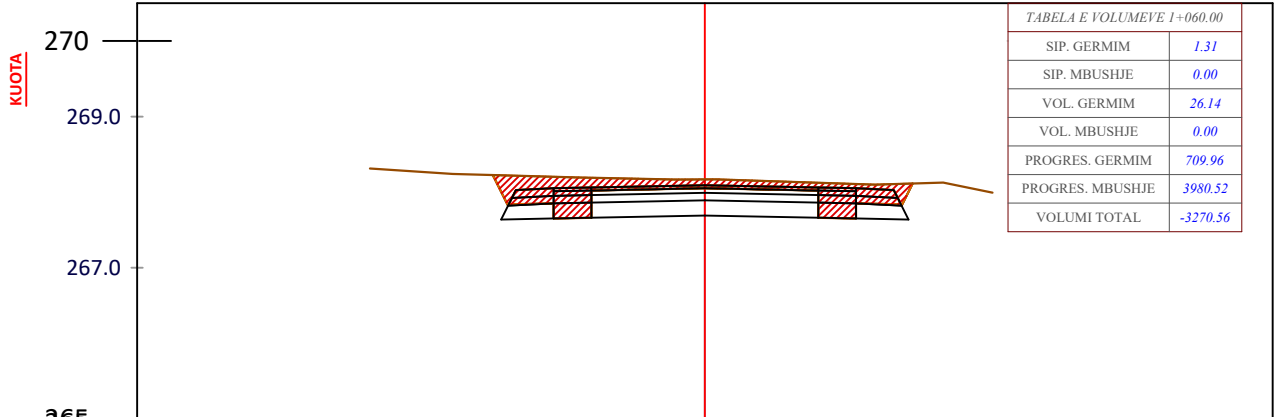

TABELA E VOLUMEVE 1+100.00	
SIP. GERMIM	1.28
SIP. MBUSHJE	0.00
VOL. GERMIM	25.94
VOL. MBUSHJE	0.00
PROGRES. GERMIM	762.19
PROGRES. MBUSHJE	3980.52
VOLUMI TOTAL	-3218.33

KUOTA TERRENIT	265	267.70	267.61	267.60	267.56	267.53	267.47	267.50	267.32	265
DISTANCA	7.50	4.58	3.10	2.77	1.91	0.00	1.93	3.16	4.04	7.50
KUOTA PROJEKTIT	265	267.60	267.59	267.52	267.49	267.42	267.40	267.49	267.50	265
DISTANCA	7.5	4.58	2.80	2.00	1.50	0.00	2.00	2.59	3.16	7.5
KUOTA PUNES			0.07		0.16	0.11	0.44			

KUOTA TERRENIT	265	268.92	268.87	268.84	268.79	268.78	268.78	268.73	268.67	265
DISTANCA	7.50	4.18	3.48	2.23	0.50	0.00	0.34	1.31	2.66	7.50
KUOTA PROJEKTIT	265	268.45	268.45	268.48	268.68	268.77	268.89	268.88	268.73	265
DISTANCA	7.5	4.18	2.80	2.00	1.50	0.00	1.50	2.00	2.59	7.5
KUOTA PUNES			0.36		0.12	0.10	0.10	0.12	0.16	

KUOTA TERRENIT	265	268.31	268.24	268.22	268.19	268.17	268.10	268.13	267.99	265
DISTANCA	7.50	4.43	3.34	2.64	1.68	0.39	2.25	3.15	3.80	7.50
KUOTA PROJEKTIT	265	268.23	268.18	268.15	268.08	268.05	268.08	268.12	268.12	265
DISTANCA	7.5	4.43	2.80	2.00	1.50	0.00	1.50	2.00	2.59	7.5
KUOTA PUNES			0.32	0.54	0.12	0.12	0.25			

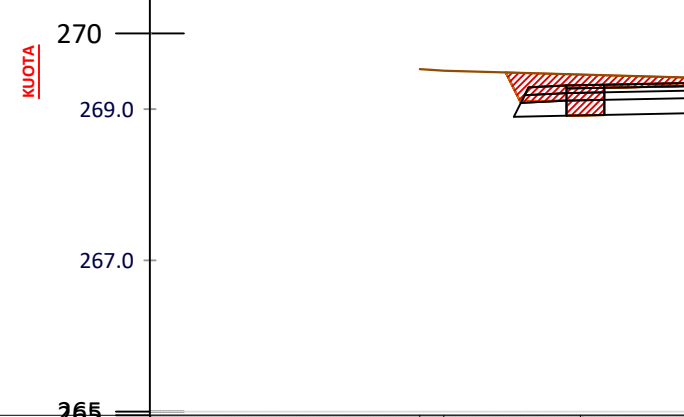
KUOTA TERRENIT	265	269.53	269.51	269.46	269.40	269.39	269.38	269.39	269.37	265
DISTANCA	7.50	3.94	3.62	1.82	0.00	0.69	1.06	2.47	3.07	7.50
KUOTA PROJEKTIT	265	269.08	269.08	269.11	269.31	269.39	269.38	269.39	269.37	265
DISTANCA	7.5	3.94	2.80	2.00	1.50	0.00	1.50	2.00	2.59	7.5
KUOTA PUNES			0.54		0.09	0.09	0.09	0.28		

Porositës:

**BASHKIA MALËSI
E MADHE**

Titulli i Projektit
SISTEMIMI ASFALTIM RRUGA
DEGEZIM I RRUGES
KOPLIK-RAZEM PER TEK RRUGA
E REÇIT

Faza
PROJEKT ZBATIMI

Vula

Autor
"NOVATECH STUDIO" SHPK

ADMIN ING. EMIL NOVA

Grupi projektimit:
ING. NDERTIMI MIMOZA TOMCO
ARKITEKT GERTA NOVA
ING. HIDROTEKNIK KLODJAN NDOJ
ING. HIDROTEKNIK KOSTANDIN NOVA
ING. GJEOLOGJIK ANTONELA BAZHDARI
ING. NDERTIMI PETRIKA DOKU

Kapitulli
PROJEKT ARKITEKTONIK

Titulli i Vizatimit
PROFILI TERTHOR

Realizuar **DHJETOR 2022** Shkalla **1:100**
Emërtimi i Fletës **A 1 - 57**

PROFILI TERTHOR

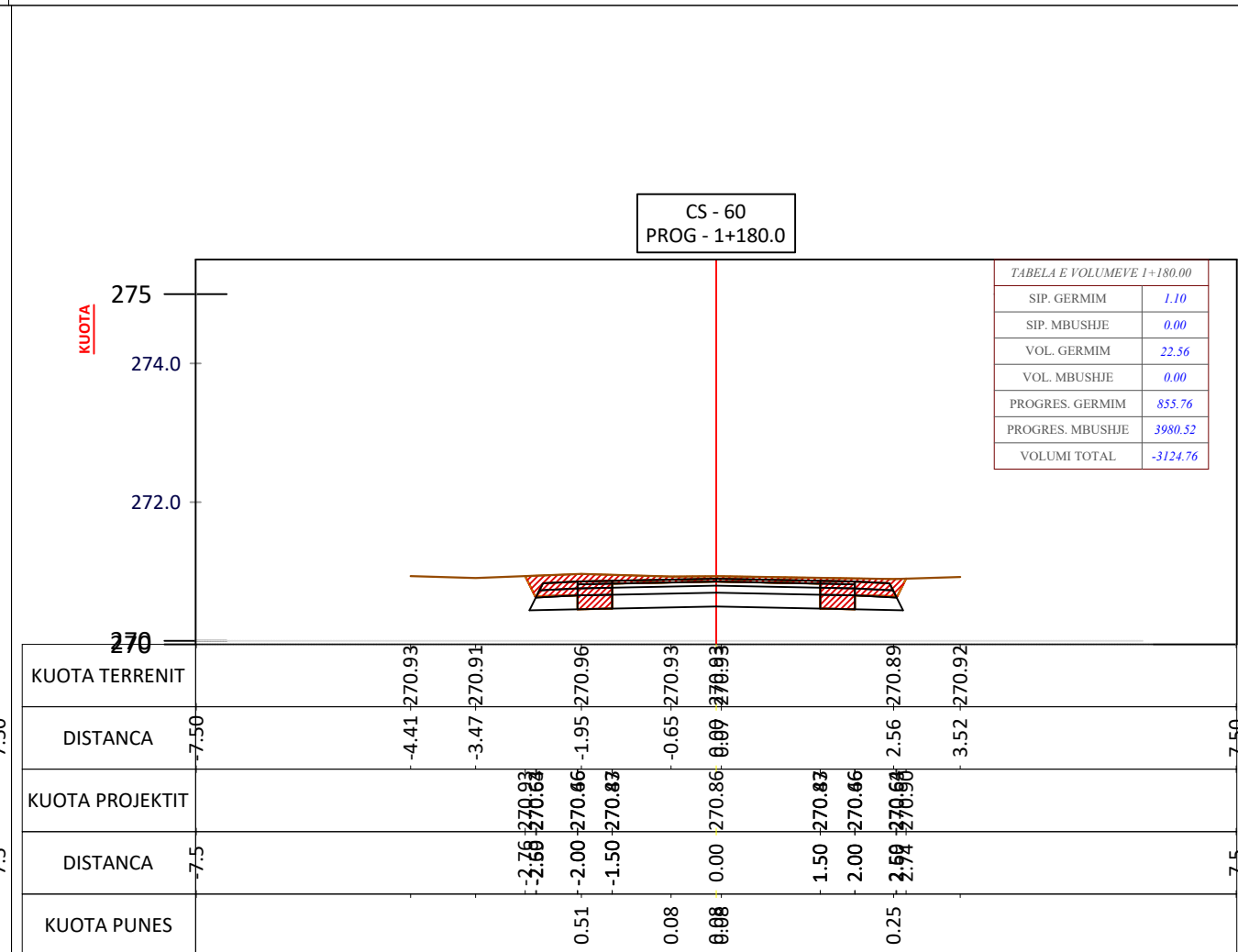
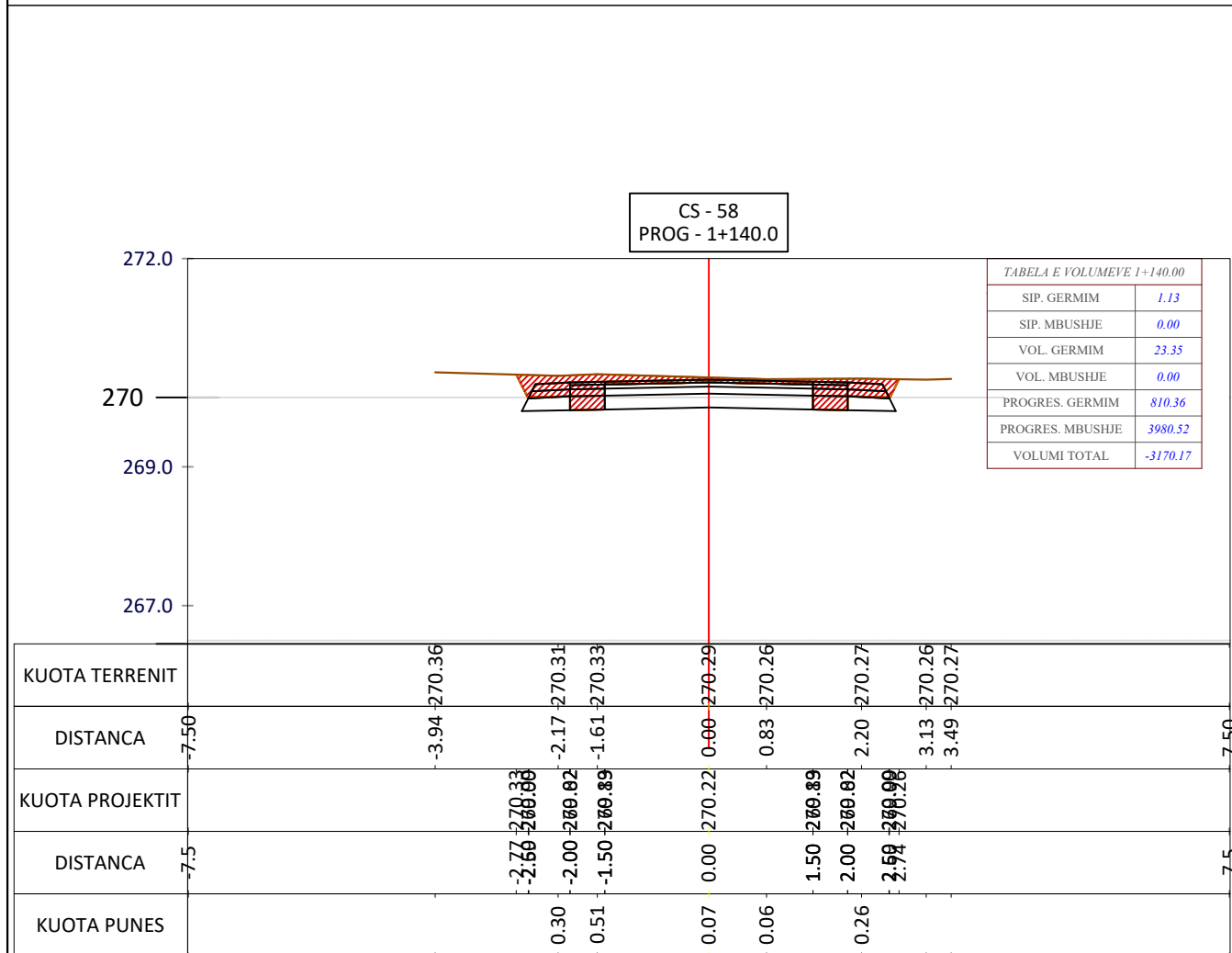
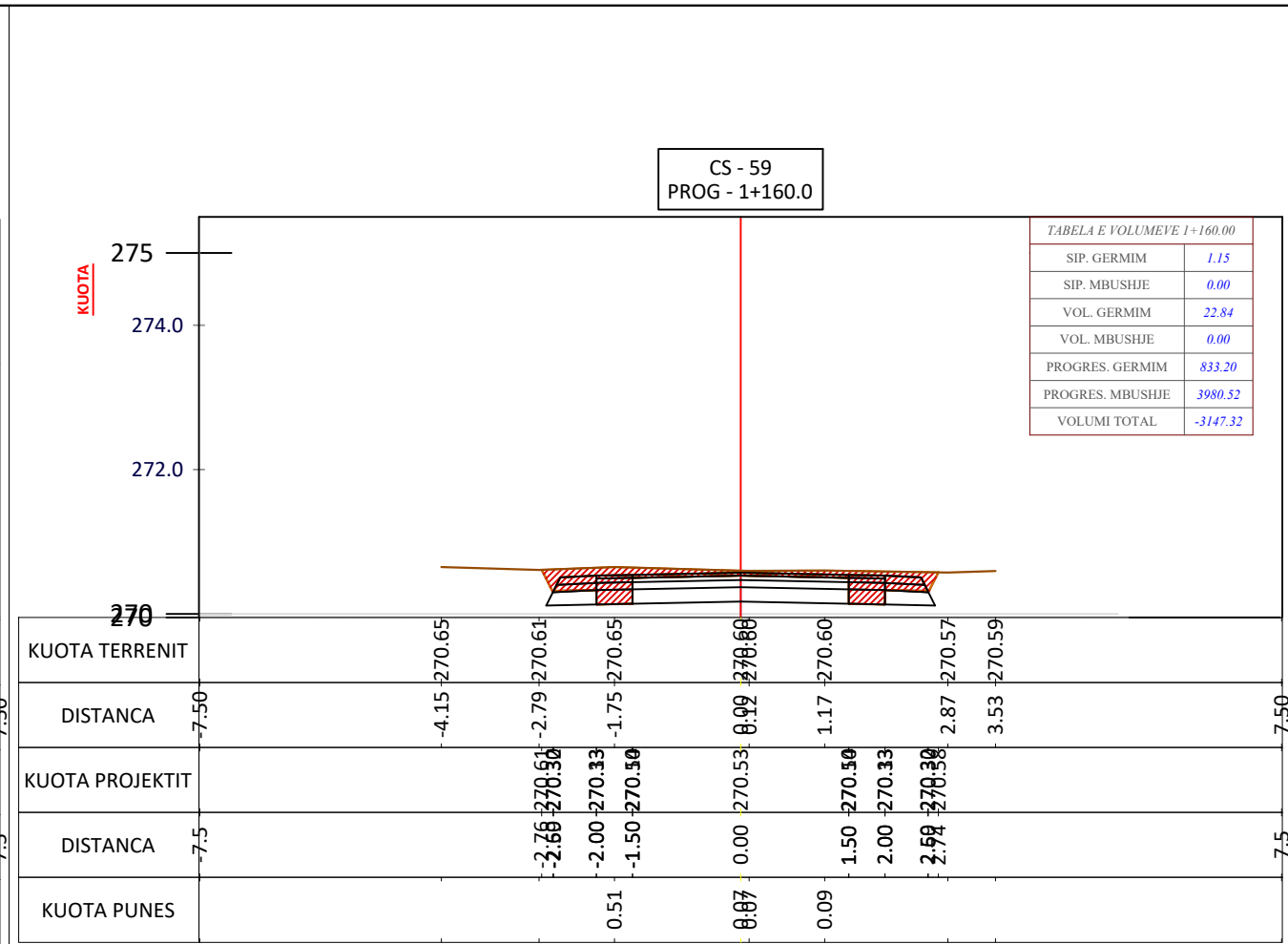
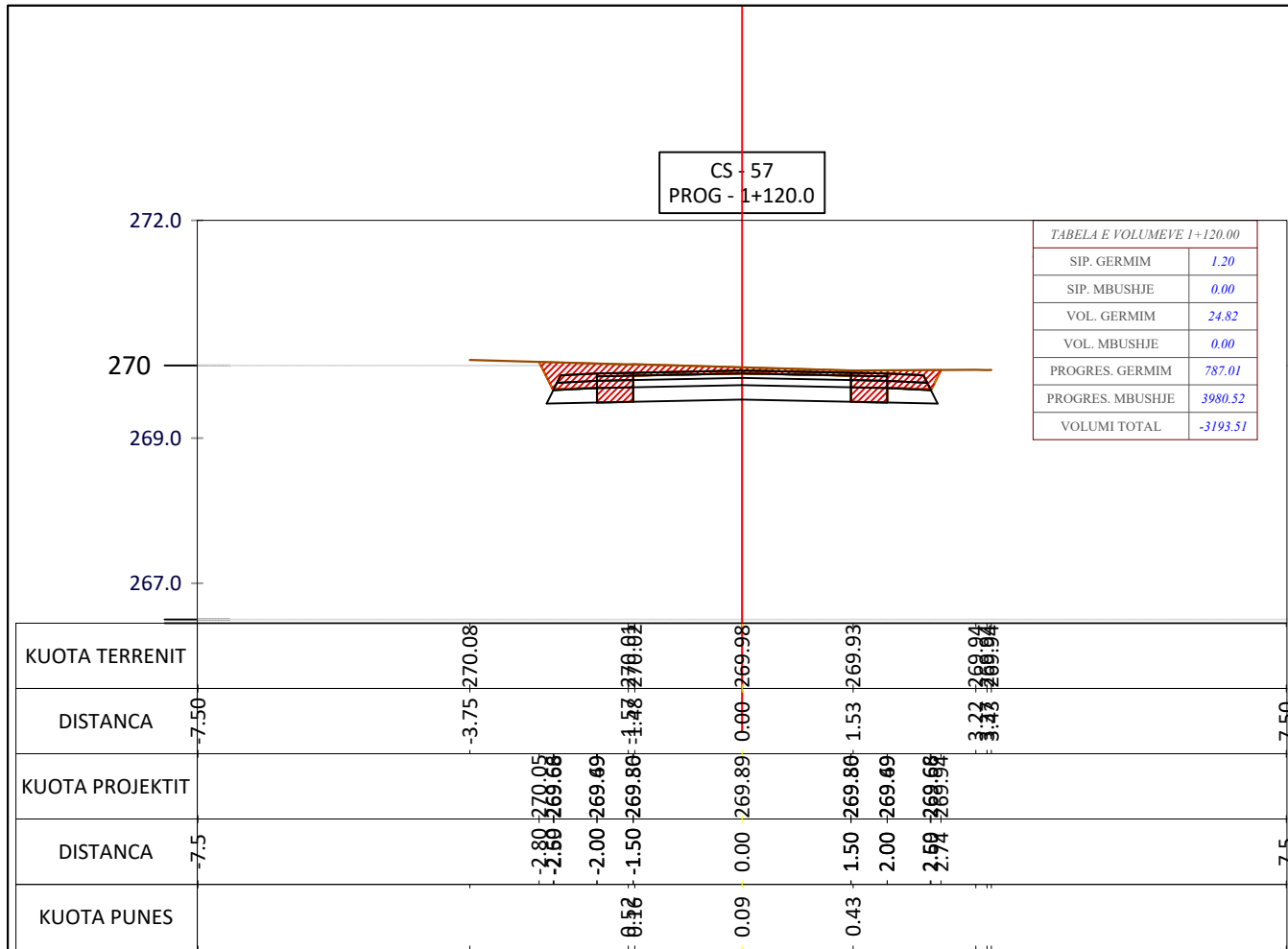

Porositës:

BASHKIA MALËSI
E MADHE

Titulli i Projektit

SISTEMIMI ASFALTIM RRUGA
DEGEZIM I RRUGES
KOPLIK-RAZEM PER TEK RRUGA
E REÇIT

Faza

PROJEKT ZBATIMI

Vula

Autor

"NOVATECH STUDIO" SHPK
ADMIN ING. EMIL NOVA

Grupi projektimit:

ING. NDERTIMI	Mimoza TOMCO
ARKITEKT	Gerta NOVA
ING. HIDROTEKNIK	Klodjan NDOJ
ING. HIDROTEKNIK	Kostandin NOVA
ING. GJEOLGIJK	Antonela BAZHDARI
ING. NDERTIMI	Petrika DOKU

Kapitulli

PROJEKT ARKITEKTONIK

Titulli i Vizatimit

PROFILI TERTHOR

Realizuar **DHJETOR 2022** Shkalla **1:100**

Emërtimi i Fletës

A 1 - 58

PROFILI TERTHOR

CS - 61
PROG - 1+200.0

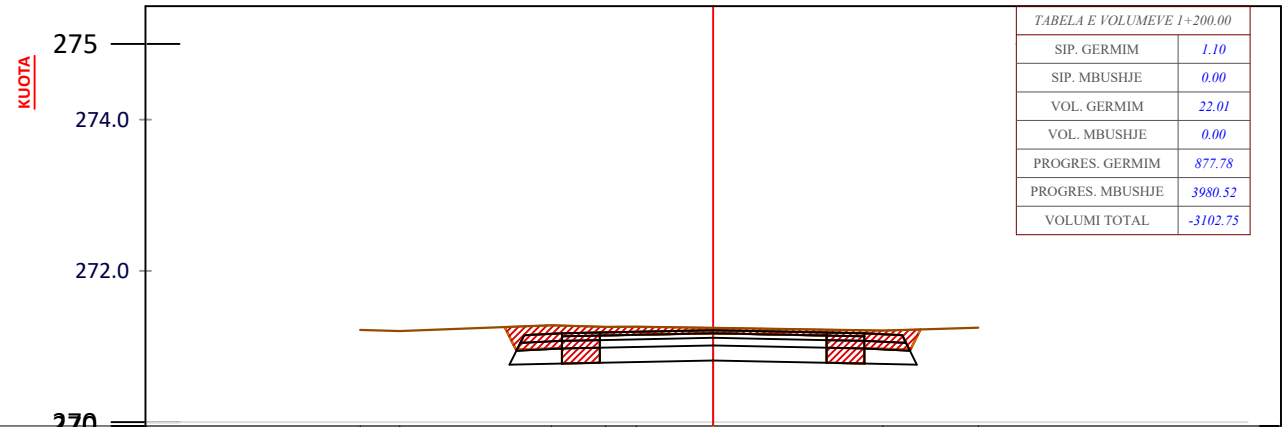

KUOTA TERRENIT	7.50	-4.67	271.22	-4.15	271.20	-2.14	271.28	-1.42	271.26	-1.02	271.26	0.00	271.25	2.25	271.21	3.51	271.25
DISTANCA	7.50																
KUOTA PROJEKTIT																	
DISTANCA	7.5																
KUOTA PUNES																	

CS - 63
PROG - 1+240.0

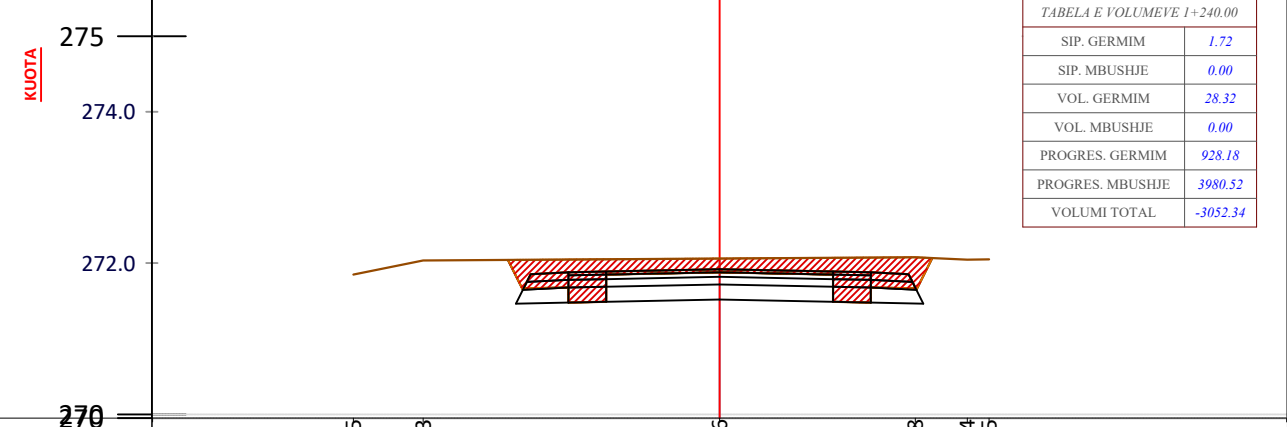

KUOTA TERRENIT	7.50	-4.85	271.85	-3.92	272.03	0.00	272.06	2.59	272.08	3.28	272.04	3.56	272.05
DISTANCA	7.50												
KUOTA PROJEKTIT													
DISTANCA	7.5												
KUOTA PUNES													

CS - 62
PROG - 1+220.0

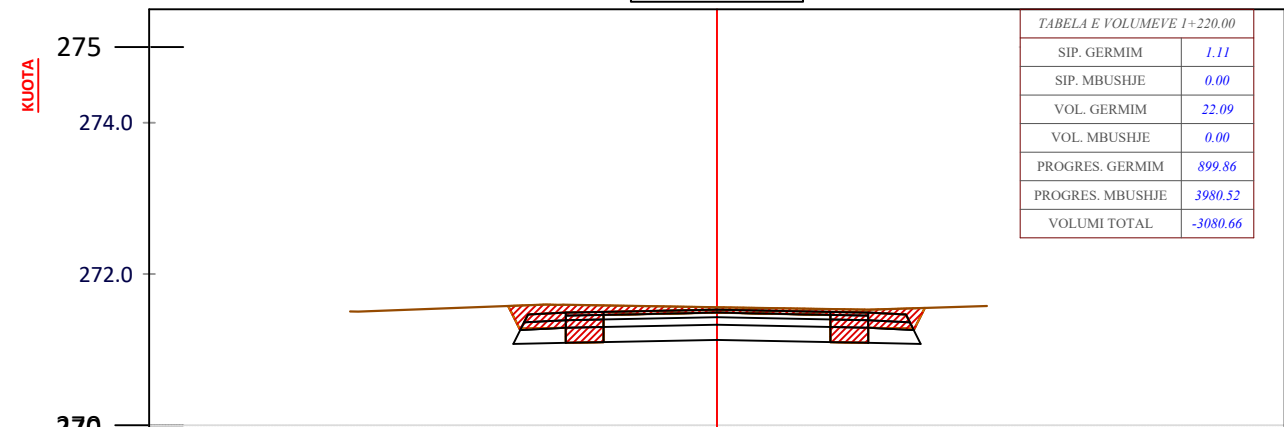

KUOTA TERRENIT	7.50	-4.95	271.56	-2.26	271.60	0.00	271.56	1.50	271.40	2.01	271.53	3.57	271.58
DISTANCA	7.50												
KUOTA PROJEKTIT													
DISTANCA	7.5												
KUOTA PUNES													

CS - 64
PROG - 1+260.0

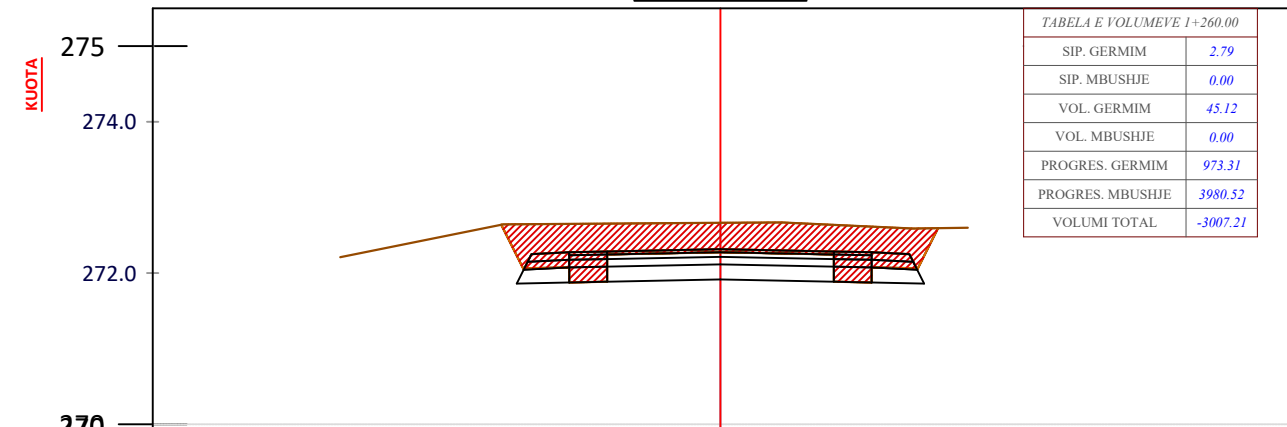

KUOTA TERRENIT	7.50	-5.03	272.21	-2.88	272.64	0.00	272.66	0.81	272.67	2.54	272.59	3.27	272.60
DISTANCA	7.50												
KUOTA PROJEKTIT													
DISTANCA	7.5												
KUOTA PUNES													

Porositës:
**BASHKIA MALËSI
E MADHE**

Titulli i Projektit
**SISTEMIMI ASFALTIM RRUGA
DEGEZIM I RRUGES
KOPLIK-RAZEM PER TEK RRUGA
E REÇIT**

Faza
PROJEKT ZBATIMI

Vula
Autor
"NOVATECH STUDIO" SHPK
ADMIN ING. EMIL NOVA

Grupi projektimit:
ING. NDERTIMI MIMOZA TOMCO
ARKITEKT GERTA NOVA
ING. HIDROTEKNIK KLODJAN NDOJ
ING. HIDROTEKNIK KOSTANDIN NOVA
ING. GJEEOLOGJIK ANTONELA BAZHDARI
ING. NDERTIMI PETRIKA DOKU

Kapitulli
PROJEKT ARKITEKTONIK

Titulli i Vizatimit
PROFILI TERTHOR

Realizuar **DHJETOR 2022** Shkalla **1:100**

Emërtimi i Fletës
A 1 - 59

PROFILI TERTHOR

CS - 65
PROG - 1+280.0

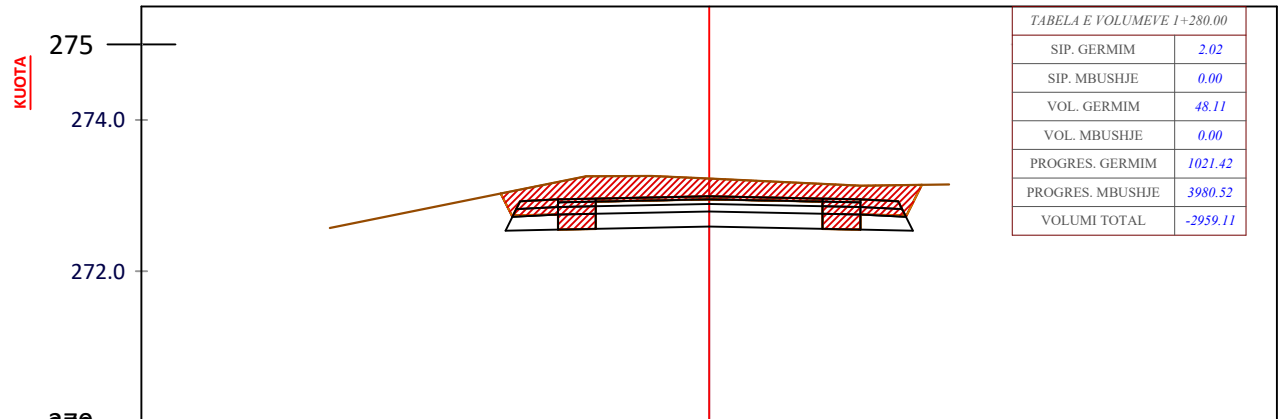

CS - 67
PROG - 1+320.0

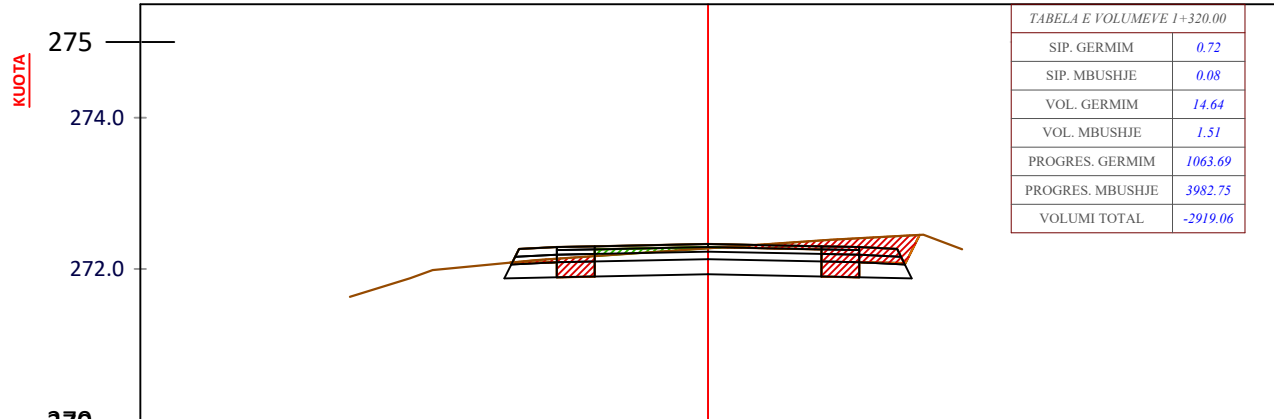

CS - 66
PROG - 1+300.0

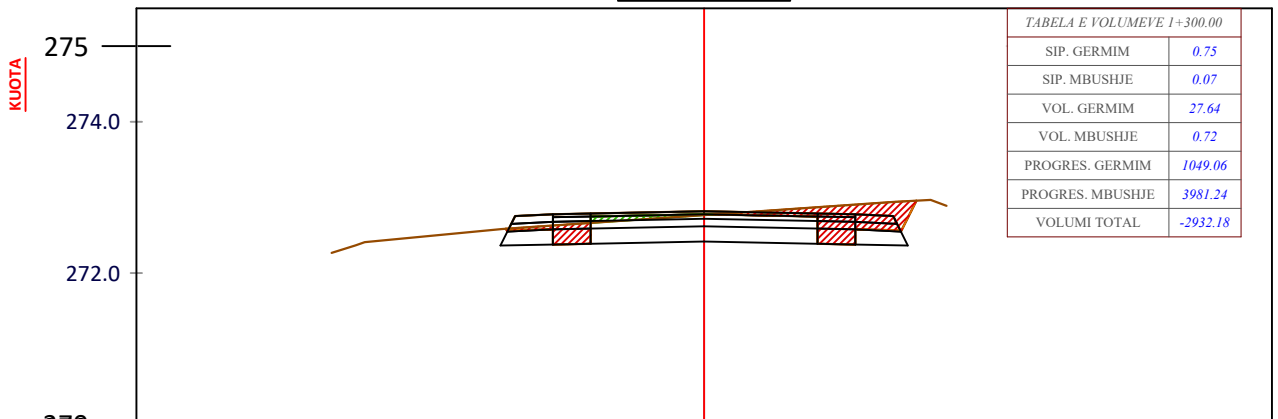

CS - 68
PROG - 1+340.0

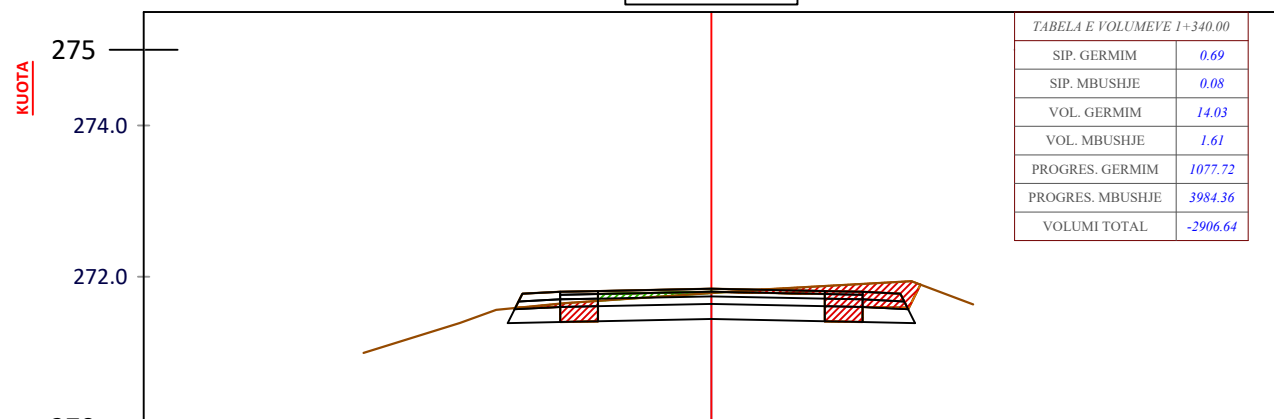

Porositës:
**BASHKIA MALËSI
E MADHE**

Titulli i Projektit
**SISTEMIMI ASFALTIM RRUGA
DEGEZIM I RRUGES
KOPLIK-RAZEM PER TEK RRUGA
E REÇIT**

Faza
PROJEKT ZBATIMI

Vula
Autor
"NOVATECH STUDIO" SHPK

ADMIN ING. EMIL NOVA

Grupi projektimit:
ING. NDERTIMI MIMOZA TOMCO
ARKITEKT GERTA NOVA
ING. HIDROTEKNIK KLODJAN NDOJ
ING. HIDROTEKNIK KOSTANDIN NOVA
ING. GJEOLOGJIK ANTONELA BAZHDARI
ING. NDERTIMI PETRIKA DOKU

Kapitulli
PROJEKT ARKITEKTONIK

Titulli i Vizatimit
PROFILI TERTHOR

Realizuar **DHJETOR 2022** Shkalla **1:100**

Emërtimi i Fletës
A 1 - 60

PROFILI TERTHOR

CS - 69
PROG - 1+360.0



TABELA E VOLUMEVE 1+360.00	
SIP. GERMIM	0.64
SIP. MBUSHJE	0.07
VOL. GERMIM	13.24
VOL. MBUSHJE	1.54
PROGRES. GERMIM	1090.96
PROGRES. MBUSHJE	3985.90
VOLUMI TOTAL	-2894.94

CS - 71
PROG - 1+400.0

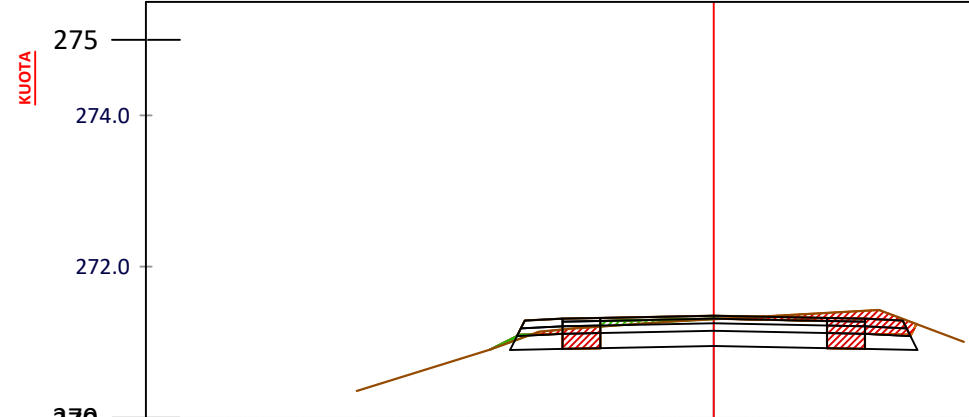

TABELA E VOLUMEVE 1+400.00	
SIP. GERMIM	0.16
SIP. MBUSHJE	0.52
VOL. GERMIM	6.54
VOL. MBUSHJE	7.37
PROGRES. GERMIM	1108.85
PROGRES. MBUSHJE	3996.15
VOLUMI TOTAL	-2887.29

KUOTA TERRENIT	-7.50	-4.72	-270.36	-2.97	-270.90	-2.31	-271.14	-1.84	-271.18	-0.52	-271.28	0.00	-271.31	2.19	-271.43	3.31	-271.01	7.50
DISTANCA	-7.5	-2.96	-270.91	-2.50	-271.06	-2.00	-270.91	-1.50	-270.98	0.00	-271.31	1.50	-270.98	2.00	-270.91	2.68	-271.06	7.5
KUOTA PROJEKTTIT																		
DISTANCA																		
KUOTA PUNES				0.03		0.27				-0.03		-0.01		0.32				

KUOTA TERRENIT	-7.50	-3.73	-269.10	-3.06	-269.30	-1.79	-269.43	-1.54	-269.52	-0.44	-269.59	0.00	-269.60	2.22	-269.23	3.12	-269.29	7.50
DISTANCA	-7.5	-2.56	-269.39	-2.00	-269.40	-1.50	-269.37	-1.00	-269.42	0.00	-269.60	1.50	-269.37	2.00	-269.40	2.88	-269.37	7.5
KUOTA PROJEKTTIT																		
DISTANCA																		
KUOTA PUNES				0.23		0.31				0.00		-0.17						

CS - 70
PROG - 1+380.0

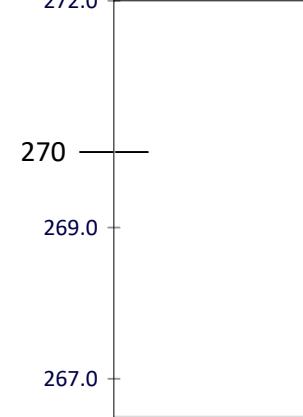

TABELA E VOLUMEVE 1+380.00	
SIP. GERMIM	0.50
SIP. MBUSHJE	0.21
VOL. GERMIM	11.35
VOL. MBUSHJE	2.87
PROGRES. GERMIM	1102.31
PROGRES. MBUSHJE	3988.77
VOLUMI TOTAL	-2886.46

CS - 72
PROG - 1+420.0

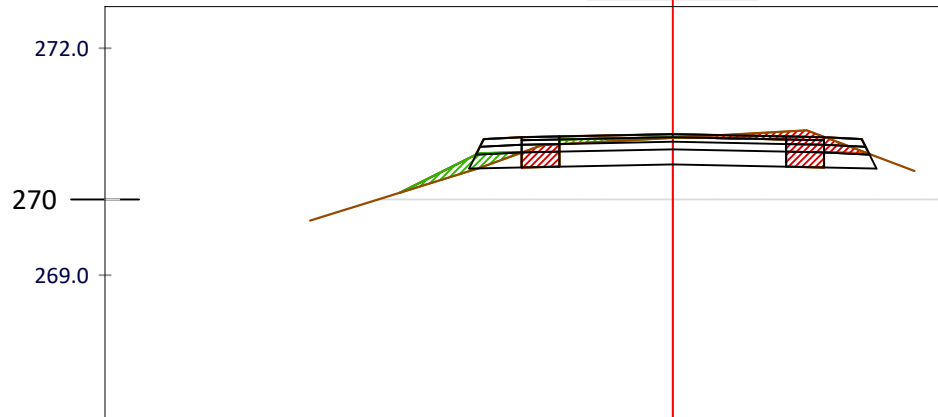

TABELA E VOLUMEVE 1+420.00	
SIP. GERMIM	0.99
SIP. MBUSHJE	0.06
VOL. GERMIM	11.50
VOL. MBUSHJE	5.83
PROGRES. GERMIM	1120.35
PROGRES. MBUSHJE	4001.97
VOLUMI TOTAL	-2881.62

KUOTA TERRENIT	-7.50	-4.80	-269.72	-2.57	-270.41	-1.83	-270.72	0.00	-270.81	1.77	-270.91	3.20	-270.38	7.50			
DISTANCA	-7.5	-3.61	-270.09	-2.00	-270.62	-1.50	-270.79	0.00	-270.82	1.50	-270.79	2.00	-270.62	2.68	-270.60	7.5	
KUOTA PROJEKTTIT																	
DISTANCA																	
KUOTA PUNES				-0.20		0.29		-0.01		0.49							

KUOTA TERRENIT	-7.50	-3.65	-268.42	-2.78	-268.51	-1.40	-268.34	0.00	-268.22	1.70	-268.35	2.35	-268.40	4.88	-271.52	7.50		
DISTANCA	-7.5	-2.82	-268.50	-2.50	-268.08	-2.00	-268.09	-1.50	-268.20	0.00	-268.29	1.50	-268.20	2.00	-268.09	2.59	-268.08	7.5
KUOTA PROJEKTTIT																		
DISTANCA																		
KUOTA PUNES				0.10		0.08				-0.07		0.46	0.31					

Porositës:
**BASHKIA MALËSI
E MADHE**

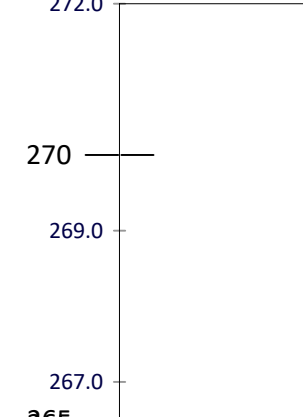
Titulli i Projektit
**SISTEMIMI ASFALTIM RRUGA
DEGEZIM I RRUGES
KOPLIK-RAZEM PER TEK RRUGA
E REÇIT**

Faza
PROJEKT ZBATIMI

Vula
Autor
"NOVATECH STUDIO" SHPK

ADMIN ING. EMIL NOVA

Grupi projektimit:
ING. NDERTIMI Mimoza TOMCO
ARKITEKT Gerta NOVA
ING. HIDROTEKNIK Klodjan NDOJ
ING. HIDROTEKNIK Kostandin NOVA
ING. GJEOLOGJIK Antonela BAZHDARI
ING. NDERTIMI Petrika DOKU

Kapitulli
PROJEKT ARKITEKTONIK

Titulli i Vizatimit
PROFILI TERTHOR

Realizuar **DHJETOR 2022** Shkalla **1:100**

Emërtimi i Fletës
A 1 - 61

PROFILI TERTHOR

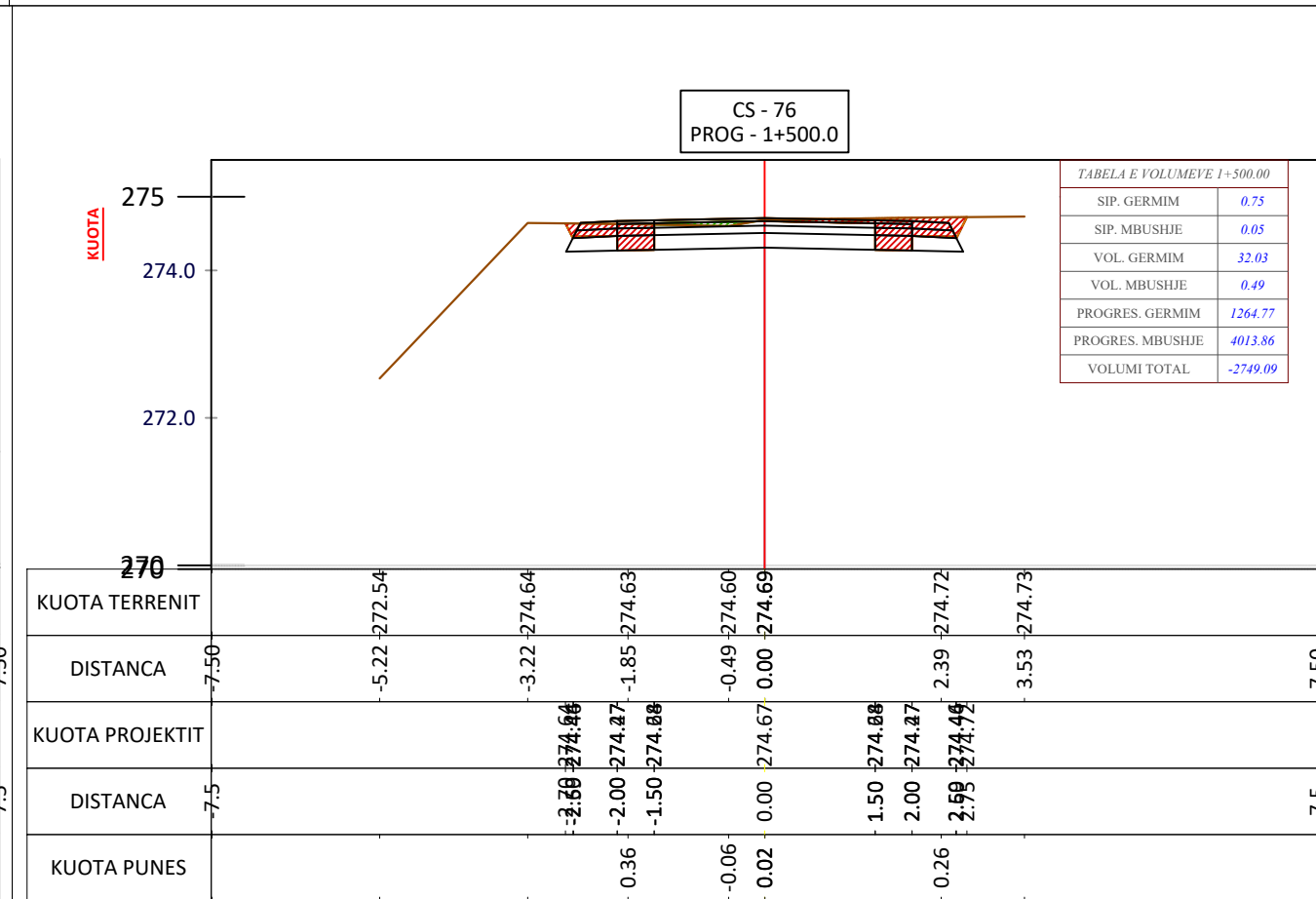
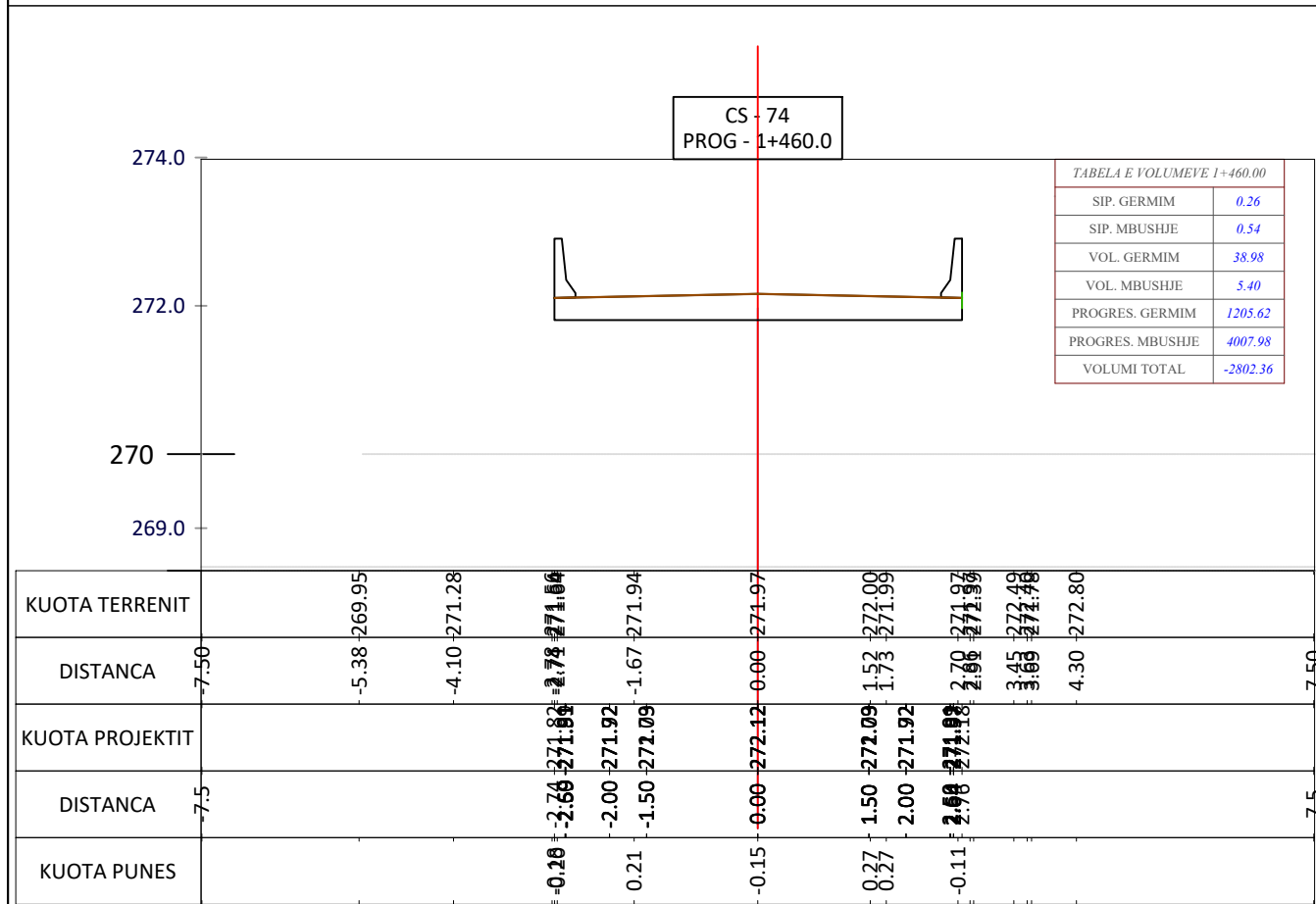
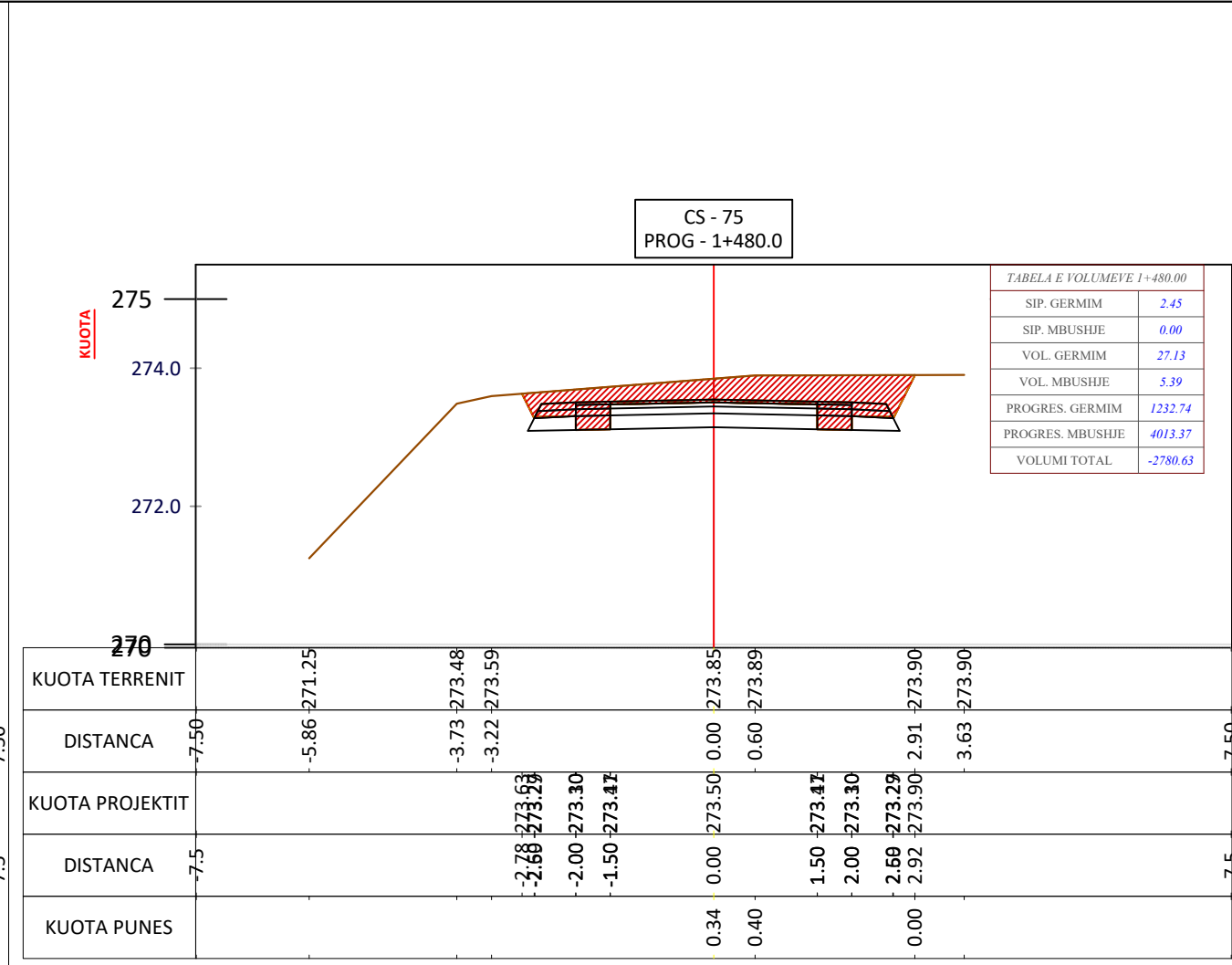
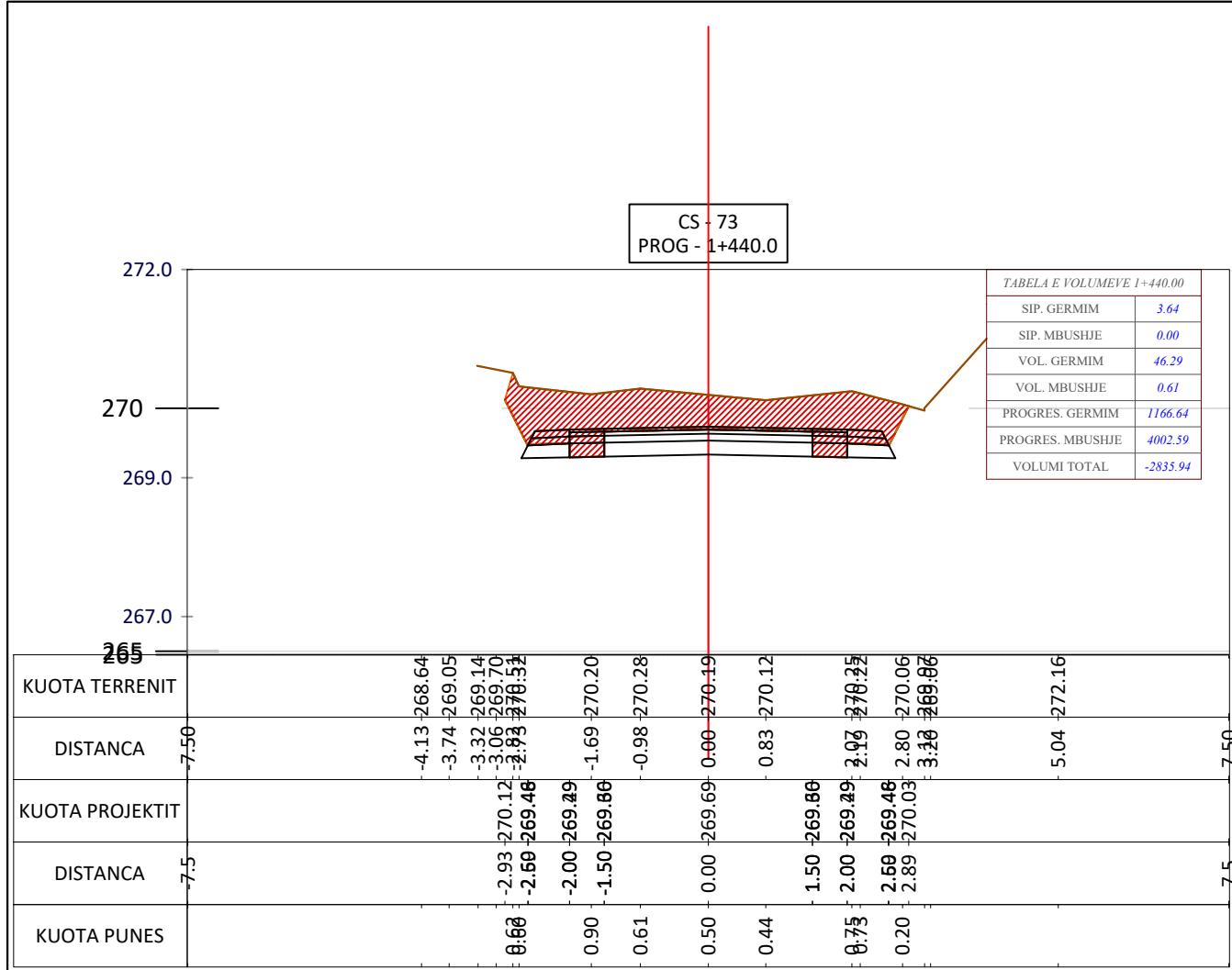

Porositës:

**BASHKIA MALËSI
E MADHE**

Titulli i Projektit
SISTEMIMI ASFALTIM RRUGA
DEGEZIM I RRUGES
KOPLIK-RAZEM PER TEK RRUGA
E REÇIT

Faza
PROJEKT ZBATIMI

Vula

Autor
"NOVATECH STUDIO" SHPK

ADMIN ING. EMIL NOVA

Grupi projektimit:

ING. NDERTIMI	Mimoza TOMCO
ARKITEKT	Gerta NOVA
ING. HIDROTEKNIK	Klodjan NDOJ
ING. HIDROTEKNIK	Kostandin NOVA
ING. GJEOLOGJIK	Antonela BAZHDARI
ING. NDERTIMI	Petrika DOKU

Vula

Kapitulli
PROJEKT ARKITEKTONIK

Titulli i Vizatimit
PROFILI TERTHOR

Realizuar **DHJETOR 2022** Shkalla **1:100**

Emërtimi i Fletës
A 1 - 62

PROFILI TERTHOR

CS - 81
PROG - 1+600.0

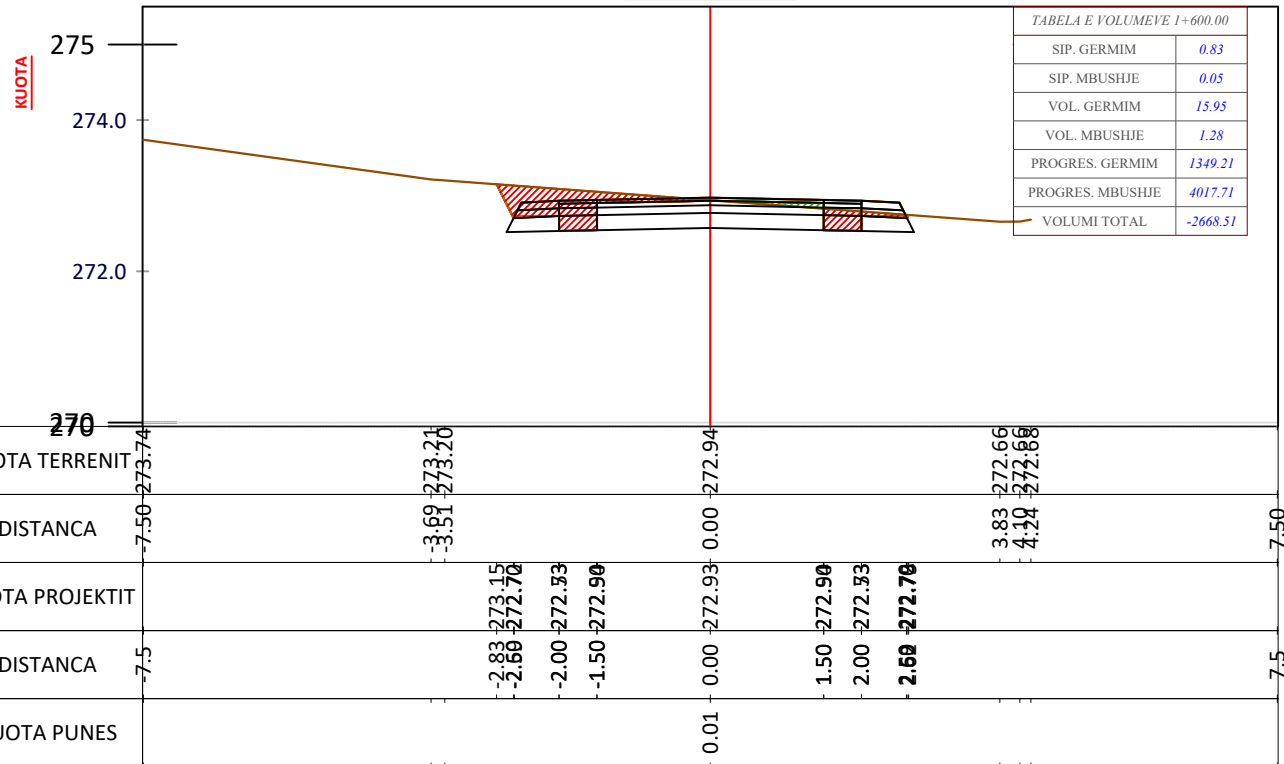

CS - 83
PROG - 1+640.0

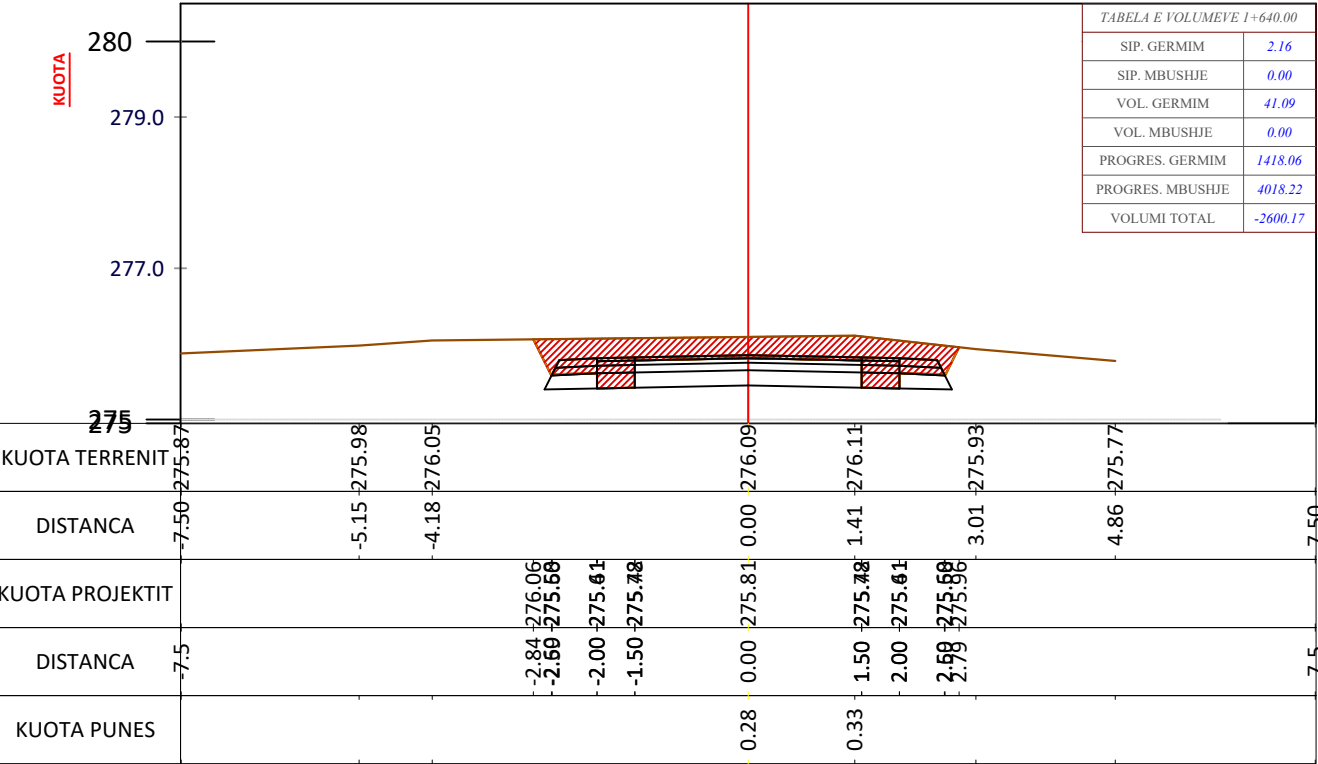

CS - 82
PROG - 1+620.0

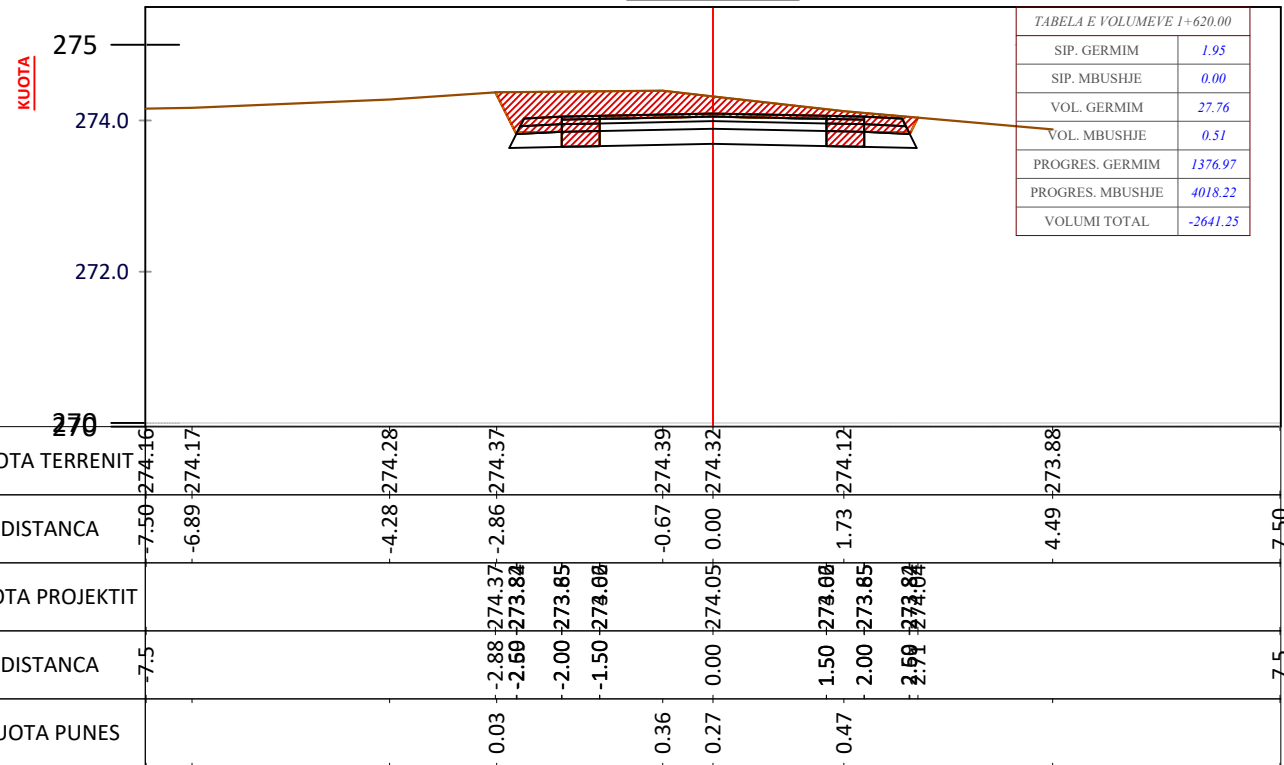

CS - 84
PROG - 1+660.0

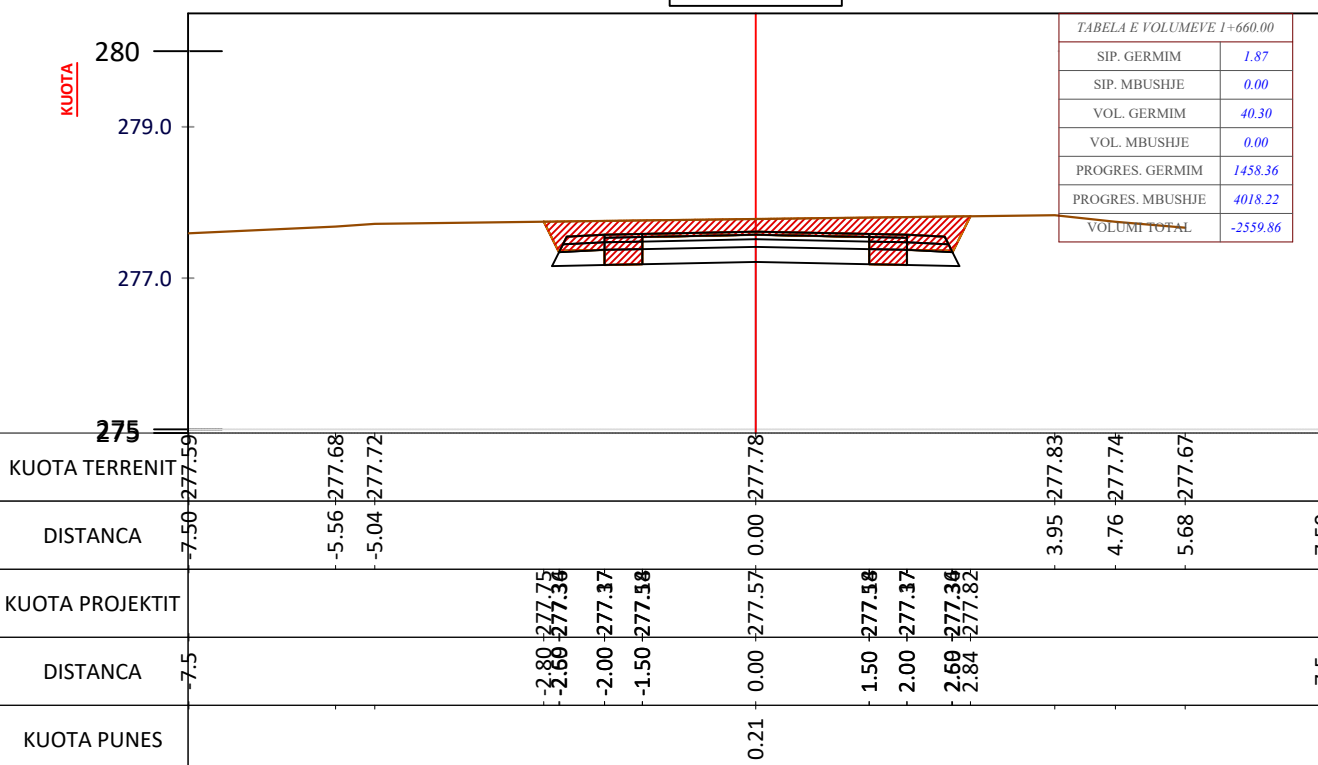

Porositës:
**BASHKIA MALËSI
E MADHE**

Titulli i Projektit
**SISTEMIMI ASFALTIM RRUGA
DEGEZIM I RRUGES
KOPLIK-RAZEM PER TEK RRUGA
E REÇIT**

Faza
PROJEKT ZBATIMI

Vula
Autor
"NOVATECH STUDIO" SHPK

ADMIN ING. EMIL NOVA

Grupi projektimit:
ING. NDERTIMI MIMOZA TOMCO
ARKITEKT GERTA NOVA
ING. HIDROTEKNIK KLODJAN NDOJ
ING. GJEOLOGJIK KOSTANDIN NOVA
ING. NDERTIMI ANTONELA BAZHDARI
PETRIKA DOKU

Kapitulli
PROJEKT ARKITEKTONIK

Titulli i Vizatimit
PROFILI TERTHOR

Realizuar **DHJETOR 2022** Shkalla **1:100**

Emërtimi i Fletës
A 1 - 64

PROFILI TERTHOR

CS - 85
PROG - 1+680.0

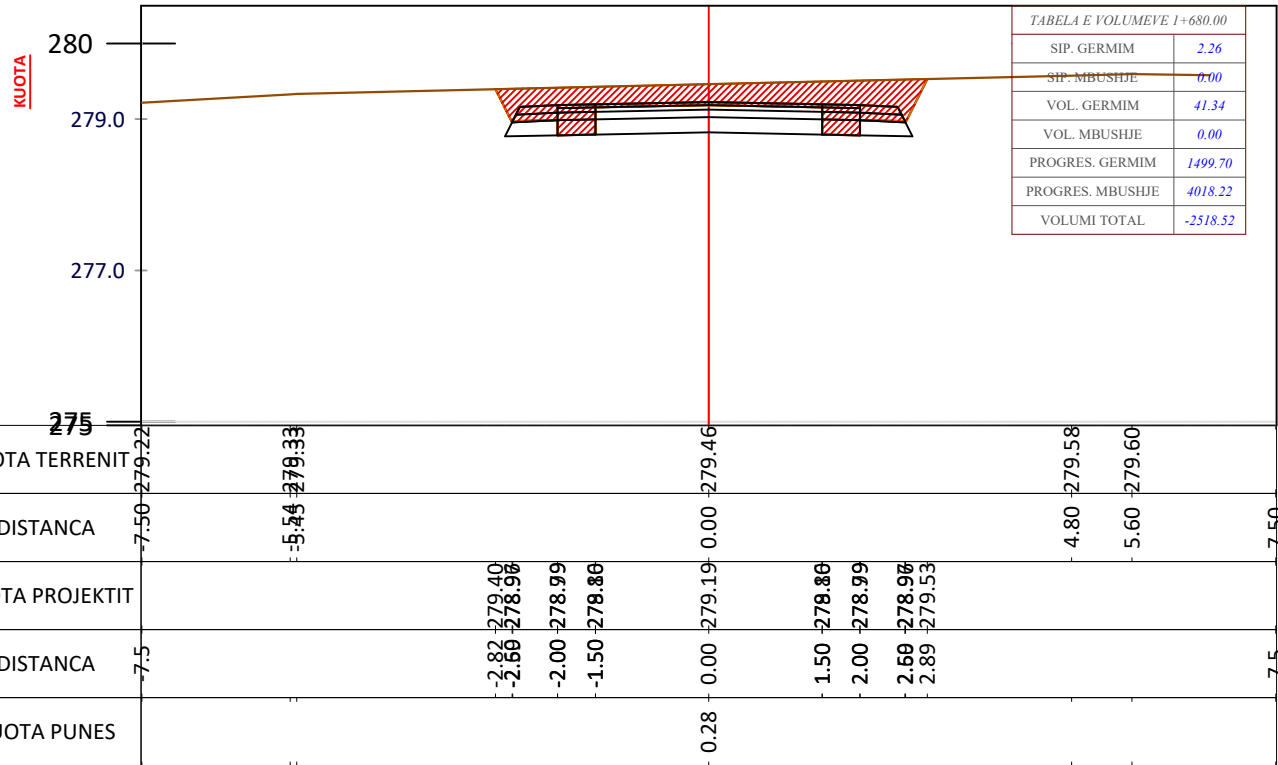

CS - 87
PROG - 1+720.0

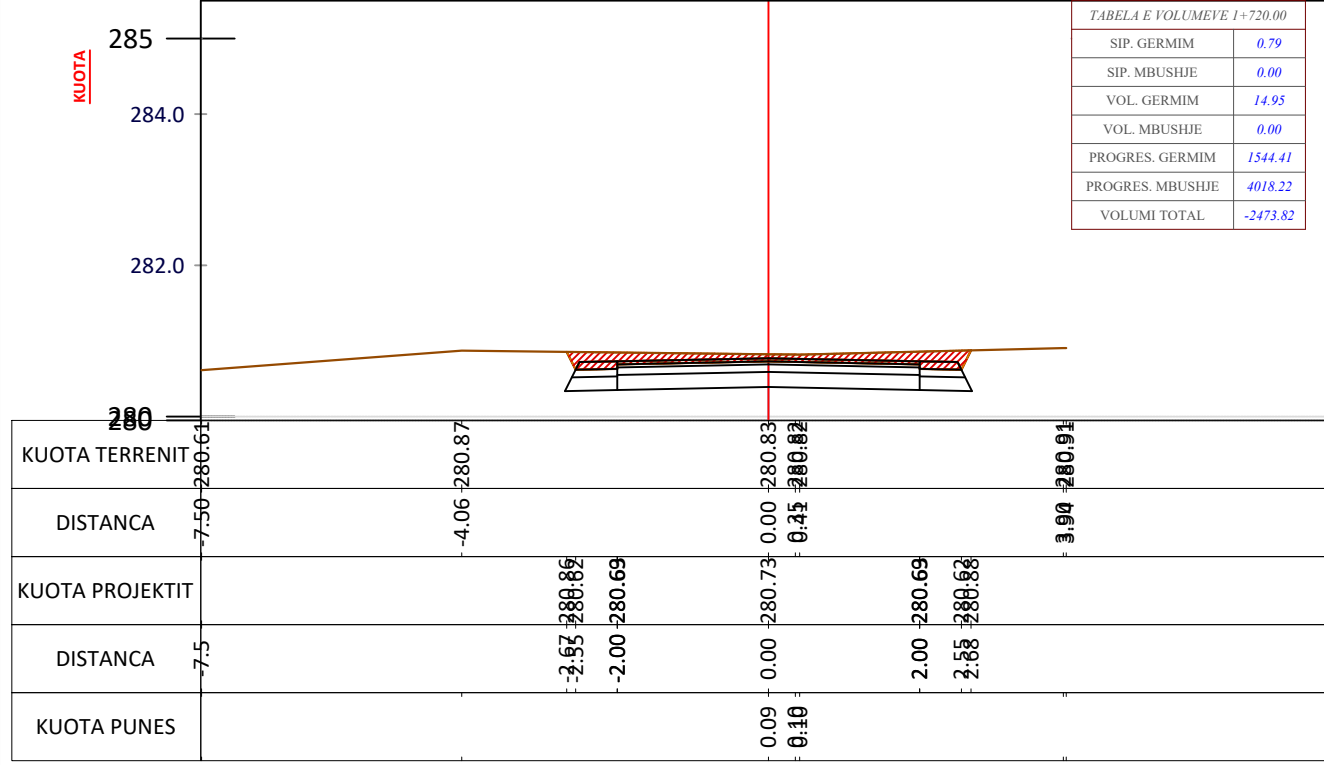

CS - 86
PROG - 1+700.0

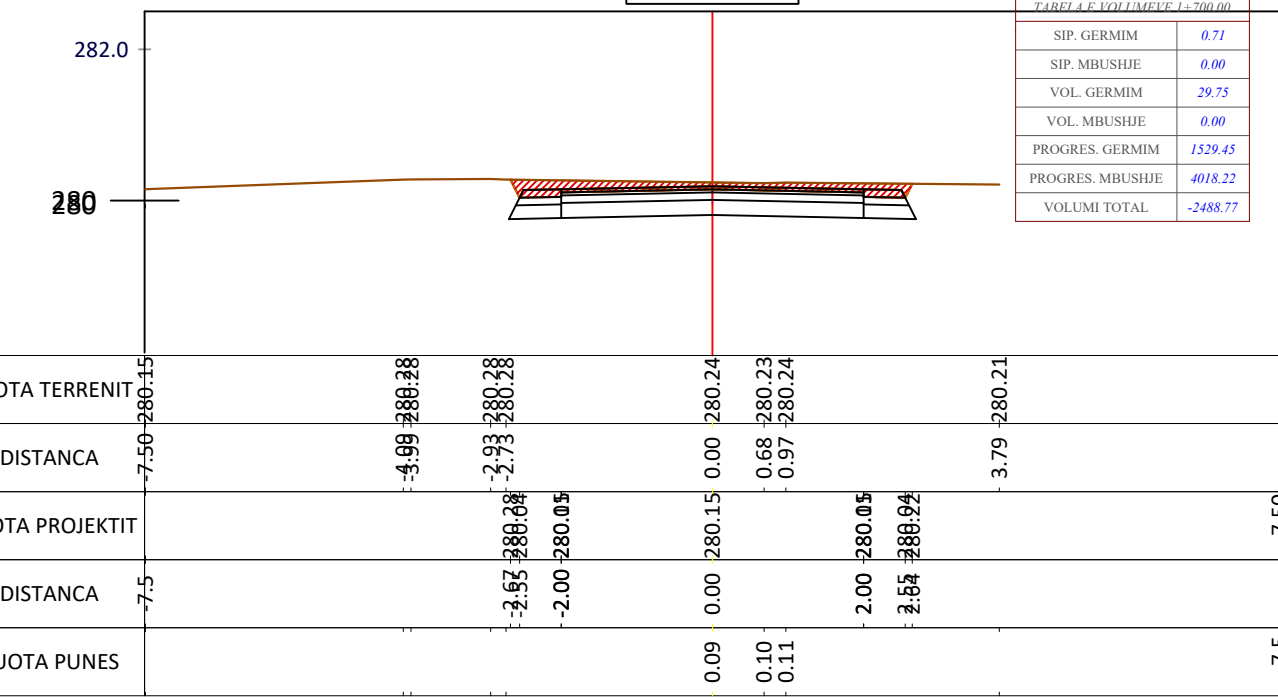

CS - 88
PROG - 1+740.0

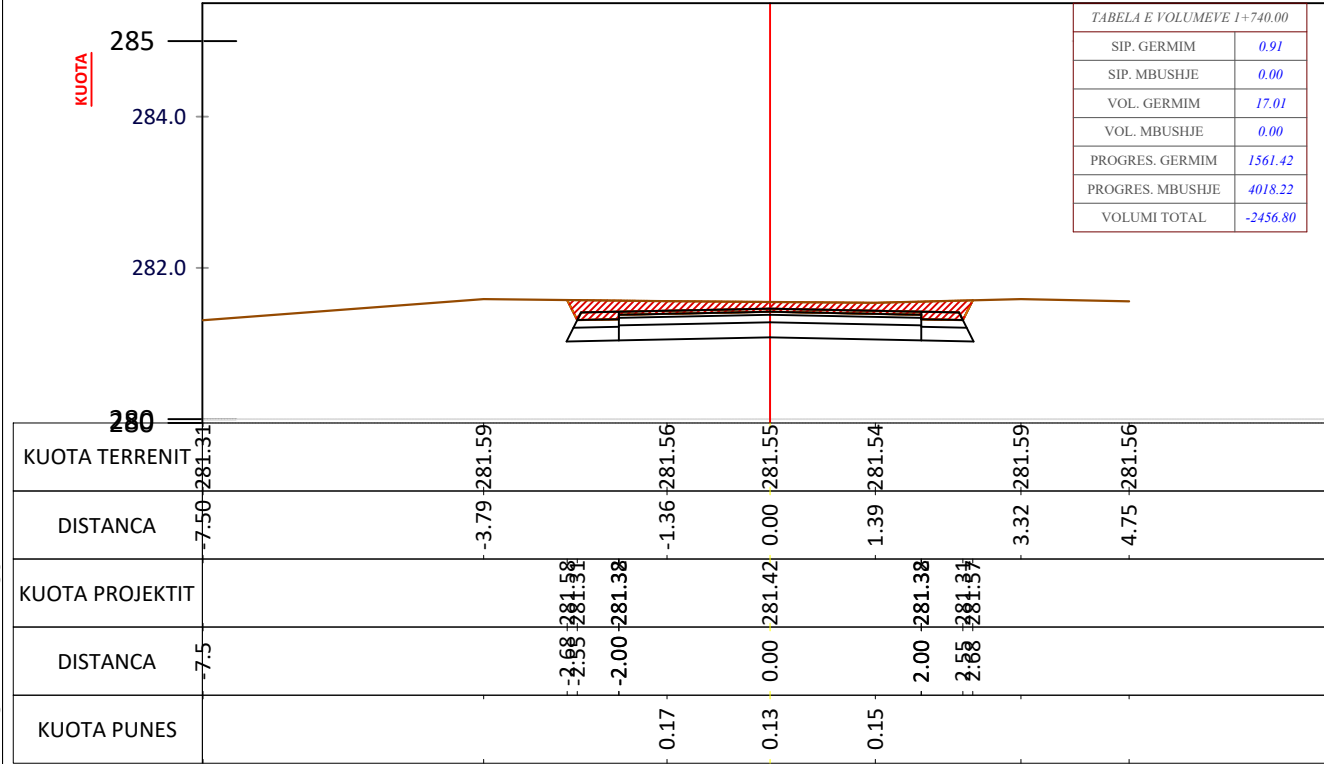

Porositës:
**BASHKIA MALËSI
E MADHE**

Titulli i Projektit
**SISTEMIMI ASFALTIM RRUGA
DEGEZIM I RRUGES
KOPLIK-RAZEM PER TEK RRUGA
E REÇIT**

Faza
PROJEKT ZBATIMI

Vula
Autor
"NOVATECH STUDIO" SHPK
ADMIN ING. EMIL NOVA

Grupi projektimit:
ING. NDERTIMI MIMOZA TOMCO
ARKITEKT GERTA NOVA
ING. HIDROTEKNIK KLODJAN NDOJ
ING. HIDROTEKNIK KOSTANDIN NOVA
ING. GJEOLGJIK ANTONELA BAZHDARI
ING. NDERTIMI PETRIKA DOKU

Kapitulli
PROJEKT ARKITEKTONIK

Titulli i Vizatimit
PROFILI TERTHOR

Realizuar **DHJETOR 2022** Shkalla **1:100**

Emërtimi i Fletës
A 1 - 65

PROFILI TERTHOR

CS - 89
PROG - 1+760.0

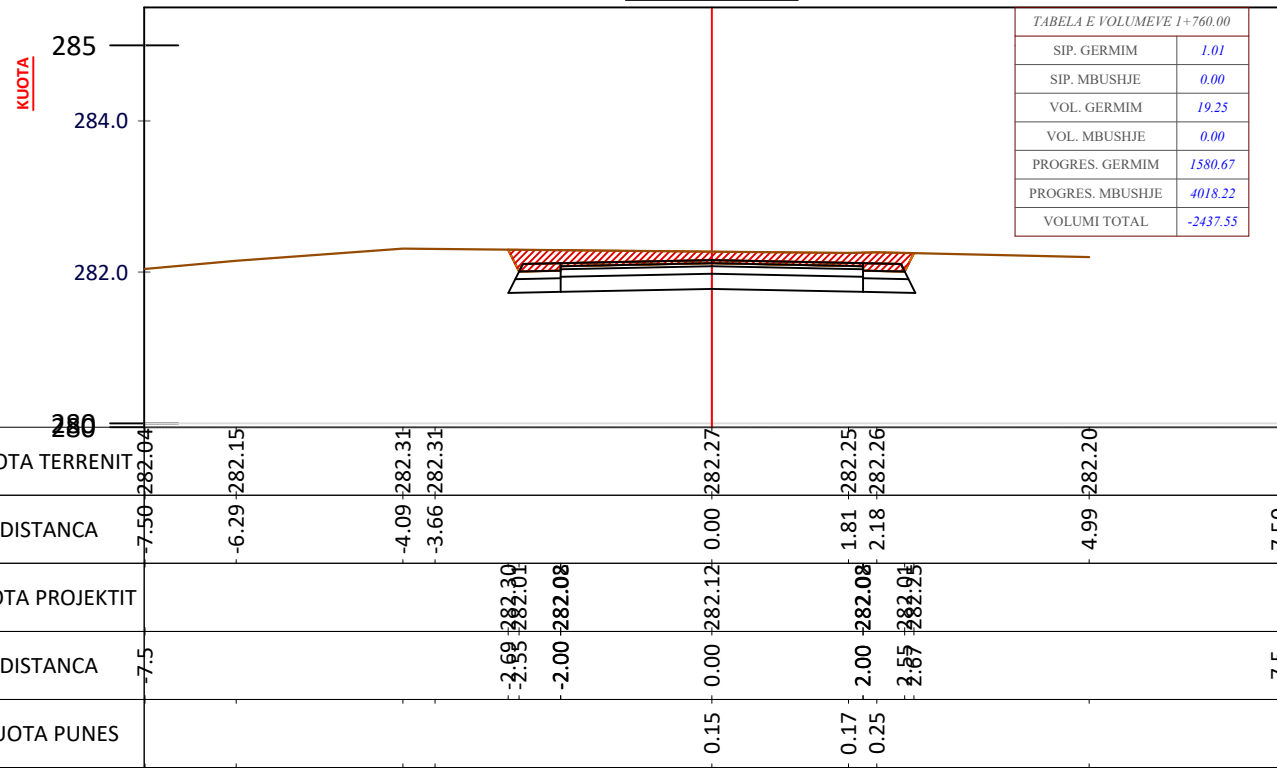

CS - 90
PROG - 1+780.0

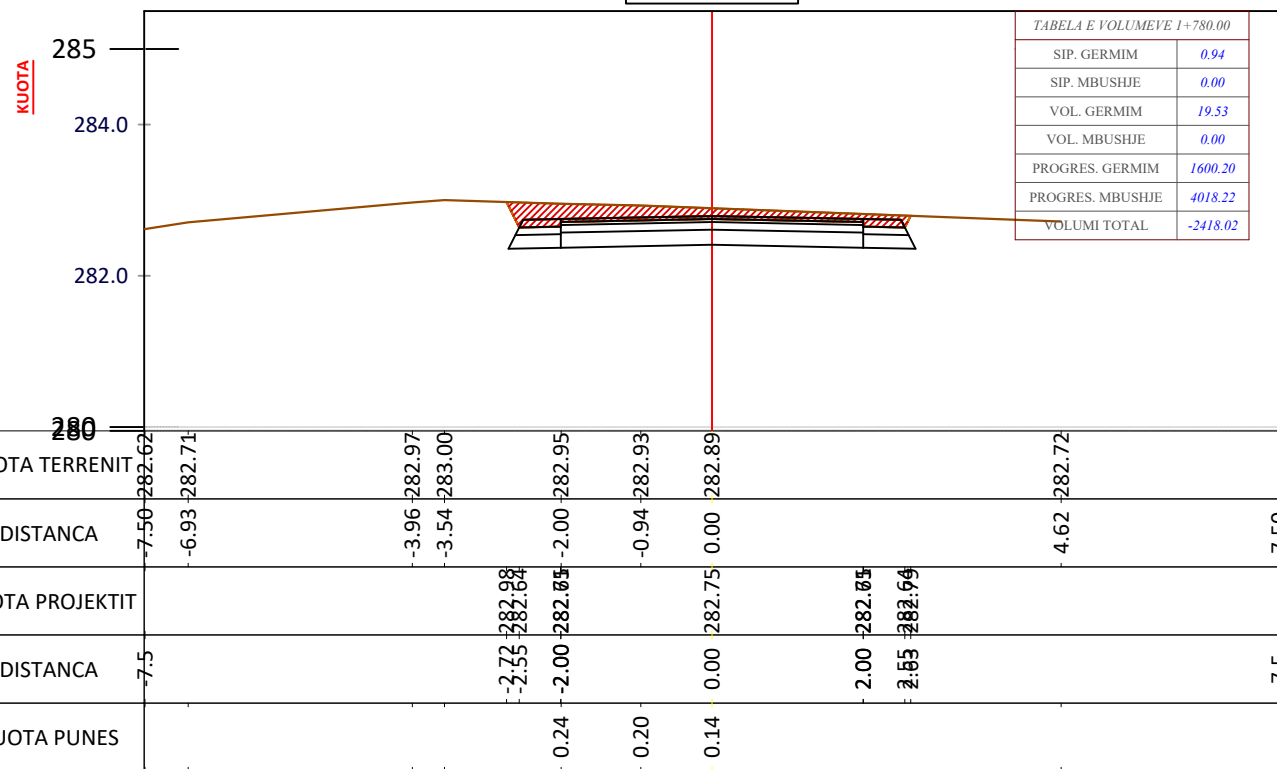

CS - 91
PROG - 1+788.3

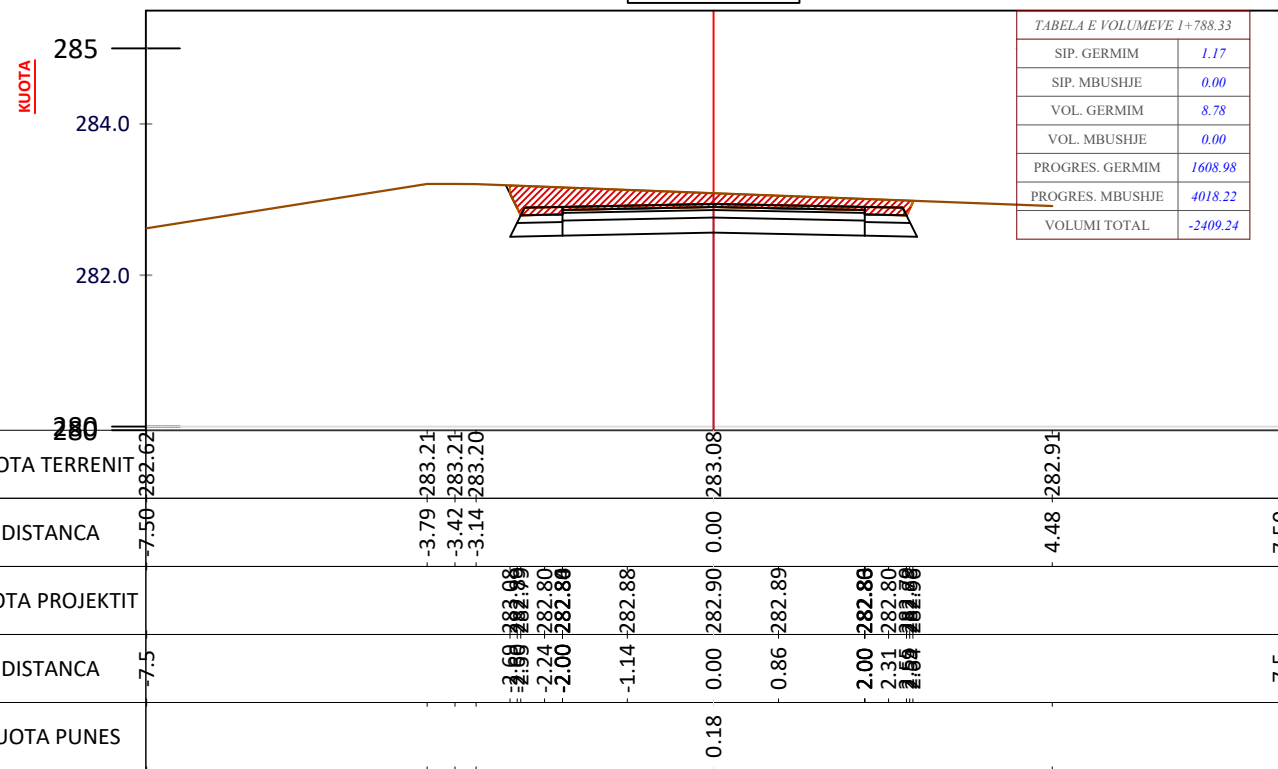

Porositës:

**BASHKIA MALËSI
E MADHE**

Titulli i Projektit

**SISTEMIMI ASFALTIM RRUGA
DEGEZIM I RRUGES
KOPLIK-RAZEM PER TEK RRUGA
E REÇIT**

Faza

PROJEKT ZBATIMI

Vula

Autor

"NOVATECH STUDIO" SHPK



Grupi projektimit:

ING. NDERTIMI MIMOZA TOMCO
ARKITEKT GERTA NOVA
ING. HIDROTEKNIK KLODJAN NDOJ
ING. HIDROTEKNIK KOSTANDIN NOVA
ING. GJEOLGJIK ANTONELA BAZHDARI
ING. NDERTIMI PETRIKA DOKU

Vula

Kapitulli

PROJEKT ARKITEKTONIK

Titulli i Vizatimit

PROFILI TERTHOR

Realizuar **DHJETOR 2022**

Shkalla **1:100**

Emërtimi i Fletës

A 1 - 66

**PROFILI
TERTHOR**

PLANIMETRI E URES SH 1:50

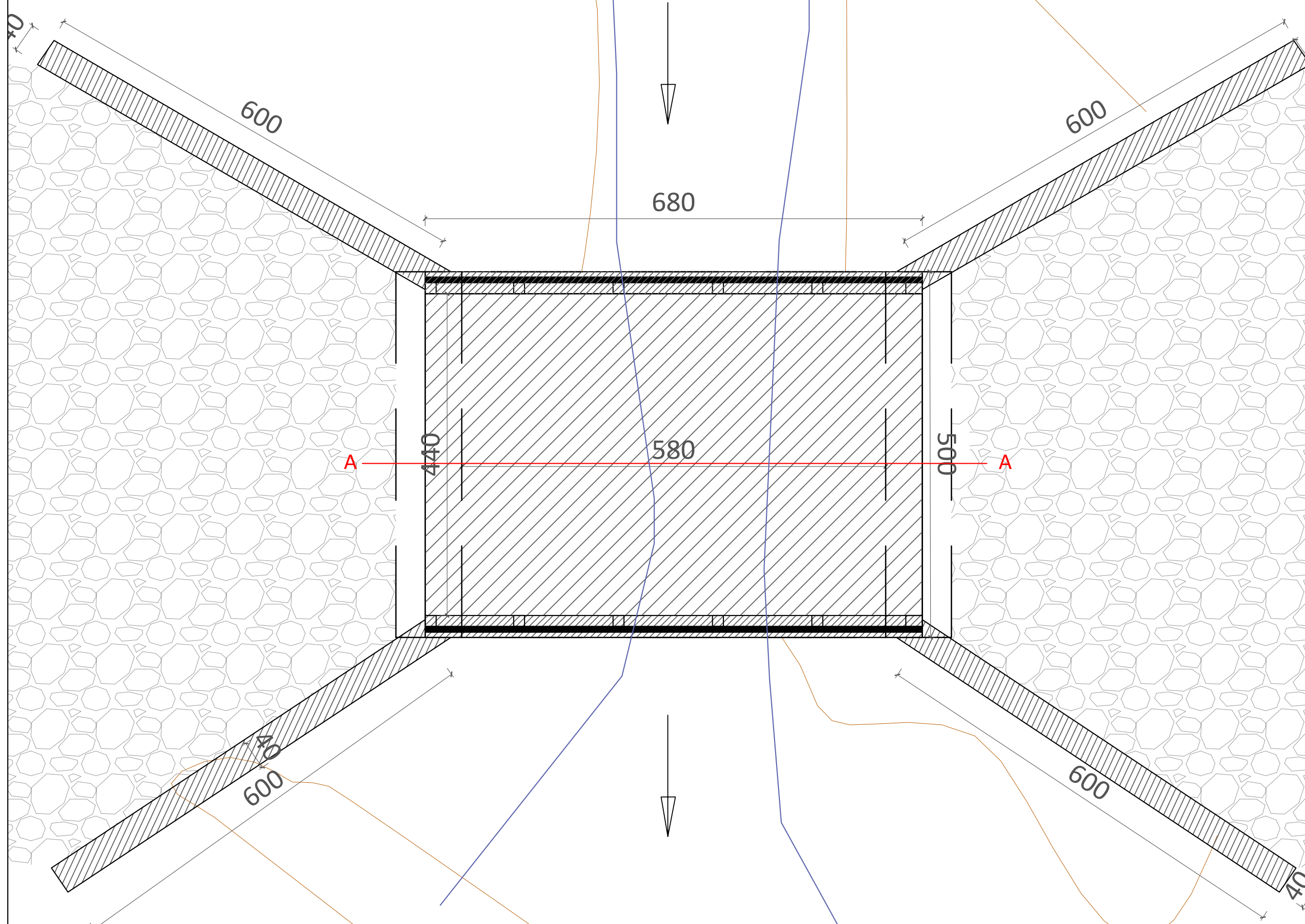

Porositës:

**BASHKIA MALËSI
E MADHE**

Titulli i Projektit
**SISTEMIMI ASFALTIM RRUGA
DEGEZIM I RRUGES
KOPLIK-RAZEM PER TEK RRUGA
E REÇIT**

Faza
PROJEKT ZBATIMI

Vula
Autor
"NOVATECH STUDIO" SHPK

ADMIN ING. EMIL NOVA

Grupi projektimit:
ING. NDERTIMI Mimoza TOMCO
ARKITEKT Gerta NOVA
ING. HIDROTEKNIK Klodjan NDOJ
ING. HIDROTEKNIK Kostandin NOVA
ING. GJEOLGJIK Antonela BAZHDARI
ING. NDERTIMI Petrika DOKU

Vula

Kapitulli
PROJEKT ARKITEKTONIK

Titulli i Vizatimit
URA PLAN DHE PRERJE

Realizuar **DHJETOR 2022** Shkalla **1:50**

Emërtimi i Fletës
A 1 - 67

PRERJA A-A E URES SH 1:50

PARMAK ME KOLONCINA BETONI

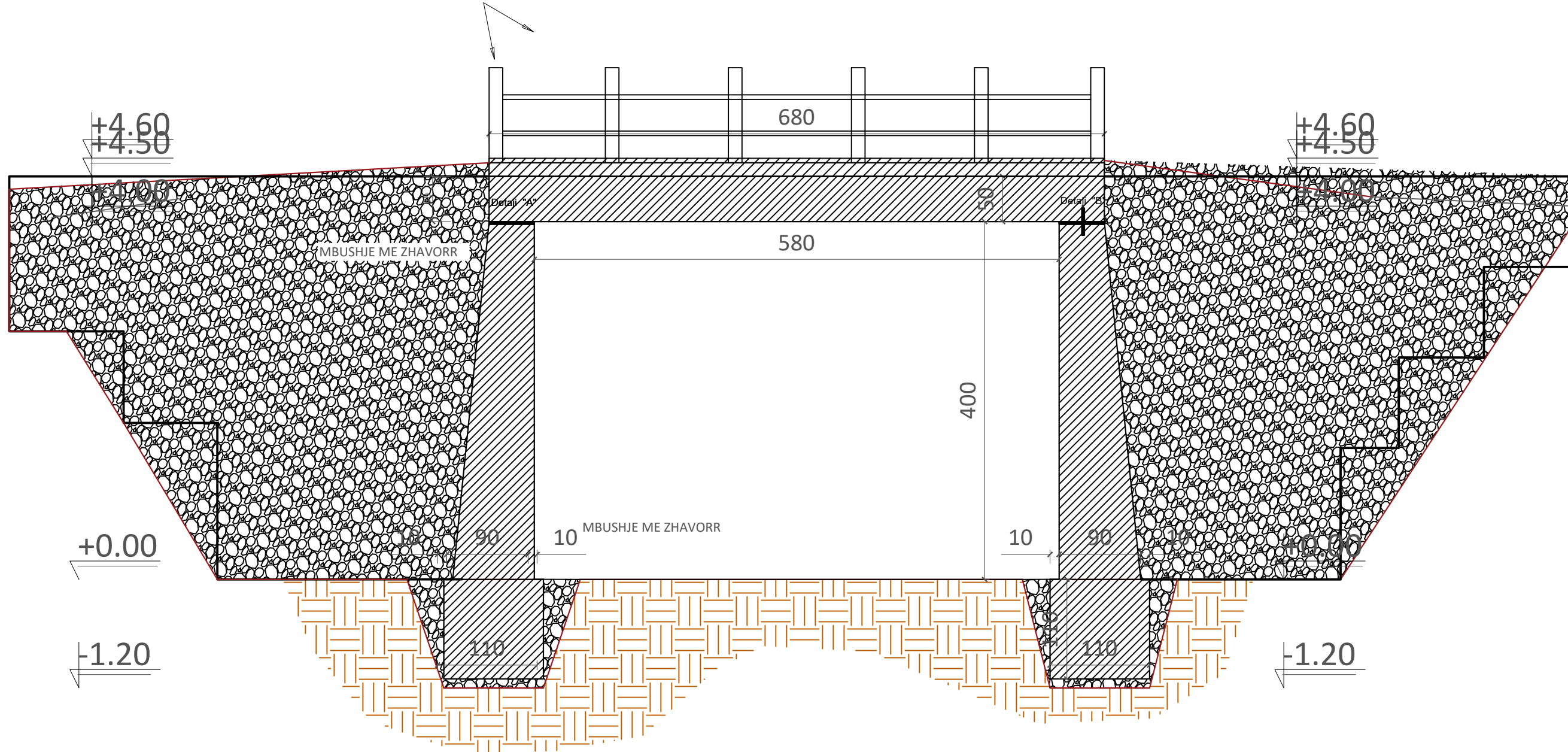

PROFILI
TERTHOR

Porositës:

BASHKIA MALËSI
E MADHE

Titulli i Projektit

SISTEMIMI ASFALTIM RRUGA
DEGEZIM I RRUGES
KOPLIK-RAZEM PER TEK RRUGA
E REÇIT

Faza

PROJEKT ZBATIMI

Vula

Autor "NOVATECH STUDIO" SHPK



Grupi projektimit:

ING. NDERTIMI	Mimoza TOMCO
ARKITEKT	Gerta NOVA
ING. HIDROTEKNIK	Klodjan NDOJ
ING. HIDROTEKNIK	Kostandin NOVA
ING. GJEOLGJIK	Antonela BAZHDARI
ING. NDERTIMI	Petrika DOKU

Vula

Kapitulli

PROJEKT ARKITEKTONIK

Titulli i Vizatimit

URA PRERJE A-A

Realizuar DHJETOR 2022 Shkalla 1:50

Emërtimi i Fletës

A 1 - 68

DETAJE TE LIDHJES SE SOLETES ME BALLNAT

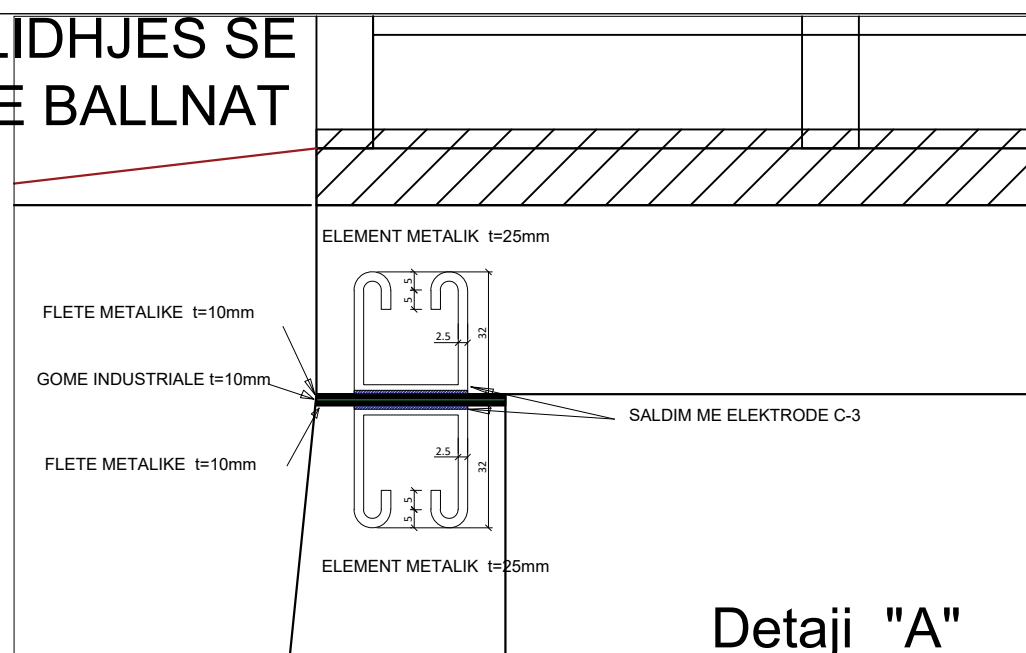

Detaji "A"

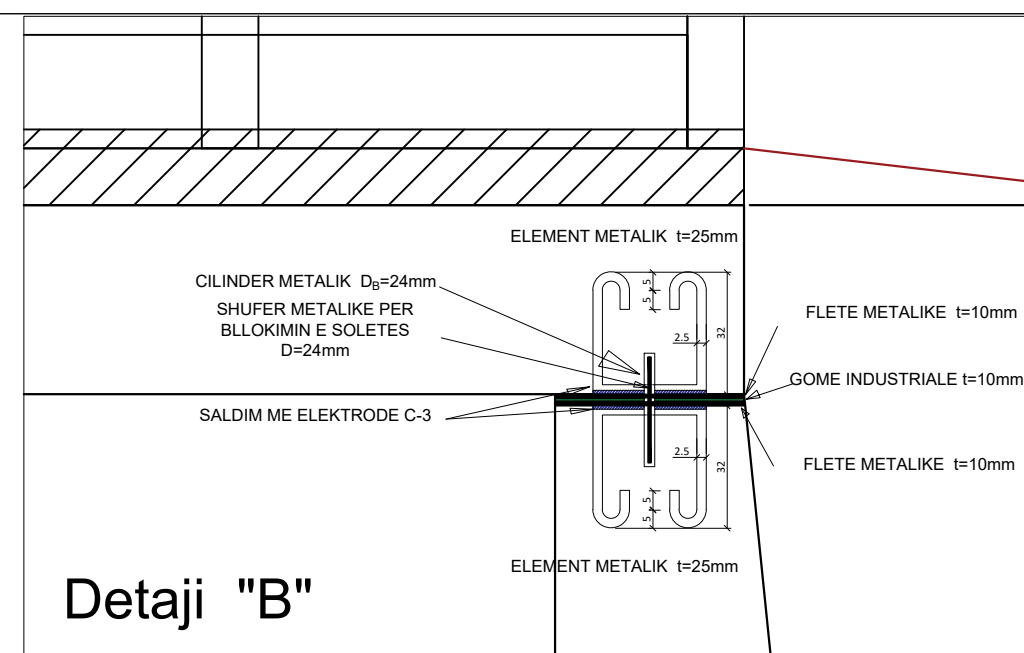

Detaji "B"

PLANVENDOSJE E URES HD=6.8m B=5m SH 1:150

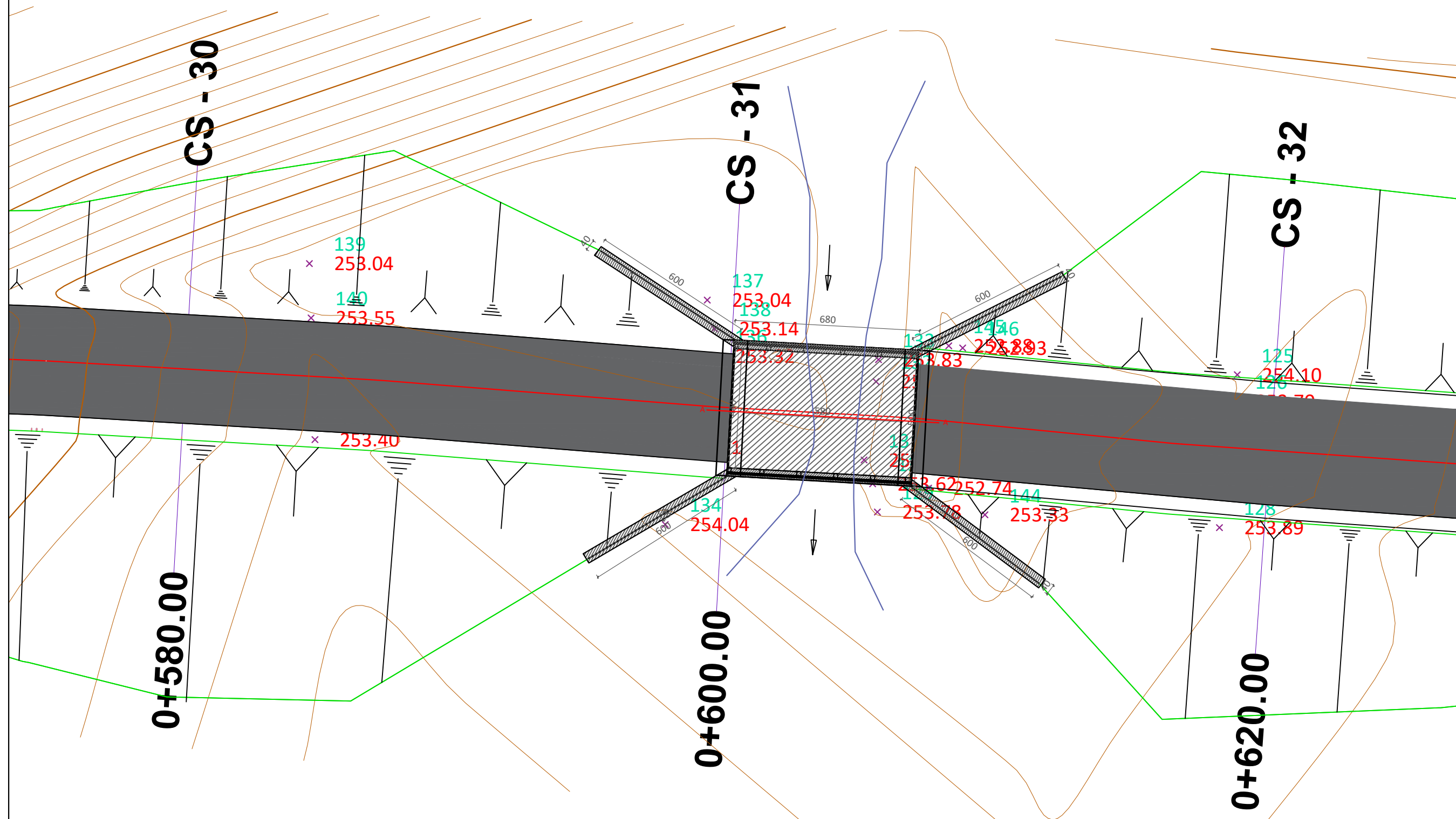

Porositës:	BASHKIA MALËSI E MADHE													
Titulli i Projektit	SISTEMIMI ASFALTIM RRUGA DEGEZIM I RRUGES KOPLIK-RAZEM PER TEK RRUGA E REÇIT													
Faza	PROJEKT ZBATIMI													
Vula														
Autor	"NOVATECH STUDIO" SHPK  ADMIN ING. EMIL NOVA													
Grupi projektimit:	<table border="1"> <tr> <td>ING. NDERTIMI</td> <td>Mimoza TOMCO</td> </tr> <tr> <td>ARKITEKT</td> <td>Gerta NOVA</td> </tr> <tr> <td>ING. HIDROTEKNIK</td> <td>Klodjan NDOJ</td> </tr> <tr> <td>ING. HIDROTEKNIK</td> <td>Kostandin NOVA</td> </tr> <tr> <td>ING. GJEOLGJIK</td> <td>Antonela BAZHDARI</td> </tr> <tr> <td>ING. NDERTIMI</td> <td>Petrika DOKU</td> </tr> </table>		ING. NDERTIMI	Mimoza TOMCO	ARKITEKT	Gerta NOVA	ING. HIDROTEKNIK	Klodjan NDOJ	ING. HIDROTEKNIK	Kostandin NOVA	ING. GJEOLGJIK	Antonela BAZHDARI	ING. NDERTIMI	Petrika DOKU
ING. NDERTIMI	Mimoza TOMCO													
ARKITEKT	Gerta NOVA													
ING. HIDROTEKNIK	Klodjan NDOJ													
ING. HIDROTEKNIK	Kostandin NOVA													
ING. GJEOLGJIK	Antonela BAZHDARI													
ING. NDERTIMI	Petrika DOKU													
Vula														
Kapitulli	PROJEKT ARKITEKTONIK													
Titulli i Vizatimit	ARMIMI I URES/SOLETA													
Realizuar	DHJETOR 2022	Shkalla 1:150												
Emërtimi i Fletës	K1 - 02													

ARMIMI I SOLETES SE URES SH 1:50

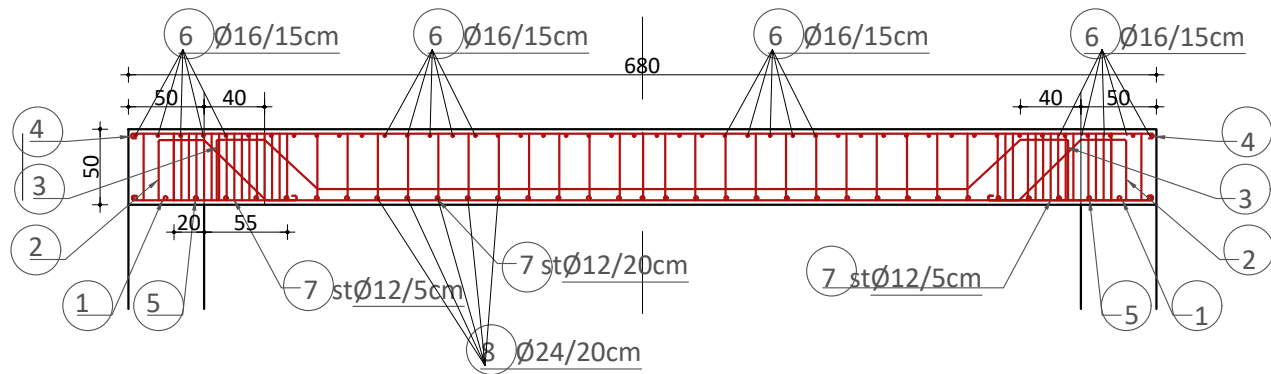

numri i elementit	Profili Ø	gjatesia cm	sas'a cope	gjatesia totale Ml	armatura permb edhese			
					gjatesia ml	pesha kg	totali kg	
1	Ø=24	680	17	115.6	Ø=12	2325.6	1.13	2627.928
2	Ø=24	670	17	113.9	Ø=16	458.44	1.58	124.332
3	Ø=24	750	17	127.5	Ø=24	547.06	4.52	2472.711
4	Ø=16	680	34	231.2				
5	Ø=24	130	17	22.1				
6	Ø=16	494	46	227.24				
7	Ø=12	228	1020	2325.6				
8	Ø=24	494	34	167.96				
					SHUMA TOT			5824.974

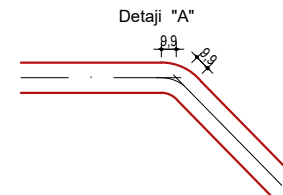
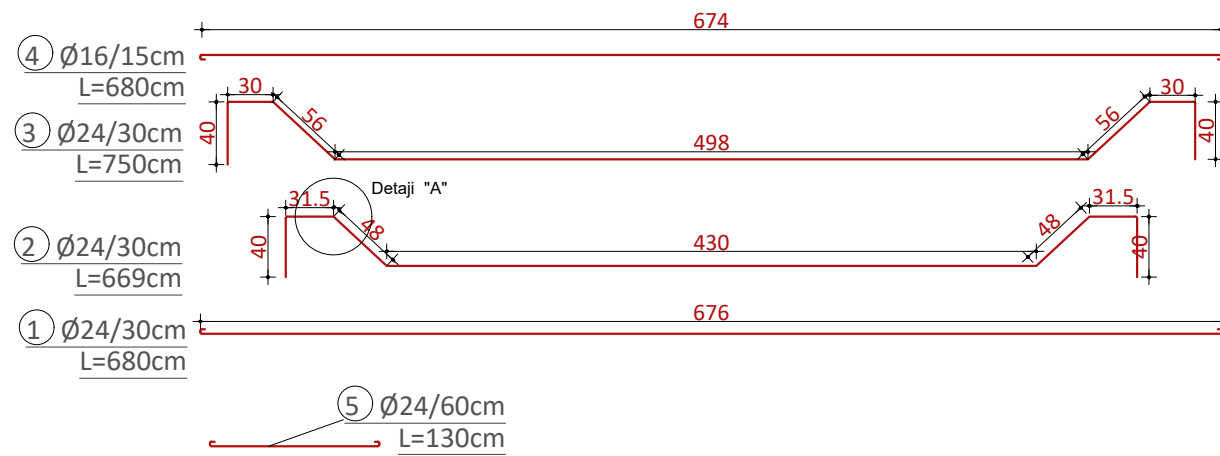

DETAJE TE PARMAKUT

SH 1 : 20
PARMAKU I URES SH 1:20

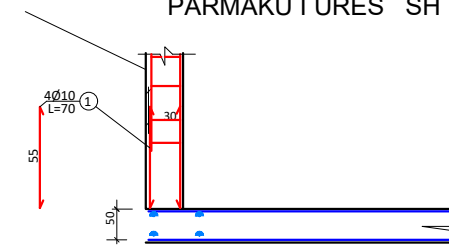

kolloncina b/arme 15 x 15 x 105 cm
Ne cdo 1,28 m

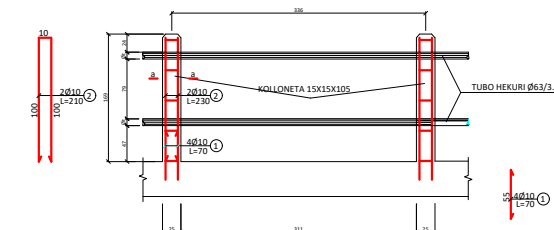

PRERJA a-a



TABELA E HEKURAVE PER 1 MI GIATESI PARMAKU						
Poz	Diametri Ø mm	L (cm)	Sasa	gjatesia totale (cm)	Pesha rrepti	Pesha kg
1	10	70	4	2.8	0.62	1.7
2	10	210	2	4.2	0.62	2.6
3	8	10	5	2.5	0.395	0.98
SHUMA KË						5.3

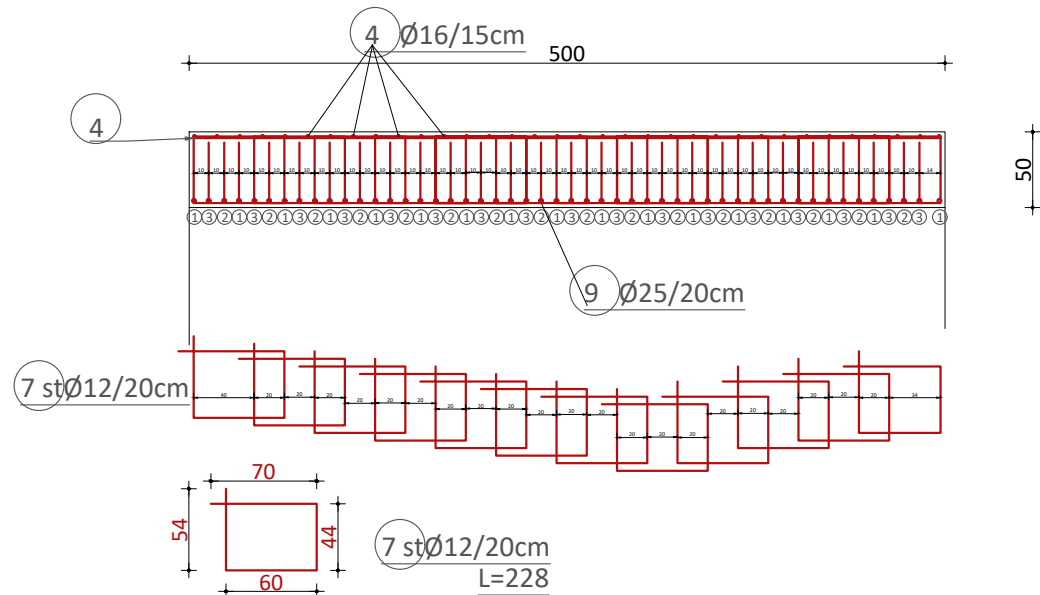

ARMIMI I SHTRYES NDHMESE M-250 H=15cm

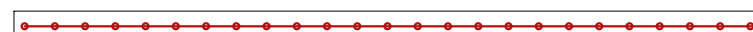

zgare Ø10/15cm

Porositës:

BASHKIA MALËSI
E MADHE

Titulli i Projektit

SISTEMIMI ASFALTIM RRUGA
DEGEZIM I RRUGES
KOPLIK-RAZEM PER TEK RRUGA
E REÇIT

Faza

PROJEKT ZBATIMI

Vula

Autor

"NOVATECH STUDIO" SHPK

NOVATECH STUDIO
ADMIN ING. EMIL NOVA

Grupi projektimit:

ING. NDERTIMI Mimoza TOMCO
ARKITEKT Gerta NOVA
ING. HIDROTEKNIK Klodjan NDOJ
ING. HIDROTEKNIK Kostandin NOVA
ING. GJEOLJIK Antonela BAZHDARI
ING. NDERTIMI Petrika DOKU

Vula

Kapitulli

PROJEKT ARKITEKTONIK

Titulli i Vizatimit

ARMIMI I URES/SOLETA

Realizuar
DHJETOR 2022

Shkalla
1:100

Emërtimi i Fletës

K1 - 01

PROFILI TERTHOR

ARMIMI I KEMBEVE TE URES SH 1:50

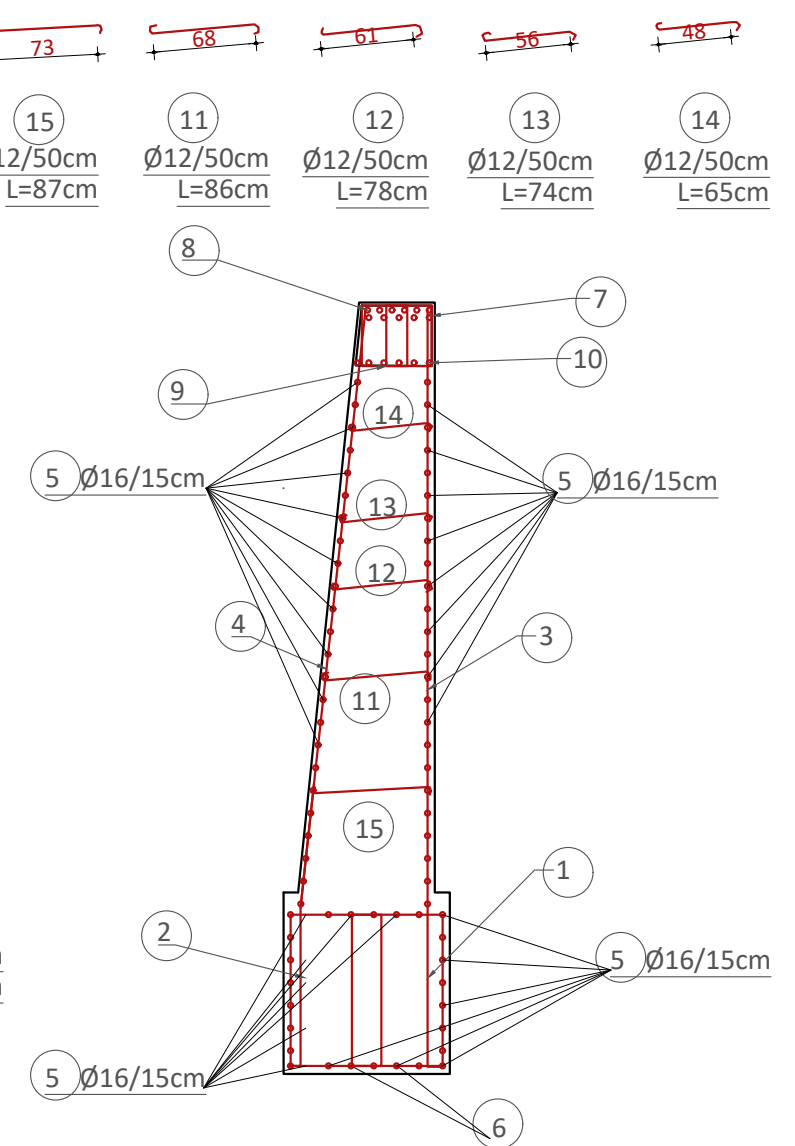
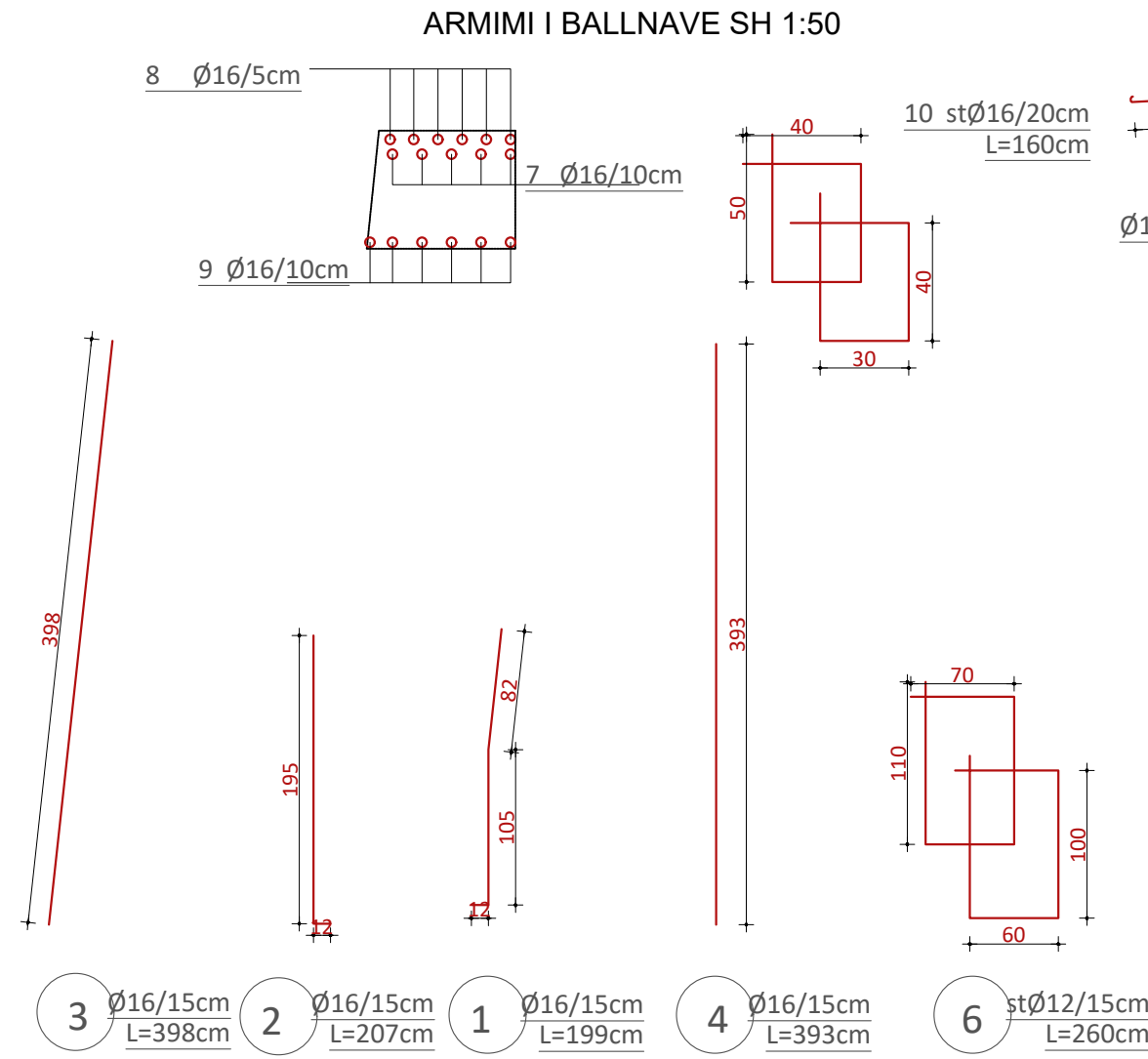

ARMIMI I SHPATULLAVE Zgare 2fishe Ø12/15cm

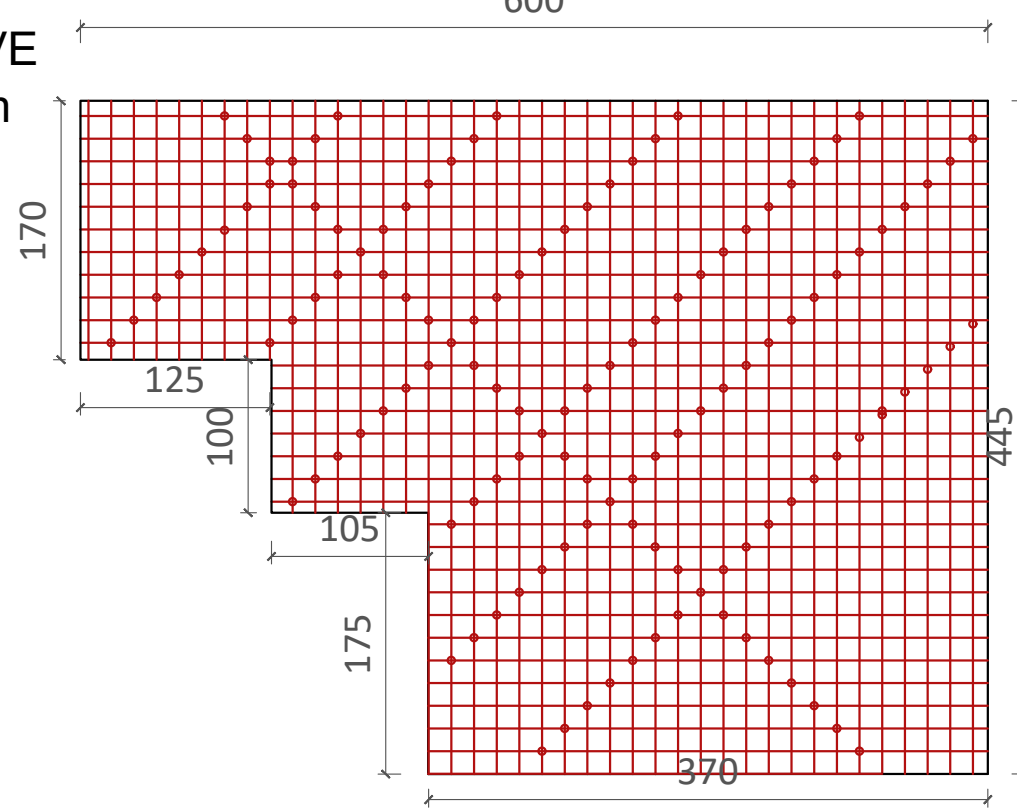

ARMIMI I BALLNAVE

numri elementit	Profil Ø	gjatësia cm	sasia copo	gjatësia totale m	gatesia profi Ø	gatesia m	pesha kg	totali kg
1	Ø=16	199	39	67.66	Ø=16	1.52	1686.332	
2	Ø=16	707	14	70.78	Ø=17	0.89	38.181	
3	Ø=16	398	34	135.32				
4	Ø=16	393	34	133.62				
5	Ø=16	495	70	266.5				
6	Ø=16	770	50	385				
7	Ø=16	494	5	24.7				
8	Ø=16	494	9	44.46				
9	Ø=16	494	6	29.64				
10	Ø=16	180	50	90				
11	Ø=12	86	11	9.46				
12	Ø=12	78	11	8.58				
13	Ø=12	74	11	8.14				
14	Ø=12	65	11	7.15				
15	Ø=12	87	11	9.57				
ARMIMI PER 2 B 3448.967								

ARMIMI I SHPATULLAVE

numri elementit	Profil Ø	gjatësia cm	sasia copo	gjatësia totale m	gatesia profi Ø	gatesia m	pesha kg	totali kg
1	Ø=12	500	11	55	Ø=16	34.00	389	308.8743
2	Ø=12	400	7	28				
3	Ø=12	370	12	44.4				
4	Ø=12	445	24	106.8				
5	Ø=12	275	7	29.25				
6	Ø=12	200	9	18				
7	Ø=12	48	130	62.4				
SHUMA TOT 1235.498								

Porositës:

BASHKIA MALËSI E MADHE

Titulli i Projektit
SISTEMIMI ASFALTIM RRUGA DEGEZIM I RRUGES KOPLIK-RAZEM PER TEK RRUGA E REÇIT

Faza
PROJEKT ZBATIMI

Vula

Autor
"NOVATECH STUDIO" SHPK

ADMIN ING. EMIL NOVA

Grupi projektimit:

ING. NDERTIMI	Mimoza TOMCO
ARKITEKT	Gerta NOVA
ING. HIDROTEKNIK	Klodjan NDOJ
ING. HIDROTEKNIK	Kostandin NOVA
ING. GJEOLGJIK	Antonela BAZHDARI
ING. NDERTIMI	Petrika DOKU

Kapitulli
PROJEKT ARKITEKTONIK

Titulli i Vizatimit
ARMIMI I URES/SOLETA

Realizuar **DHJETOR 2022** Shkalla **1:100**

Emërtimi i Fletës
K1 - 02