

PROFILI GJATESOR I RRUGES KRYESORE (1 NGA 2)

SHKALLA A1-1:200 / A3-1:400

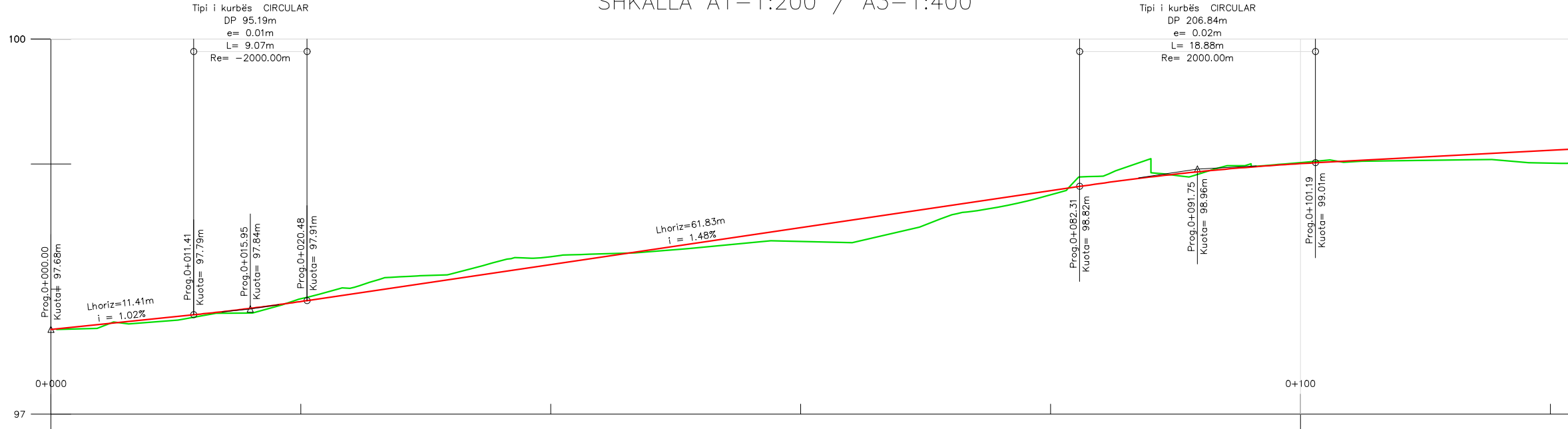

Piketa:	0+000	0+010	0+011	0+020	0+030	0+034	0+040	0+043	0+050	0+060	0+070	0+073	0+080	0+082	0+085	0+088	0+090	0+100	0+101	0+110	0+120	
Ds-Pjesore:	0	10	1	8	8	4	6	3	7	10	10	3	7	2	2	4	2	18	1	9	10	
Ds-Progressive:	0	10	11	20	30	34	40	43	50	60	70	73	80	82	85	88	90	108	109	110	120	
Kuota-Tokës:		97.75	97.77	97.92	98.11	98.17	98.26	98.28	98.32	98.38	98.52	98.60	98.75	98.90	98.92	98.93	98.91	99.02	99.02	99.03	99.01	
Kuota Projektit:	97.68	97.78	97.79	97.91	98.04	98.10	98.20	98.24	98.34	98.49	98.64	98.68	98.79	98.82	98.85	98.90	98.92	99.00	99.01	99.06	99.11	
Th-Gërmim:				0.02	0.07	0.07	0.06	0.04	0.02	0.11	0.12	0.08	0.04	0.08	0.07	0.03	0.01	0.01	0.01	0.03	0.10	
H-Mbushje:	1.65	0.03	0.02						0.02	0.11	0.12	0.08	0.04	0.08	0.07	0.01	0.01			0.03	0.10	
Kthesat në-plan:	L= 19.84m		Rk= 15.00m Lk= 9.68m		L= 4.25m		Rk= -15.00m Lk= 9.33m				L= 29.42m				L= 3.56m		Rk= 15.00m Lk= 12.14m		L=			
Pjerrësia & Distanca:	K=97.68		i=1.023% L=15.947m		K=97.84		i=1.476% L=75.804m				K=98.96											

Bashkia Tirane

OBJEKTI:

"LAGJIA E ARTISTEVE"

Emertimi:
Realizimi i objektit "Lagjia e
Artisteve"

SHENIME TEKNIKE:

Inxh. Engjell ÇAKA
Inxh. Liliana Vllamasi

Projektes:

Inxh. Liliana VLLAMASI
Inxh. Engjell ÇAKA
Gjeo. Haxhi PERVANA
Gjeo. Iv BEQARI
Elek. Besmir LUMANI
Hidr. Majlinda KONCI
Ark. Besian MUHARREMI

Emertimi i fletes:
Profilet Gjatesore

SHKALLA
FLETA
A13



"Arabel - Studio Arabel" Sh.p.k Adresa: Dher, Prahocës, Gjeo. Driçkaj, Tiranë, Rruga Ahmet Gjatah, Pallat 34, Shkallë 3, Apartament Nr. 20 Ndërtuesi: E.Ç. s.f.r.	"TRANSSPORT HIGHWAY CONSULTING" Sh.p.k Adresa: Tiranë, Komuna Pajitë, Rruga Osman Myzeqer, Pallat Shekulli	"Dricons" Sh.p.k Adresa: Tiranë, Komuna Pajitë, Rruga Osman Myzeqer, Pallat Shekulli
---	---	---

POROSITESI: Bashkia Tirane

PROFILI GJATESOR I RRUGES KRYESORE (2 NGA 2)

SHKALLA A1-1:200 / A3-1:400

Piketa:	0+120	0+130	0+140	0+146	0+150	0+156	0+159	0+160	0+165	0+170	0+173	0+180
Ds-Pjesore:	10	10	10	6	4	6	3	1	5	5	3	7
Ds-Progressive:	120	130	140	146	150	156	159	160	165	170	173	180
Kuota-Tokës:	99.01	99.11	99.19	99.22	99.31	99.30	99.32	99.31	99.40	99.25	99.16	99.16
Kuota Projektit:	99.11	99.16	99.22	99.25	99.27	99.30	99.31	99.31	99.27	99.20	99.16	99.16
Th-Gërmim:					0.04		0.01		0.13	0.05		
H-Mbushje:	0.10	0.05	0.03	0.03								
Kthesat në-plan:	L= 45.63m			L= 14.39m								
Pjerrësia & Distanca:	i=0.532% L=68.570m			<div style="display: flex; justify-content: space-around; align-items: center;"> <div style="text-align: center;"> <p>Rk= -8.00m Lk= 12.65m</p> </div> <div style="text-align: center;"> <p>K=99.33</p> </div> <div style="text-align: center;"> <p>i=-1.275% L=12.678m</p> </div> <div style="text-align: center;"> <p>K=99.16</p> </div> </div>								

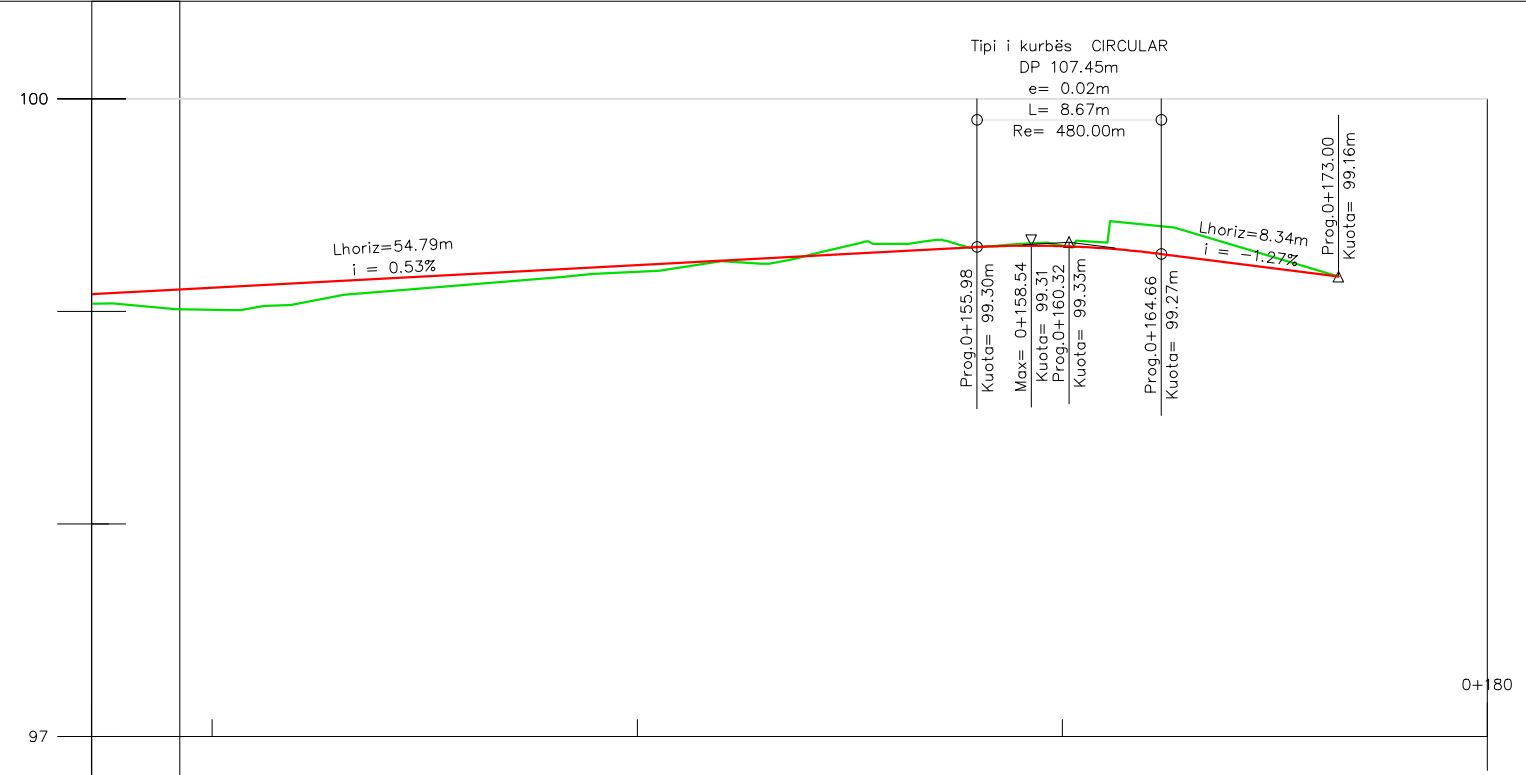

Emertimi i fletës:
Profilet Gjatesore

SHKALLA FLETA
A13

Projektoes:

Inxh. Liliana VLLAMASI
Inxh. Engjell ÇAKA
Gjeo. Haxhi PERVANA
Gjeo. Iv BEQARI
Elek. Besmir LUMANI
Hidr. Majlinda KONCI
Ark. Besian MUHARREMI

SHENIME TEKNIKE:

Inxh. Engjell ÇAKA
Inxh. Liliana Vllamasi

Bashkia Tirane

OBJEKTI:

"LAGJIA E ARTISTEVE"

Emertimi:
Realizimi i objektit "Lagjia e Artisteve"

"Arabel - Studio Arabel" Sh.p.k	"TRANSSPORT HIGHWAY CONSULTING" Sh.p.k	"Dricons" Sh.p.k
Adresa: Dher, Prahocës, Gjeo. Driçë, Tiranë, Rruga Ahmet Gjata, Pallat 34, Shkalla 3, Apartament Nr. 20, Ndërtues Nr. 05	Adresa: Tiranë, Komuna Prishtë, Rruga Osman Myzeqer, Pallat Shekulli	Adresa: Tiranë, Komuna Prishtë, Rruga Osman Myzeqer, Pallat Shekulli

POROSITESI: Bashkia Tirane

PROFILI GJATESOR I RRUGES SEKONDARE Nr.1 DHE RAKORDIMEVE

SHKALLA A1-1:200 / A3-1:400

Rruga sekondar Nr.1

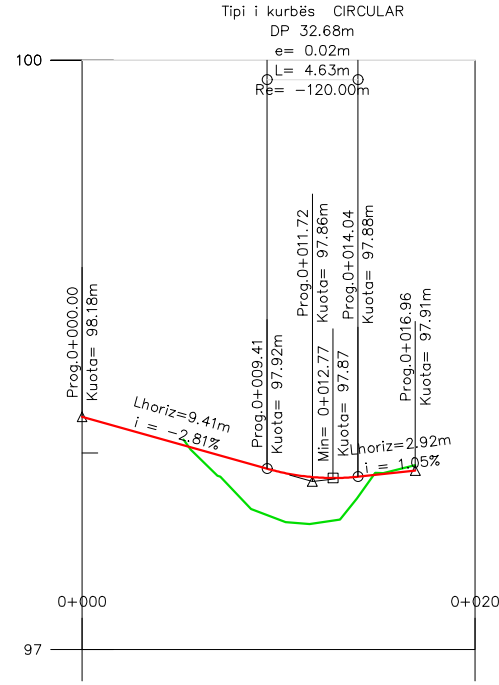

Piketa:	0+000	0+009	0+010	0+014	0+017	0+020
Ds-Pjesore:	0	9	10	4	3	3
Ds-Progressive:	0	10	14	17	20	
Kuota-Tokës:		97.88	97.86	97.78	97.94	
Kuota Projektit:	98.18	97.92	97.91	97.88	97.91	97.94
Th-Gërmim:				0.03		
H-Mbushje:	9.58	0.24	0.25	0.10		
Kthesat në-plan:	L = 16.96m					
Pjerrësia & Distanca:						

Kth_Mj_1

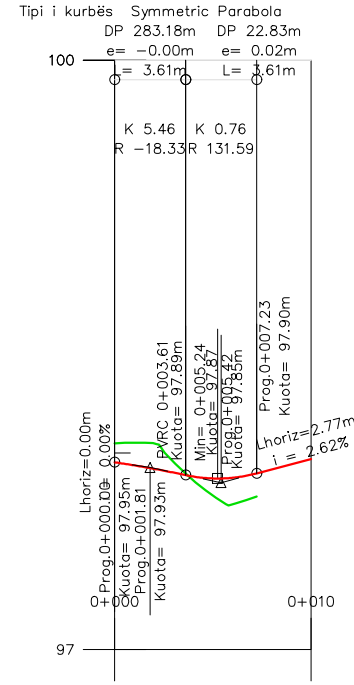

Piketa:	0+000	0+004	0+007	0+010
Ds-Pjesore:	0	4	4	3
Ds-Progressive:	0	4	7	10
Kuota-Tokës:		97.90	97.78	
Kuota Projektit:	97.95	97.89	97.90	97.97
Th-Gërmim:	0.10	0.01		
H-Mbushje:			0.12	
Kthesat në-plan:	Rk = 6.00m Lk = 7.23m			
Pjerrësia & Distanca:				

Kth_Dj_1

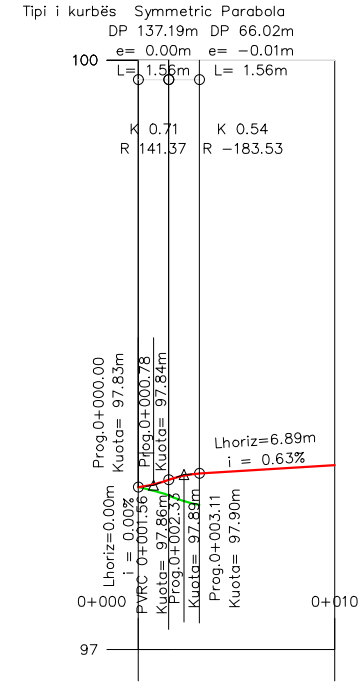

Piketa:	0+000	0+002	0+003	0+010
Ds-Pjesore:	0	2	2	7
Ds-Progressive:	0	2	3	10
Kuota-Tokës:		97.83	97.74	
Kuota Projektit:	97.83	97.86	97.90	97.94
Th-Gërmim:				
H-Mbushje:		0.08	0.16	
Kthesat në-plan:	Rk = -2.00m Lk = 3.11m			
Pjerrësia & Distanca:				

"Arabel - Studio Arabel" Sh.p.k	"TRANSSPORT HIGHWAY CONSULTING" Sh.p.k	"Dricons" Sh.p.k
Adresa: Dheer, Prahocës, Gjeq, Durrës, Buzë, Rrethi i Gjakovës, Rruga Durrës-Myslym Sh. Nr. 20, Ndërtuesi Nr. 05	Adresa: Tiranë, Kuzhva e Pashës, Rruga Mehmet Gjakova, Pallat 34, Shkallë 3, Apartament Nr. 20	Adresa: Tiranë, Kuzhva e Pashës, Rruga Osman Myzeqerit, Pallat Shekulli

Bashkia Tirane	OBJEKTI:	"LAGJIA E ARTISTEVE"
SHENIME TEKNIKE:		Emertimi: Realizimi i objektit "Lagjia e Artisteve"

Projektoes:	Inxh. Liliana VLLAMASI Inxh. Engjell ÇAKA Gjeo. Haxhi PERVANA Gjeo. Iv BEQARI Elek. Besmir LUMANI Hidr. Majlinda KONCI Ark. Besian MUHARREMI
-------------	--

Emertimi i fletes: Profilet Gjatesore	FLETA	A13
SHKALLA	FLETA	

POROSITESI: Bashkia Tirane

PROFILI GJATESOR I RRUGES SEKONDARE Nr.2 DHE RAKORDIMEVE
SHKALLA A1-1:200 / A3-1:400

Rruga sekondar Nr.2

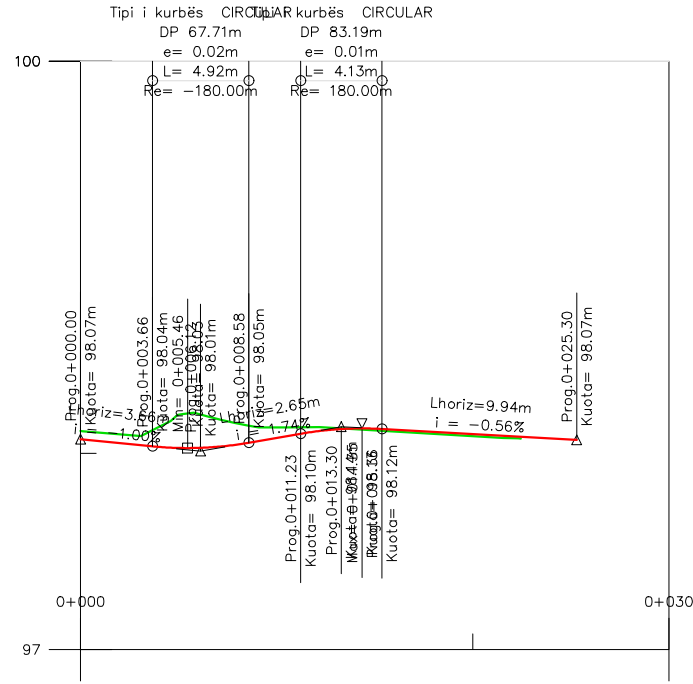

Piketa:	0+000	0+004	0+009	0+018	0+011	0+015	0+020	0+025	0+030
Ds-Pjesore:	0	6	5	4	1	4	5	6	5
Ds-Progresive:	0	4	9	18	11	15	20	25	30
Kuota-Tokës:	98.11	98.13	98.14	98.13	98.13	98.12	98.09	98.07	
Kuota Projektit:	98.07	98.05	98.05	98.08	98.10	98.12	98.10	98.07	
Th-Gërmim:	0.04	0.08	0.09	0.05	0.03				
H-Mbushje:							0.01	3.80	
Kthesat në-plan:	L = 3.95m		L = 14.83m						
Pjerrësia & Distanca:	K=98.07, L=1.9m, i=1.476%		K=98.01, L=7.36m, i=1.476%		K=98.14, L=7.17m, i=1.476%		K=98.07, L=12.00m, i=-0.56%		

Kth_Mj_2

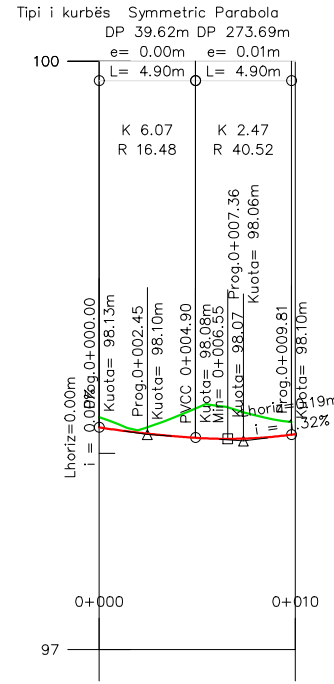

Piketa:	0+000	0+005	0+010
Ds-Pjesore:	0	5	6
Ds-Progresive:	0	5	10
Kuota-Tokës:	98.19	98.23	98.16
Kuota Projektit:	98.13	98.08	98.10
Th-Gërmim:	0.06	0.15	0.06
H-Mbushje:			
Kthesat në-plan:	Rk= -5.00m, Lk= 9.81m		
Pjerrësia & Distanca:	K=98.10, L=1.476m, i=1.476%; K=98.06, L=1.319m, i=1.476%; K=98.06, L=12.452m, i=-0.56%		

Kth_Dj_2

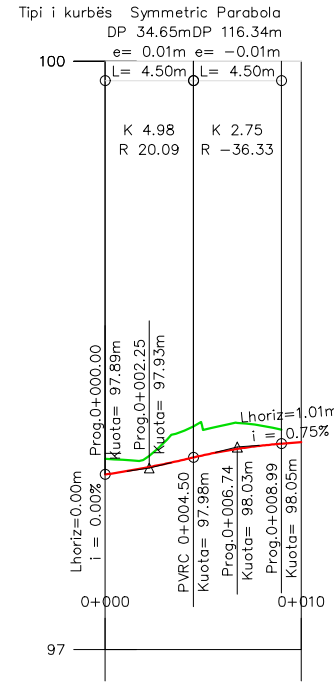

Piketa:	0+000	0+004	0+009	0+010
Ds-Pjesore:	0	4	4	1
Ds-Progresive:	0	4	9	10
Kuota-Tokës:	97.97	98.14	98.12	
Kuota Projektit:	97.89	97.98	98.05	98.06
Th-Gërmim:	0.08	0.16	0.07	
H-Mbushje:				
Kthesat në-plan:	Rk= 5.00m, Lk= 8.99m			
Pjerrësia & Distanca:	i=1.476%, L=12.248m, K=97.93, L=1.476m, i=1.476%; K=98.03, L=12.248m, i=0.748%			

"Arabel - Studio Arabel" Sh.p.k	"TRANSPORT HIGHWAY CONSULTING" Sh.p.k	"Dricons" Sh.p.k
Adresa: Dher, Prahovo, Gjeo Doci, Transp. Rruga M. N. Gjeo Doci, Pallat 34, Shkalla 3, Apartament Nr. 20, Ndërtues Nr. 05	Adresa: Transp. Kontrakti Pakti Rruga M. N. Gjeo Doci, Pallat 34, Shkalla 3, Apartament Nr. 20	Adresa: Transp. Kontrakti Pakti Rruga M. N. Gjeo Doci, Pallat 34, Shkalla 3, Apartament Nr. 20

Bashkia Tirane	OBJEKTI:	"LAGJIA E ARTISTEVE"
Emertimi: Realizimi i objektit "Lagjia e Artisteve"		

SHENIME TEKNIKE:	Inxh. Engjell CAKA Inxh. Liliana Vllamasi
------------------	--

Projektes:

Inxh. Liliana VLLAMASI
Inxh. Engjell CAKA
Gjeo. Haxhi PERVANA
Gjeo. Iv BEQARI
Elek. Besmir LUMANI
Hidr. Majlinda KONCI
Ark. Besian MUHARREMI

Emertimi i fletes: Profilet Gjatesore	FLETA	A13
SHKALLA		

POROSITESI: Bashkia Tirane

PROFILI GJATESOR I RRUGES SEKONDARE Nr.3 DHE RAKORDIMEVE
SHKALLA A1-1:200 / A3-1:400

Rruga sekondar Nr.3

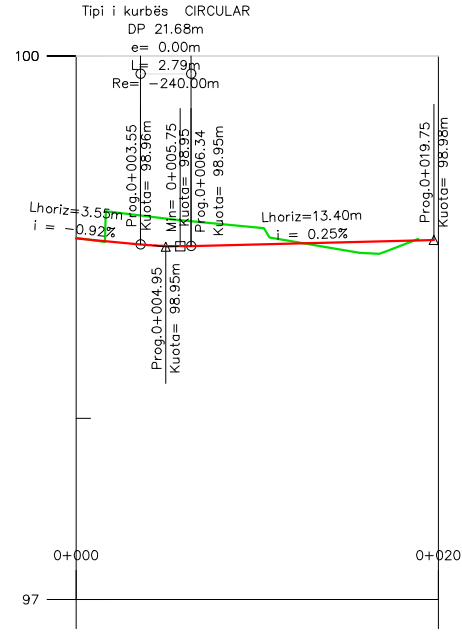

Piketa:	0+000	0+004	0+006	0+010	0+019
Ds-Pjesore:	0	4	3	4	9
Ds-Progresive:	0	4	6	10	19
Kuota-Tokës:	99.00	99.12	99.09	99.05	98.99
Kuota Projektit:	98.99	98.96	98.95	98.96	98.98
Th-Gërmim:	0.01	0.16	0.14	0.09	0.01
H-Mbushje:					
Kthesat në-plan:	L = 18.89m				
Pjerrësia & Distanca:					

Kth_Mj_3

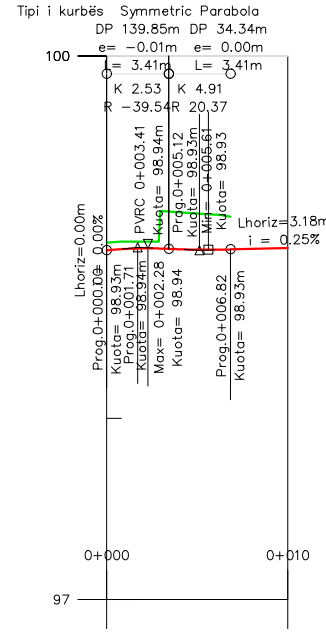

Piketa:	0+000	0+003	0+007	0+010
Ds-Pjesore:	0	3	3	3
Ds-Progresive:	0	3	7	10
Kuota-Tokës:	98.97	99.14	99.11	98.94
Kuota Projektit:	98.93	98.94	98.93	98.94
Th-Gërmim:	0.04	0.20	0.18	
H-Mbushje:				
Kthesat në-plan:				
Pjerrësia & Distanca:				

Kth_Dj_3

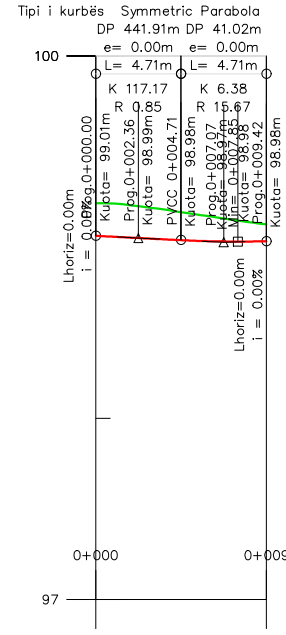

Piketa:	0+000	0+005	0+009
Ds-Pjesore:	0	5	5
Ds-Progresive:	0	5	9
Kuota-Tokës:	99.19	99.14	99.07
Kuota Projektit:	99.01	98.98	98.98
Th-Gërmim:	0.18	0.16	0.09
H-Mbushje:			
Kthesat në-plan:			
Pjerrësia & Distanca:			

Bashkia Tirane

OBJEKTI:

"LAGJIA E ARTISTEVE"

Emertimi:
Realizimi i objektit "Lagjia e
Artisteve"

SHENIME TEKNIKE:

Inxh. Engjell ÇAKA
Inxh. Liliana Vllamasi

Projektues:

Inxh. Liliana VLLAMASI
Inxh. Engjell ÇAKA
Gjeo. Haxhi PERVANA
Gjeo. Iv BEQARI
Elek. Besmir LUMANI
Hidr. Majlinda KONCI
Ark. Besian MUHARREMI

Emertimi i fletes:
Profilet Gjatesore

FLETA

A13



"TRANSSPORT
HIGHWAY
CONSULTING"
Sh.p.k

Adresa:
Tirane, Komuna Pallat
Rruga Osman Myzeviz
Pallat Shekulli
Apartment Nr. 20

"Arabel -
Studio Arabel"
Sh.p.k

Adresa:
Dharrë, Prahocë, Gjeo. Dajç
Tirane, Rruga M. Gërvalla
Pallat 34, Shekulli 3
Apartment Nr. 20

POROSITESI: Bashkia Tirane

PROFILI GJATESOR I RRUGES SEKONDARE Nr.4 DHE RAKORDIMEVE
SHKALLA A1-1:200 / A3-1:400

Rruga sekondar Nr.4

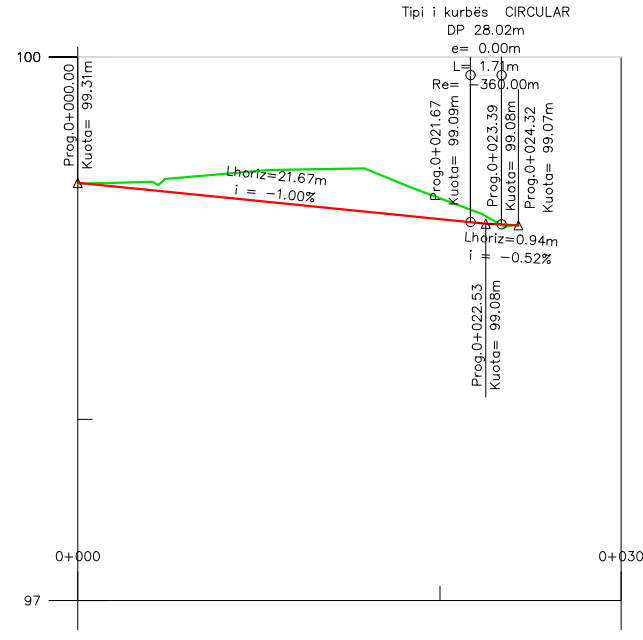

Kth_Mj_4

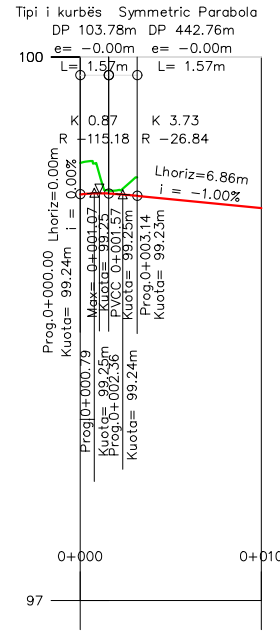

Kth_Dj_4

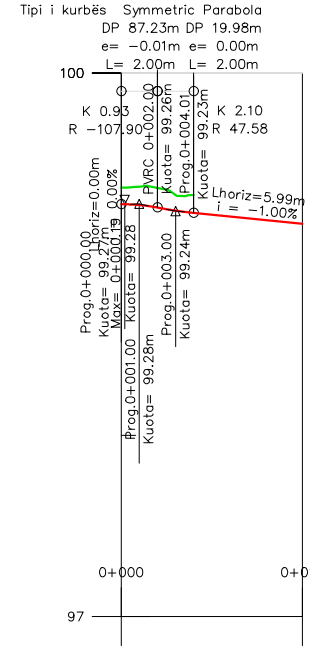

Piketa:	0+000	0+010	0+020	0+022	0+023	0+024	0+030
Ds-Pjesore:	0	10	10	2	2	0	6
Ds-Progresive:	0	10	20	22	23	24	30
Kuota-Tokës:	99.30	99.37	99.22	99.16	99.07	99.07	
Kuota Projektit:	99.31	99.21	99.11	99.09	99.08	99.07	
Th-Gërmim:		0.16	0.11	0.07			
H-Mbushje:	0.01			0.01			
Kthesat në-plan:	L = 24.35m						
Pjerrësia & Distanca:							

Piketa:	0+000	0+002	0+003	0+010
Ds-Pjesore:	0	2	2	7
Ds-Progresive:	0	2	3	10
Kuota-Tokës:	99.42	99.26	99.34	
Kuota Projektit:	99.24	99.25	99.23	99.17
Th-Gërmim:	0.18	0.01	0.11	
H-Mbushje:				
Kthesat në-plan:				
Pjerrësia & Distanca:				

Piketa:	0+000	0+002	0+004	0+010
Ds-Pjesore:	0	2	2	6
Ds-Progresive:	0	2	4	10
Kuota-Tokës:	99.37	99.37	99.33	
Kuota Projektit:	99.27	99.26	99.23	99.17
Th-Gërmim:	0.10	0.11	0.10	
H-Mbushje:				
Kthesat në-plan:				
Pjerrësia & Distanca:				

"Arabel - Studio Arabel" Sh.p.k	"TRANSSPORT HIGHWAY CONSULTING" Sh.p.k	"Dricons" Sh.p.k
Adresa: Dher, Prahocës, Gjatë Durrës-Elbasan, Nëntoria Nr.05	Adresa: Tiranë, Komuna Pallat Rruga Osman Myzeqerit, Pallat Nr.20	Adresa: Tiranë, Komuna Pallat Rruga Osman Myzeqerit, Pallat Shkollë

Bashkia Tirane	OBJEKTI:	"LAGJIA E ARTISTEVE"
		Emertimi: Realizimi i objektit "Lagjia e Artisteve"

SHENIME TEKNIKE:	Inxh. Engjell CAKA Inxh. Liliana Vllamasi
------------------	--

Projektues:	Inxh. Liliana VLLAMASI Inxh. Engjell CAKA Gjeo. Haxhi PERVANA Gjeo. Iv BEQARI Elek. Besmir LUMANI Hidr. Majlinda KONCI Ark. Besian MUHAREMI
-------------	---

Emertimi i fletes: Profilet Gjatesore	FLETA
SHKALLA	A13

POROSITESI: Bashkia Tirane

SEKSIONET TERTHORE PROGRESIVE TE RRUGES KRYESORE (1 NGA 9)

SHKALLA A1-1:100 / A3-1:200

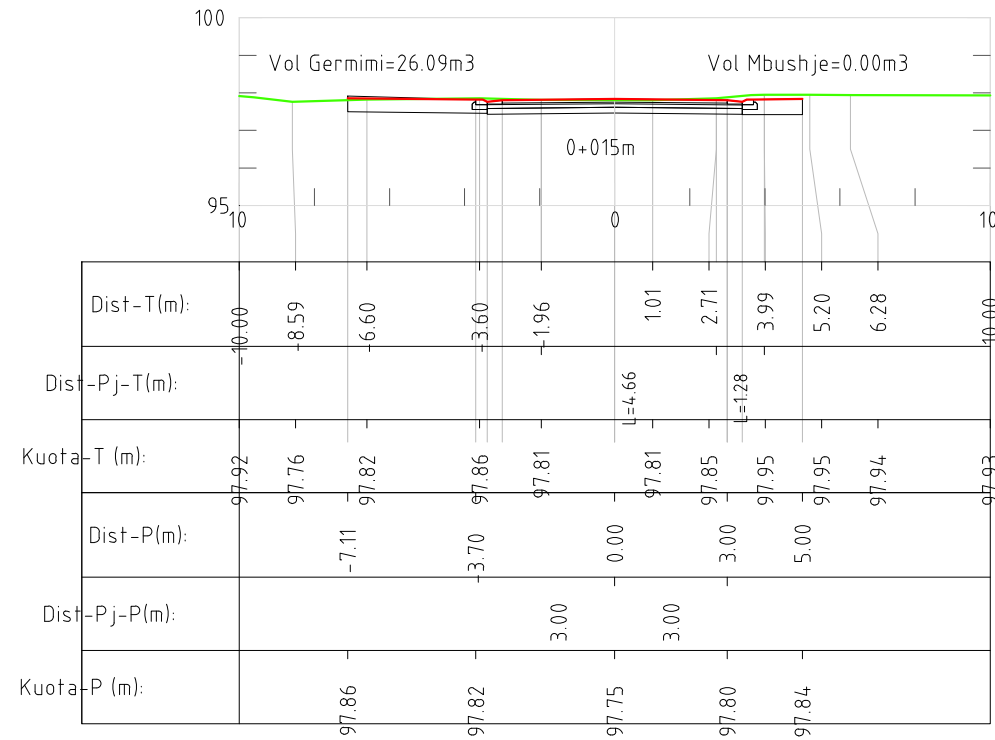
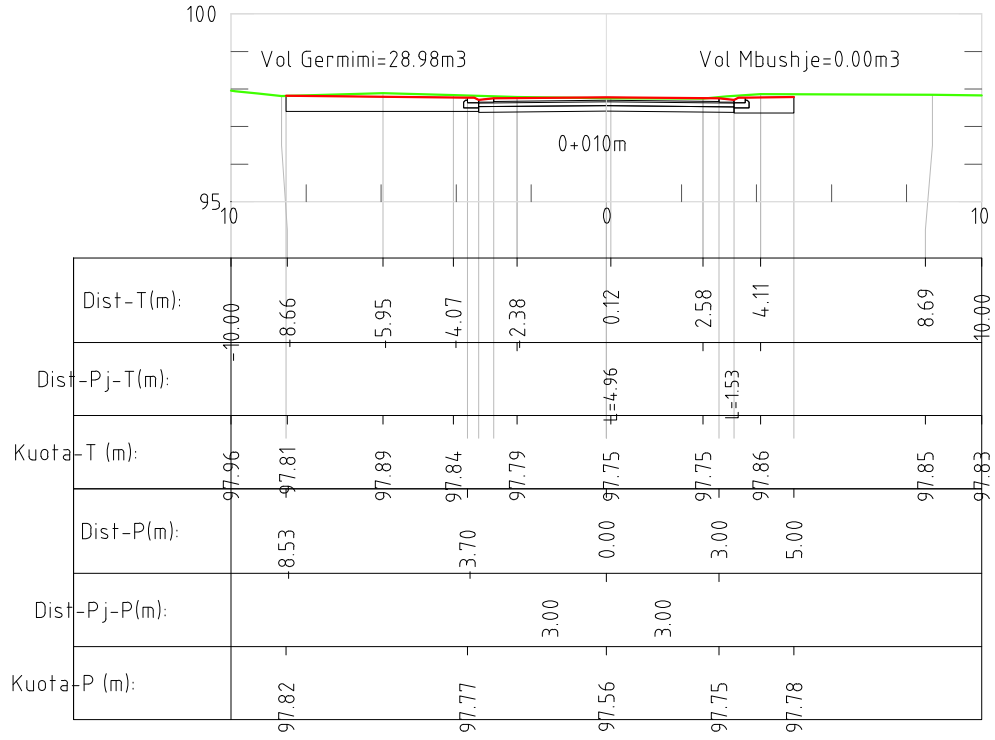
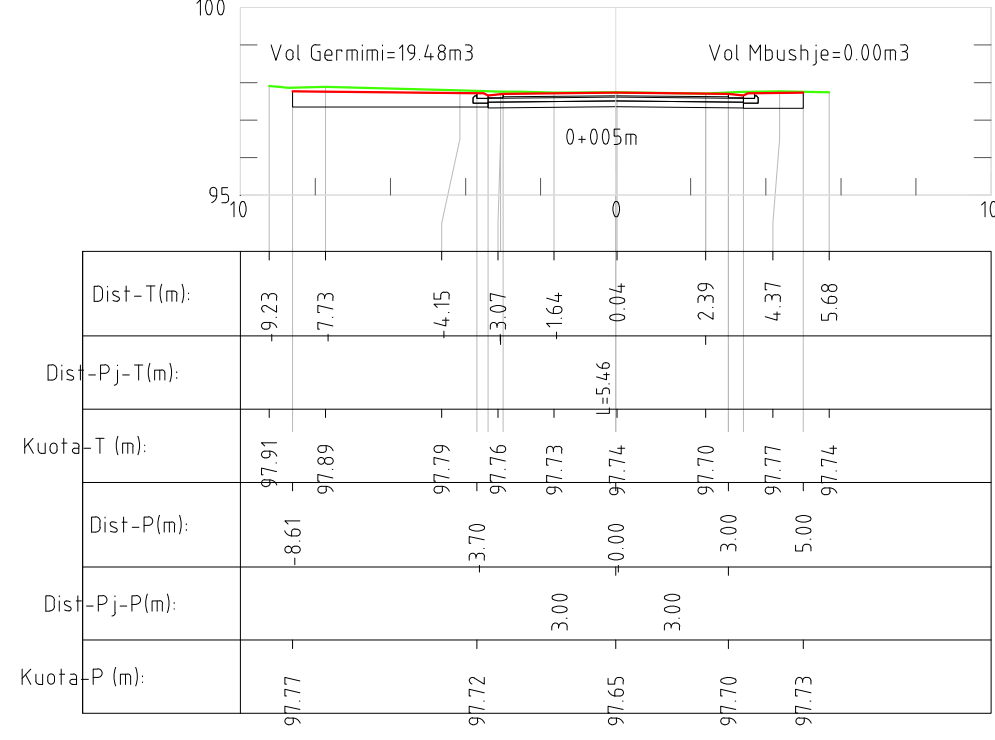
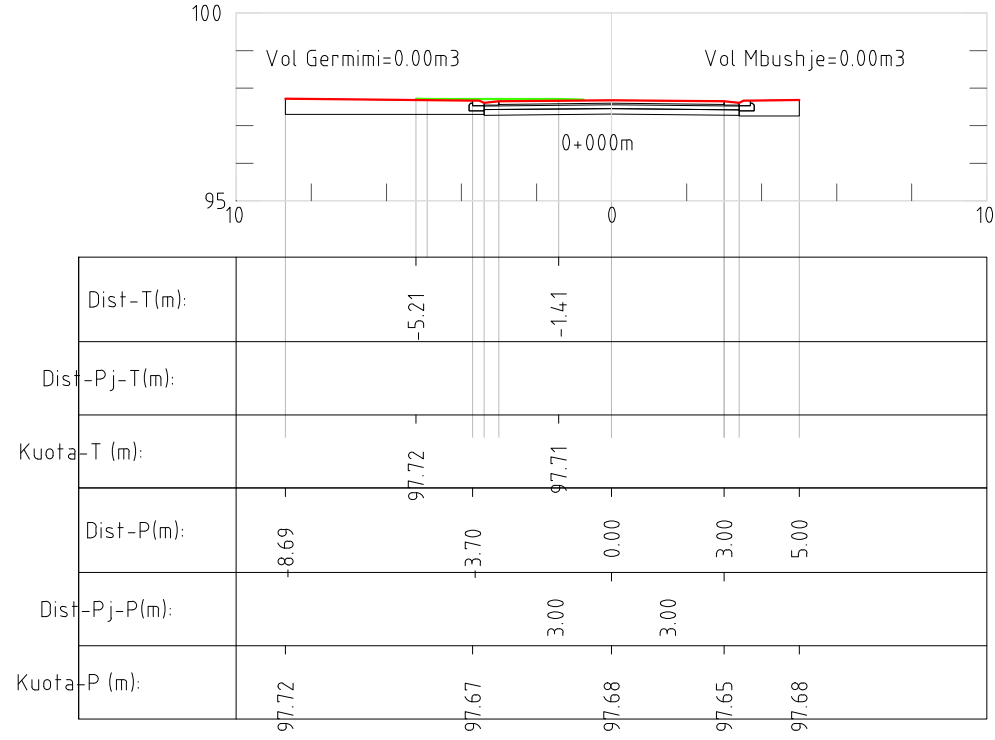

"Arabel - Studio Arabel" Sh.p.k	"TRANSPOH HIGHWAY CONSULTING" Sh.p.k	"Dricons" Sh.p.k
Adresa: Dher, Peshkopia, Gjeq, Durrës, Rrethi i Tiranës, Rruga e Kombit, Nr. 34, Shikimi 3, Ndërtimi Nr. 05	Adresa: Tiranë, Komuna e Pallatit, Rruga e Kombit, Nr. 20, Apartment Nr. 20	Adresa: Tiranë, Komuna e Pallatit, Rruga e Kombit, Nr. 20, Apartment Nr. 20

Bashkia Tirane
OBJEKTI:
"LAGJIA E ARTISTEVE"
Emertimi: Realizimi i objektit "Lagjia e Artisteve"

SHENIME TEKNIKE:
Inxh. Engjell ÇAKA Inxh. Liliana Vllamasi

Projektes:
Inxh. Liliana VLLAMASI Inxh. Engjell ÇAKA Gjeo. Haxhi PERVANA Gjeo. Iv BEQARI Elek. Besmir LUMANI Hidr. Majlinda KONCI Ark. Besian MUHARREMI

Emertimi i fletes: Profillet Terthore	FLETA
SHKALLA	A13
	

POROSITESI: Bashkia Tirane

SEKSIONET TERTHORE PROGRESIVE TE RRUGES KRYESORE (2 NGA 9)
SHKALLA A1-1:100 / A3-1:200

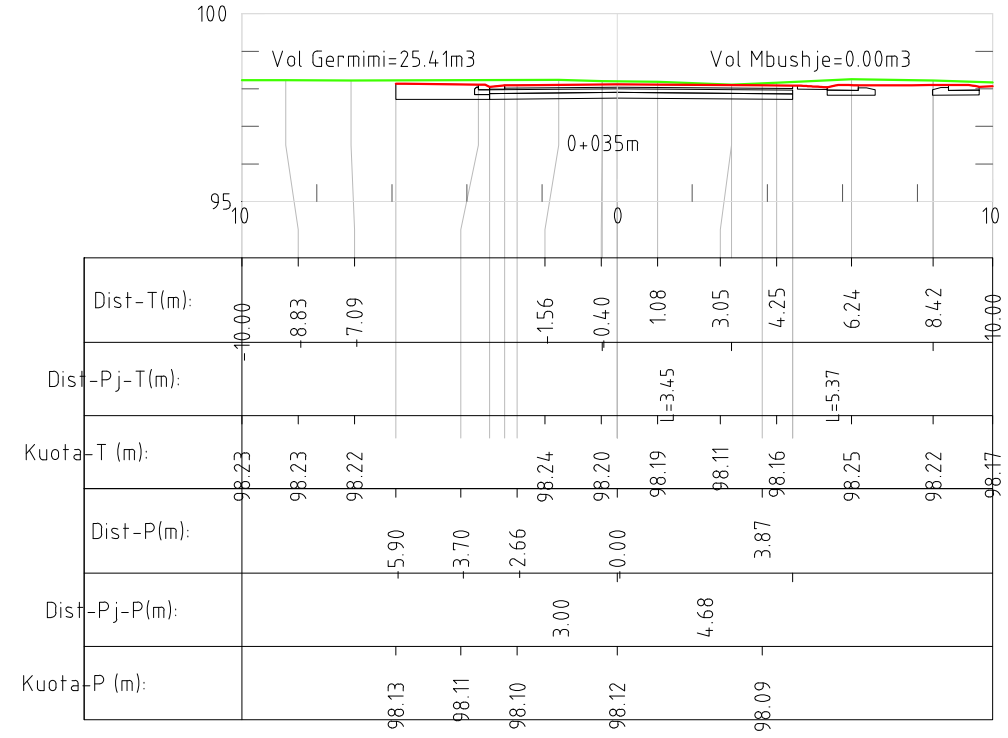
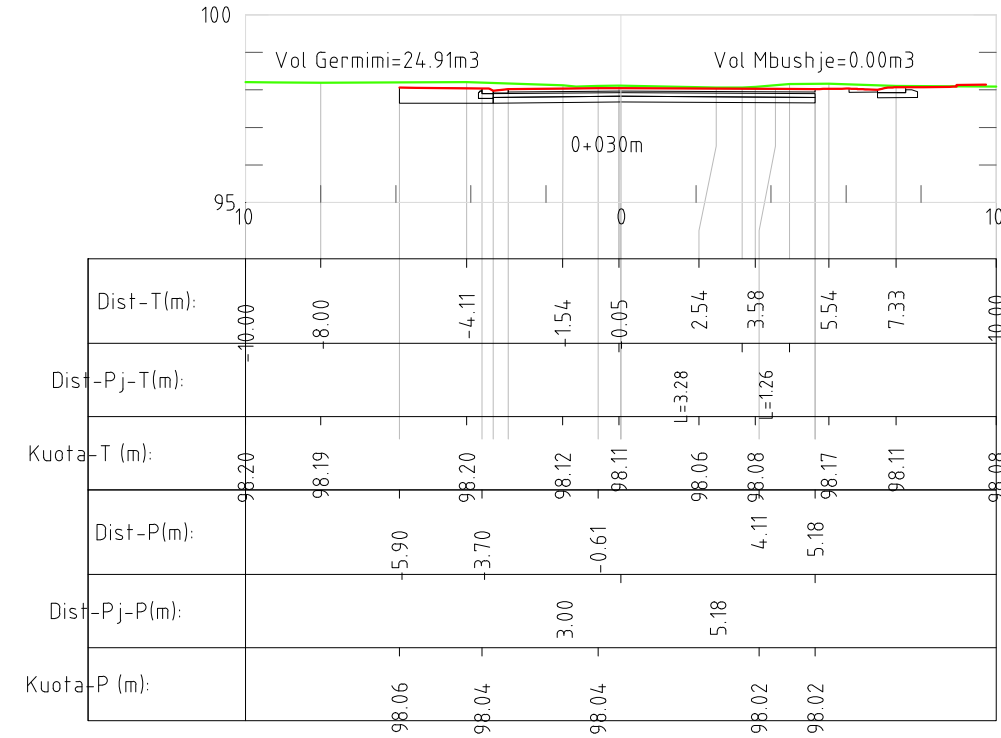
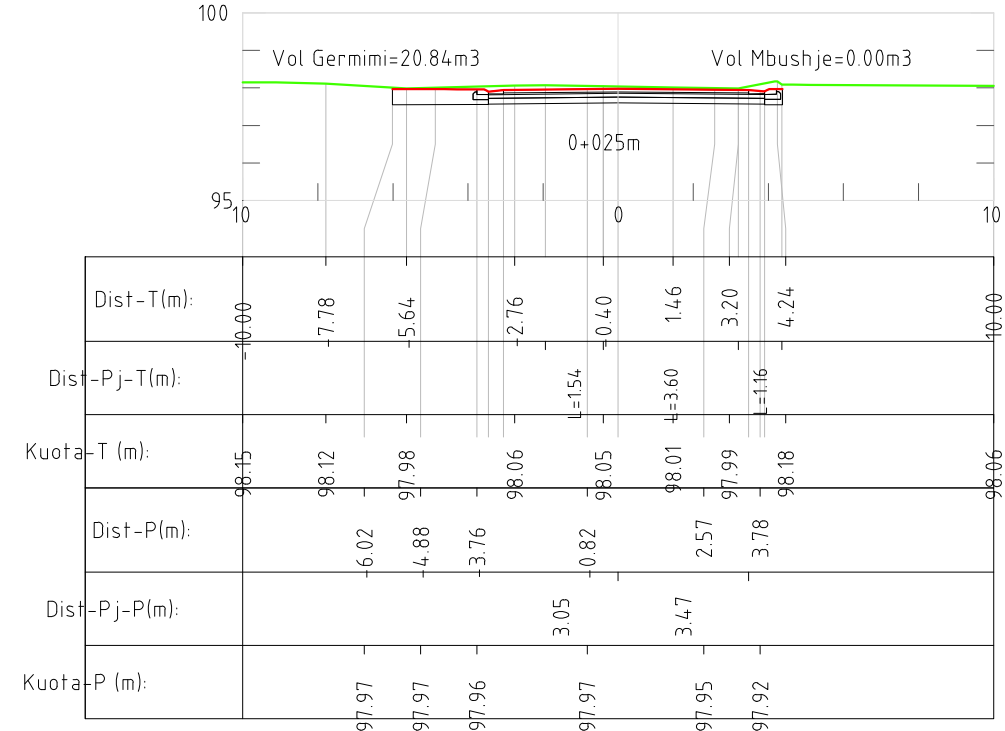
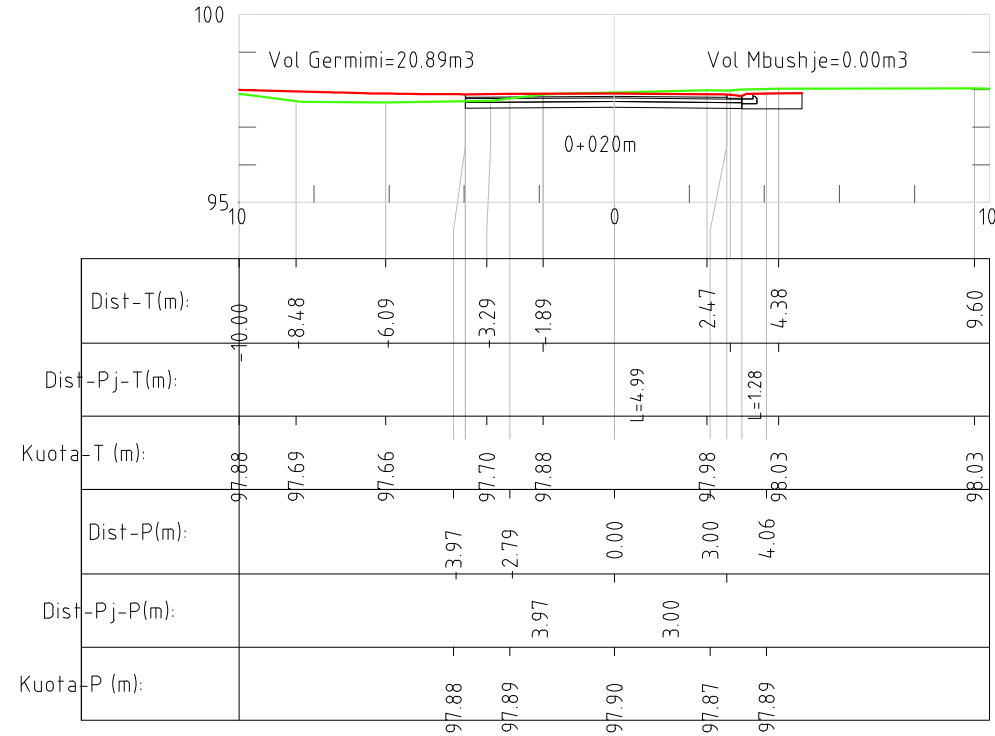

Emertimi i fletes:
Profillet Terthore

SHKALLA FLETA

A13



Projektues:

Inxh. Liliana VLLAMASI
Inxh. Engjell ÇAKA
Gjeo. Haxhi PERVANA
Gjeo. Iv BEQARI
Elek. Besmir LUMANI
Hidr. Majlinda KONCI
Ark. Besian MUHARREMI

Bashkia Tirane

OBJEKTI:

"LAGJIA E ARTISTEVE"

Emertimi:
Realizimi i objektit **"Lagjia e
Artisteve"**

"TRANSPO
HIGHWAY
CONSULTING"
Sh.p.k

"Arabel -
Studio Arabel"
Sh.p.k

"Dricons"
Sh.p.k

Adresa:
Tirane, Komuna Prishtine
Rruga Duman Myzez
Pallat Shekulli

Adresa:
Tirane, Komuna Prishtine
Rruga Duman Myzez
Pallat Shekulli
Apartment N. 20

Adresa:
Dher, Prahovo, Rrethi Durrës
Burrnesi Ezer iuri,
Nendesa Nr.05

POROSITESI: Bashkia Tirane

SEKSIONET TERTHORE PROGRESIVE TE RRUGES KRYESORE (3 NGA 9)

SHKALLA A1-1:100 / A3-1:200

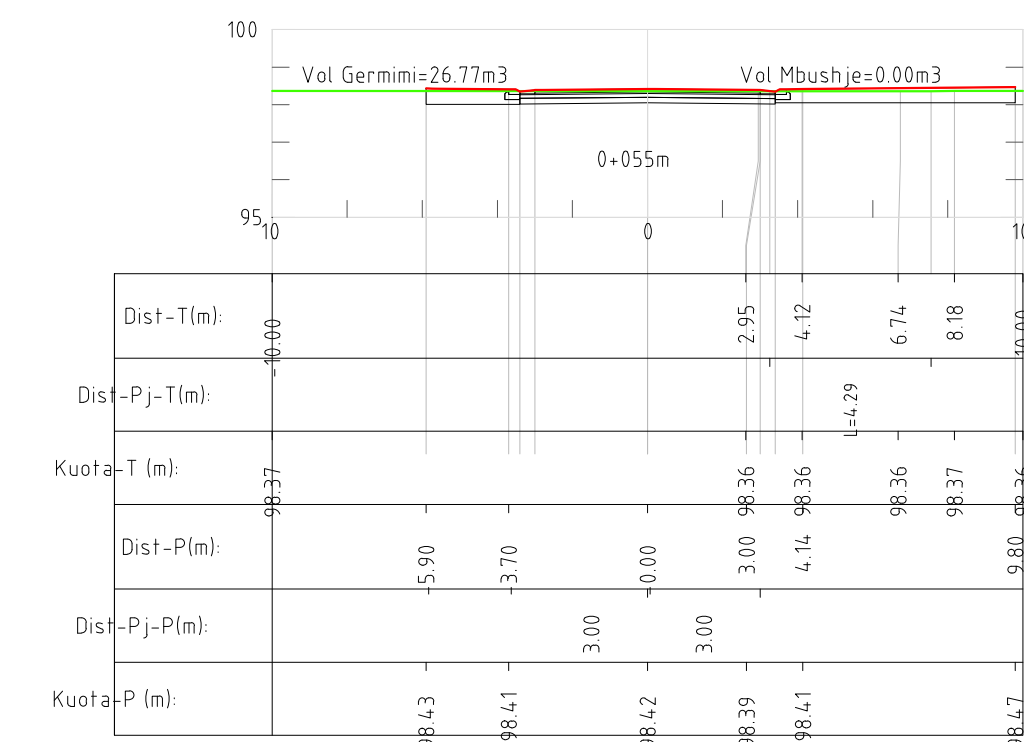
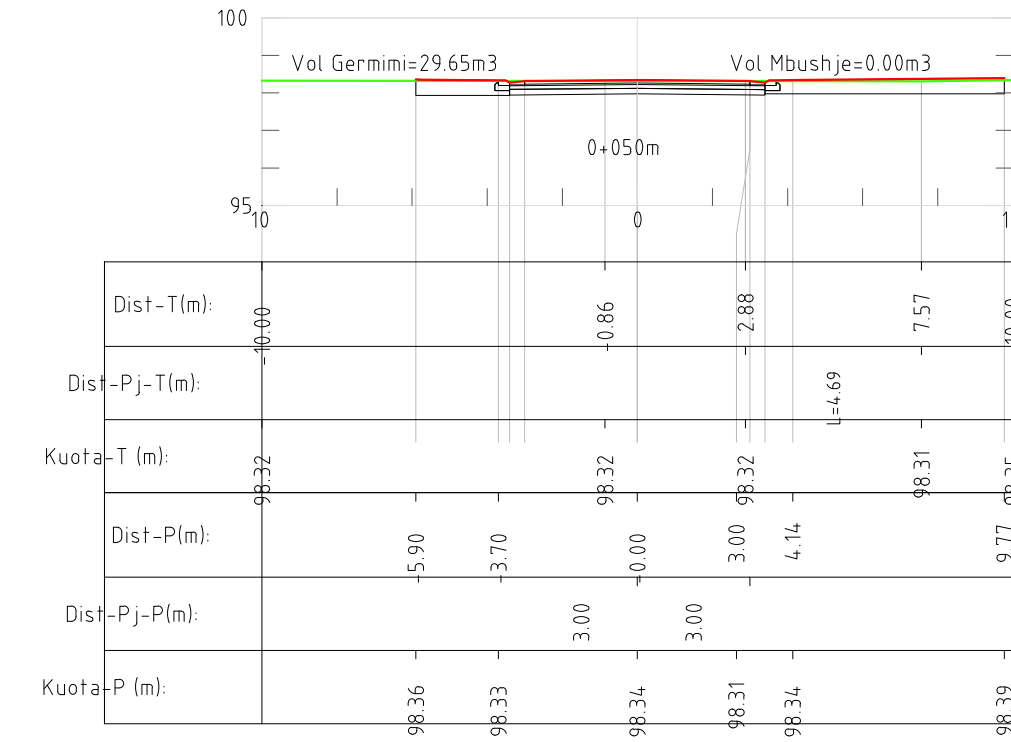
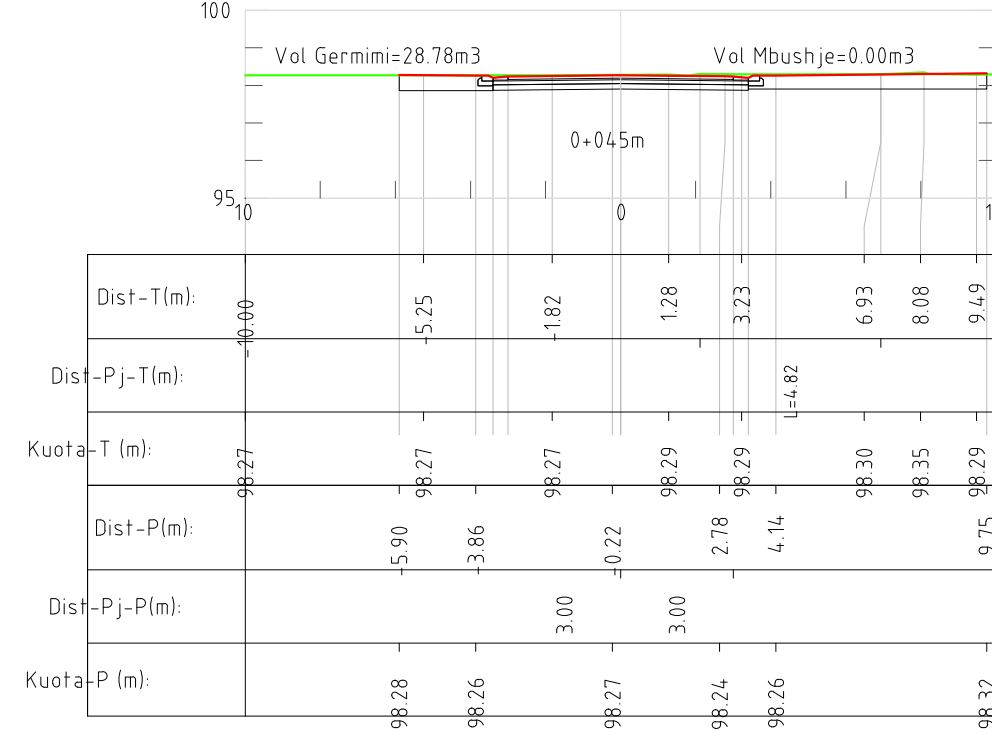
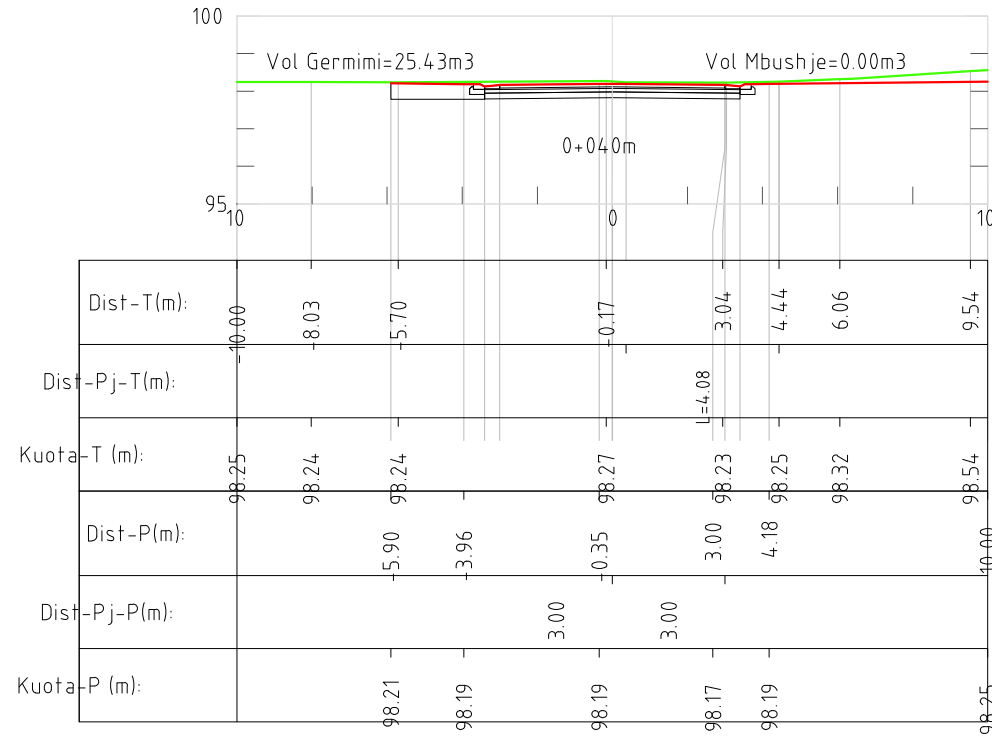

	Bashkia Tirane		"Dricons" Sh.p.k		"TRANSPORT HIGHWAY CONSULTING" Sh.p.k	
Emertimi i fletes: Profillet Terthore	SHKALLA FLETA A13	SHENIME TEKNIKE: Inxh. Engjell ÇAKA Inxh. Liliana Vllamasi	OBJEKTI: "LAGJIA E ARTISTEVE" Emertimi: Realizimi i objektit "Lagjia e Artisteve"	Projektes: Inxh. Liliana VLLAMASI Inxh. Engjell ÇAKA Gjeo. Haxhi PERVANA Gjeo. Iv BEQARI Elek. Besmir LUMANI Hidr. Majlinda KONCI Ark. Besian MUHARREMI	POROSITESI: Bashkia Tirane	<div style="display: flex; justify-content: space-between;"> <div style="width: 45%;"> Adresa: Dharrë, Prahocës, Rruga Gjeo Doci Bashkia e Elbasanit Ndërtues Nr.05 </div> <div style="width: 45%;"> Adresa: Tirane, Komuna Pallat Rruga Osman Myzeqer Pallat Shekulli </div> </div>

SEKSIONET TERTHORE PROGRESIVE TE RRUGES KRYESORE (4 NGA 9)
SHKALLA A1-1:100 / A3-1:200

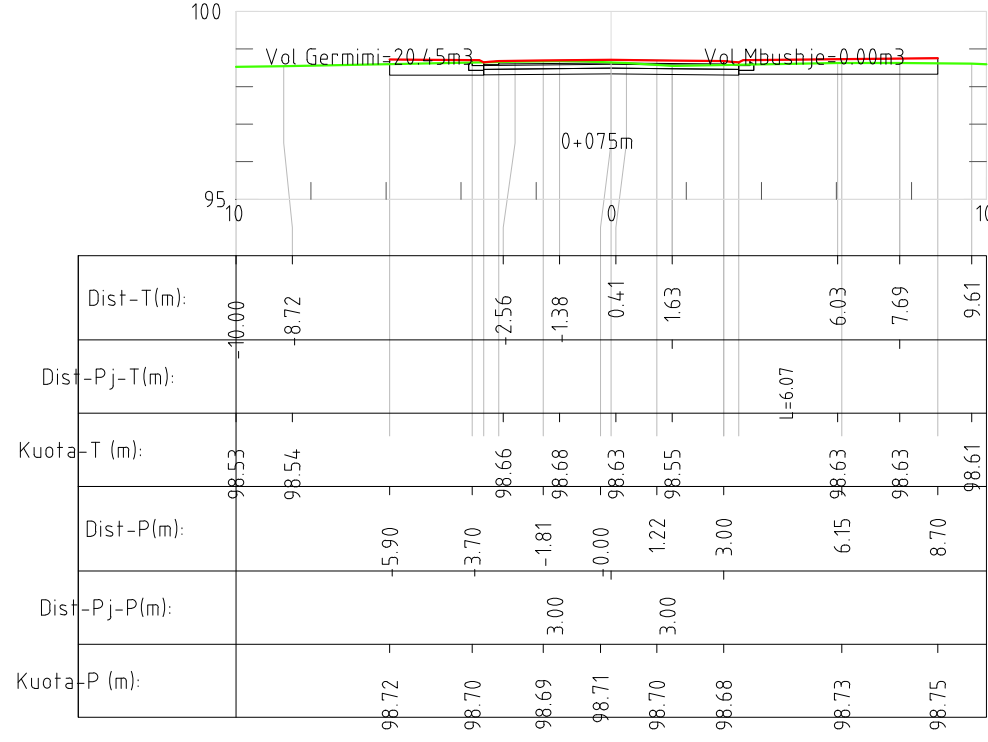
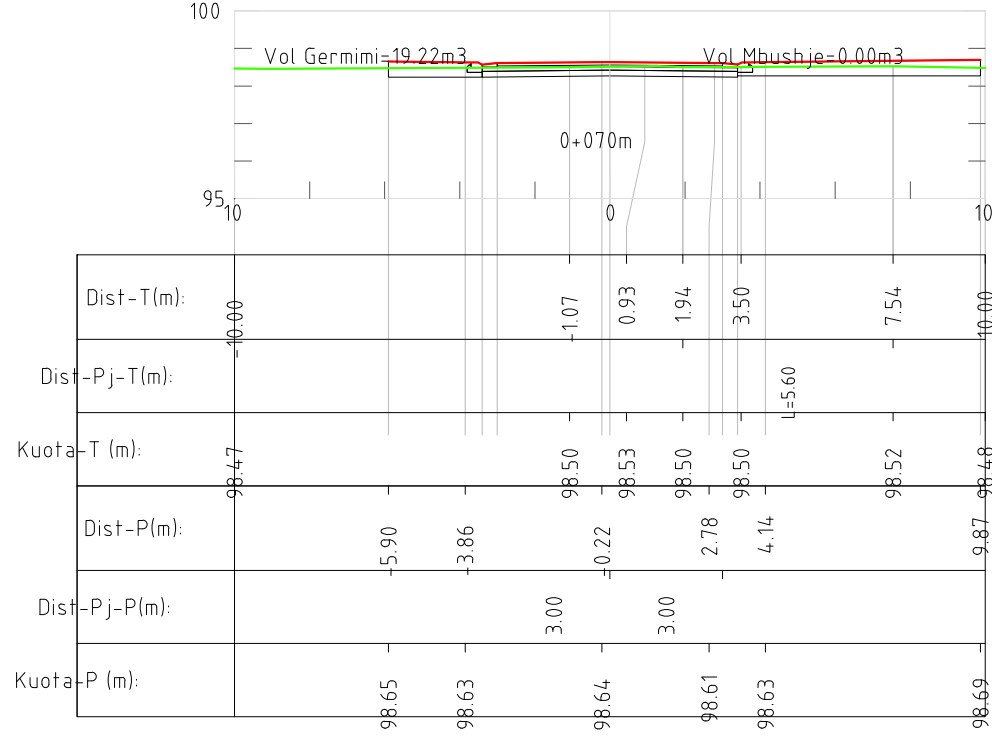
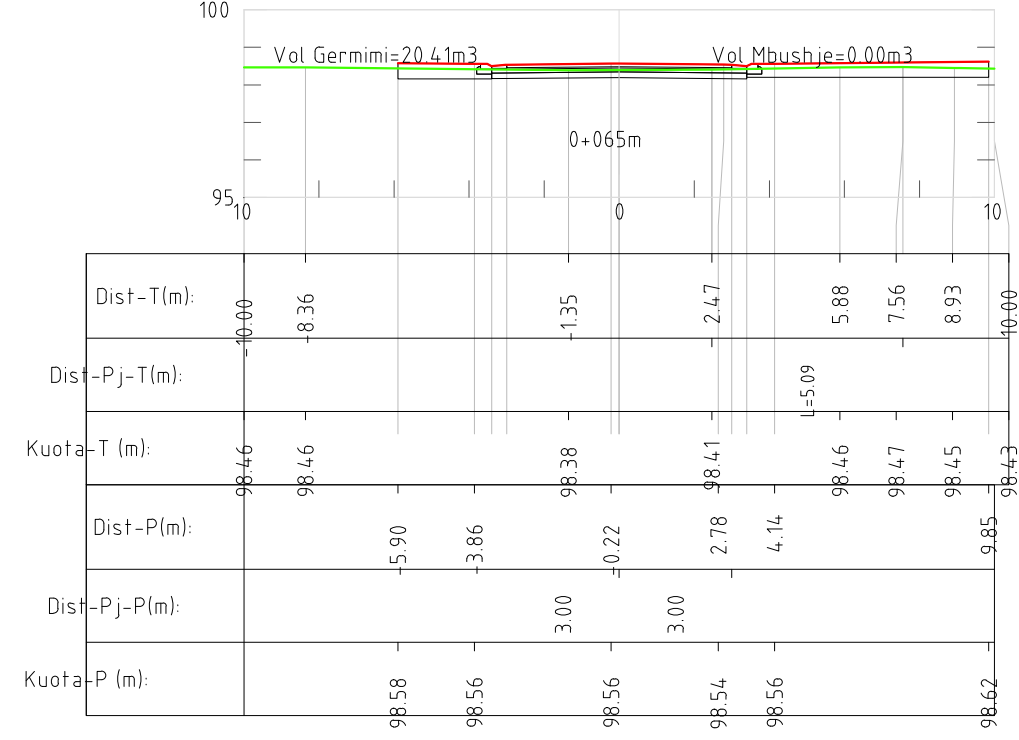
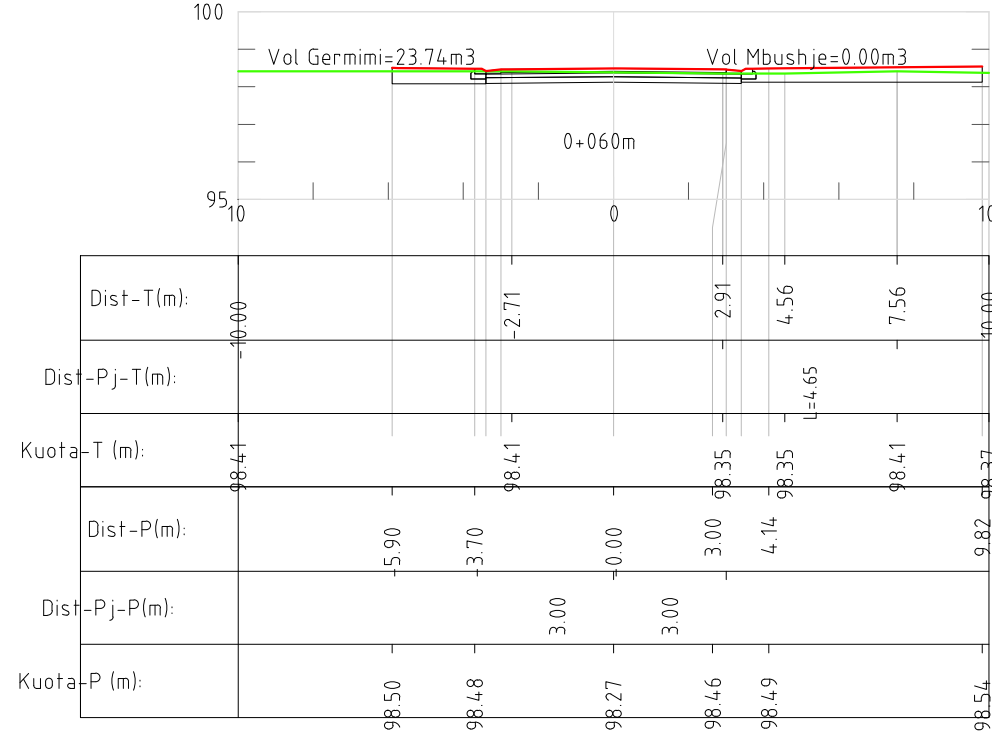

Emertimi i fletes: Profillet Terthore	SHKALLA FLETA	A13	Projektes: Inxh. Liliana VLLAMASI Inxh. Engjell ÇAKA Gjeo. Haxhi PERVANA Gjeo. Iv BEQARI Elek. Besmir LUMANI Hidr. Majlinda KONCI Ark. Besian MUHARREMI	SHENIME TEKNIKE: Inxh. Engjell ÇAKA Inxh. Liliana Vllamasi	Bashkia Tirane	"Arabel - Studio Arabel" Sh.p.k	"TRANSPORT HIGHWAY CONSULTING" Sh.p.k	"Dricons" Sh.p.k
						Adresa: Dher, Prahocës, Gjeo. Driçkaj, Tirane, Rruga Ahmet Gjatahja, Pallat 34, Shkalla 3, Apartament Nr. 20 Nendresa Nr.05	Adresa: Tirane, Komuna Prishtine, Rruga Osman Myzeqerit, Pallat Shekulli	
OBJEKTI: "LAGJIA E ARTISTEVE" Emertimi: Realizimi i objektit "Lagjia e Artisteve"						POROSITESI: Bashkia Tirane		

SEKSIONET TERTHORE PROGRESIVE TE RRUGES KRYESORE (5 NGA 9)

SHKALLA A1-1:100 / A3-1:200

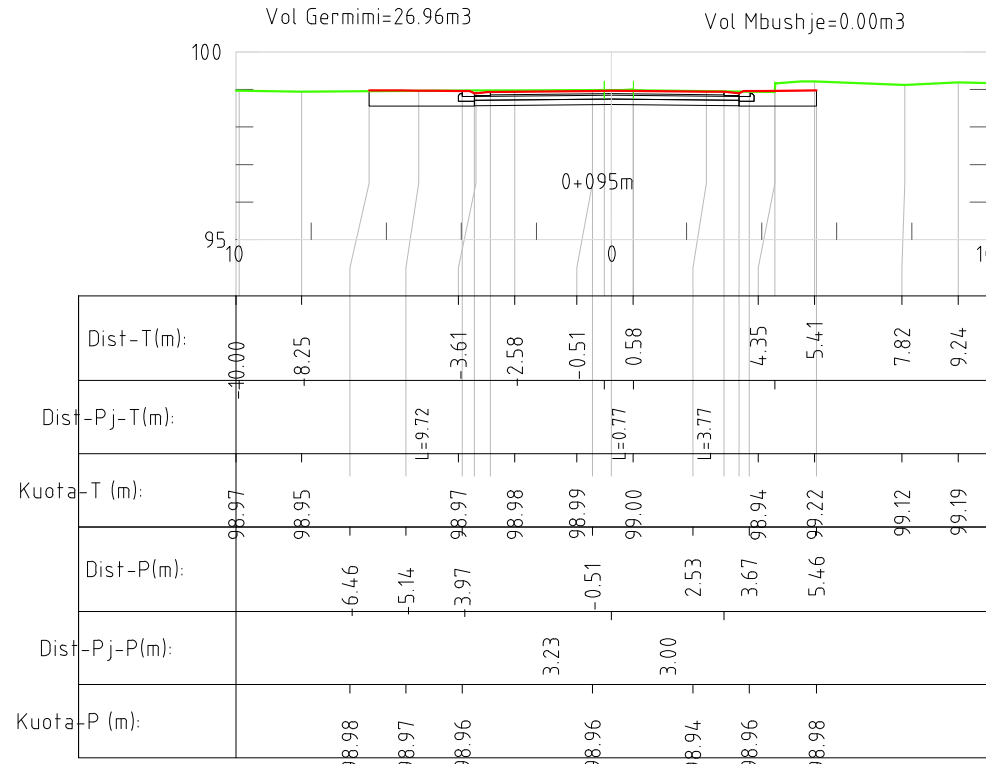
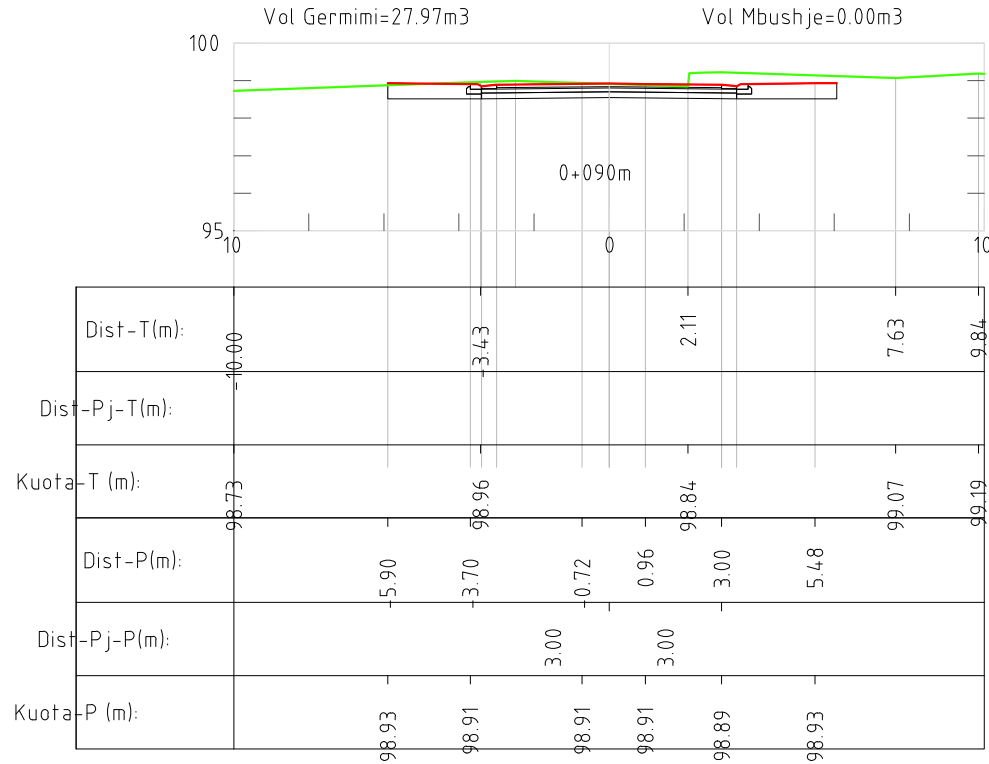
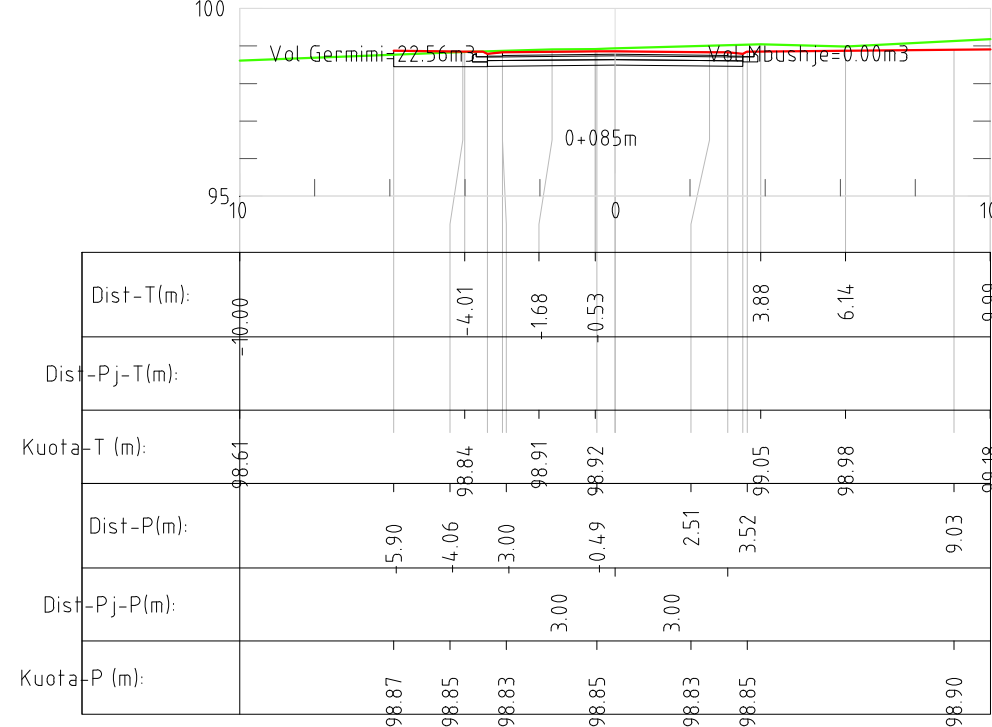
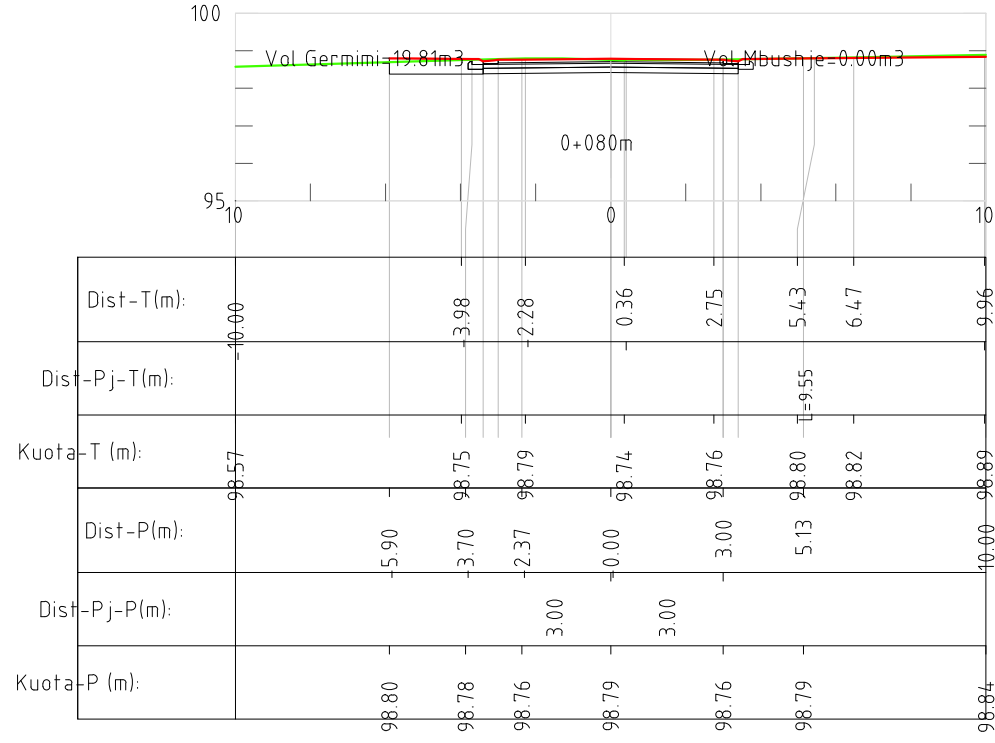

Emeritimi i fletes: Profilet Terthore	FLETA	A13	
SHKALLA	FLETA		

Projektes:	Inxh. Liliana VLLAMASI Inxh. Engjell ÇAKA Gjeo. Haxhi PERVANA Gjeo. Iv BEQARI Elek. Besmir LUMANI Hidr. Majlinda KONCI Ark. Besian MUHARREMI
------------	--

SHENIME TEKNIKE:	Inxh. Engjell ÇAKA Inxh. Liliana Vllamasi
------------------	--

Bashkia Tirane	OBJEKTI:	"LAGJIA E ARTISTEVE"	Emeritimi: Realizimi i objektit "Lagjia e Artisteve"
----------------	----------	----------------------	--

"Arabel - Studio Arabel" Sh.p.k	"TRANSPORT HIGHWAY CONSULTING" Sh.p.k	"Dricons" Sh.p.k	POROSITESI: Bashkia Tirane
---------------------------------------	--	---------------------	----------------------------

SEKSIONET TERTHORE PROGRESIVE TE RRUGES KRYESORE (6 NGA 9)

SHKALLA A1-1:100 / A3-1:200

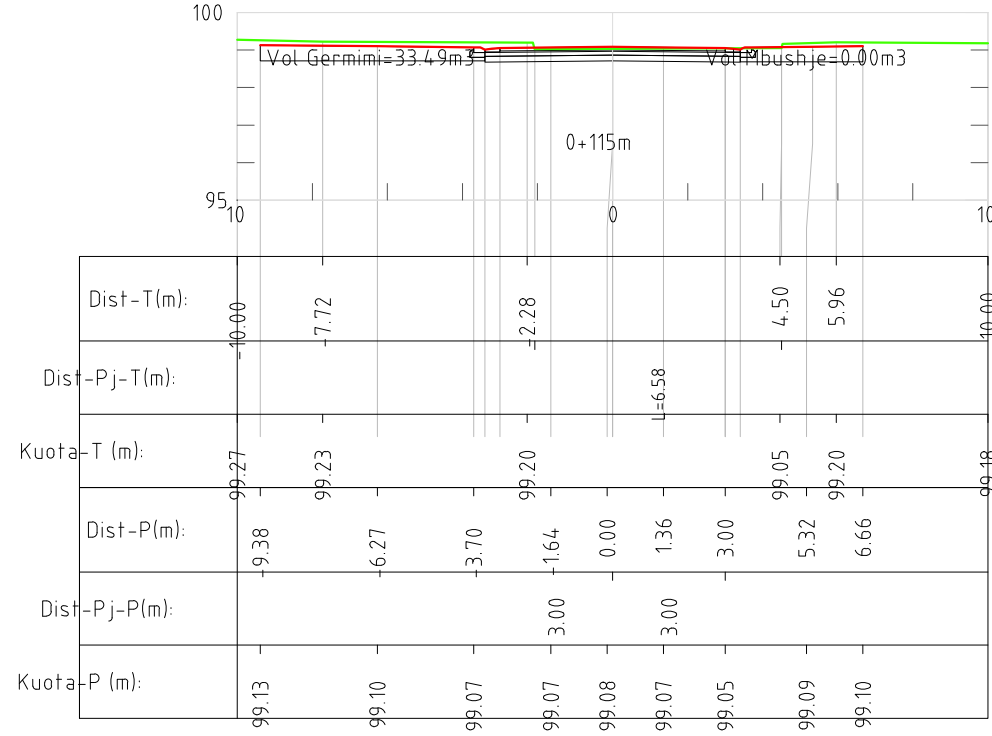
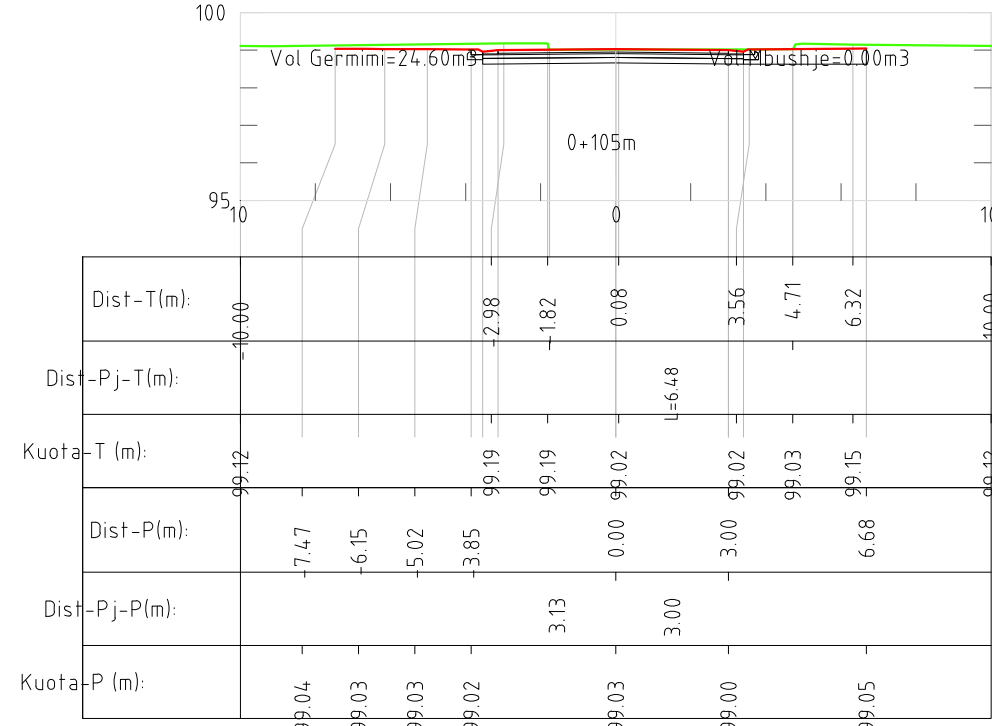
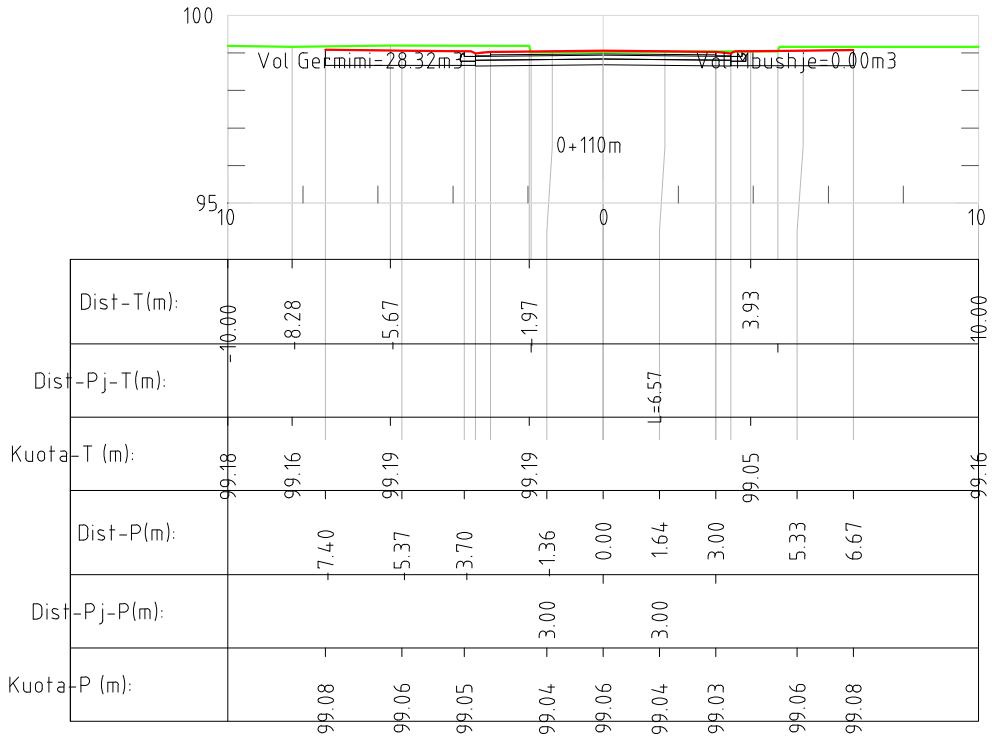
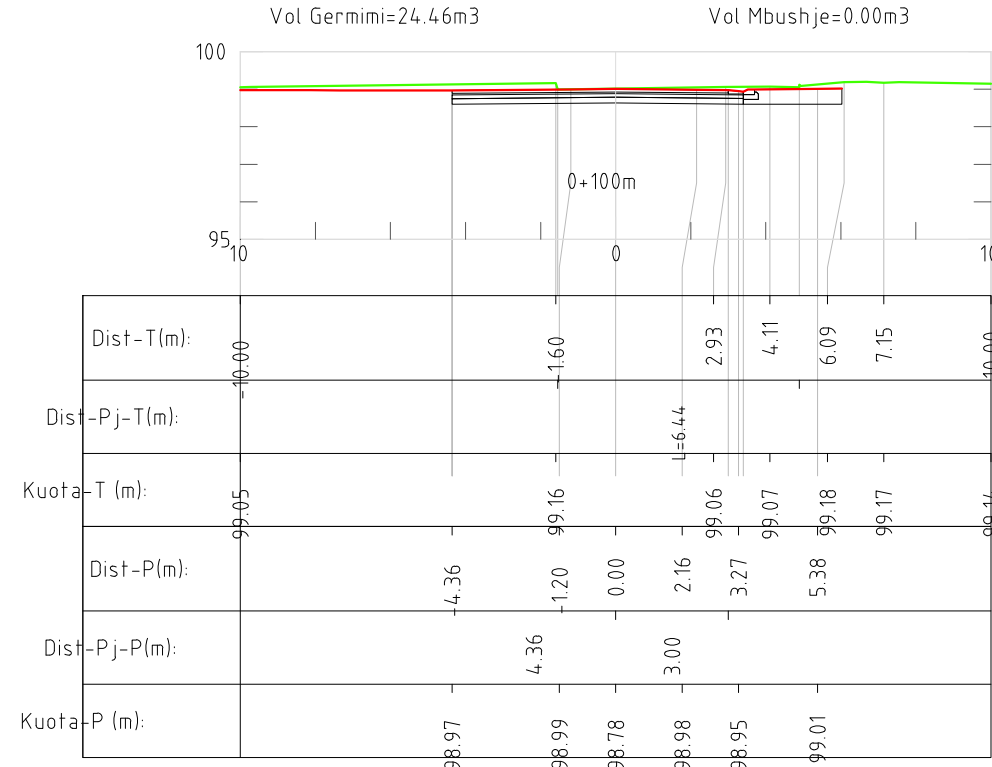

	Bashkia Tirane		"LAGJIA E ARTISTEVE"	
Emertimi i fletes: Profilet Terthore	SHENIME TEKNIKE:	OBJEKTI:	Emertimi: Realizimi i objektit "Lagjia e Artisteve"	POROSITESI: Bashkia Tirane
SHKALLA	Projektes:	SHENIME TEKNIKE:	Inxh. Liliانا VLLAMASI Inxh. Engjell ÇAKA Gjeo. Haxhi PERVANA Gjeo. Iv BEQARI Elek. Besmir LUMANI Hidr. Majlinda KONCI Ark. Besian MUHARREMI	"Arabel - Studio Arabel" Sh.p.k <small>Adresa: Dhër Prahocës Gjatë Durrës-Tiranë Bulevardi Elza Juri, Nendëria Nr.05</small>
FLETA	Inxh. Liliانا VLLAMASI Inxh. Engjell ÇAKA Gjeo. Haxhi PERVANA Gjeo. Iv BEQARI Elek. Besmir LUMANI Hidr. Majlinda KONCI Ark. Besian MUHARREMI	OBJEKTI:	"LAGJIA E ARTISTEVE"	"TRANSPO RT HIGHWAY CONSULTING" Sh.p.k
A13	Inxh. Liliانا VLLAMASI Inxh. Engjell ÇAKA Gjeo. Haxhi PERVANA Gjeo. Iv BEQARI Elek. Besmir LUMANI Hidr. Majlinda KONCI Ark. Besian MUHARREMI	OBJEKTI:	"LAGJIA E ARTISTEVE"	"Dricons" Sh.p.k <small>Adresa: Tiranë, Komuna Pajitë Rruga Osman Myzeqer Pajitë Shkollë</small>
	Inxh. Liliانا VLLAMASI Inxh. Engjell ÇAKA Gjeo. Haxhi PERVANA Gjeo. Iv BEQARI Elek. Besmir LUMANI Hidr. Majlinda KONCI Ark. Besian MUHARREMI	OBJEKTI:	"LAGJIA E ARTISTEVE"	"Arabel - Studio Arabel" Sh.p.k <small>Adresa: Dhër Prahocës Gjatë Durrës-Tiranë Bulevardi Elza Juri, Nendëria Nr.05</small>

SEKSIONET TERTHORE PROGRESIVE TE RRUGES KRYESORE (7 NGA 9)

SHKALLA A1-1:100 / A3-1:200

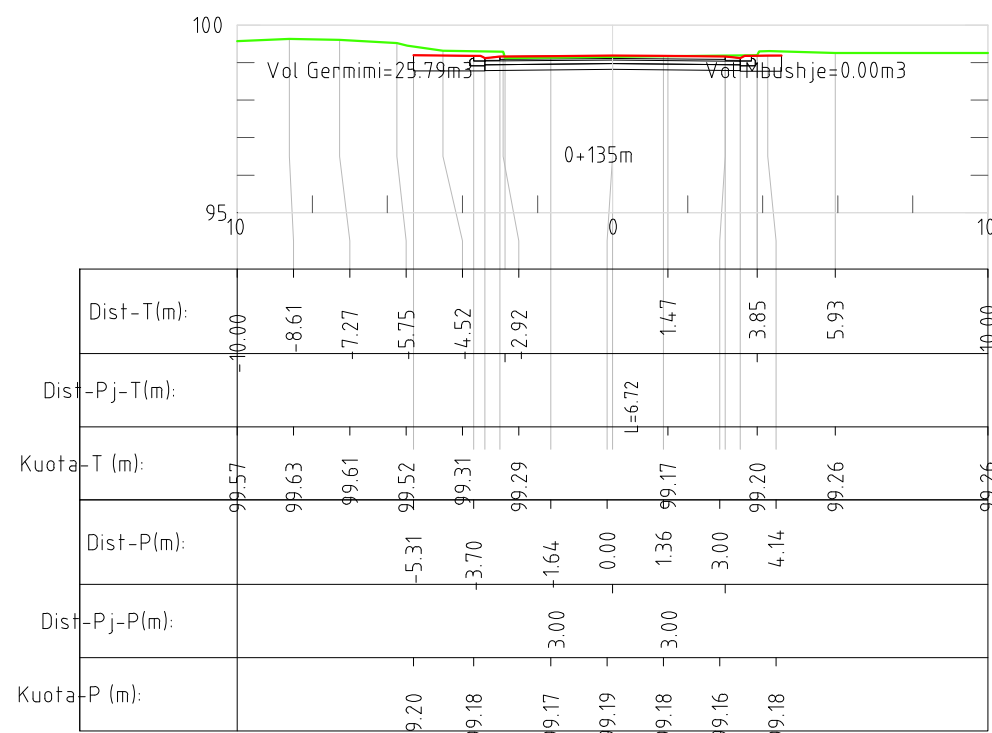
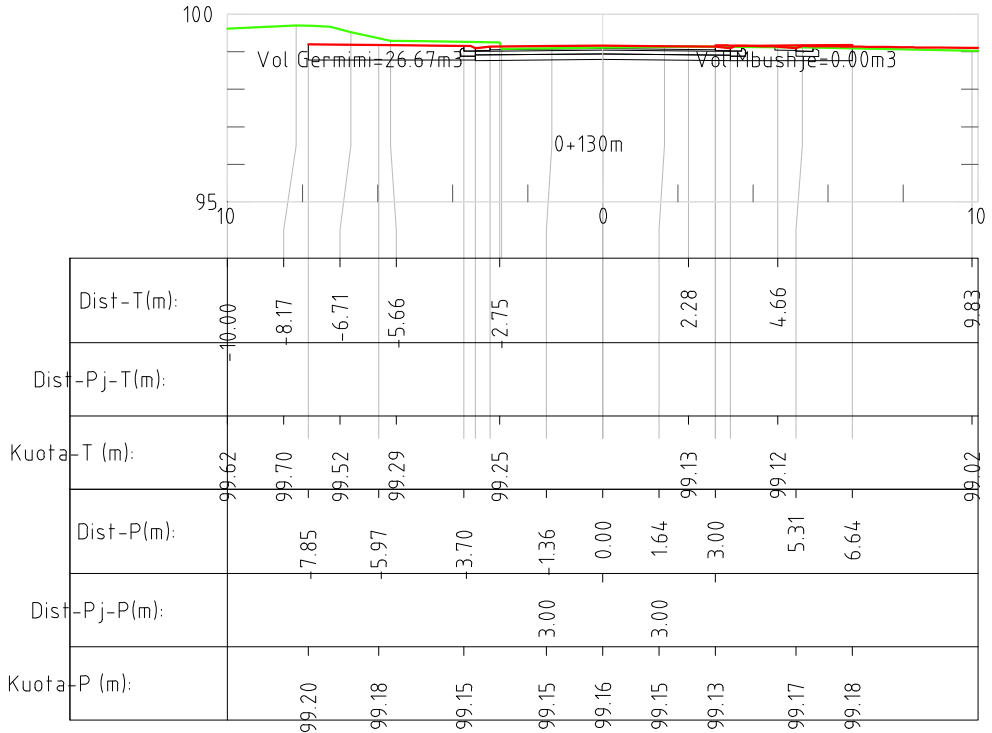
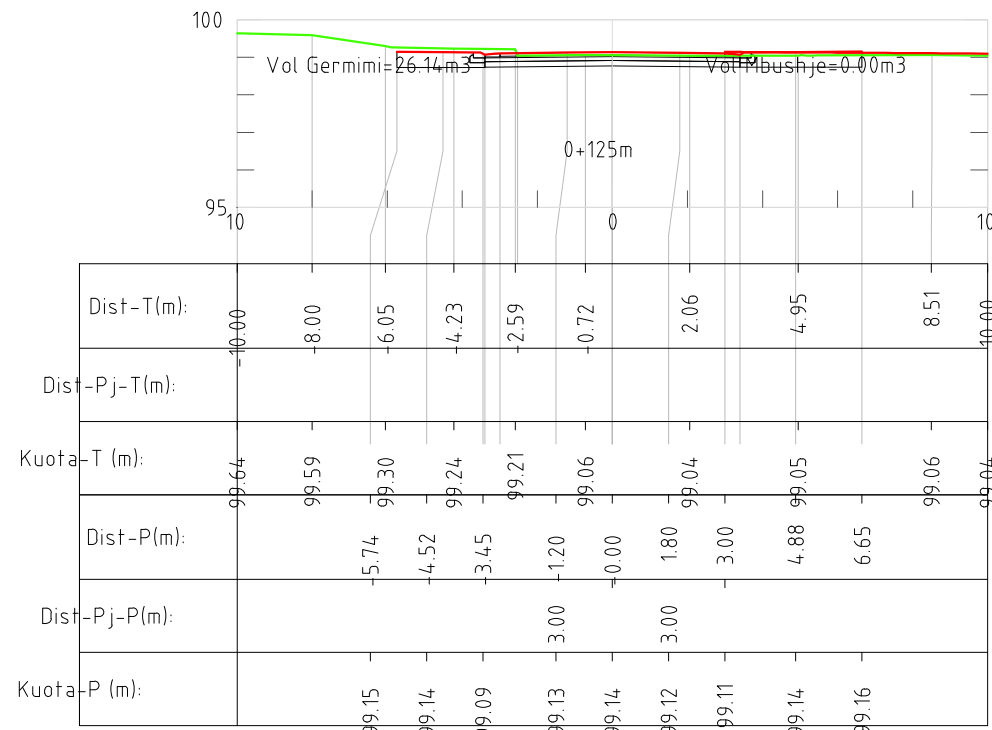
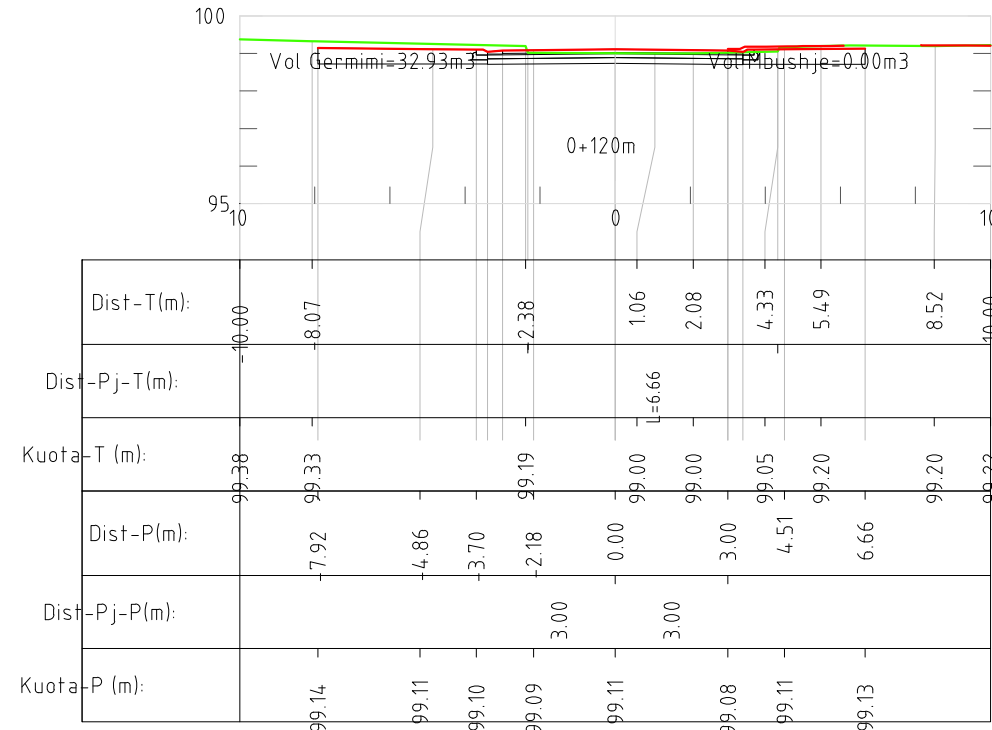

	Bashkia Tirane		"Dricons" Sh.p.k		"TRANSPORT HIGHWAY CONSULTING" Sh.p.k		"Arabel - Studio Arabel" Sh.p.k
	OBJEKTI:						
	"LAGJIA E ARTISTEVE"						
	Emertimi: Realizimi i objektit "Lagjia e Artisteve"						
	SHENIME TEKNIKE:						
	Projektes:	Inxh. Lilitana VLLAMASI Inxh. Engjell CAKA Gjeo. Haxhi PERVANA Gjeo. Iv BEQARI Elek. Besmir LUMANI Hidr. Majlinda KONCI Ark. Besian MUHARREMI					
Emertimi i fletes: Profillet Terthore	SHKALLA	FLETA	A13				
							POROSITESI: Bashkia Tirane

SEKSIONET TERTHORE PROGRESIVE TE RRUGES KRYESORE (8 NGA 9)

SHKALLA A1-1:100 / A3-1:200

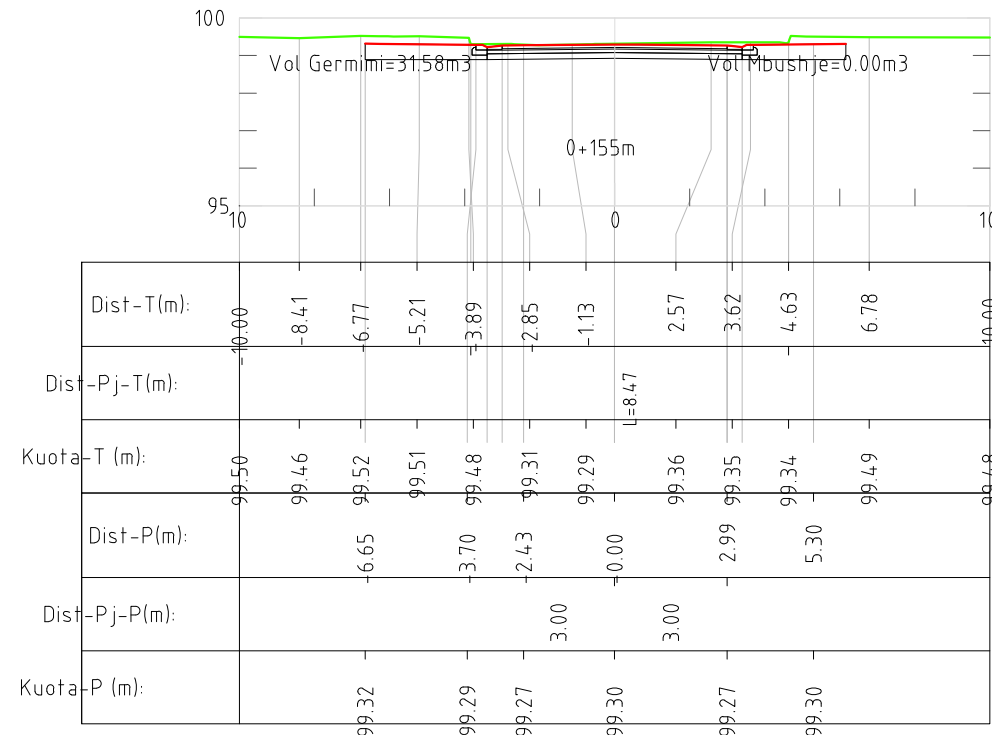
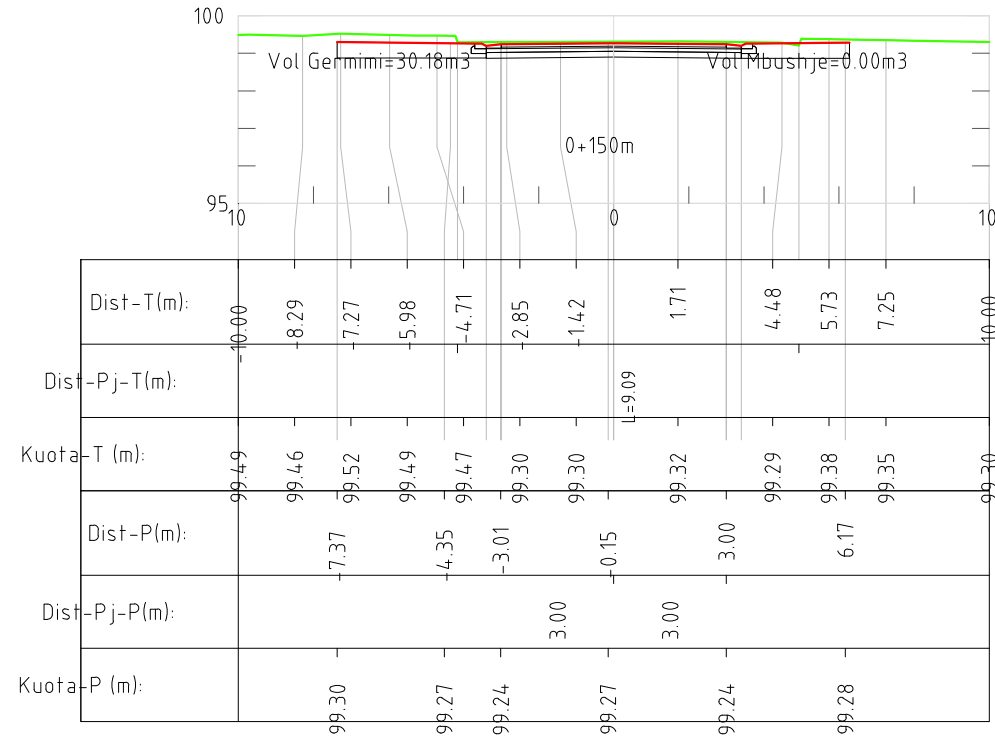
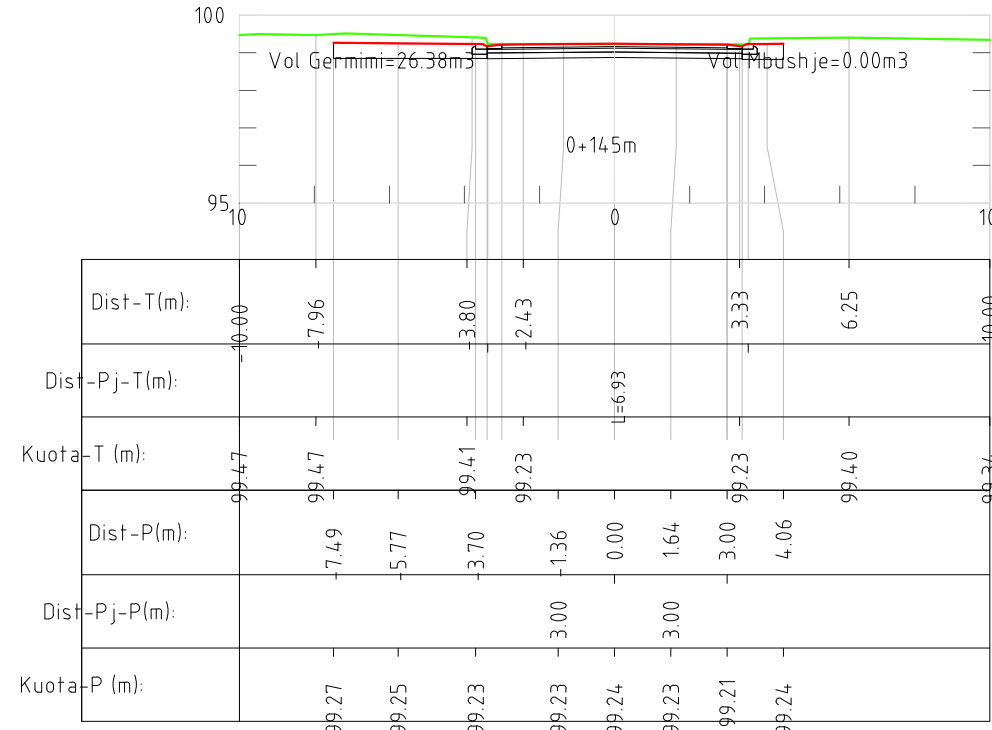
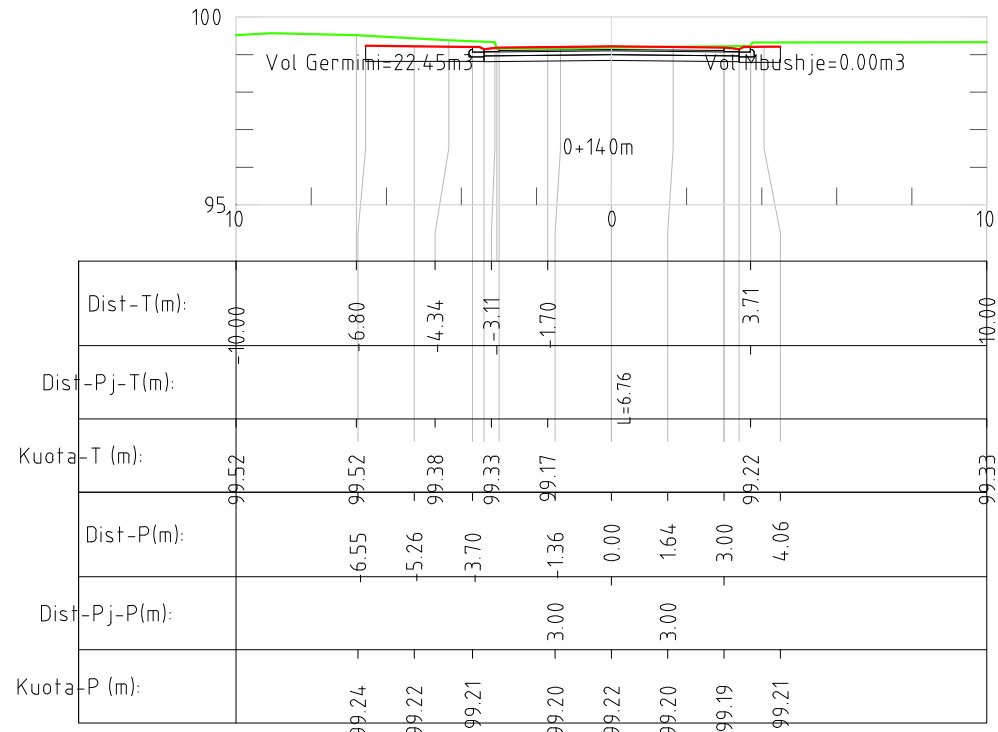

	Bashkia Tirane		"Dricons" Sh.p.k
OBJEKTI:	"LAGJIA E ARTISTEVE"	SHENIME TEKNIKE:	"TRANSPORT HIGHWAY CONSULTING" Sh.p.k
Emertimi i fletes: Profilet Terthore	Projektes: Inxh. Liliana VLLAMASI Inxh. Engjell CAKA Gjeo. Haxhi PERVANA Gjeo. Iv BEQARI Elek. Besmir LUMANI Hidr. Majlinda KONCI Ark. Besian MUHARREMI	Emertimi: Realizimi i objektit "Lagjia e Artisteve"	"Arabel - Studio Arabel" Sh.p.k
SHKALLA FLETA	A13	Inxh. Liliana Vllamasi Inxh. Engjell Caka Gjeo. Haxhi Pervana Gjeo. Iv Beqari Elek. Besmir Lumani Hidr. Majlinda Konci Ark. Besian Muharremi	"Dricons" Sh.p.k
POROSITESI: Bashkia Tirane		"TRANSPORT HIGHWAY CONSULTING" Sh.p.k	"Dricons" Sh.p.k

SEKSIONET TERTHORE PROGRESIVE TE RRUGES KRYESORE (9 NGA 9)

SHKALLA A1-1:100 / A3-1:200

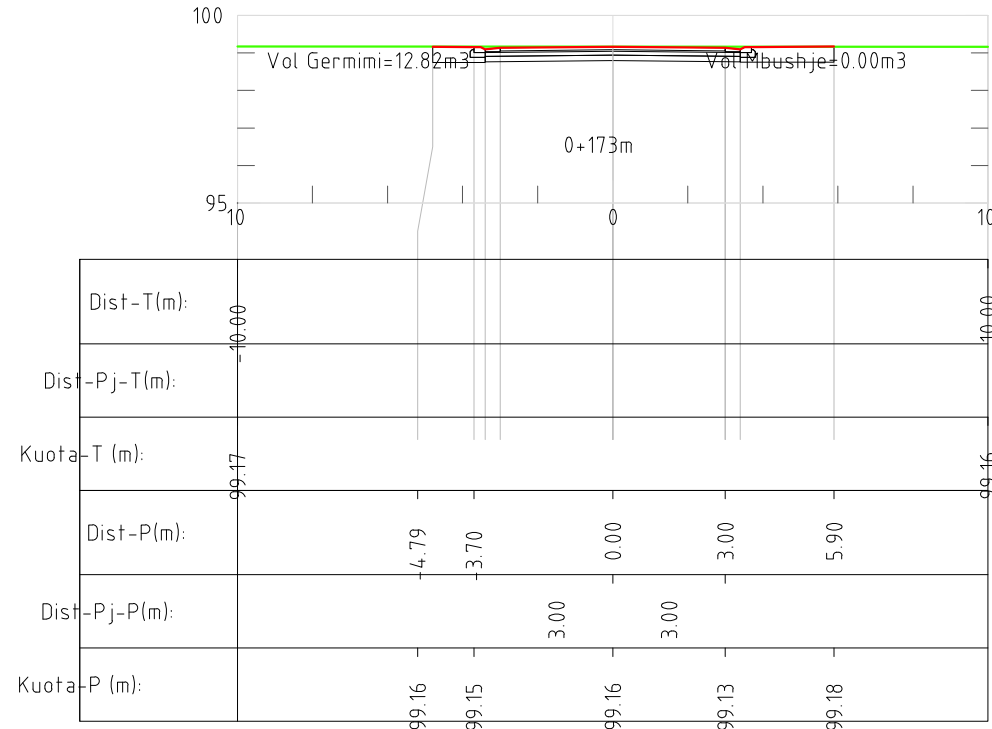
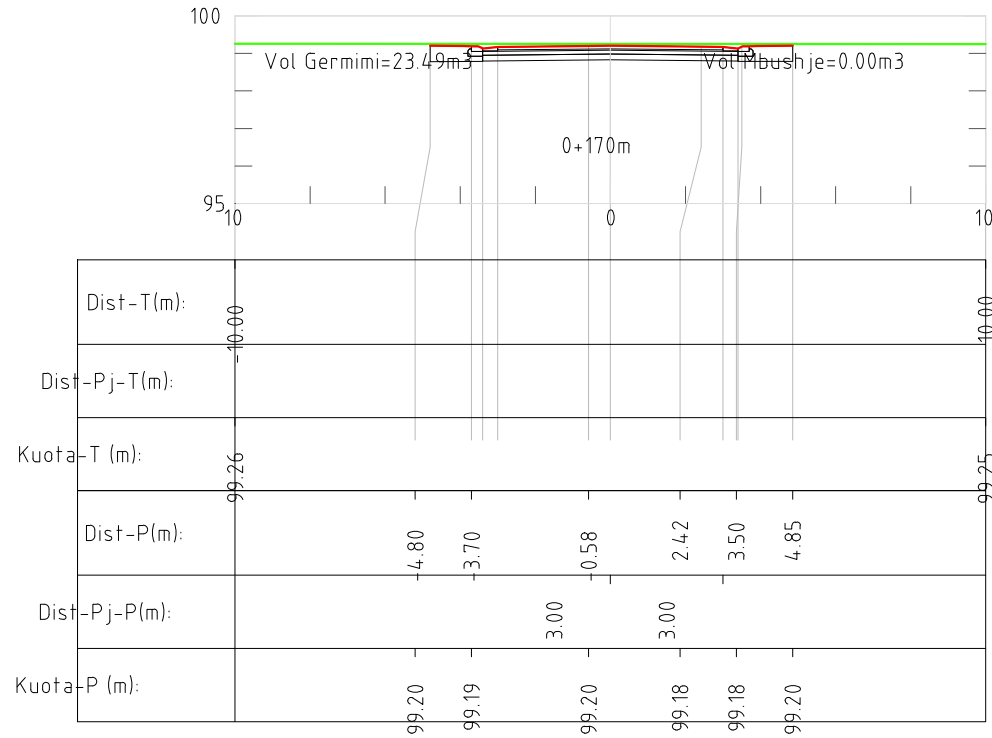
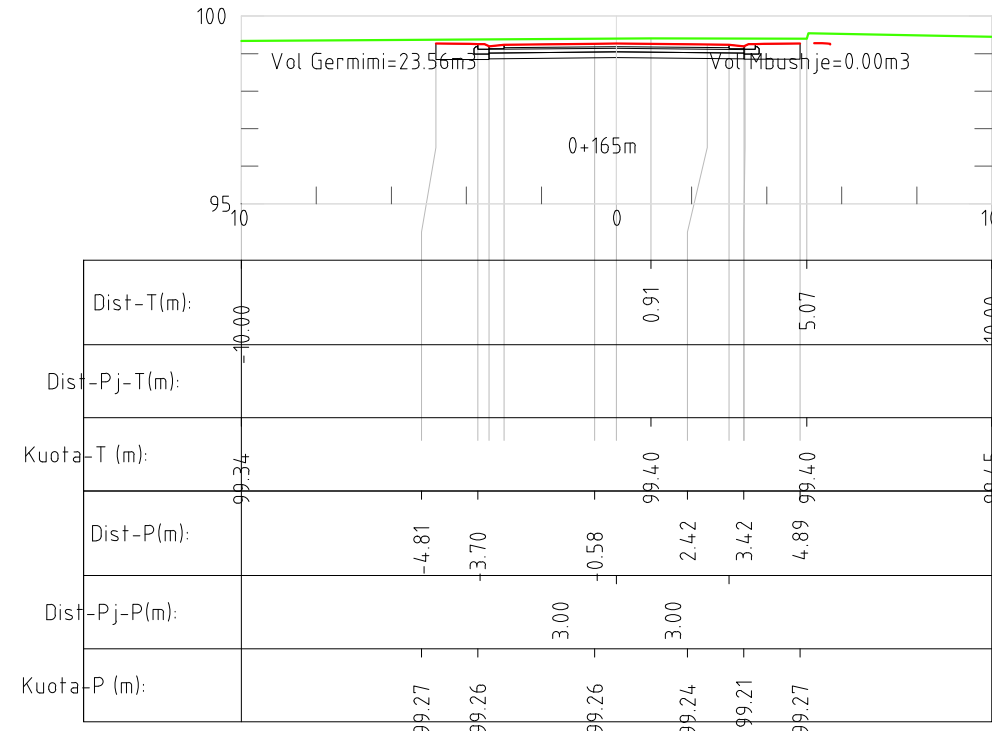
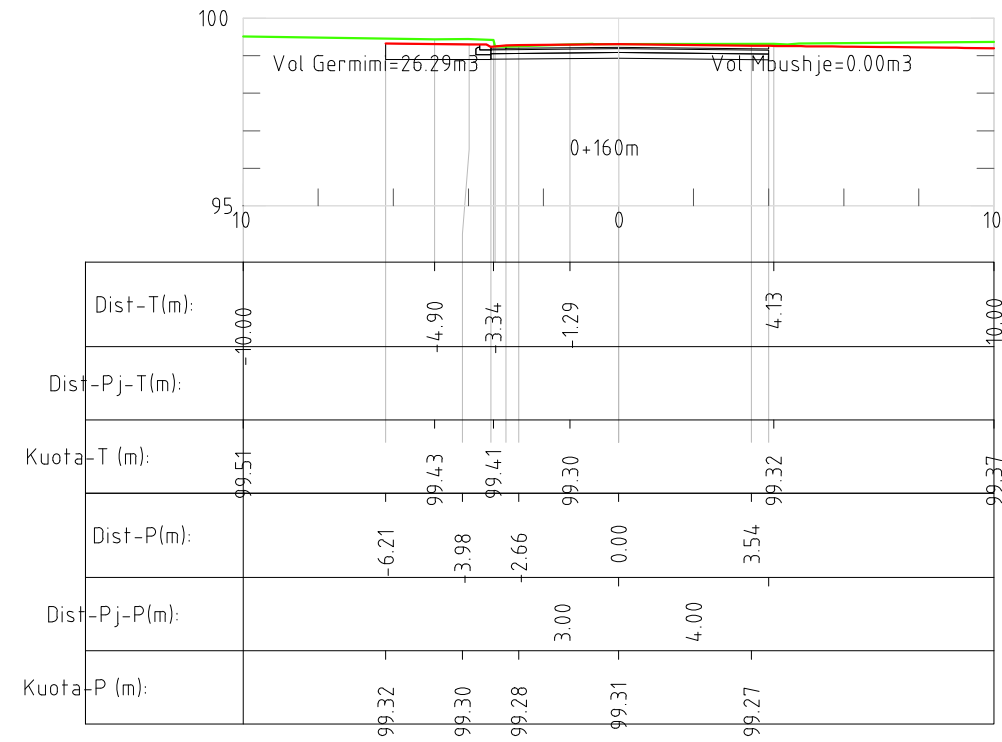

	Bashkia Tirane OBJEKTI: "LAGJIA E ARTISTEVE" Emeritimi: Realizimi i objektit "Lagjia e Artisteve"	SHENIME TEKNIKE: Inxh. Engjell ÇAKA Inxh. Liliana Vllamasi	Projektes: Inxh. Liliana VLLAMASI Inxh. Engjell ÇAKA Gjeo. Haxhi PERVANA Gjeo. Iv BEQARI Elek. Besmir LUMANI Hidr. Majlinda KONCI Ark. Besian MUHARREMI	Emeritimi i fletes: Profillet Terthore SHKALLA FLETA A13
"Arabel - Studio Arabel" Sh.p.k <small>Adresa: Dher, Prahocës, Gjeo. Durrës, Rruga M. Durrës, Nr. 05</small>	"TRANSPORT HIGHWAY CONSULTING" Sh.p.k <small>Adresa: Tiranë, Komuna Pallat, Rruga Osman Myzeqer, Pallat Shekulli, Apartament N. 20</small>	"Dricons" Sh.p.k <small>Adresa: Tiranë, Komuna Pallat, Rruga Osman Myzeqer, Pallat Shekulli</small>	POROSITESI: Bashkia Tirane	

SEKSIONET TERTHORE PROGRESIVE TE RRUGES SEKONDARE Nr.1 (1 NGA 3)

SHKALLA A1-1:100 / A3-1:200

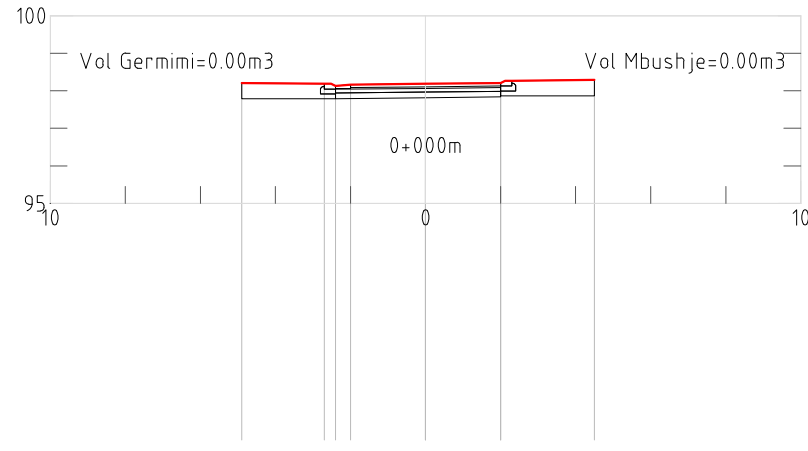

Dist-P(m):	-4.90	-2.70	0.00	2.00	4.50
Dist-Pj-P(m):			2.00	2.00	
Kuota-P (m):	98.21	98.18	98.18	98.20	98.29

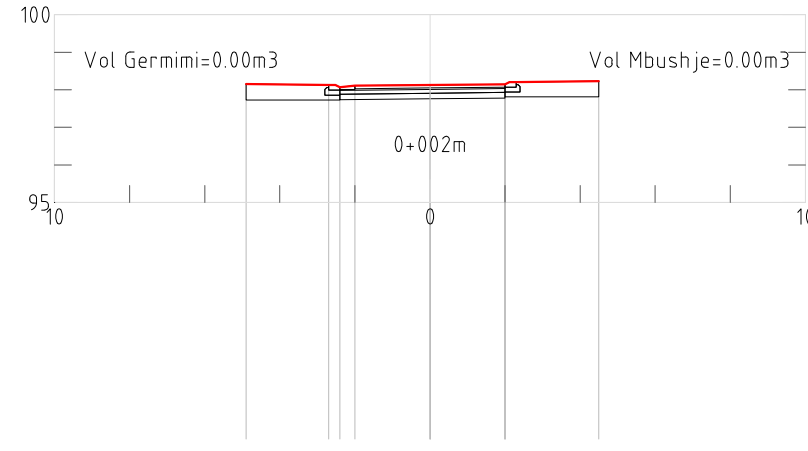

Dist-P(m):	-4.90	-2.70	-0.00	2.00	4.50
Dist-Pj-P(m):			2.00	2.00	
Kuota-P (m):	98.15	98.13	98.13	98.15	98.23

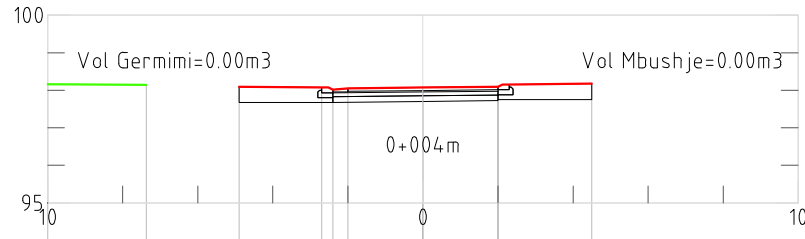

Dist-T(m):	-10.00	-7.37				
Dist-Pj-T(m):		L=2.63				
Kuota-T (m):	98.16	98.14				
Dist-P(m):		-4.90	-2.70	-0.00	2.00	4.50
Dist-Pj-P(m):			2.00	2.00		
Kuota-P (m):		98.09	98.07	98.07	98.09	98.17

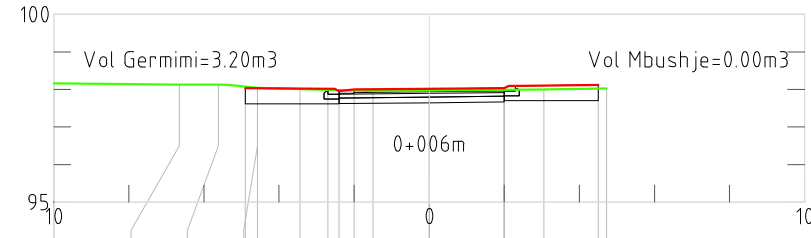

Dist-T(m):	-10.00	-6.65	-5.61	-4.57	-3.44	-1.50	3.06	4.73
Dist-Pj-T(m):								
Kuota-T (m):	98.16	98.13	98.13	98.04	98.01	97.96	98.00	98.02
Dist-P(m):		-4.90	-2.70	-0.00	2.00	4.50	98.04	98.12
Dist-Pj-P(m):			2.00	2.00				
Kuota-P (m):		98.04	98.02	98.02	98.04	98.12		

Emertimi i fletes:
Profillet Terthore

SHKALLA

FLETA

A13



Bashkia Tirane

OBJEKTI:

"LAGJIA E ARTISTEVE"

Emertimi:
Realizimi i objektit "Lagjia e
Artisteve"

SHENIME TEKNIKE:

Inxh. Engjell ÇAKA
Inxh. Liliana Vllamasi

Projektes:

Inxh. Liliana VLLAMASI
Inxh. Engjell ÇAKA
Gjeo. Haxhi PERVANA
Gjeo. Iv BEQARI
Elek. Besmir LUMANI
Hidr. Majlinda KONCI
Ark. Besian MUHARREMI

"Arabel -
Studio Arabel"
Sh.p.k

"TRANSPORT
HIGHWAY
CONSULTING"
Sh.p.k

"Dricons"
Sh.p.k

Adresa:
Dhlor Pashkova Gjata Dajç
Buzneci Etaz. Nr.1
Nendresa Nr.05

Adresa:
Tirane, Komuna Pallat
Rruga Osman Myzeqer
Pallat Shekulli
Apartment Nr. 20

Adresa:
Tirane, Komuna Pallat
Rruga Osman Myzeqer
Pallat Shekulli

POROSITESI: Bashkia Tirane

SEKSIONET TERTHORE PROGRESIVE TE RRUGES SEKONDARE Nr.1 (2 NGA 3)

SHKALLA A1-1:100 / A3-1:200

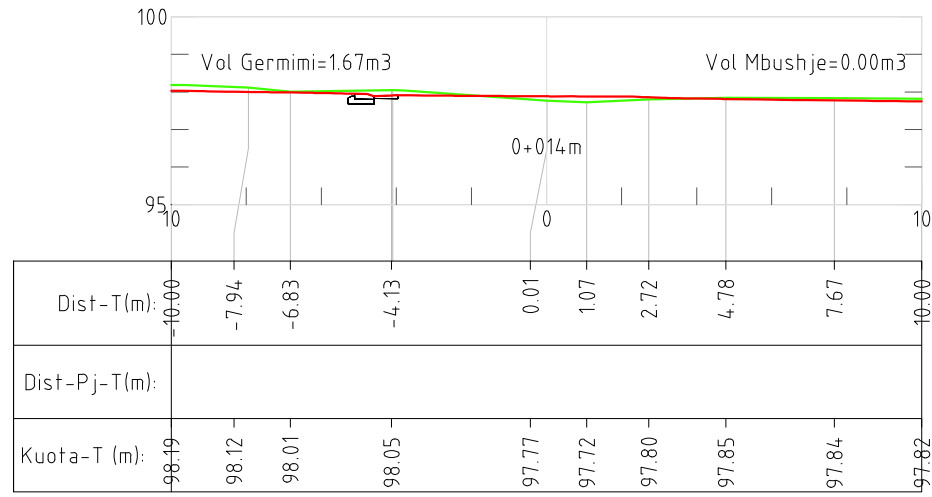
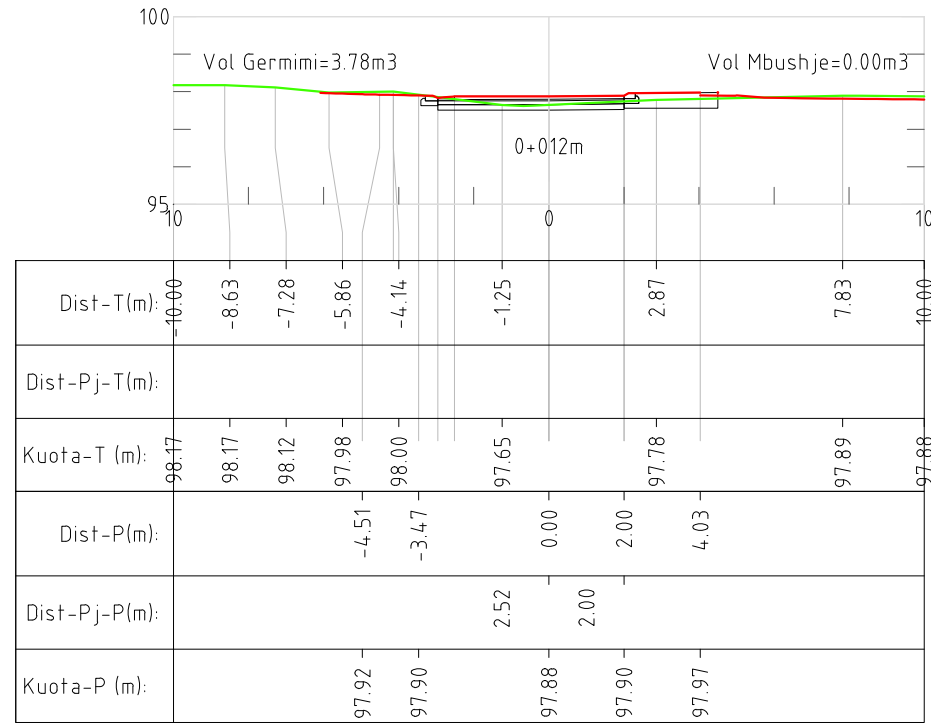
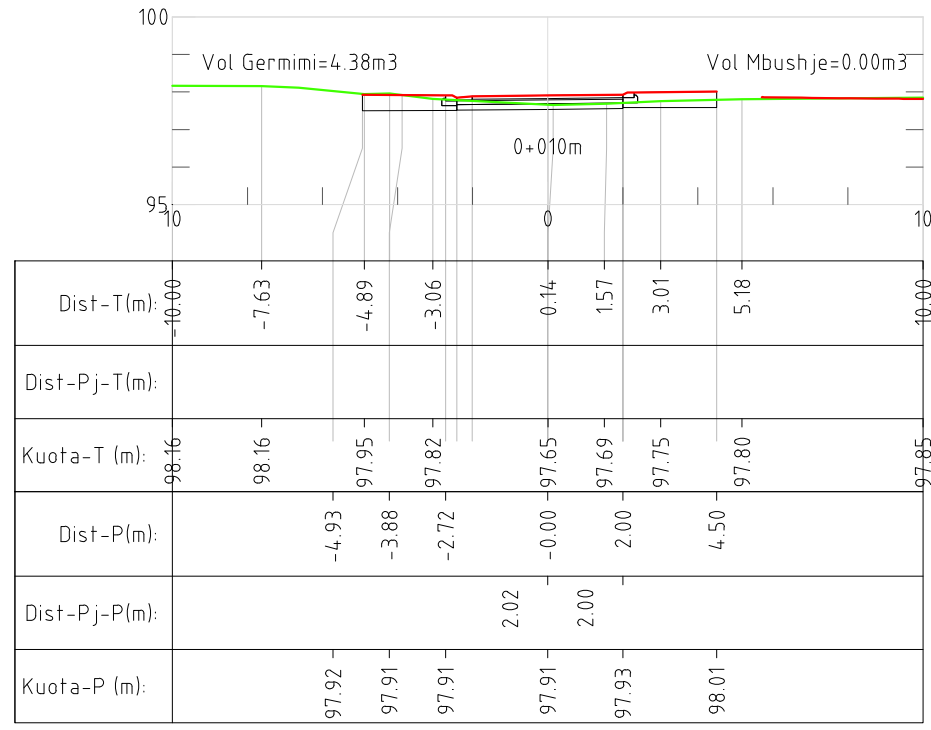
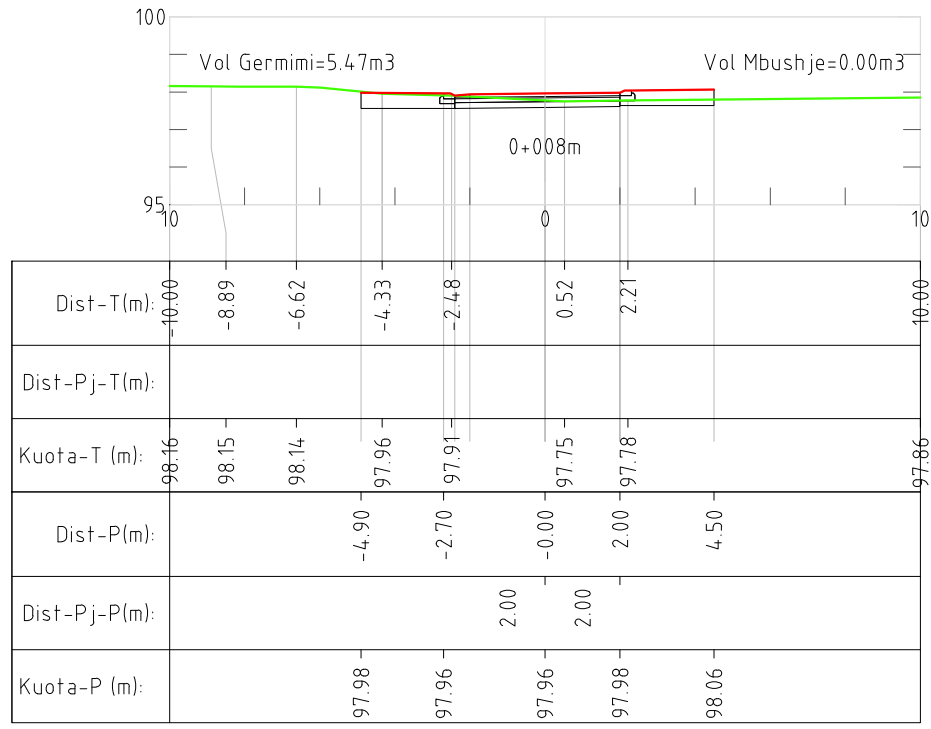

Emeritimi i fletes: Profilet Terthore	SHKALLA FLETA A13	Projektesues: Inxh. Liliana VLLAMASI Inxh. Engjell ÇAKA Gjeo. Haxhi PERVANA Gjeo. Iv BEQARI Elek. Besmir LUMANI Hidr. Majlinda KONCI Ark. Besian MUHARREMI	SHENIME TEKNIKE: Inxh. Engjell ÇAKA Inxh. Liliana Vllamasi	Bashkia Tirane OBJEKTI: "LAGJIA E ARTISTEVE" Emeritimi: Realizimi i objektit "Lagjia e Artisteve"	"Arabel - Studio Arabel" Sh.p.k <small>Adresa: Dher, Prahocës, Gjeo. Durrës, Rruga M. Durrës, Apartament Nr. 20</small>	"TRANSPORT HIGHWAY CONSULTING" Sh.p.k <small>Adresa: Tiranë, Komuna Pallat Rruga Durrës Myzezi Pallat Shehi</small>	"Dricons" Sh.p.k <small>Adresa: Tiranë, Komuna Pallat Rruga Durrës Myzezi Pallat Shehi</small>
					POROSITESI: Bashkia Tirane		

SEKSIONET TERTHORE PROGRESIVE TE RRUGES SEKONDARE Nr.1 (3 NGA 3)

SHKALLA A1-1:100 / A3-1:200

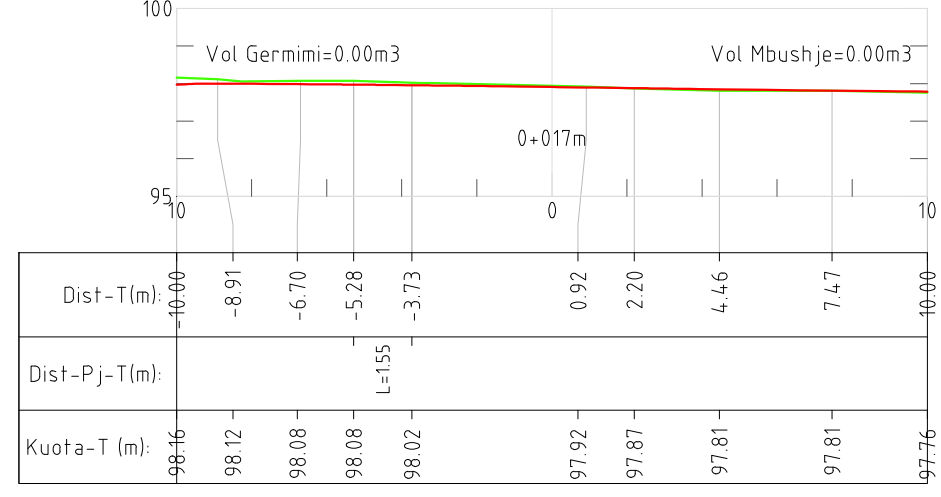
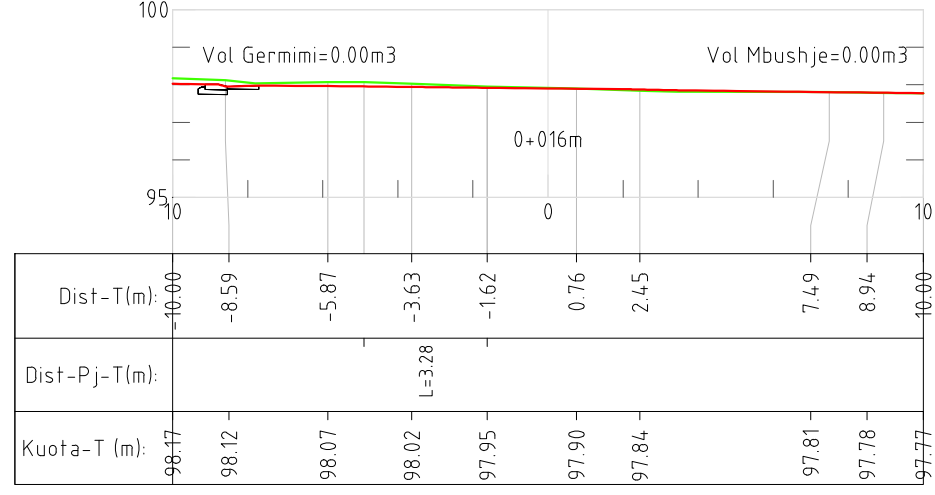

Emeritimi i fletes:
Profilet Terthore

SHKALLA FLETA

A13



Projektues:

Inxh. Liliana VLLAMASI
Inxh. Engjell ÇAKA
Gjeo. Haxhi PERVANA
Gjeo. Iv BEQARI
Elek. Besmir LUMANI
Hidr. Majlinda KONCI
Ark. Besian MUHARREMI

SHENIME TEKNIKE:

Inxh. Engjell ÇAKA
Inxh. Liliana Vllamasi

Bashkia Tirane

OBJEKTI:

"LAGJIA E ARTISTEVE"

Emeritimi:
Realizimi i objektit "Lagjia e
Artisteve"

"Arabel -
Studio Arabel"
Sh.p.k

Adresa:
Dharr. Prahocës Pallat Gjeo Dajç
Burrmorit Et'hem Beut
Nendres Nr.05

"TRANSPORT
HIGHWAY
CONSULTING"
Sh.p.k

Adresa:
Tirane, Kuznetsov Pallat
Rruga Osman Myzeviz
Apartment Nr. 20

"Dricons"
Sh.p.k

Adresa:
Tirane, Kuznetsov Pallat
Rruga Osman Myzeviz
Pallat Sheca

POROSITESI: Bashkia Tirane

SEKSIONET TERTHORE PROGRESIVE TE RRUGES SEKONDARE Nr.2 (1 NGA 4)

SHKALLA A1-1:100 / A3-1:200

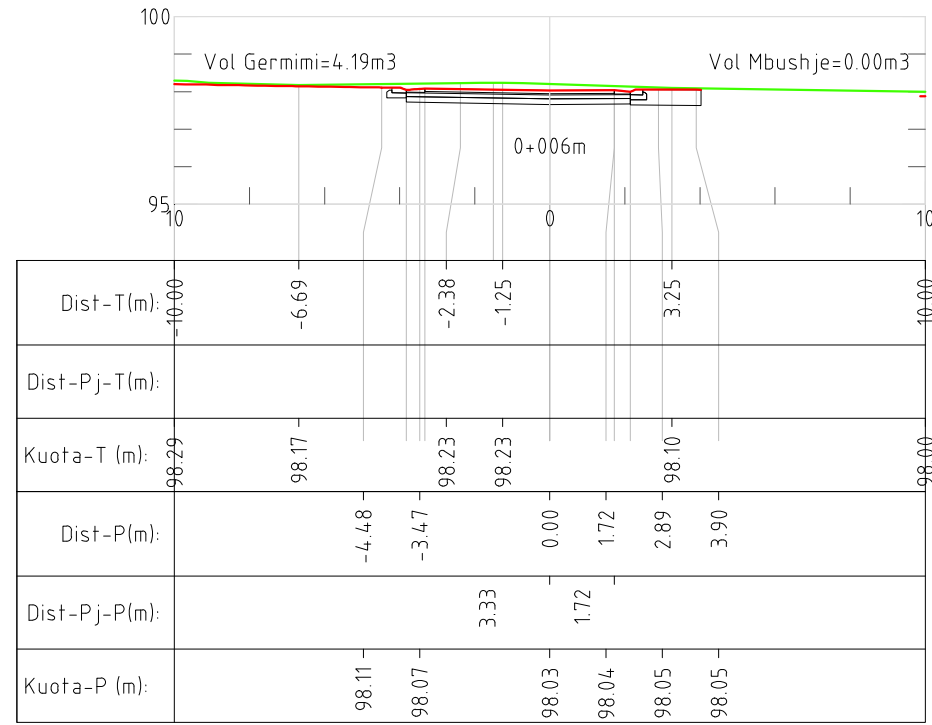
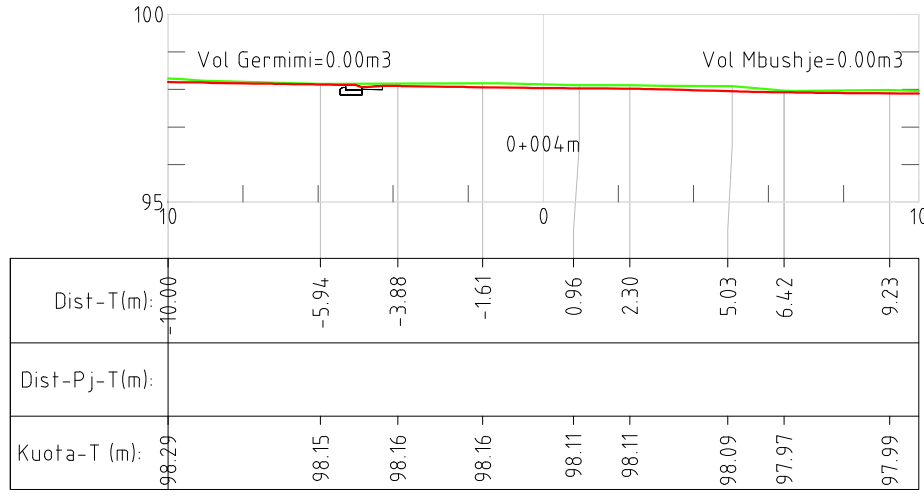
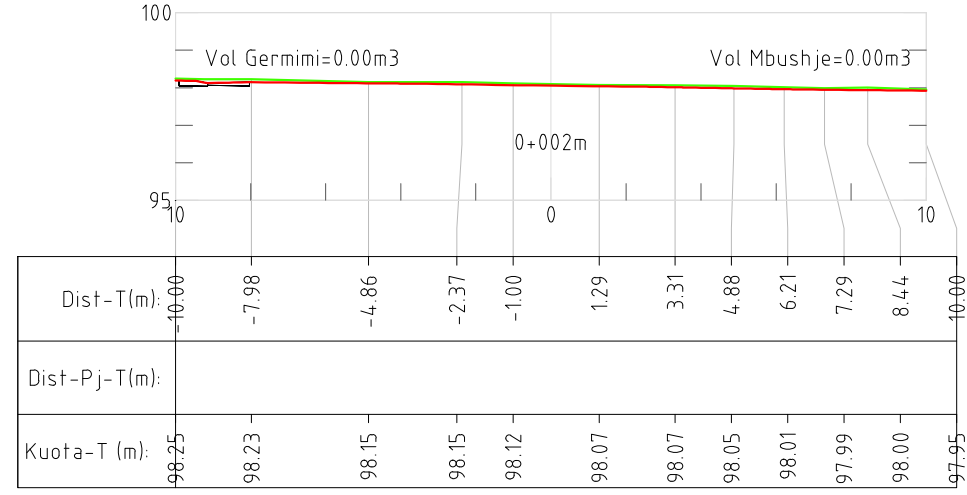
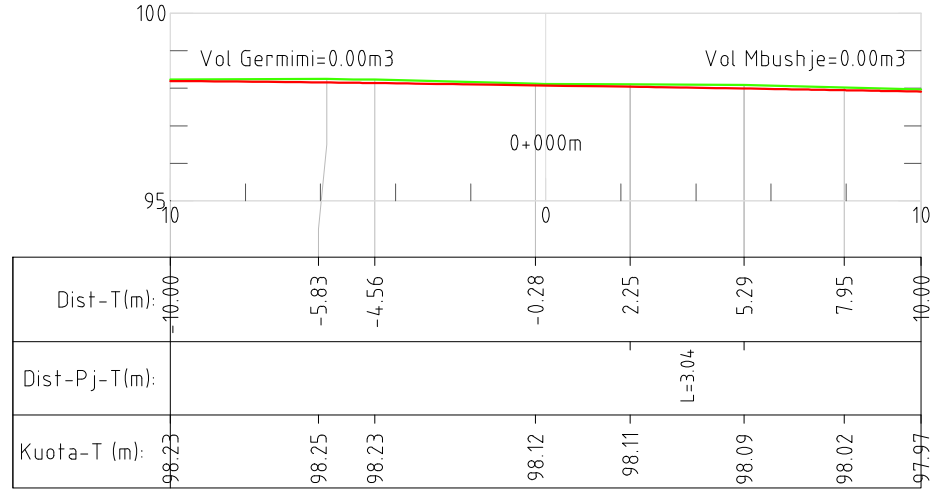

	Bashkia Tirane			
Emertimi i fletes: Profillet Terthore	OBJEKTI: "LAGJIA E ARTISTEVE"	SHENIME TEKNIKE: Inxh. Engjell ÇAKA Inxh. Liliana Vllamasi	Emertimi: Realizimi i objektit "Lagjia e Artisteve"	POROSITESI: Bashkia Tirane
SHKALLA FLETA A13	Inxh. Liliana VLLAMASI Inxh. Engjell ÇAKA Gjeo. Haxhi PERVANA Gjeo. Iv BEQARI Elek. Besmir LUMANI Hidr. Majlinda KONCI Ark. Besian MUHARREMI	"Arabel - Studio Arabel" Sh.p.k <small>Adresa: Dher, Prahocës, Gjeo. Dreqi, Tiranë, Rruga M. Kallmet, Grahova, Pallat 34, Shkalla 3, Apartament Nr. 20 Dher, Prahocës, Gjeo. Dreqi, Tiranë, Rruga M. Kallmet, Grahova, Pallat 34, Shkalla 3, Apartament Nr. 20 Adresa: Tiranë, Komuna Pajitë, Rruga Durrës, Myzez Pallat Shekulli</small>	"TRANSSPORT HIGHWAY CONSULTING" Sh.p.k	"Dricons" Sh.p.k

SEKSIONET TERTHORE PROGRESIVE TE RRUGES SEKONDARE Nr.2 (2 NGA 4)

SHKALLA A1-1:100 / A3-1:200

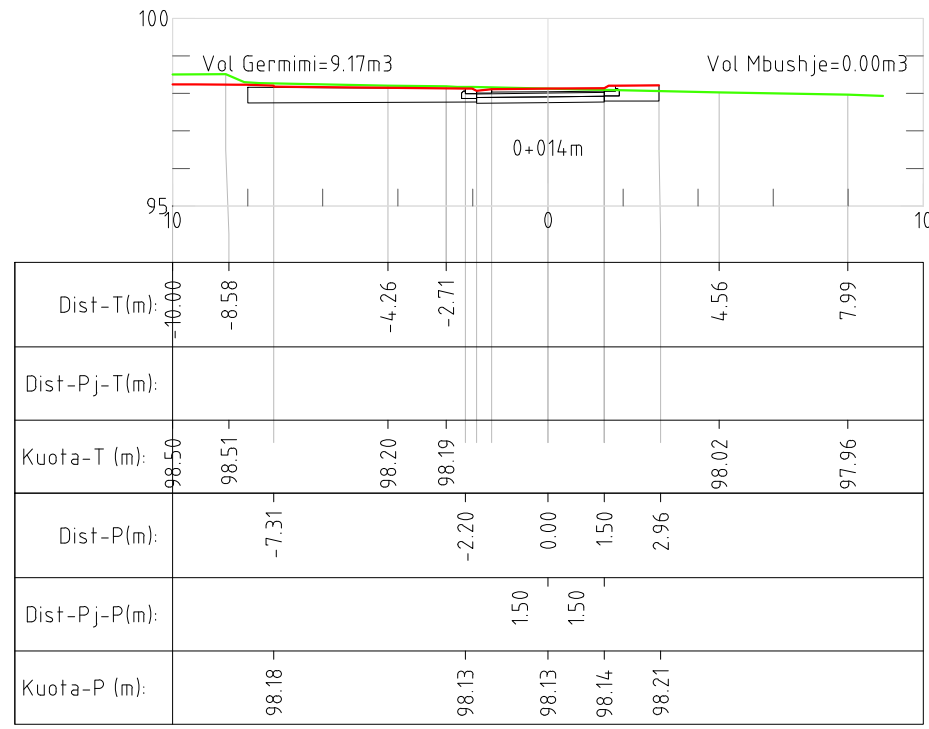
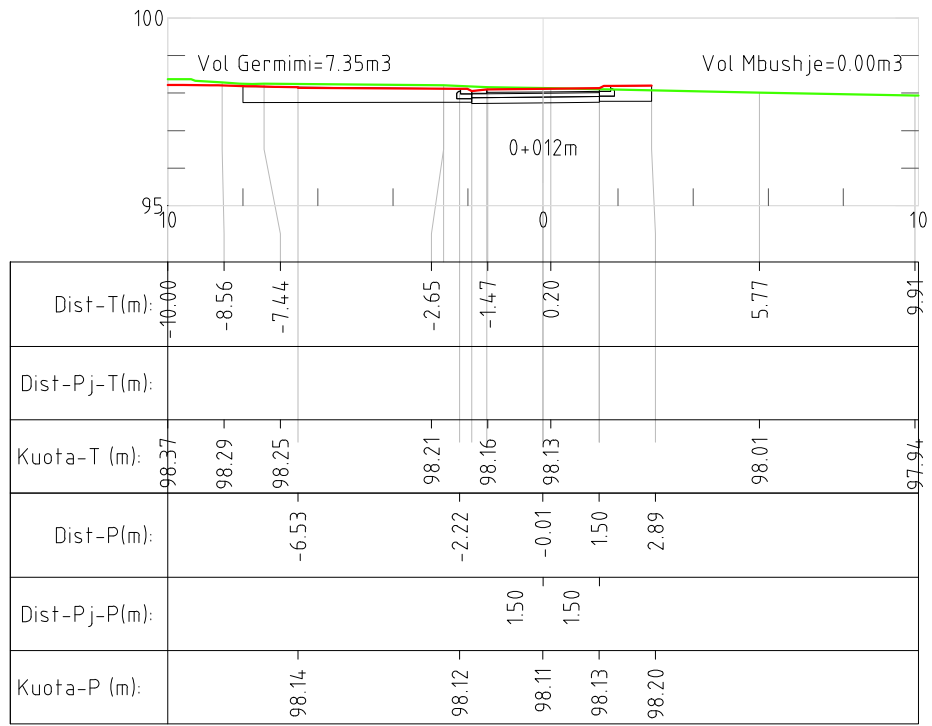
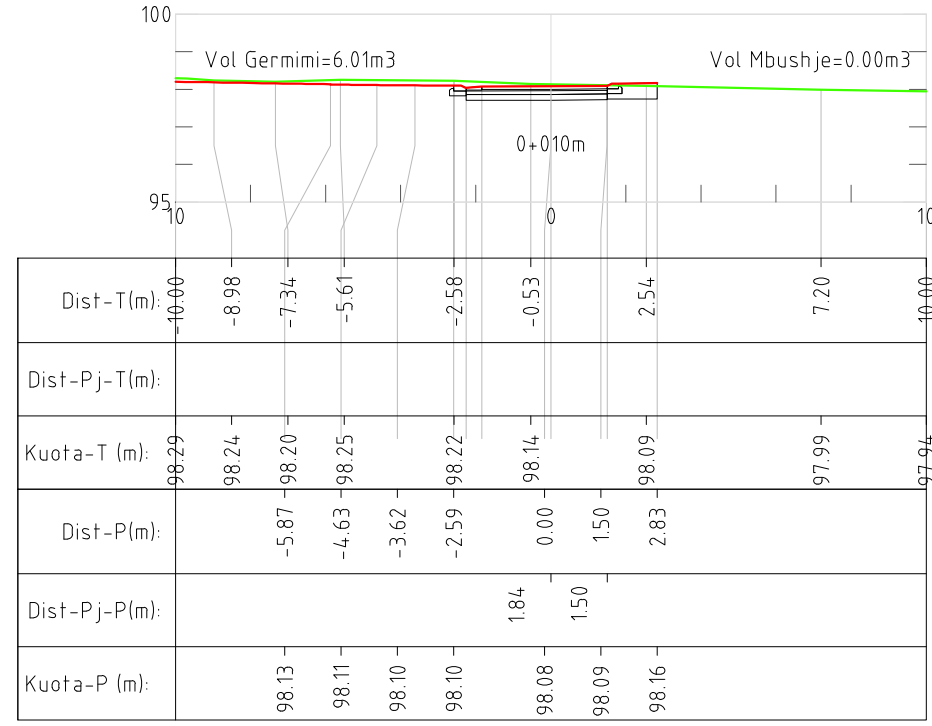
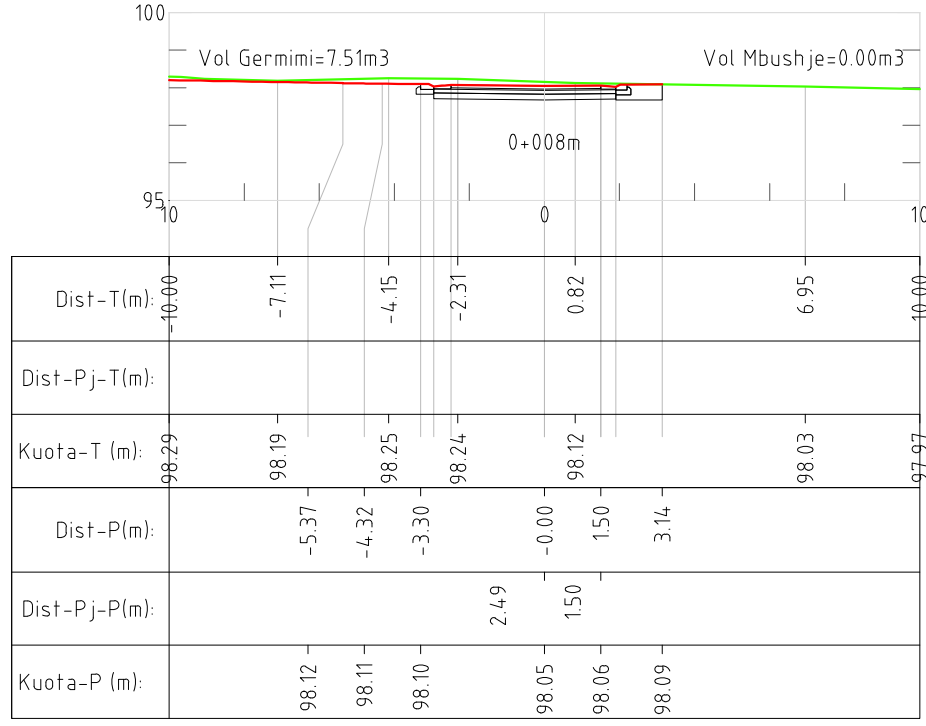

Emertimi i fletes: Profillet Terthore	SHKALLA FLETA A13	Projektes: Inxh. Liliana VLLAMASI Inxh. Engjell ÇAKA Gjeo. Haxhi PERVANA Gjeo. Iv BEQARI Elek. Besmir LUMANI Hidr. Majlinda KONCI Ark. Besian MUHARREMI	SHENIME TEKNIKE: Inxh. Engjell ÇAKA Inxh. Liliana Vllamasi	Bashkia Tirane OBJEKTI: "LAGJIA E ARTISTEVE" Emertimi: Realizimi i objektit "Lagjia e Artisteve"	POROSITESI: Bashkia Tirane

SEKSIONET TERTHORE PROGRESIVE TE RRUGES SEKONDARE Nr.2 (3 NGA 4)

SHKALLA A1-1:100 / A3-1:200

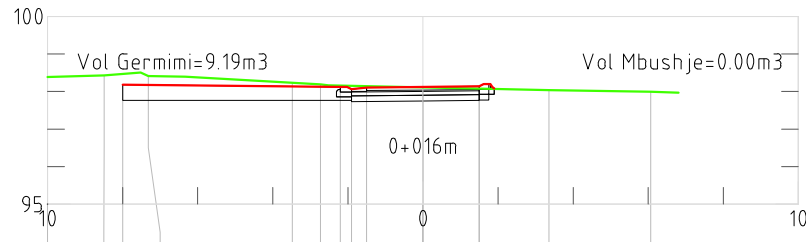

Dist-T(m):	-10.00	-8.49	-7.32	-3.48	3.35	6.07
Dist-Pj-T(m):						
Kuota-T (m):	98.39	98.43	98.41	98.23	98.04	97.99
Dist-P(m):		-8.00		-2.20	-0.00	1.50
Dist-Pj-P(m):				1.50	1.50	
Kuota-P (m):		98.18		98.13	98.12	98.14

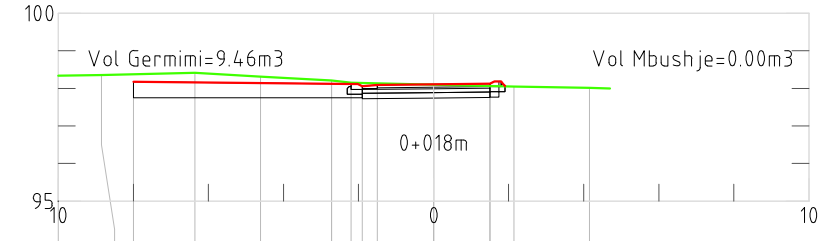

Dist-T(m):	-10.00	-8.85	-6.36	-4.61	-2.72	2.14	4.15
Dist-Pj-T(m):							
Kuota-T (m):	98.34	98.35	98.41	98.32	98.21	98.05	98.02
Dist-P(m):		-8.00			-2.20	0.00	1.50
Dist-Pj-P(m):					1.50	1.50	
Kuota-P (m):		98.17			98.11	98.11	98.12

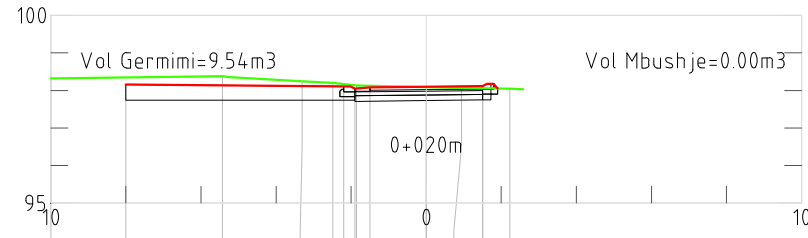

Dist-T(m):	-10.00	-5.43	-3.31	-1.86	0.94	2.23
Dist-Pj-T(m):						
Kuota-T (m):	98.32	98.38	98.25	98.13	98.07	98.05
Dist-P(m):		-8.00		-2.20	0.00	1.50
Dist-Pj-P(m):				1.50	1.50	
Kuota-P (m):		98.16		98.10	98.10	98.11

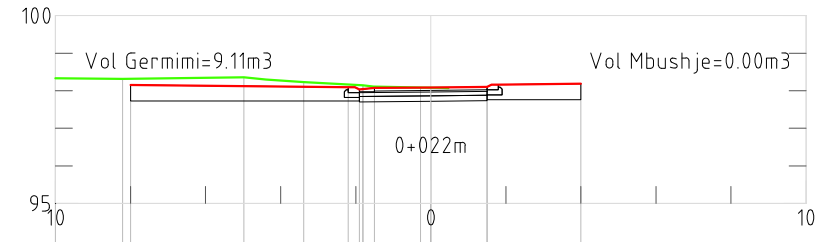

Dist-T(m):	-10.00	-8.21	-4.98	-3.39	-1.81	-0.27	
Dist-Pj-T(m):							
Kuota-T (m):	98.34	98.32	98.36	98.23	98.14	98.08	
Dist-P(m):		-8.00			-2.20	0.00	1.50
Dist-Pj-P(m):					1.50	1.50	
Kuota-P (m):		98.15			98.09	98.09	98.10

"Arabel - Studio Arabel" Sh.p.k	"TRANSPOORT HIGHWAY CONSULTING" Sh.p.k	"Dricons" Sh.p.k
Adresa: Dher. Prahocës, Rruga Dajç, Tiranë, Komuna Prishtinë, Rruga Duman Myzeq, Pallat Shekulli, Ndërtues Nr.05	Adresa: Tiranë, Komuna Prishtinë, Rruga Duman Myzeq, Pallat Shekulli, Apartment Nr. 20	Adresa: Tiranë, Komuna Prishtinë, Rruga Duman Myzeq, Pallat Shekulli

POROSITESI: Bashkia Tirane

Bashkia Tirane

OBJEKTI:

"LAGJIA E ARTISTEVE"

Emertimi:
Realizimi i objektit "Lagjia e Artisteve"

SHENIME TEKNIKE:

Inxh. Engjell ÇAKA
Inxh. Liliana Vllamasi

Projektues:

Inxh. Liliana VLLAMASI
Inxh. Engjell ÇAKA
Gjeo. Haxhi PERVANA
Gjeo. Iv BEQARI
Elek. Besmir LUMANI
Hidr. Majlinda KONCI
Ark. Besian MUHARREMI

Emertimi i fletes:
Profillet Terthore

FLETA

A13



SEKSIONET TERTHORE PROGRESIVE TE RRUGES SEKONDARE Nr.2 (4 NGA 4)
SHKALLA A1-1:100 / A3-1:200

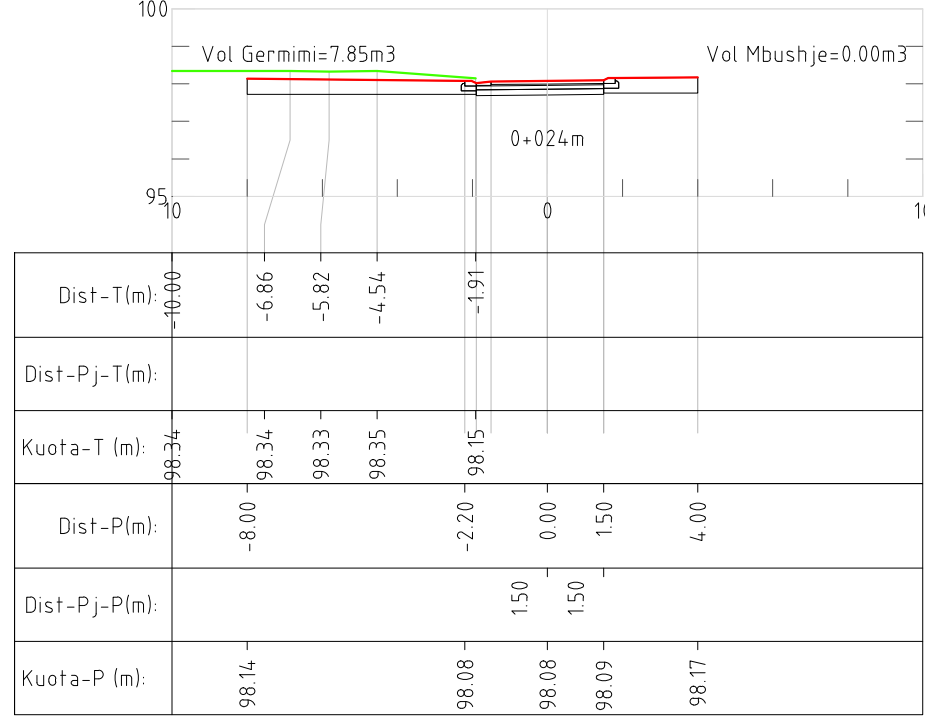

Emeritimi i fletes:
Profillet Terthore

SHKALLA FLETA
A13

Projektoes:
Inxh. Liliana VLLAMASI
Inxh. Engjell ÇAKA
Gjeo. Haxhi PERVANA
Gjeo. Iv BEQARI
Elek. Besmir LUMANI
Hidr. Majlinda KONCI
Ark. Besian MUHARREMI

SHENIME TEKNIKE:

Inxh. Engjell ÇAKA
Inxh. Liliana Vllamasi

Bashkia Tirane
OBJEKTI:
"LAGJIA E ARTISTEVE"
Emeritimi:
Realizimi i objektit "Lagjia e
Artisteve"

"Arabel - Studio Arabel" Sh.p.k	"TRANSPORT HIGHWAY CONSULTING" Sh.p.k	"Dricons" Sh.p.k
Adresa: Dhlor. Pashko Vasa Gjeo Driç Buzneci Et'hem Beut Nendresa Nr.05	Adresa: Trane, Komuna Prishtine Rruga Duman Myzeviz Pallat Shekulli Apartment Nr. 20	Adresa: Trane, Komuna Prishtine Rruga Duman Myzeviz Pallat Shekulli

POROSITESI: Bashkia Tirane

SEKSIONET TERTHORE PROGRESIVE TE RRUGES SEKONDARE Nr.3 (1 NGA 3)
SHKALLA A1-1:100 / A3-1:200

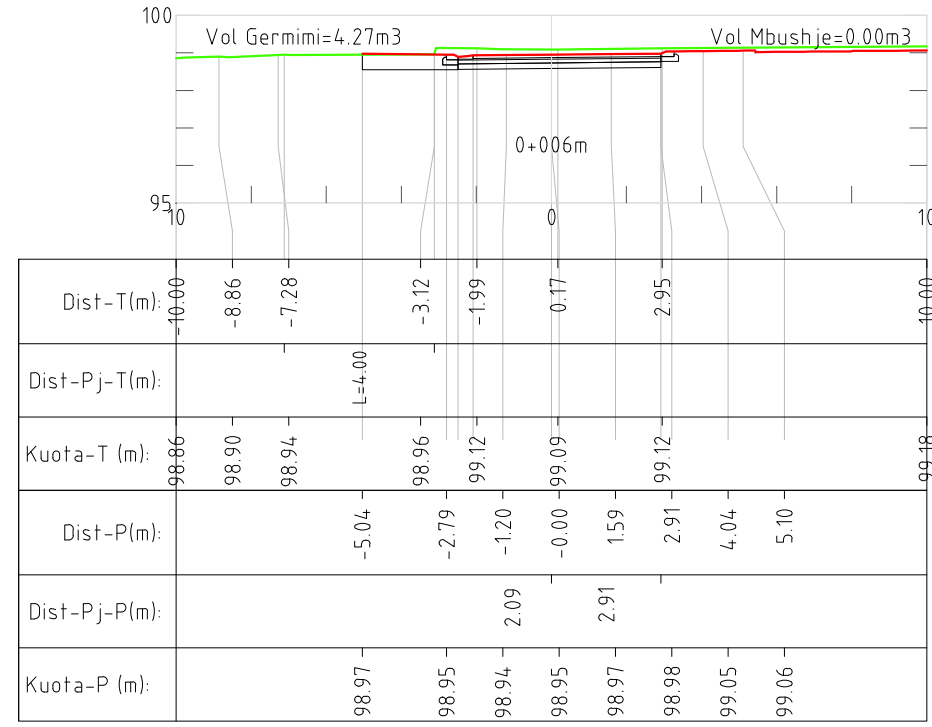
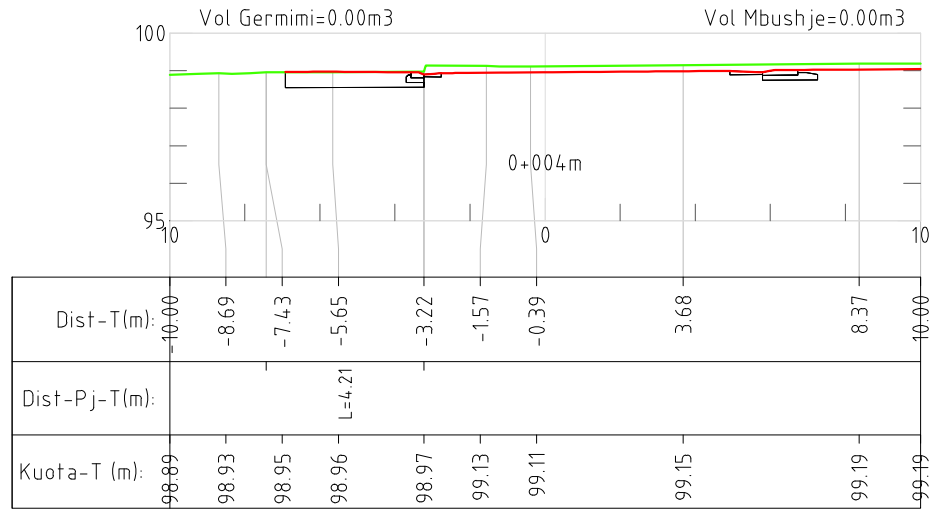
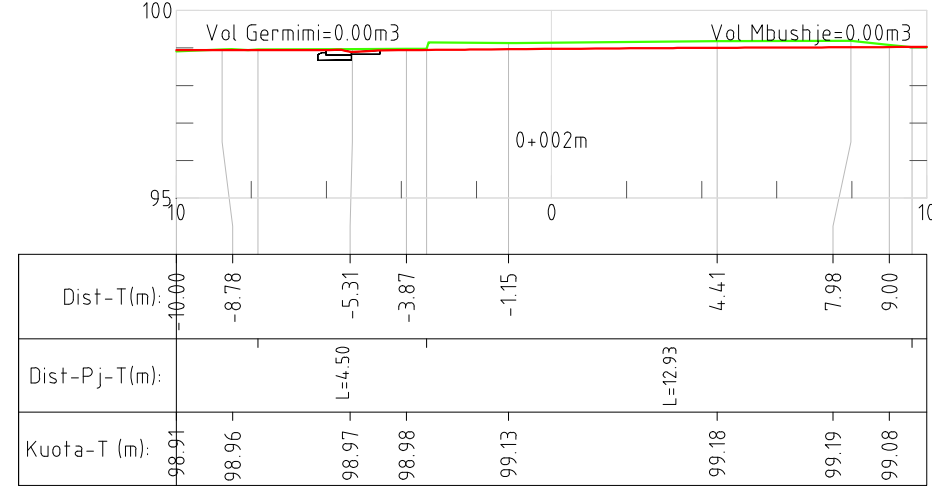
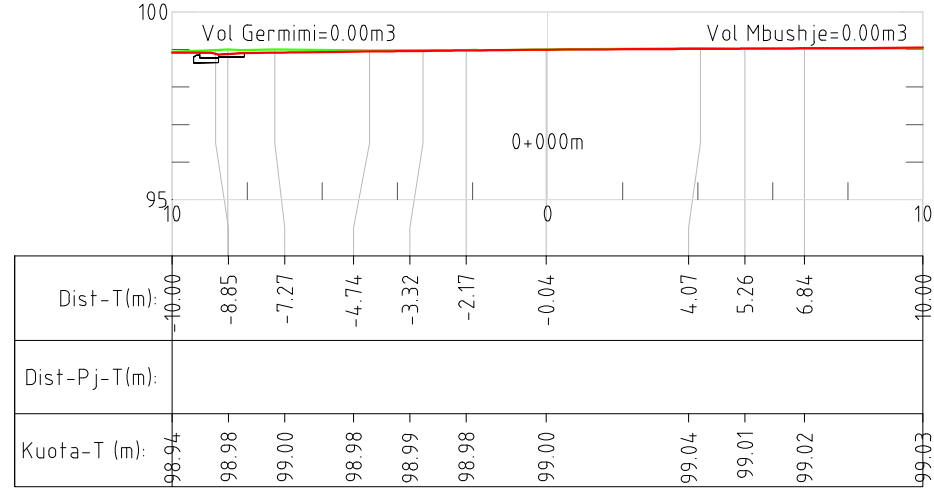

"Arabel - Studio Arabel" Sh.p.k	"TRANSPORT HIGHWAY CONSULTING" Sh.p.k	"Dricons" Sh.p.k
Adresa: Dher, Prahoveja, Gjeq, Durrës, Rruga M. Durrës, Nr. 20 Buzina, E. Durrës, Nr. 20	Adresa: Tiranë, Komuna Pallat, Rruga Durrës, Nr. 20, Pallat Sh.p.k	Adresa: Tiranë, Komuna Pallat, Rruga Durrës, Nr. 20, Pallat Sh.p.k

Bashkia Tirane	OBJEKTI:	"LAGJIA E ARTISTEVE"
		Emeritimi: Realizimi i objektit "Lagjia e Artisteve"

SHENIME TEKNIKE:	Inxh. Engjell ÇAKA Inxh. Liliana Vllamasi
-------------------------	--

Projektues:	Inxh. Liliana VLLAMASI Inxh. Engjell ÇAKA Gjeo. Haxhi PERVANA Gjeo. Iv BEQARI Elek. Besmir LUMANI Hidr. Majlinda KONCI Ark. Besian MUHARREMI
--------------------	--

Emeritimi i fletes: Profilet Terthore	SHKALLA	FLETA	A13	
--	----------------	-------	-----	--

POROSITESI: Bashkia Tirane

SEKSIONET TERTHORE PROGRESIVE TE RRUGES SEKONDARE Nr.3 (2 NGA 3)

SHKALLA A1-1:100 / A3-1:200

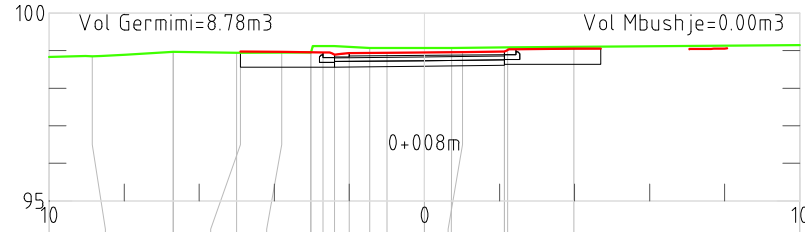

Dist-T(m):	-10.00	-8.85	-6.69	-5.01	-3.02	-1.46	0.73	2.22	10.00
Dist-Pj-T(m):				L=3.67					
Kuota-T (m):	98.83	98.85	98.97	98.95	98.95	99.07	99.07	99.09	99.15
Dist-P(m):			-4.90	-3.80	-2.70	-1.00	1.02	2.13	3.98
Dist-Pj-P(m):						2.00	2.13		
Kuota-P (m):			98.98	98.97	98.95	98.94	98.96	98.98	99.05

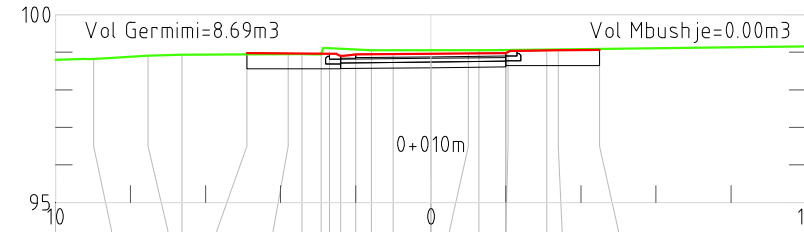

Dist-T(m):	-10.00	-8.98	-7.53	-3.43	-1.58	1.28	3.09	10.00	
Dist-Pj-T(m):				L=3.71					
Kuota-T (m):	98.80	98.83	98.91	98.95	99.05	99.05	99.07	99.16	
Dist-P(m):			-4.90	-3.80	-2.70	-1.00	1.00	2.06	4.50
Dist-Pj-P(m):						2.00	2.00		
Kuota-P (m):			98.98	98.97	98.96	98.95	98.97	99.01	99.05

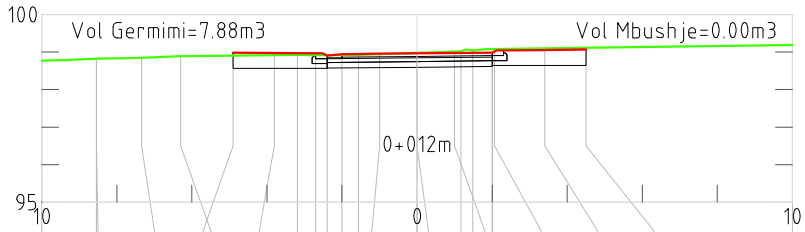

Dist-T(m):	-10.00	-8.55	-7.34	-6.30	-3.19	-1.56	1.17	10.00	
Dist-Pj-T(m):					L=10.03				
Kuota-T (m):	98.77	98.82	98.85	98.89	98.92	98.92	99.01	99.19	
Dist-P(m):			-4.90	-3.80	-2.70	-1.00	-0.00	1.00	2.06
Dist-Pj-P(m):						2.00	2.00		
Kuota-P (m):			98.99	98.98	98.96	98.95	98.96	98.97	99.01

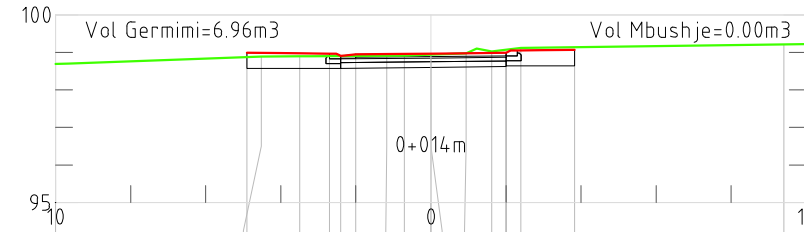

Dist-T(m):	-10.00	-4.51	-3.50	-0.71	0.93	2.39	9.40
Dist-Pj-T(m):							
Kuota-T (m):	98.69	98.89	98.90	98.92	98.97	99.12	99.21
Dist-P(m):		-4.90	-2.70	-1.18	-0.00	2.00	3.82
Dist-Pj-P(m):				2.00	2.00		
Kuota-P (m):		98.99	98.97	98.96	98.97	98.99	99.06

"Arabel - Studio Arabel" Sh.p.k	"TRANSPORT HIGHWAY CONSULTING" Sh.p.k	"Dricons" Sh.p.k
Adresa: Dher, Peshkopia, Gjeq, Durrës, Rruga M. Dëshmorit, Nr. 10, Niveli Nr. 05	Adresa: Tiranë, Komanë, Prishtinë, Rruga Dëshmorit, Apartament Nr. 20	Adresa: Tiranë, Komanë, Prishtinë, Rruga Dëshmorit, Apartament Nr. 20

Bashkia Tirane
OBJEKTI:
"LAGJIA E ARTISTEVE"
Emertimi: Realizimi i objektit "Lagjia e Artisteve"

SHENIME TEKNIKE:
Inxh. Engjell ÇAKA Inxh. Liliana Vllamasi

Projektes:
Inxh. Liliana VLLAMASI Inxh. Engjell ÇAKA Gjeo. Haxhi PERVANA Gjeo. Iv BEQARI Elek. Besmir LUMANI Hidr. Majlinda KONCI Ark. Besian MUHARREMI

Emertimi i fletes: Profillet Terthore	FLETA
SHKALLA	A13

POROSITESI: Bashkia Tirane

SEKSIONET TERTHORE PROGRESIVE TE RRUGES SEKONDARE Nr.3 (3 NGA 3)

SHKALLA A1-1:100 / A3-1:200

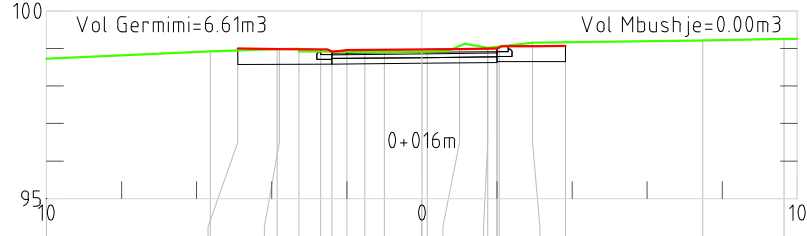

Dist-T(m):	10.00	5.64	3.86	1.52	0.14	1.76	2.95	7.48	9.65
Dist-Pj-T(m):				L=5.03					
Kuota-T (m):	98.72	98.92	98.98	98.90	98.91	99.02	99.15	99.21	99.25
Dist-P(m):		-4.90	-3.80	-2.70	-1.00	1.00	2.06	3.82	
Dist-Pj-P(m):				2.00	2.00				
Kuota-P (m):		99.00	98.99	98.97	98.96	98.98	99.02	99.07	

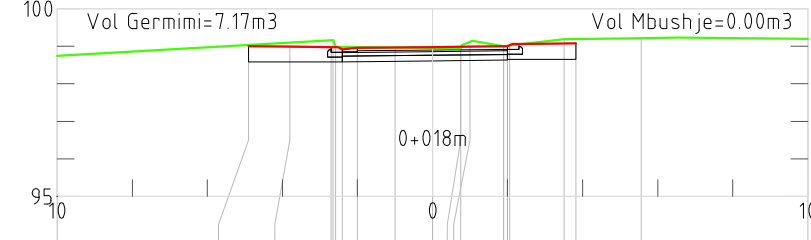

Dist-T(m):	10.00		2.65	0.75	1.89	3.50	5.56	10.00
Dist-Pj-T(m):			L=3.34	L=1.14				
Kuota-T (m):	98.75		99.16	98.95	99.00	99.19	99.22	99.20
Dist-P(m):		-4.90	-3.80	-2.70	-1.00	1.00	2.06	3.82
Dist-Pj-P(m):				2.00	2.00			
Kuota-P (m):		99.00	98.99	98.98	98.97	98.99	99.03	99.07

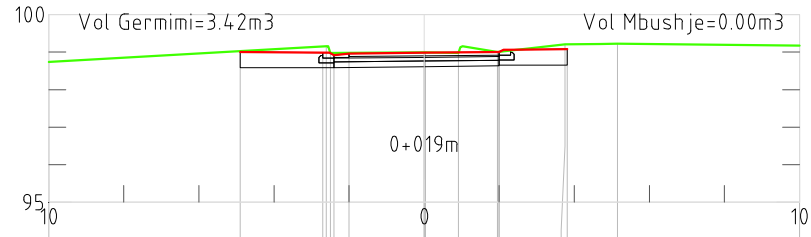

Dist-T(m):	10.00		2.61	0.04	1.95	3.75	5.15	10.00
Dist-Pj-T(m):			L=3.41	L=1.04				
Kuota-T (m):	98.74		99.16	98.99	99.00	99.21	99.23	99.47
Dist-P(m):		-4.90	-2.70	0.00	2.00	3.82		
Dist-Pj-P(m):				2.00	2.00			
Kuota-P (m):		99.00	98.98	98.98	99.00	99.08		

	Bashkia Tirane			
Emertimi i fletes: Profillet Terthore	OBJEKTI: "LAGJIA E ARTISTEVE" Emertimi: Realizimi i objektit "Lagjia e Artisteve"	SHENIME TEKNIKE: Inxh. Engjell ÇAKA Inxh. Liliana Vllamasi	Projektes: Inxh. Liliana VLLAMASI Inxh. Engjell ÇAKA Gjeo. Haxhi PERVANA Gjeo. Iv BEQARI Elek. Besmir LUMANI Hidr. Majlinda KONCI Ark. Besian MUHARREMI	POROSITESI: Bashkia Tirane
SHKALLA FLETA A13	FLETA A13			
		"Arabel - Studio Arabel" Sh.p.k <small>Adresa: Dher, Punaqulla, Gjeo. Doci, Tirane, Rruga M. Shekulli, Apartament N. 20, Ndërrimi Nr. 05</small>	"TRANSPORT HIGHWAY CONSULTING" Sh.p.k <small>Adresa: Tiranë, Komuna e Pallatit, Rruga Osman Myzeqerit, Apartament N. 20</small>	"Dricons" Sh.p.k <small>Adresa: Tiranë, Komuna e Pallatit, Rruga Osman Myzeqerit, Apartament N. 20</small>