

PLANIMETRIA E RRUGES 1:250

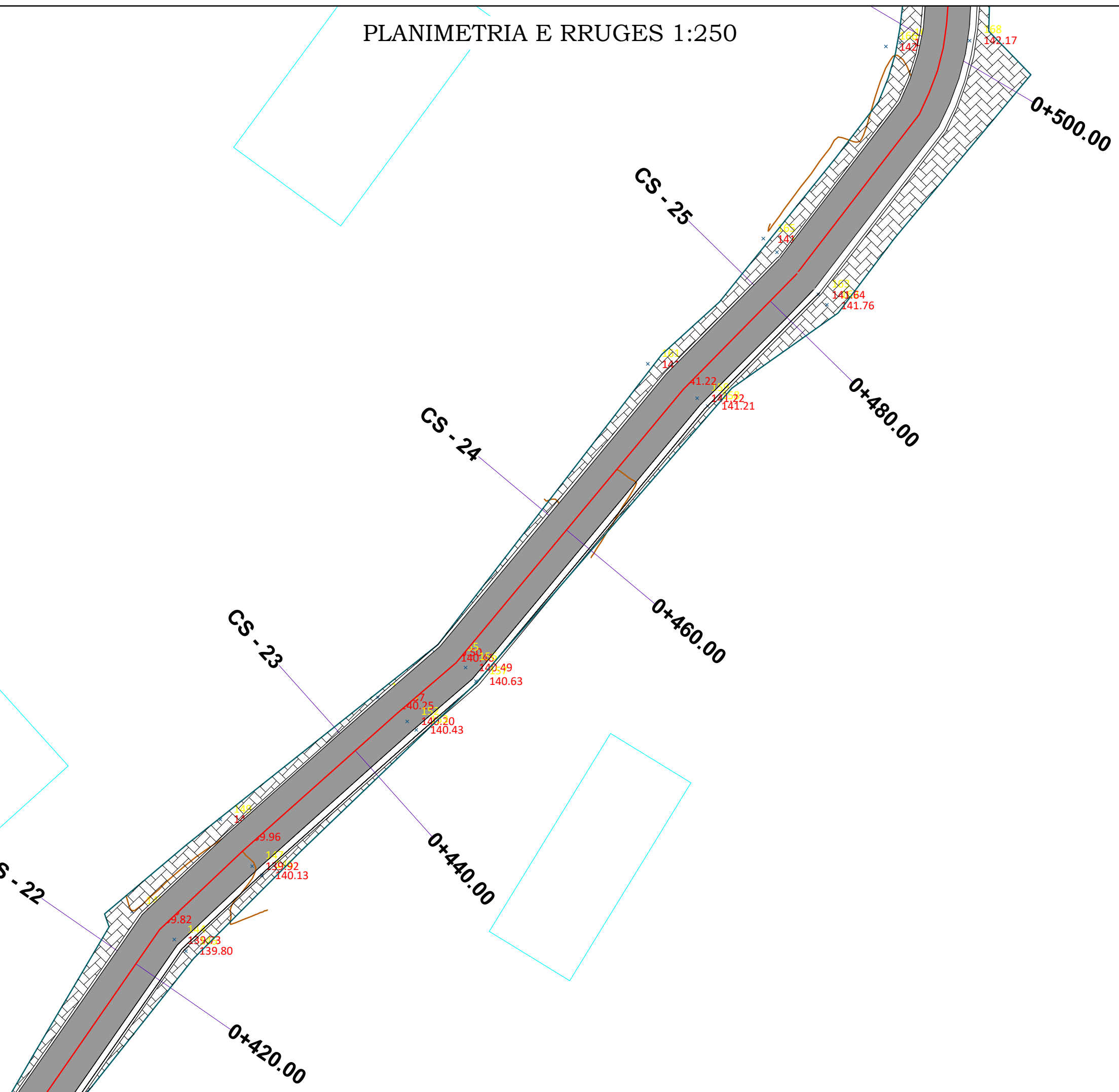

- ✕ 77, 139.31 Rilevimi topografik (kuota)
- Rilevimi topografik (Izoipse)
- Aksi i rruges
- Mure ekzistuese
- Trotuar ekzistues
- Godina ekzistuese
- Veshje me asfaltbeton/binder
- Trotuar i ri

Porositës:

**BASHKIA MALËSI
E MADHE**

Titulli i Projektit

**SISTEMIM ASFALTIM RRUGA GJURAJ
KOPLIK I SIPËRM**

Faza

PROJEKT ZBATIMI

Vula

Autor

"NOVATECH STUDIO "SHPK

ADMIN ING. EMIL NOVA

Grupi projektimit:

ING. NDERTIMI	Mimoza TOMCO
ARKITEKT	Gerta NOVA
ING. HIDROTEKNIK	Klodjan NDOJ
ING. HIDROTEKNIK	Kostandin NOVA
ING. GJEOLGJIK	Antonela BAZHDARI
ING. NDERTIMI	Petrika DOKU

Vula

Kapitulli

PROJEKT ARKITEKTONIK

Titulli i Vizatimit

PLANIMETRIA E RRUGES

Realizuar **DHJETOR 2022** Shkalla **1:250**

Emërtimi i Fletës

A 1 - 12

PLANIMETRIA E RRUGES 1:250

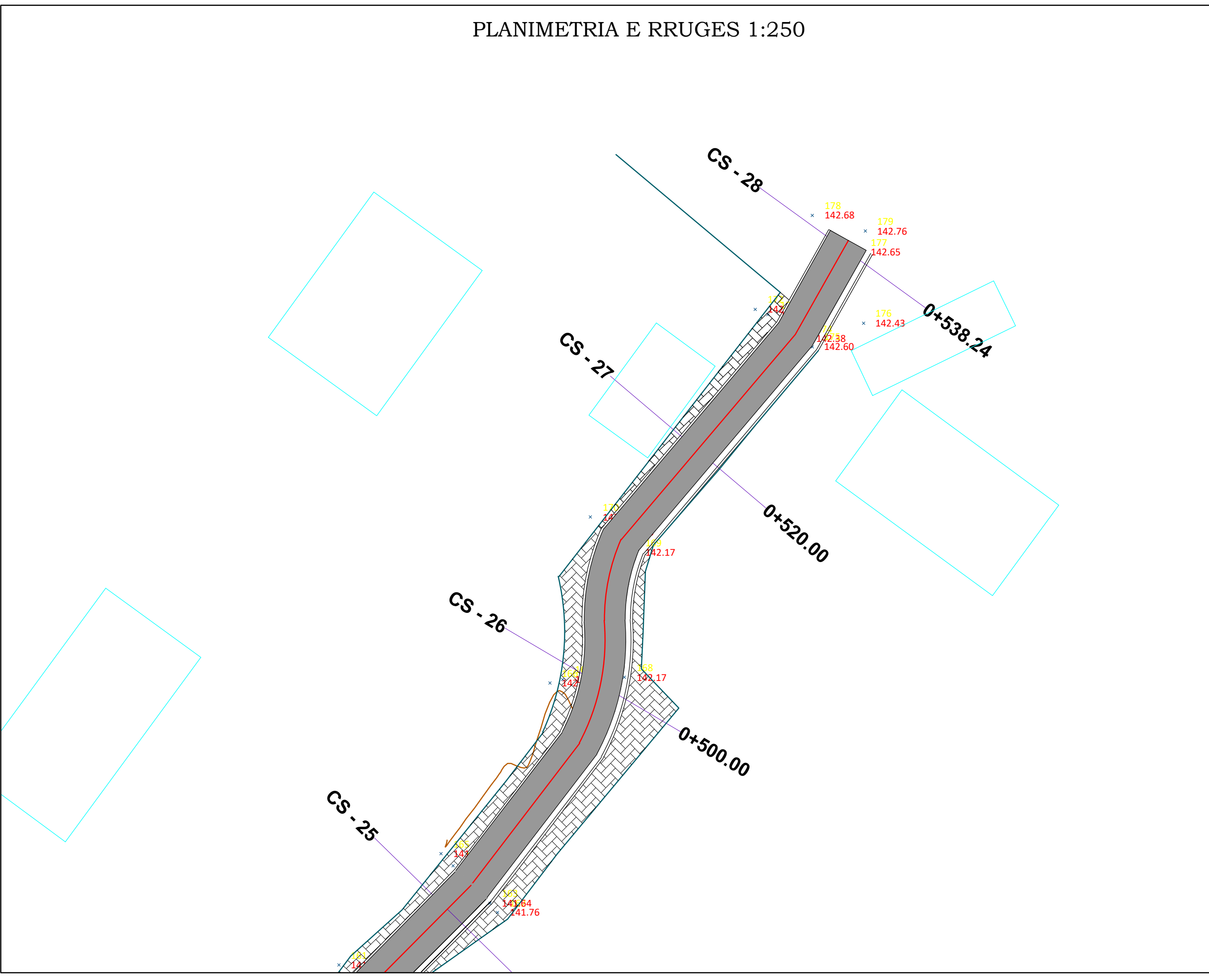

LEGJENDE

- x 77 139.31 Rilevimi topografik (kuota)
- Rilevimi topografik (Izoipse)
- Aksi i rruges
- Mure ekzistuese
- Trotuar ekzistues
- Godina ekzistuese
- Veshje me asfaltbeton/binder
- Trotuar i ri

Porositës:

**BASHKIA MALËSI
E MADHE**

Titulli i Projektit
**SISTEMIM ASFALTIM RRUGAJ
KOPLIK I SIPËRM**

Faza
PROJEKT ZBATIMI

Vula

Autor
"NOVATECH STUDIO "SHPK

ADMIN ING. EMIL NOVA

Grupi projektimit:

ING. NDERTIMI	Mimoza TOMCO
ARKITEKT	Gerta NOVA
ING. HIDROTEKNIK	Klodjan NDOJ
ING. HIDROTEKNIK	Kostandin NOVA
ING. GJEOLGJIK	Antonela BAZHDARI
ING. NDERTIMI	Petrika DOKU

Vula

Kapitulli
PROJEKT ARKITEKTONIK

Titulli i Vizatimit
PLANIMETRIA E RRUGES

Realizuar DHJETOR 2022	Shkalla 1:250
----------------------------------	-------------------------

Emërtimi i Fletës
A 1 - 13

PROFILI GJATESOR AKSI 01

SHH 1:1000 SHV 1:100

- LEGJENDE**
- ▲ 77, 139.31 Rilevimi topografik (kuota)
 - Rilevimi topografik (Izoipse)
 - Aksi i rruges
 - Mure ekzistuese
 - Trotuar ekzistues
 - Godina ekzistuese
 - Veshje me asfaltbeton/binder
 - Trotuar i ri

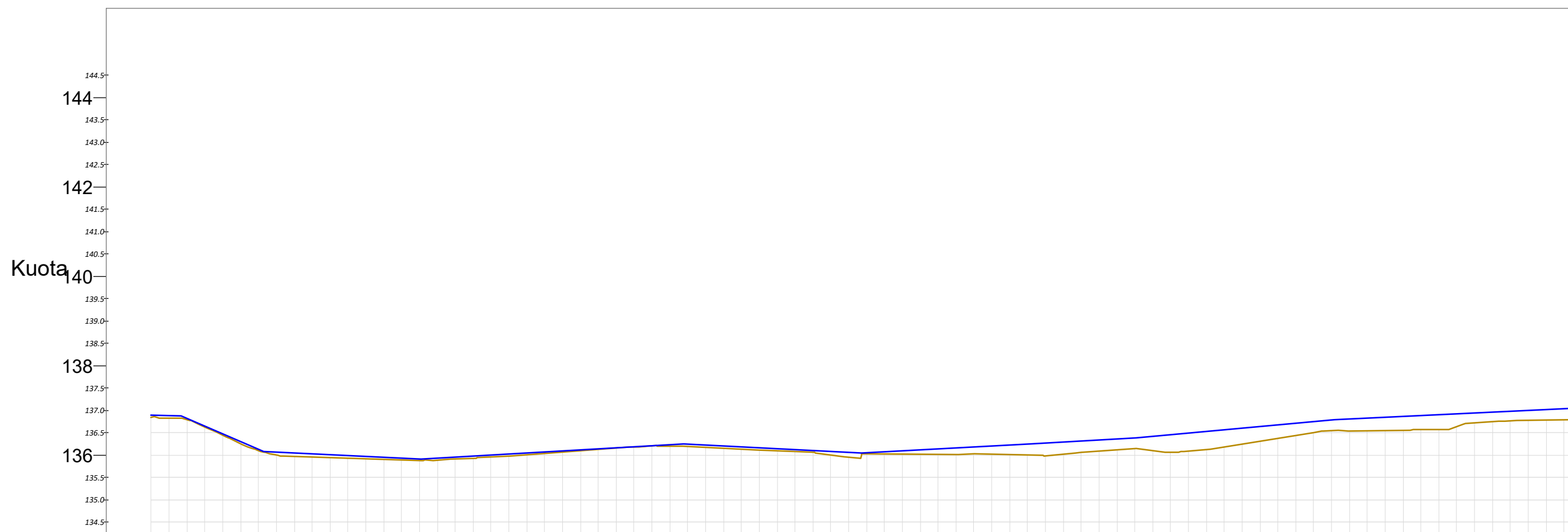

NR I PRERJES	CS - 1	CS - 2	CS - 3	CS - 4	CS - 5	CS - 6	CS - 7	CS - 8	CS - 9	CS - 10	CS - 11	CS - 12	CS - 13	CS - 14	CS - 15	CS - 16
KUOTA TOKES	136.85	136.75	136.95	135.88	135.99	136.13	136.19	136.11	136.03	136.02	135.98	136.14	136.19	136.51	136.56	136.74
KUOTA PROJEKTI	136.85	136.75	136.01	135.91	136.03	136.14	136.25	136.15	136.06	136.16	136.27	136.39	136.57	136.76	136.87	136.96
KUOTA PUNES	0.05	0.05	0.06	0.03	0.04	0.02	0.06	0.05	0.03	0.14	0.29	0.25	0.39	0.25	0.31	0.22
DIST PJESORE	10.00	20.00	20.00	20.00	20.00	20.00	20.00	20.00	20.00	20.00	20.00	20.00	20.00	20.00	20.00	20.00
DIST PROGRESIVE	0+000	0+020	0+040	0+060	0+080	0+100	0+120	0+140	0+160	0+180	0+200	0+220	0+240	0+260	0+280	0+300

Porositës:

**BASHKIA MALËSI
E MADHE**

Titulli i Projektit
SISTEMIM ASFALTIM RRUGAJ
KOPLIK I SIPËRM

Faza
PROJEKT ZBATIMI

Vula
Autor "NOVATECH STUDIO "SHPK

ADMIN ING. EMIL NOVA

Grupi projektimit:

ING. NDERTIMI	Mimoza TOMCO
ARKITEKT	Gerda NOVA
ING. HIDROTEKNIK	Klodjan NDOJ
ING. HIDROTEKNIK	Kostandin NOVA
ING. GJEOLGJIK	Antonela BAZHDARI
ING. NDERTIMI	Petrika DOKU

Vula

Kapitulli
PROJEKT ARKITEKTONIK

Titulli i Vizatimit
PROFILI GJATESOR I RRUGES

Realizuar DHJETOR 2022	Shkalla 1:1000 1:100
----------------------------------	---------------------------------------

Emërtimi i Fletës
A 1 - 14

PROFILI GJATESOR AKSI 01 SHH 1:1000 SHV 1:100

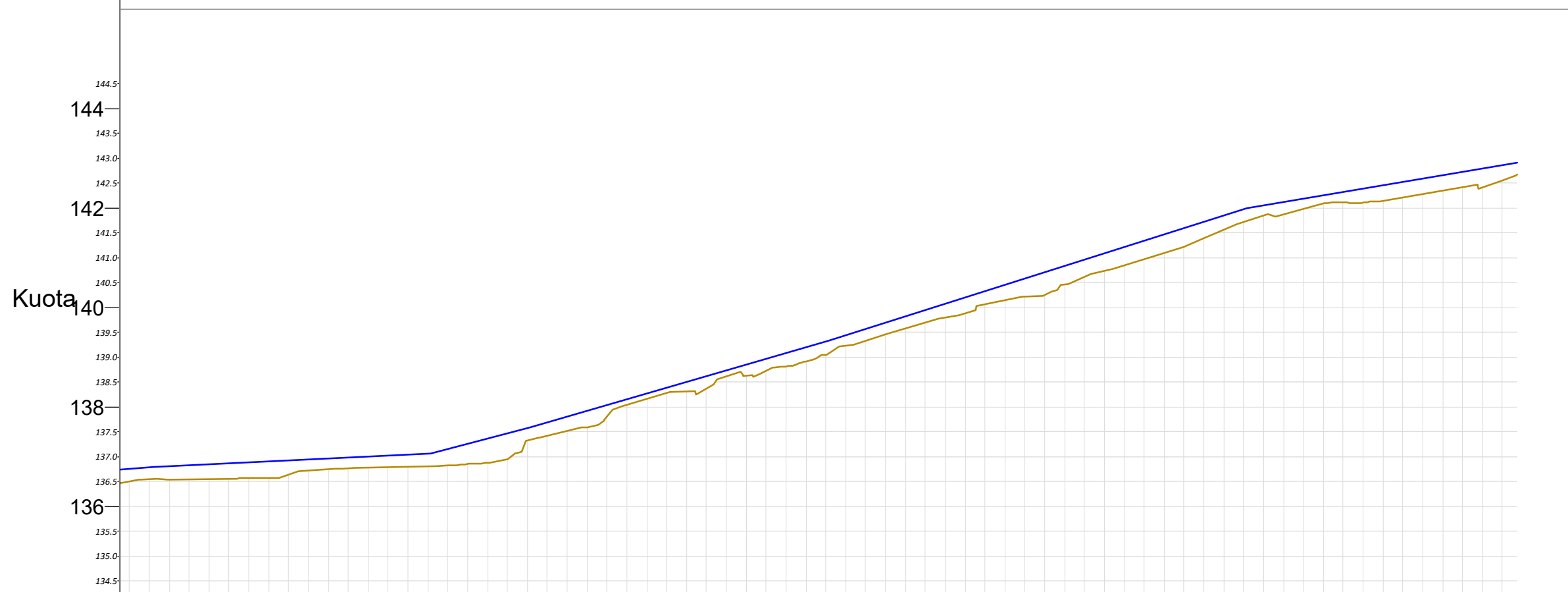

NR I PRERJES	CS - 14	CS - 15	CS - 16	CS - 17	CS - 18	CS - 19	CS - 20	CS - 21	CS - 22	CS - 23	CS - 24	CS - 25	CS - 26	CS - 27	CS - 28
KUOTA TOKES	136.51	136.56	136.74	136.81	137.32	138.04	138.62	139.05	139.70	140.21	140.84	141.57	142.09	142.28	142.59
KUOTA PROJEKTTIT	136.76	136.87	136.96	137.05	137.57	138.15	138.73	139.31	139.94	140.58	141.22	141.85	142.26	142.59	142.88
KUOTA PUNES	0.25	0.31	0.22	0.25	0.25	0.11	0.11	0.26	0.25	0.37	0.37	0.28	0.17	0.32	
DIST PJESORE		20.00	20.00	20.00	20.00	20.00	20.00	20.00	20.00	20.00	20.00	20.00	20.00	20.00	10.00
DIST PROGRESIVE	0+000	0+020	0+040	0+060	0+080	0+100	0+120	0+140	0+160	0+180	0+200	0+220	0+240	0+260	0+280

Porositës:

**BASHKIA MALËSI
E MADHE**

Titulli i Projektit
SISTEMIM ASFALTIM RRUGAJ
KOPLIK I SIPËRM

Faza
PROJEKT ZBATIMI

Vula
Autor "NOVATECH STUDIO "SHPK

ADMIN ING. EMIL NOVA

Grupi projektimit:

ING. NDERTIMI	Mimoza TOMCO
ARKITEKT	Gerda NOVA
ING. HIDROTEKNIK	Klodjan NDOJ
ING. HIDROTEKNIK	Kostandin NOVA
ING. GJEOLGJIK	Antonela BAZHDARI
ING. NDERTIMI	Petrika DOKU

Vula

Kapitulli
PROJEKT ARKITEKTONIK

Titulli i Vizatimit
PROFILI GJATESOR I RRUGES

Realizuar DHJETOR 2022	Shkalla 1:1000 1:100
----------------------------------	---------------------------------------

Emërtimi i Fletës
A 1 - 15

**PROFILI GJATESOR AKSI 02
DHE AKSI 03 SHH 1:1000 SHV
1:100**

AKSI 02

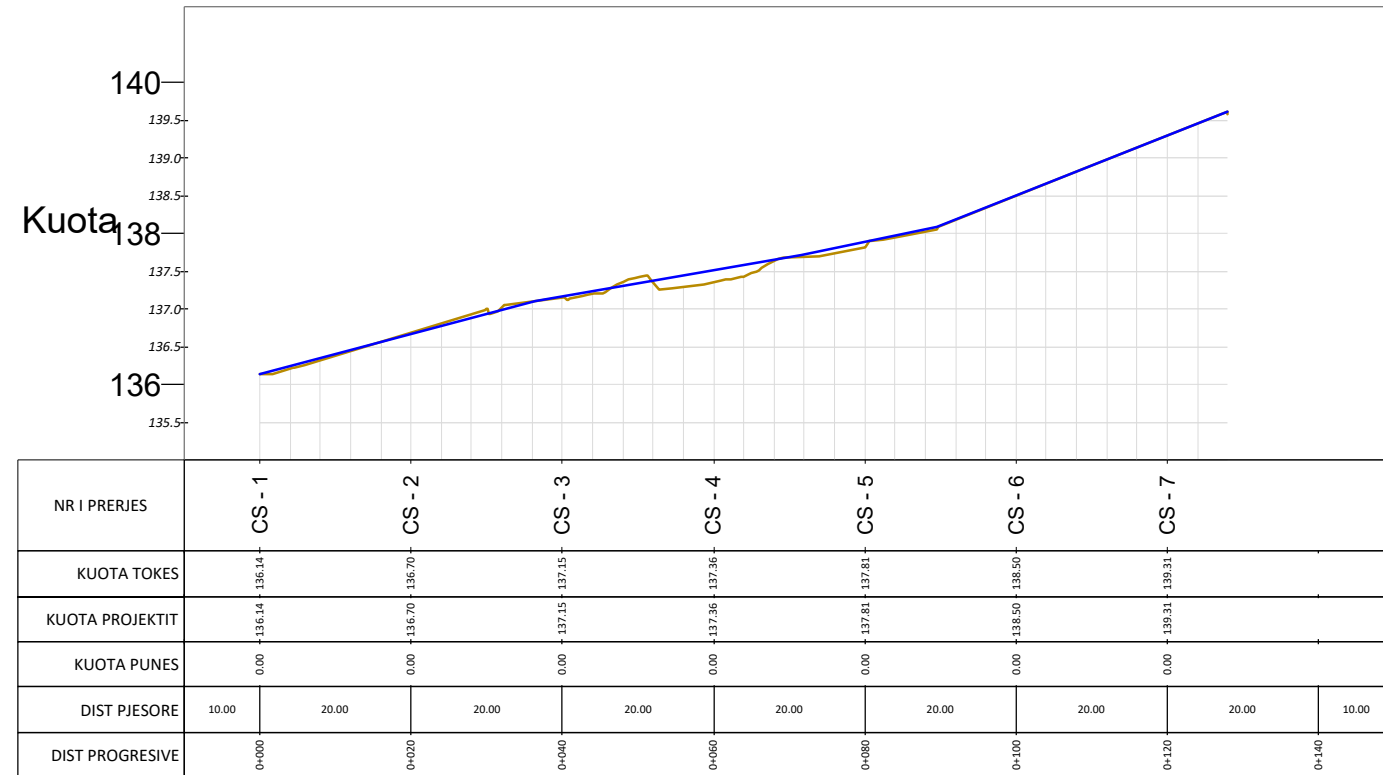

AKSI 03

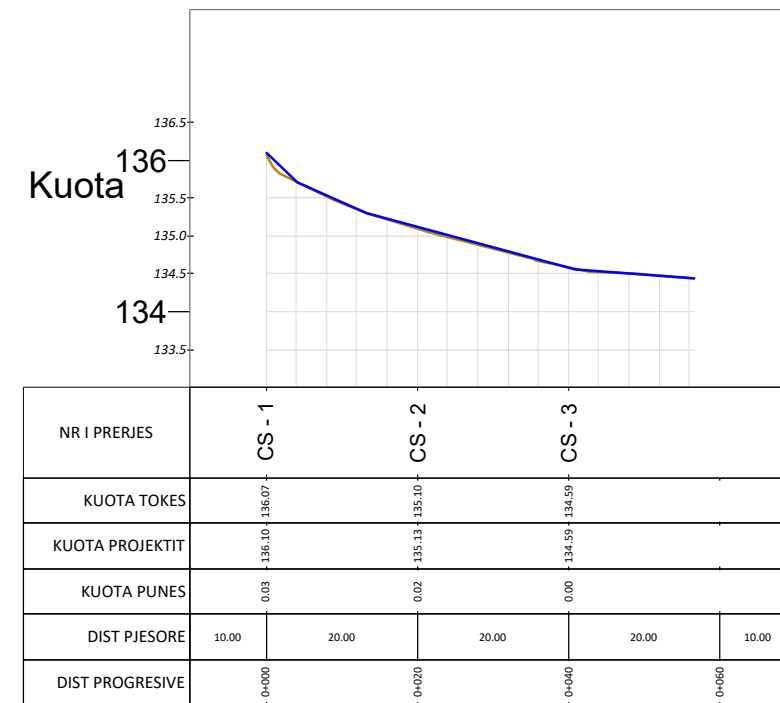

Porositës:

**BASHKIA MALËSI
E MADHE**

Titulli i Projektit

**SISTEMIM ASFALTIM RRUGAJ
KOPLIK I SIPËRM**

Faza

PROJEKT ZBATIMI

Vula

Autor "NOVATECH STUDIO "SHPK

ADMIN ING. EMIL NOVA

Grupi projektimit:

ING. NDERTIMI	Mimoza TOMCO
ARKITEKT	Gerta NOVA
ING. HIDROTEKNIK	Klodjan NDOJ
ING. HIDROTEKNIK	Kostandin NOVA
ING. GJEOLGJIK	Antonela BAZHDARI
ING. NDERTIMI	Petrika DOKU

Vula

Kapitulli

PROJEKT ARKITEKTONIK

Titulli i Vizatimit

PROFILI GJATESOR I RRUGES

Realizuar	DHJETOR 2022	Shkalla	1:1000
Emërtimi i Fletës			1:100

A 1 - 16

PROFIL TIP 1
pg0+000-pg0+023

PROFILI TIP 1:40

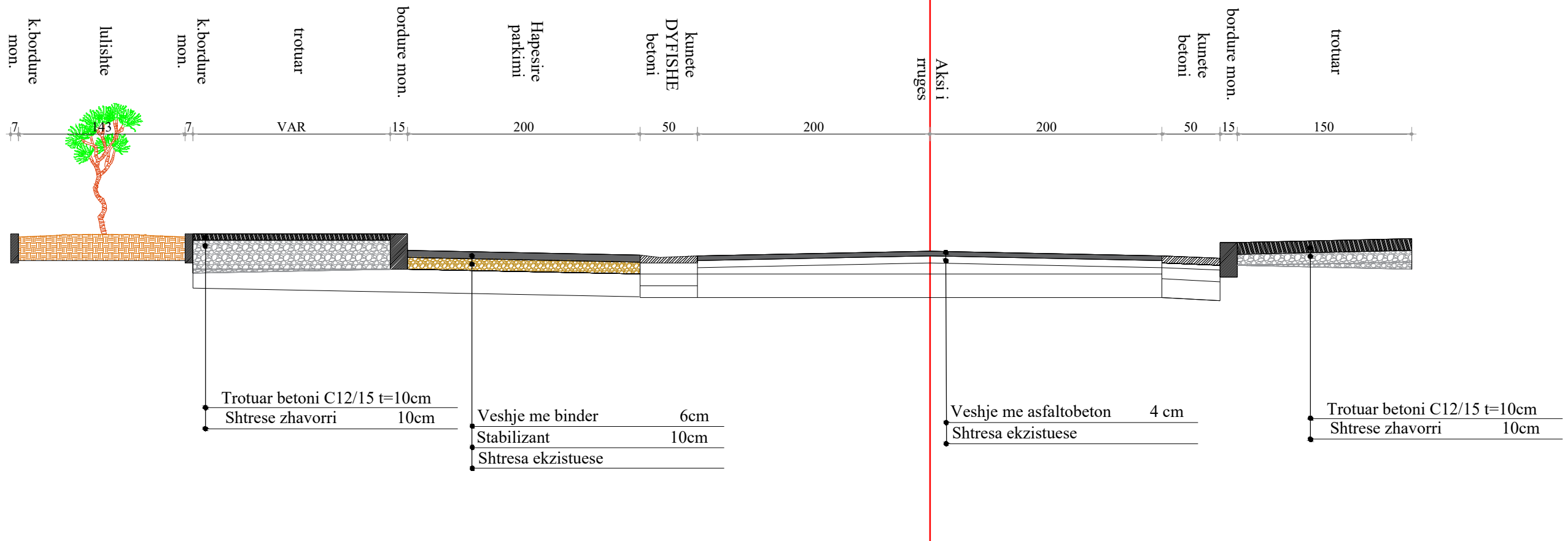

PROFIL TIP 2
pg0+023.01-pg0+062.83

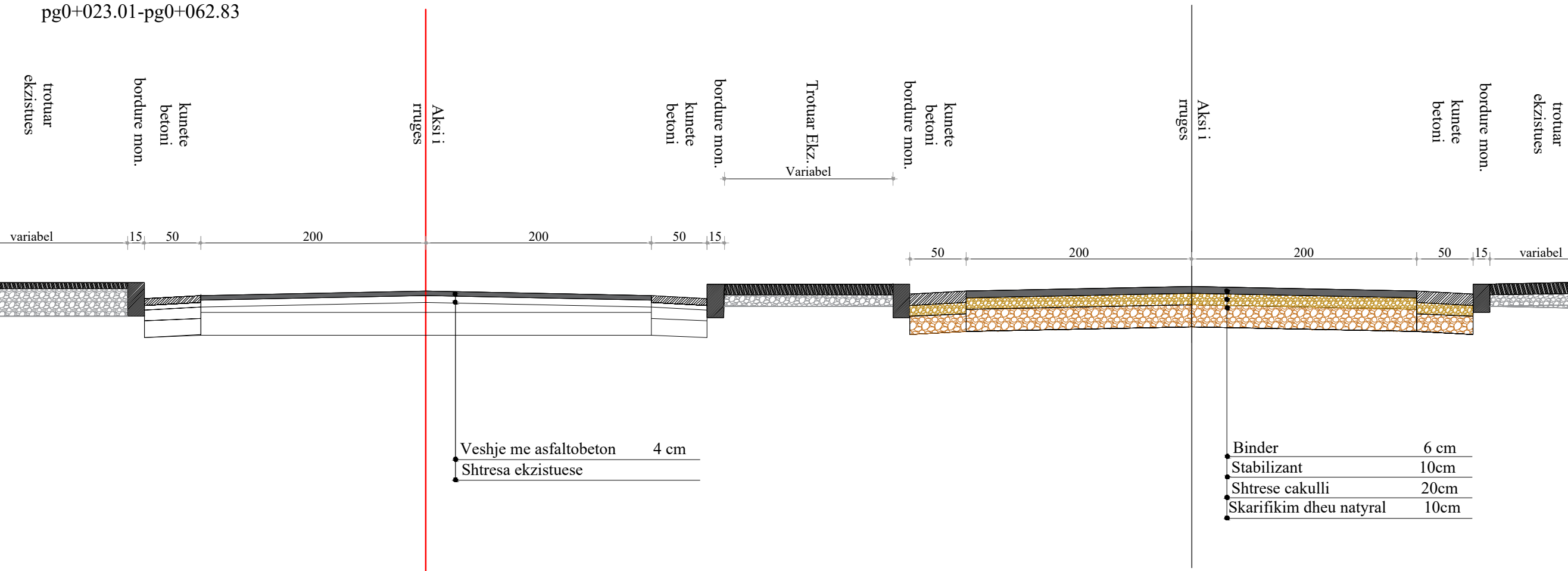

Porositës:
**BASHKIA MALËSI
E MADHE**

Titulli i Projektit
**SISTEMIM ASFALTIM RRUGA GJURAJ
KOPLIK I SIPËRM**

Faza
PROJEKT ZBATIMI

Vula

Autor
"NOVATECH STUDIO "SHPK
ADMIN ING. EMIL NOVA

Grupi projektimit:

ING. NDERTIMI	Mimoza TOMCO
ARKITEKT	Gerda NOVA
ING. HIDROTEKNIK	Klodjan NDOJ
ING. HIDROTEKNIK	Kostandin NOVA
ING. GJEOLGJIK	Antonela BAZHDARI
ING. NDERTIMI	Petrika DOKU

Vula

Kapitulli
PROJEKT ARKITEKTONIK

Titulli i Vizatimit
PROFILI TIP

Realizuar **DHJETOR 2022** Shkalla **1:40**

Emërtimi i Fletës
A 1 - 17

PROFILI TIP 1:40

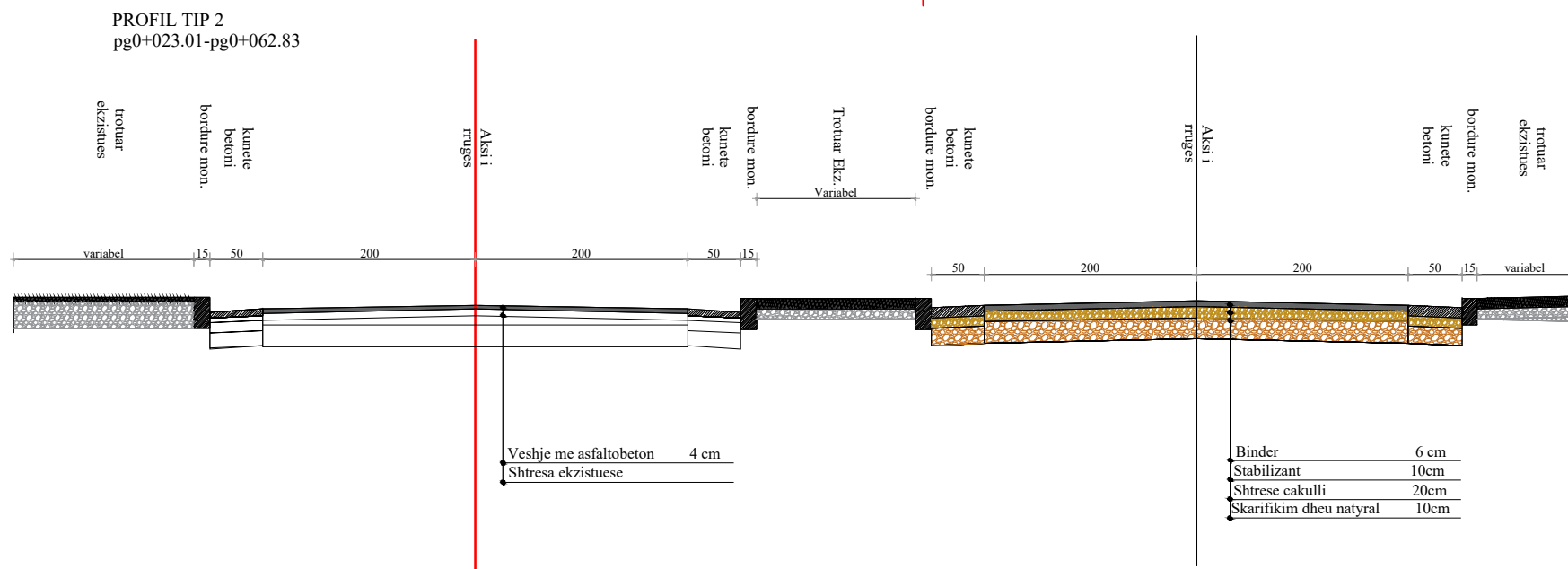
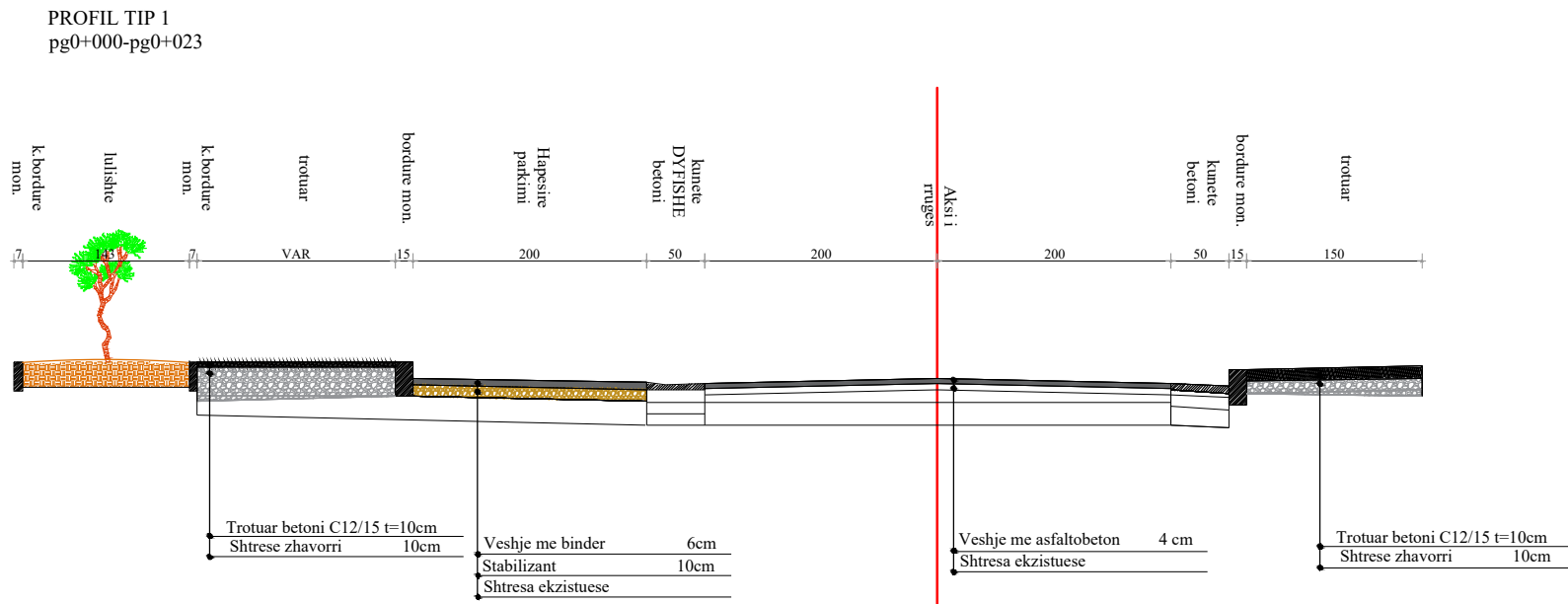

Porositës:

**BASHKIA MALËSI
E MADHE**

Titulli i Projektit

**SISTEMIM ASFALTIM RRUGAJ
KOPLIK I SIPËRM**

Faza

PROJEKT ZBATIMI

Vula

Autor

"NOVATECH STUDIO "SHPK

ADMIN ING. EMIL NOVA

Grupi projektimit:

ING. NDERTIMI	Mimoza TOMCO
ARKITEKT	Gerda NOVA
ING. HIDROTEKNIK	Klodjan NDOJ
ING. HIDROTEKNIK	Kostandin NOVA
ING. GJEOLGJIK	Antonela BAZHDARI
ING. NDERTIMI	Petrika DOKU

Vula

Kapitulli

PROJEKT ARKITEKTONIK

Titulli i Vizatimit

PROFILI TIP

Realizuar **DHJETOR 2022** Shkalla **1:40**

Emërtimi i Fletës

A 1 - 18

PROFIL TIP 3
pg0+062.84-pg0+207.50

PROFILI TIP 1:40

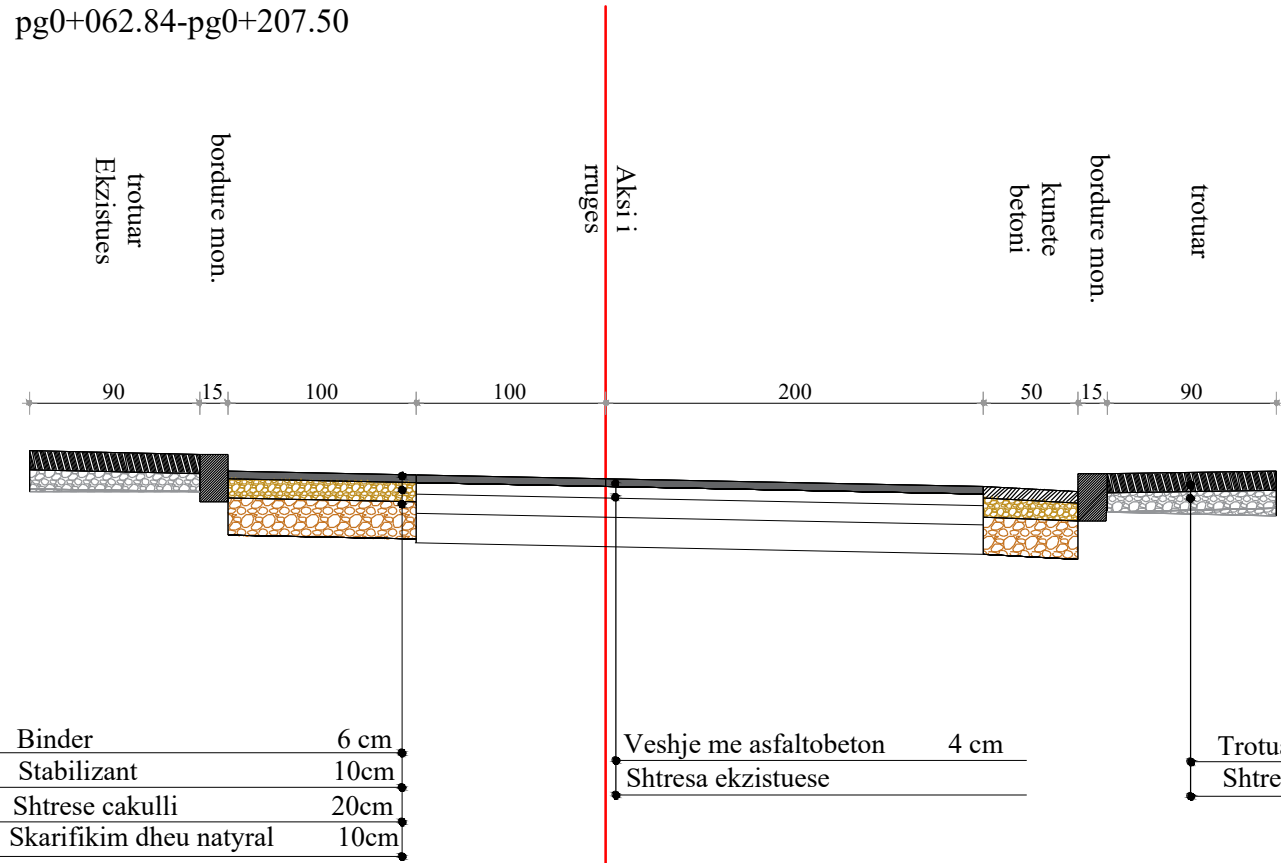

PROFIL TIP 5
pg0+333.76-pg0+538.78

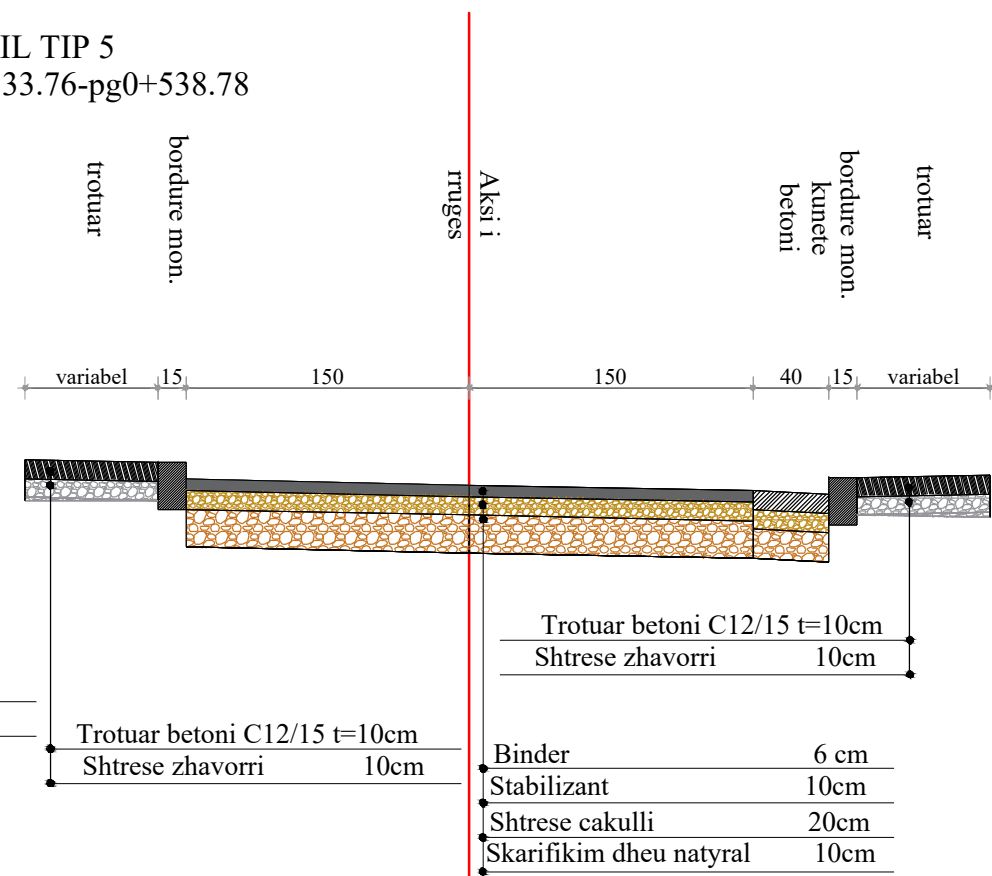

PROFIL TIP 4
pg0+207.51-pg0+333.76

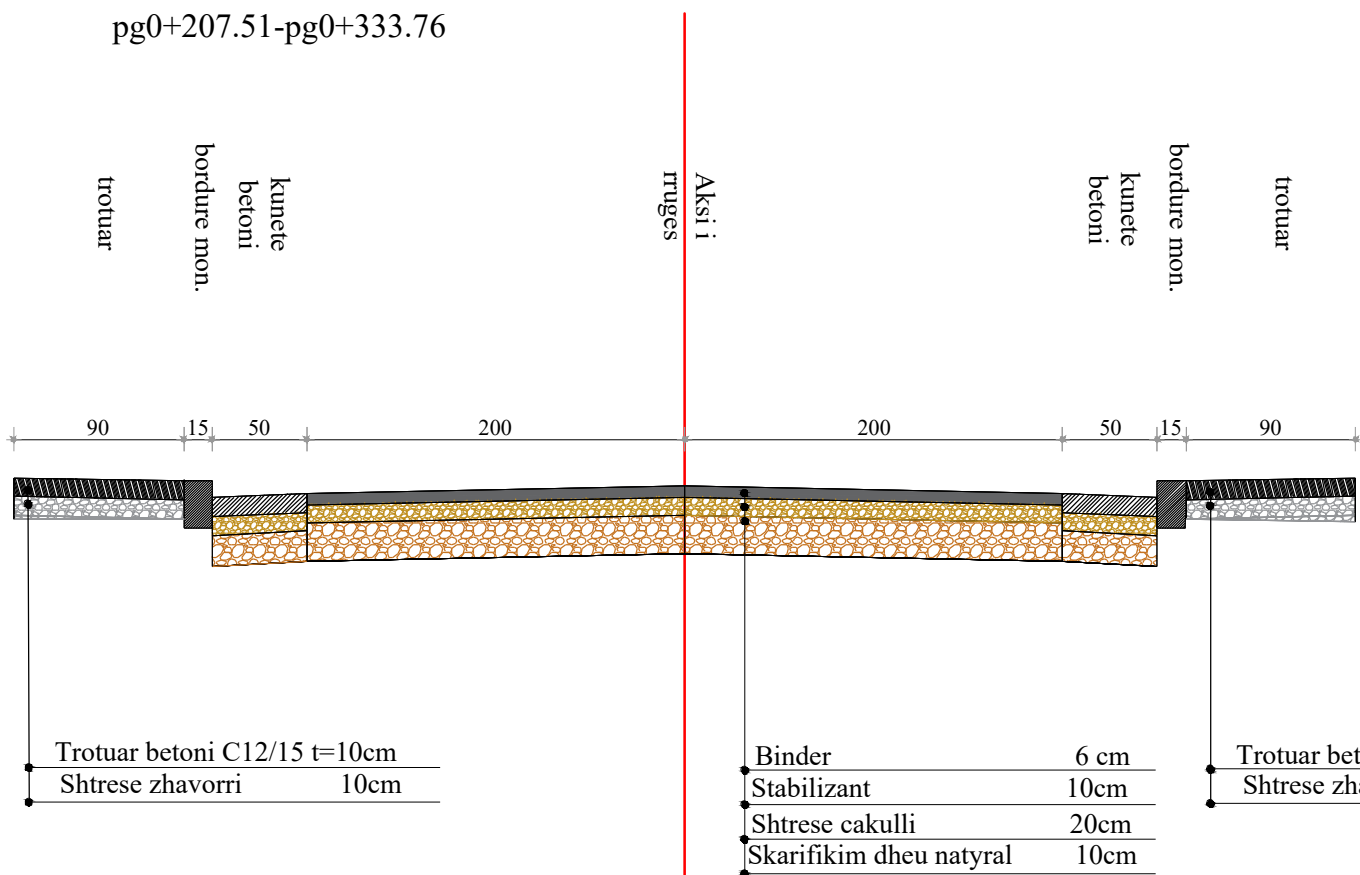

PROFIL TIP 1* DHE PROFIL TIP 1**
Aksi 03 pg0+000-pg0+056.13
Aksi 02 pg0+000-pg0+127.95

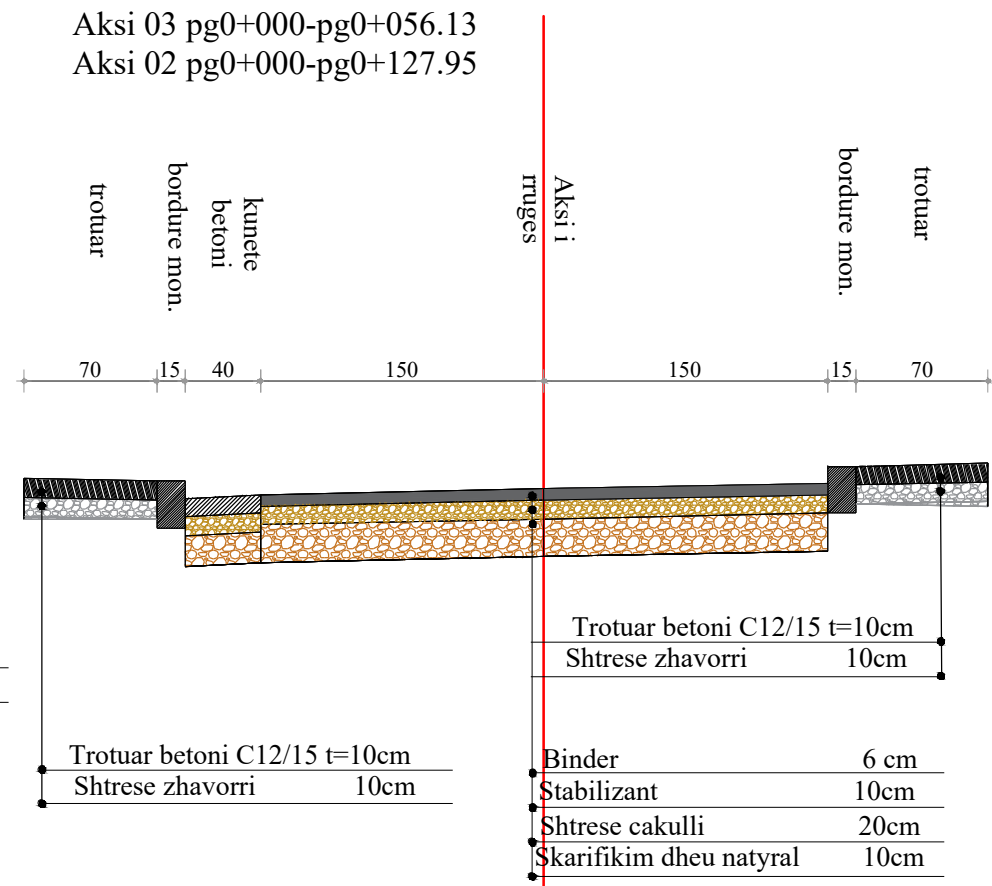

Porositës:

**BASHKIA MALËSI
E MADHE**

Titulli i Projektit

**SISTEMIM ASFALTIM RRUGA GJURAJ
KOPLIK I SIPËRM**

Faza

PROJEKT ZBATIMI

Vula

Autor "NOVATECH STUDIO "SHPK



Grupi projektimit:

ING. NDERTIMI	Mimoza TOMCO
ARKITEKT	Gerda NOVA
ING. HIDROTEKNIK	Klodjan NDOJ
ING. HIDROTEKNIK	Kostandin NOVA
ING. GJEOLGJIK	Antonela BAZHDARI
ING. NDERTIMI	Petrika DOKU

Vula

Kapitulli

PROJEKT ARKITEKTONIK

Titulli i Vizatimit

PROFILI TIP

Realizuar **DHJETOR 2022** Shkalla **1:40**

Emërtimi i Fletës

A 1 - 19

PROFILA TERTHORE

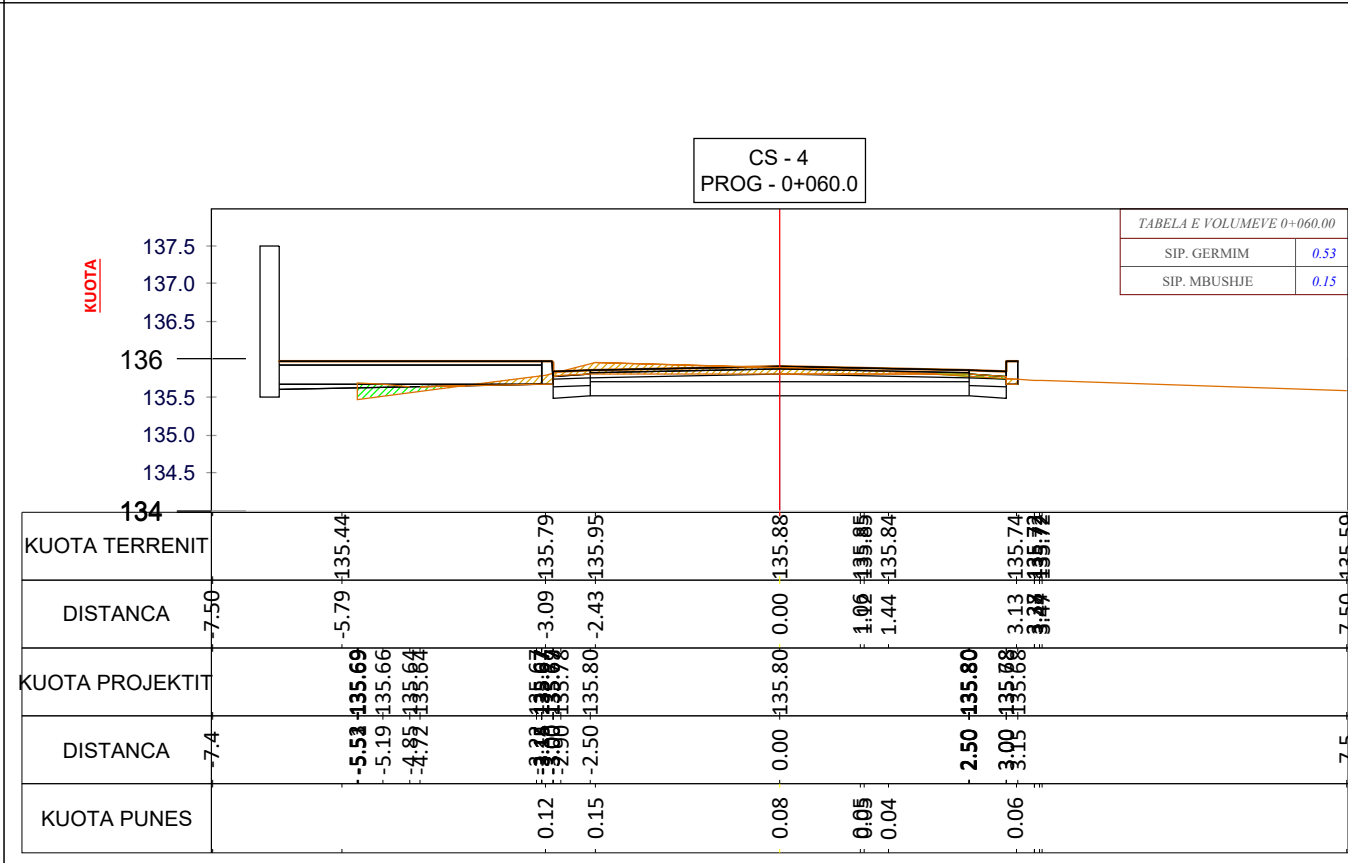
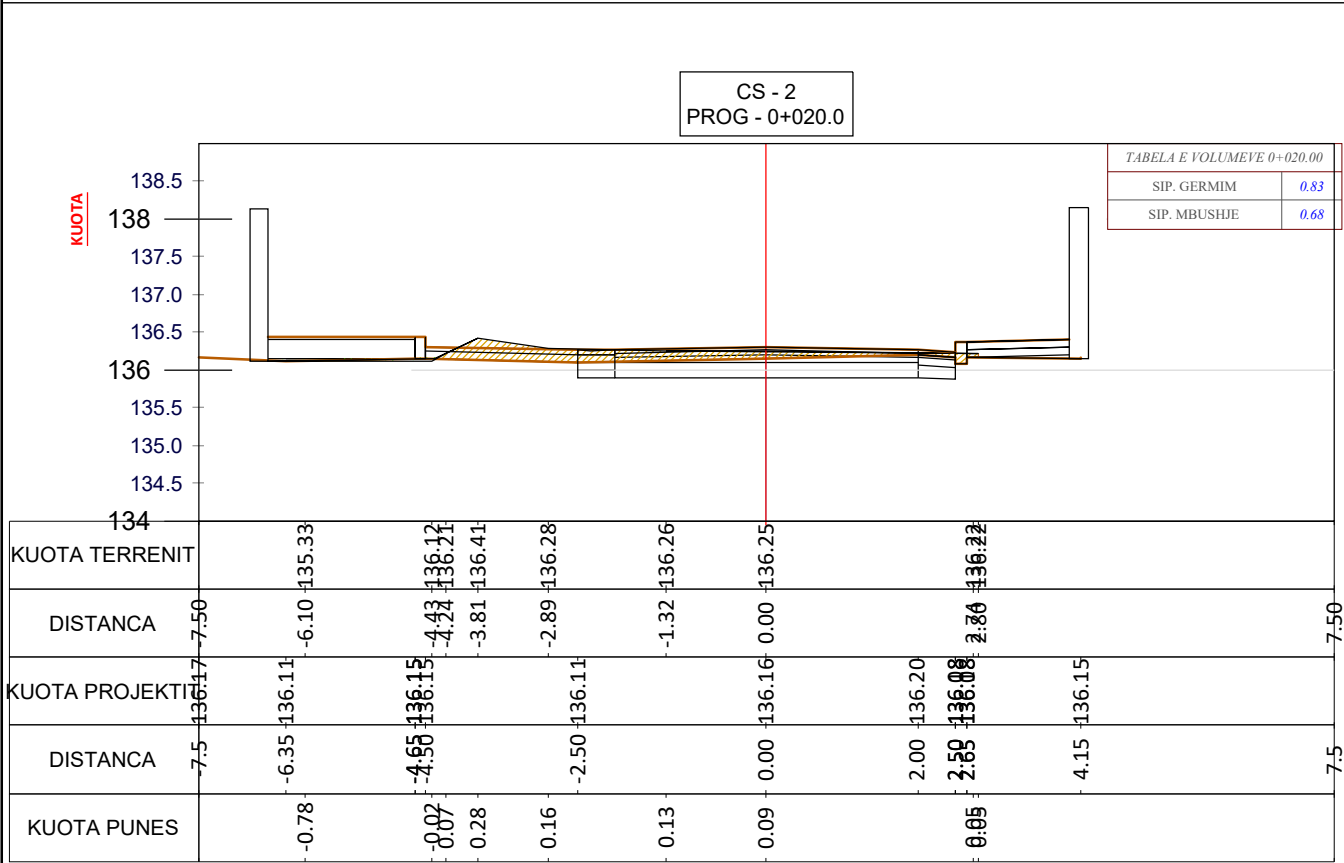
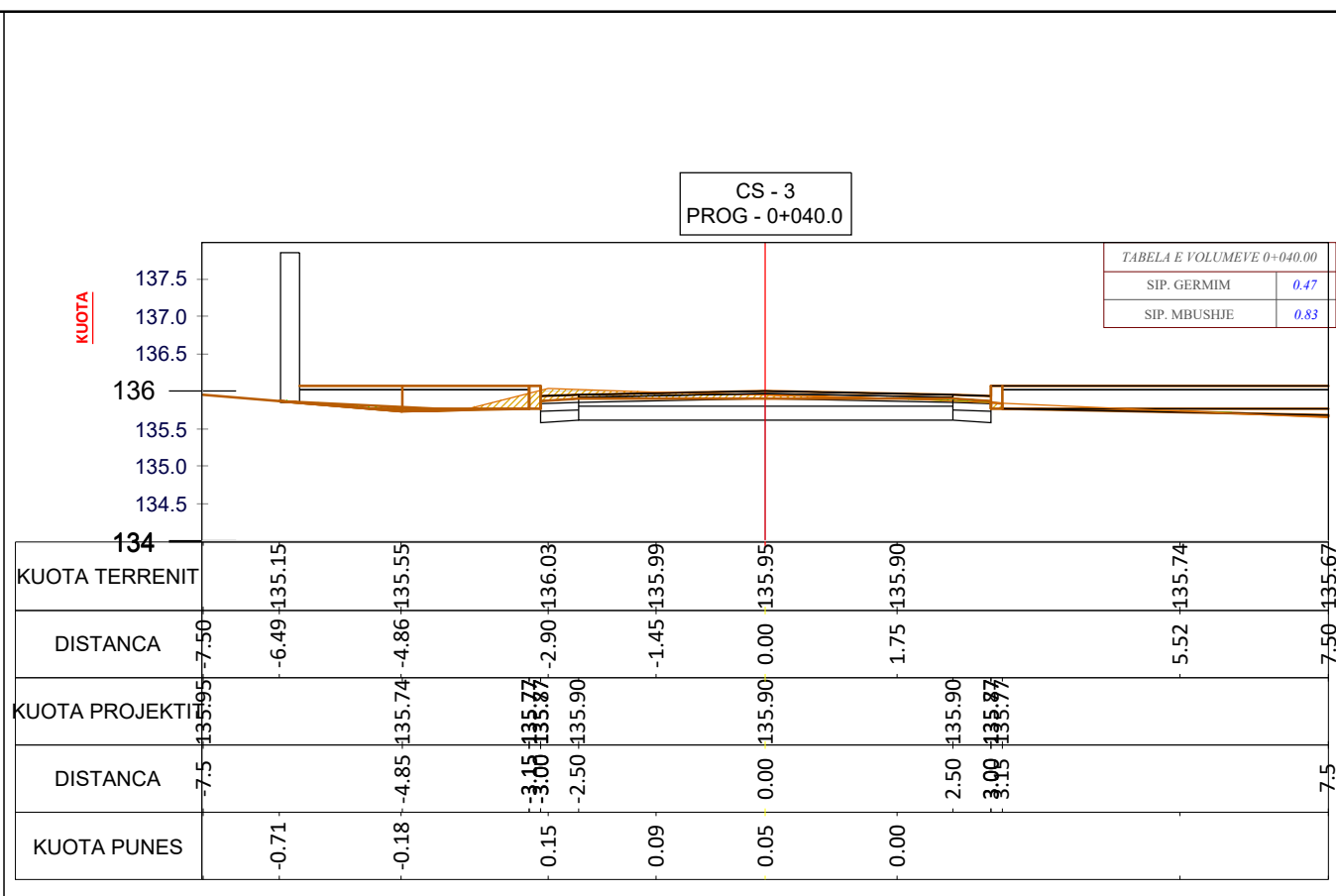
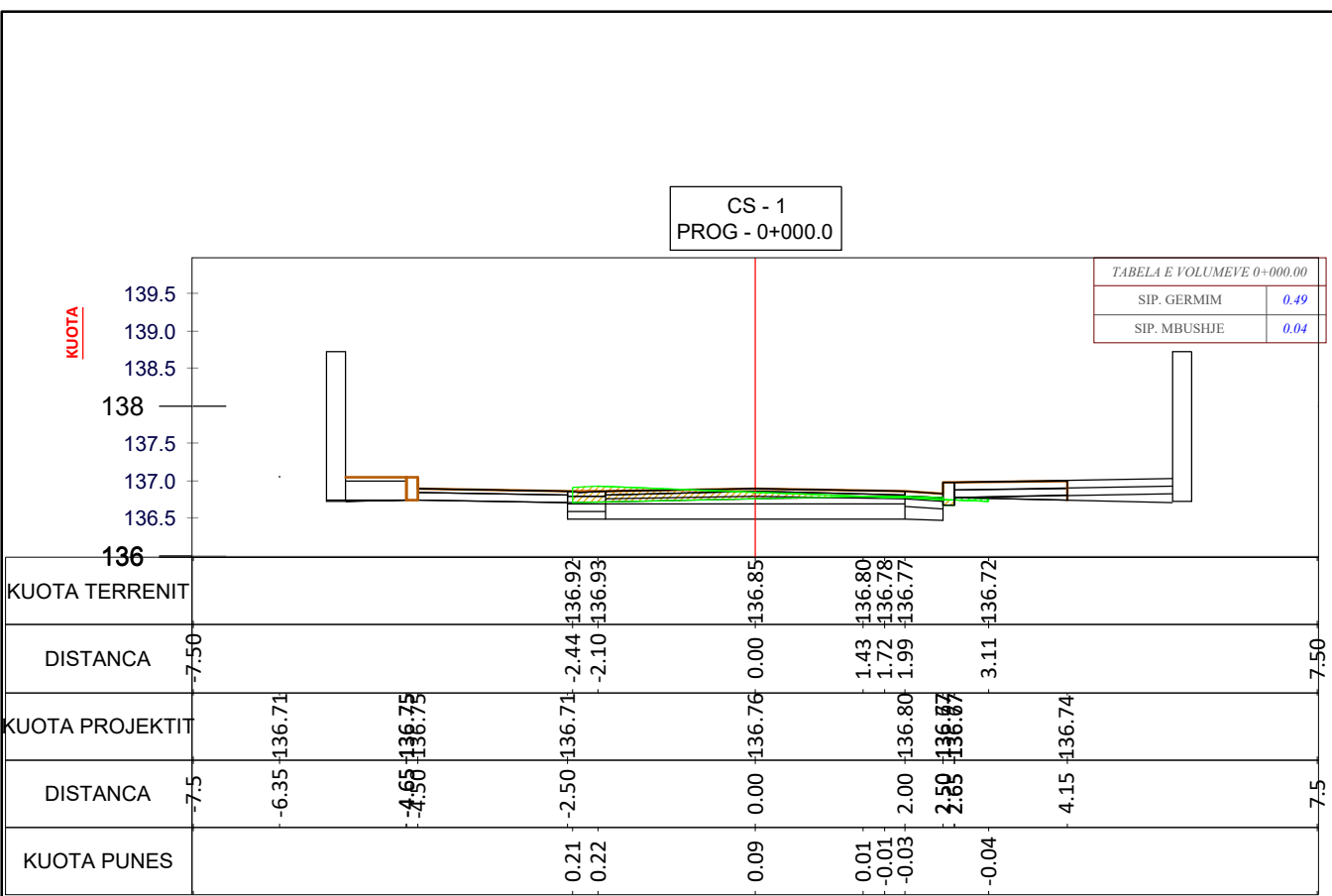

Porositës:
**BASHKIA MALËSI
E MADHE**

Titulli i Projektit
**SISTEMIM ASFALTIM RRUGA GJURAJ
KOPLIK I SIPËRM**

Faza
PROJEKT ZBATIMI

Vula
Autor
**"NOVATECH STUDIO "SHPK
ADMIN ING. EMIL NOVA**

Grupi projektimit:
ING. NDERTIMI MIMOZA TOMCO
ARKITEKT GERGA NOVA
ING. HIDROTEKNIK KLODJAN NDOJ
ING. HIDROTEKNIK KOSTANDIN NOVA
ING. GJEOLGJIK ANTONELA BAZHDARI
ING. NDERTIMI PETRIKA DOKU

Kapitulli
PROJEKT ARKITEKTONIK

Titulli i Vizatimit
PROFILA TERTHORE

Realizuar **DHJETOR 2022** Shkalla **1:40**

Emërtimi i Fletës
A 1 - 20

PROFILA TERTHORE

CS - 5
PROG - 0+080.0

KUOTA

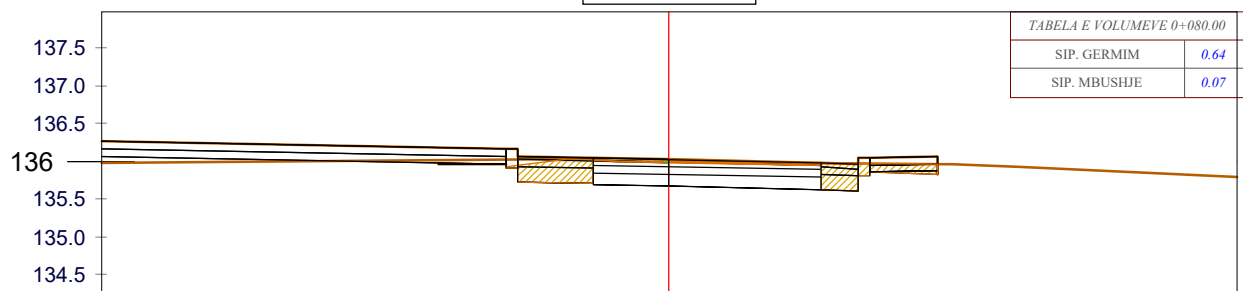

KUOTA TERRENIT	135.94	135.96	136.02	136.00	135.99	135.89	135.88	135.97	135.92
DISTANCA	7.50		1.35	0.87	0.03	2.00	2.50	3.57	4.60
KUOTA PROJEKTI	135.94	135.96	136.02	136.00	135.99	135.89	135.88	135.97	135.92
DISTANCA	7.5	3.05	2.05	1.00	0.00	2.00	2.50	3.55	4.60
KUOTA PUNES			0.31	0.00	0.00				

CS - 7
PROG - 0+120.0

KUOTA

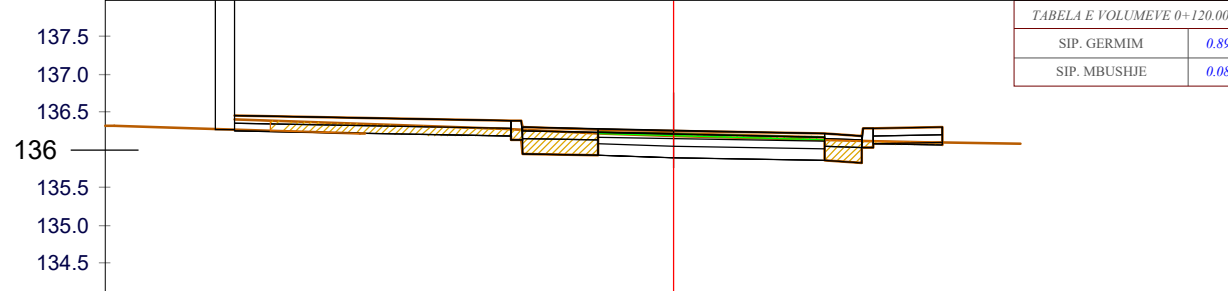

KUOTA TERRENIT	136.31	136.28	136.25	136.22	136.18	136.28	136.25	136.21	136.19	136.12	136.10	136.08
DISTANCA	7.50		5.32	2.96	1.67	2.10	1.67	1.00	0.00	2.63	3.42	4.59
KUOTA PROJEKTI	136.31	136.28	136.25	136.22	136.18	136.28	136.25	136.21	136.19	136.12	136.10	136.08
DISTANCA	7.5	6.34	5.25	4.05	3.05	2.05	1.00	0.00	0.00	2.00	2.50	3.55
KUOTA PUNES			0.13	0.10	0.31	0.28	-0.02			0.09	0.04	

CS - 6
PROG - 0+100.0

KUOTA

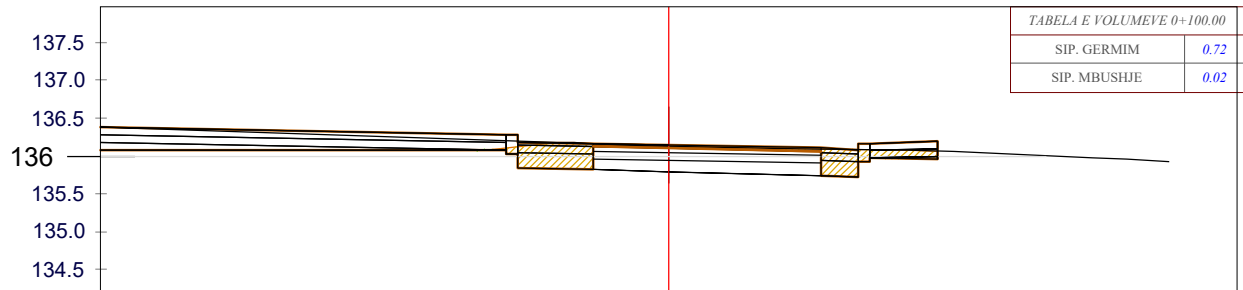

KUOTA TERRENIT	135.85	135.87	136.18	136.14	136.13	136.09	136.08	135.97	135.95	135.93
DISTANCA	7.50	4.25	1.47	1.26	0.68	1.74	3.15	5.60	6.06	6.61
KUOTA PROJEKTI	135.85	135.87	136.18	136.14	136.13	136.09	136.08	135.97	135.95	135.93
DISTANCA	7.5	3.05	2.05	1.00	0.00	2.00	2.50	3.55		
KUOTA PUNES			0.35	0.02	0.02	0.02	0.12			

CS - 8
PROG - 0+140.0

KUOTA

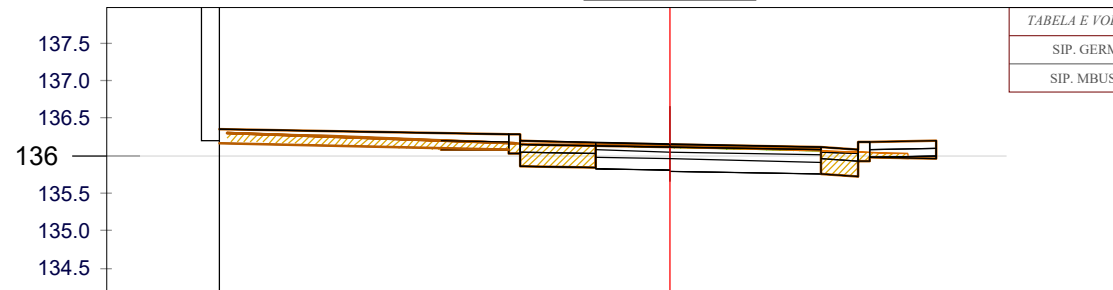

KUOTA TERRENIT	136.30	136.26	136.15	136.13	136.11	136.04	136.03
DISTANCA	7.50	5.91	4.88	2.87	0.81	2.59	2.99
KUOTA PROJEKTI	136.25	136.26	136.15	136.13	136.11	136.04	136.03
DISTANCA	7.5	3.05	2.05	1.00	0.00	2.00	2.50
KUOTA PUNES		0.11	0.11	0.13	0.00	-0.01	0.11

Porositës:

**BASHKIA MALËSI
E MADHE**

Titulli i Projektit

**SISTEMIM ASFALTIM RRUGAJ
KOPLIK I SIPËRM**

Faza

PROJEKT ZBATIMI

Vula

Autor "NOVATECH STUDIO "SHPK



ADMIN ING. EMIL NOVA

Grupi projektimit:

ING. NDERTIMI	Mimoza TOMCO
ARKITEKT	Gerda NOVA
ING. HIDROTEKNIK	Klodjan NDOJ
ING. HIDROTEKNIK	Kostandin NOVA
ING. GJEOLGJIK	Antonela BAZHDARI
ING. NDERTIMI	Petrika DOKU

Vula

Kapitulli

PROJEKT ARKITEKTONIK

Titulli i Vizatimit

PROFILA TERTHORE

Realizuar

DHJETOR 2022

Shkalla

1:40

Emërtimi i Fletës

A 1 - 21

PROFILA TERTHORE

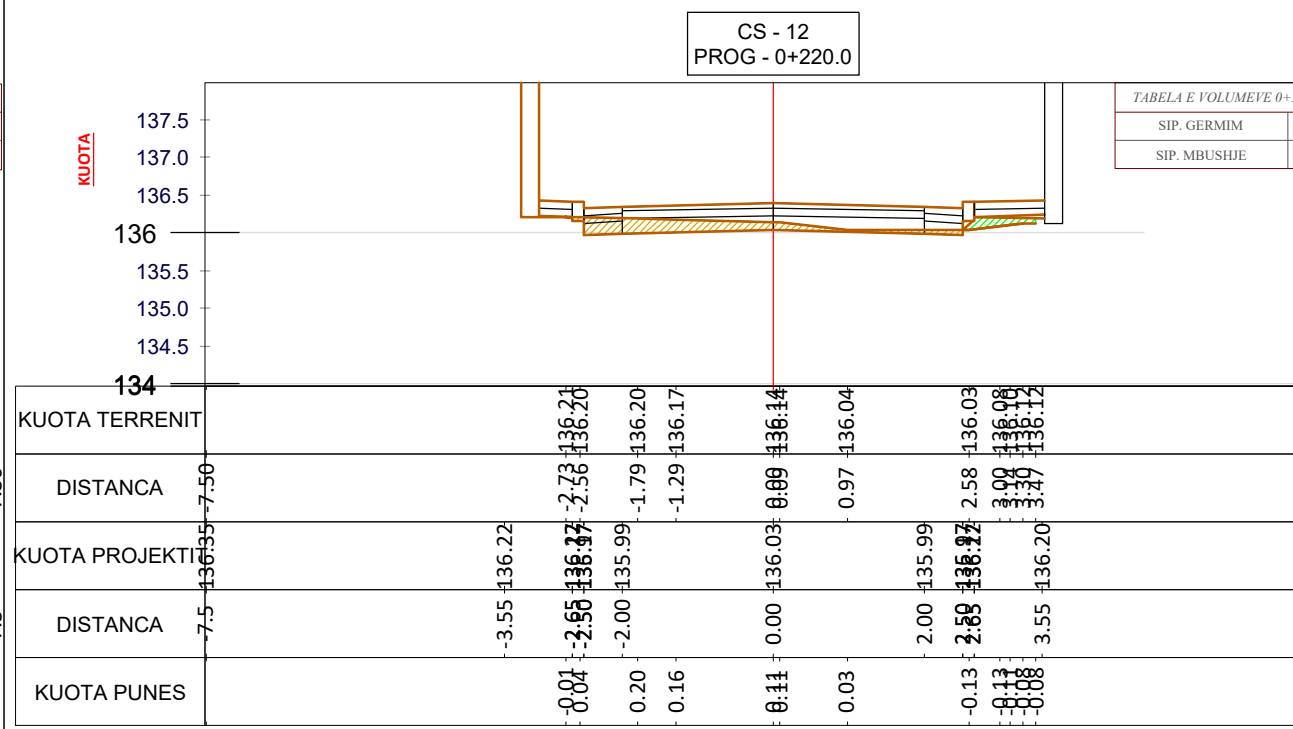
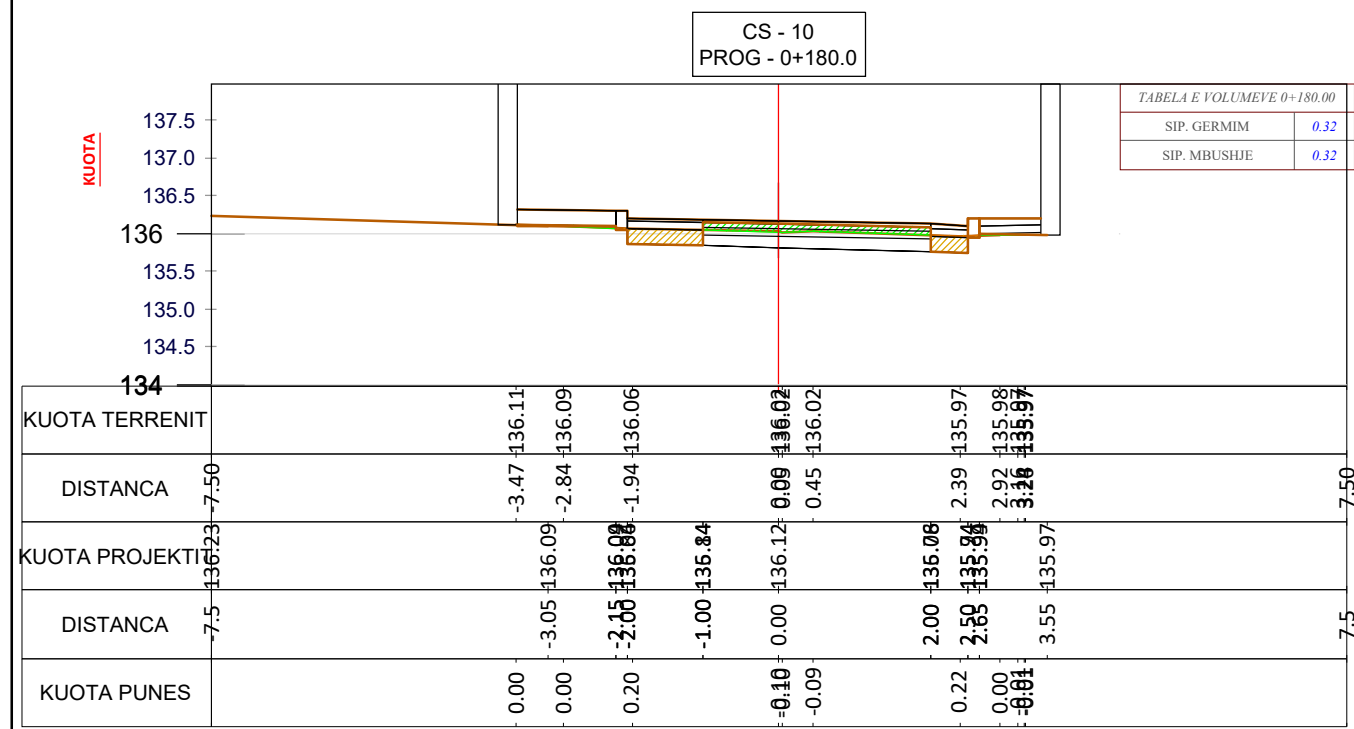
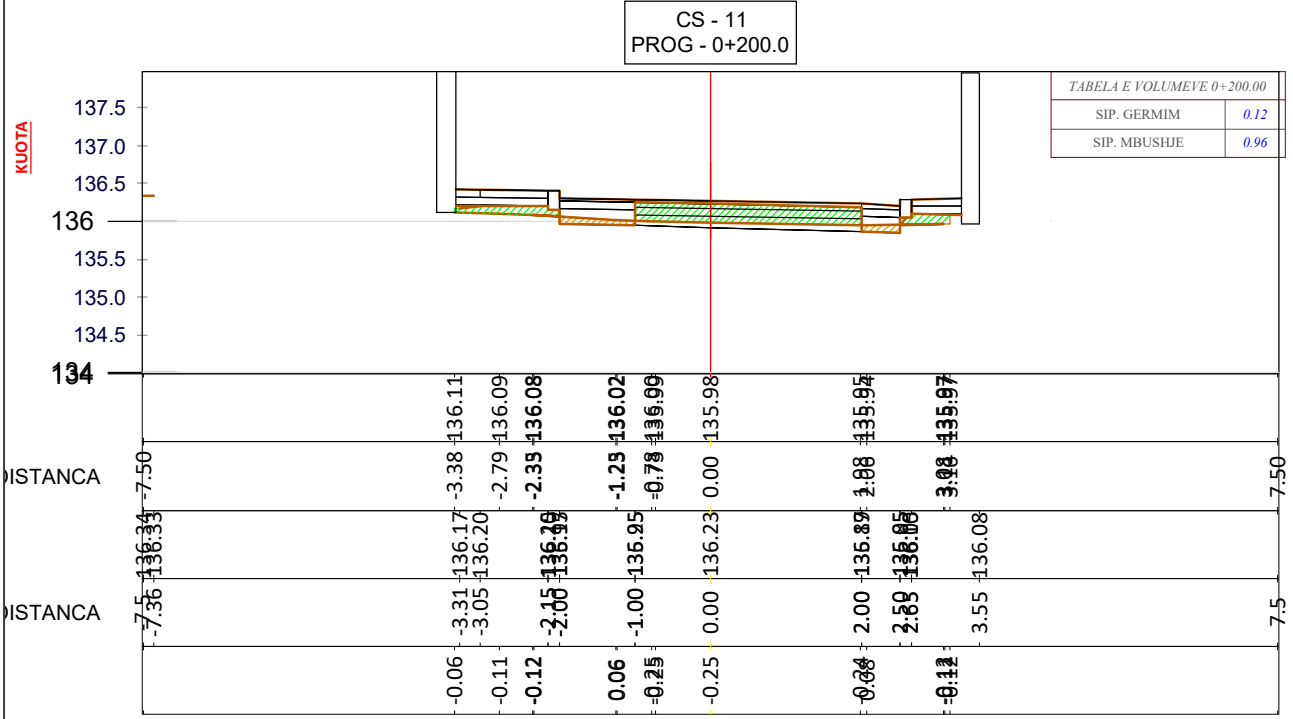
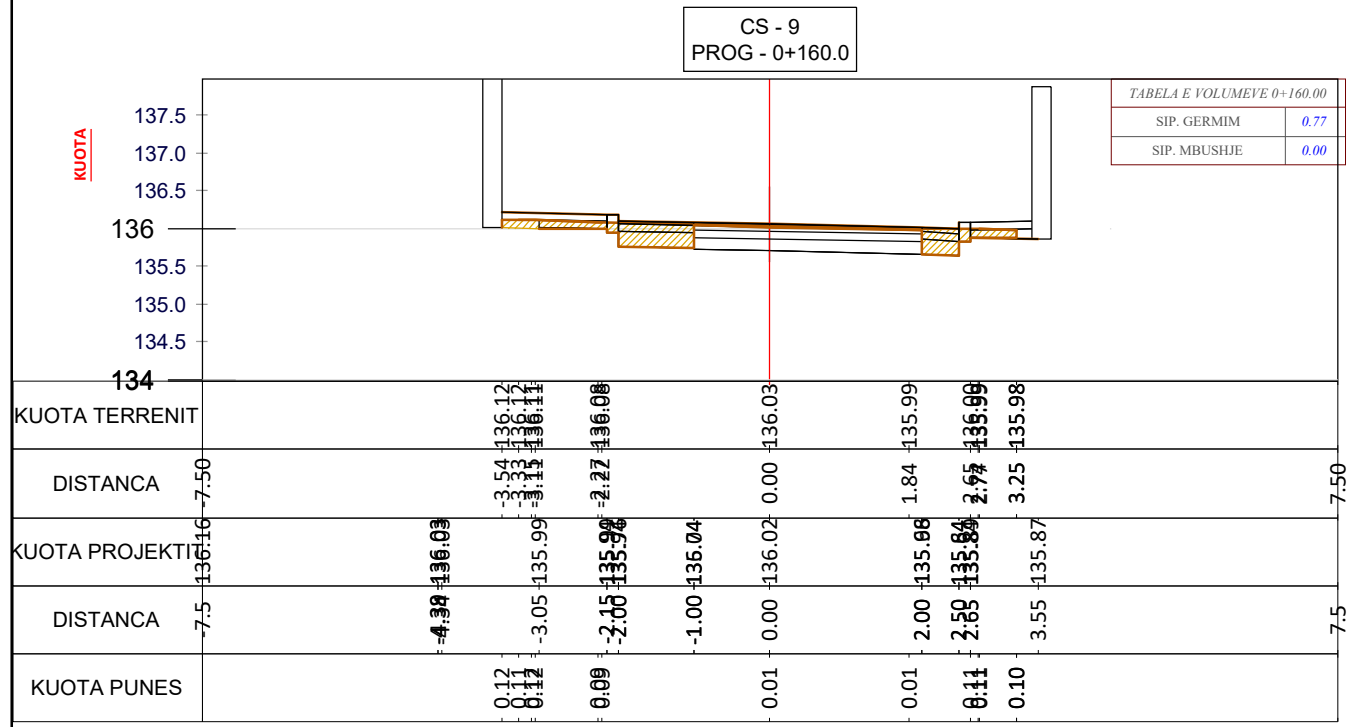

Porositës:
**BASHKIA MALËSI
E MADHE**

Titulli i Projektit
**SISTEMIM ASFALTIM RRUGA GJURAJ
KOPLIK I SIPËRM**

Faza
PROJEKT ZBATIMI

Vula
Autor
**"NOVATECH STUDIO "SHPK
ADMIN ING. EMIL NOVA**

Grupi projektimit:
ING. NDERTIMI MIMOZA TOMCO
ARKITEKT GERGA NOVA
ING. HIDROTEKNIK KLUDJAN NDOJ
ING. HIDROTEKNIK KOSTANDIN NOVA
ING. GJEOLOGJIK ANTONELA BAZHDARI
ING. NDERTIMI PETRIKA DOKU

Kapitulli
PROJEKT ARKITEKTONIK

Titulli i Vizatimit
PROFILA TERTHORE

Realizuar **DHJETOR 2022** Shkalla **1:40**

Emërtimi i Fletës
A 1 - 22

PROFILA TERTHORE

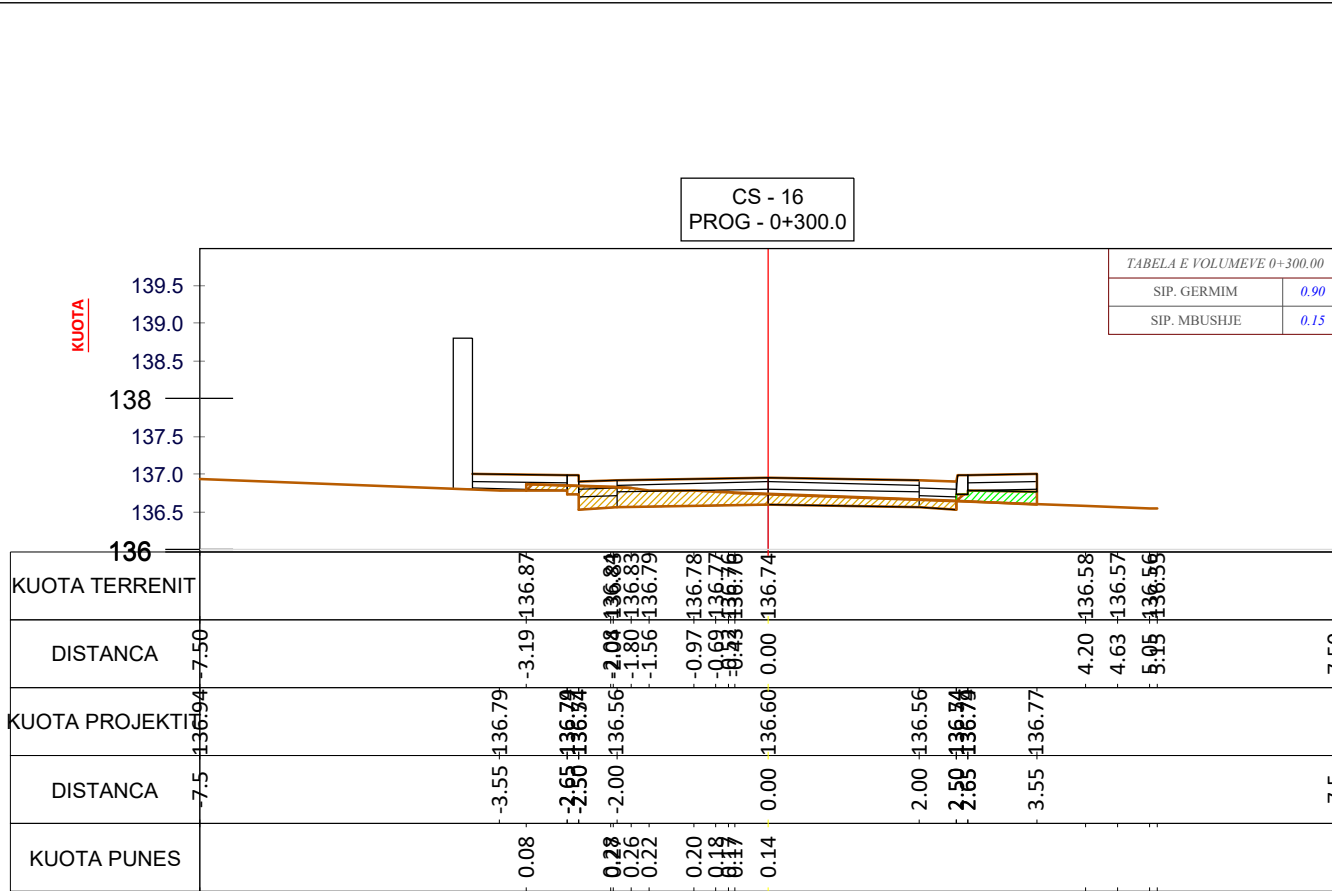
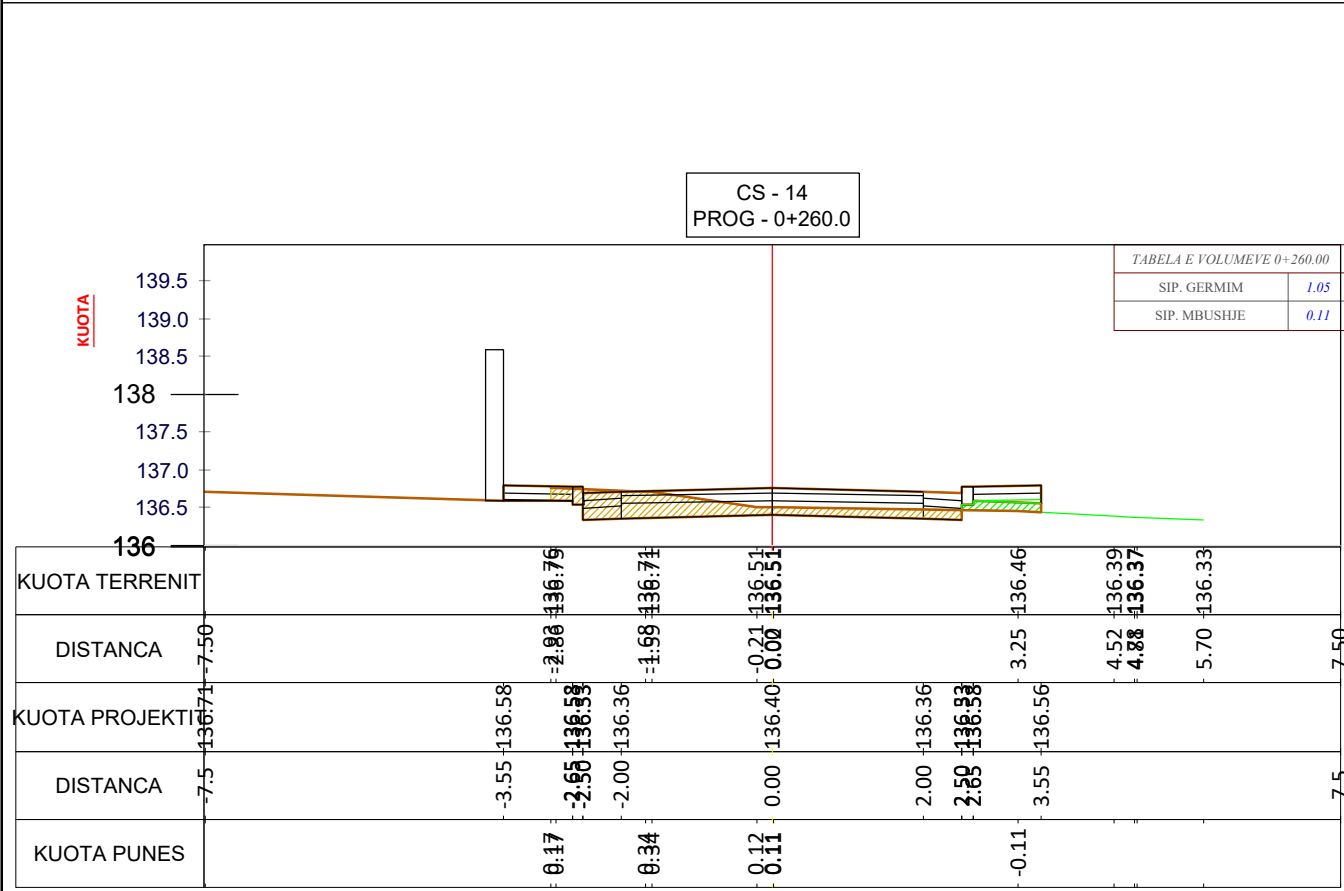
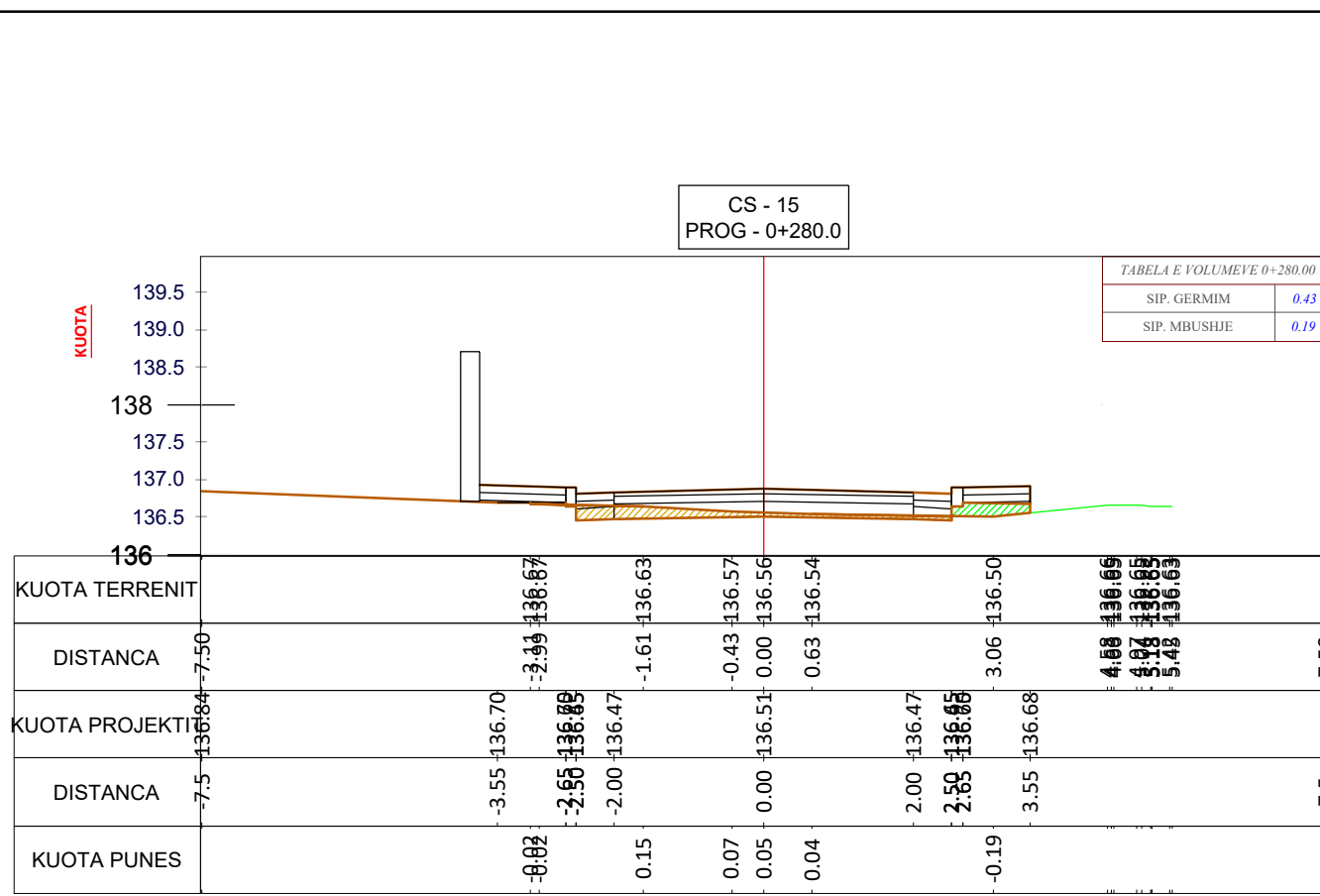
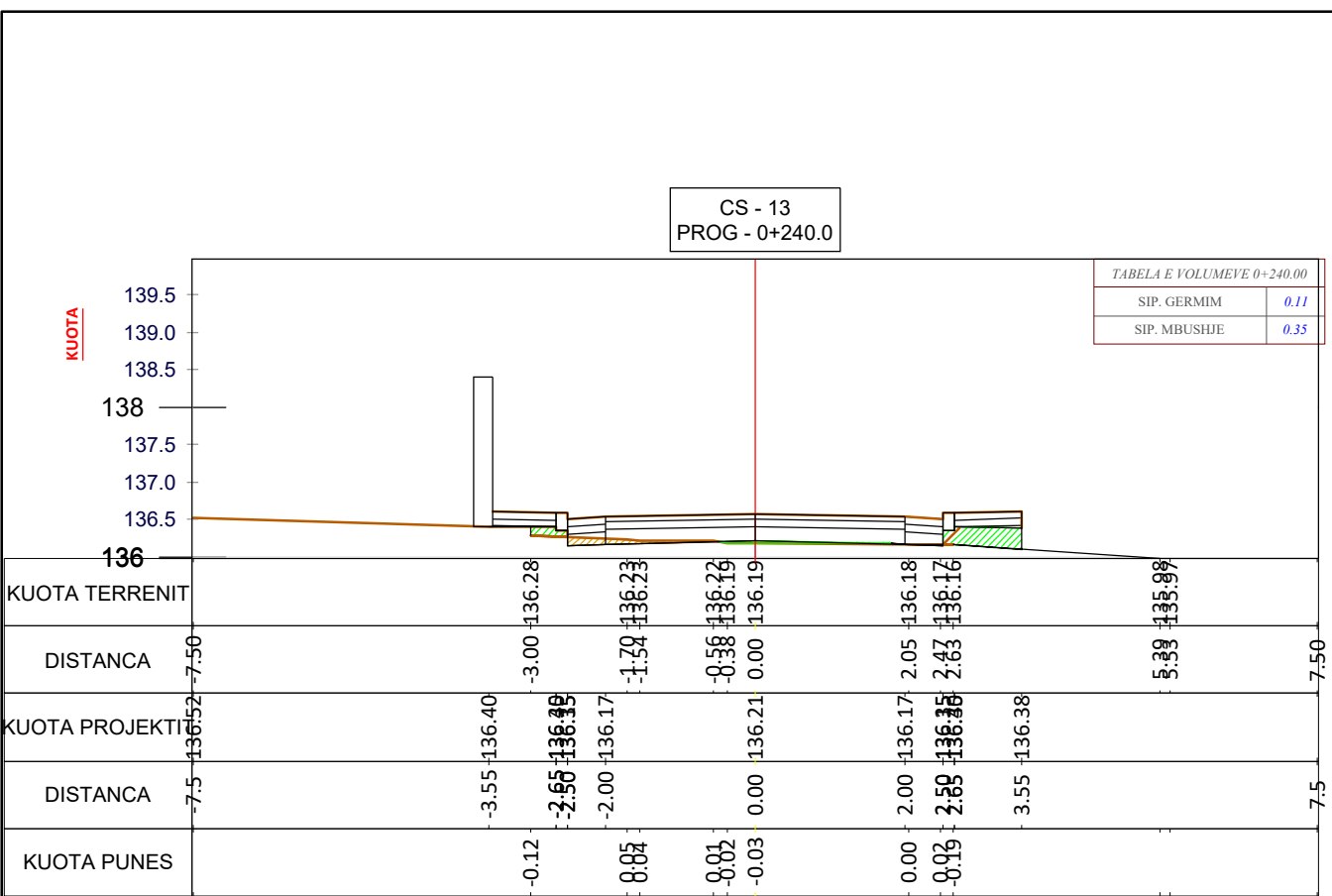

Porositës:
**BASHKIA MALËSI
E MADHE**

Titulli i Projektit
**SISTEMIM ASFALTIM RRUGA GJURAJ
KOPLIK I SIPËRM**

Faza
PROJEKT ZBATIMI

Vula
Autor
"NOVATECH STUDIO" SHPK
ADMIN ING. EMIL NOVA

Grupi projektimit:
ING. NDERTIMI MIMOZA TOMCO
ARKITEKT GERGA NOVA
ING. HIDROTEKNIK KLODJAN NDOJ
ING. HIDROTEKNIK KOSTANDIN NOVA
ING. GJEOLGJIK ANTONELA BAZHDARI
ING. NDERTIMI PETRIKA DOKU

Kapitulli
PROJEKT ARKITEKTONIK

Titulli i Vizatimit
PROFILA TERTHORE

Realizuar **DHJETOR 2022** Shkalla **1:40**

Emërtimi i Fletës
A 1 - 23

PROFILA TERTHORE

CS - 17
PROG - 0+320.0

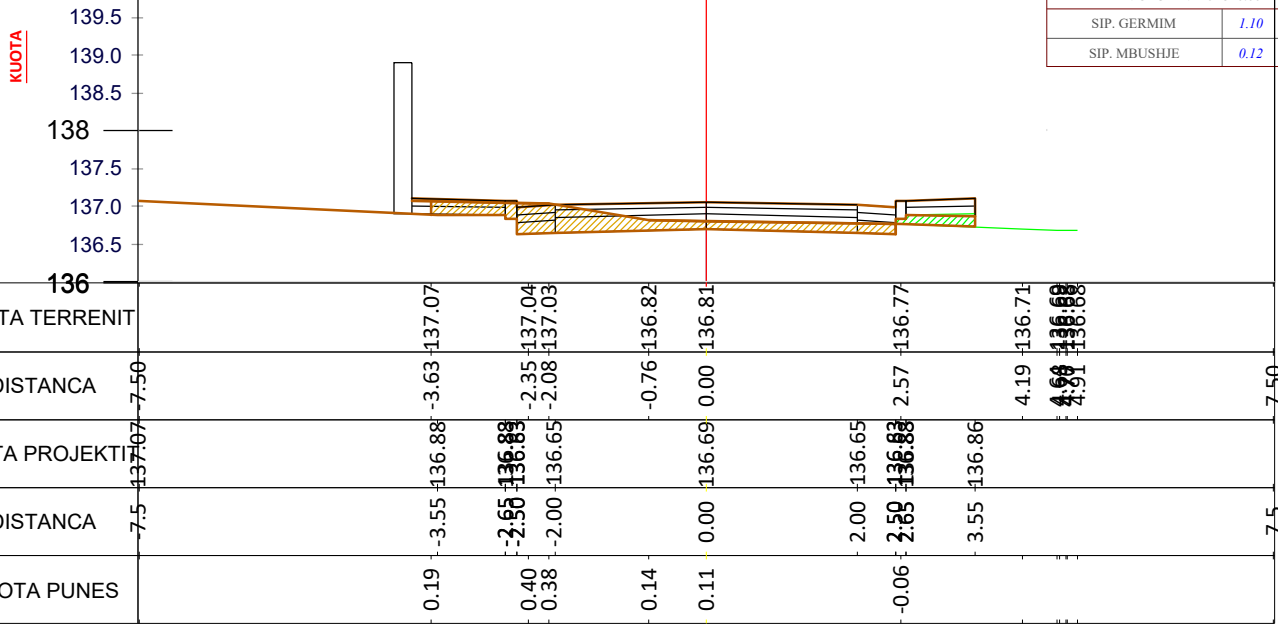

CS - 19
PROG - 0+360.0

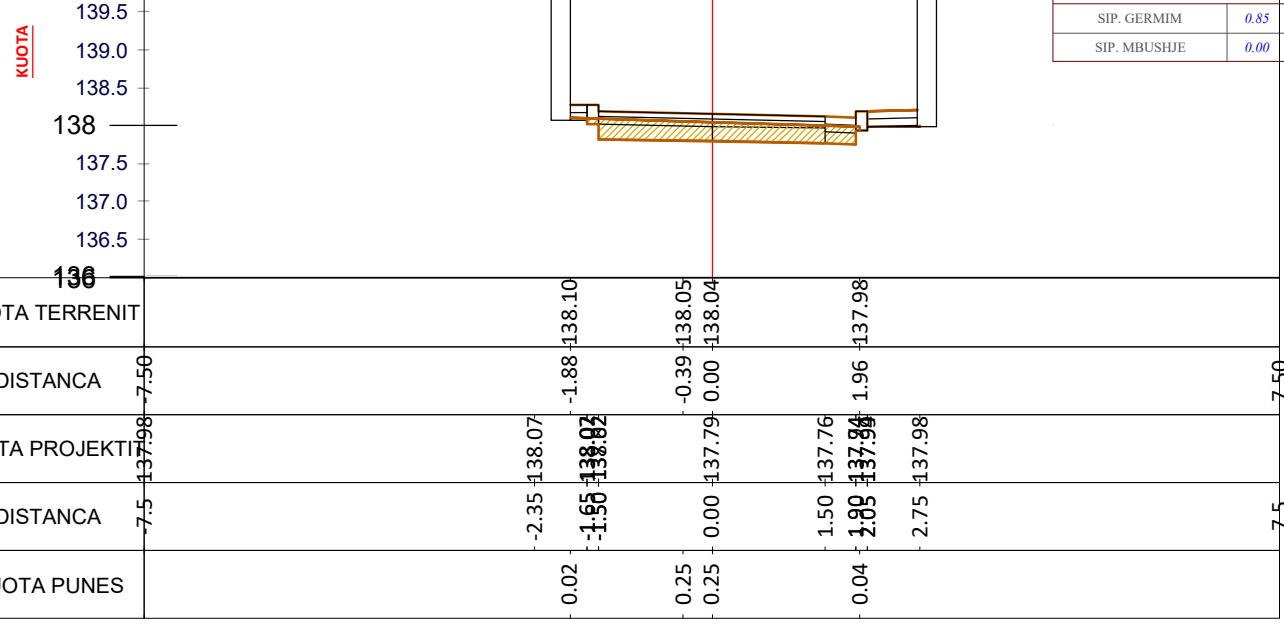

CS - 18
PROG - 0+340.0

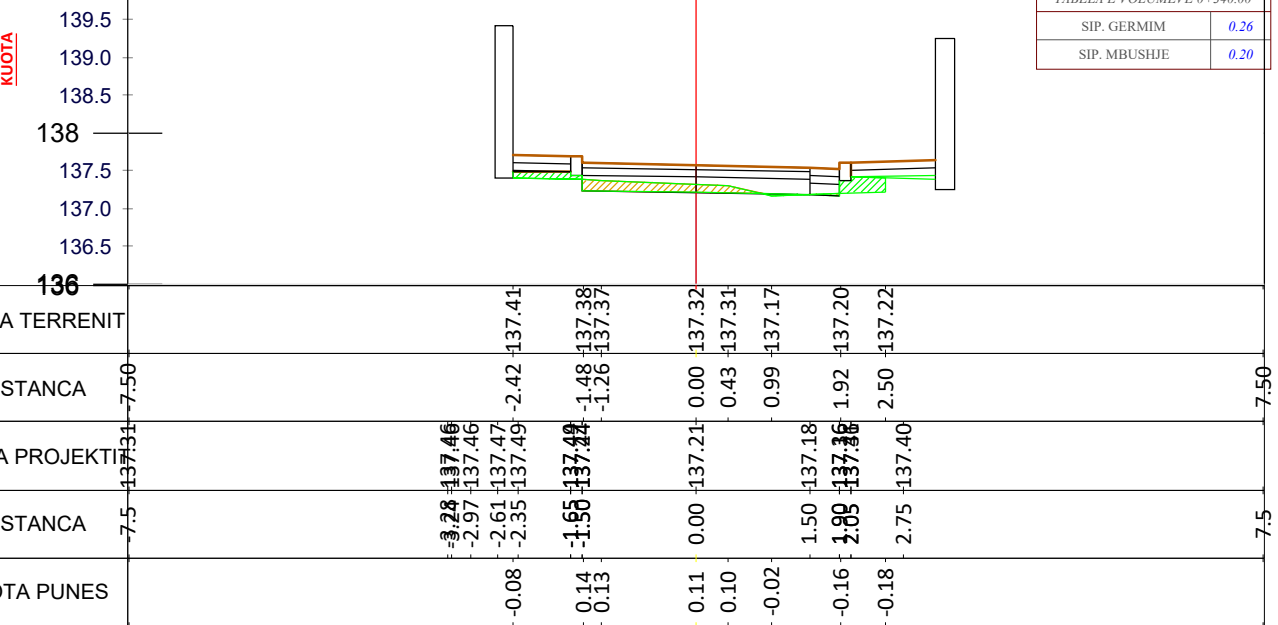

CS - 20
PROG - 0+380.0

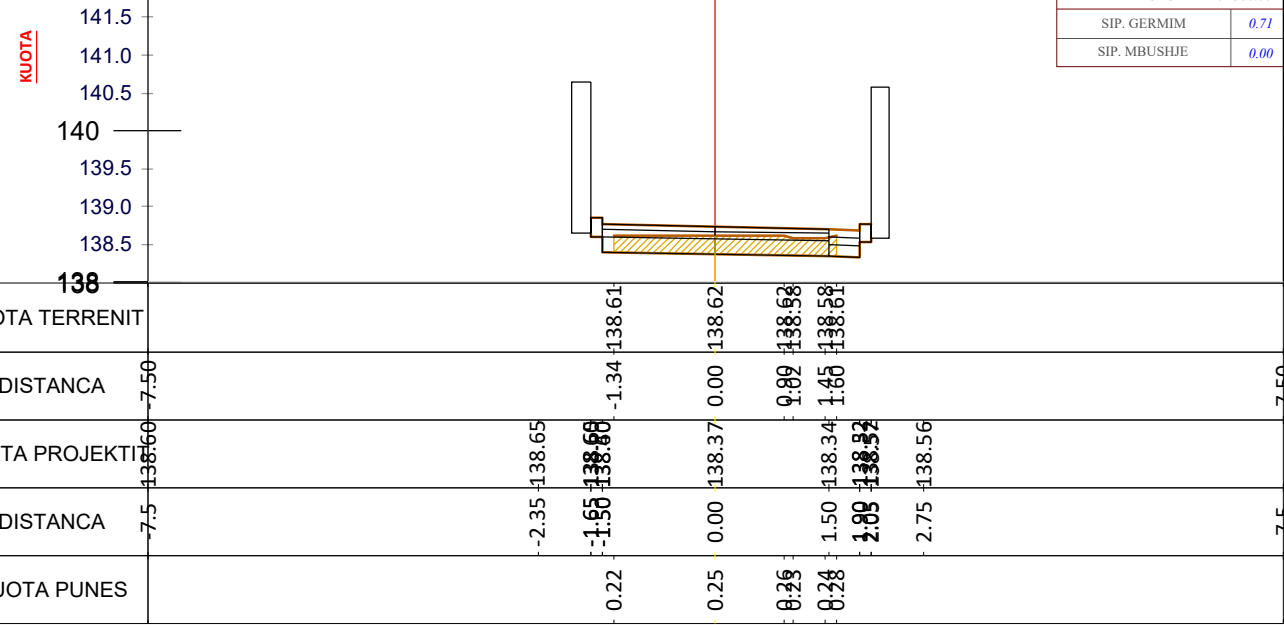

Porositës:
**BASHKIA MALËSI
E MADHE**

Titulli i Projektit
**SISTEMIM ASFALTIM RRUGAJ
KOPLIK I SIPËRM**

Faza
PROJEKT ZBATIMI

Vula
Autor
"NOVATECH STUDIO" SHPK
ADMIN ING. EMIL NOVA

Grupi projektimit:
ING. NDERTIMI MIMOZA TOMCO
ARKITEKT GERGA NOVA
ING. HIDROTEKNIK KLODJAN NDOJ
ING. HIDROTEKNIK KOSTANDIN NOVA
ING. GJEOLLOJIK ANTONELA BAZHDARI
ING. NDERTIMI PETRIKA DOKU

Kapitulli
PROJEKT ARKITEKTONIK

Titulli i Vizatimit
PROFILA TERTHORE

Realizuar **DHJETOR 2022** Shkalla **1:40**

Emërtimi i Fletës
A 1 - 24

PROFILA TERTHORE

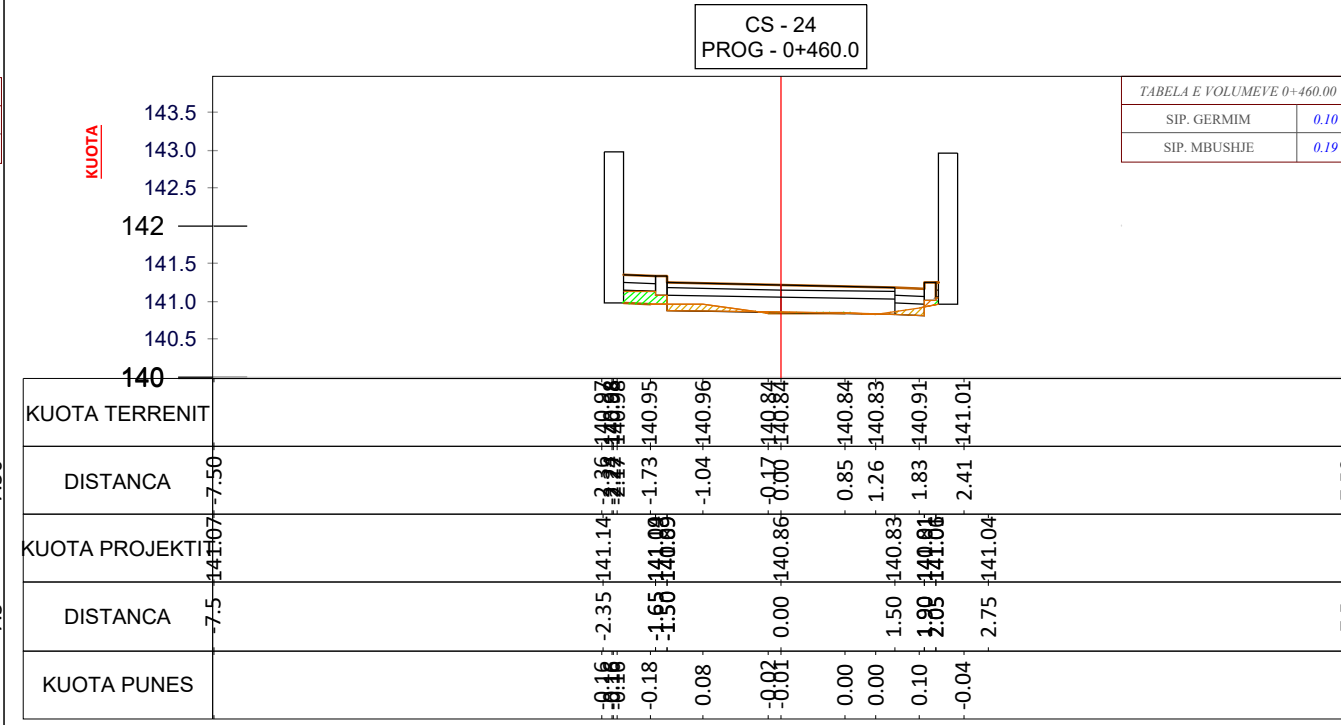
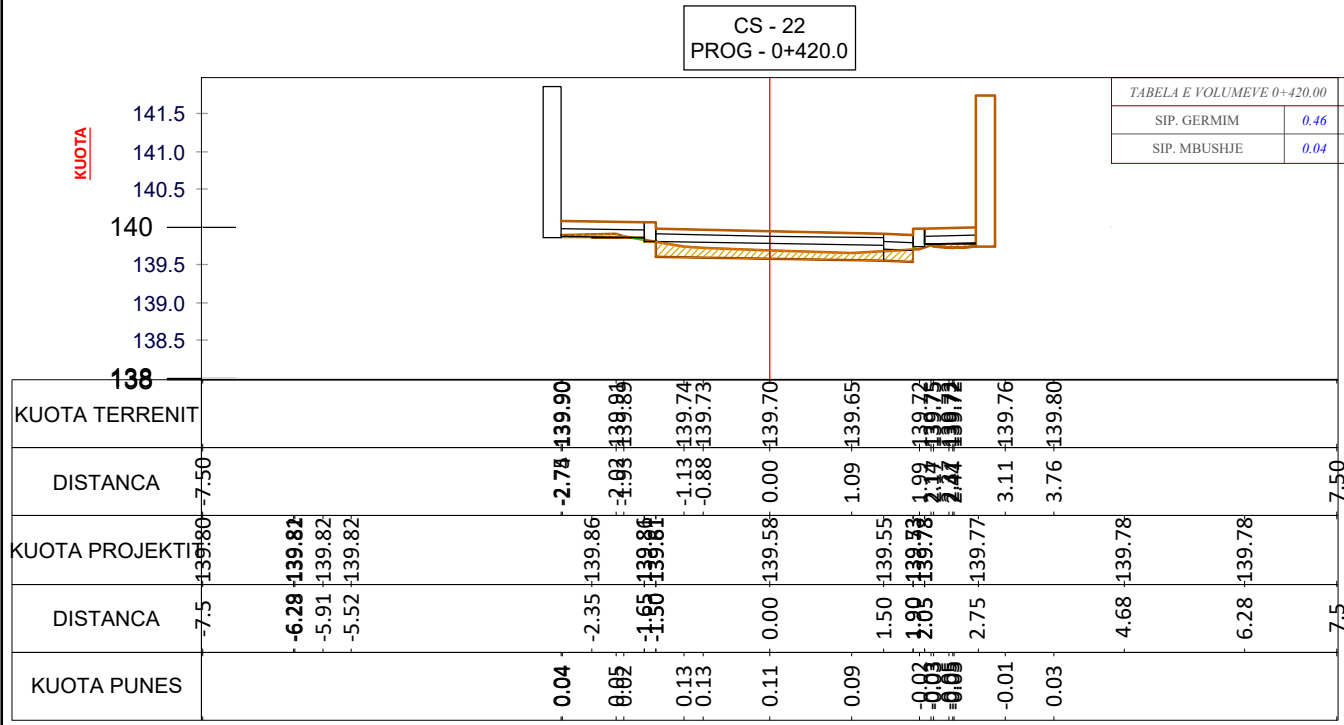
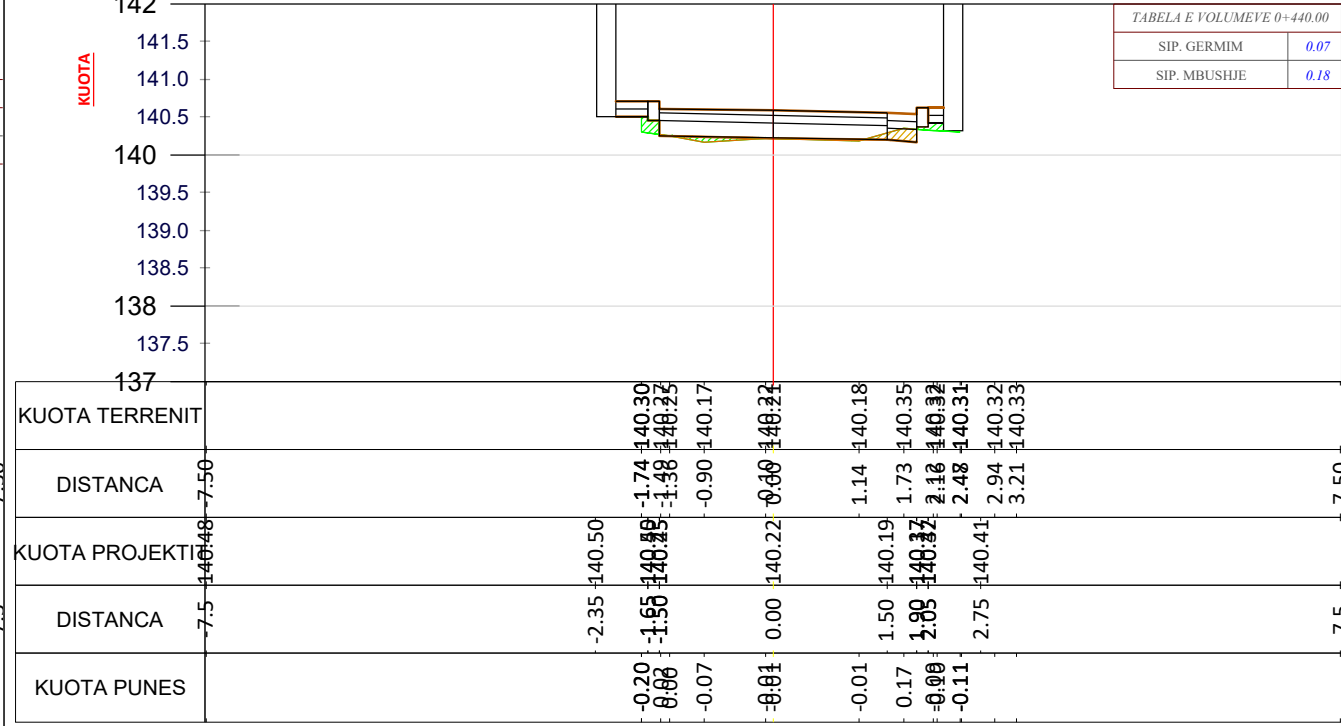
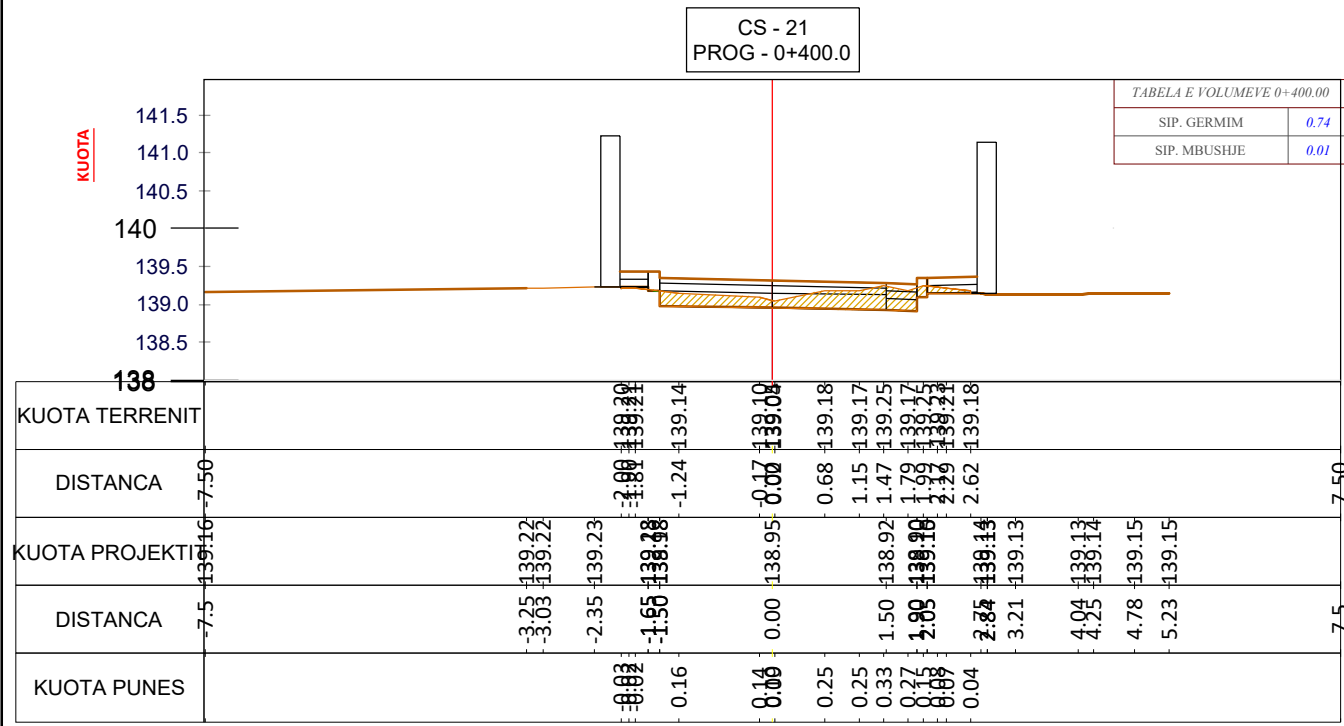

Porositës:
**BASHKIA MALËSI
E MADHE**

Titulli i Projektit
**SISTEMIM ASFALTIM RRUGAJ
KOPLIK I SIPËRM**

Faza
PROJEKT ZBATIMI

Vula
Autor
**"NOVATECH STUDIO "SHPK
ADMIN ING. EMIL NOVA**

Grupi projektimit:
ING. NDERTIMI MIMOZA TOMCO
ARKITEKT GERTE NOVA
ING. HIDROTEKNIK KLUDJAN NDOJ
ING. HIDROTEKNIK KOSTANDIN NOVA
ING. GJEOLGJIK ANTONELA BAZHDARI
ING. NDERTIMI PETRIKA DOKU

Kapitulli
PROJEKT ARKITEKTONIK

Titulli i Vizatimit
PROFILA TERTHORE

Realizuar **DHJETOR 2022** Shkalla **1:40**

Emërtimi i Fletës
A 1 - 25

PROFILA TERTHORE

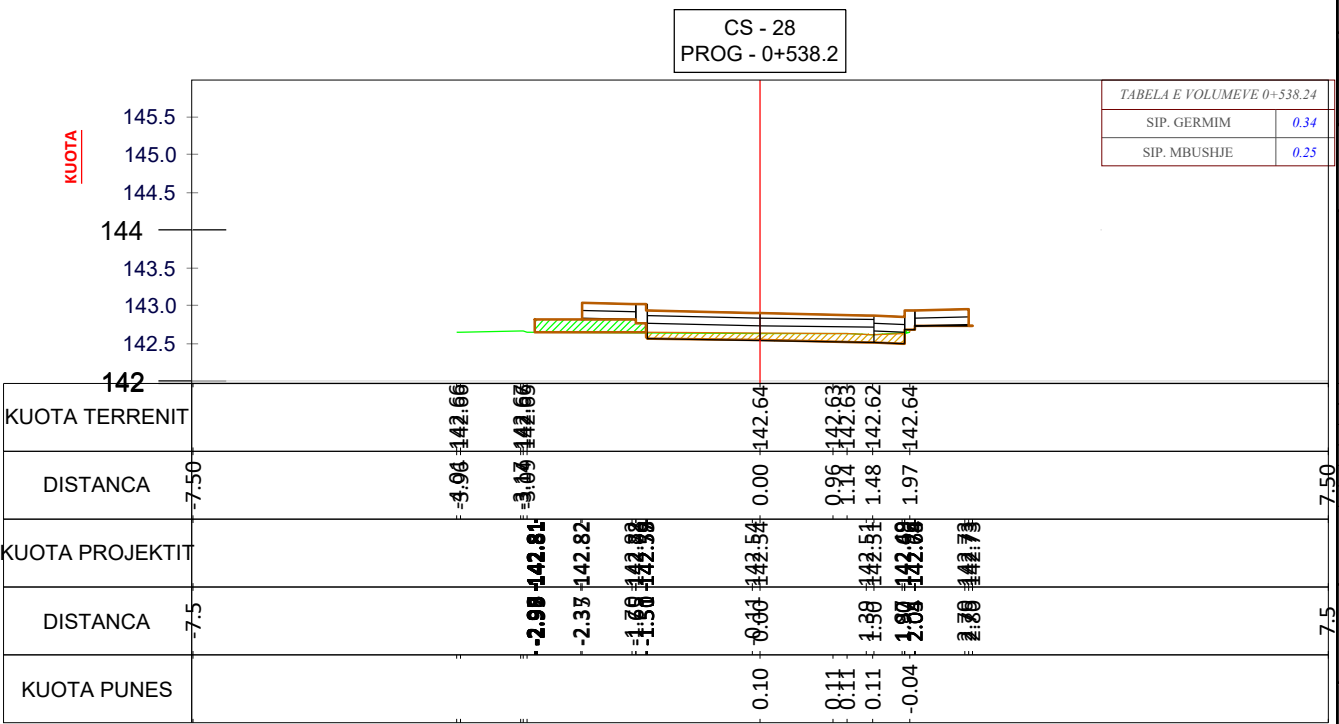
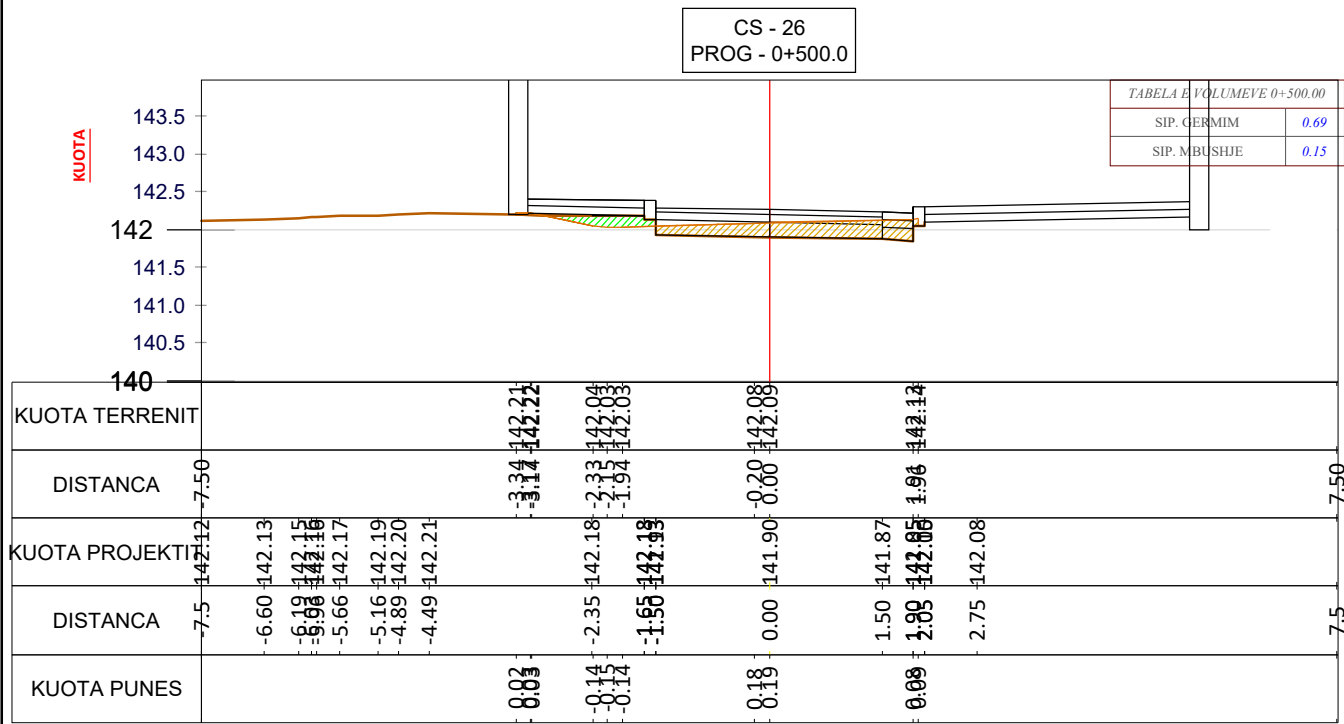
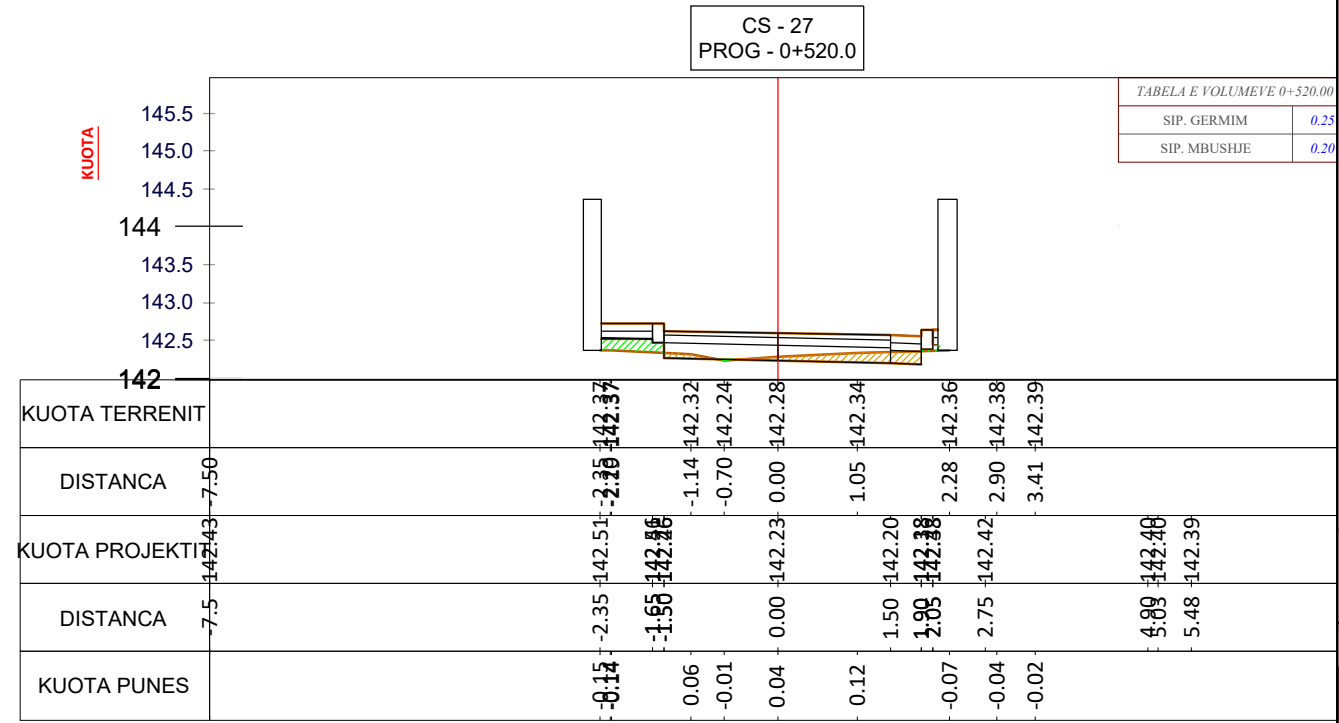
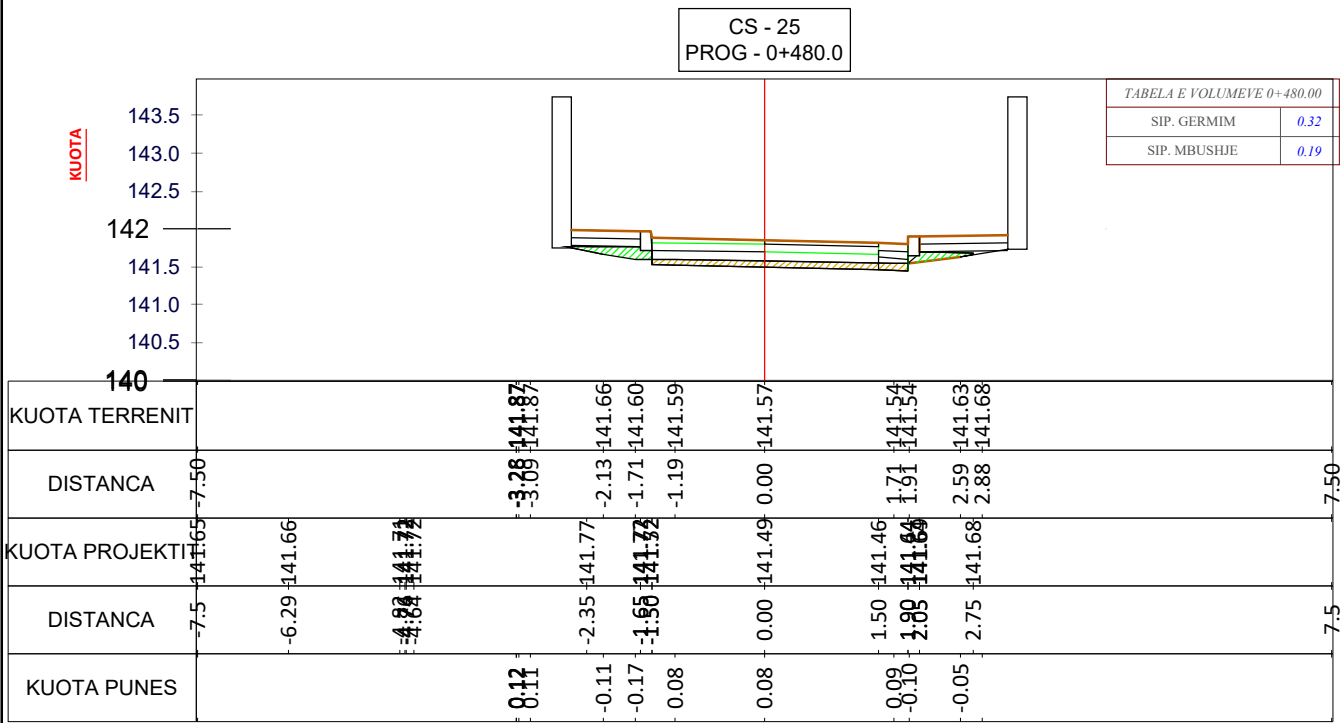

Porositës:
**BASHKIA MALËSI
E MADHE**

Titulli i Projektit
**SISTEMIM ASFALTIM RRUGAJ
KOPLIK I SIPËRM**

Faza
PROJEKT ZBATIMI

Vula
Autor
"NOVATECH STUDIO" SHPK

ADMIN ING. EMIL NOVA

Grupi projektimit:
ING. NDERTIMI MIMOZA TOMCO
ARKITEKT GERGA NOVA
ING. HIDROTEKNIK KLODJAN NDOJ
ING. HIDROTEKNIK KOSTANDIN NOVA
ING. GJEOLGJIK ANTONELA BAZHDARI
ING. NDERTIMI PETRIKA DOKU

Kapitulli
PROJEKT ARKITEKTONIK

Titulli i Vizatimit
PROFILA TERTHORE

Realizuar **DHJETOR 2022** Shkalla **1:40**

Emërtimi i Fletës
A 1 - 26

PROFILA TERTHORE

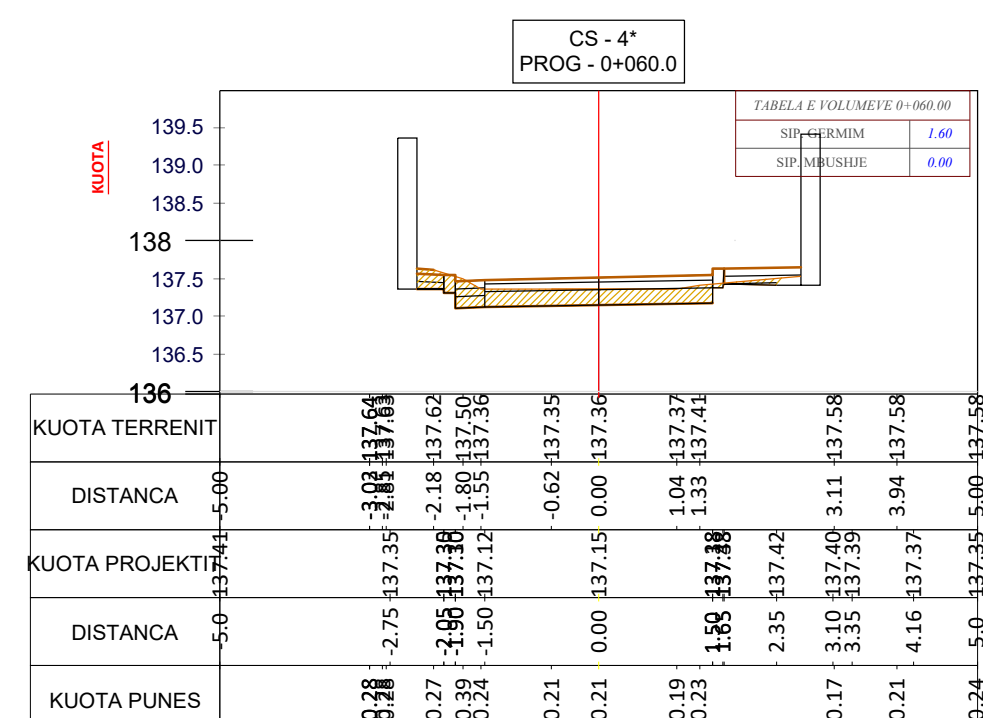
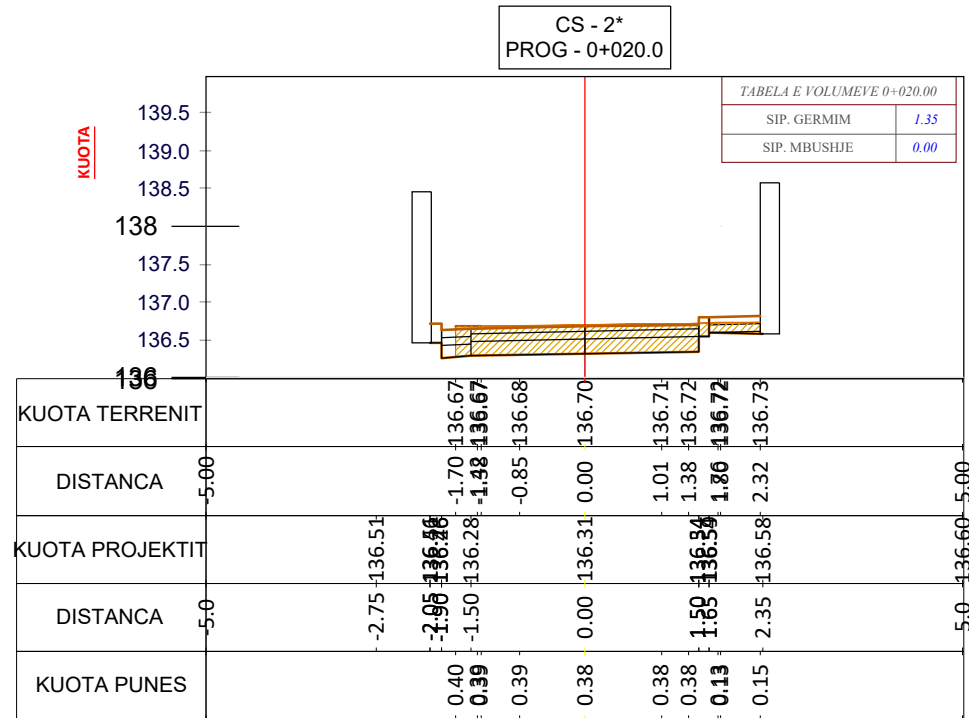
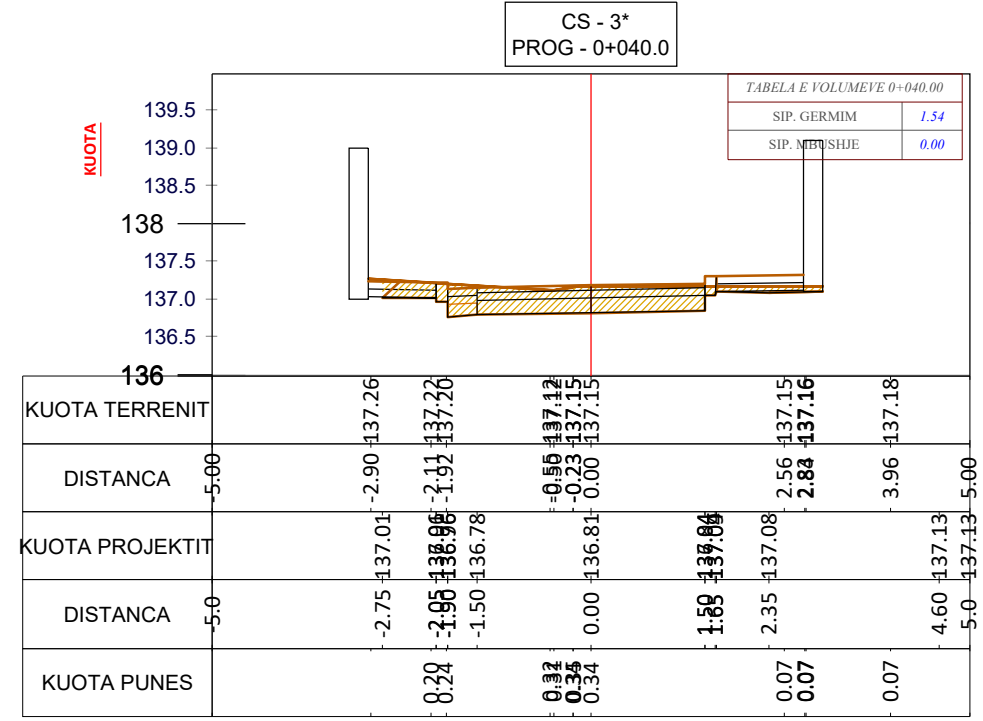
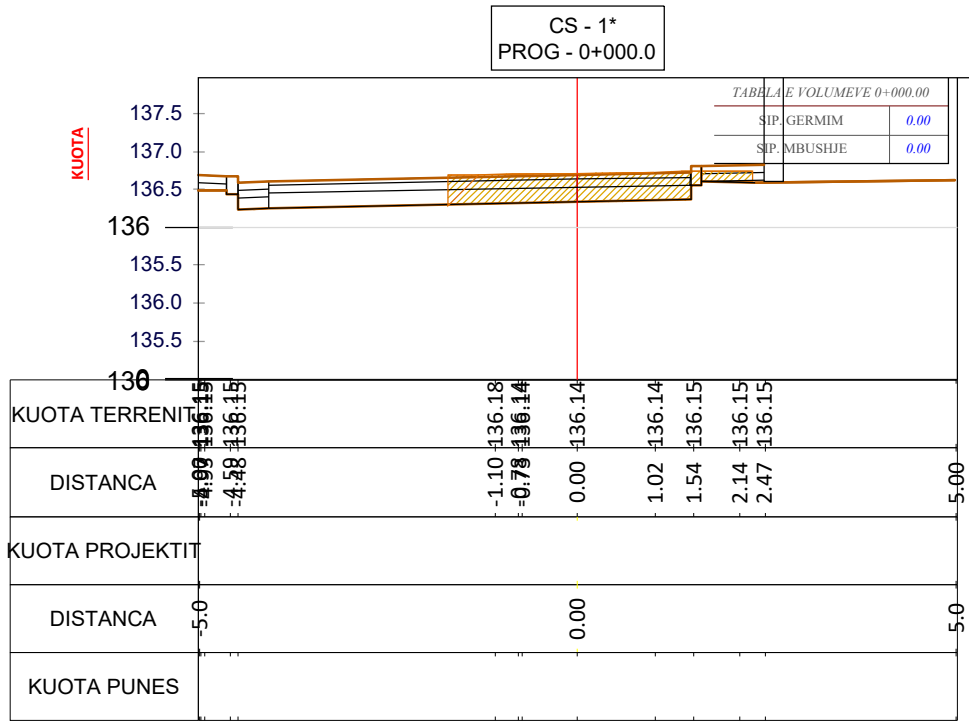

Porositës:

**BASHKIA MALËSI
E MADHE**

Titulli i Projektit
**SISTEMIM ASFALTIM RRUGA GJURAJ
KOPLIK I SIPËRM**

Faza
PROJEKT ZBATIMI

Vula
Autor
"NOVATECH STUDIO" SHPK
ADMIN ING. EMIL NOVA

Grupi projektimit:

ING. NDERTIMI	Mimoza TOMCO
ARKITEKT	Gerda NOVA
ING. HIDROTEKNIK	Klodjan NDOJ
ING. HIDROTEKNIK	Kostandin NOVA
ING. GJEOLGJIK	Antonela BAZHDARI
ING. NDERTIMI	Petrika DOKU

Kapitulli
PROJEKT ARKITEKTONIK

Titulli i Vizatimit
PROFILA TERTHORE

Realizuar
DHJETOR 2022 Shkalla **1:40**

Emërtimi i Fletës
A 1 - 27

PROFILA TERTHORE

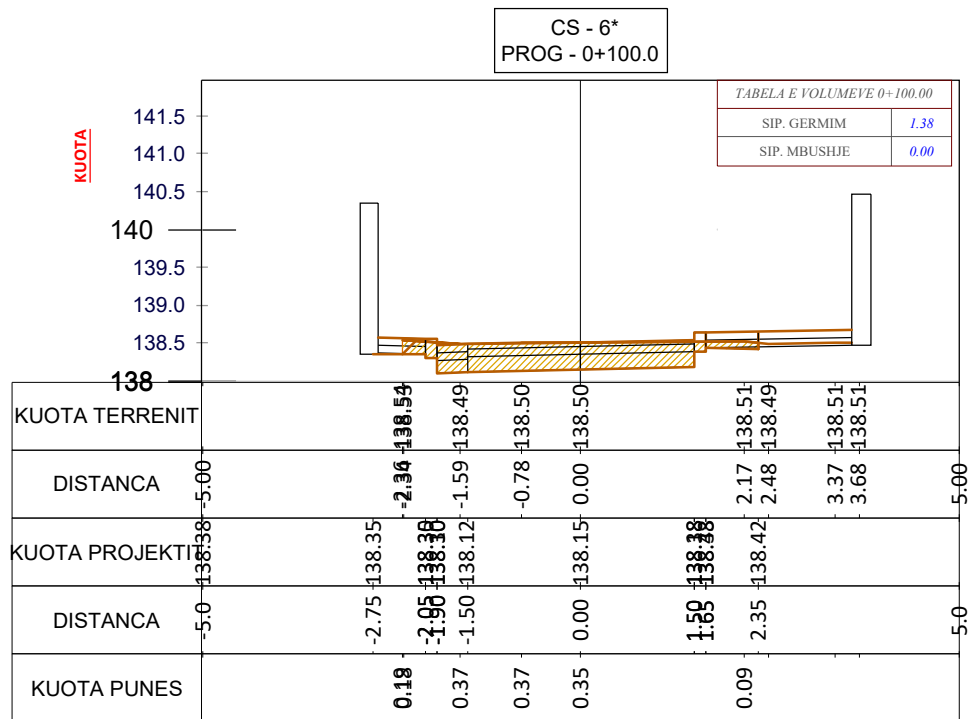
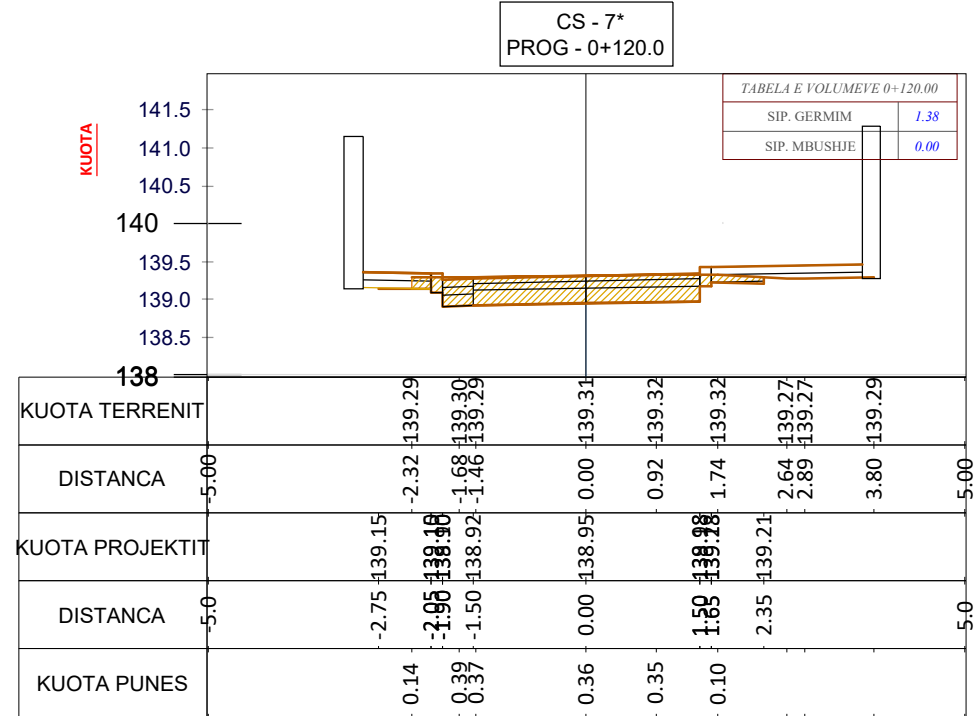
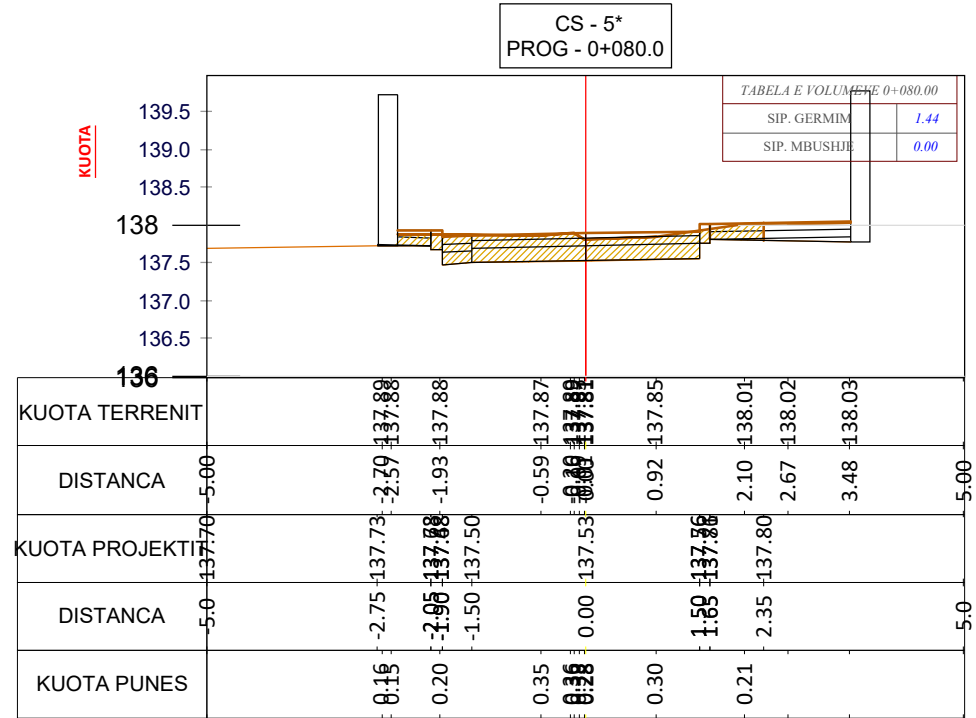

Porosités:

**BASHKIA MALËSI
E MADHE**

Titulli i Projektit

**SISTEMIM ASFALTIM RRUGAJ
KOPLIK I SIPËRM**

Faza

PROJEKT ZBATIMI

Vula

Autor

"NOVATECH STUDIO "SHPK

ADMIN ING. EMIL NOVA

Grupi projektimit:

ING. NDERTIMI	Mimoza TOMCO
ARKITEKT	Gerda NOVA
ING. HIDROTEKNIK	Klodjan NDOJ
ING. HIDROTEKNIK	Kostandin NOVA
ING. GJEOLGJIK	Antonela BAZHDARI
ING. NDERTIMI	Petrika DOKU

Vula

Kapitulli

PROJEKT ARKITEKTONIK

Titulli i Vizatimit

PROFILA TERTHORE

Realizuar	DHJETOR 2022	Shkalla	1:40
-----------	---------------------	---------	-------------

Emërtimi i Fletës

A 1 - 28

PROFILA TERTHORE

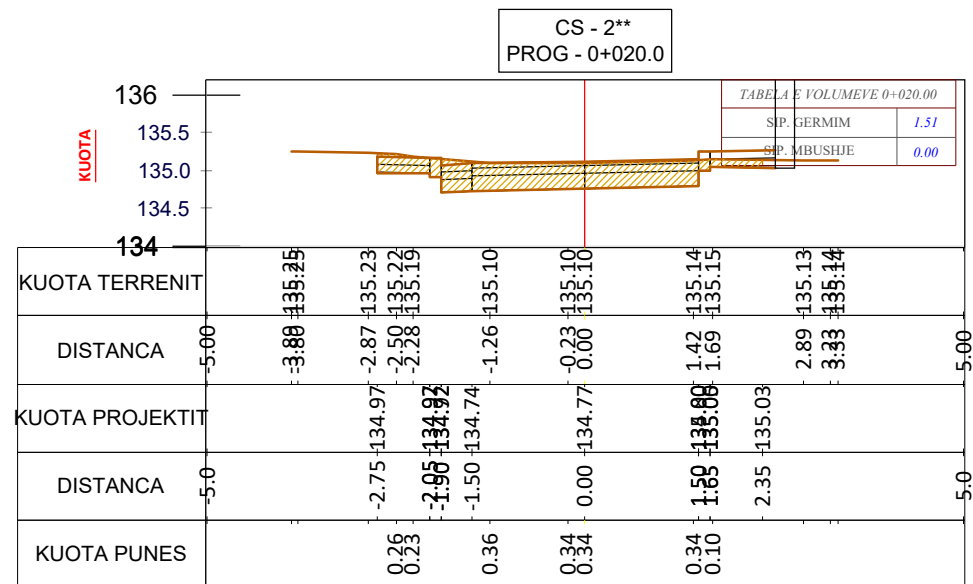
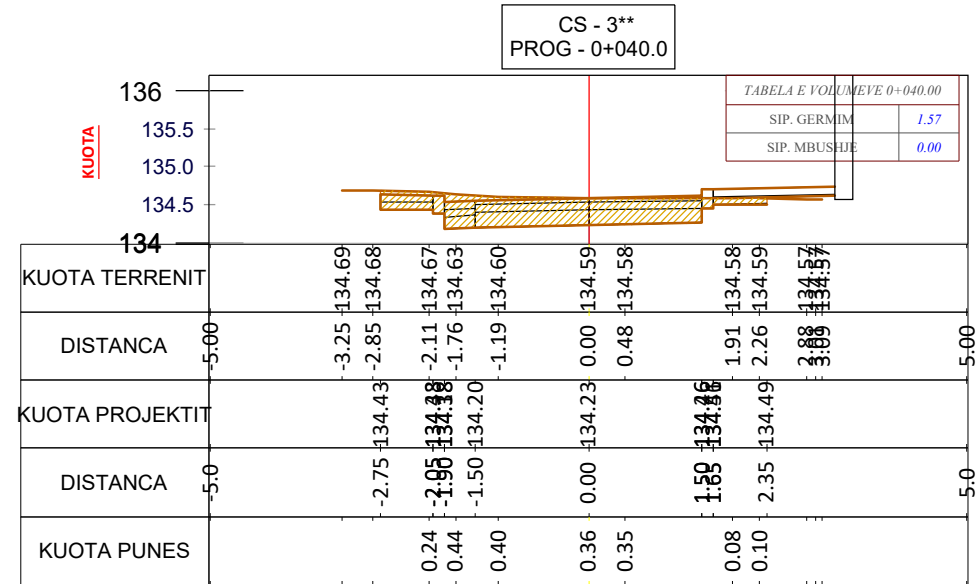
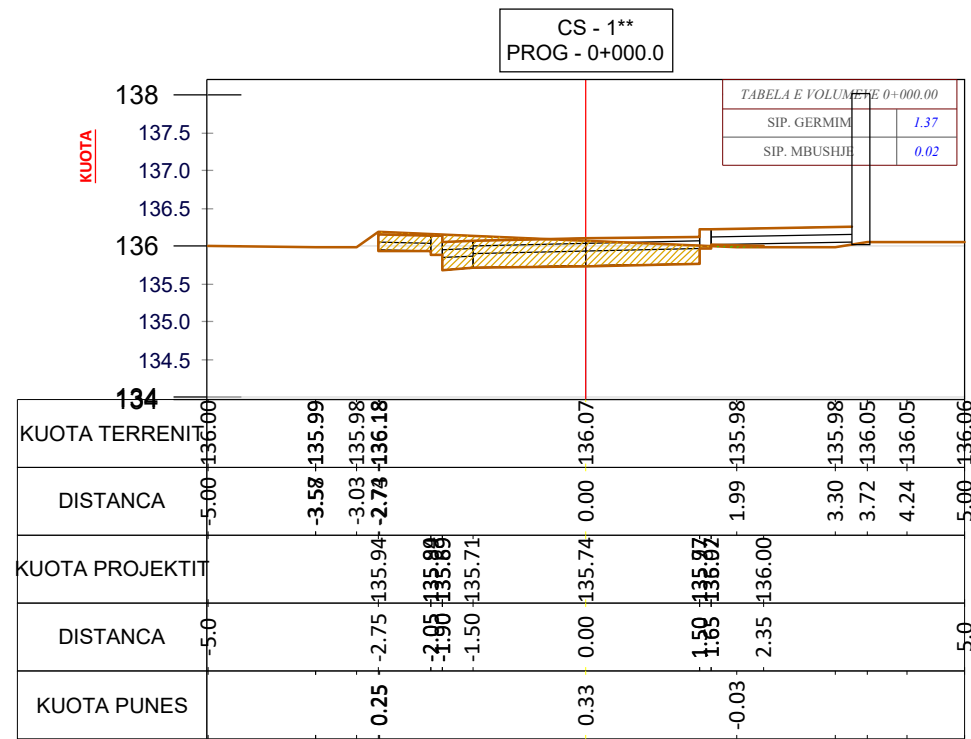

Porositës:

**BASHKIA MALËSI
E MADHE**

Titulli i Projektit

**SISTEMIM ASFALTIM RRUGAJ
KOPLIK I SIPËRM**

Faza

PROJEKT ZBATIMI

Vula

Autor "NOVATECH STUDIO "SHPK

ADMIN ING. EMIL NOVA

Grupi projektimit:

ING. NDERTIMI	Mimoza TOMCO
ARKITEKT	Gerta NOVA
ING. HIDROTEKNIK	Klodjan NDOJ
ING. HIDROTEKNIK	Kostandin NOVA
ING. GJEOLGJIK	Antonela BAZHDARI
ING. NDERTIMI	Petrika DOKU

Vula

Kapitulli

PROJEKT ARKITEKTONIK

Titulli i Vizatimit

PROFILA TERTHORE

Realizuar	DHJETOR 2022	Shkalla	1:40
-----------	---------------------	---------	-------------

Emërtimi i Fletës

A 1 - 29

DETAJ I ZGARES FUNDORE AKSI 03 SH 1:40

PLAN

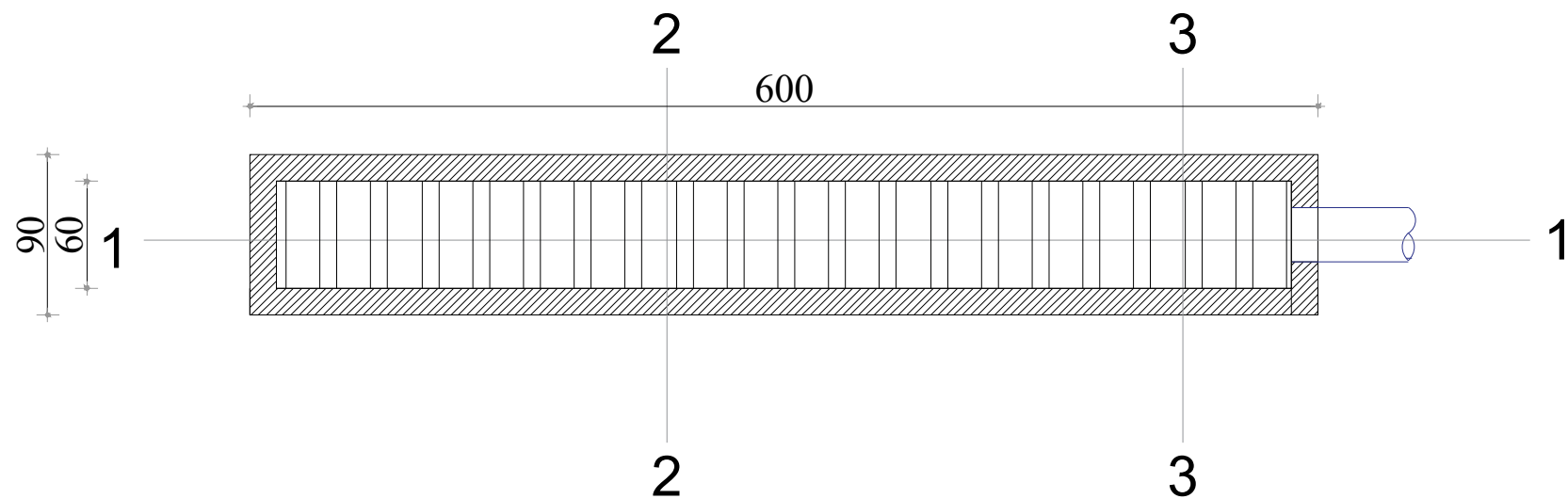

PRERJE 1-1

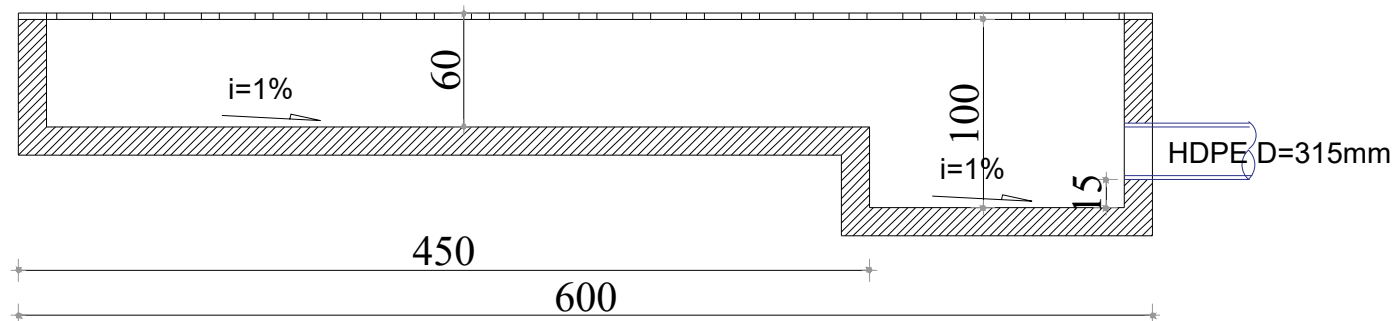

PRERJE 2-2

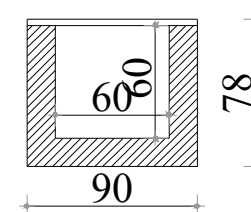

PRERJE 3-3

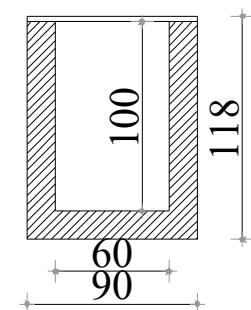

Porositës:

**BASHKIA MALËSI
E MADHE**

Titulli i Projektit

**SISTEMIM ASFALTIM RRUGA GJURAJ
KOPLIK I SIPËRM**

Faza

PROJEKT ZBATIMI

Vula

Autor

"NOVATECH STUDIO "SHPK

ADMIN ING. EMIL NOVA

Grupi projektimit:

ING. NDERTIMI	Mimoza TOMCO
ARKITEKT	Gerta NOVA
ING. HIDROTEKNIK	Klodjan NDOJ
ING. HIDROTEKNIK	Kostandin NOVA
ING. GJEOLGJIK	Antonela BAZHDARI
ING. NDERTIMI	Petrika DOKU

Vula

Kapitulli

PROJEKT ARKITEKTONIK

Titulli i Vizatimit

DETAJ ZGARA

Realizuar **DHJETOR 2022** Shkalla **1:40**

Emërtimi i Fletës

A 1 - 30