

06-PROFILA TËRTHORË

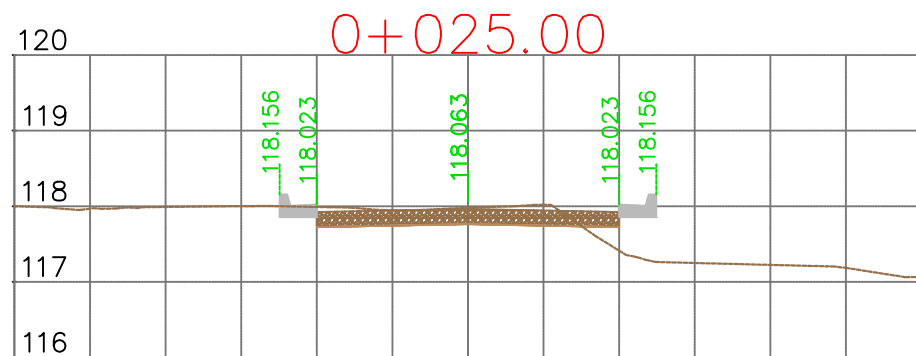
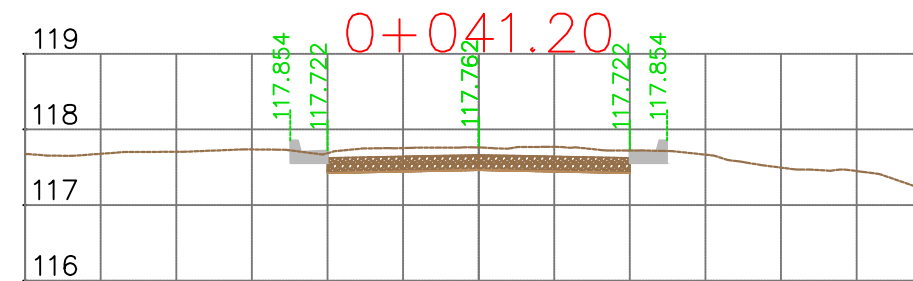
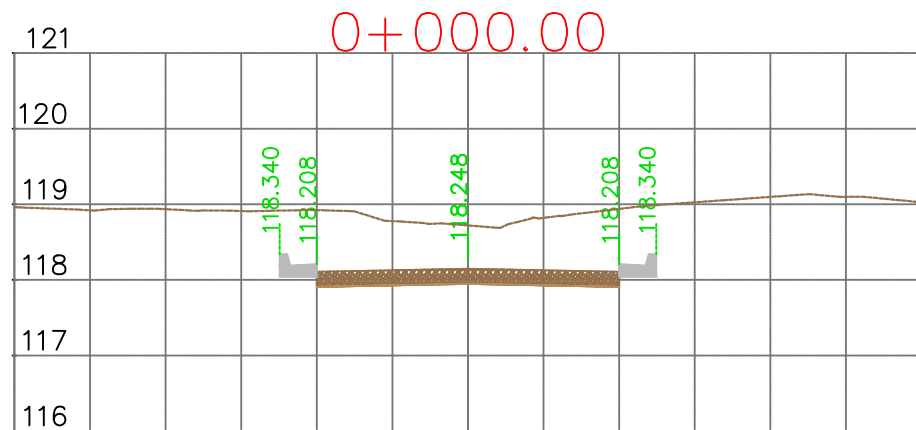

REPUBLIKA E SHQIPËRISË
BASHKIA E TIRANËS

OBJEKTI: "RIKUALIFIKIMI URBAN I ZONËS
INFORMALE QË KUFIZOHET NGA RRUGËT
-SABAUDIN GABRANI -JONUZ RAMA-HAMDI
CULLHAJ-DAMIAN HIMARIOTI-BARI
ISHKA-VASFI SAMIMI-ALUSH ELMAZ TAKA."

Projektoi :

Ing.A.JAKOVA
Ing.G.ISLAMI
Ing.S.MYRSELI
Ing.P.SHKURTI

Ark.M.DADO
Ing.Gjeol.Xh.KASMI
Ing.Mjedis.E.CALI
Top.A.BECECI

Projektoi :

"S&L STUDIO SH.P.K"

Projektim-kupervizion-cosnulence



FAZA

DORËZIM

PROJEKT ZBATIMI

1.0

PROFILE TËRTHORE
RRUGA RR.ISUF SOKOLI 1

SHKALLA 1:100

Nr. I FLETËS 001

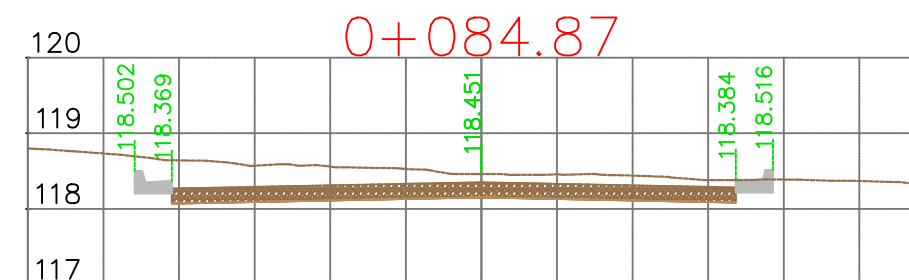
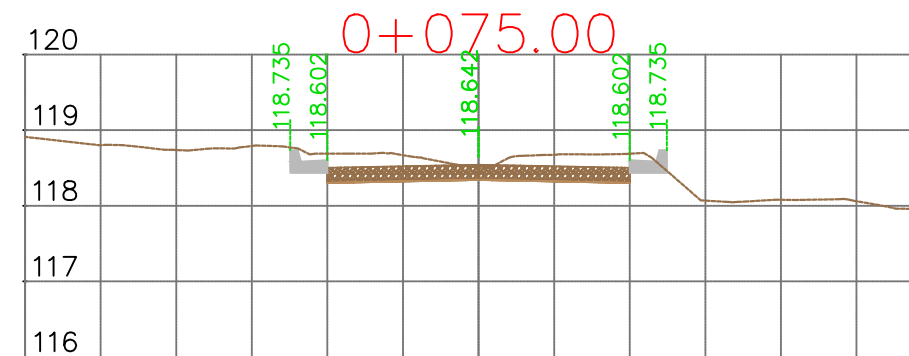
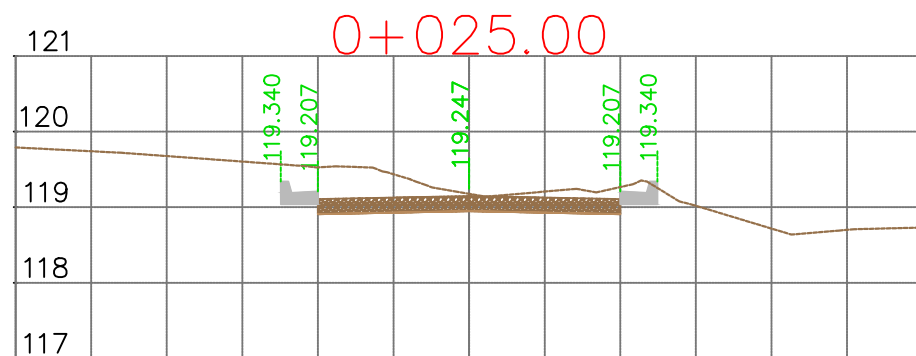
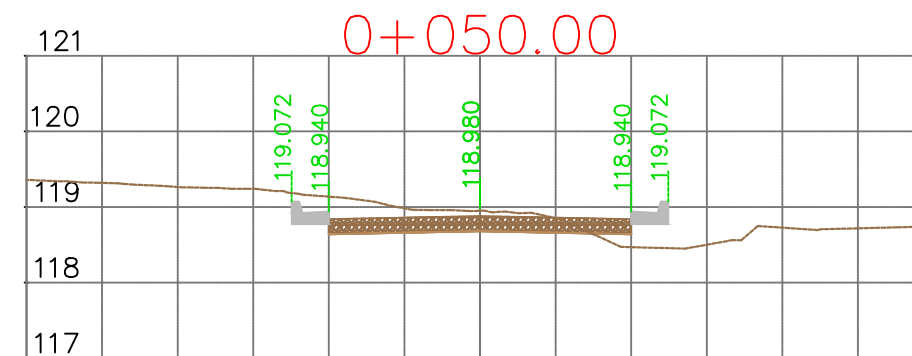
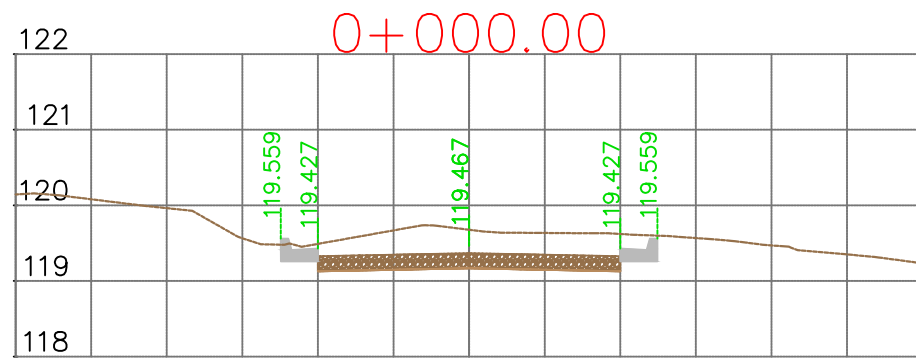

REPUBLIKA E SHQIPËRISË
BASHKIA E TIRANËS

OBJEKTI: "RIKUALIFIKIMI URBAN I ZONËS
INFORMALE QË KUFIZOHET NGA RRUGËT
-SABAUDIN GABRANI -JONUZ RAMA-HAMDI
CULLHAJ-DAMIAN HIMARIOTI-BARI
ISHKA-VASFI SAMIMI-ALUSH ELMAZ TAKA."

Projektoi :

Ing.A.JAKOVA
Ing.G.ISLAMI
Ing.S.MYRSELI
Ing.P.SHKURTI

Ark.M.DADO
Ing.Gjeol.Xh.KASMI
Ing.Mjedis.E.CALI
Top.A.BECECI

Projektoi :

"S&L STUDIO SH.P.K"

Projektim-kupervizion-cosnulence



FAZA

DORËZIM

PROJEKT ZBATIMI

1.0

PROFILE TËRTHORE
RRUGA RR.ISUF SOKOLI 2

SHKALLA 1:100

Nr. I FLETËS 001

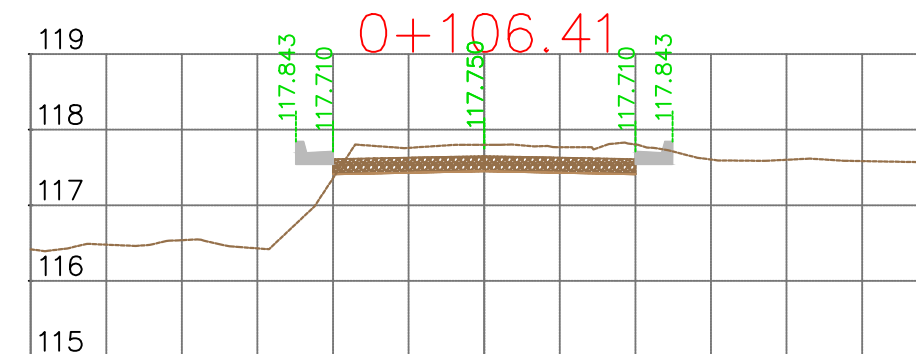
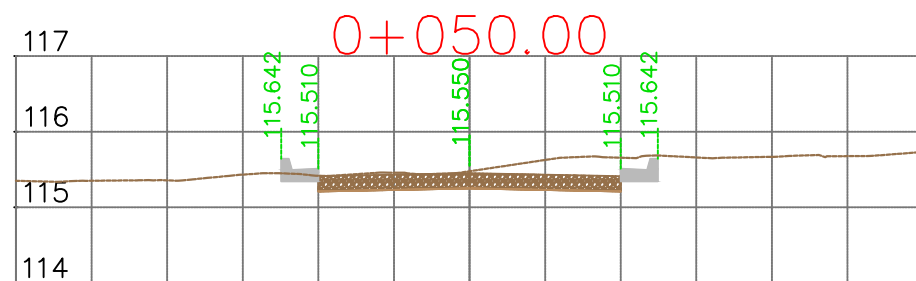
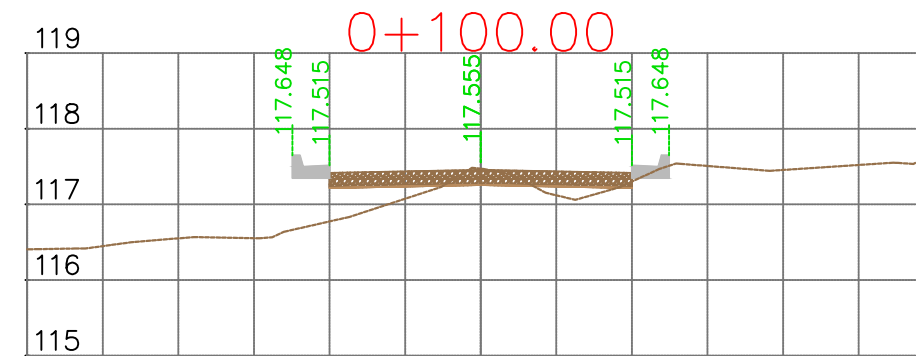
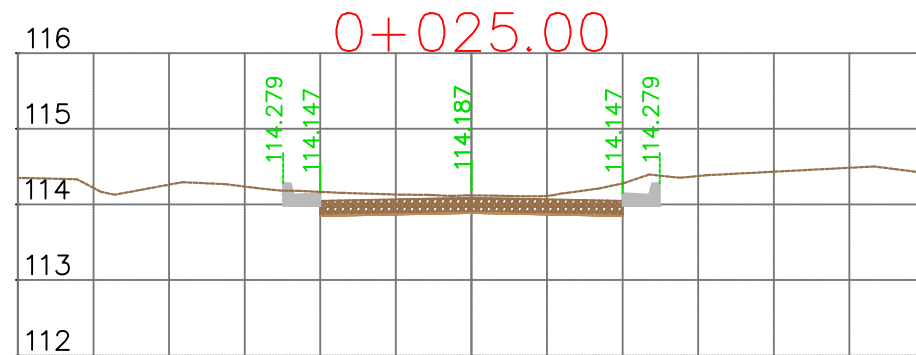
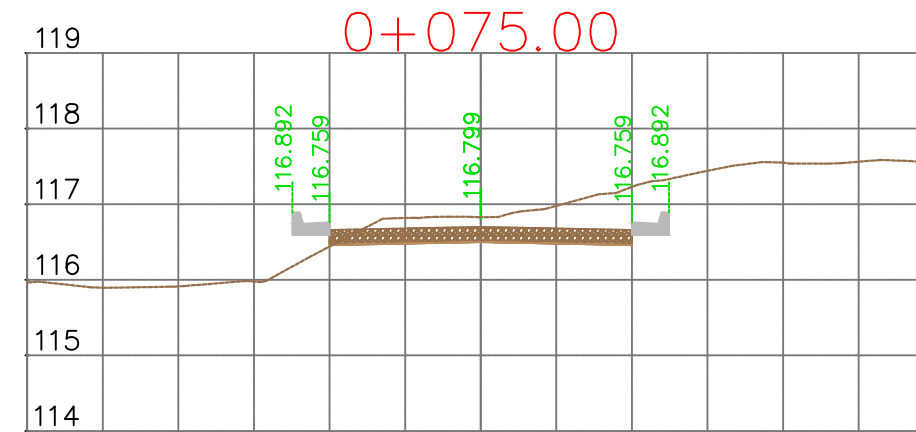
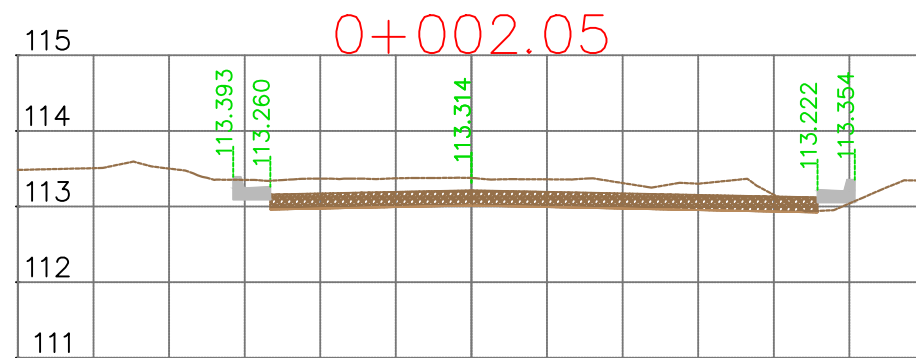

REPUBLIKA E SHQIPËRISË
BASHKIA E TIRANËS

OBJEKTI: "RIKUALIFIKIMI URBAN I ZONËS
INFORMALE QË KUFIZOHET NGA RRUGËT
-SABAUDIN GABRANI -JONUZ RAMA-HAMDI
CULLHAJ-DAMIAN HIMARIOTI-BARI
ISHKA-VASFI SAMIMI-ALUSH ELMAZ TAKA."

Projektoi :

Ing.A.JAKOVA
Ing.G.ISLAMI
Ing.S.MYRSELI
Ing.P.SHKURTI

Ark.M.DADO
Ing.Gjeol.Xh.KASMI
Ing.Mjedis.E.CALI
Top.A.BECECI

Projektoi :

"S&L STUDIO SH.P.K"

Projektim-kupervizion-cosnulence



FAZA

DORËZIM

PROJEKT ZBATIMI

1.0

PROFILE TËRTHORE
RRUGA RR.ILMAZ TAKA 1

SHKALLA 1:100

Nr. I FLETËS 001

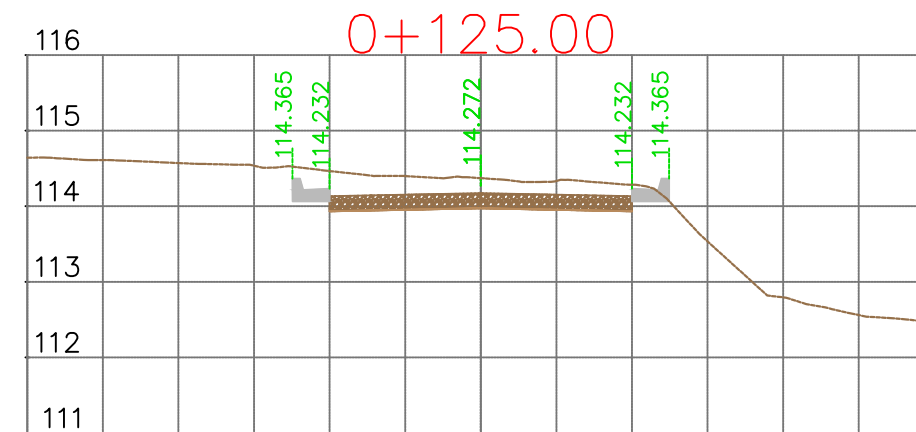
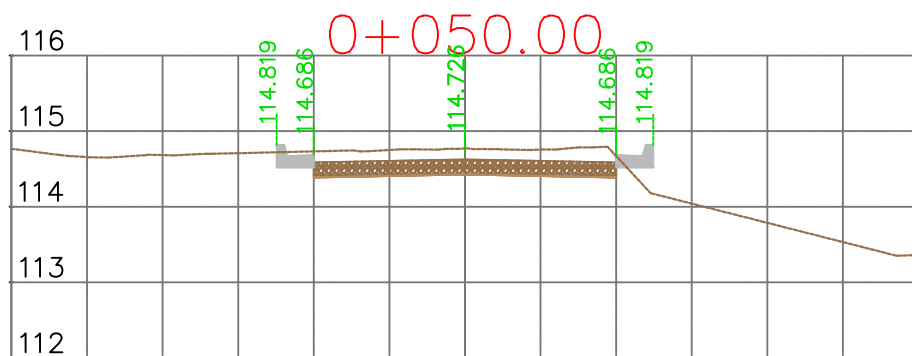
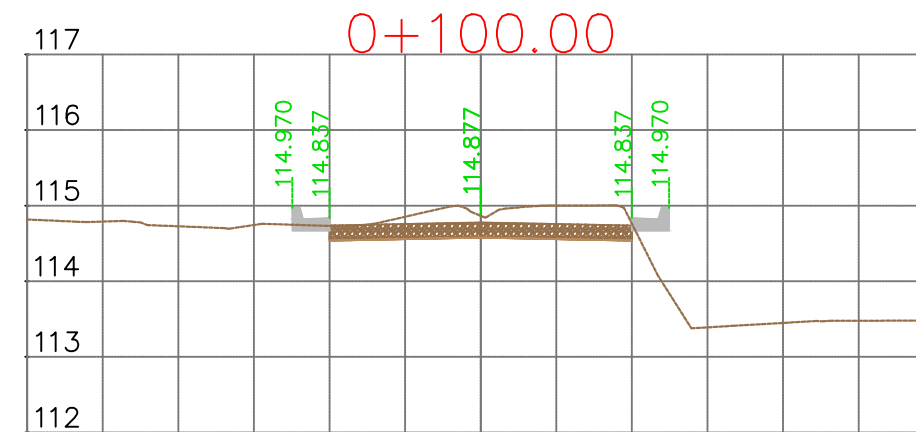
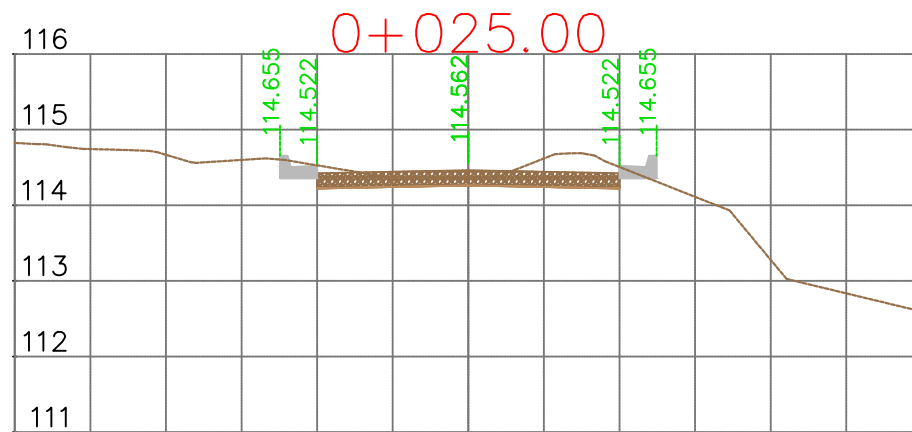
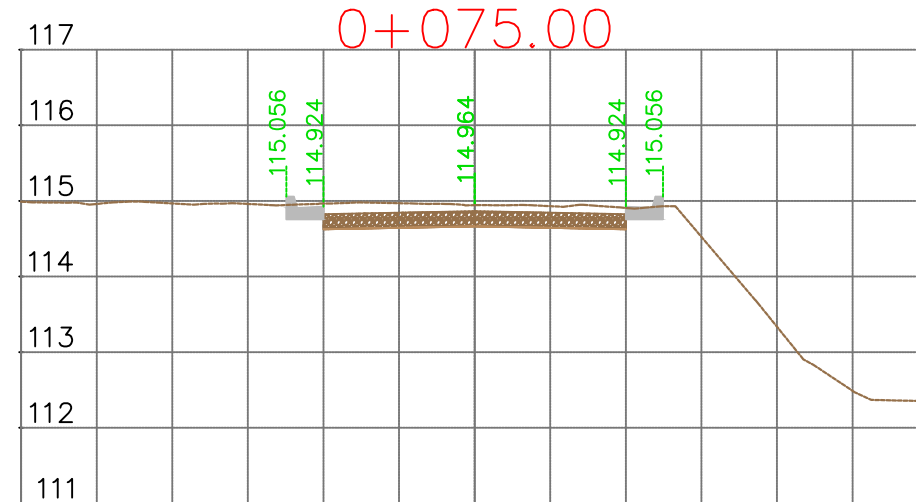
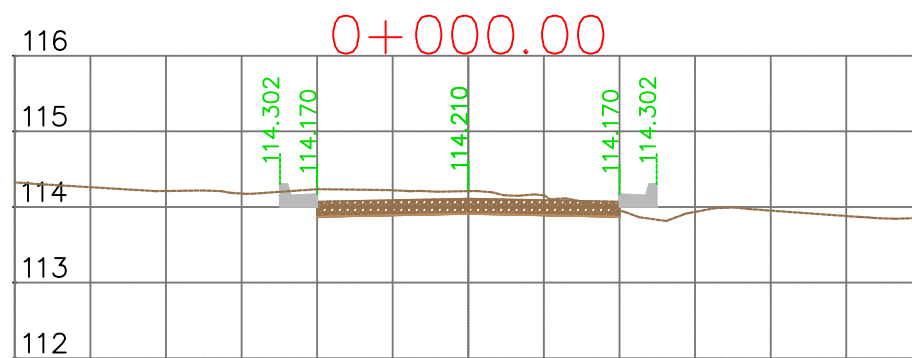

REPUBLIKA E SHQIPËRISË
BASHKIA E TIRANËS

OBJEKTI: "RIKUALIFIKIMI URBAN I ZONËS INFORMALE QË KUFIZOHET NGA RRUGËT -SABAUDIN GABRANI -JONUZ RAMA-HAMDI CULLHAJ-DAMIAN HIMARIOTI-BARI ISHKA-VASFI SAMIMI-ALUSH ELMAZ TAKA."

Projektoi :

Ing.A.JAKOVA
Ing.G.ISLAMI
Ing.S.MYRSELI
Ing.P.SHKURTI

Ark.M.DADO
Ing.Gjeol.Xh.KASMI
Ing.Mjedis.E.CALI
Top.A.BECECI

Projektoi :
"S&L STUDIO SH.P.K"

Projektim-kupervizion-cosnulence



FAZA

DORËZIM

PROJEKT ZBATIMI

1.0

PROFILE TËRTHORE
RRUGA RR.ILMAZ TAKA 2

SHKALLA 1:100

Nr. I FLETËS 001

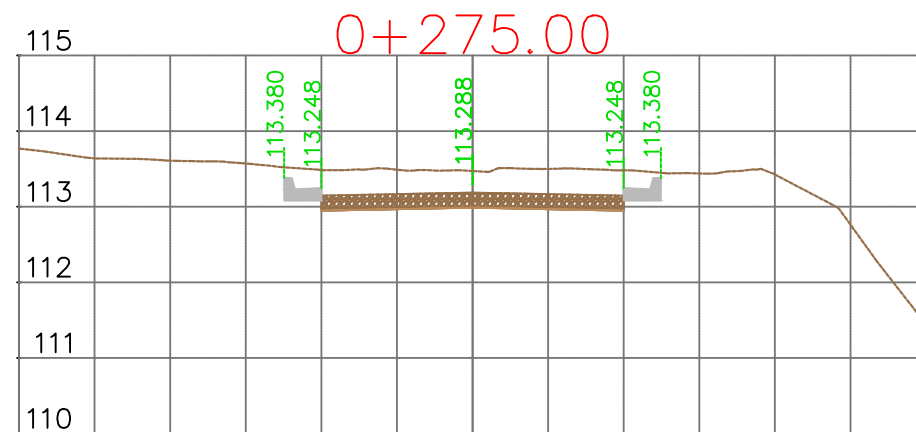
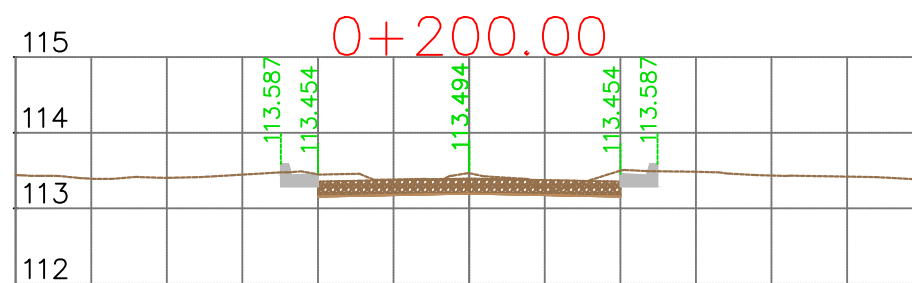
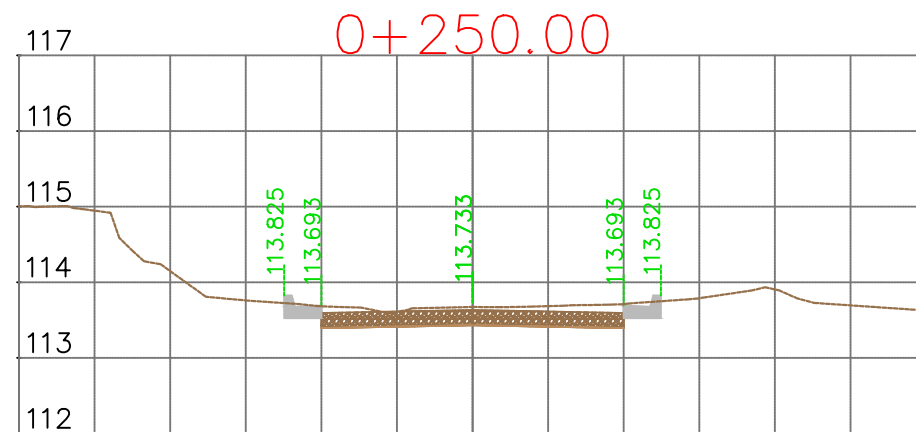
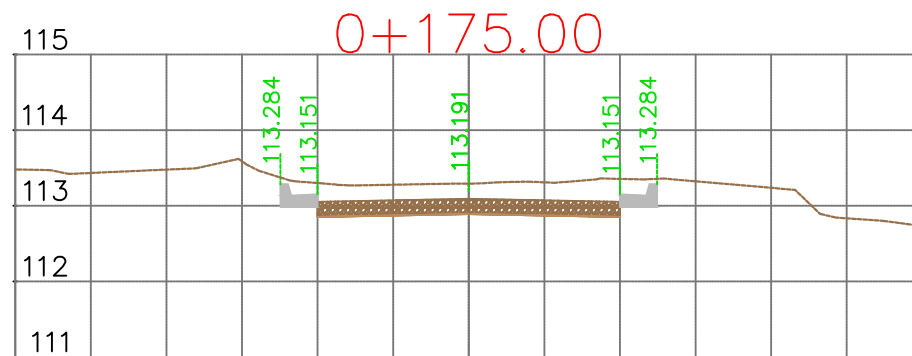
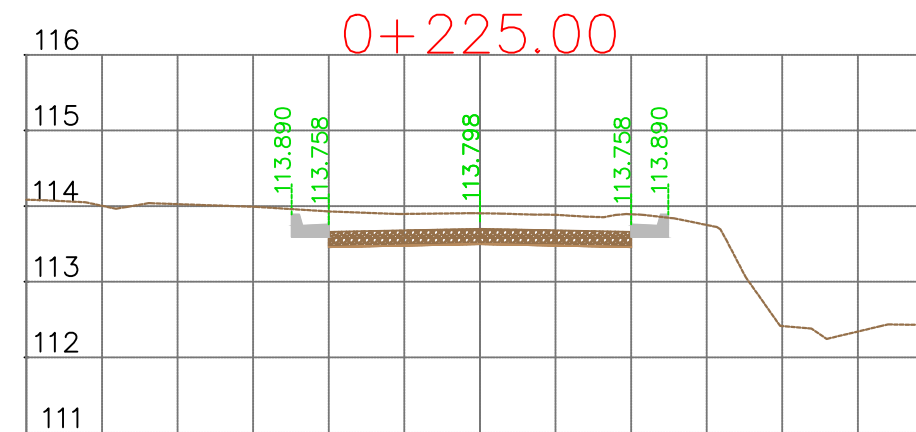
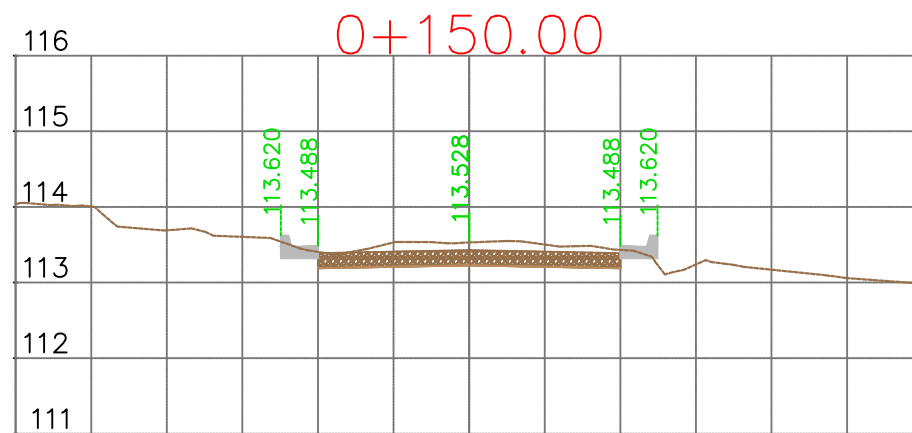

REPUBLIKA E SHQIPËRISË
BASHKIA E TIRANËS

OBJEKTI: "RIKUALIFIKIMI URBAN I ZONËS
INFORMALE QË KUFIZOHET NGA RRUGËT
-SABAUDIN GABRANI -JONUZ RAMA-HAMDI
CULLHAJ-DAMIAN HIMARIOTI-BARI
ISHKA-VASFI SAMIMI-ALUSH ELMAZ TAKA."

Projektoi :

Ing.A.JAKOVA
Ing.G.ISLAMI
Ing.S.MYRSELI
Ing.P.SHKURTI

Ark.M.DADO
Ing.Gjeol.Xh.KASMI
Ing.Mjedis.E.CALI
Top.A.BECECI

Projektoi :

"S&L STUDIO SH.P.K"

Projektim-kupervizion-cosnulence



FAZA

DORËZIM

PROJEKT ZBATIMI

1.0

PROFILE TËRTHORE
RRUGA RR.ILMAZ TAKA 2

SHKALLA 1:100

Nr. I FLETËS 002

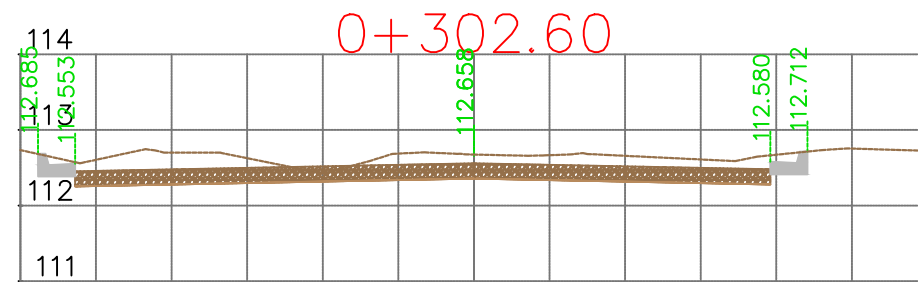
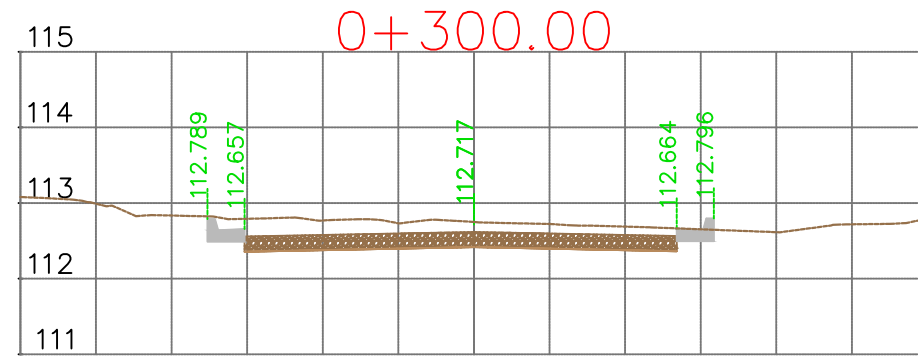

REPUBLIKA E SHQIPËRISË
BASHKIA E TIRANËS

OBJEKTI: "RIKUALIFIKIMI URBAN I ZONËS INFORMALE QË KUFIZOHET NGA RRUGËT -SABAUDIN GABRANI -JONUZ RAMA-HAMDI CULLHAJ-DAMIAN HIMARIOTI-BARI ISHKA-VASFI SAMIMI-ALUSH ELMAZ TAKA."

Projektoi :

Ing.A.JAKOVA
Ing.G.ISLAMI
Ing.S.MYRSELI
Ing.P.SHKURTI

Ark.M.DADO
Ing.Gjeol.Xh.KASMI
Ing.Mjedis.E.CALI
Top.A.BECECI

Projektoi :

"S&L STUDIO SH.P.K"

Projektim-kupervizion-cosnulence



FAZA

DORËZIM

PROJEKT ZBATIMI

1.0

PROFILE TËRTHORE
RRUGA RR.ILMAZ TAKA 2

SHKALLA 1:100

Nr. I FLETËS 003

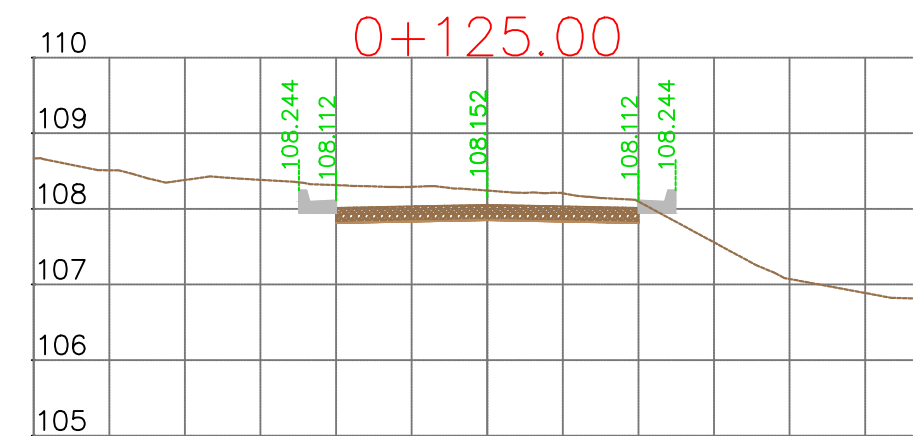
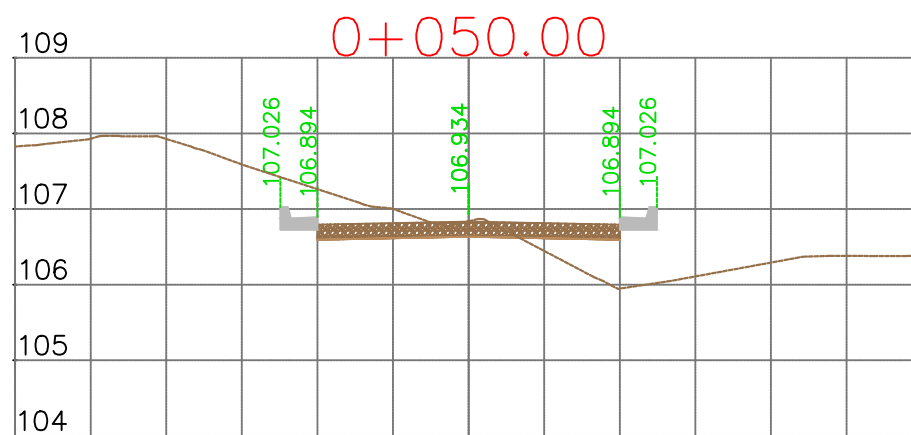
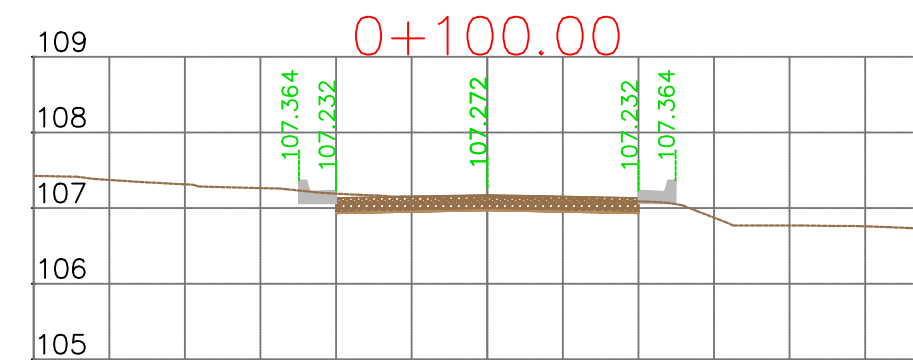
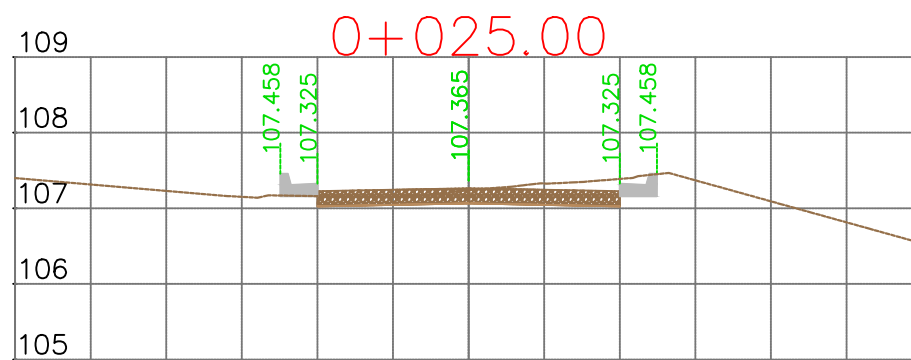
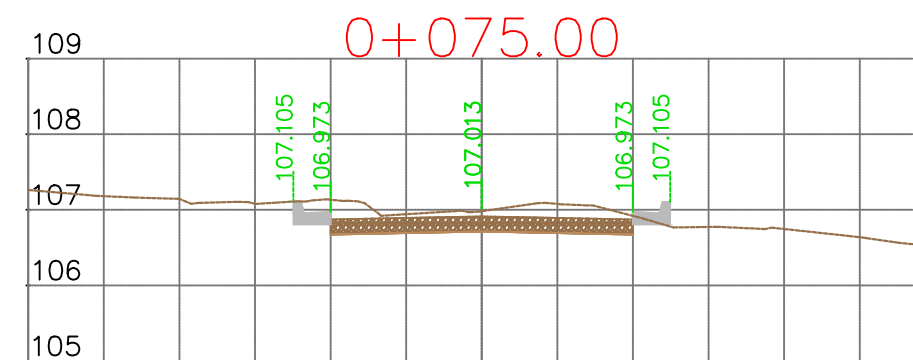
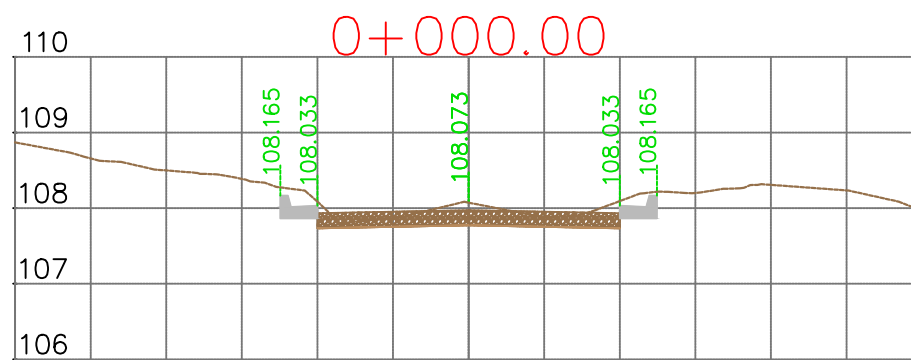

REPUBLIKA E SHQIPËRISË
BASHKIA E TIRANËS

OBJEKTI: "RIKUALIFIKIMI URBAN I ZONËS
INFORMALE QË KUFIZOHET NGA RRUGËT
-SABAUDIN GABRANI -JONUZ RAMA-HAMDI
CULLHAJ-DAMIAN HIMARIOTI-BARI
ISHKA-VASFI SAMIMI-ALUSH ELMAZ TAKA."

Projektoi :

Ing.A.JAKOVA
Ing.G.ISLAMI
Ing.S.MYRSELI
Ing.P.SHKURTI

Ark.M.DADO
Ing.Gjeol.Xh.KASMI
Ing.Mjedis.E.CALI
Top.A.BECECI

Projektoi :

"S&L STUDIO SH.P.K"

Projektim-kupervizion-cosnulence



FAZA

DORËZIM

PROJEKT ZBATIMI

1.0

PROFILE TËRTHORE
RRUGA RR.ATE STATH MELANI

SHKALLA 1:100

Nr. I FLETËS 001

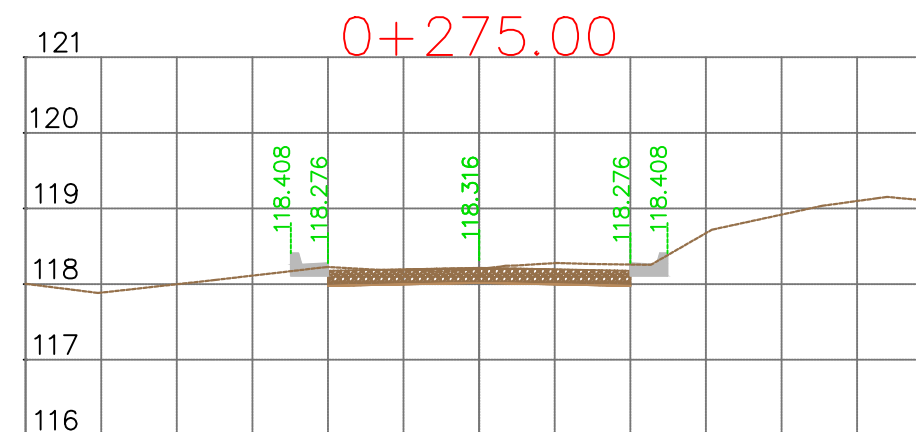
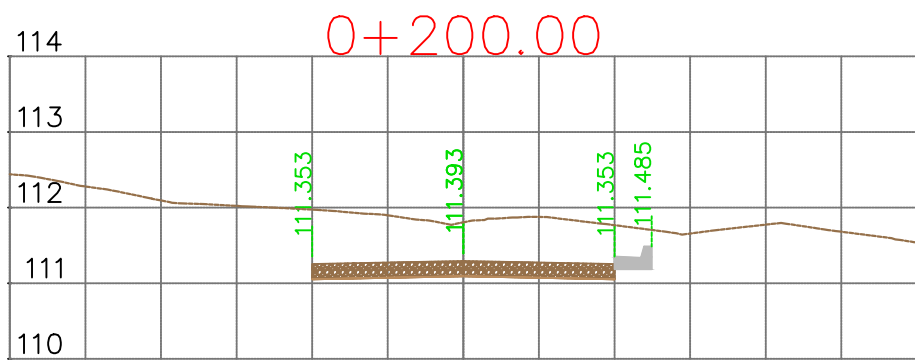
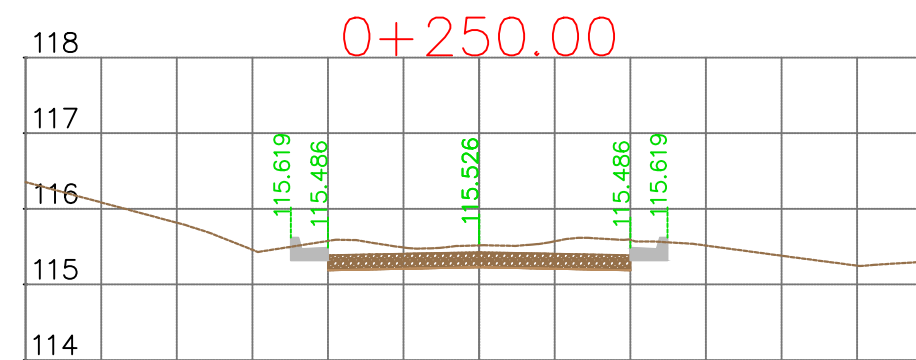
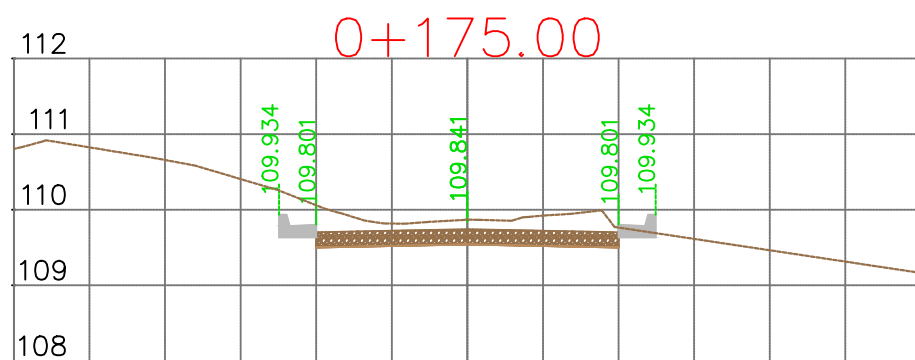
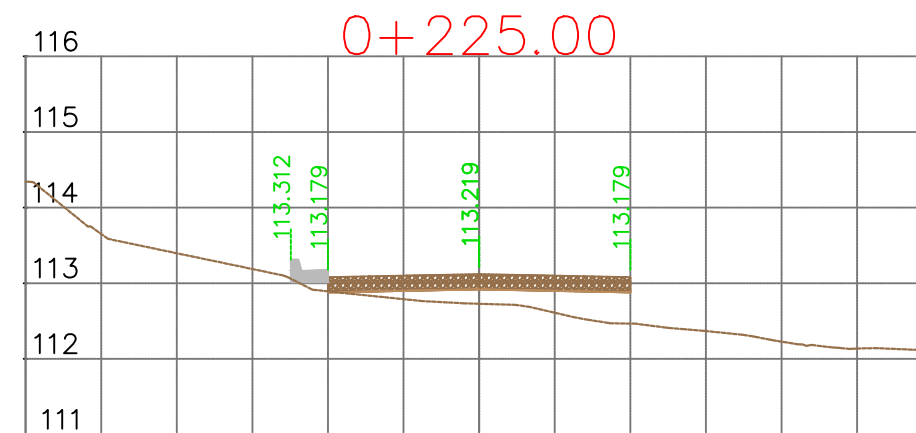
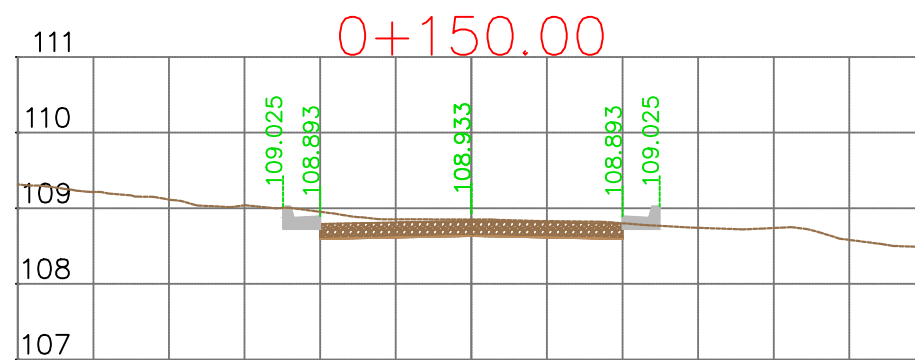

REPUBLIKA E SHQIPËRISË
BASHKIA E TIRANËS

OBJEKTI: "RIKUALIFIKIMI URBAN I ZONËS
INFORMALE QË KUFIZOHET NGA RRUGËT
-SABAUDIN GABRANI -JONUZ RAMA-HAMDI
CULLHAJ-DAMIAN HIMARIOTI-BARI
ISHKA-VASFI SAMIMI-ALUSH ELMAZ TAKA."

Projektoi :

Ing.A.JAKOVA
Ing.G.ISLAMI
Ing.S.MYRSELI
Ing.P.SHKURTI

Ark.M.DADO
Ing.Gjeol.Xh.KASMI
Ing.Mjedis.E.CALI
Top.A.BECECI

Projektoi :

"S&L STUDIO SH.P.K"

Projektim-kupervizion-cosnulence



FAZA

DORËZIM

PROJEKT ZBATIMI

1.0

PROFILE TËRTHORE
RRUGA RR.ATE STATH MELANI

SHKALLA 1:100

Nr. I FLETËS 002

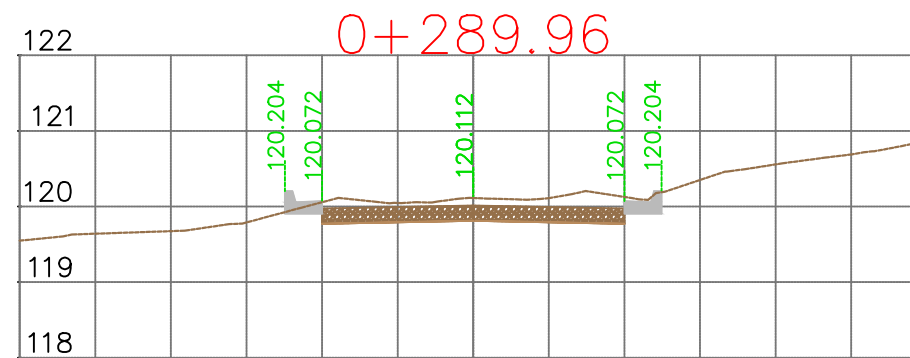

REPUBLIKA E SHQIPËRISË
BASHKIA E TIRANËS

OBJEKTI: "RIKUALIFIKIMI URBAN I ZONËS
INFORMALE QË KUFIZOHET NGA RRUGËT
-SABAUDIN GABRANI -JONUZ RAMA-HAMDI
CULLHAJ-DAMIAN HIMARIOTI-BARI
ISHKA-VASFI SAMIMI-ALUSH ELMAZ TAKA."

Projektoi :

Ing.A.JAKOVA
Ing.G.ISLAMI
Ing.S.MYRSELI
Ing.P.SHKURTI

Ark.M.DADO
Ing.Gjeol.Xh.KASMI
Ing.Mjedis.E.CALI
Top.A.BECECI

Projektoi :
"S&L STUDIO SH.P.K"

Projektim-kupervizion-cosnulence



FAZA

DORËZIM

PROJEKT ZBATIMI

1.0

PROFILE TËRTHORE
RRUGA RR.ATE STATH MELANI

SHKALLA 1:100

Nr. I FLETËS 003

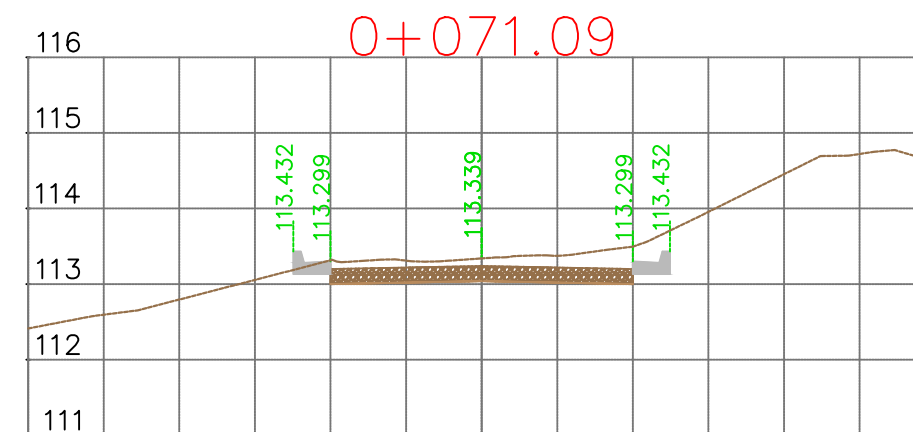
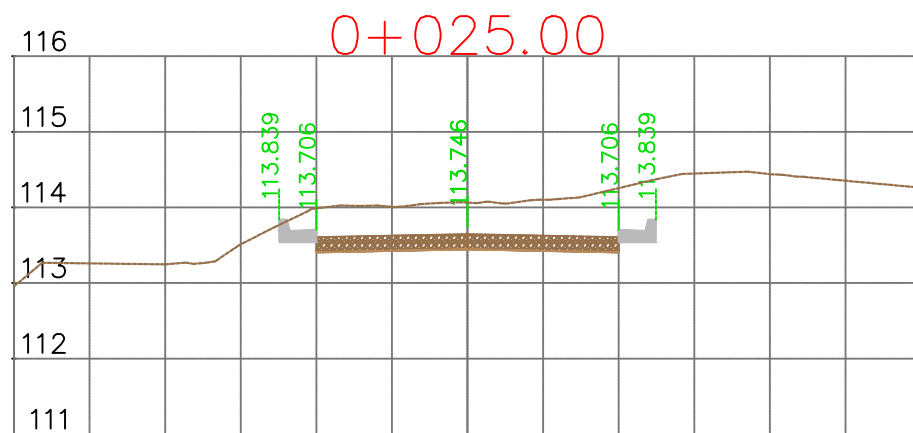
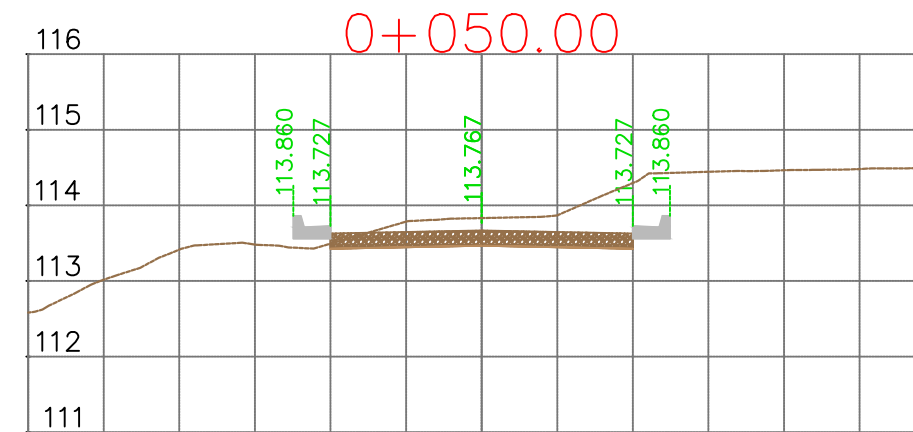
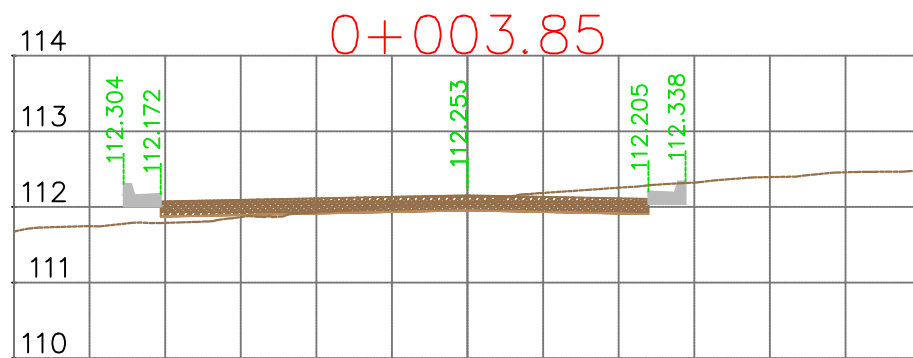

REPUBLIKA E SHQIPËRISË
BASHKIA E TIRANËS

OBJEKTI: "RIKUALIFIKIMI URBAN I ZONËS
INFORMALE QË KUFIZOHET NGA RRUGËT
-SABAUDIN GABRANI -JONUZ RAMA-HAMDI
CULLHAJ-DAMIAN HIMARIOTI-BARI
ISHKA-VASFI SAMIMI-ALUSH ELMAZ TAKA."

Projektoi :

Ing.A.JAKOVA
Ing.G.ISLAMI
Ing.S.MYRSELI
Ing.P.SHKURTI

Ark.M.DADO
Ing.Gjeol.Xh.KASMI
Ing.Mjedis.E.CALI
Top.A.BECECI

Projektoi :

"S&L STUDIO SH.P.K"

Projektim-kupervizion-cosnulence



FAZA

DORËZIM

PROJEKT ZBATIMI

1.0

PROFILE TËRTHORE
RRUGA RR.ATE STATH MELANI

SHKALLA 1:100

Nr. I FLETËS 004

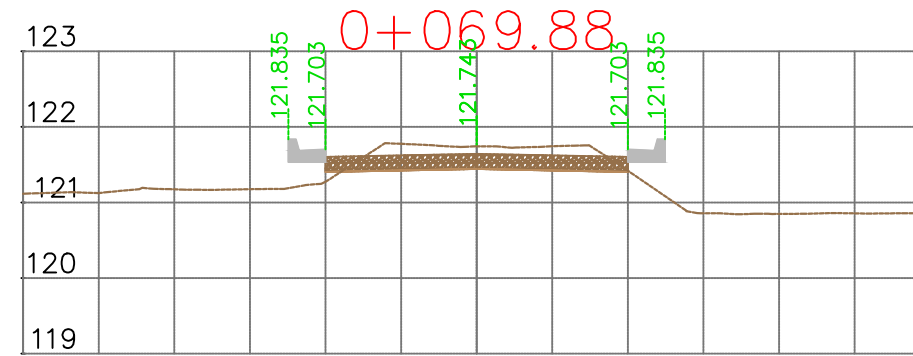
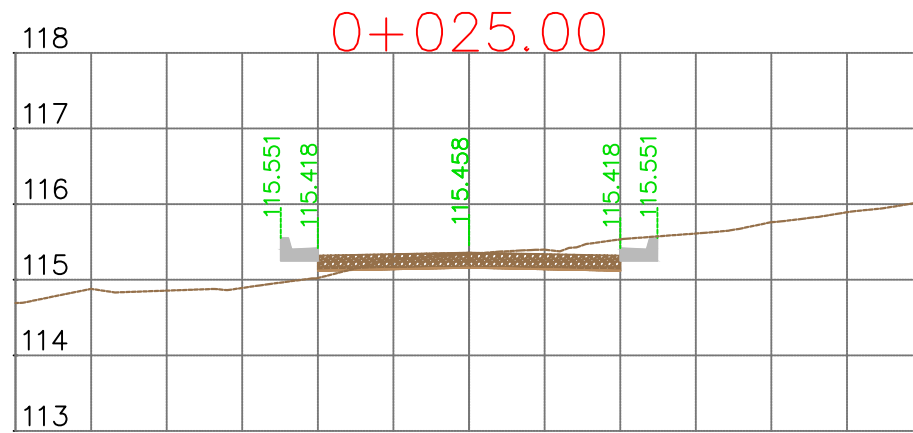
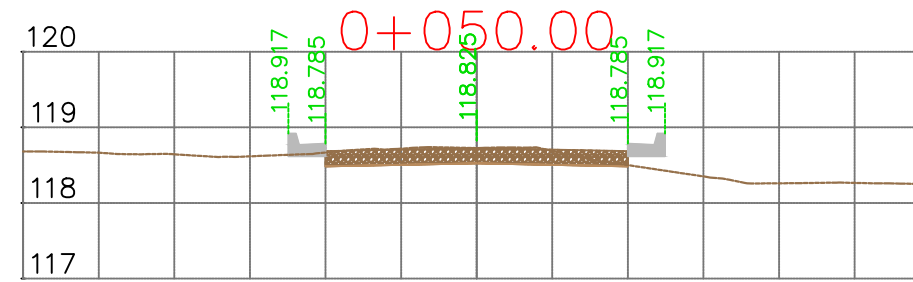
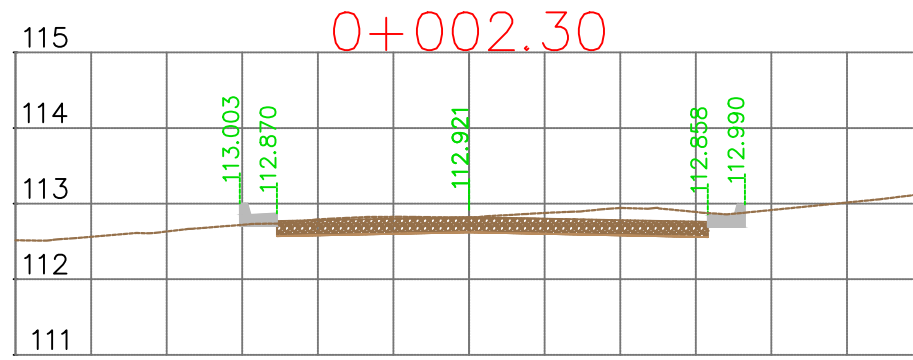

REPUBLIKA E SHQIPËRISË
BASHKIA E TIRANËS

OBJEKTI: "RIKUALIFIKIMI URBAN I ZONËS
INFORMALE QË KUFIZOHET NGA RRUGËT
-SABAUDIN GABRANI -JONUZ RAMA-HAMDI
CULLHAJ-DAMIAN HIMARIOTI-BARI
ISHKA-VASFI SAMIMI-ALUSH ELMAZ TAKA."

Projektoi :

Ing.A.JAKOVA
Ing.G.ISLAMI
Ing.S.MYRSELI
Ing.P.SHKURTI

Ark.M.DADO
Ing.Gjeol.Xh.KASMI
Ing.Mjedis.E.CALI
Top.A.BECECI

Projektoi :
"S&L STUDIO SH.P.K"

Projektim-kupervizion-cosnulence



FAZA

DORËZIM

PROJEKT ZBATIMI

1.0

PROFILE TËRTHORE
RRUGA RR.ATE STATH MELANI

SHKALLA 1:100

Nr. I FLETËS 005

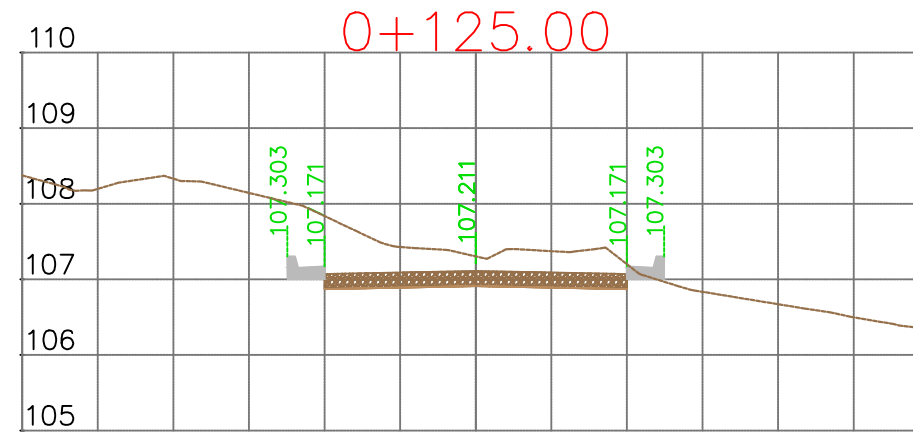
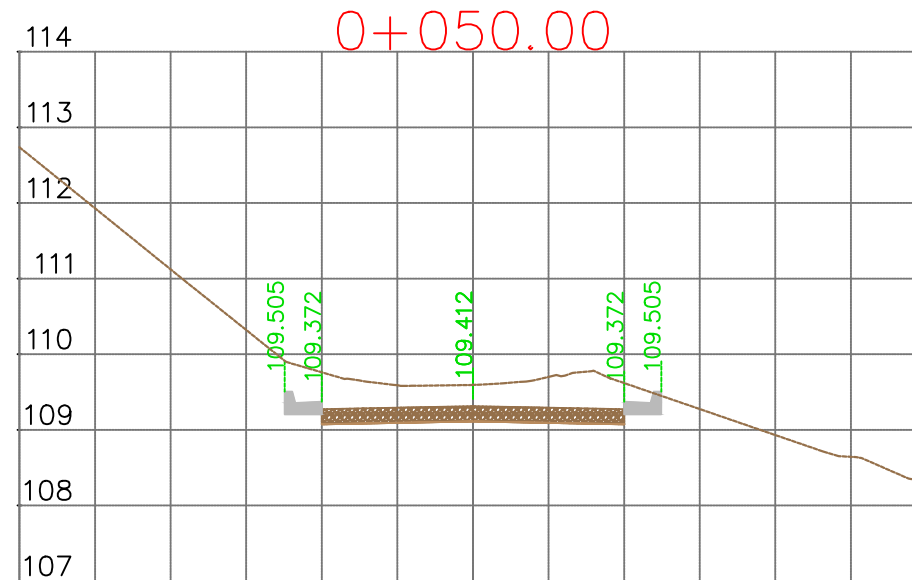
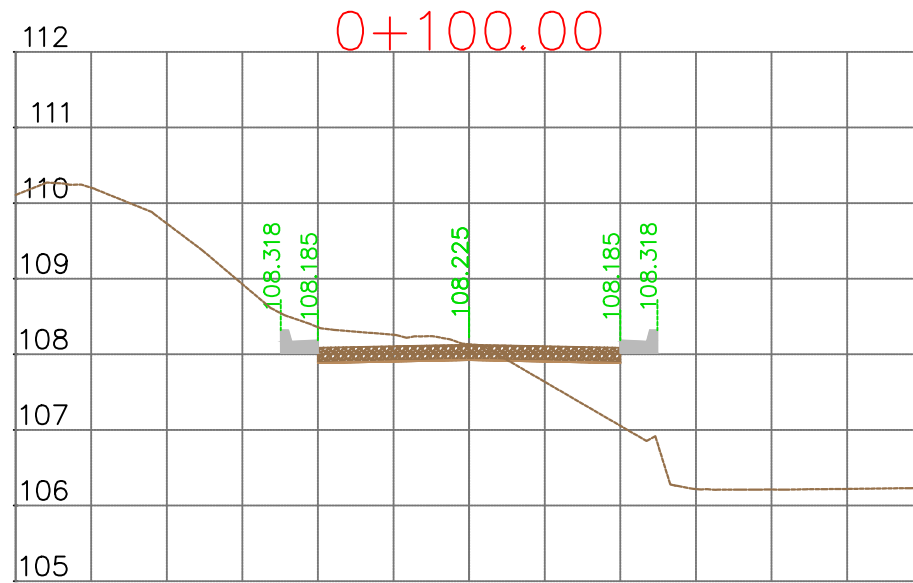
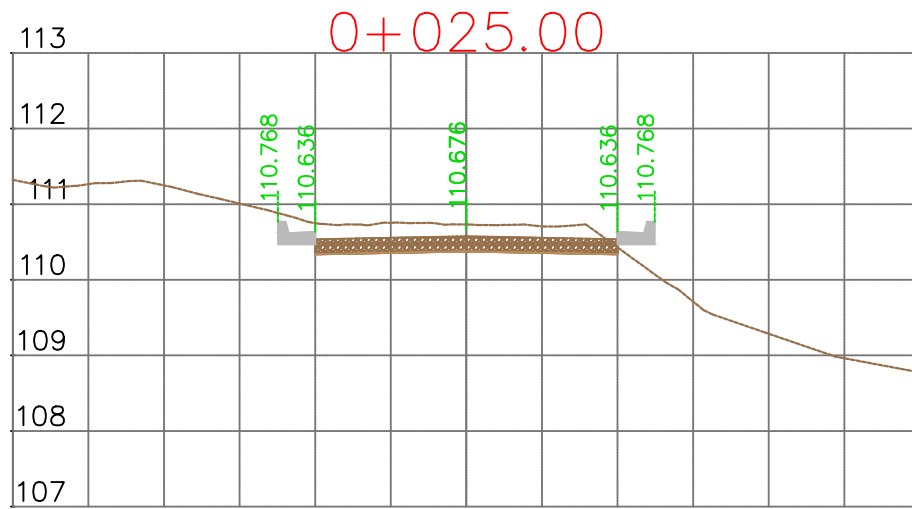
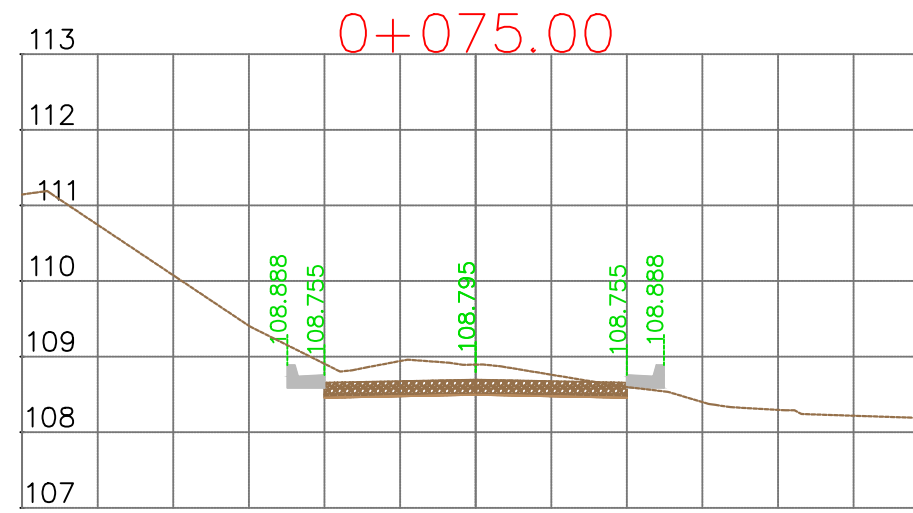
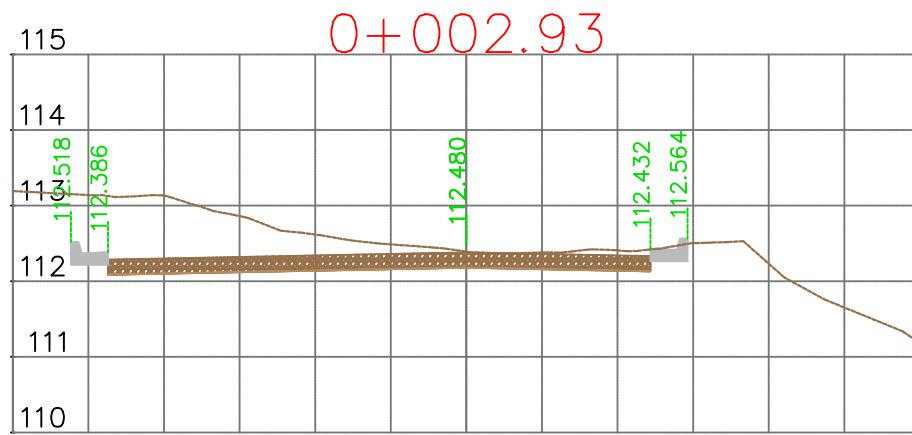

REPUBLIKA E SHQIPËRISË
BASHKIA E TIRANËS

OBJEKTI: "RIKUALIFIKIMI URBAN I ZONËS
INFORMALE QË KUFIZOHET NGA RRUGËT
-SABAUDIN GABRANI -JONUZ RAMA-HAMDI
CULLHAJ-DAMIAN HIMARIOTI-BARI
ISHKA-VASFI SAMIMI-ALUSH ELMAZ TAKA."

Projektoi :

Ing.A.JAKOVA
Ing.G.ISLAMI
Ing.S.MYRSELI
Ing.P.SHKURTI

Ark.M.DADO
Ing.Gjeol.Xh.KASMI
Ing.Mjedis.E.CALI
Top.A.BECECI

Projektoi :

"S&L STUDIO SH.P.K"

Projektim-kupervizion-cosnulence



FAZA

DORËZIM

PROJEKT ZBATIMI

1.0

PROFILE TËRTHORE
RRUGA RR.ATE STATH MELANI

SHKALLA 1:100

Nr. I FLETËS 006

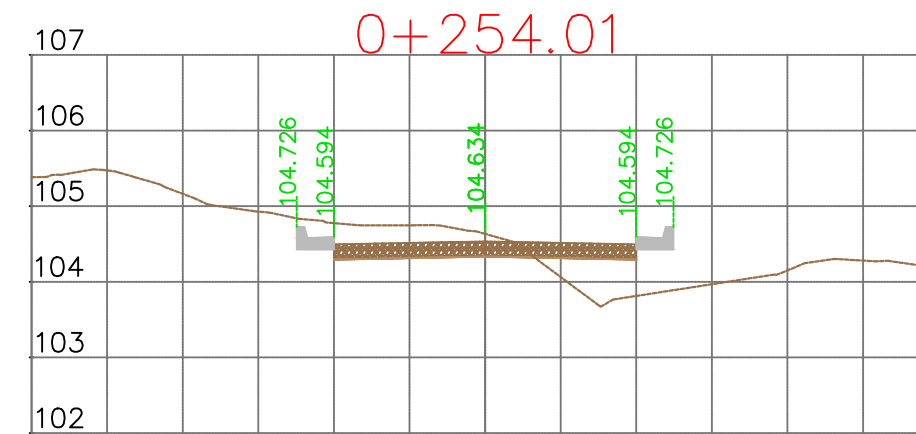
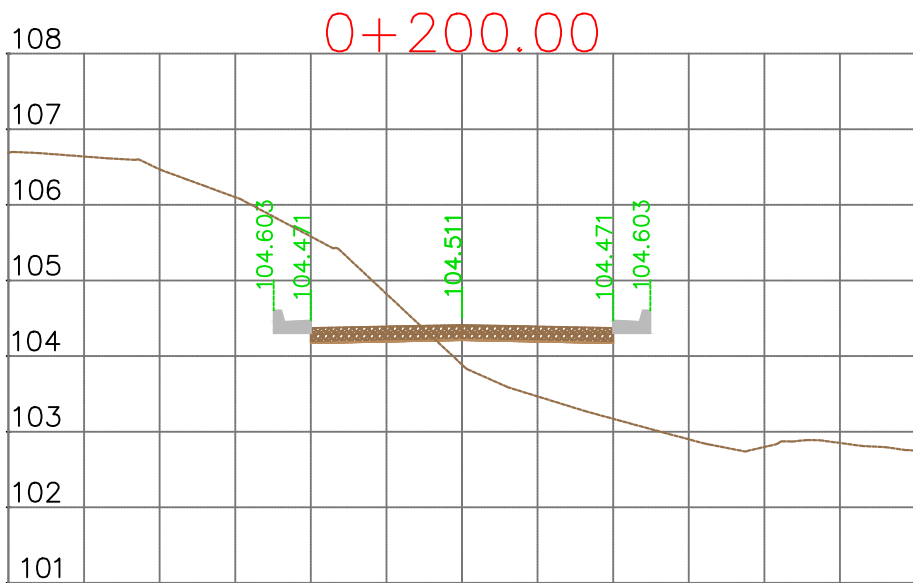
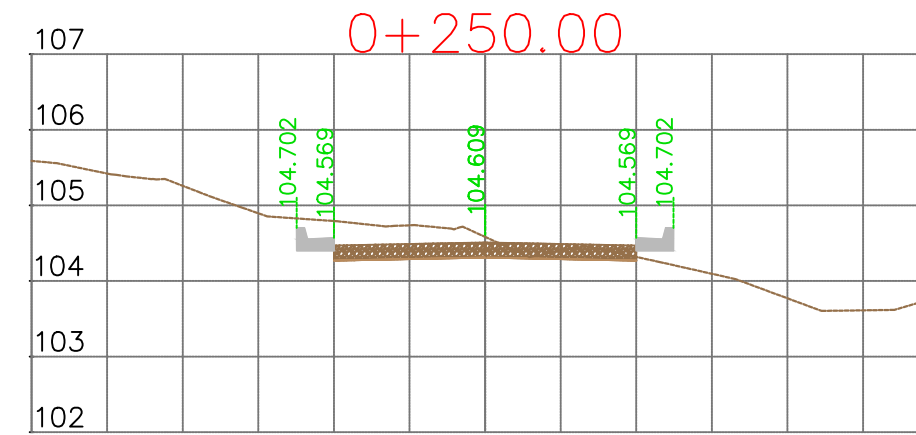
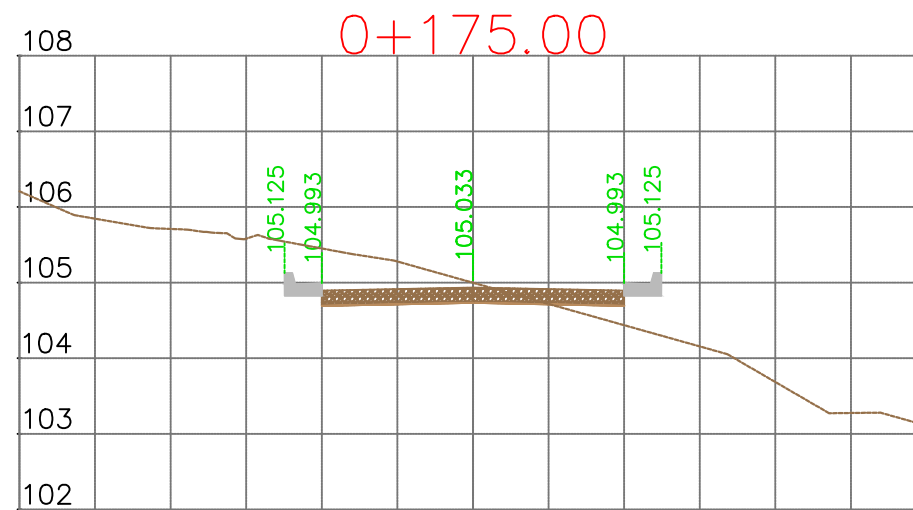
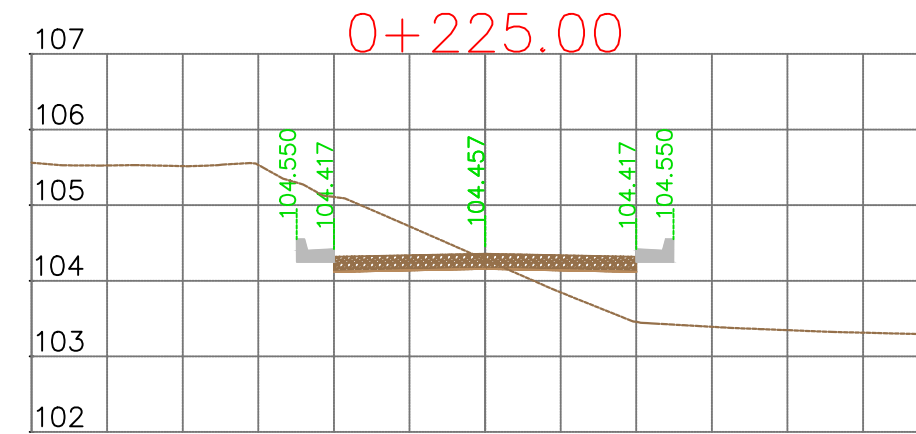

REPUBLIKA E SHQIPËRISË
BASHKIA E TIRANËS

OBJEKTI: "RIKUALIFIKIMI URBAN I ZONËS INFORMALE QË KUFIZOHET NGA RRUGËT -SABAUDIN GABRANI -JONUZ RAMA-HAMDI CULLHAJ-DAMIAN HIMARIOTI-BARI ISHKA-VASFI SAMIMI-ALUSH ELMAZ TAKA."

Projektoi :

Ing.A.JAKOVA
Ing.G.ISLAMI
Ing.S.MYRSELI
Ing.P.SHKURTI

Ark.M.DADO
Ing.Gjeol.Xh.KASMI
Ing.Mjedis.E.CALI
Top.A.BECECI

Projektoi :
"S&L STUDIO SH.P.K"

Projektim-kupervizion-cosnulence



FAZA

DORËZIM

PROJEKT ZBATIMI

1.0

PROFILE TËRTHORE
RRUGA RR.ATE STATH MELANI

SHKALLA 1:100

Nr. I FLETËS 007

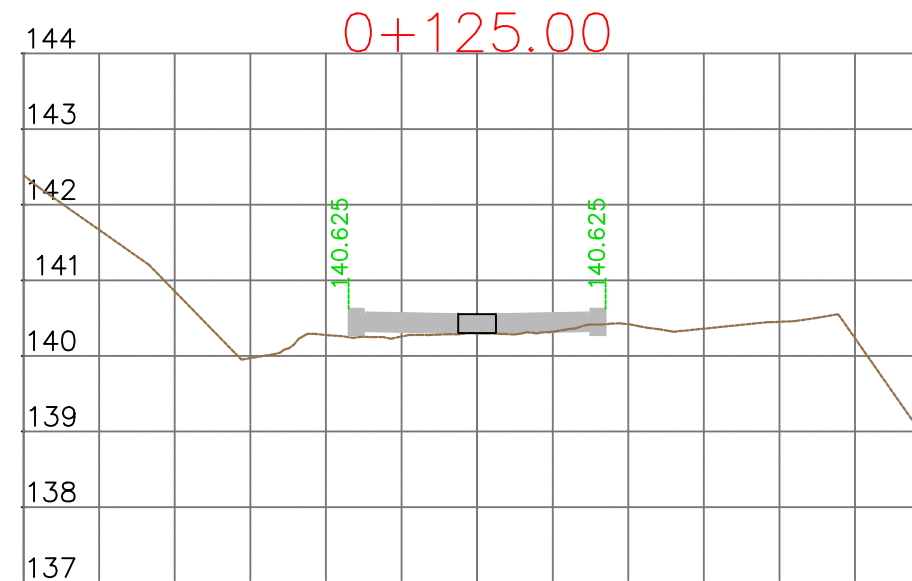
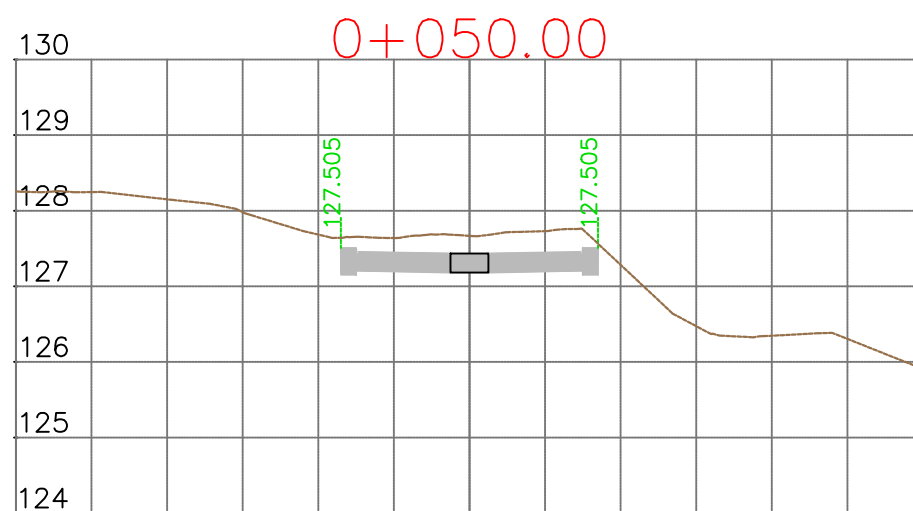
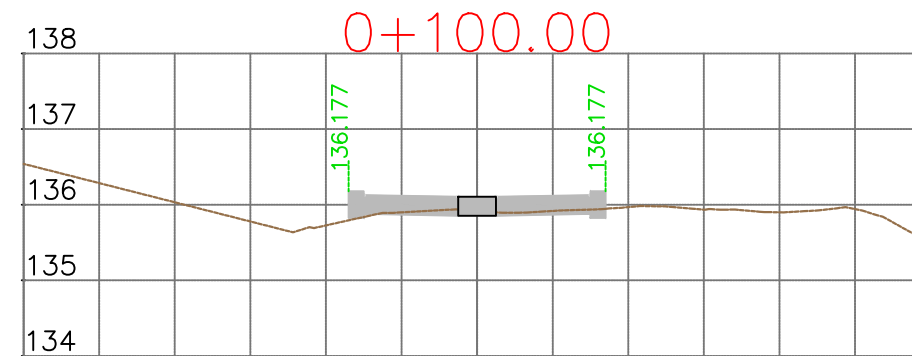
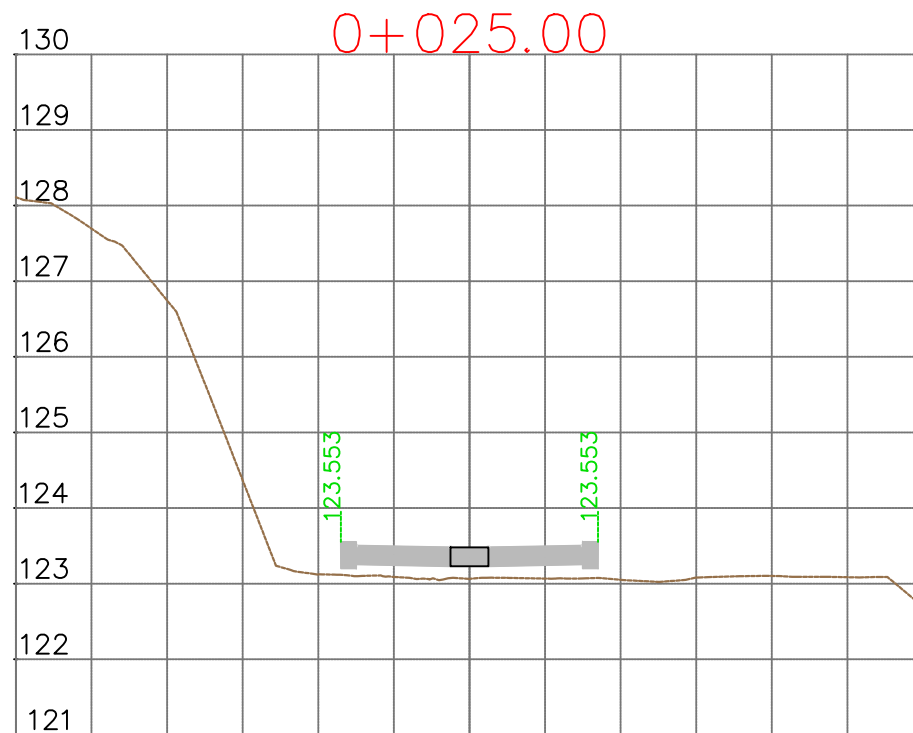
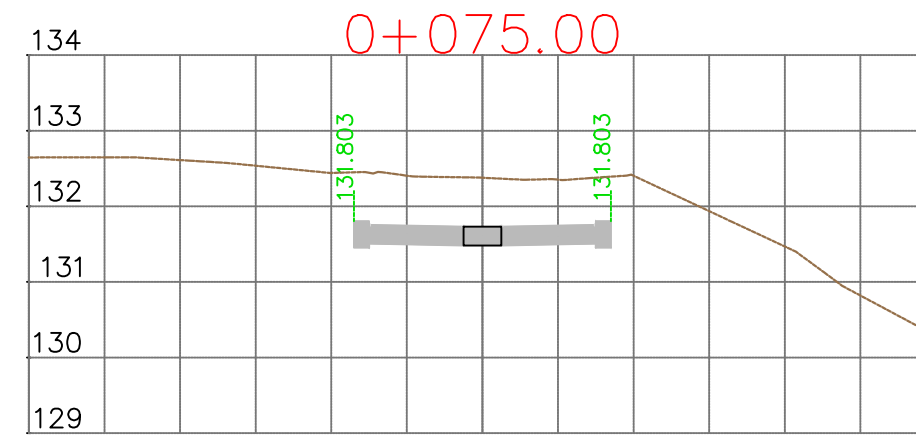
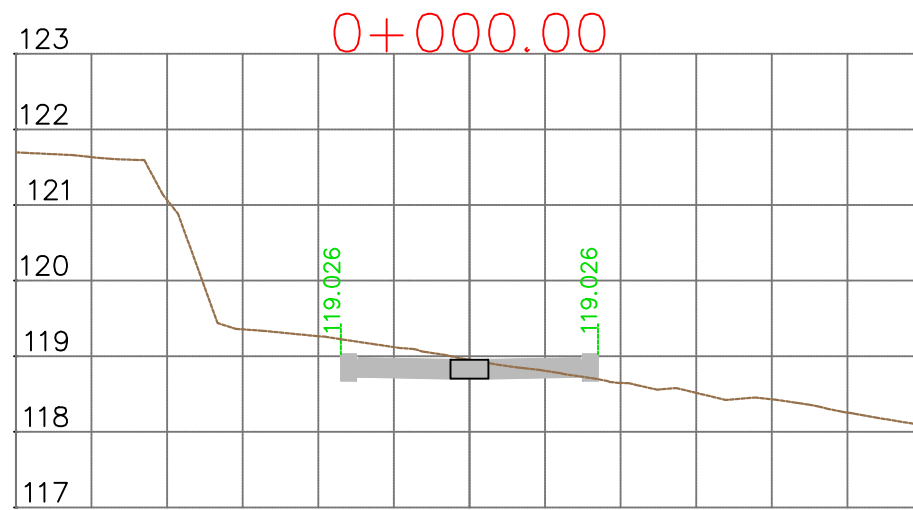

REPUBLIKA E SHQIPËRISË
BASHKIA E TIRANËS

OBJEKTI: "RIKUALIFIKIMI URBAN I ZONËS
INFORMALE QË KUFIZOHET NGA RRUGËT
-SABAUDIN GABRANI -JONUZ RAMA-HAMDI
CULLHAJ-DAMIAN HIMARIOTI-BARI
ISHKA-VASFI SAMIMI-ALUSH ELMAZ TAKA."

Projektoi :

Ing.A.JAKOVA
Ing.G.ISLAMI
Ing.S.MYRSELI
Ing.P.SHKURTI

Ark.M.DADO
Ing.Gjeol.Xh.KASMI
Ing.Mjedis.E.CALI
Top.A.BECECI

Projektoi :

"S&L STUDIO SH.P.K"

Projektim-kupervizion-cosnulence



FAZA

DORËZIM

PROJEKT ZBATIMI

1.0

PROFILE TËRTHORE
RRUGA RR.DAMIAN HIMARIOTI

SHKALLA 1:100

Nr. I FLETËS 001

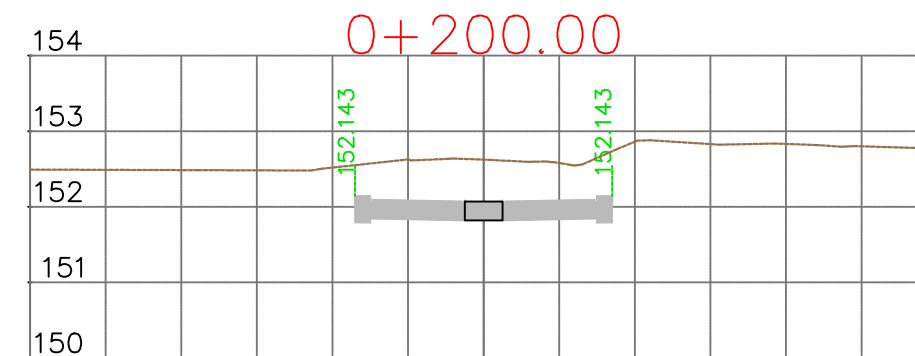
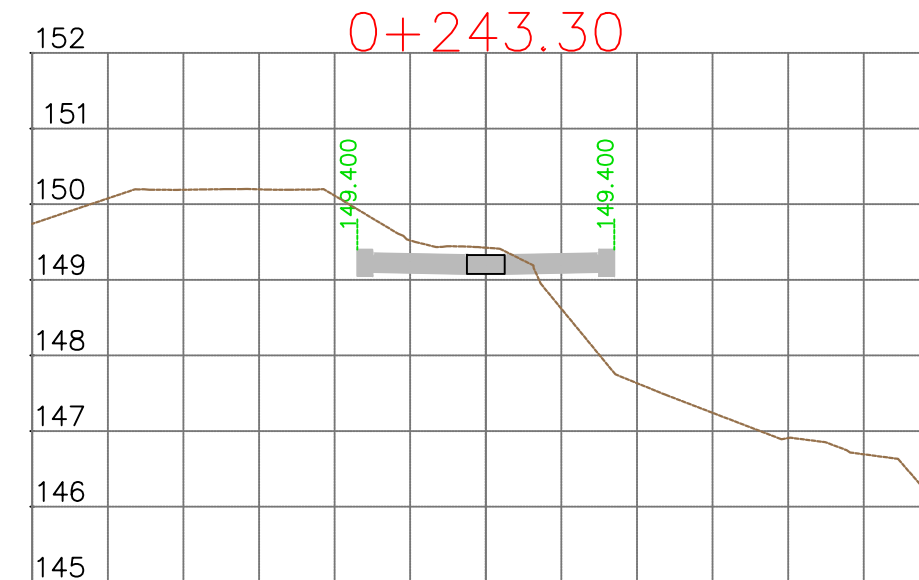
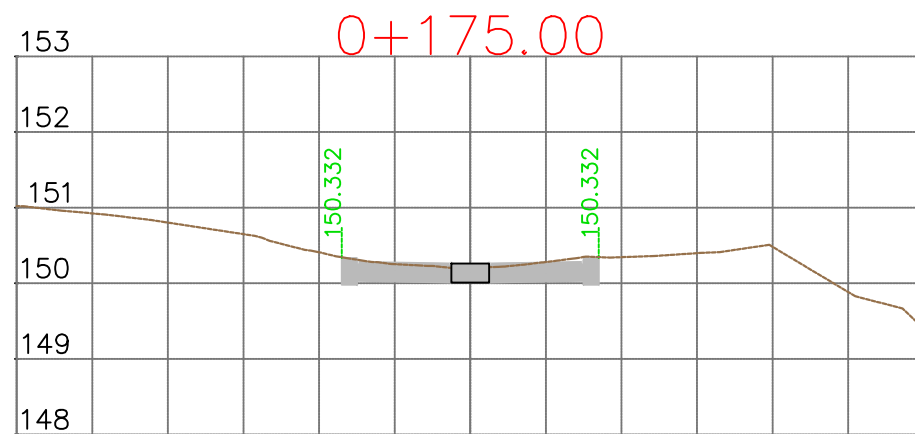
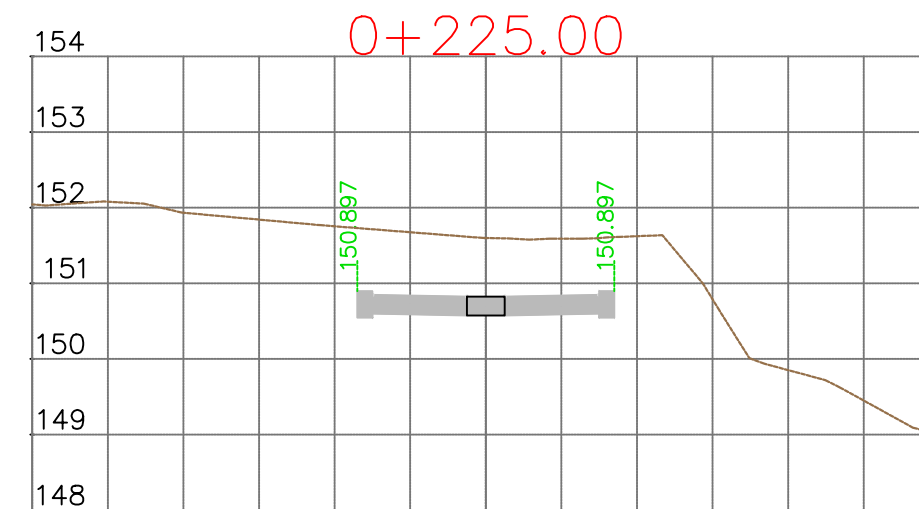
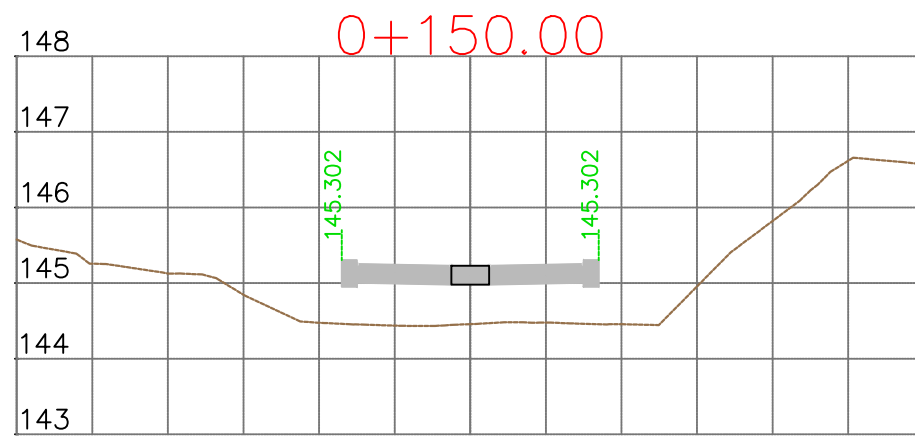

REPUBLIKA E SHQIPËRISË
BASHKIA E TIRANËS

OBJEKTI: "RIKUALIFIKIMI URBAN I ZONËS
INFORMALE QË KUFIZOHET NGA RRUGËT
-SABAUDIN GABRANI -JONUZ RAMA-HAMDI
CULLHAJ-DAMIAN HIMARIOTI-BARI
ISHKA-VASFI SAMIMI-ALUSH ELMAZ TAKA."

Projektoi :

Ing.A.JAKOVA
Ing.G.ISLAMI
Ing.S.MYRSELI
Ing.P.SHKURTI

Ark.M.DADO
Ing.Gjeol.Xh.KASMI
Ing.Mjedis.E.CALI
Top.A.BECECI

Projektoi :

"S&L STUDIO SH.P.K"

Projektim-kupervizion-cosnulence



FAZA

DORËZIM

PROJEKT ZBATIMI

1.0

PROFILE TËRTHORE
RRUGA RR.DAMIAN HIMARIOTI

SHKALLA 1:100

Nr. I FLETËS 002

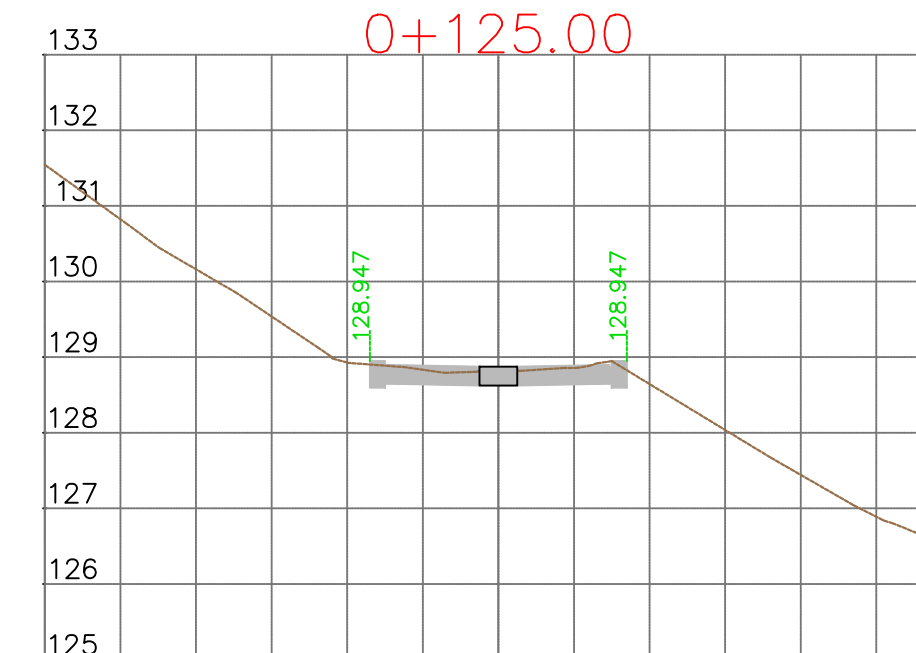
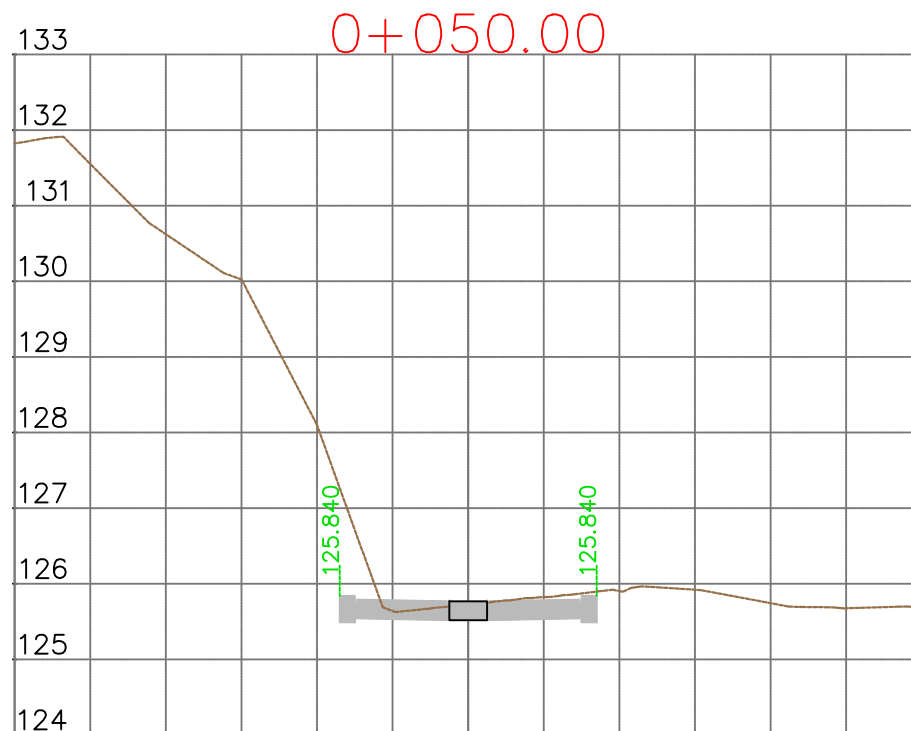
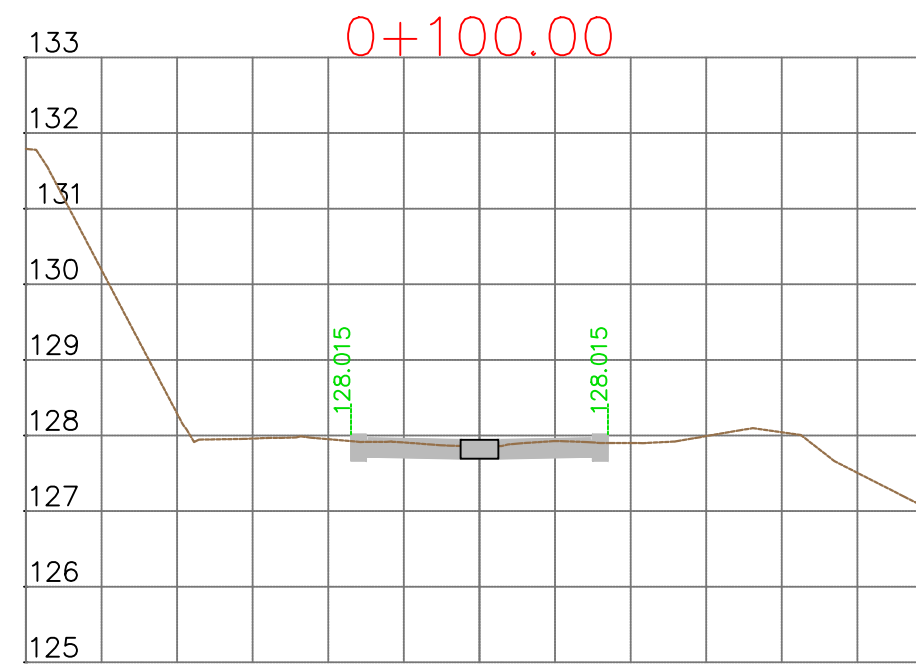
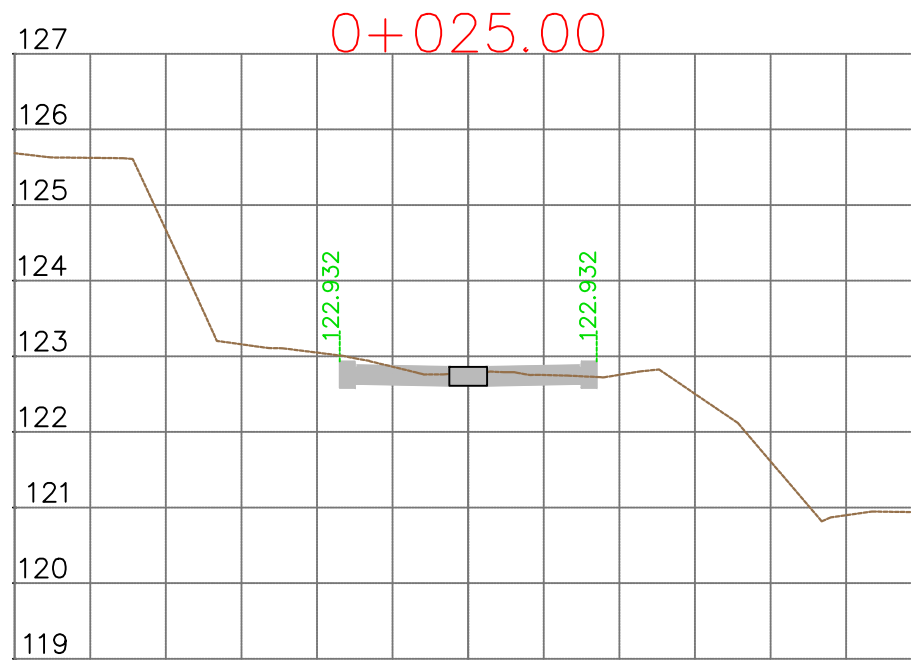
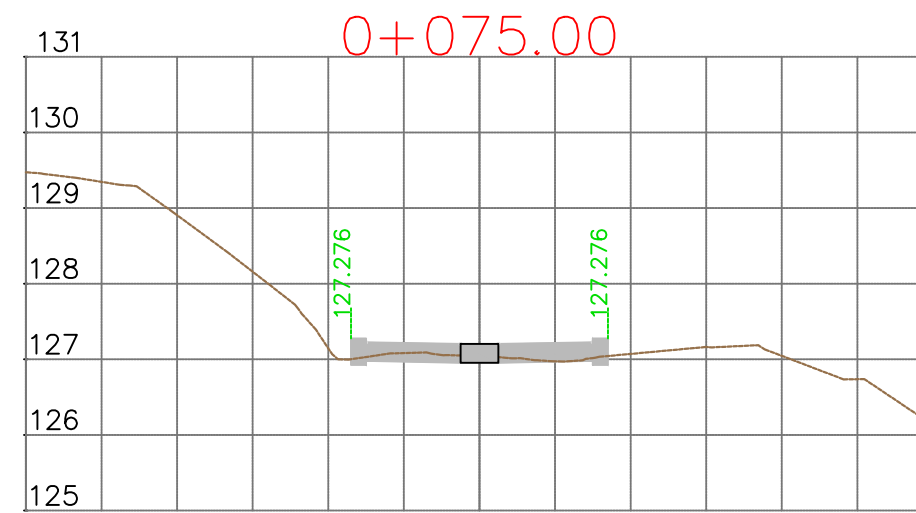
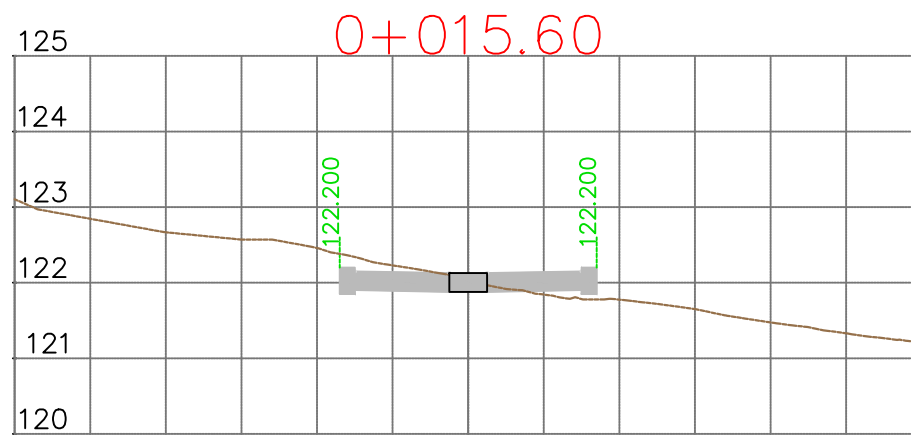

REPUBLIKA E SHQIPËRISË
BASHKIA E TIRANËS

OBJEKTI: "RIKUALIFIKIMI URBAN I ZONËS
INFORMALE QË KUFIZOHET NGA RRUGËT
-SABAUDIN GABRANI -JONUZ RAMA-HAMDI
CULLHAJ-DAMIAN HIMARIOTI-BARI
ISHKA-VASFI SAMIMI-ALUSH ELMAZ TAKA."

Projektoi :

Ing.A.JAKOVA
Ing.G.ISLAMI
Ing.S.MYRSELI
Ing.P.SHKURTI

Ark.M.DADO
Ing.Gjeol.Xh.KASMI
Ing.Mjedis.E.CALI
Top.A.BECECI

Projektoi :
"S&L STUDIO SH.P.K"

Projektim-kupervizion-cosnulence



FAZA

DORËZIM

PROJEKT ZBATIMI

1.0

PROFILE TËRTHORE
RRUGA RR.KROI BANES

SHKALLA 1:100

Nr. I FLETËS 001

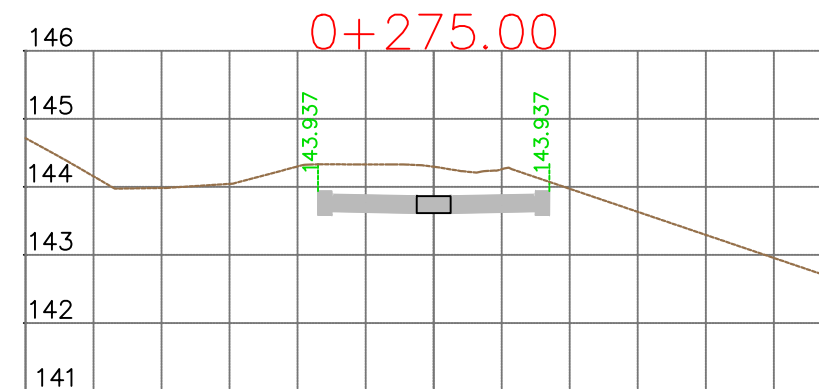
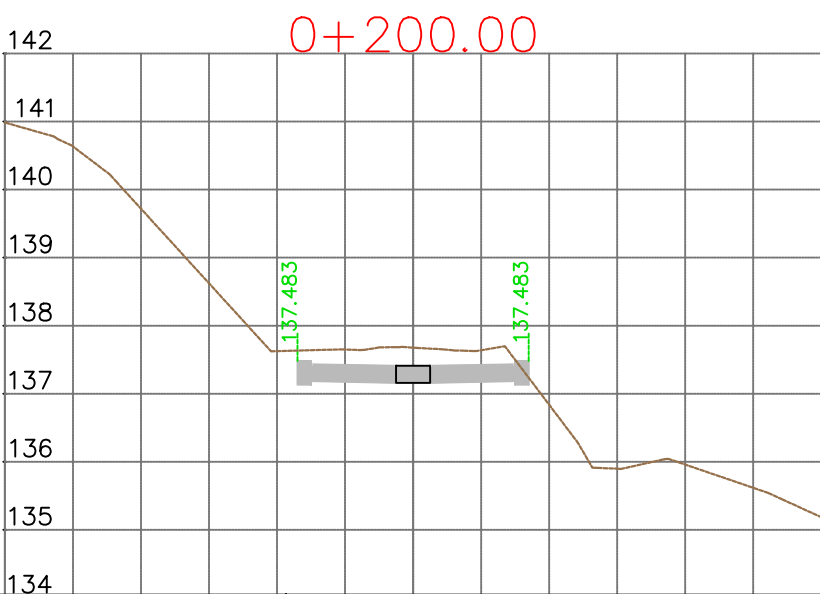
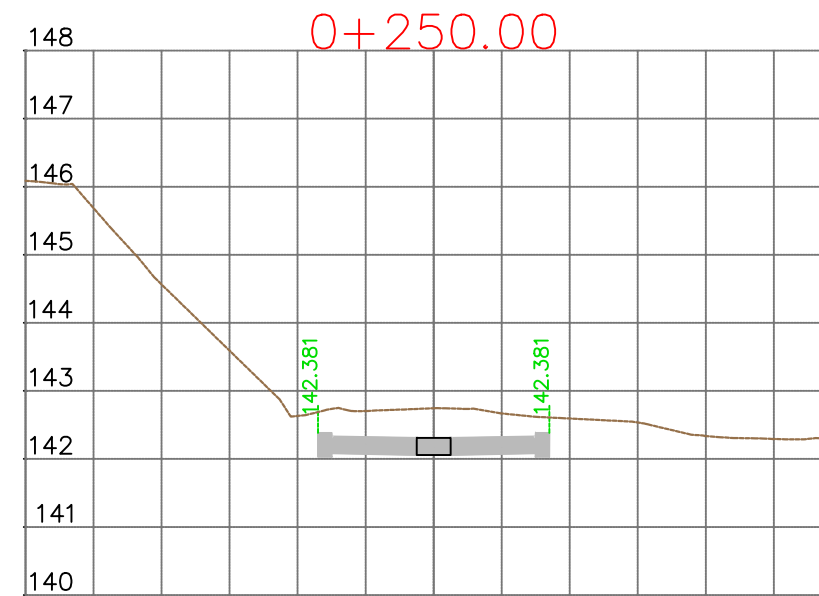
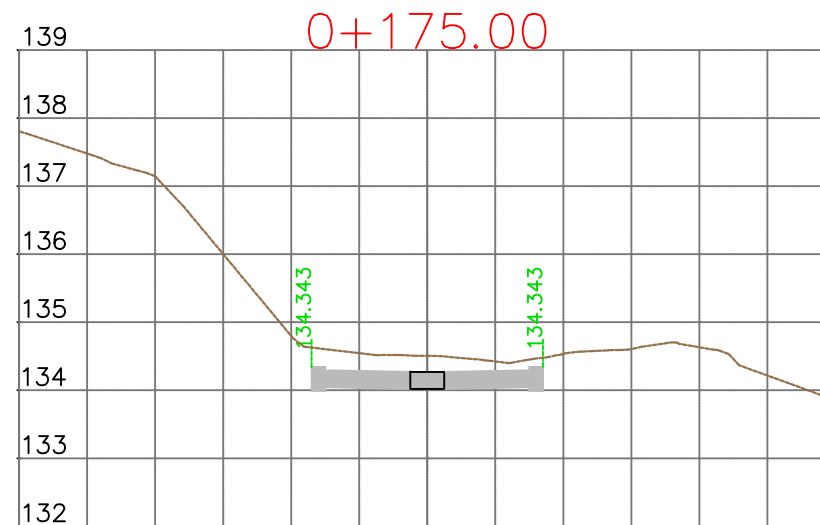
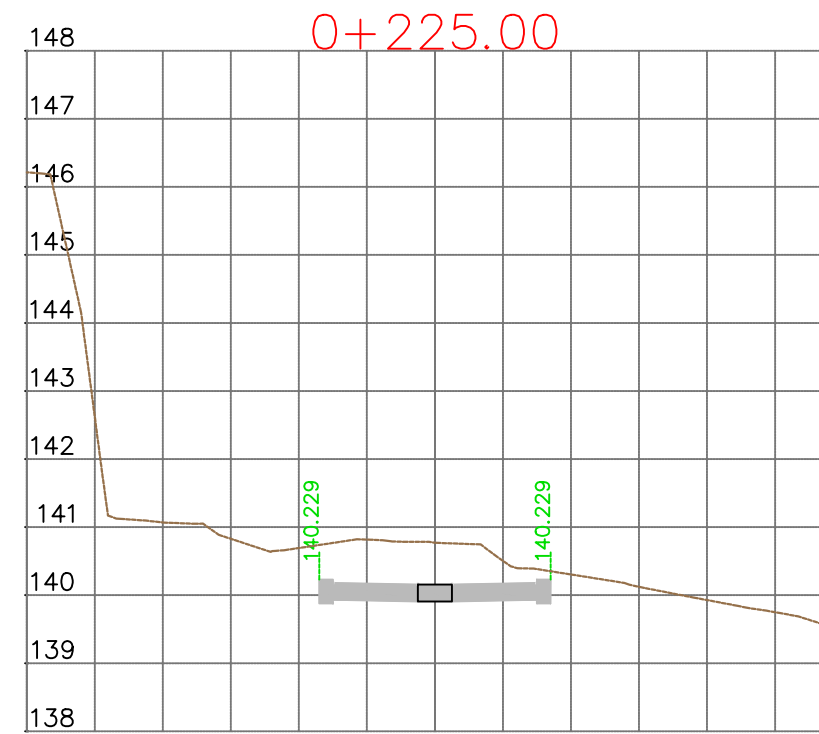
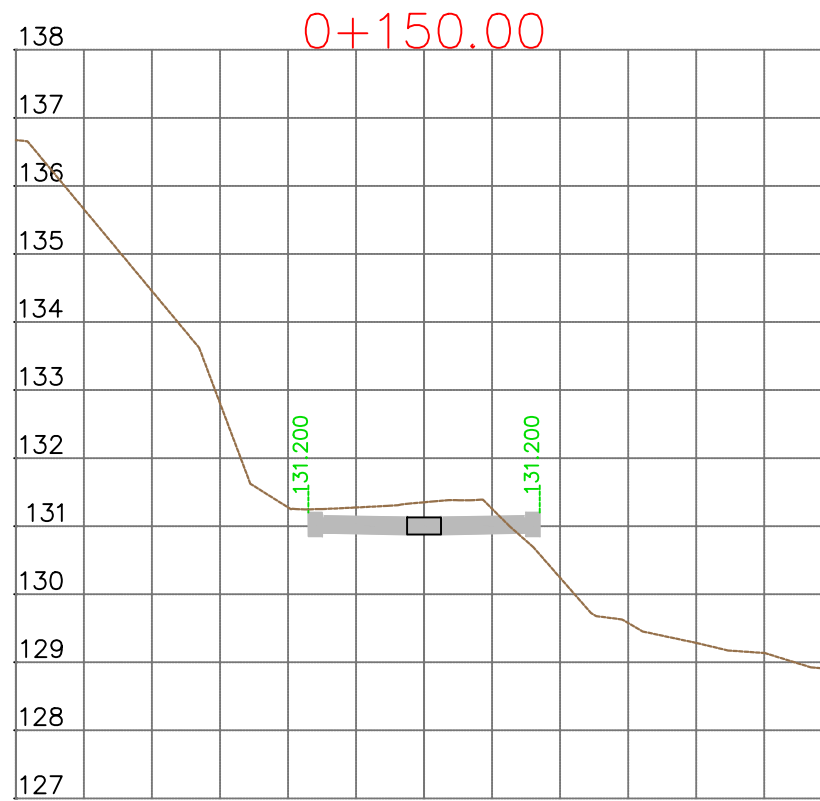

REPUBLIKA E SHQIPËRISË
BASHKIA E TIRANËS

OBJEKTI: "RIKUALIFIKIMI URBAN I ZONËS
INFORMALE QË KUFIZOHET NGA RRUGËT
-SABAUDIN GABRANI -JONUZ RAMA-HAMDI
CULLHAJ-DAMIAN HIMARIOTI-BARI
ISHKA-VASFI SAMIMI-ALUSH ELMAZ TAKA."

Projektoi :

Ing.A.JAKOVA
Ing.G.ISLAMI
Ing.S.MYRSELI
Ing.P.SHKURTI

Ark.M.DADO
Ing.Gjeol.Xh.KASMI
Ing.Mjedis.E.CALI
Top.A.BECECI

Projektoi :

"S&L STUDIO SH.P.K"

Projektim-kupervizion-cosnulence



FAZA

DORËZIM

PROJEKT ZBATIMI

1.0

PROFILE TËRTHORE
RRUGA RR.KROI BANES

SHKALLA 1:100

Nr. I FLETËS 002

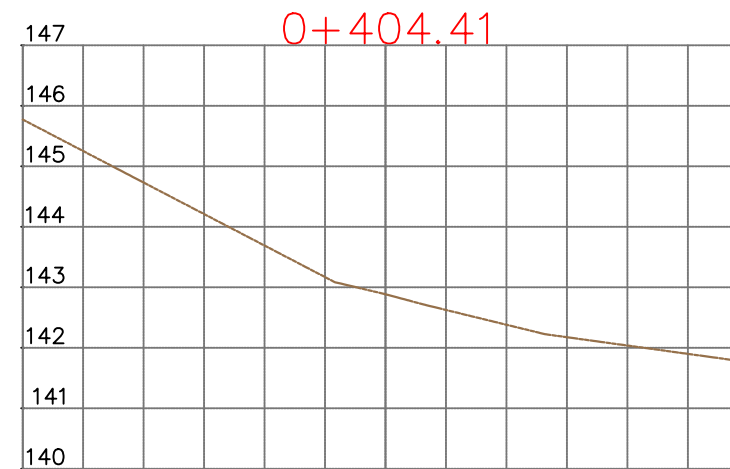
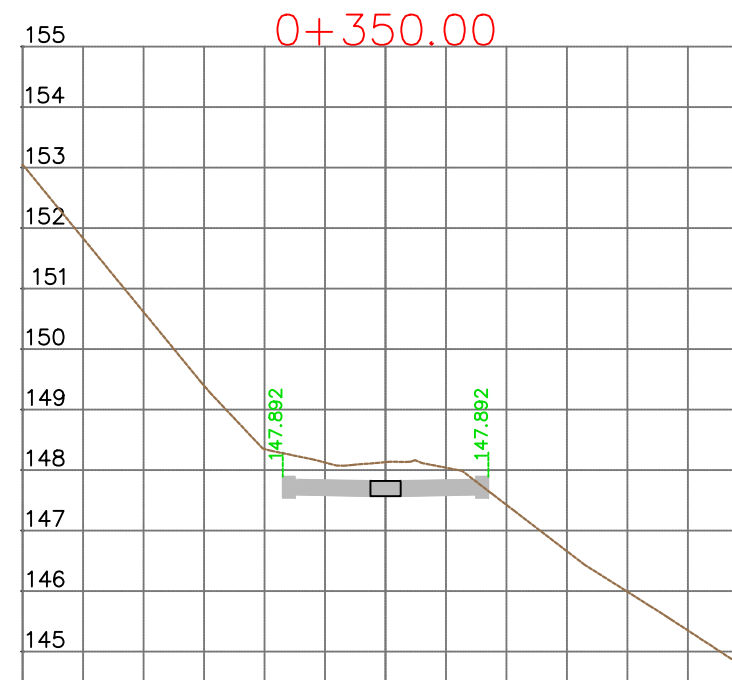
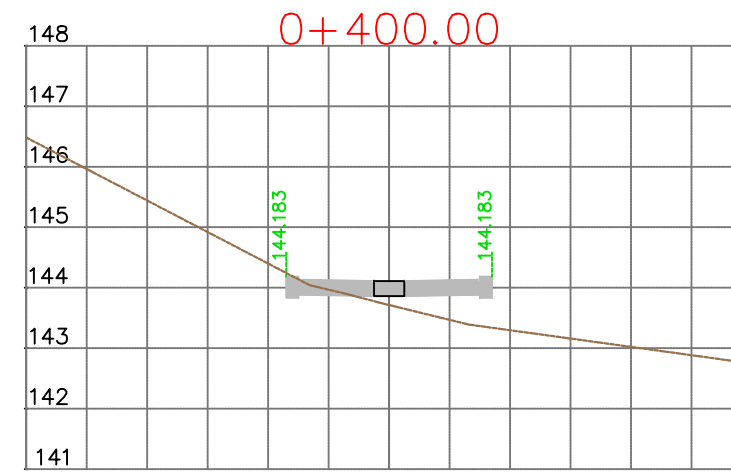
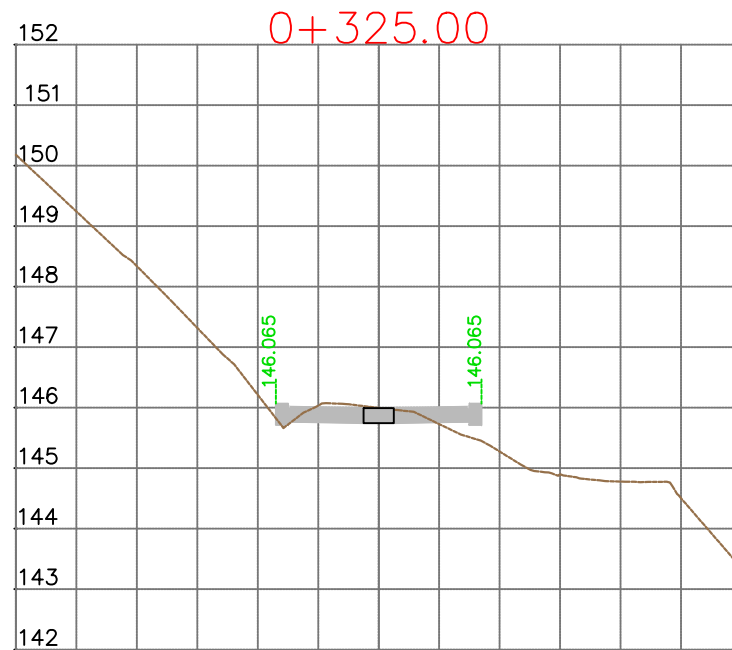
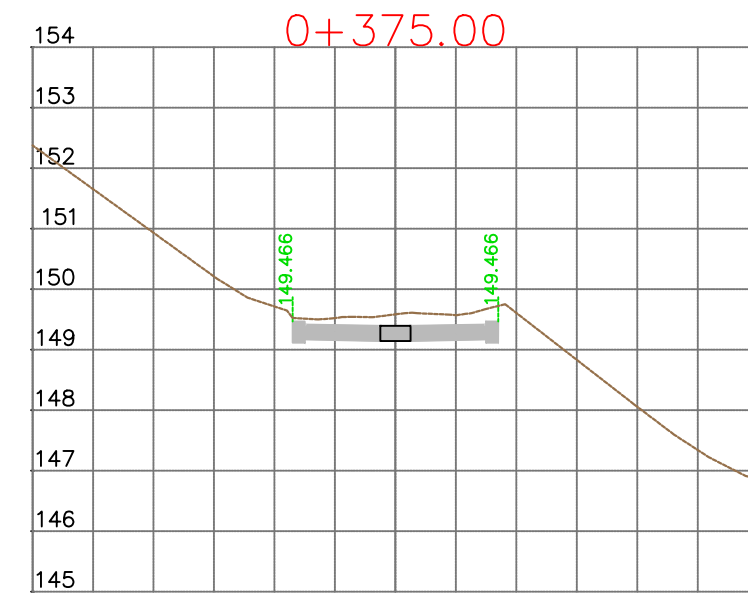
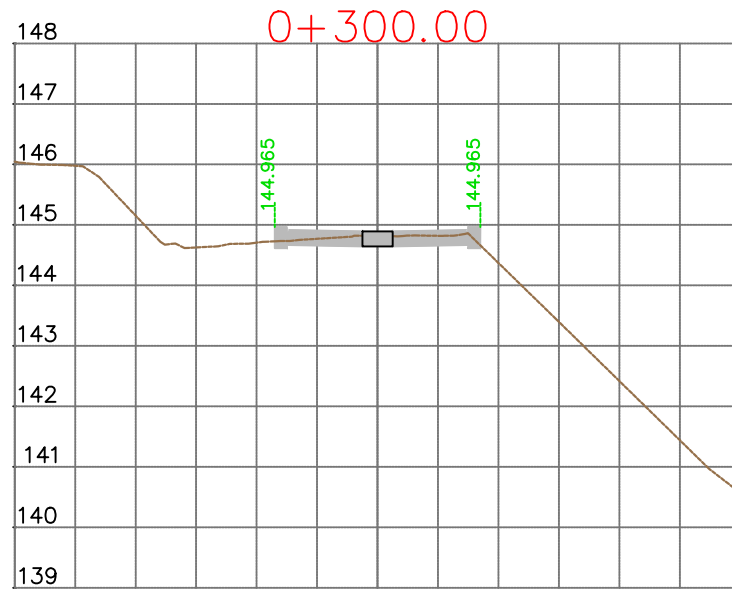

REPUBLIKA E SHQIPËRISË
BASHKIA E TIRANËS

OBJEKTI: "RIKUALIFIKIMI URBAN I ZONËS
INFORMALE QË KUFIZOHET NGA RRUGËT
-SABAUDIN GABRANI -JONUZ RAMA-HAMDI
CULLHAJ-DAMIAN HIMARIOTI-BARI
ISHKA-VASFI SAMIMI-ALUSH ELMAZ TAKA."

Projektoi :

Ing.A.JAKOVA
Ing.G.ISLAMI
Ing.S.MYRSELI
Ing.P.SHKURTI

Ark.M.DADO
Ing.Gjeol.Xh.KASMI
Ing.Mjedis.E.CALI
Top.A.BECECI

Projektoi :

"S&L STUDIO SH.P.K"

Projektim-kupervizion-cosnulence



FAZA

DORËZIM

PROJEKT ZBATIMI

1.0

PROFILE TËRTHORE
RRUGA RR.KROI BANES

SHKALLA 1:100

Nr. I FLETËS 003

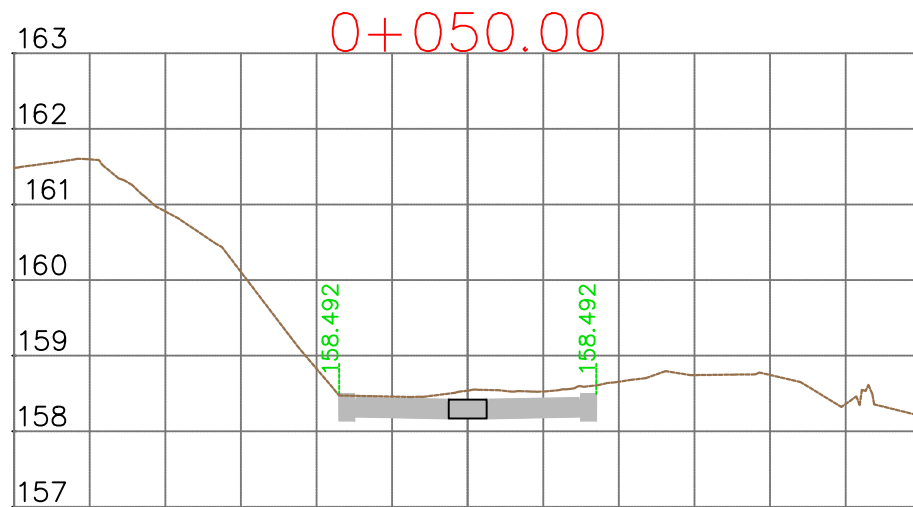
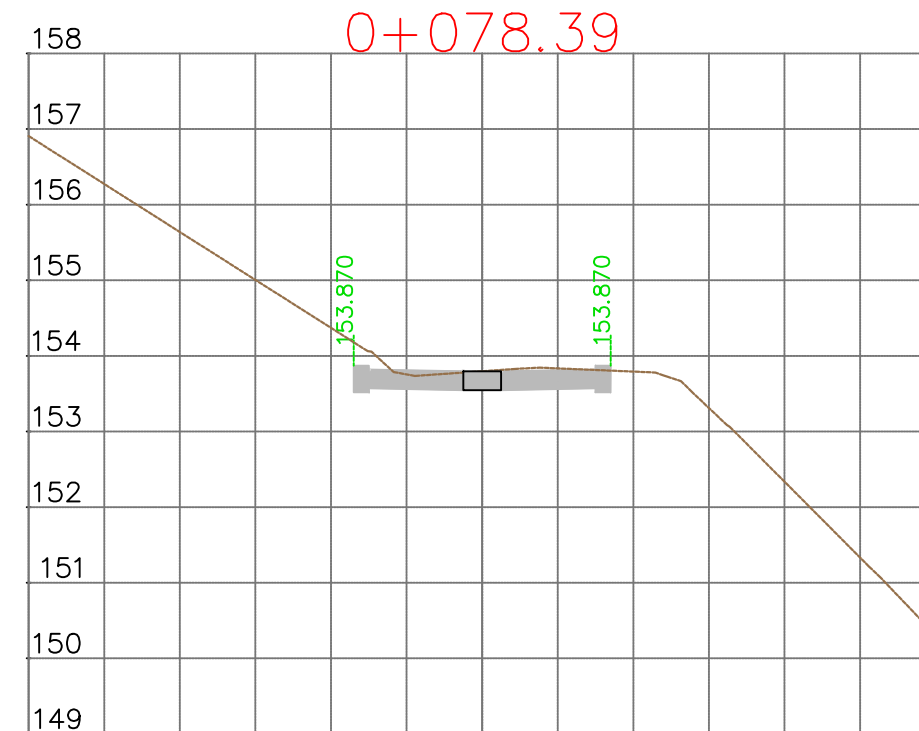
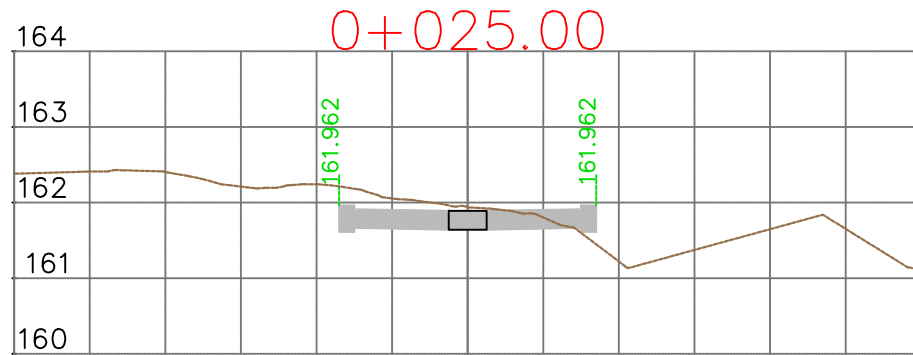
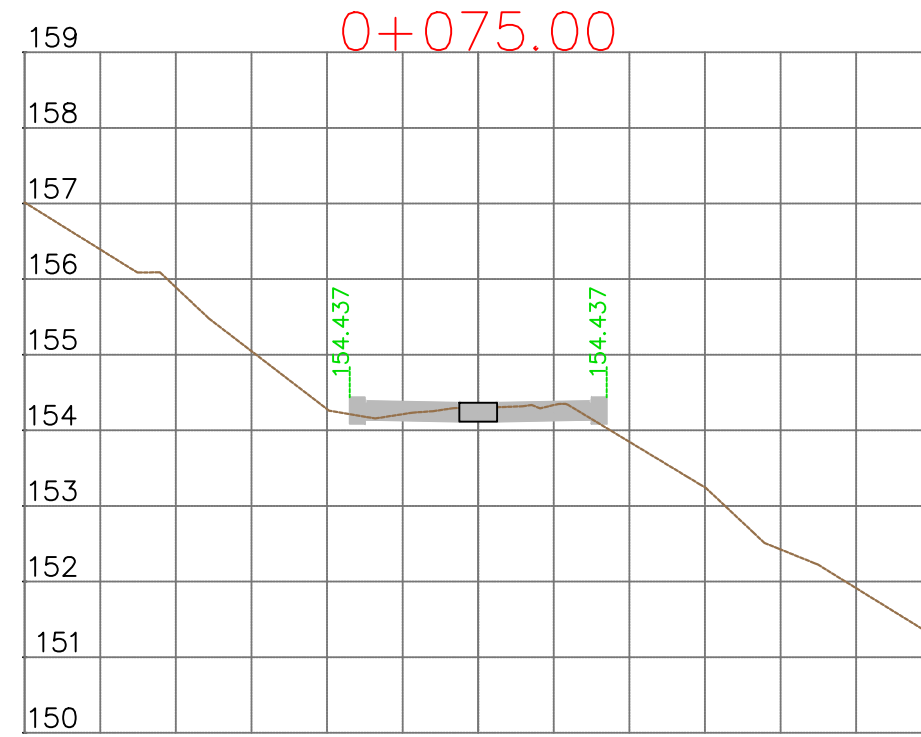
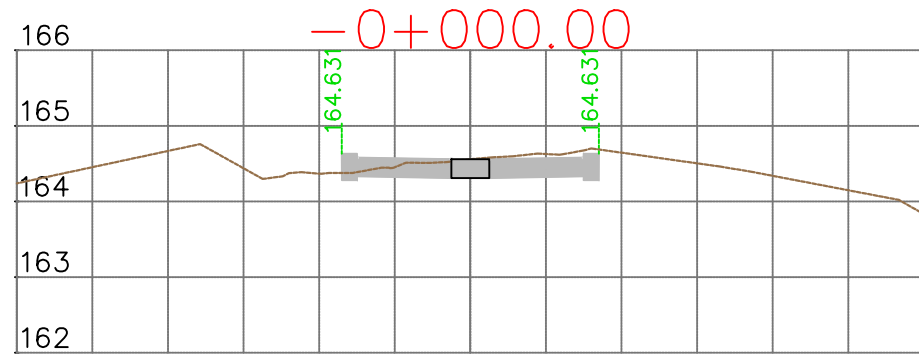

REPUBLIKA E SHQIPËRISË
BASHKIA E TIRANËS

OBJEKTI: "RIKUALIFIKIMI URBAN I ZONËS
INFORMALE QË KUFIZOHET NGA RRUGËT
-SABAUDIN GABRANI -JONUZ RAMA-HAMDI
CULLHAJ-DAMIAN HIMARIOTI-BARI
ISHKA-VASFI SAMIMI-ALUSH ELMAZ TAKA."

Projektoi :

Ing.A.JAKOVA
Ing.G.ISLAMI
Ing.S.MYRSELI
Ing.P.SHKURTI

Ark.M.DADO
Ing.Gjeol.Xh.KASMI
Ing.Mjedis.E.CALI
Top.A.BECECI

Projektoi :

"S&L STUDIO SH.P.K"

Projektim-kupervizion-cosnulence



FAZA

DORËZIM

PROJEKT ZBATIMI

1.0

PROFILE TËRTHORE
RRUGA RR.KROI BANES

SHKALLA 1:100

Nr. I FLETËS 004

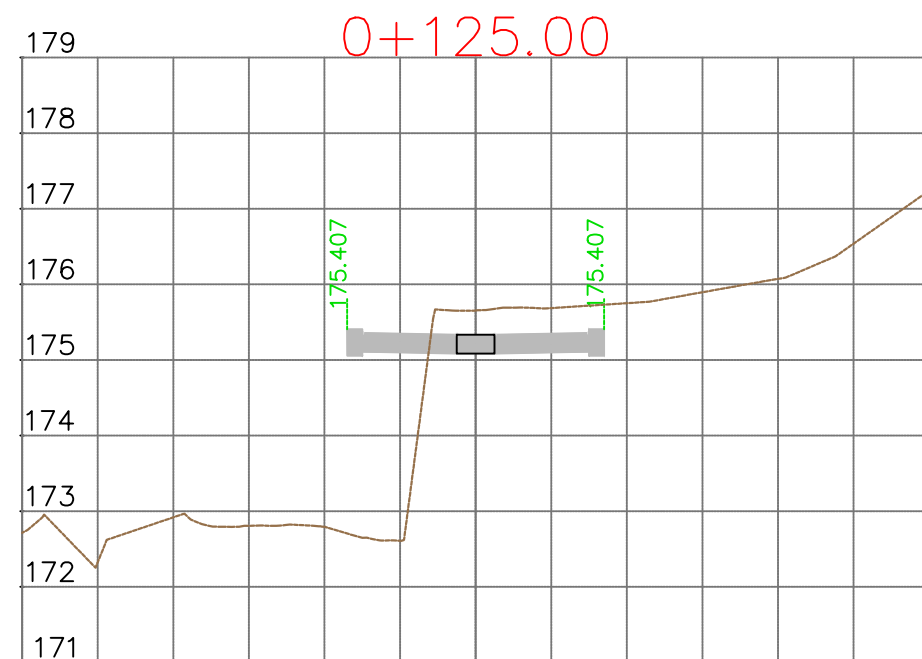
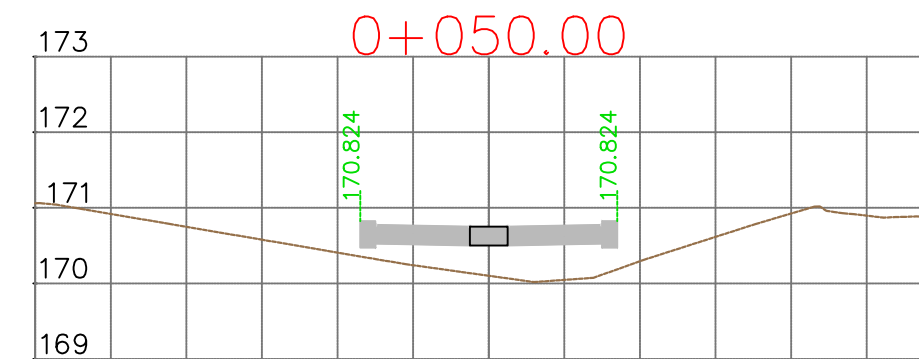
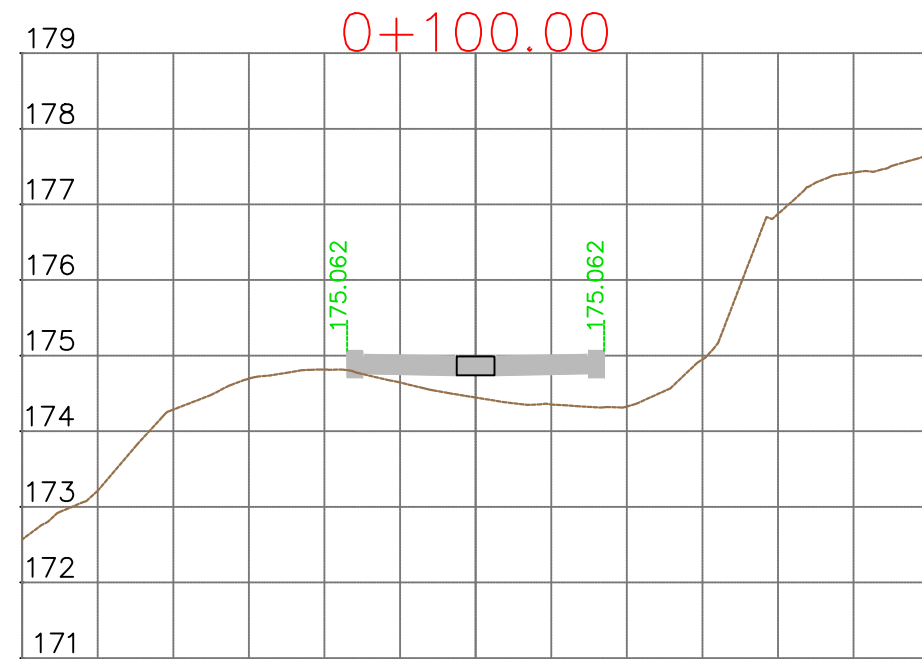
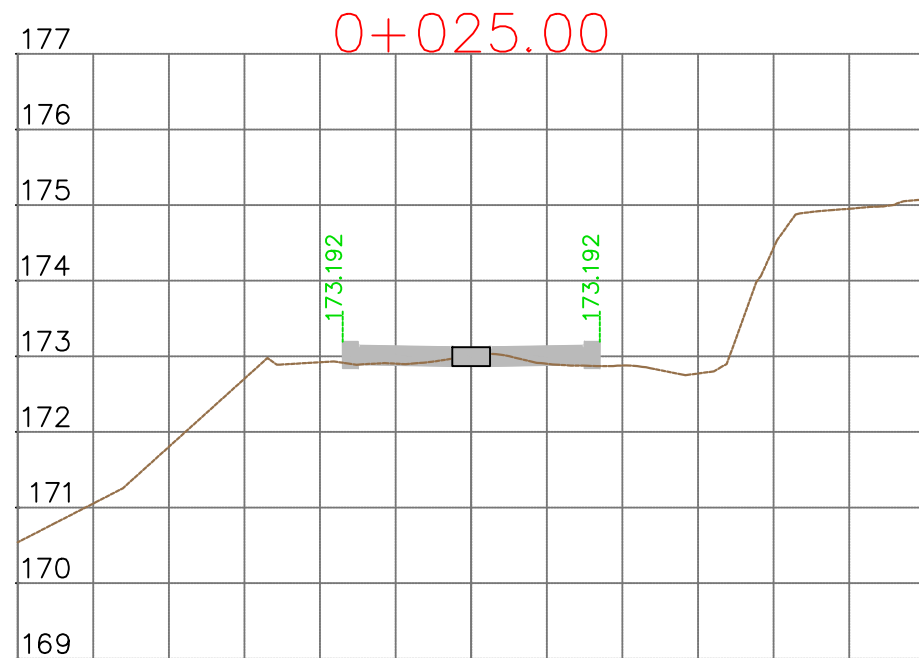
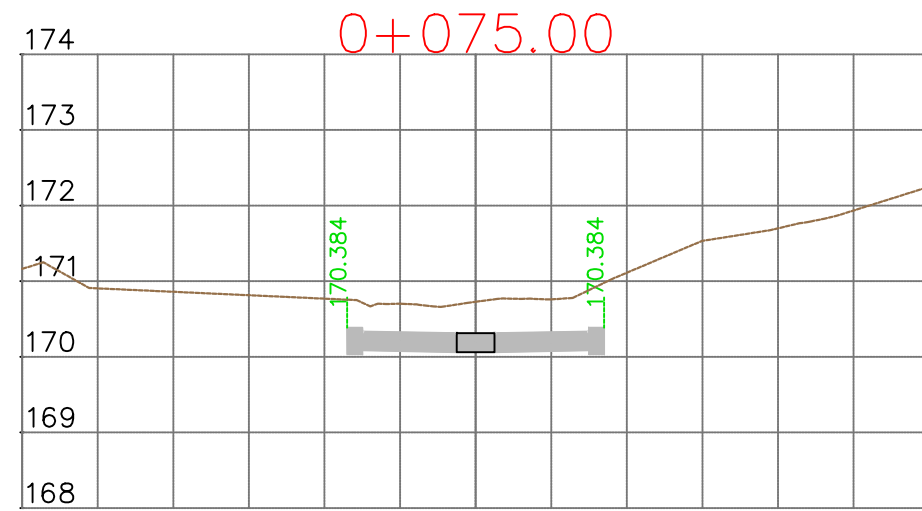
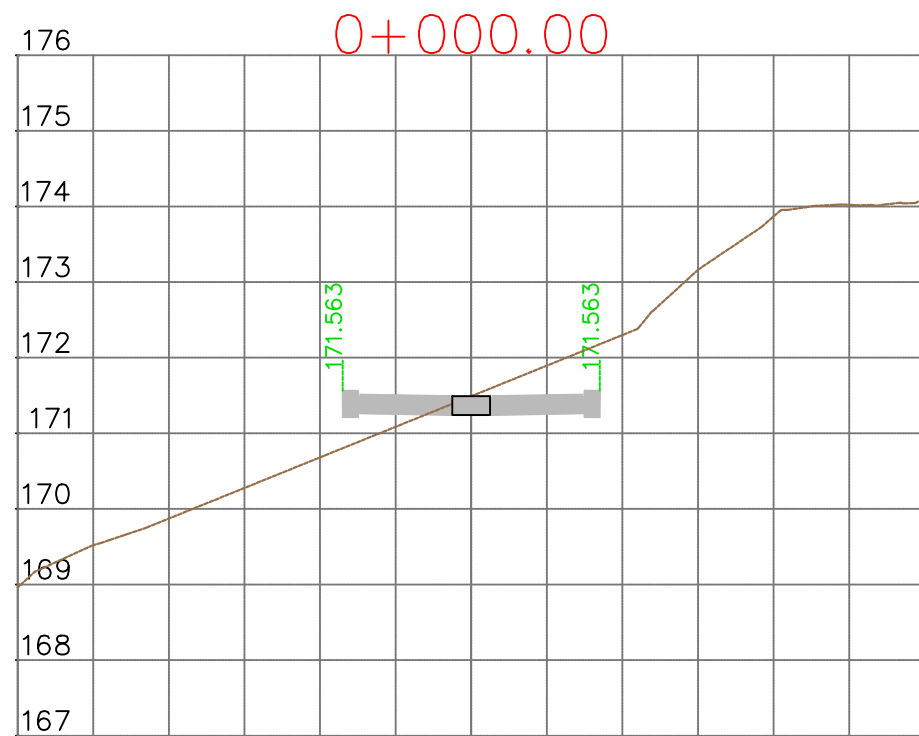

REPUBLIKA E SHQIPËRISË
BASHKIA E TIRANËS

OBJEKTI: "RIKUALIFIKIMI URBAN I ZONËS
INFORMALE QË KUFIZOHET NGA RRUGËT
-SABAUDIN GABRANI -JONUZ RAMA-HAMDI
CULLHAJ-DAMIAN HIMARIOTI-BARI
ISHKA-VASFI SAMIMI-ALUSH ELMMAZ TAKA."

Projektoi :

Ing.A.JAKOVA
Ing.G.ISLAMI
Ing.S.MYRSELI
Ing.P.SHKURTI

Ark.M.DADO
Ing.Gjeol.Xh.KASMI
Ing.Mjedis.E.CALI
Top.A.BECECI

Projektoi :

"S&L STUDIO SH.P.K"

Projektim-kupervizion-cosnulence



FAZA

DORËZIM

PROJEKT ZBATIMI

1.0

PROFILE TËRTHORE
RRUGA RR.KROI BANES

SHKALLA 1:100

Nr. I FLETËS 005

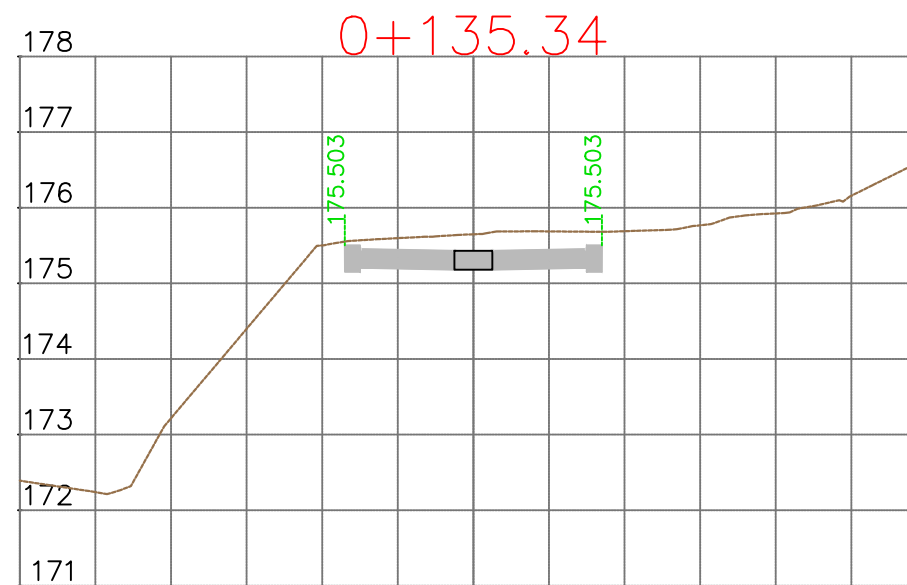

REPUBLIKA E SHQIPËRISË
BASHKIA E TIRANËS

OBJEKTI: "RIKUALIFIKIMI URBAN I ZONËS
INFORMALE QË KUFIZOHET NGA RRUGËT
-SABAUDIN GABRANI -JONUZ RAMA-HAMDI
CULLHAJ-DAMIAN HIMARIOTI-BARI
ISHKA-VASFI SAMIMI-ALUSH ELMAZ TAKA."

Projektoi :

Ing.A.JAKOVA
Ing.G.ISLAMI
Ing.S.MYRSELI
Ing.P.SHKURTI

Ark.M.DADO
Ing.Gjeol.Xh.KASMI
Ing.Mjedis.E.CALI
Top.A.BECECI

Projektoi :
"S&L STUDIO SH.P.K"

Projektim-kupervizion-cosnulence



FAZA

DORËZIM

PROJEKT ZBATIMI

1.0

PROFILE TËRTHORE
RRUGA RR.KROI BANES

SHKALLA 1:100

Nr. I FLETËS 006

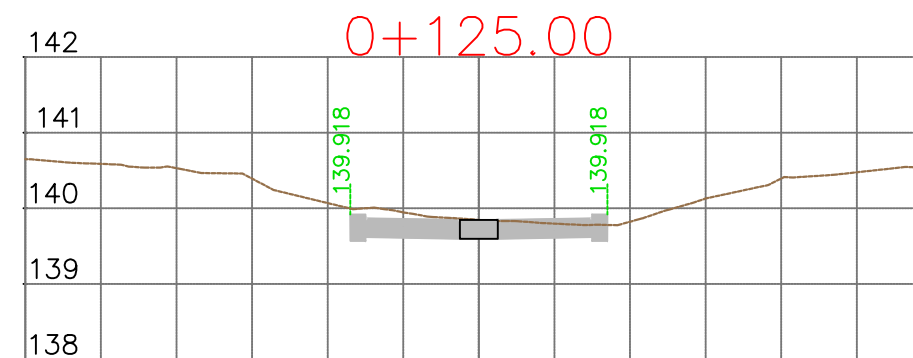
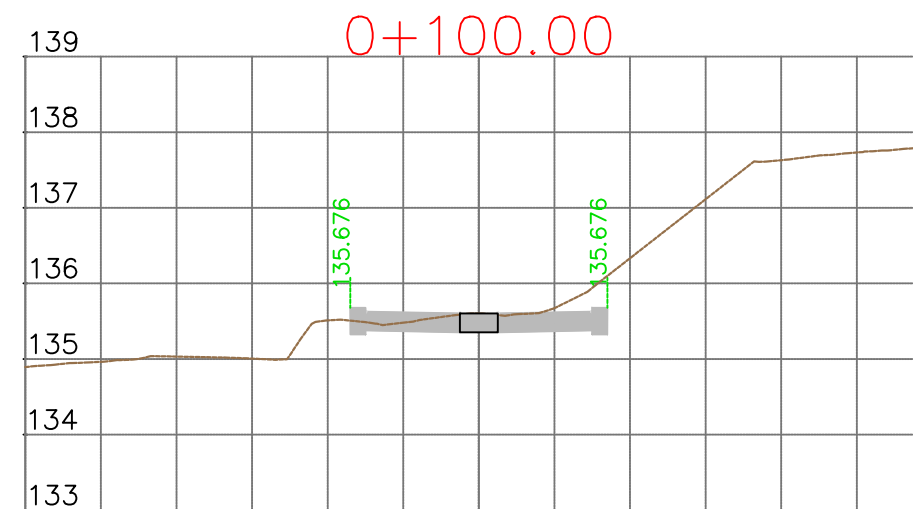
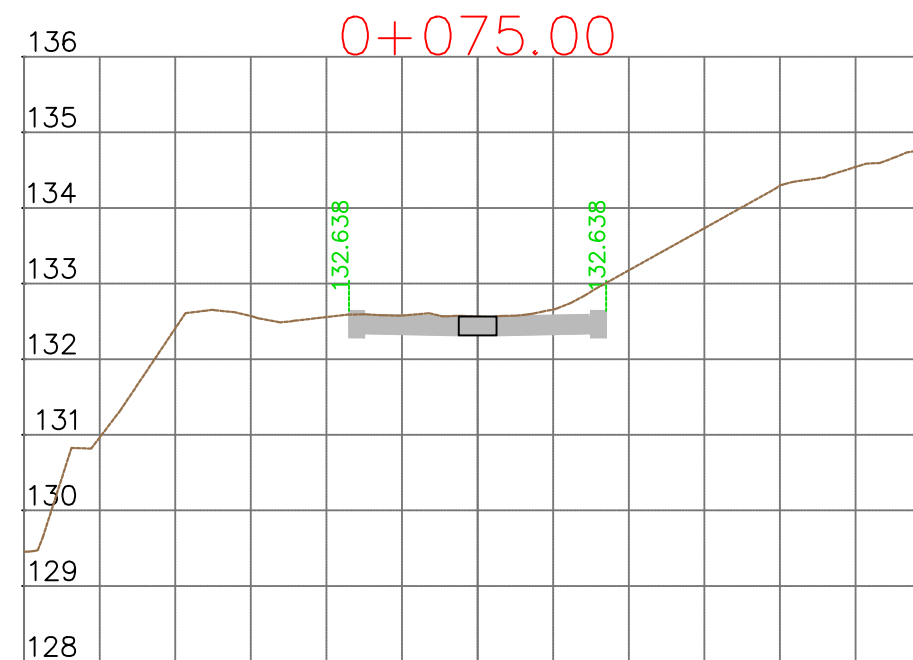
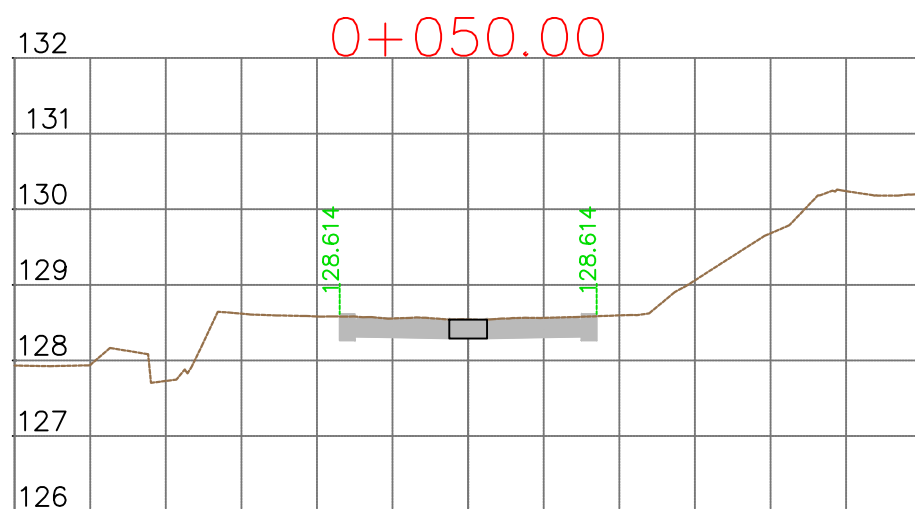
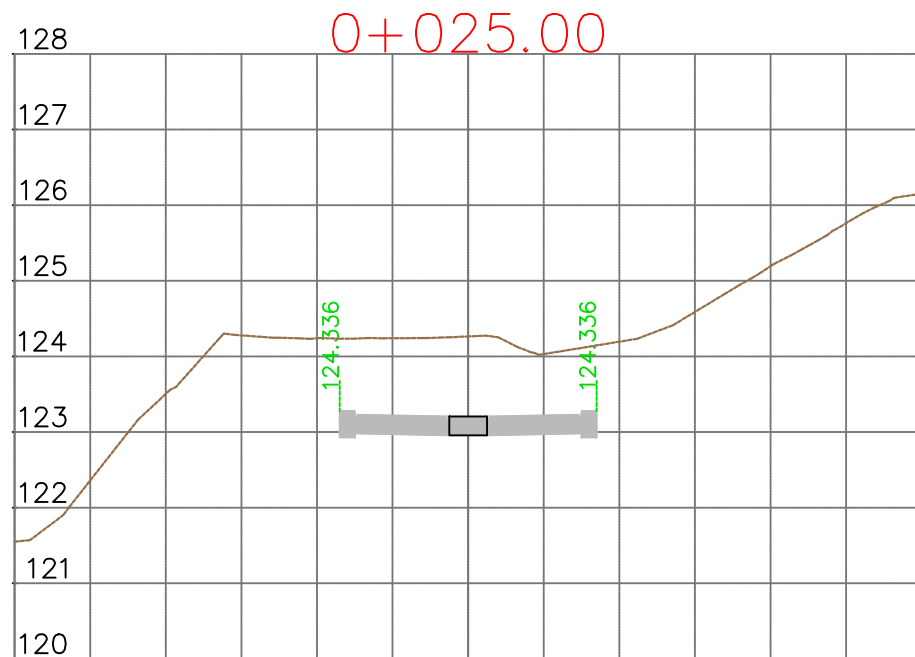
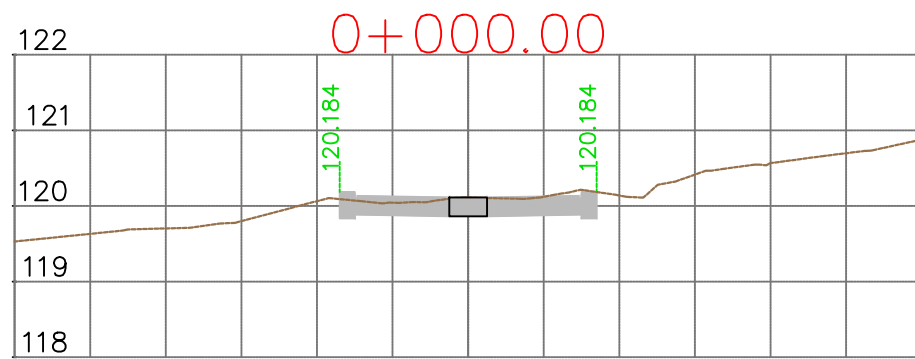

REPUBLIKA E SHQIPËRISË
BASHKIA E TIRANËS

OBJEKTI: "RIKUALIFIKIMI URBAN I ZONËS
INFORMALE QË KUFIZOHET NGA RRUGËT
-SABAUDIN GABRANI -JONUZ RAMA-HAMDI
CULLHAJ-DAMIAN HIMARIOTI-BARI
ISHKA-VASFI SAMIMI-ALUSH ELMAZ TAKA."

Projektoi :

Ing.A.JAKOVA
Ing.G.ISLAMI
Ing.S.MYRSELI
Ing.P.SHKURTI

Ark.M.DADO
Ing.Gjeol.Xh.KASMI
Ing.Mjedis.E.CALI
Top.A.BECECI

Projektoi :

"S&L STUDIO SH.P.K"

Projektim-kupervizion-cosnulence



FAZA

DORËZIM

PROJEKT ZBATIMI

1.0

PROFILE TËRTHORE
RRUGA RR.BAHRRI ISHKA

SHKALLA 1:100

Nr. I FLETËS 001

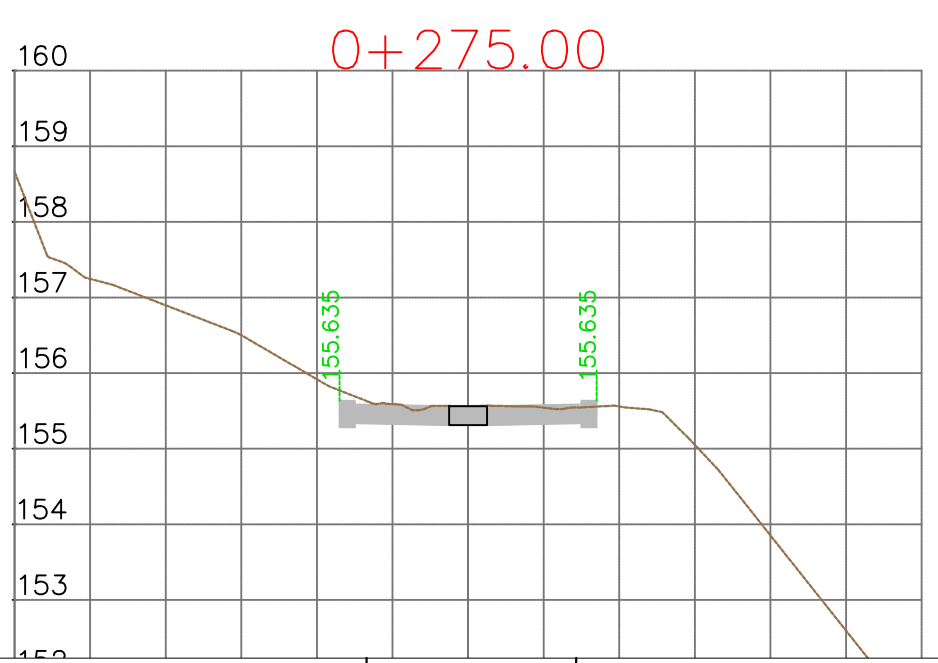
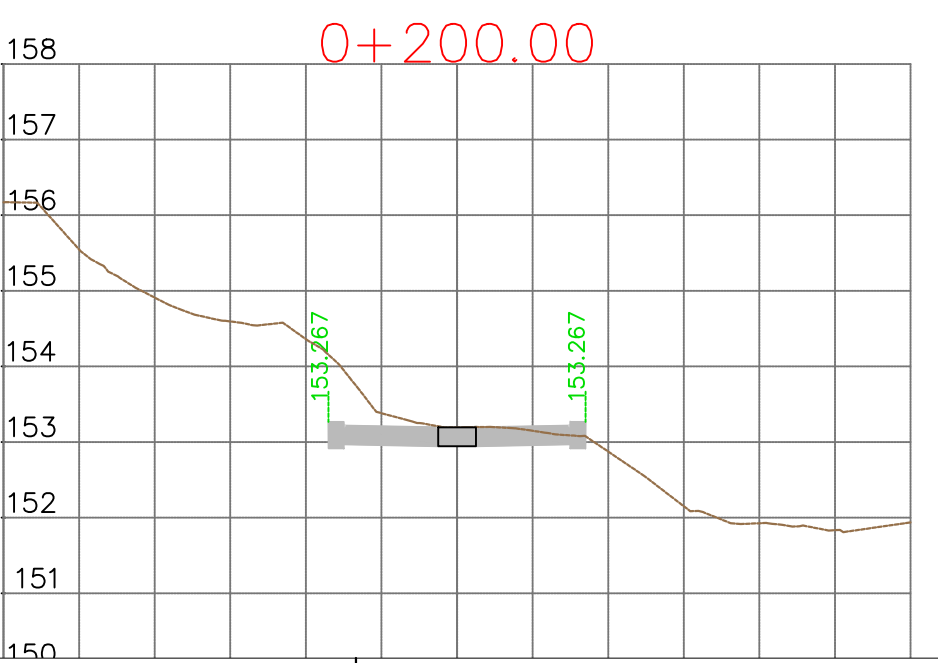
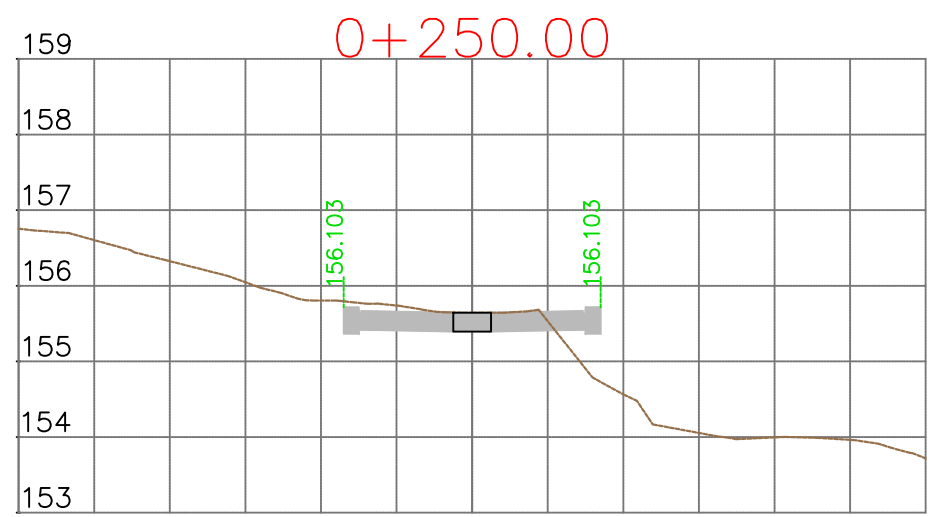
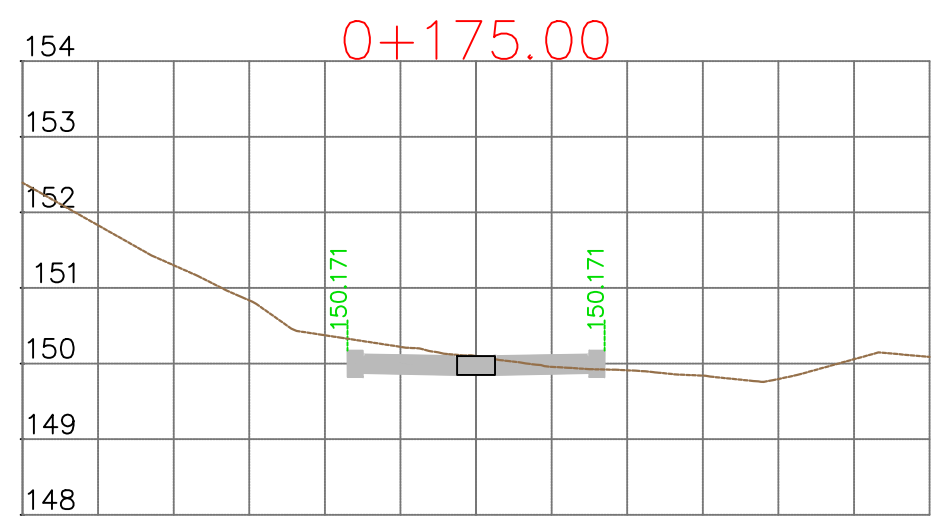
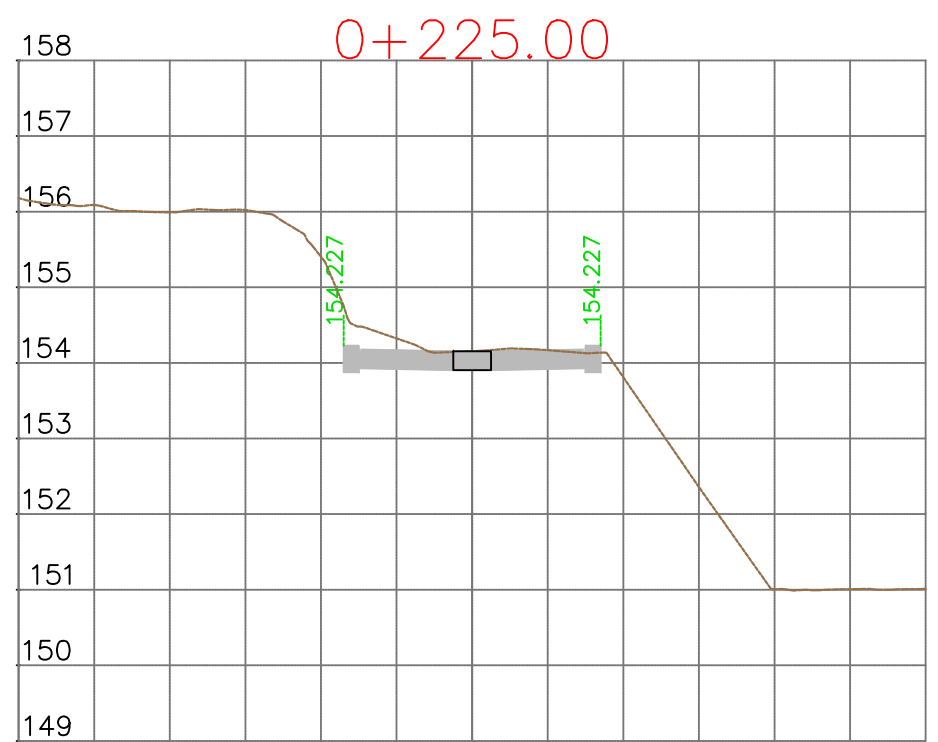
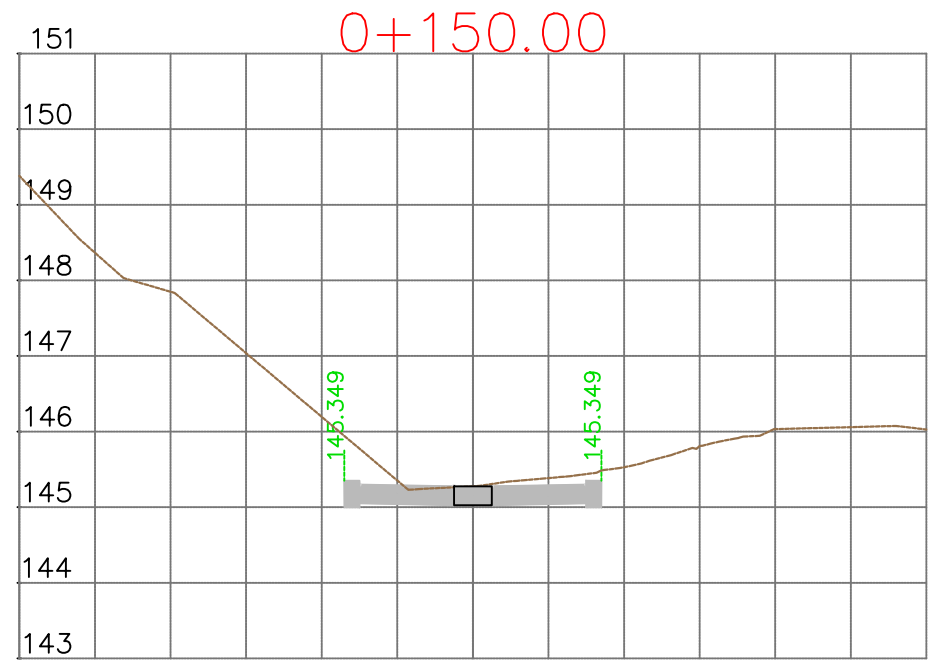

OBJEKTI: "RIKUALIFIKIMI URBAN I ZONËS INFORMALE QË KUFIZOHET NGA RRUGËT -SABAUDIN GABRANI -JONUZ RAMA-HAMDI CULLHAJ-DAMIAN HIMARIOTI-BARI ISHKA-VASFI SAMIMI-ALUSH ELMAZ TAKA."

Projektoi :
Ing.A.JAKOVA
Ing.G.ISLAMI
Ing.S.MYRSELI
Ing.P.SHKURTI
Ark.M.DADO
Ing.Gjeol.Xh.KASMI
Ing.Mjedis.E.CALI
Top.A.BECECI

Projektoi :
"S&L STUDIO SH.P.K"
Projektim-kupervizion-cosnulence
R A I D - G
PROJEKTIM DESIGN
SUPERVISION KOLAUDIM

FAZA
DORËZIM

PROJEKT ZBATIMI
1.0

PROFILE TËRTHORE
RRUGA RR.BAHRRI ISHKA
SHKALLA 1:100
Nr. I FLETËS 002

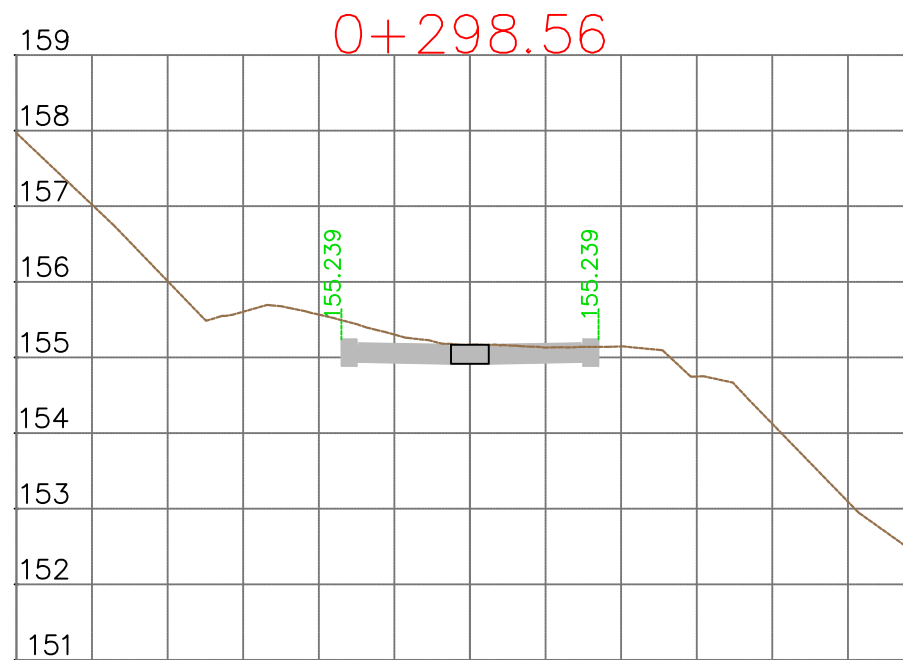

REPUBLIKA E SHQIPËRISË
BASHKIA E TIRANËS

OBJEKTI: "RIKUALIFIKIMI URBAN I ZONËS
INFORMALE QË KUFIZOHET NGA RRUGËT
-SABAUDIN GABRANI -JONUZ RAMA-HAMDI
CULLHAJ-DAMIAN HIMARIOTI-BARI
ISHKA-VASFI SAMIMI-ALUSH ELMAZ TAKA."

Projektoi :

Ing.A.JAKOVA
Ing.G.ISLAMI
Ing.S.MYRSELI
Ing.P.SHKURTI

Ark.M.DADO
Ing.Gjeol.Xh.KASMI
Ing.Mjedis.E.CALI
Top.A.BECECI

Projektoi :
"S&L STUDIO SH.P.K"

Projektim-kupervizion-cosnulence



FAZA

DORËZIM

PROJEKT ZBATIMI

1.0

PROFILE TËRTHORE
RRUGA RR.BAHRI ISHKA

SHKALLA 1:100

Nr. I FLETËS 003

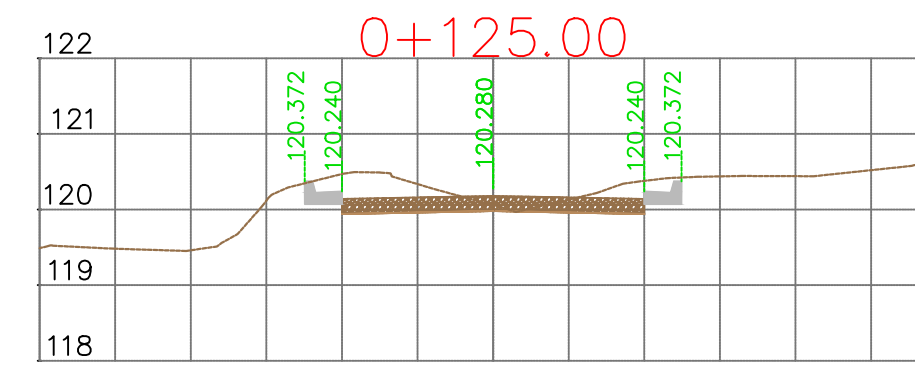
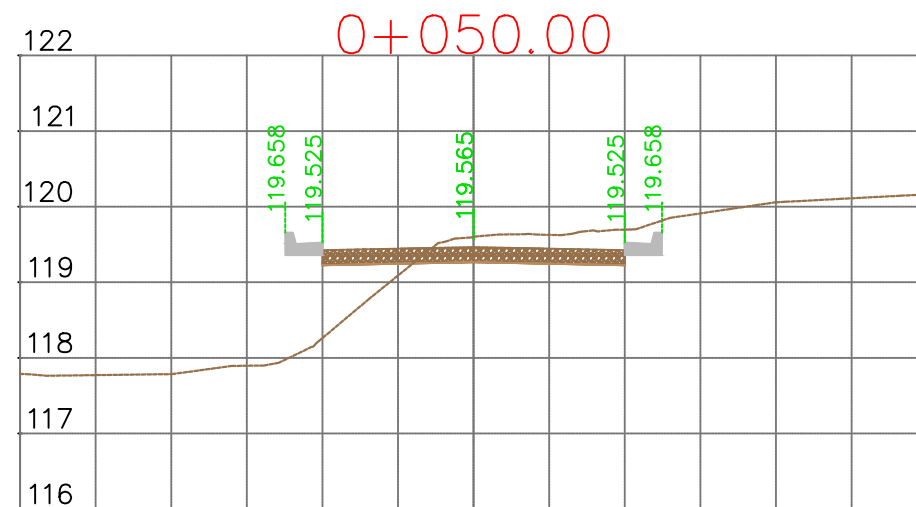
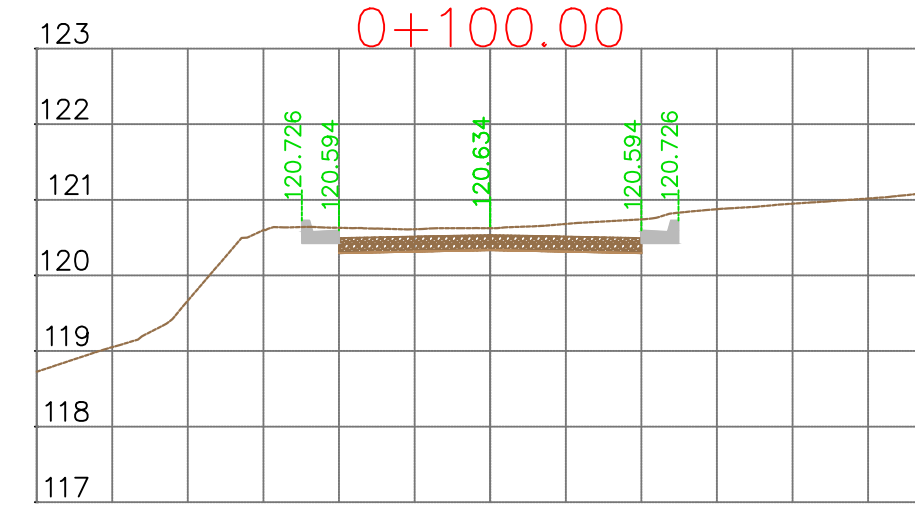
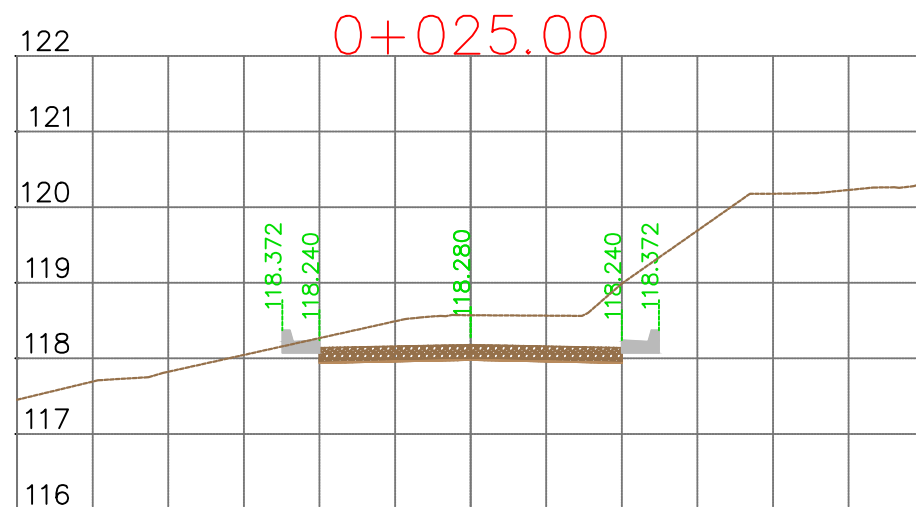
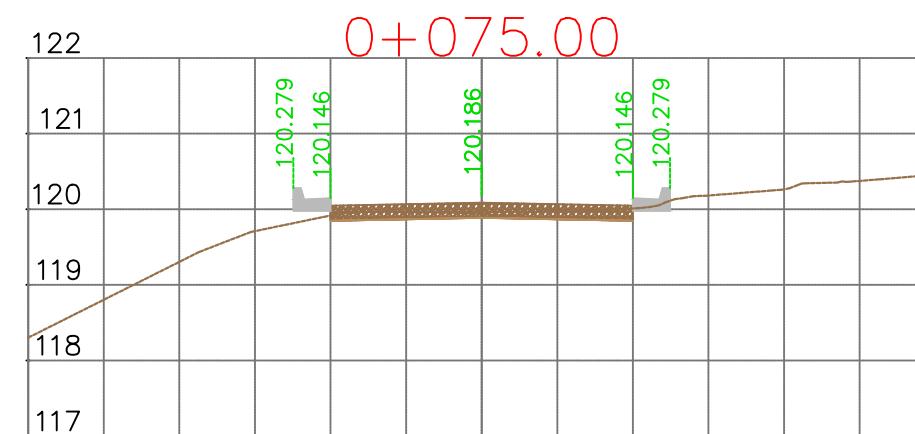
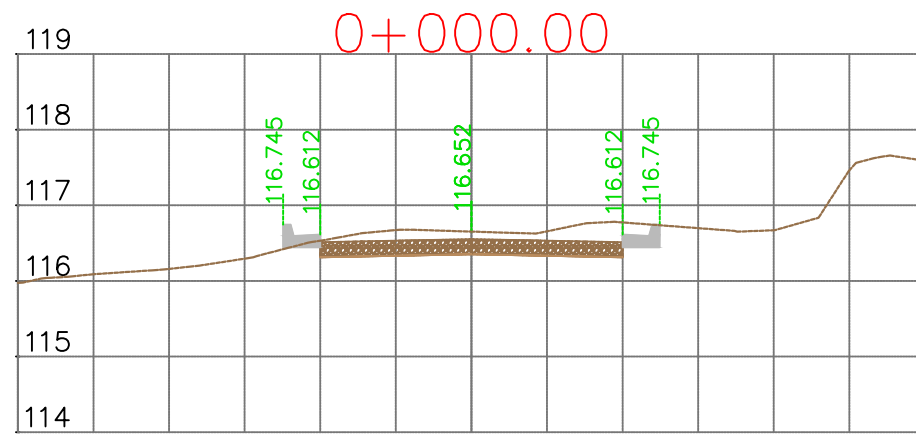

REPUBLIKA E SHQIPËRISË
BASHKIA E TIRANËS

OBJEKTI: "RIKUALIFIKIMI URBAN I ZONËS INFORMALE QË KUFIZOHET NGA RRUGËT -SABAUDIN GABRANI -JONUZ RAMA-HAMDI CULLHAJ-DAMIAN HIMARIOTI-BARI ISHKA-VASFI SAMIMI-ALUSH ELMAZ TAKA."

Projektoi :

Ing.A.JAKOVA
Ing.G.ISLAMI
Ing.S.MYRSELI
Ing.P.SHKURTI

Ark.M.DADO
Ing.Gjeol.Xh.KASMI
Ing.Mjedis.E.CALI
Top.A.BECECI

Projektoi :

"S&L STUDIO SH.P.K"

Projektim-kupervizion-cosnulence



FAZA

DORËZIM

PROJEKT ZBATIMI

1.0

PROFILE TËRTHORE
RRUGA RR.VAFSI SAMIMI

SHKALLA 1:100

Nr. I FLETËS 001

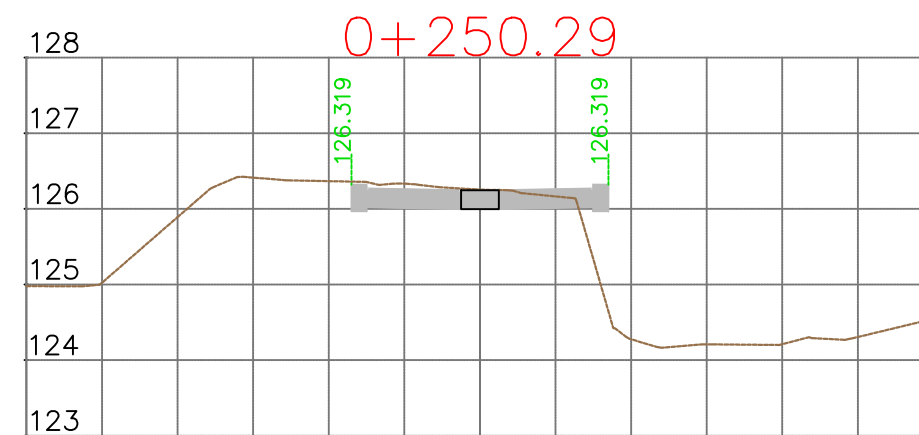
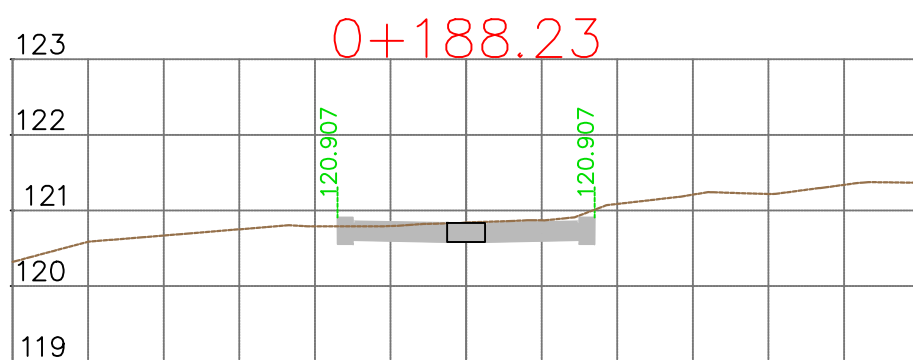
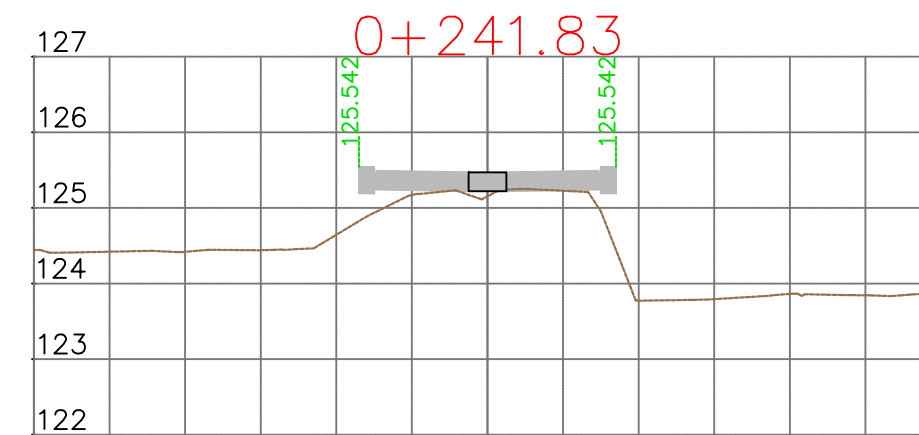
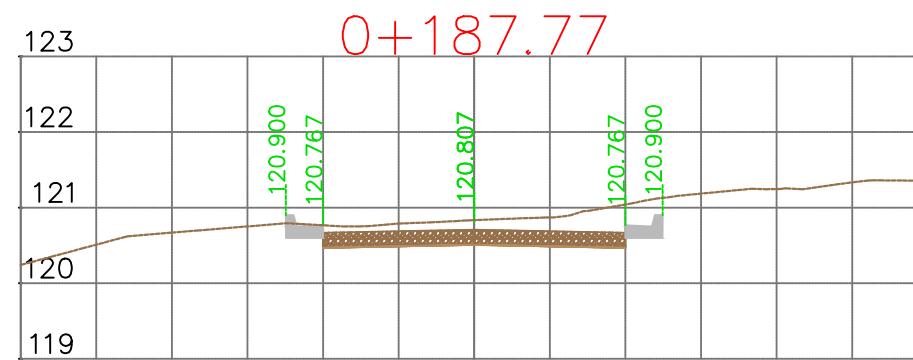
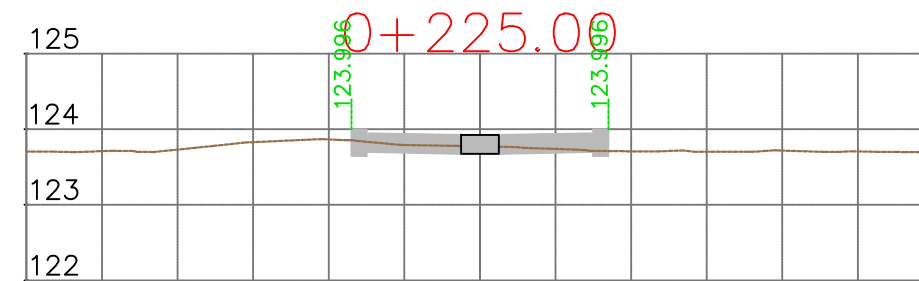
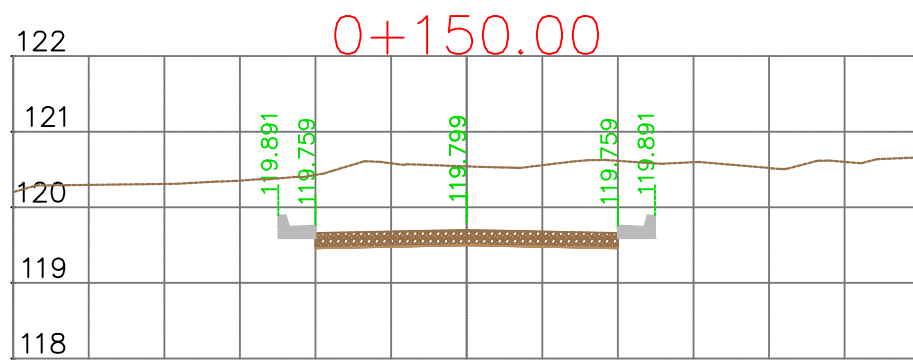

REPUBLIKA E SHQIPËRISË
BASHKIA E TIRANËS

OBJEKTI: "RIKUALIFIKIMI URBAN I ZONËS
INFORMALE QË KUFIZOHET NGA RRUGËT
-SABAUDIN GABRANI -JONUZ RAMA-HAMDI
CULLHAJ-DAMIAN HIMARIOTI-BARI
ISHKA-VASFI SAMIMI-ALUSH ELMAZ TAKA."

Projektoi :

Ing.A.JAKOVA
Ing.G.ISLAMI
Ing.S.MYRSELI
Ing.P.SHKURTI

Ark.M.DADO
Ing.Gjeol.Xh.KASMI
Ing.Mjedis.E.CALI
Top.A.BECECI

Projektoi :
"S&L STUDIO SH.P.K"

Projektim-kupervizion-cosnulence



FAZA

DORËZIM

PROJEKT ZBATIMI

1.0

PROFILE TËRTHORE
RRUGA RR.VAFSI SAMIMI

SHKALLA 1:100

Nr. I FLETËS 002

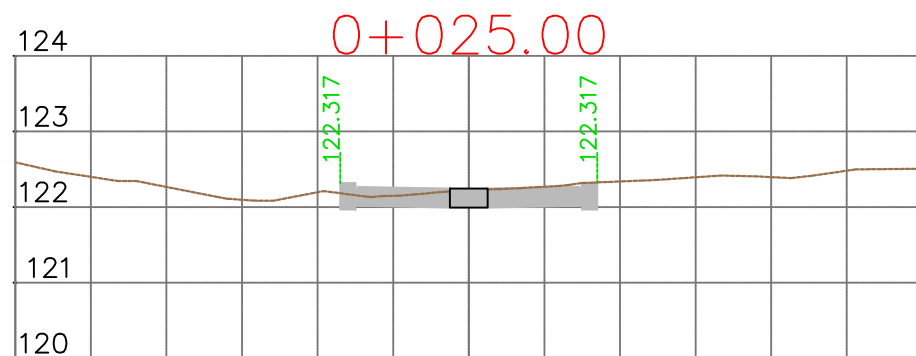
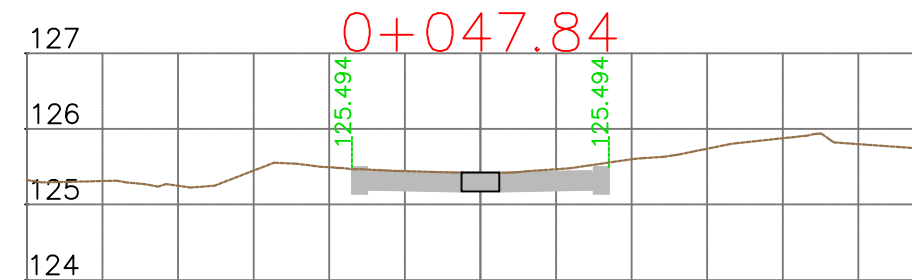
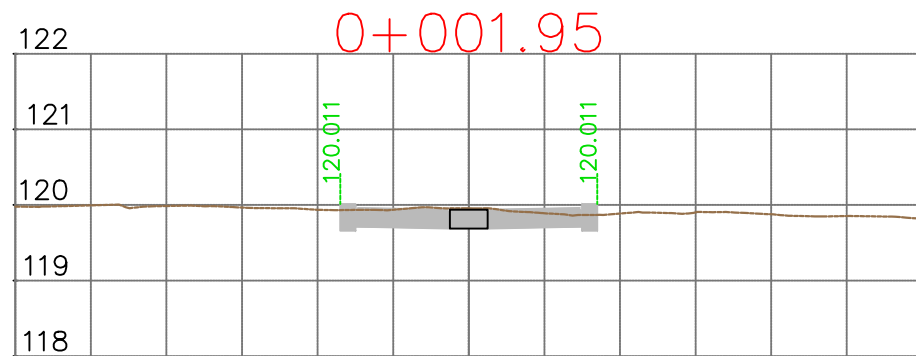

REPUBLIKA E SHQIPËRISË
BASHKIA E TIRANËS

OBJEKTI: "RIKUALIFIKIMI URBAN I ZONËS
INFORMALE QË KUFIZOHET NGA RRUGËT
-SABAUDIN GABRANI -JONUZ RAMA-HAMDI
CULLHAJ-DAMIAN HIMARIOTI-BARI
ISHKA-VASFI SAMIMI-ALUSH ELMAZ TAKA."

Projektoi :

Ing.A.JAKOVA
Ing.G.ISLAMI
Ing.S.MYRSELI
Ing.P.SHKURTI

Ark.M.DADO
Ing.Gjeol.Xh.KASMI
Ing.Mjedis.E.CALI
Top.A.BECECI

Projektoi :
"S&L STUDIO SH.P.K"

Projektim-kupervizion-cosnulence



FAZA

DORËZIM

PROJEKT ZBATIMI

1.0

PROFILE TËRTHORE
RRUGA RR.VAFSI SAMIMI

SHKALLA 1:100

Nr. I FLETËS 003

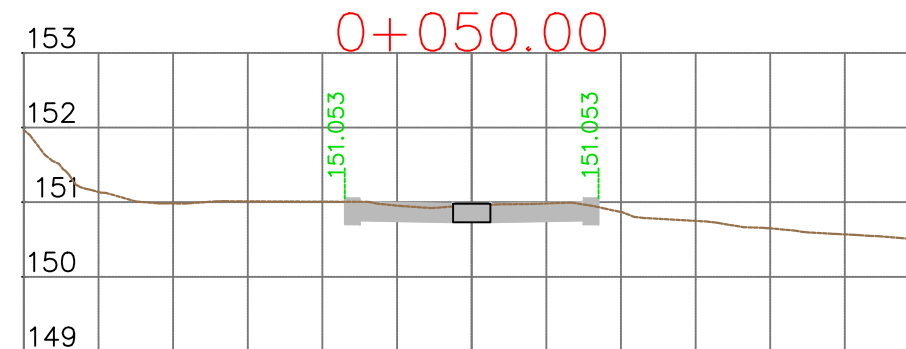
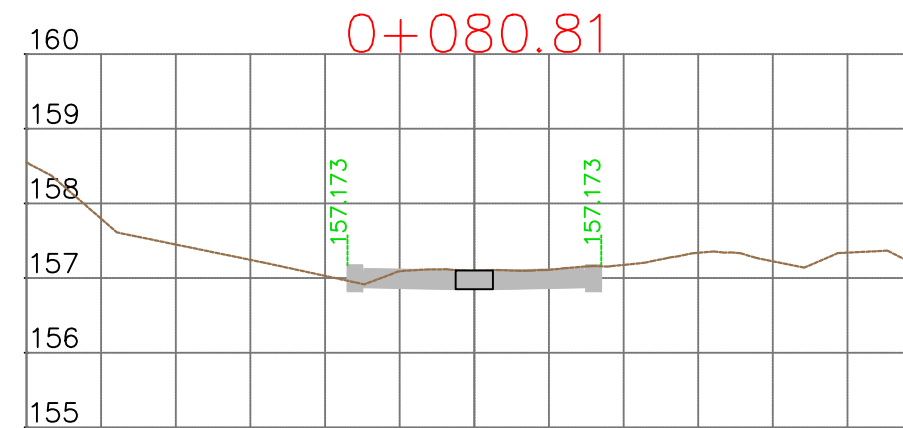
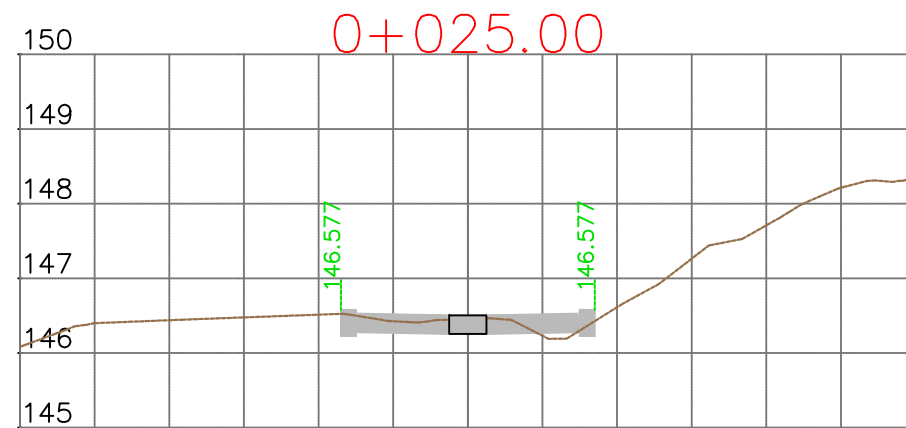
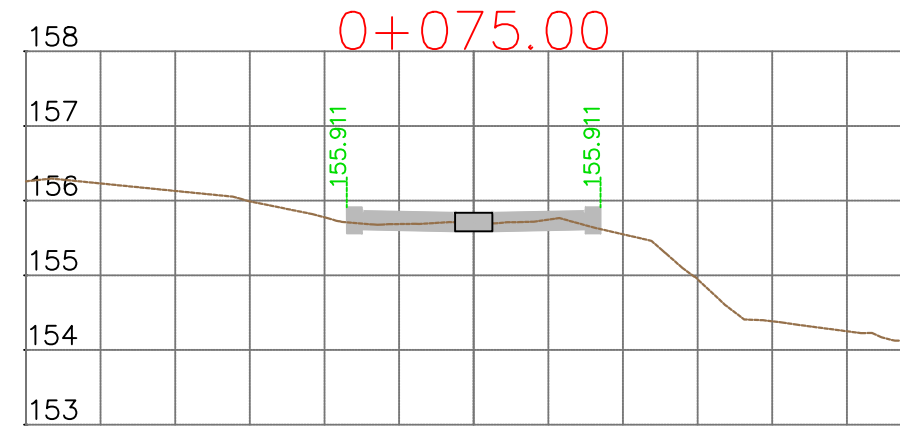
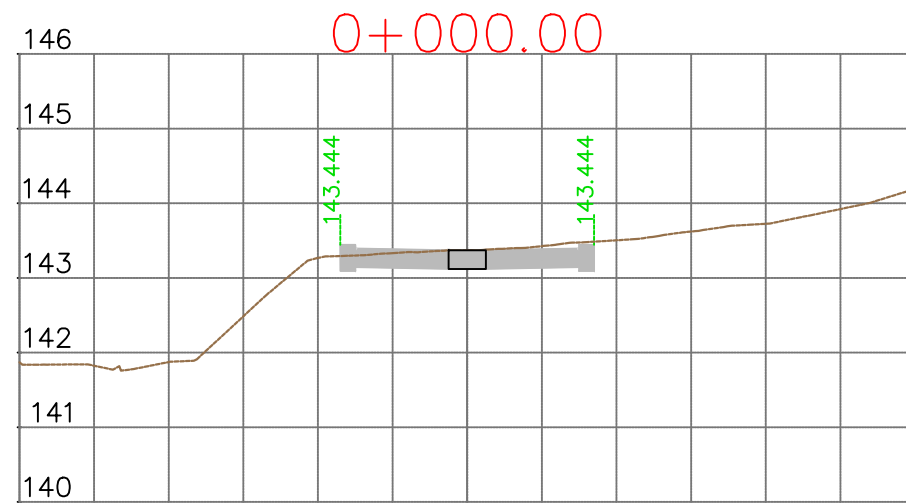

REPUBLIKA E SHQIPËRISË
BASHKIA E TIRANËS

OBJEKTI: "RIKUALIFIKIMI URBAN I ZONËS
INFORMALE QË KUFIZOHET NGA RRUGËT
-SABAUDIN GABRANI -JONUZ RAMA-HAMDI
CULLHAJ-DAMIAN HIMARIOTI-BARI
ISHKA-VASFI SAMIMI-ALUSH ELMAZ TAKA."

Projektoi :

Ing.A.JAKOVA
Ing.G.ISLAMI
Ing.S.MYRSELI
Ing.P.SHKURTI

Ark.M.DADO
Ing.Gjeol.Xh.KASMI
Ing.Mjedis.E.CALI
Top.A.BECECI

Projektoi :

"S&L STUDIO SH.P.K"

Projektim-kupervizion-cosnulence



FAZA

DORËZIM

PROJEKT ZBATIMI

1.0

PROFILE TËRTHORE
RRUGA RR.SABAUDIN GABRANI

SHKALLA 1:100

Nr. I FLETËS 001

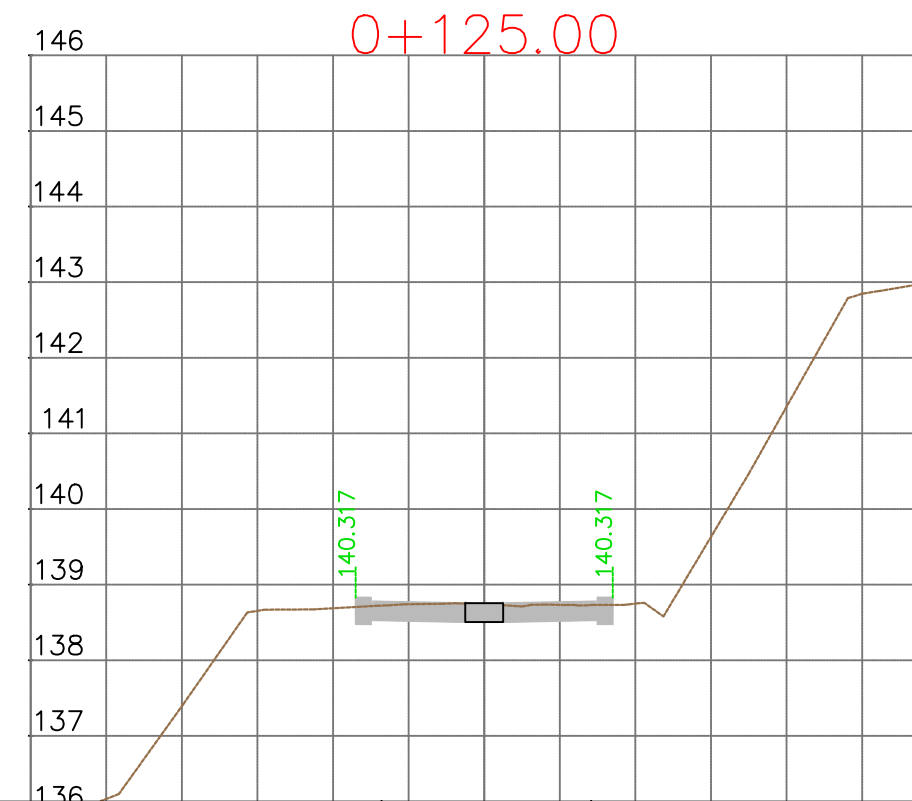
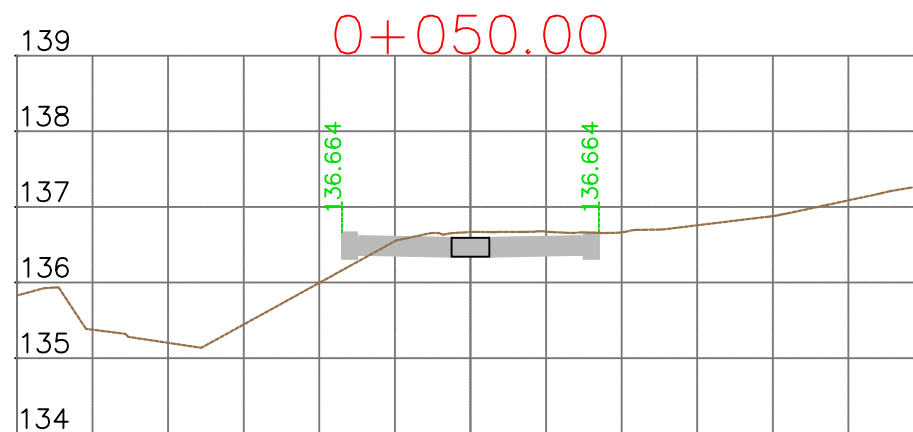
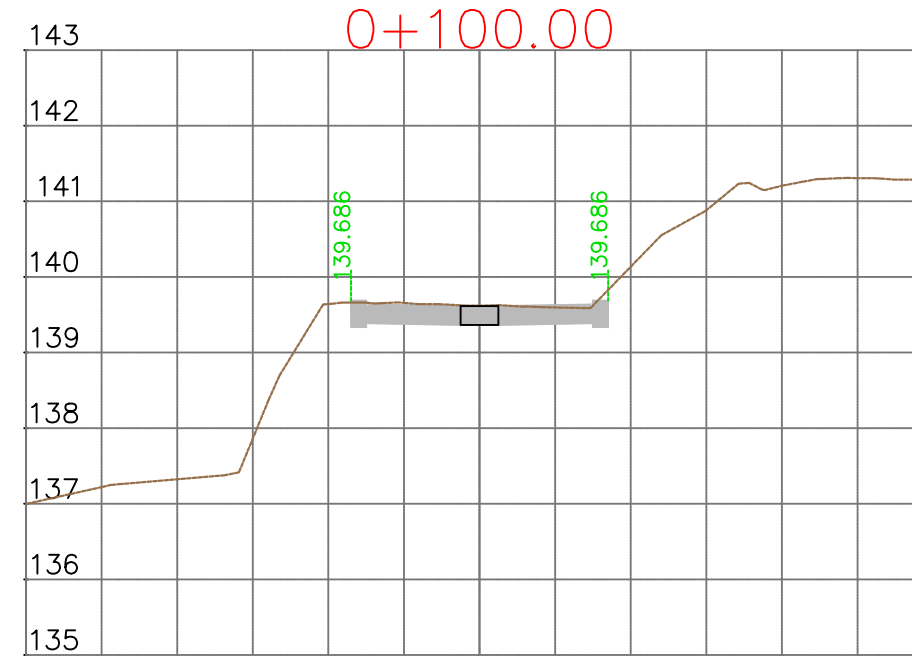
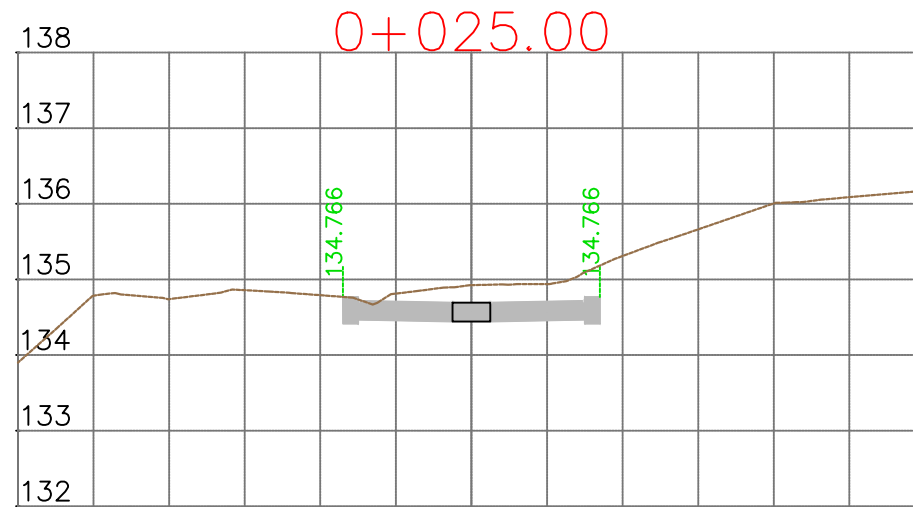
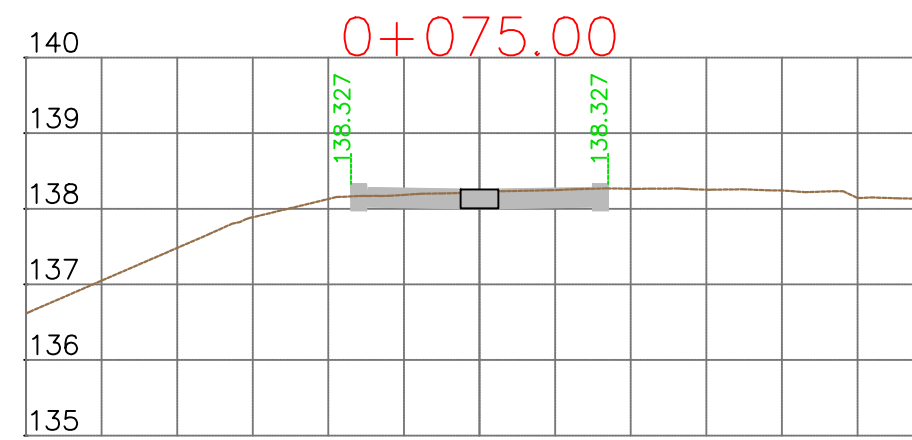
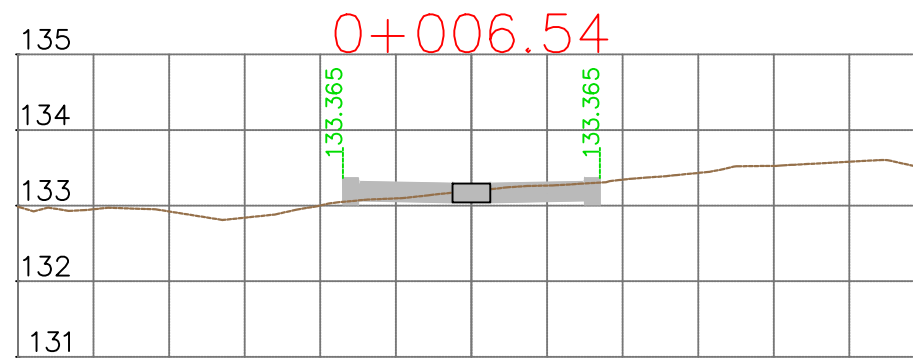

REPUBLIKA E SHQIPËRISË
BASHKIA E TIRANËS

OBJEKTI: "RIKUALIFIKIMI URBAN I ZONËS
INFORMALE QË KUFIZOHET NGA RRUGËT
-SABAUDIN GABRANI -JONUZ RAMA-HAMDI
CULLHAJ-DAMIAN HIMARIOTI-BARI
ISHKA-VASFI SAMIMI-ALUSH ELMAZ TAKA."

Projektoi :

Ing.A.JAKOVA
Ing.G.ISLAMI
Ing.S.MYRSELI
Ing.P.SHKURTI

Ark.M.DADO
Ing.Gjeol.Xh.KASMI
Ing.Mjedis.E.CALI
Top.A.BECECI

Projektoi :
"S&L STUDIO SH.P.K"

Projektim-kupervizion-cosnulence



FAZA

DORËZIM

PROJEKT ZBATIMI

1.0

PROFILE TËRTHORE
RRUGA RR.JONUZ RAMA

SHKALLA 1:100

Nr. I FLETËS 001

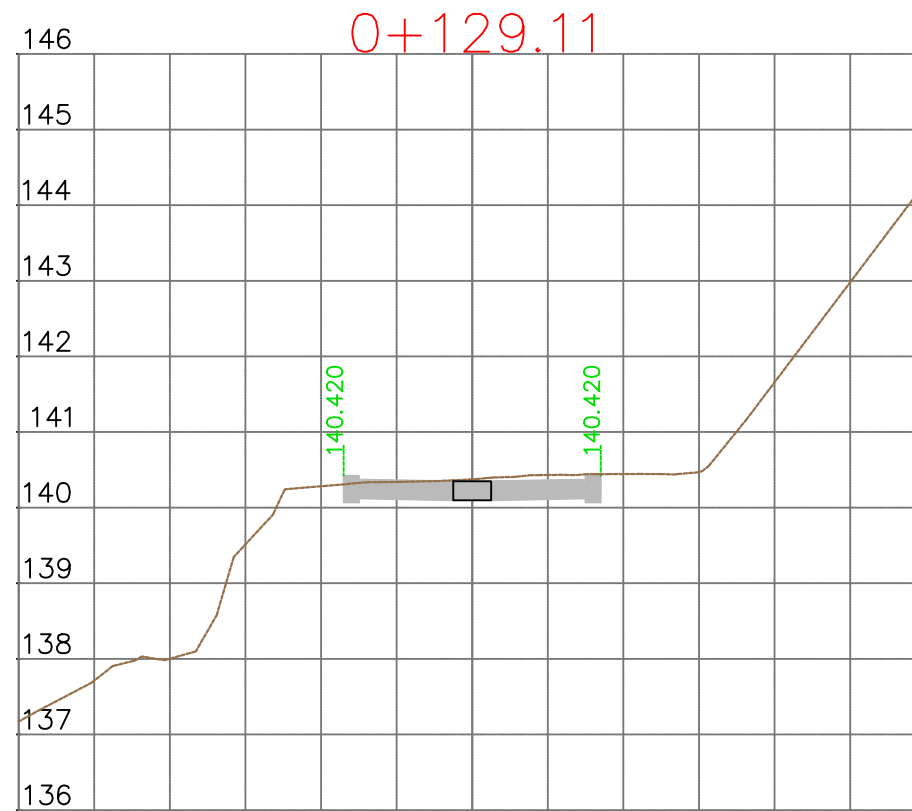

REPUBLIKA E SHQIPËRISË
BASHKIA E TIRANËS

OBJEKTI: "RIKUALIFIKIMI URBAN I ZONËS
INFORMALE QË KUFIZOHET NGA RRUGËT
-SABAUDIN GABRANI -JONUZ RAMA-HAMDI
CULLHAJ-DAMIAN HIMARIOTI-BARI
ISHKA-VASFI SAMIMI-ALUSH ELMAZ TAKA."

Projektoi :

Ing.A.JAKOVA
Ing.G.ISLAMI
Ing.S.MYRSELI
Ing.P.SHKURTI

Ark.M.DADO
Ing.Gjeol.Xh.KASMI
Ing.Mjedis.E.CALI
Top.A.BECECI

Projektoi :

"S&L STUDIO SH.P.K"

Projektim-kupervizion-cosnulence



FAZA

DORËZIM

PROJEKT ZBATIMI

1.0

PROFILE TËRTHORE
RRUGA RR.JONUZ RAMA

SHKALLA 1:100

Nr. I FLETËS 002

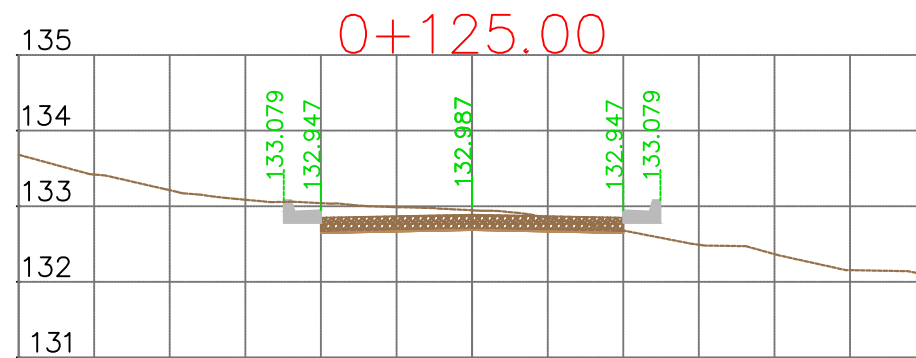
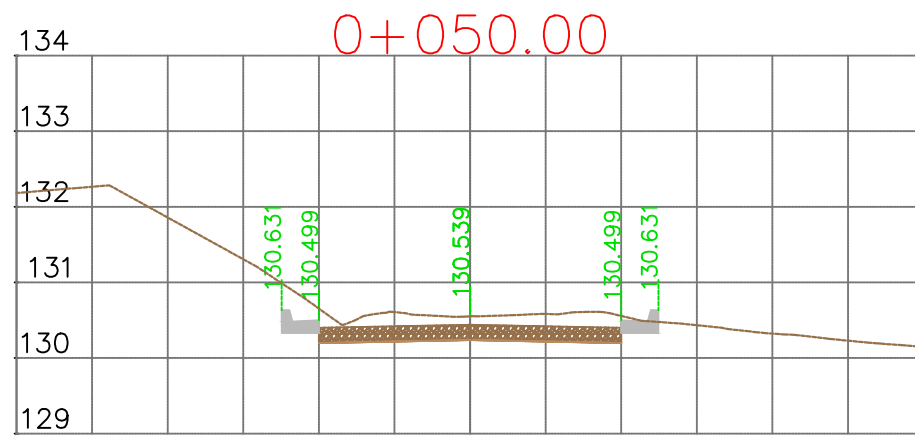
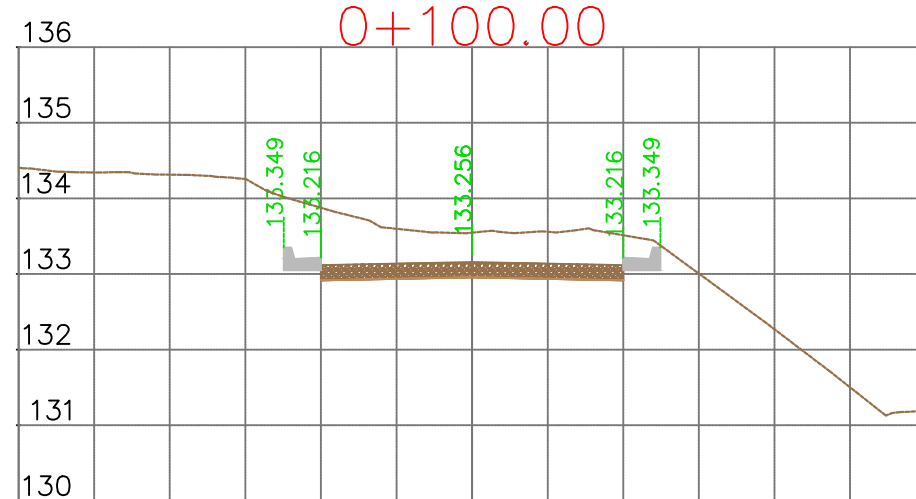
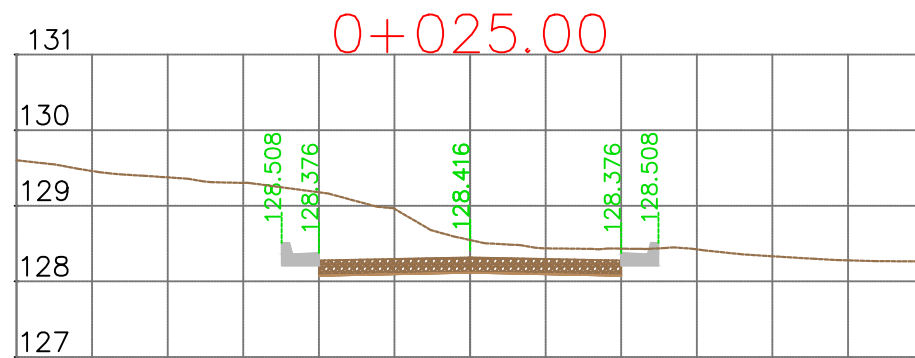
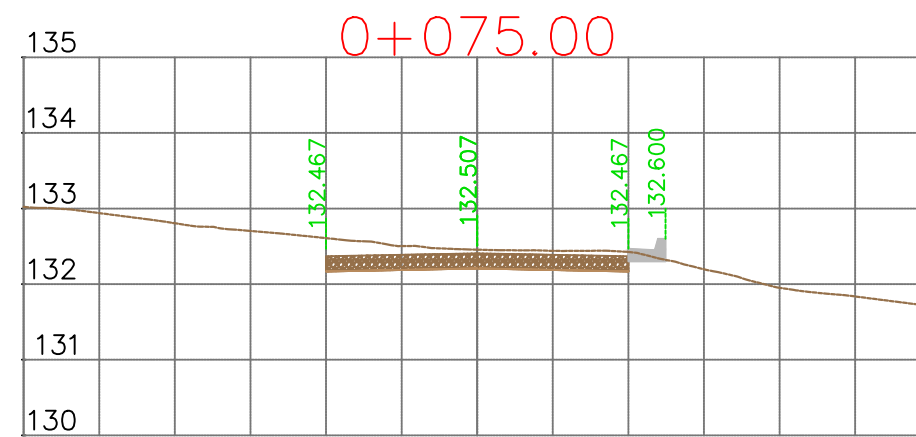
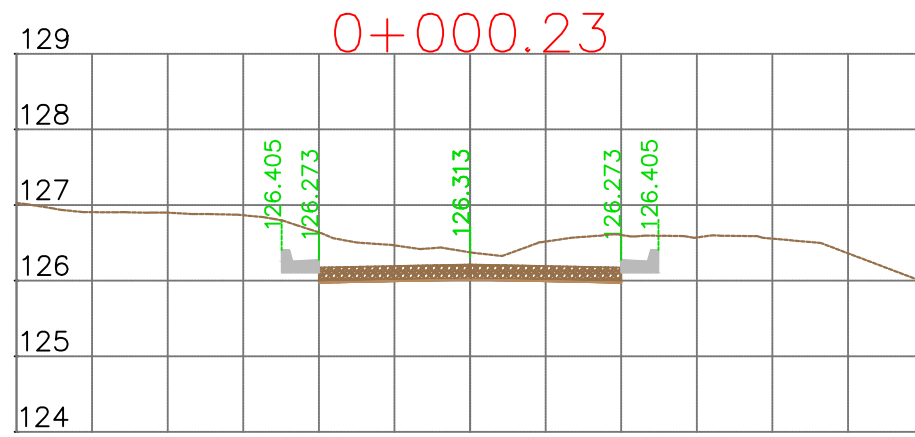

REPUBLIKA E SHQIPËRISË
BASHKIA E TIRANËS

OBJEKTI: "RIKUALIFIKIMI URBAN I ZONËS
INFORMALE QË KUFIZOHET NGA RRUGËT
-SABAUDIN GABRANI -JONUZ RAMA-HAMDI
CULLHAJ-DAMIAN HIMARIOTI-BARI
ISHKA-VASFI SAMIMI-ALUSH ELMAZ TAKA."

Projektoi :

Ing.A.JAKOVA
Ing.G.ISLAMI
Ing.S.MYRSELI
Ing.P.SHKURTI

Ark.M.DADO
Ing.Gjeol.Xh.KASMI
Ing.Mjedis.E.CALI
Top.A.BECECI

Projektoi :

"S&L STUDIO SH.P.K"

Projektim-kupervizion-cosnulence



FAZA

DORËZIM

PROJEKT ZBATIMI

1.0

PROFILE TËRTHORE
RRUGA RR.JONUZ RAMA

SHKALLA 1:100

Nr. I FLETËS 003

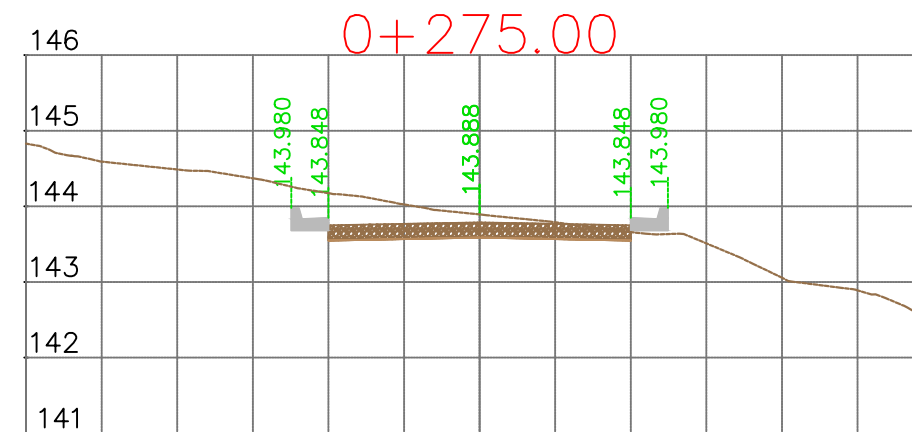
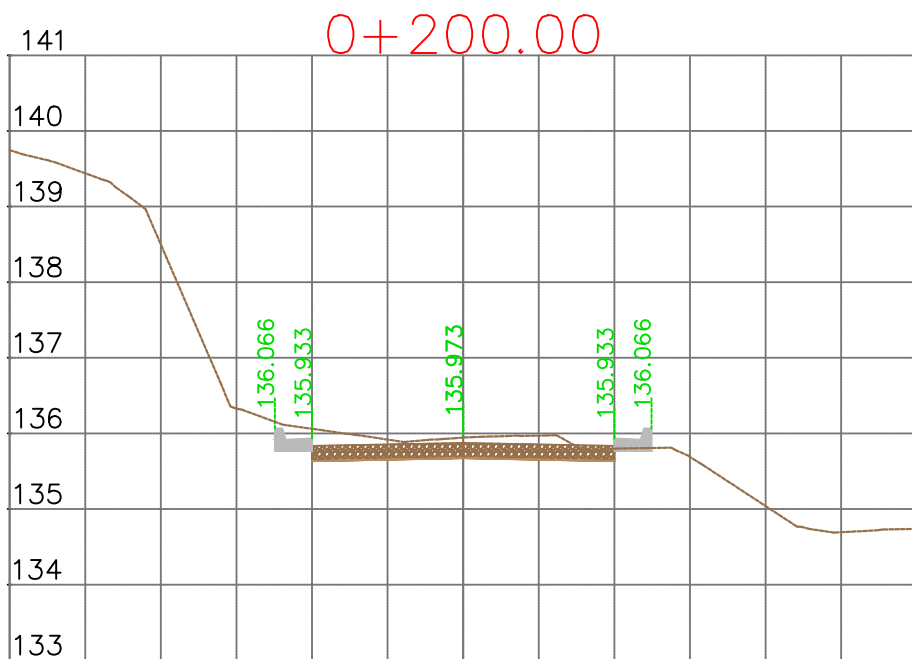
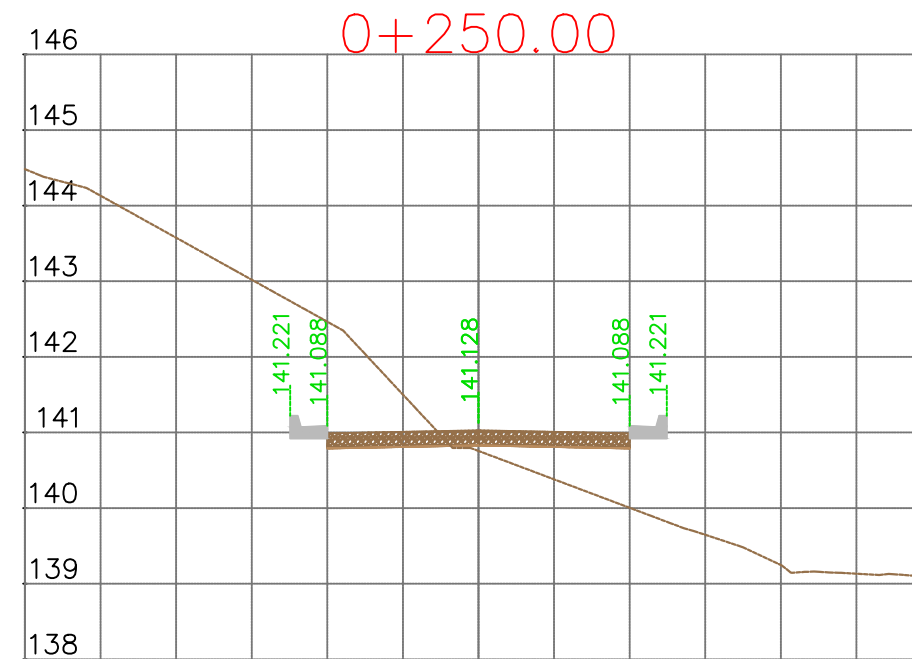
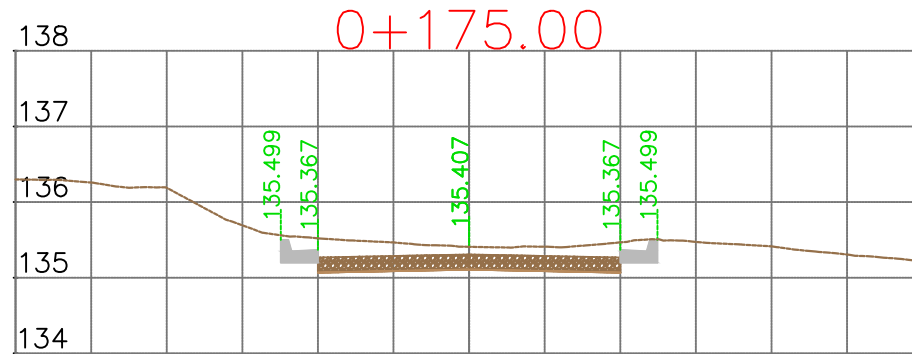
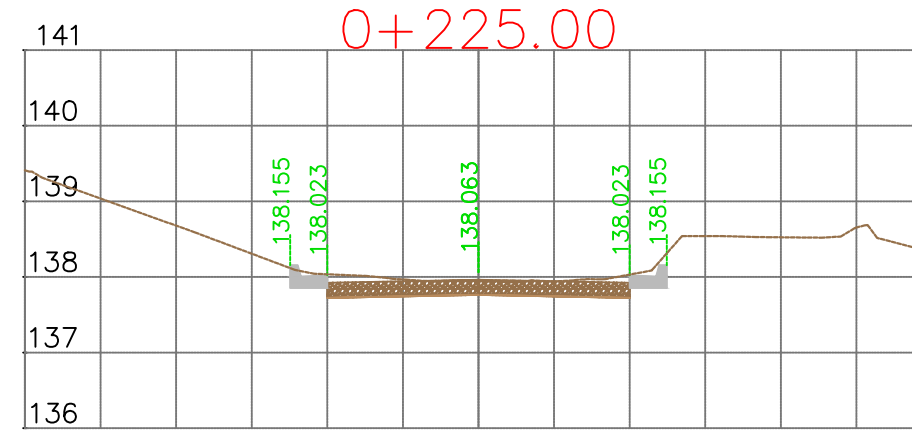
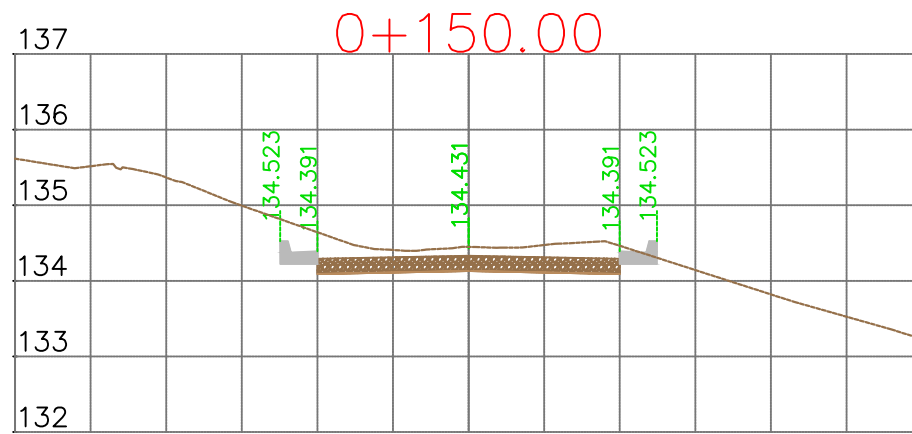

REPUBLIKA E SHQIPËRISË
BASHKIA E TIRANËS

OBJEKTI: "RIKUALIFIKIMI URBAN I ZONËS
INFORMALE QË KUFIZOHET NGA RRUGËT
-SABAUDIN GABRANI -JONUZ RAMA-HAMDI
CULLHAJ-DAMIAN HIMARIOTI-BARI
ISHKA-VASFI SAMIMI-ALUSH ELMAZ TAKA."

Projektoi :

Ing.A.JAKOVA
Ing.G.ISLAMI
Ing.S.MYRSELI
Ing.P.SHKURTI

Ark.M.DADO
Ing.Gjeol.Xh.KASMI
Ing.Mjedis.E.CALI
Top.A.BECECI

Projektoi :
"S&L STUDIO SH.P.K"

Projektim-kupervizion-cosnulence



FAZA

DORËZIM

PROJEKT ZBATIMI

1.0

PROFILE TËRTHORE
RRUGA RR.JONUZ RAMA

SHKALLA 1:100

Nr. I FLETËS 004

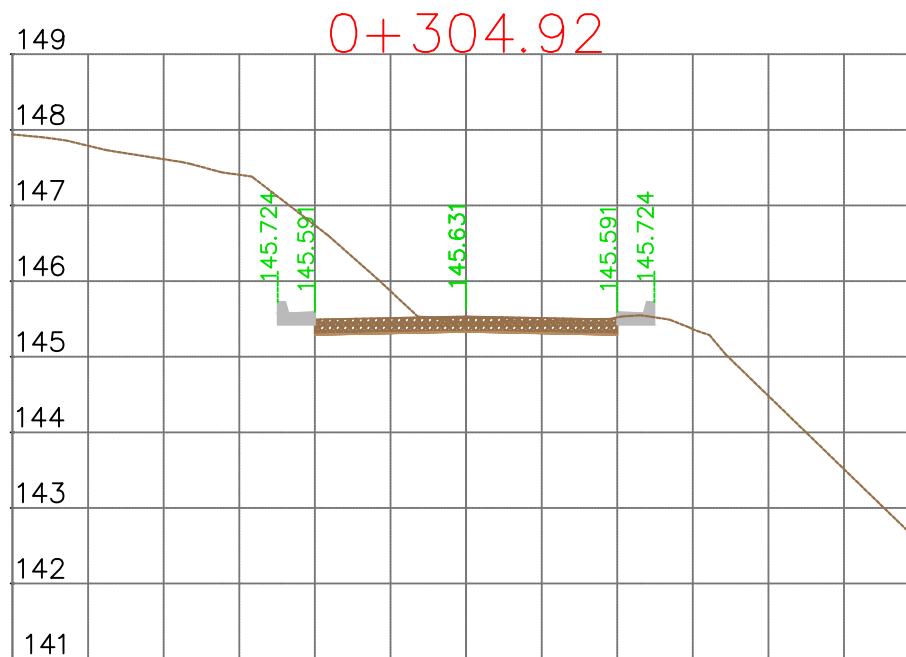
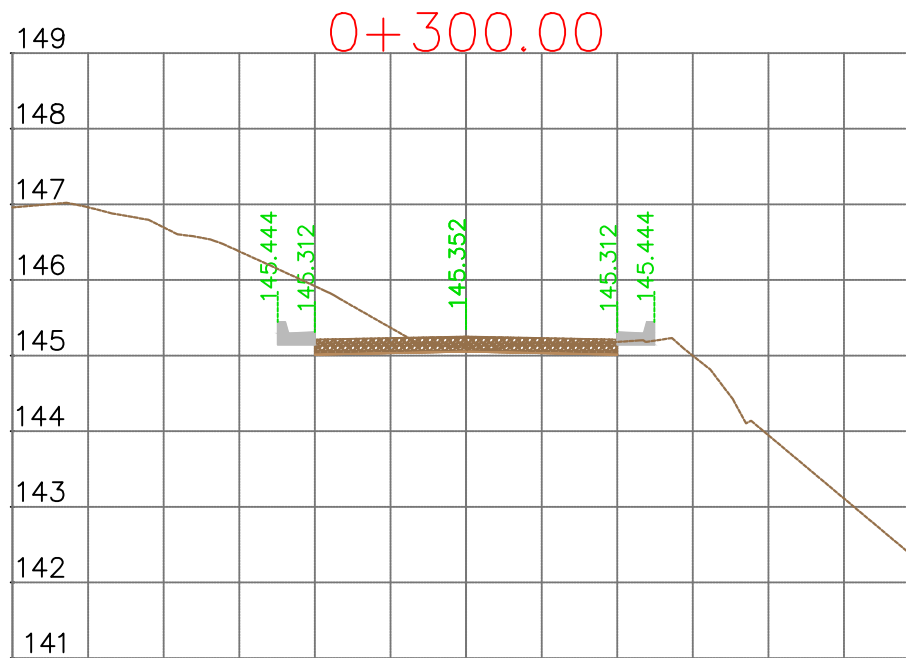

REPUBLIKA E SHQIPËRISË
BASHKIA E TIRANËS

OBJEKTI: "RIKUALIFIKIMI URBAN I ZONËS
INFORMALE QË KUFIZOHET NGA RRUGËT
-SABAUDIN GABRANI -JONUZ RAMA-HAMDI
CULLHAJ-DAMIAN HIMARIOTI-BARI
ISHKA-VASFI SAMIMI-ALUSH ELMAZ TAKA."

Projektoi :

Ing.A.JAKOVA
Ing.G.ISLAMI
Ing.S.MYRSELI
Ing.P.SHKURTI

Ark.M.DADO
Ing.Gjeol.Xh.KASMI
Ing.Mjedis.E.CALI
Top.A.BECECI

Projektoi :

"S&L STUDIO SH.P.K"

Projektim-kupervizion-cosnulence



FAZA

DORËZIM

PROJEKT ZBATIMI

1.0

PROFILE TËRTHORE
RRUGA RR.JONUZ RAMA

SHKALLA 1:100

Nr. I FLETËS 005