

# PLANIMETRIA E BANESËS PAS RIKONSTRUKSIONIT SHK. 1:100

Z.AGIM BASHA

FSHATI ÇETË

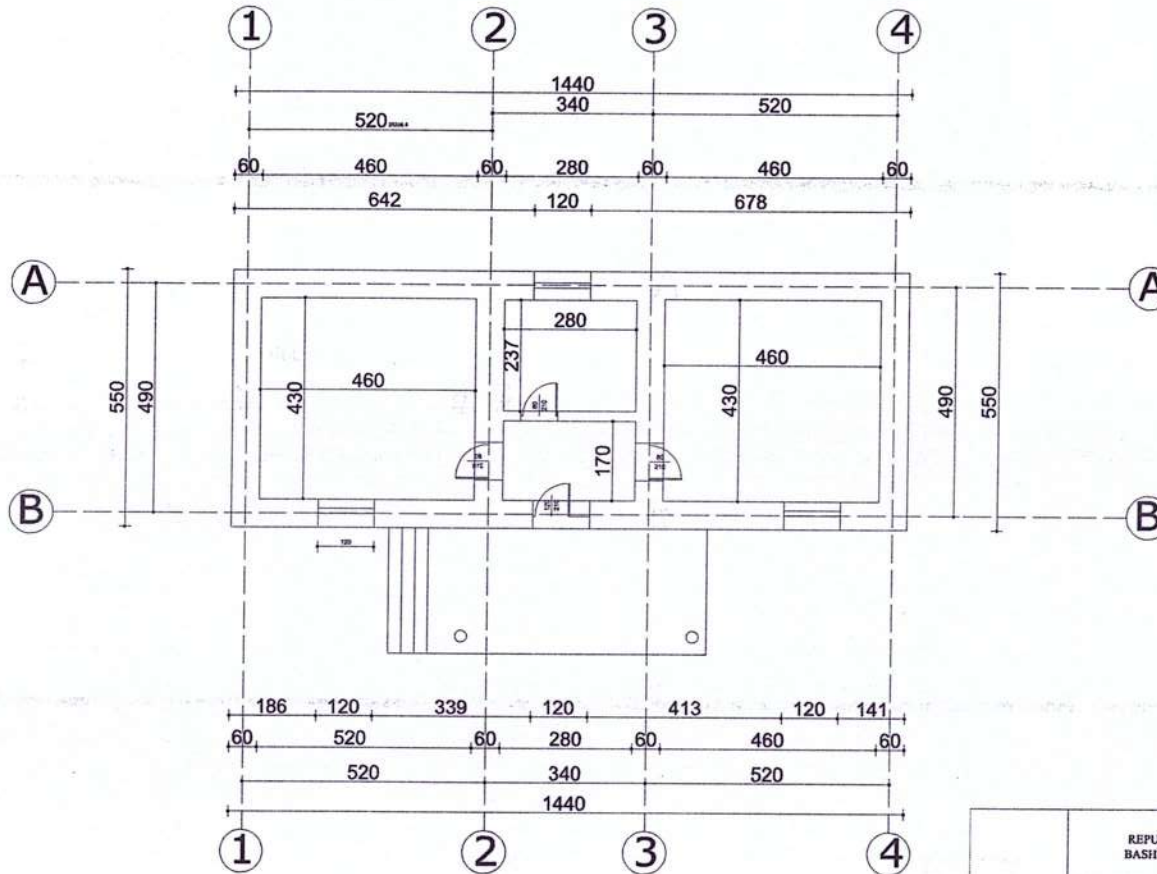

|   |  |  |                         |  |
|---|--|--|-------------------------|--|
| REPUBLIKA E SHQIPERISË<br>BASHKIA URA VAJGURORË | DREJTORIA E PLANIFIKIMIT TË<br>TERRITORIT, INVESTIMEVE,<br>KONTROLLIT TË PROJEKTEVE, E<br>SHËRBIMEVE PUBLIKE DHE STREHIMIT | DREJTOR<br>I DREJTORISË SE PLANIFIKIMIT TË<br>TERRITORIT, INVESTIMEVE,<br>KONTROLLIT TË PROJEKTEVE,<br>E SHËRBIMEVE PUBLIKE<br>DHE STREHIMIT | ARK. ALTIN PALI         |  |
| OBJEKTI:<br>ZAGIM BASHA                         |  | SPECIALISTI TOPOGRAF   | TOP.IGRID SHKËMBI       |  |
| FSHATI ÇETË                                     | 2023   | SPECIALIST I ZYRES<br>SE URBANISTIKES  | ING. JULIANA ABDURAMANI |  |

# PLANIMETRIA E ÇATISË BANESËS PAS RIKONSTRUKSIONIT SHK. 1:100

Z.AGIM BASHA

FSHATI ÇETË

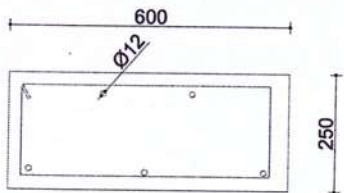
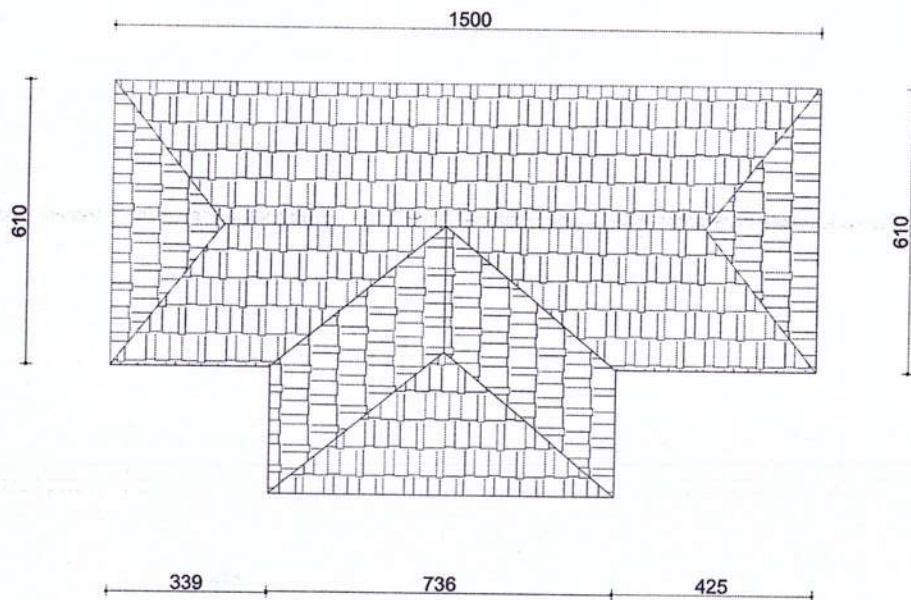

BREZ BETONARME  
SHKALLA 1:10

|                          |  |  |                         |   |
|--------------------------|--|--|-------------------------|---|
|                          | REPUBLIKA E SHQIPERISË<br>BASHKIA URA VAJGURORRE<br><br>DREJTORIA E PLANIFIKIMIT TË<br>TERRITORIT, INVESTIMEVE,<br>KONTROLLIT TË PROJEKTEVE, E<br>SHËRBIMEVE PUBLIKE DHE STREHIMIT | DREJTOR<br>I DREJTORISE SË PLANIFIKIMIT TË<br>TERRITORIT, INVESTIMEVE,<br>KONTROLLIT TË PROJEKTEVE,<br>E SHËRBIMEVE PUBLIKE<br>DHE STREHIMIT | ARK. ALTIN PALI         |  |
| OBJEKTI:<br>Z.AGIM BASHA |  | SPECIALISTI TOPOGRAF   | TOP.IGRID SHKËMBI       |  |
| FSHATI ÇETË              | 2023   | SPECIALIST I ZYRES<br>SE URBANISTIKES  | ING. JULIANA ABDURAMANI |  |

# PLANIMETRIA E ÇATISË BANESËS PAS RIKONSTRUKSIONIT SHK. 1:100

Z.AGIM BASHA

FSHATI ÇETË

SKEMA E ELEMENTEVE TE KAPRIATES KAP-1

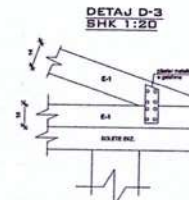
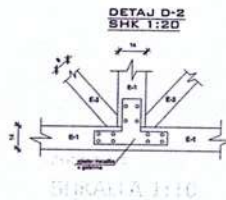
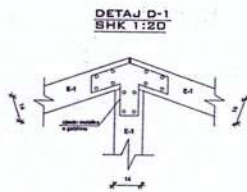
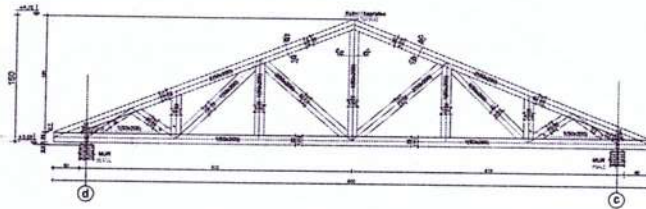

DETAJE  
SHKALLA 1:10

KULMI I KAPRIATES

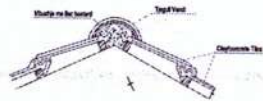

CATI ME TJEGULLA MARSELJEZE



DETAJI 1

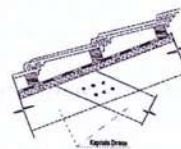

**SHENIM TEKNIK:**  
 -Tregjulla materiale  
 -Rruges e ceto 130x40-3cmj  
 -Aqja e shtrua karton lakuar  
 -Cilindra dremesh 0-2,5cm  
 -Kapriata dremes e ceto „m

|                         |  |  |                         |  |
|-------------------------|--|--|-------------------------|--|
|                         | REPUBLIKA E SHQIPERISE<br>BASHKIA URA VAJGJORE   | DREJTOR<br>I DREJTORISE SE PLANIFIKIMIT TE<br>TERRITORIT, INVESTIMEVE,<br>KONTROLLIT TE PROJEKTEVE,<br>E SHERBIMEVE PUBLIKE<br>DHE STREHIMIT | ARK. ALTIN PALI         |  |
| OBJEKTI:<br>ZAGIM BASHA | DREJTORIA E PLANIFIKIMIT TE<br>TERRITORIT, INVESTIMEVE,<br>KONTROLLIT TE PROJEKTEVE, E<br>SHERBIMEVE PUBLIKE DHE STREHIMIT | SPECIALISTI TOPOGRAF   | TOP.IGRID SHKËMBI       |  |
| FSHATI ÇETË             | 2023   | SPECIALISTI I ZYRES<br>SE URBANISTIKES   | ING. JULIANA ABDURAMANI |  |



# LANIMETRIA E BANESËS PAS RIKONSTRUKSIONIT SHK. 1:100

Z. ELIDJON KAZANXHIU FSHATI PASHALLI

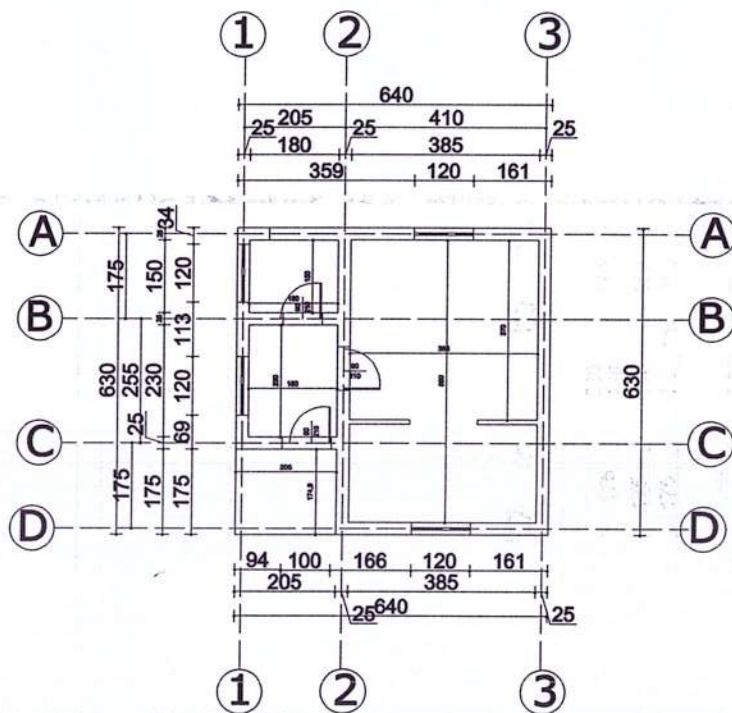

|                 |   |  |   |
|-----------------|---|--|---|
|                 | REPUBLIKA E SHQIPERISË<br>BASHKIA URA VAJGURORË<br><br>DREJTORIA E PLANIFIKIMIT TË<br>TERRITORIT, INVESTIMEVE,<br>KONTROLLIT TË PROJEKTEVE, E<br>SHËRBIMEVE PUBLIKE DHE STREHIMIT | DREJTOR<br>I DREJTORISË E PLANIFIKIMIT TË<br>TERRITORIT, INVESTIMEVE<br>KONTROLLIT TË PROJEKTEVE,<br>E SHËRBIMEVE PUBLIKE<br>DHE STREHIMIT | ARK. ALTIN PALI<br><br>        |
| OBJEKTI:        | Z. ELIDJON KAZANXHIU  | SPECIALISTI TOPOGRAF   | TOP.IGRID SHKËMBI<br><br>      |
| FSHATI PASHALLI | 2023  | SPECIALIST I ZYRES<br>SE URBANISTIKES  | ING. JULIANA ABDURAMAN<br><br> |

# PLANIMETRIA E CATISE SE BANESËS PAS RIKONSTRUKSIONIT SHK. 1:100

Z.ELIDJON KAZANXHIU

FSHATI PASHALLI

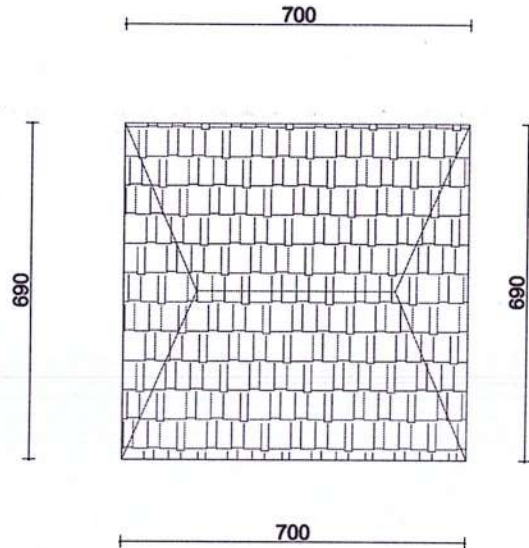



200

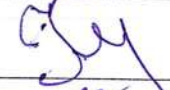

250

BREZ BETONARME  
SHKALLA 1:10

|                                  |   |  |   |
|----------------------------------|---|--|---|
|                                  | REPUBLIKA E SHQIPERISË<br>BASHKIA URA VAJGURORË<br><br>DREJTORIA E PLANIFIKIMIT TË<br>TERRITORIT, INVESTIMEVE,<br>KONTROLLIT TË PROJEKTEVE, E<br>SHËRBIMEVE PUBLIKE DHE STREHIMIT | DREJTOR<br>I DREJTORISË SE PLANIFIKIMIT TË<br>TERRITORIT, INVESTIMEVE,<br>KONTROLLIT TË PROJEKTEVE,<br>E SHËRBIMEVE PUBLIKE<br>DHE STREHIMIT | ARK. ALTIN PALI          |
| OBJEKTI:<br>Z. ELIDJON KAZANXHIU |   | SPECIALISTI TOPOGRAF   | TOP.IGRID SHKËMBI        |
| FSHATI PASHALLI      2023        |   | SPECIALIST I ZYRES<br>SE URBANISTIKES  | ING. JULIANA ABDURAMANI  |

# PLANIMETRIA E CATISE SE BANESËS PAS RIKONSTRUKSIONIT SHK. 1:100

Z.ELIDJON KAZANXHIU FSHATI PASHALLI

SHKEMA E ELEMENTEVE TE KAPRIATES KAP-1

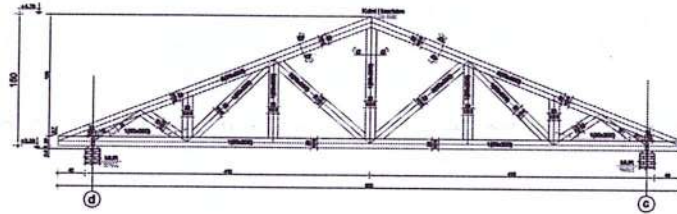

DETAJ D-1  
SHK 1:20

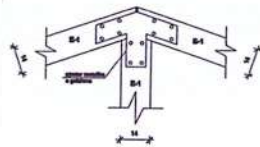

DETAJ D-2  
SHK 1:20

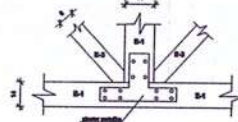

DETAJ D-3  
SHK 1:20

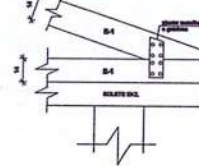

DETAJE  
SHKALLA 1:10

KULMI I KAPRIATES



CATI ME TJEGULLA MARSELIEZE

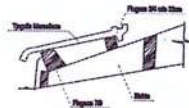

DETAJ 1

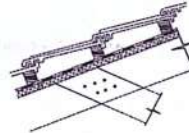

SHENIM TEBORIK:  
-Tjegalet e marshallit  
-Kupola e marshallit (4-5cm)  
-Ngjyeshja e karkos karkos  
-Gjeresha e marshallit (2-3cm)  
-Kupola e marshallit (2-3cm)

|                                  |   |  |                         |
|----------------------------------|---|--|-------------------------|
|                                  | REPUBLIKA E SHQIPERISE<br>BASHKIA URA VAJGURORE<br><br>DREJTORIA E PLANIFIKIMIT TE<br>TERRITORIT, INVESTIMEVE,<br>KONTROLLIT TE PROJEKTEVE, E<br>SHERBIMEVE PUBLIKE DHE STREHIMIT | DREJTOR<br>I DREJTORISE SE PLANIFIKIMIT TE<br>TERRITORIT, INVESTIMEVE,<br>KONTROLLIT TE PROJEKTEVE,<br>E SHERBIMEVE PUBLIKE<br>DHE STREHIMIT | ARK. ALTIN PALI         |
| OBJEKTI:<br>Z. ELIDJON KAZANXHIU |   | SPECIALISTI TOPOGRAF   | TOP.IGRID SHKËMBI       |
| FSHATI PASHALLI                  | 2023  | SPECIALIST I ZYRES<br>SE URBANISTIKES  | ING. JULIANA ABDURAMANI |



# PLANIMETRIA E BANESËS PAS RIKONSTRUKSIONIT SHK. 1:100

Z.FERDINANT SINANI

FSHATI ALLAMBRES

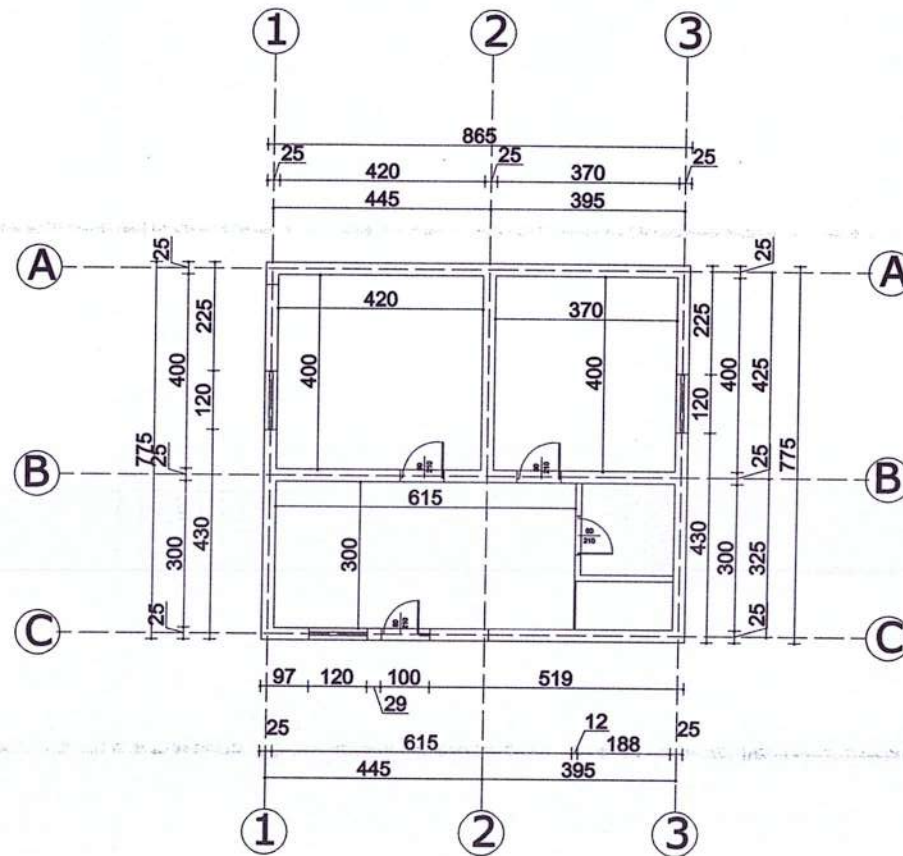



|   |   |  |   |
|---|---|--|---|
|   | REPUBLIKA E SHQIPERISË<br>BASHKIA URA VAJGURORË<br><br>DREJTORIA E PLANIFIKIMIT TË<br>TERRITORIT, INVESTIMEVE,<br>KONTROLLIT TË PROJEKTEVE, E<br>SHËRBIMEVE PUBLIKE DHE STREHIMIT | DREJTOR<br>I DREJTORISË SE PLANIFIKIMIT TË<br>TERRITORIT, INVESTIMEVE,<br>KONTROLLIT TË PROJEKTEVE,<br>E SHËRBIMEVE PUBLIKE<br>DHE STREHIMIT | ARK. ALTIN PALI  |
| OBJEKTI:<br>Z. FERDINANT SINANI<br><br>FSHATI ALLAMBRES      2023 | SPECIALISTI TOPOGRAF<br><br>SPECIALIST I ZYRES<br>SE URBANISTIKES   | TOP.IGRID SHKËMBI<br><br>ING. JULIANA ABDURAMANI        |   |

# PLANIMETRIA E CATISE SE BANESËS PAS RIKONSTRUKSIONIT SHK. 1:100

Z.FERDINANT SINANI

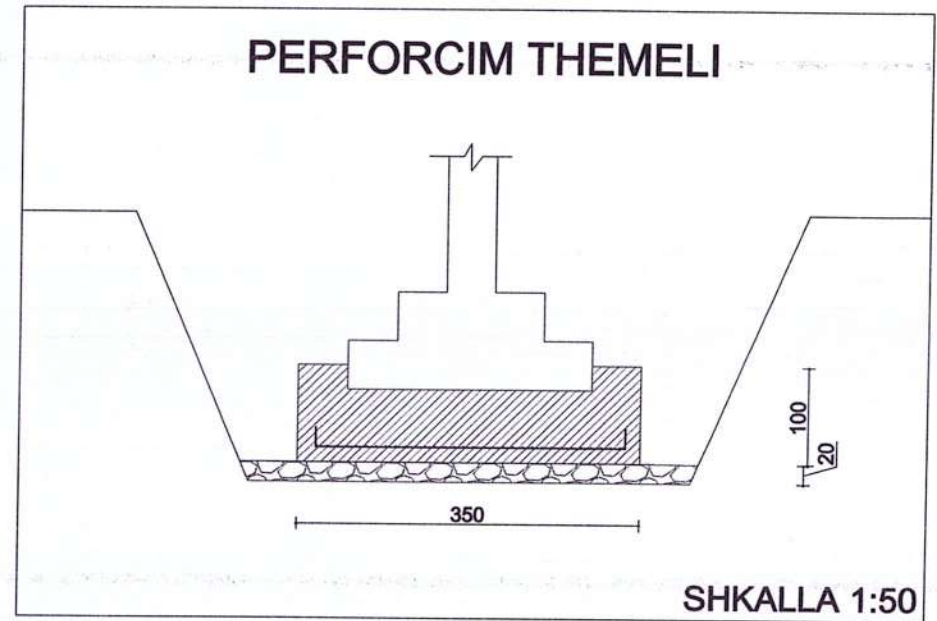
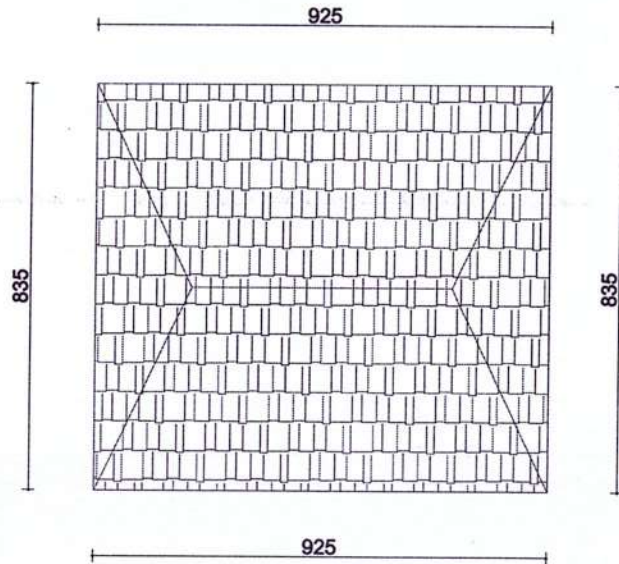
FSHATI ALLAMBRES

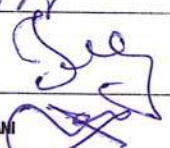

|                                       |   |  |  |
|---------------------------------------|---|--|--|
|                                       | REPUBLIKA E SHQIPERISË<br>BASHKIA URA VAJGURORË<br><br>DREJTORIA E PLANIFIKIMIT TË<br>TERRITORIT, INVESTIMEVE,<br>KONTROLLIT TË PROJEKTEVE, E<br>SHËRBIMEVE PUBLIKE DHE STREHIMIT | DREJTOR<br>I DREJTORISË SE PLANIFIKIMIT TË<br>TERRITORIT, INVESTIMEVE,<br>KONTROLLIT TË PROJEKTEVE,<br>E SHËRBIMEVE PUBLIKE<br>DHE STREHIMIT | ARK. ALTIN PALI             |
| OBJEKTI:<br>Z.SEJDO ADUSHI            |   | SPECIALISTI TOPOGRAF   | TOP.IGRID SHKËMBI  |
| FSHATI ÇETË                      2023 |   | SPECIALIST I ZYRES<br>SE URBANISTIKES  | ING. JULIANA ABDURAMANI<br> |



# PLANIMETRIA E CATISE SE BANESËS PAS RIKONSTRUKSIONIT SHK. 1:100

Z.FERDINANT SINANI

FSHATI ALLAMBRES

SKEMA E ELEMENTEVE TE KAPRIATES KAP-1

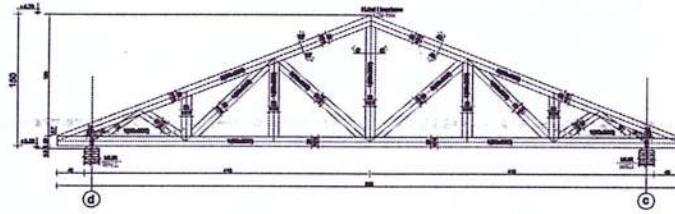

DETAJ D-1  
SHK 1:20

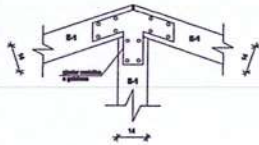

DETAJ D-2  
SHK 1:20

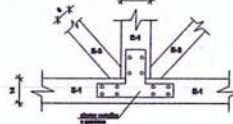

DETAJ D-3  
SHK 1:20

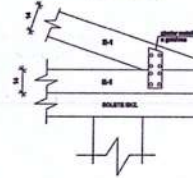

DETAJE  
SHKALLA 1:10

KULMI I KAPRIATES

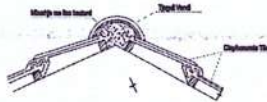

CATI ME T.JEGULLA MARSELEZE



DETAJ 1

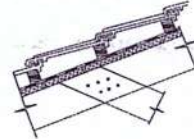



SHENIM TËRHOQË:  
 -Tjegulla marseleze  
 -Furgesa e 30cm(+30cm)  
 -Ngjeshja e betonit korrimet  
 -Shtrime e detyruar 40-50cm  
 -Kapriates e detyruar e 20cm

|   |  |  |   |
|---|--|--|---|
|   | REPUBLIKA E SHQIPERISË<br>BASHKIA URA VAJGJURORE<br><br>DREJTORIA E PLANIFIKIMIT TË<br>TERRITORIT, INVESTIMEVE,<br>KONTROLLIT TË PROJEKTEVE, E<br>SHËRBIMEVE PUBLIKE DHE STREHIMIT | DREJTOR<br>I DREJTORISE SE PLANIFIKIMIT TE<br>TERRITORIT, INVESTIMEVE,<br>KONTROLLIT TE PROJEKTEVE,<br>E SHËRBIMEVE PUBLIKE<br>DHE STREHIMIT | ARK. ALTIN PALI<br><br>                                  |
| OBJEKTI:<br>Z.SEJDO ADUSHI<br><br>FSHATI ÇETË | 2023   | SPECIALISTI TOPOGRAF<br><br>SPECIALIST I ZYRES<br>SE URBANISTIKES  | TOP.IGRID SHKËMBI<br><br>ING. JULIANA ABDURAMANI<br><br> |

# PLANIMETRIA E BANESËS PAS RIKONSTRUKSIONIT SHK. 1:100

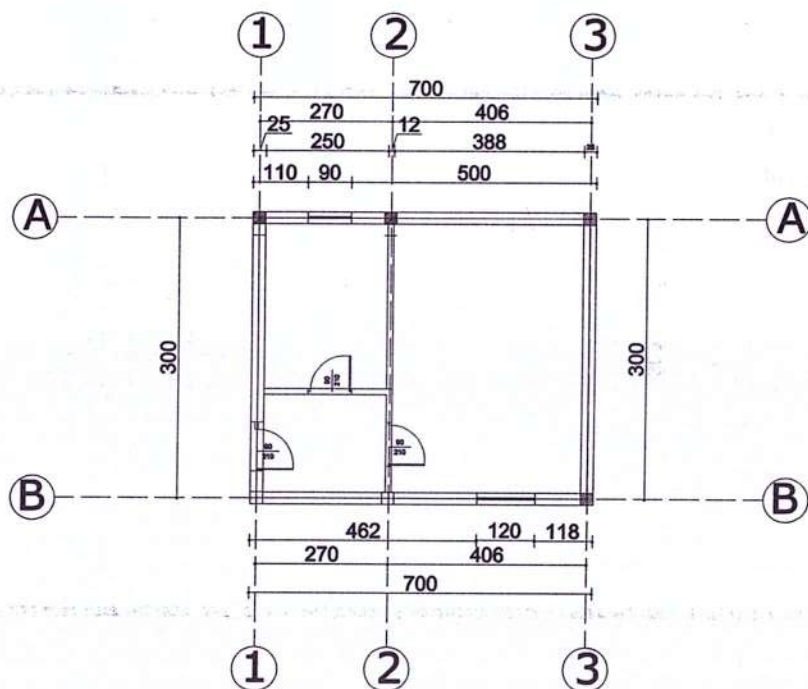
Z. HAMITE XHAFERRI FSHATI GAJDE

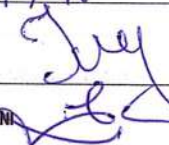

|                                 |  |  |   |
|---------------------------------|--|--|---|
|                                 | REPUBLIKA E SHQIPERISË<br>BASHKIA URA VAJGJORE<br><br>DREKTORIA E PLANIFIKIMIT TË<br>TERRITORIT, INVESTIMEVE,<br>KONTROLLIT TË PROJEKTEVE, E<br>SHËRBIMEVE PUBLIKE DHE STREHIMIT | DREJTOR<br>I DREJTORESË SE PLANIFIKIMIT TË<br>TERRITORIT, INVESTIMEVE,<br>KONTROLLIT TË PROJEKTEVE,<br>E SHËRBIMEVE PUBLIKE<br>DHE STREHIMIT | ARK. ALTIN PALI<br><br>        |
| OBJEKTI:<br>ZNJ.HAMITE XHAFERRI |  | SPECIALISTI TOPOGRAF   | TOP.IGRID SHKËMBI   |
| FSHATI GAJDE                    | 2023   | SPECIALIST I ZYRES<br>SE URBANISTIKES  | ING. JULIANA ABDURAMAN<br><br> |

# PLANIMETRIA E CATISE SE BANESËS PAS RIKONSTRUKSIONIT SHK. 1:100

Z. HAMITE XHAFERRI FSHATI GAJDE

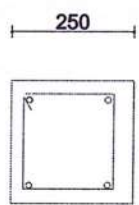
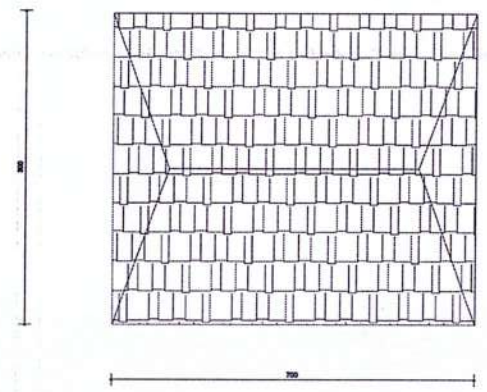

BREZ BETONARME  
SHKALLA 1:10

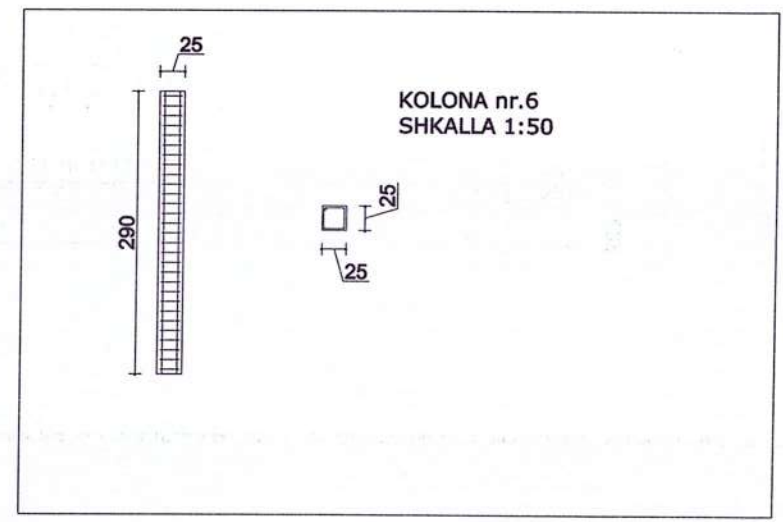

|  |   |  |  |
|--|---|--|--|
|  | REPUBLIKA E SHQIPERISË<br>BASHKIA URA VAJGURORË<br><br>DREJTORIA E PLANIFIKIMIT TË<br>TERRITORIT, INVESTIMEVE,<br>KONTROLLIT TË PROJEKTEVE, E<br>SHËRBIMEVE PUBLIKE DHE STREHIMIT | DREJTOR<br>I DREJTORISË SE PLANIFIKIMIT TË<br>TERRITORIT, INVESTIMEVE,<br>KONTROLLIT TË PROJEKTEVE,<br>E SHËRBIMEVE PUBLIKE<br>DHE STREHIMIT | ARK. ALTIN PALI<br><br>   |
| OBJEKTI:<br>Z.NJ.HAMITE XHAFERRI<br><br>FSHATI GAJDE | 2023  | SPECIALISTI TOPOGRAF<br><br>SPECIALIST I ZYRES<br>SE URBANISTIKES  | TOP.IGRID SHKËMBI<br><br>ING. JULIANA ABDURAMANI<br><br><br> |



# PLANIMETRIA E CATISE SE BANESËS PAS RIKONSTRUKSIONIT SHK. 1:100

Z. HAMITE XHAFERRI FSHATI GAJDE

SKEMA E ELEMENTEVE TE KAPRIATES KAP-1

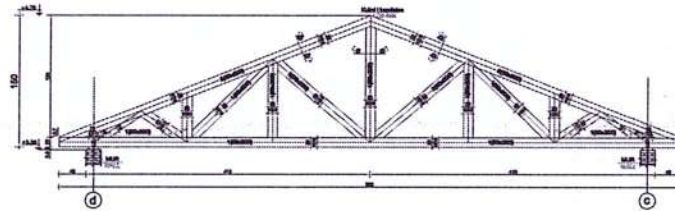

DETAJ D-1  
SHK 1:20

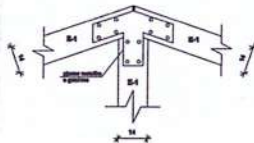

DETAJ D-2  
SHK 1:20

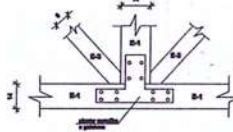

DETAJ D-3  
SHK 1:20

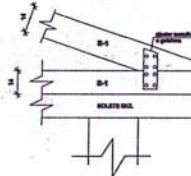

DETAJE  
SHKALLA 1:10

KULMI I KAPRIATES

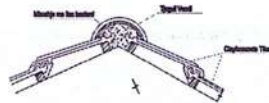

CATI ME T.JEGULLA MARSELIEZE

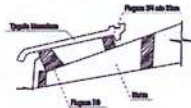

DETAJ 1

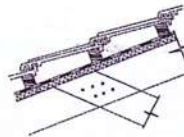

SHENIM TEORIK:  
-Tjega e marselieze  
-Figura e sh. 10 (4-5m)  
-Ngjeshja e krahut te krahut  
-Shirresha e marshallit q=2.5cm  
-Kapriates e marshallit sh. 11

|   |   |  |  |
|---|---|--|--|
|   | REPUBLIKA E SHQIPERISE<br>BASHKIA URA VAJGURORE<br><br>DREKTORIA E PLANIFIKIMIT TE<br>TERRITORIT, INVESTIMEVE,<br>KONTROLLIT TE PROJEKTEVE, E<br>SHERBIMEVE PUBLIKE DHE STREHIMIT | DREJTOR<br>I DREKTORISE SE PLANIFIKIMIT TE<br>TERRITORIT, INVESTIMEVE,<br>KONTROLLIT TE PROJEKTEVE,<br>E SHERBIMEVE PUBLIKE<br>DHE STREHIMIT | ARK. ALTIN PALI                                  |
| OBJEKTI:<br>ZNJ.HAMITE XHAFERRI<br><br>FSHATI GAJDE | 2023  | SPECIALISTI TOPOGRAF<br><br>SPECIALIST I ZYRES<br>SE URBANISTIKES  | TOP.IGRID SHKEMBI<br><br>ING. JULIANA ABDURAMANI |

# LANIMETRIA E BANESËS PAS RIKONSTRUKSIONIT SHK. 1:100

Z. AGIM CJAPI FSHATI ARREZ

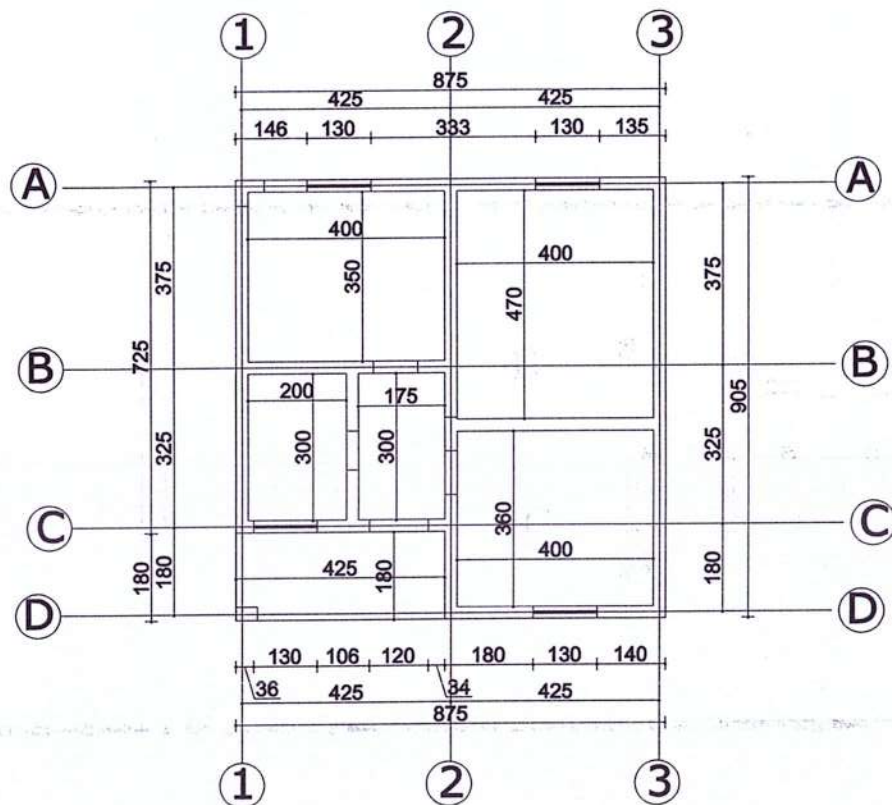

|  |   |  |  |
|--|---|--|--|
|  | REPUBLIKA E SHQIPERISË<br>BASHKIA URA VAJGURORË<br><br>DREKTORIA E PLANIFIKIMIT TË<br>TERRITORIT, INVESTIMEVE,<br>KONTROLLIT TË PROJEKTEVE, E<br>SHËRBIMEVE PUBLIKE DHE STREHIMIT | DREKTOR<br>I DREKTORISË TË PLANIFIKIMIT TË<br>TERRITORIT, INVESTIMEVE,<br>KONTROLLIT TË PROJEKTEVE,<br>E SHËRBIMEVE PUBLIKE<br>DHE STREHIMIT | ARK. ALTIN PALI<br>         |
| OBJEKTI:<br>Z. AGIM CJAPI              |   | SPECIALISTI TOPOGRAF   | TOP.IGRID SHKËMBI<br>       |
| FSHATI ARREZ                      2023 |   | SPECIALISTI I ZYRES<br>SE URBANISTIKES   | ING. JULIANA ABDURAMANI<br> |

# PLANIMETRIA E CATISE SE BANESËS PAS RIKONSTRUKSIONIT SHK. 1:100

Z. AGIM CJAPI FSHATI ARREZ

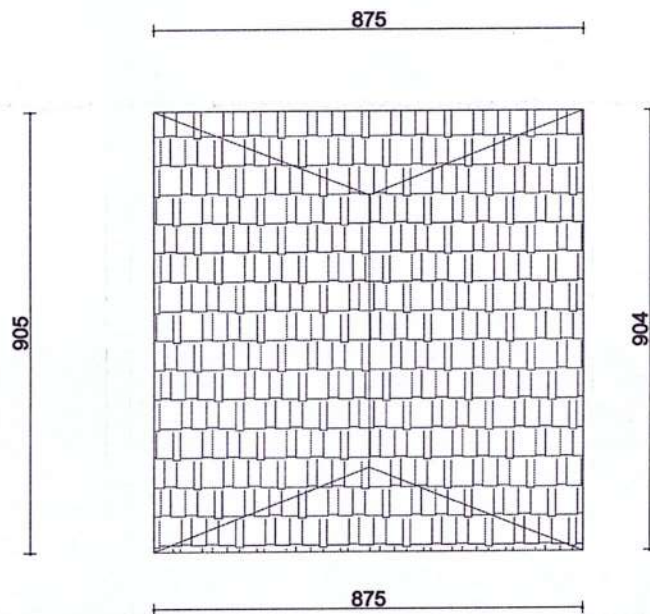

|                           |  |  |  |
|---------------------------|--|--|--|
|                           | REPUBLIKA E SHQIPERISË<br>BASHKIA URA VAJGJURORE<br><br>DREJTORIA E PLANIFIKIMIT TË<br>TERRITORIT, INVESTIMEVE,<br>KONTROLLIT TË PROJEKTEVE, E<br>SHËRBIMEVE PUBLIKE DHE STREHIMIT | DREJTOR<br>I DREJTORISË SE PLANIFIKIMIT TË<br>TERRITORIT, INVESTIMEVE,<br>KONTROLLIT TË PROJEKTEVE,<br>E SHËRBIMEVE PUBLIKE<br>DHE STREHIMIT | ARK. ALTIN PALI<br>         |
| OBJEKTI:<br>Z. AGIM CJAPI |  | SPECIALISTI TOPOGRAF   | TOP.IGRID SHKËMBI<br>       |
| FSHATI ARREZ              | 2023   | SPECIALIST I ZYRES<br>SE URBANISTIKES  | ING. JULIANA ABDURAMANI<br> |



# PLANIMETRIA E CATISE SE BANESËS PAS RIKONSTRUKSIONIT SHK. 1:100

## Z. AGIM CJAPI FSHATI ARREZ

SKEMA E ELEMENTEVE TE KAPRIATES KAP-1

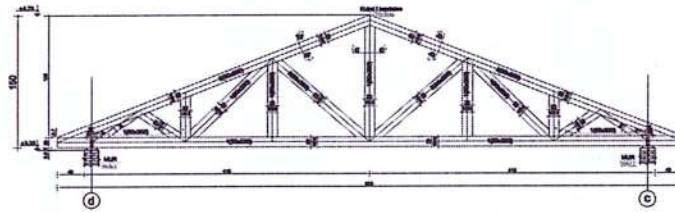

DETAJ D-1  
SHK 1:20

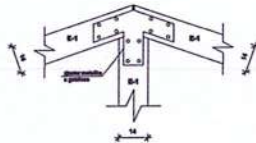

DETAJ D-2  
SHK 1:20

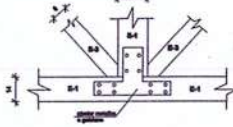

DETAJ D-3  
SHK 1:20

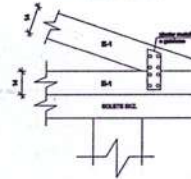

DETAJE  
SHKALLA 1:10

KULMI I KAPRIATES

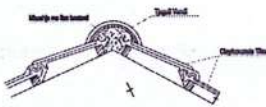

CATI ME TJEQULLA MARSELEZE

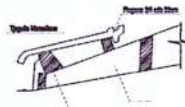

DETAJ 1

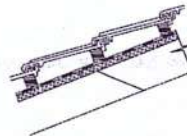

**SHENIM TËRHSIC**  
-Tregjlla matore  
-Fluga e030m(+5cm)  
-Nje shire karton izolues  
-Shtresa dremesh 4x2,5cm  
-Kapite dremesh e0,5m

|   |  |  |  |
|---|--|--|--|
|   | REPUBLIKA E SHQIPERISË<br>BASHKIA URA VAJGJORE<br><br>DREJTORIA E PLANIFIKIMIT TË<br>TERRITORIT, INVESTIMEVE,<br>KONTROLLIT TË PROJEKTEVE, E<br>SHËRBIMEVE PUBLIKE DHE STREHIMIT | DREJTOR<br>I DREJTORISE SE PLANIFIKIMIT TE<br>TERRITORIT, INVESTIMEVE,<br>KONTROLLIT TE PROJEKTEVE,<br>E SHËRBIMEVE PUBLIKE<br>DHE STREHIMIT | ARK. ALTIN PALI<br>   |
| OBJEKTI:<br>Z. AGIM CJAPI<br><br>FSHATI ARREZ | 2023   | SPECIALISTI TOPOGRAF<br><br>SPECIALIST I ZYRES<br>SE URBANISTIKES  | TOP.IGRID SHKËMBI<br><br><br>ING. JULIANA ABDURAMANI<br> |

# LANIMETRIA E BANESËS PAS RIKONSTRUKSIONIT SHK. 1:100

Z. ANESTI PRIFTI CIFLIK

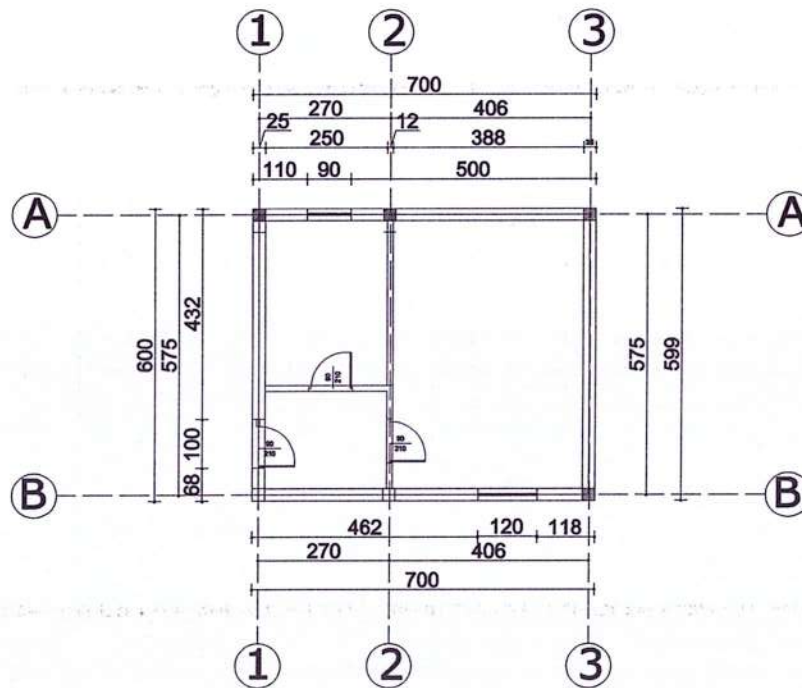

|                              |  |  |                         |   |
|------------------------------|--|--|-------------------------|---|
|                              | REPUBLIKA E SHQIPERISË<br>BASHKIA URA VAJGURORË<br><br>DRETORIA E PLANIFIKIMIT TË<br>TERRITORIT, INVESTIMEVE,<br>KONTROLLIT TË PROJEKTEVE, E<br>SHËRBIMEVE PUBLIKE DHE STREHIMIT | DREJTOR<br>I DREJTORISË SE PLANIFIKIMIT TË<br>TERRITORIT, INVESTIMEVE,<br>KONTROLLIT TË PROJEKTEVE,<br>E SHËRBIMEVE PUBLIKE<br>DHE STREHIMIT | ARK. ALTIN PALI         |  |
| OBJEKTI:<br>Z. ANESTI PRIFTI |  | SPECIALISTI TOPOGRAF   | TOP.IGRID SHKËMBI       |  |
| FSHATI CIFLIK                | 2023   | SPECIALIST I ZYRES<br>SE URBANISTIKES  | ING. JULIANA ABDURAMANI |  |

# PLANIMETRIA E CATISE SE BANESËS PAS RIKONSTRUKSIONIT SHK. 1:100

Z. ANESTI PRIFTI CIFLIK

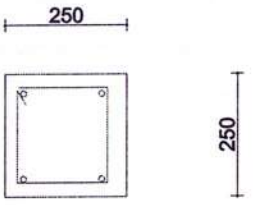
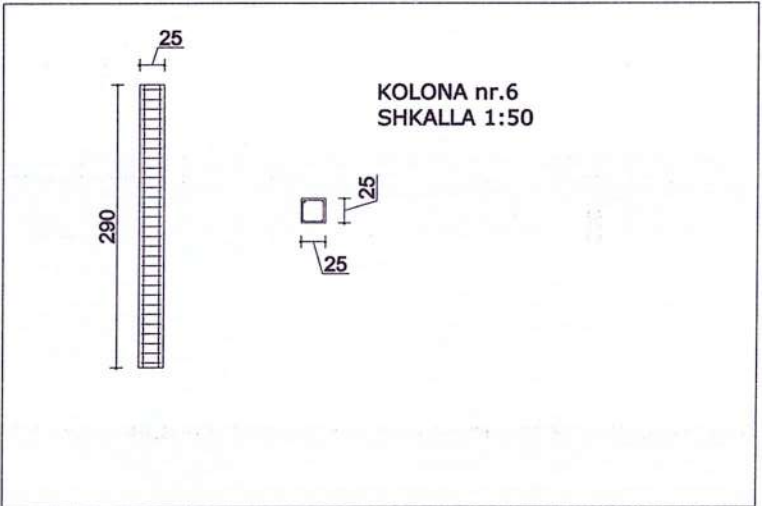
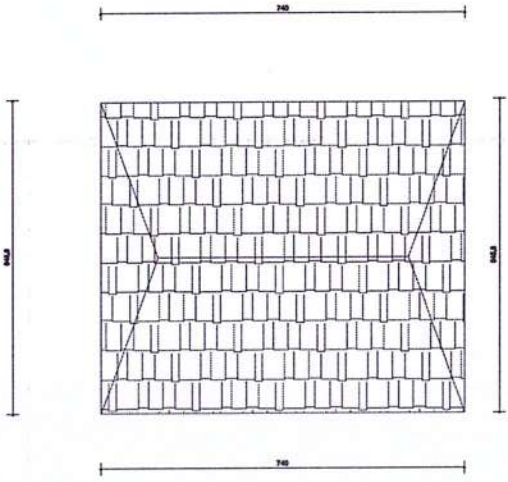

BREZ BETONARME  
SHKALLA 1:10

|                              |   |  |   |
|------------------------------|---|--|---|
|                              | REPUBLIKA E SHQIPERISË<br>BASHKIA URA VAJGURORË<br><br>DREJTORIA E PLANIFIKIMIT TË<br>TERRITORIT, INVESTIMEVE,<br>KONTROLLIT TË PROJEKTEVE, E<br>SHËRBIMEVE PUBLIKE DHE STREHIMIT | DREJTOR<br>I DREJTORESË SE PLANIFIKIMIT TË<br>TERRITORIT, INVESTIMEVE,<br>KONTROLLIT TË PROJEKTEVE,<br>E SHËRBIMEVE PUBLIKE<br>DHE STREHIMIT | ARK. ALTIN PALI          |
| OBJEKTI:<br>Z. ANESTI PRIFTI | SPECIALISTI TOPOGRAF  |  | TOP.IGRID SHKËMBI        |
| FSHATI CIFLIK 2023           | SPECIALIST I ZYRES<br>SE URBANISTIKES   |  | ING. JULIANA ABDURAMANI  |



# PLANIMETRIA E CATISE SE BANESËS PAS RIKONSTRUKSIONIT SHK. 1:100

Z. ANESTI PRIFTI CIFLIK

SHKEMA E ELEMENTEVE TE KAPRIATES KAP-1

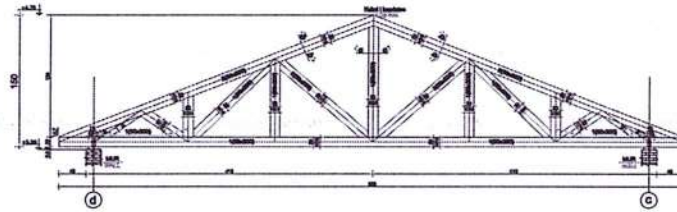

DETAJ D-1  
SHK 1:20

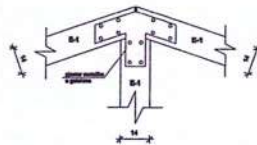

DETAJ D-2  
SHK 1:20

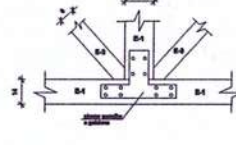

DETAJ D-3  
SHK 1:20

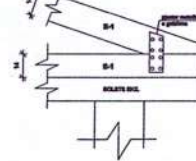

DETAJE  
SHKALLA 1:10

KULMI I KAPRIATES

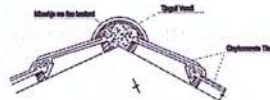

CATI ME T.JEGULLA MARSELEZE



DETAJ 1

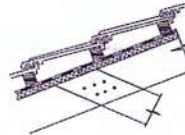

**SHENIM TEBORIK**  
 -Tregulla numerike  
 -Figura ose shprehje  
 -Nje shprehje teknike  
 -Shprehje teknike  
 -Kopjete dermte ose ..m



|   |  |  |   |
|---|--|--|---|
|   | REPUBLIKA E SHQIPERISE<br>BASHKIA URA VAJGURORRE<br><br>DREJTORIA E PLANIFIKIMIT TE<br>TERRITORIT, INVESTIMEVE,<br>KONTROLLIT TE PROJEKTEVE, E<br>SHERBIMEVE PUBLIKE DHE STREHIMIT | DREJTOR<br>I DREJTORISE SE PLANIFIKIMIT TE<br>TERRITORIT, INVESTIMEVE,<br>KONTROLLIT TE PROJEKTEVE,<br>E SHERBIMEVE PUBLIKE<br>DHE STREHIMIT | ARK. ALTIN PALI<br>                                  |
| OBJEKTI:<br>Z. ANESTI PRIFTI<br><br>FSHATI CIFLIK | 2023   | SPECIALISTI TOPOGRAF<br><br>SPECIALIST I ZYRES<br>SE URBANISTIKES  | TOP.IGRID SHKEMBI<br><br>ING. JULIANA ABDURAMANI<br> |

# LANIMETRIA E BANESËS PAS RIKONSTRUKSIONIT SHK. 1:100

Z.AZBI MARINA

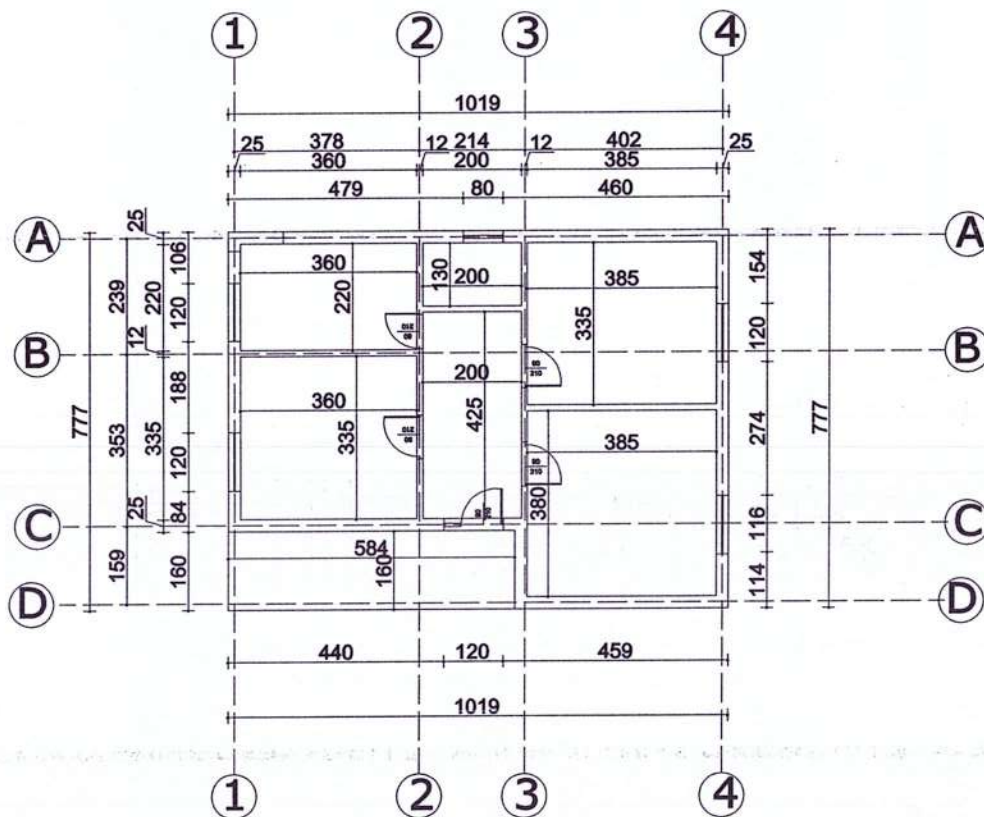
FSHATI DRENOVICE



|                            |   |  |  |
|----------------------------|---|--|--|
|                            | REPUBLIKA E SHQIPERISË<br>BASHKIA URA VAJGURORË<br><br>DREKTORIA E PLANIFIKIMIT TË<br>TERRITORIT, INVESTIMEVE,<br>KONTROLLIT TË PROJEKTEVE, E<br>SHËRBIMEVE PUBLIKE DHE STREHIMIT | DREKTOR<br>I DREKTORISË SE PLANIFIKIMIT TË<br>TERRITORIT, INVESTIMEVE,<br>KONTROLLIT TË PROJEKTEVE,<br>E SHËRBIMEVE PUBLIKE<br>DHE STREHIMIT | ARK. ALTIN PALI<br>         |
| OBJEKTI:<br>Z. AZBI MARINA |   | SPECIALISTI TOPOGRAF   | TOP.IGRID SHKËMBI<br>       |
| FSHATI DRENOVICE      2023 |   | SPECIALISTI I ZYRES<br>SE URBANISTIKES   | ING. JULIANA ABDURAMANI<br> |

# PLANIMETRIA E CATISE SE BANESËS PAS RIKONSTRUKSIONIT SHK. 1:100

Z.AZBI MARINA

FSHATI DRENOVICE

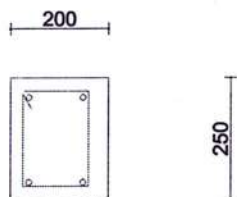
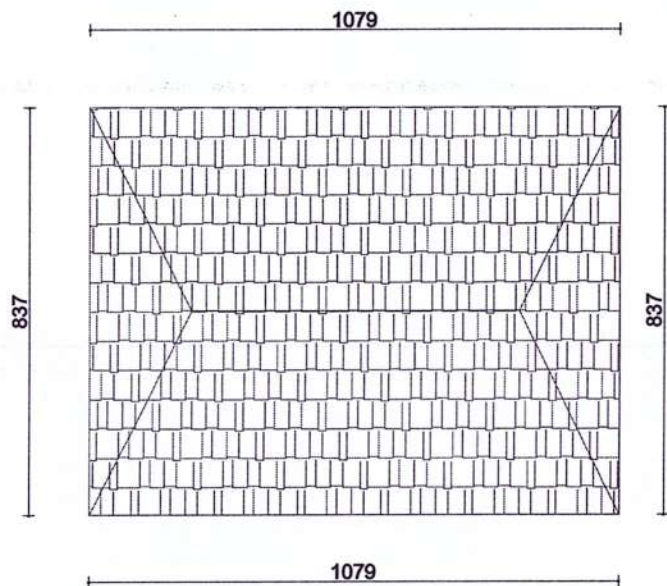

BREZ BETONARME  
SHKALLA 1:10

|                            |   |   |  |
|----------------------------|---|---|--|
|                            | REPUBLIKA E SHQIPERISË<br>BASHKIA URA VAJGURORË<br><br>DREKTORIA E PLANIFIKIMIT TË<br>TERRITORIT, INVESTIMEVE,<br>KONTROLLIT TË PROJEKTEVE, E<br>SHËRBIMEVE PUBLIKE DHE STREHIMIT | DREJTOR<br>I DREFTORISE SE PLANIFIKIMIT TË<br>TERRITORIT, INVESTIMEVE<br>KONTROLLIT TË PROJEKTEVE,<br>E SHËRBIMEVE PUBLIKE<br>DHE STREHIMIT | ARK. ALTIN PALI<br>         |
| OBJEKTI:<br>Z. AZBI MARINA |   | SPECIALISTI TOPOGRAF  | TOP.IGRID SHKËMBI<br>       |
| FSHATI DRENOVICE           | 2023  | SPECIALISTI I ZYRES<br>SE URBANISTIKES  | ING. JULIANA ABDURAMANI<br> |



# PLANIMETRIA E CATISE SE BANESËS PAS RIKONSTRUKSIONIT SHK. 1:100

Z.AZBI MARINA

FSHATI DRENOVICE

SKEMA E ELEMENTEVE TE KAPRIATES KAP-1

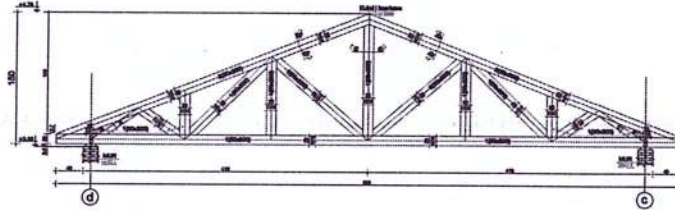

DETAJ D-1  
SHK 1:20

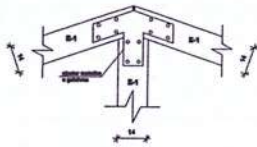

DETAJ D-2  
SHK 1:20

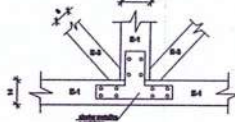

DETAJ D-3  
SHK 1:20

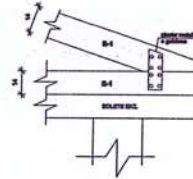

DETAJE  
SHKALLA 1:10

KULMI I KAPRIATES

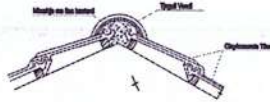

CATI ME TJEJGULLA MARSELIEZE

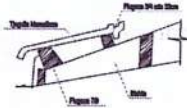

DETAJ 1

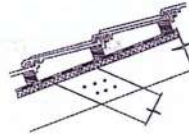

**SHENIM TËRORIS:**

- Treguesi numerik
- Treguesi i shprehur (4-3mm)
- Ngjyrat e ndryshme të linjave
- Shprehja e dimensioneve (mm)
- Kaptelat e ndryshme etc.

|                            |   |  |                         |
|----------------------------|---|--|-------------------------|
|                            | REPUBLIKA E SHQIPERISË<br>BASHKIA URA VAJGURORË<br><br>DREKTORIA E PLANIFIKIMIT TË<br>TERRITORIT, INVESTIMEVE,<br>KONTROLLIT TË PROJEKTEVE, E<br>SHËRBIMEVE PUBLIKE DHE STREHIMIT | DREKTOR<br>I DREJTORISË SE PLANIFIKIMIT TË<br>TERRITORIT, INVESTIMEVE,<br>KONTROLLIT TË PROJEKTEVE,<br>E SHËRBIMEVE PUBLIKE<br>DHE STREHIMIT | ARK. ALTIN PALI         |
| OBJEKTI:<br>Z. AZBI MARINA |   | SPECIALISTI TOPOGRAF   | TOP.IGRID SHKËMBI       |
| FSHATI DRENOVICE      2023 |   | SPECIALIST I ZYRES<br>SE URBANISTIKES  | ING. JULIANA ABDURAMANI |

# PLANIMETRIA E BANESËS PAS RIKONSTRUKSIONIT SHK. 1:100

## Z. FIZE SELIMI FSHATI PASHALLI

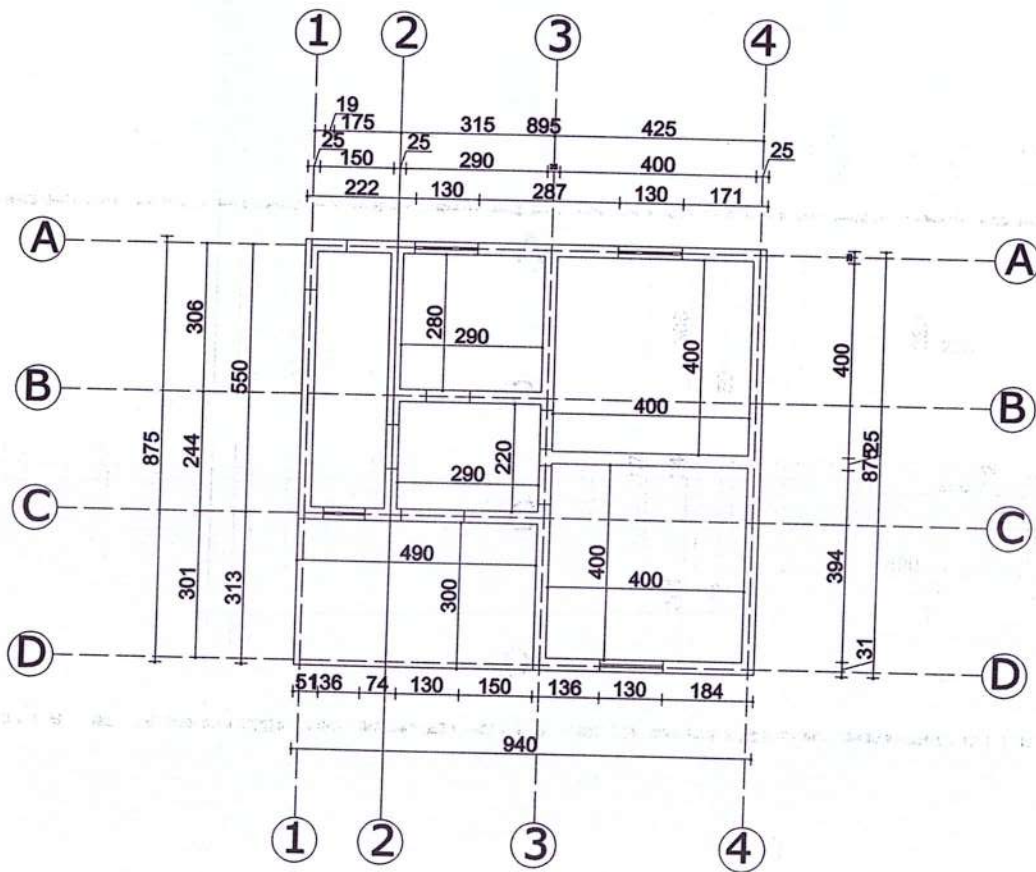

|   |   |  |  |
|---|---|--|--|
|   | REPUBLIKA E SHQIPERISË<br>BASHKIA URË VAJGËRORE<br><br>DREJTORIA E PLANIFIKIMIT TË<br>TERRITORIT, INVESTIMEVE,<br>KONTROLLIT TË PROJEKTEVE, E<br>SHËRBIMEVE PUBLIKE DHE STREHIMIT | DREJTOR<br>I DREJTORISË SE PLANIFIKIMIT TË<br>TERRITORIT, INVESTIMEVE,<br>KONTROLLIT TË PROJEKTEVE,<br>E SHËRBIMEVE PUBLIKE<br>DHE STREHIMIT | ARK. ALTIN PALI<br><br>   |
| OBJEKTI:<br>Z. FIZE SELIMI<br><br>FSHATI PASHALLI | 2023  | SPECIALISTI TOPOGRAF<br><br>SPECIALISTI I ZYRES<br>SE URBANISTIKES   | TOP.IGRID SHKËMBI<br><br>ING. JULIANA ABDURAMANI<br><br><br> |

# PLANIMETRIA E CATISE SE BANESËS PAS RIKONSTRUKSIONIT SHK. 1:100

Z. FIZE SELIMI FSHATI PASHALLI

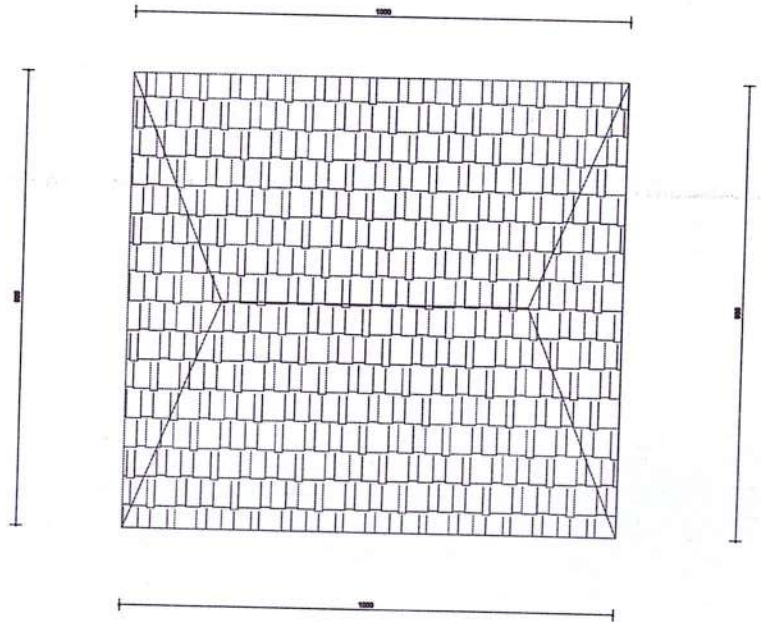

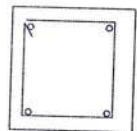

250



250

BREZ BETONARME  
SHKALLA 1:10

|                            |   |   |   |
|----------------------------|---|---|---|
|                            | REPUBLIKA E SHQIPERISË<br>BASHKIA URA VAJGURORË<br><br>DREJTORIA E PLANIFIKIMIT TË<br>TERRITORIT, INVESTIMEVE,<br>KONTROLLIT TË PROJEKTEVE, E<br>SHËRRIMEVE PUBLIKE DHE STREHIMIT | DREJTOR<br>I DREJTORISE SE PLANIFIKIMIT TË<br>TERRITORIT, INVESTIMEVE<br>KONTROLLIT TË PROJEKTEVE,<br>E SHËRRIMEVE PUBLIKE<br>DHE STREHIMIT | ARK. ALTIN PALI          |
| OBJEKTI:<br>Z. FIZE SELIMI | SPECIALISTI TOPOGRAF  |   | TOP.IGRID SHKËMBI        |
| FSHATI PASHALLI      2023  | SPECIALIST I ZYRES<br>SE URBANISTIKES   |   | ING. JULIANA ABDURAMANI  |



# LANIMETRIA E BANESËS PAS RIKONSTRUKSIONIT SHK. 1:100

Z.FLAMUR GOZHINA

FSHATI SLANICE

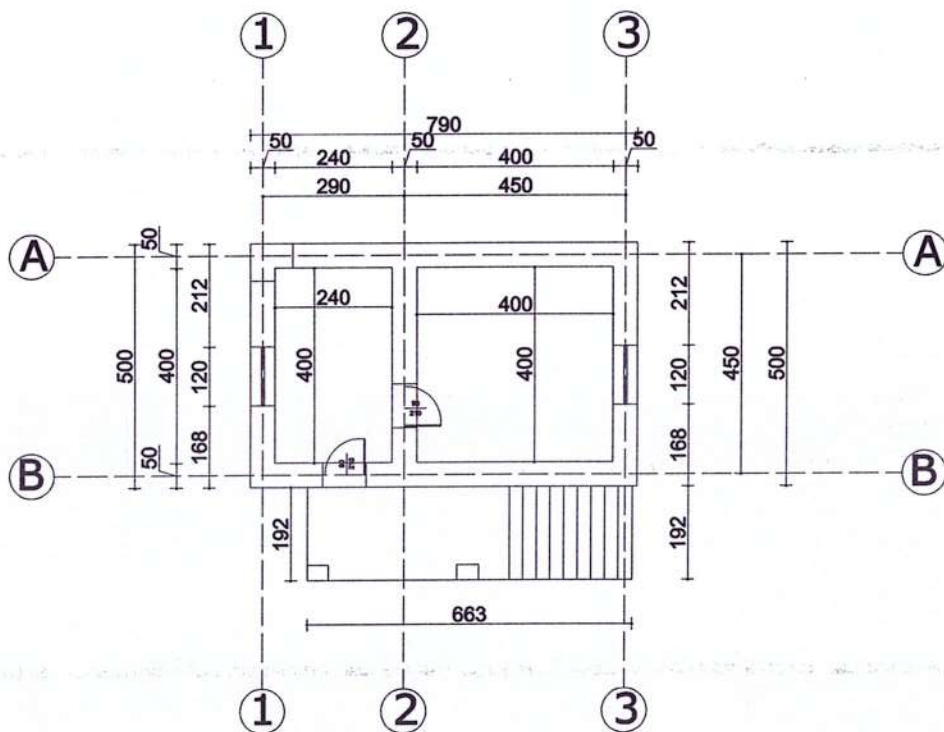

|  |   |   |  |
|--|---|---|--|
|  | REPUBLIKA E SHQIPERISË<br>BASHKIA URA VAJGURORË<br><br>DREKTORIA E PLANIFIKIMIT TË<br>TERRITORIT, INVESTIMEVE,<br>KONTROLLIT TË PROJEKTEVE, E<br>SHËRBIMEVE PUBLIKE DHE STREHIMIT | DREKTOR<br>IDREFTORISE SE PLANIFIKIMIT TË<br>TERRITORIT, INVESTIMEVE<br>,KONTROLLIT TË PROJEKTEVE,<br>E SHËRBIMEVE PUBLIKE<br>DHE STREHIMIT | ARK. ALTIN PALI<br> |
| OBJEKTI:<br>Z. FLAMUR GOZHINA            | SPECIALISTI TOPOGRAF  | TOP.IGRID SHKËMBI<br>                                  |  |
| FSHATI SLANICË                      2023 | SPECIALISTI I ZYRES<br>SE URBANISTIKES  | ING. JULIANA ABDURAMANI<br>                            |  |



# PLANIMETRIA E CATISE SE BANESËS PAS RIKONSTRUKSIONIT SHK. 1:100

Z.FLAMUR GOZHINA

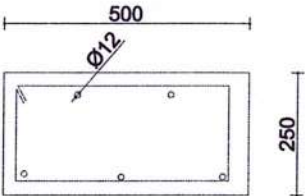
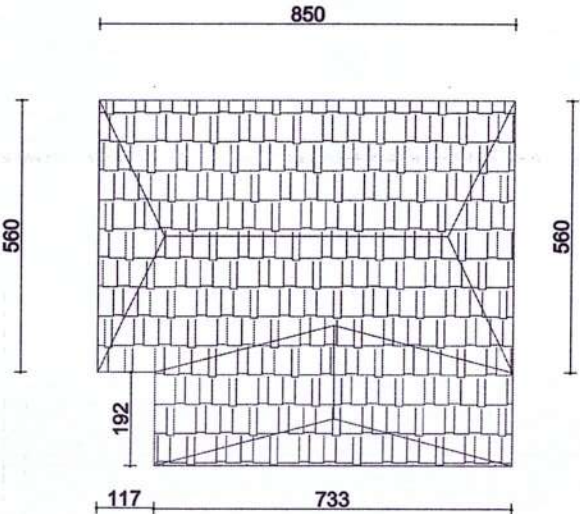
FSHATI SLANICE



BREZ BETONARME  
SHKALLA 1:10

|   |   |  |   |
|---|---|--|---|
|   | REPUBLIKA E SHQIPERISË<br>BASHKIA URK VAJGURORË<br><br>DREKTORIA E PLANIFIKIMIT TË<br>TERRITORIT, INVESTIMEVE,<br>KONTROLLIT TË PROJEKTEVE, E<br>SHËRBIMEVE PUBLIKE DHE STREHIMIT | DREJTOR<br>I DREJTORISË SE PLANIFIKIMIT TË<br>TERRITORIT, INVESTIMEVE,<br>KONTROLLIT TË PROJEKTEVE,<br>E SHËRBIMEVE PUBLIKE<br>DHE STREHIMIT | ARK. ALTIN PALI  |
| OBJEKTI:<br>Z. FLAMUR GOZHINA<br><br>FSHATI SLANICË      2023 | SPECIALISTI TOPOGRAF<br><br>SPECIALIST I ZYRES<br>SE URBANISTIKES   | TOP.IGRID SHKËMBI<br><br>ING. JULIANA ABDURAMANI        |   |

# PLANIMETRIA E CATISE SE BANESËS PAS RIKONSTRUKSIONIT SHK. 1:100

Z.FLAMUR GOZHINA

FSHATI SLANICE

SHKEMA E ELEMENTEVE TE KAPRIATES KAP-1

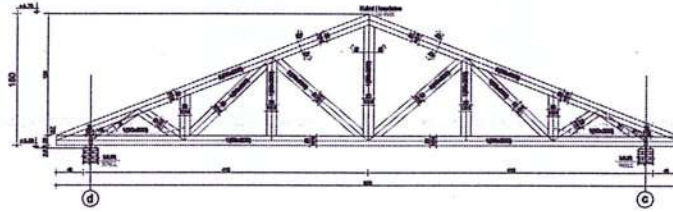

DETAJ D-1  
SHK 1:10

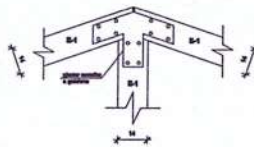

DETAJ D-2  
SHK 1:10

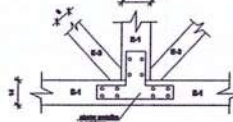

DETAJ D-3  
SHK 1:10

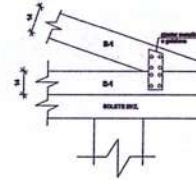

DETAJE  
SHKALLA 1:10

KULMI I KAPRIATES

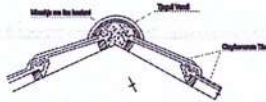

CATI ME TJEGULLA MARRBELIEZE



DETAJ 1

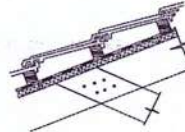

**SHIHIMI TEORIK:**  
 \*Treguesi marredhenor  
 \*Figura e cila shprehet (kon)  
 \*nga shpreh kartoni i kartonit  
 \*Shpreh detyrimet e 0-2.5m  
 \*Kapriata detyrimet e 0-2.5m

|  |   |  |                 |
|--|---|--|-----------------|
|  | REPUBLIKA E SHQIPERISE<br>BASHKIA URA VAJGURE<br><br>DREKTORIA E PLANIFIKIMIT TE<br>TERRITORIT, INVESTIMEVE,<br>KONTROLLIT TE PROJEKTEVE, E<br>SHERBIMEVE PUBLIKE DHE STREHIMIT | DREJTOR<br>I DREJTORISE SE PLANIFIKIMIT TE<br>TERRITORIT, INVESTIMEVE,<br>KONTROLLIT TE PROJEKTEVE,<br>E SHERBIMEVE PUBLIKE<br>DHE STREHIMIT | ARK. ALTIN PALI |
| OBJEKTI:<br>Z. FLAMUR GOZHINA<br><br>FSHATI SLANICE 2023 | SPECIALISTI TOPOGRAF<br><br>SPECIALISTI I ZYRES<br>SE URBANISTIKES  | TOP.IGRID SHKEMBI<br><br>ING. JULIANA ABDURAMANI   |                 |



# LANIMETRIA E BANESËS PAS RIKONSTRUKSIONIT SHK. 1:100

Z.KADRI BEJTJA

FSHATI GAJDE

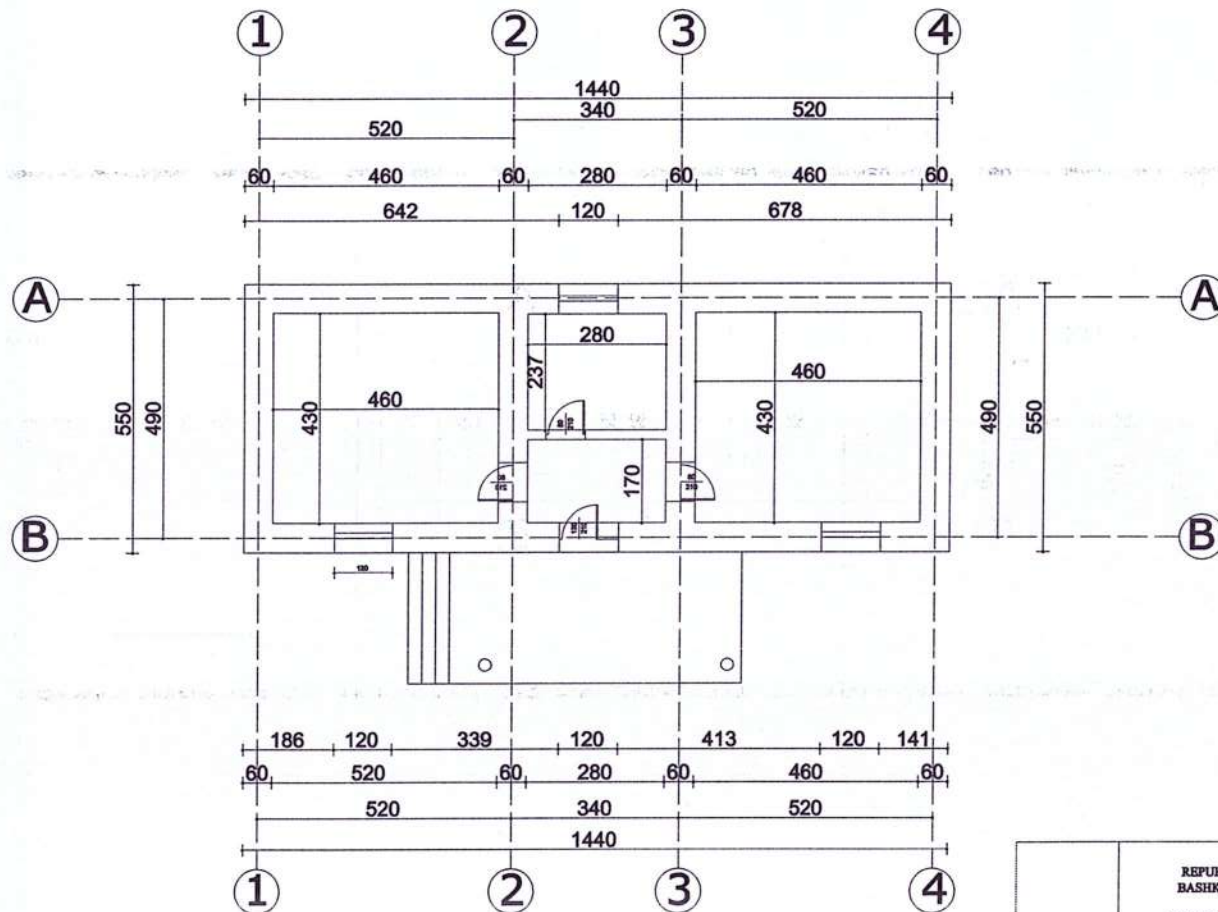

|  |  |   |  |   |
|--|--|---|--|---|
|  | REPUBLIKA E SHQIPERISË<br>BASHKIA URA VAJGURORË<br><br>DRETORIA E PLANIFIKIMIT TË<br>TERRITORIT, INVESTIMEVE,<br>KONTROLLIT TË PROJEKTEVE, E<br>SHËRBIMEVE PUBLIKE DHE STREHIMIT | DREJTOR<br>IDREJTORISË SE PLANIFIKIMIT TË<br>TERRITORIT, INVESTIMEVE,<br>KONTROLLIT TË PROJEKTEVE,<br>E SHËRBIMEVE PUBLIKE<br>DHE STREHIMIT | ARK. ALTIN PALI                                  |  |
| OBJEKTI:<br>Z.KADRI BEJTJA<br><br>FSHATI GAJDE | 2023   | SPECIALISTI TOPOGRAF<br><br>SPECIALISTI I ZYRES<br>SE URBANISTIKES  | TOP.IGRID SHKËMBI<br><br>ING. JULIANA ABDURAMANI |  |

# LANIMETRIA E ÇATISË BANESËS PAS RIKONSTRUKSIONIT SHK. 1:100

Z.KADRI BEJTJA

FSHATI GAJDE

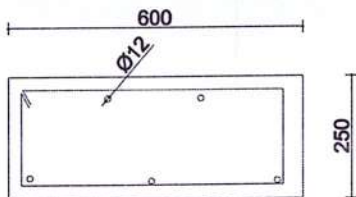
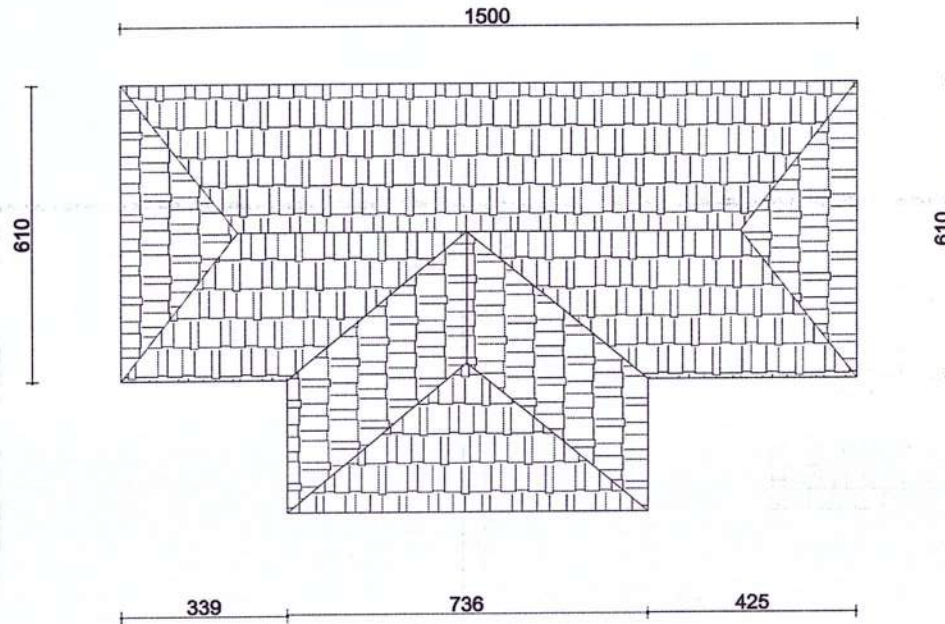

BREZ BETONARME  
SHKALLA 1:10

|                            |  |  |                         |  |
|----------------------------|--|--|-------------------------|--|
|                            | REPUBLIKA E SHQIPERISË<br>BASHKIA URA VAJGJURORË | DREJTOR<br>I DREJTORISË SE PLANIFIKIMIT TË<br>TERRITORIT, INVESTIMEVE,<br>KONTROLLIT TË PROJEKTEVE,<br>E SHËRBIMEVE PUBLIKE<br>DHE STREHIMIT | ARK. ALTIN PALI         |  |
| OBJEKTI:<br>Z.KADRI BEJTJA |  | SPECIALISTI TOPOGRAF   | TOP.IGRID SHKËMBI       |  |
| FSHATI GAJDE               | 2023   | SPECIALIST I ZYRES<br>SE URBANISTIKES  | ING. JULIANA ABDURAMANI |  |

# ANIMETRIA E ÇATISË BANESËS PAS RIKONSTRUKSIONIT SHK. 1:100

Z.KADRI BEJTJA

FSHATI GAJDE

SKEMA E ELEMENTEVE TE KAPRIATES KAP-1

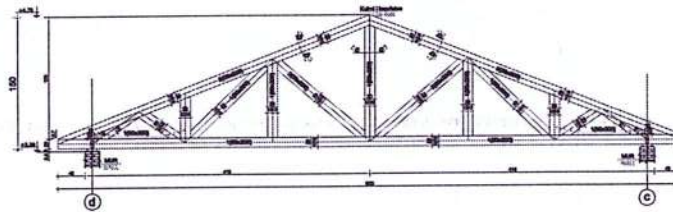

DETAJ D-1  
SHK 1:20

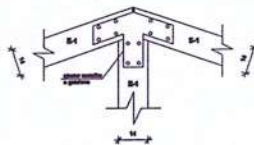

DETAJ D-2  
SHK 1:20

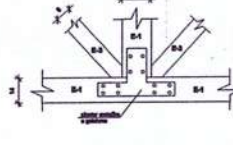

DETAJ D-3  
SHK 1:20

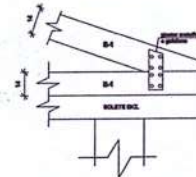

DETAJE  
SHKALLA 1:10

KULMI I KAPRIATES

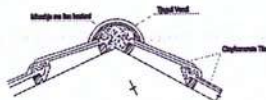

CATI ME T.JEGULLA MARSELJEZE



DETAJ 1

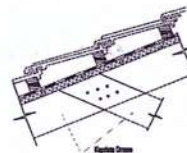

**SHENIM TIBORIC**  
 -Tregulla marseljeze  
 -Fajera ceto 25cm(4-3cm)  
 -Iqja afërta korbe korbe  
 -Shtrata detyroresh 4x2.5cm  
 -Kapriata detyroresh ceto .m

|                            |   |  |                         |   |
|----------------------------|---|--|-------------------------|---|
|                            | REPUBLIKA E SHQIPERISË<br>BASHKIA URA VAJGURORË<br><br>DREKTORIA E PLANIFIKIMIT TË<br>TERRITORIT, INVESTIMEVE,<br>KONTROLLIT TË PROJEKTEVE, E<br>SHËRBIMEVE PUBLIKE DHE STREHIMIT | DREKTOR<br>I DREJTORISË SE PLANIFIKIMIT TË<br>TERRITORIT, INVESTIMEVE,<br>KONTROLLIT TË PROJEKTEVE,<br>E SHËRBIMEVE PUBLIKE<br>DHE STREHIMIT | ARK. ALTIN PALI         |  |
| OBJEKTI:<br>Z.KADRI BEJTJA |   | SPECIALISTI TOPOGRAF   | TOP.IGRID SHKËMBI       |  |
| FSHATI GAJDE               | 2023  | SPECIALIST I ZYRES<br>SE URBANISTIKES  | ING. JULIANA ABDURAMANI |   |





# PLANIMETRIA E BANESËS PAS RIKONSTRUKSIONIT SHK. 1:100

Z.KASTRIOT SULOVARI

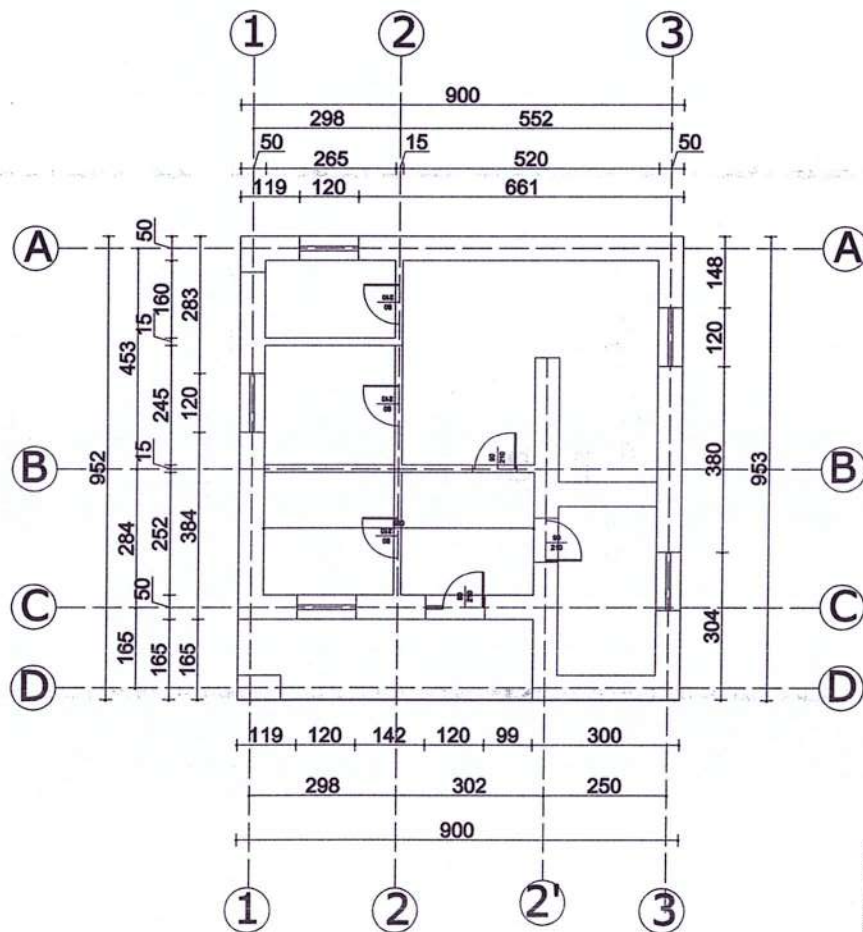
FSHATI KUTALLI



|  |   |   |  |
|--|---|---|--|
|  | REPUBLIKA E SHQIPERISË<br>BASHKIA URA VAJGURE<br><br>DREKTORIA E PLANIFIKIMIT TË<br>TERRITORIT, INVESTIMEVE,<br>KONTROLLIT TË PROJEKTEVE, E<br>SHËRBIMEVE PUBLIKE DHE STREHIMIT | DREJTOR<br>I DREJTORISE SE PLANIFIKIMIT TË<br>TERRITORIT, INVESTIMEVE<br>KONTROLLIT TË PROJEKTEVE,<br>E SHËRBIMEVE PUBLIKE<br>DHE STREHIMIT | ARK. ALTIN PALI<br><br> |
| OBJEKTI:<br>Z. KASTRIOT SULOVARI         | SPECIALISTI TOPOGRAF  | TOP.IGRID SHKËMBI<br><br>                              |  |
| FSHATI KUTALLI                      2023 | SPECIALISTI I ZYRES<br>SE URBANISTIKES  | ING. JULIANA ABDURAMANI<br><br>                        |  |

# PLANIMETRIA E CATISE SE BANESËS PAS RIKONSTRUKSIONIT SHK. 1:100

Z.KASTRIOT SULOVARI

FSHATI KUTALLI

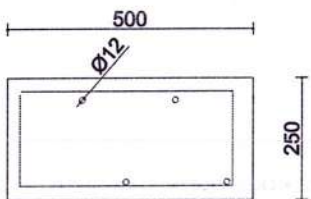
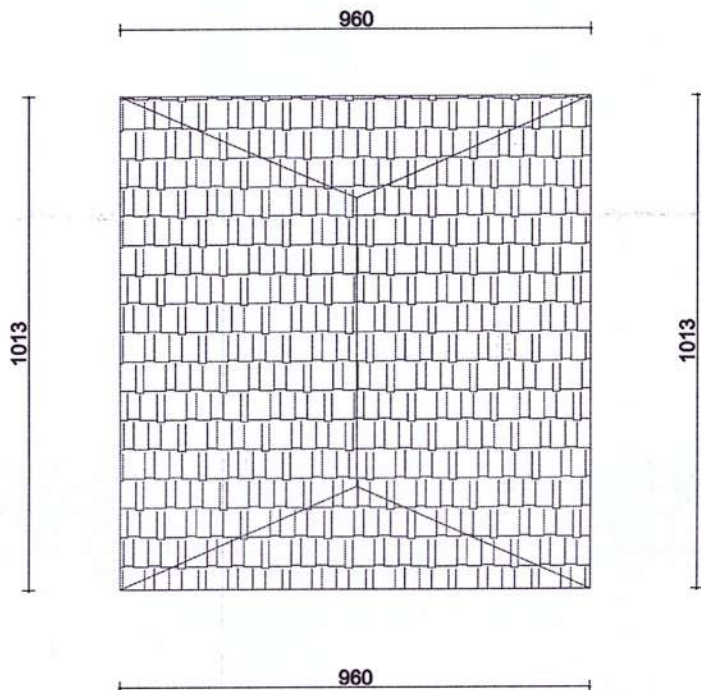

BREZ BETONARME  
SHKALLA 1:10

|  |   |  |   |
|--|---|--|---|
|  | REPUBLIKA E SHQIPERISË<br>BASHKIA URA VAJGURORË<br><br>DREJTORIA E PLANIFIKIMIT TË<br>TERRITORIT, INVESTIMEVE,<br>KONTROLLIT TË PROJEKTEVE, E<br>SHËRBIMEVE PUBLIKE DHE STREHIMIT | DREJTOR<br>I DREJTORISË SE PLANIFIKIMIT TË<br>TERRITORIT, INVESTIMEVE<br>,KONTROLLIT TË PROJEKTEVE,<br>E SHËRBIMEVE PUBLIKE<br>DHE STREHIMIT | ARK. ALTIN PALI                                  |
| OBJEKTI:<br>Z. KASTRIOT SULOVARI<br><br>FSHATI KUTALLI | 2023  | SPECIALISTI TOPOGRAF<br><br>SPECIALIST I ZYRES<br>SE URBANISTIKES  | TOPJGRID SHKËMBI<br><br>ING. JULIANA ABDURAMANI  |

# PLANIMETRIA E CATISE SE BANESËS PAS RIKONSTRUKSIONIT SHK. 1:100

## Z.KASTRIOT SULOVARI FSHATI KUTALLI

SKEMA E ELEMENTEVE TE KAPRIATES KAP-1

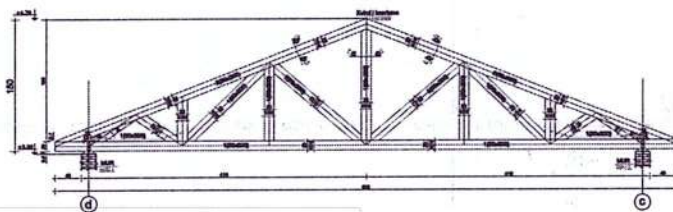

DETAJ D-1  
SHK 1:20

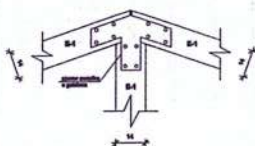

DETAJ D-2  
SHK 1:20

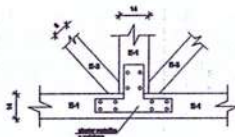

DETAJ D-3  
SHK 1:20

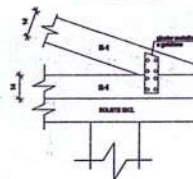

DETAJE  
SHKALLA 1:10

KULMB I KAPRIATES

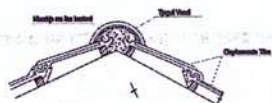

CATI ME TJEGULLA MARSELEJZE



DETAJ 1

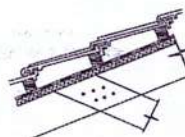

SHENIM TËRHOSE:  
-Të gjitha matësit  
-Të gjitha matësit (Shprehje e-Num)  
-Të gjitha matësit (Shprehje e-Num)  
-Të gjitha matësit (Shprehje e-Num)  
-Të gjitha matësit (Shprehje e-Num)

|                                  |   |  |                         |
|----------------------------------|---|--|-------------------------|
|                                  | REPUBLIKA E SHQIPERISË<br>BASHKIA URA VAJGURORË<br><br>DREJTORIA E PLANIFIKIMIT TË<br>TERRITORIT, INVESTIMEVE,<br>KONTROLLIT TË PROJEKTEVE, E<br>SHËRBIMEVE PUBLIKË DHE STREHIMIT | DREJTOR<br>I DREJTORISË SE PLANIFIKIMIT TË<br>TERRITORIT, INVESTIMEVE,<br>KONTROLLIT TË PROJEKTEVE,<br>E SHËRBIMEVE PUBLIKË<br>DHE STREHIMIT | ARK. ALTIN PALI         |
| OBJEKTI:<br>Z. KASTRIOT SULOVARI |   | SPECIALISTI TOPOGRAF   | TOP.IGRID SHKËMBI       |
| FSHATI KUTALLI                   | 2023  | SPECIALISTI I ZYRES<br>SE URBANISTIKES   | ING. JULIANA ABDURAMANI |



# PLANIMETRIA E BANESËS PAS RIKONSTRUKSIONIT SHK. 1:100

Z. KLODIAN MEMA FSHATI QAMICE

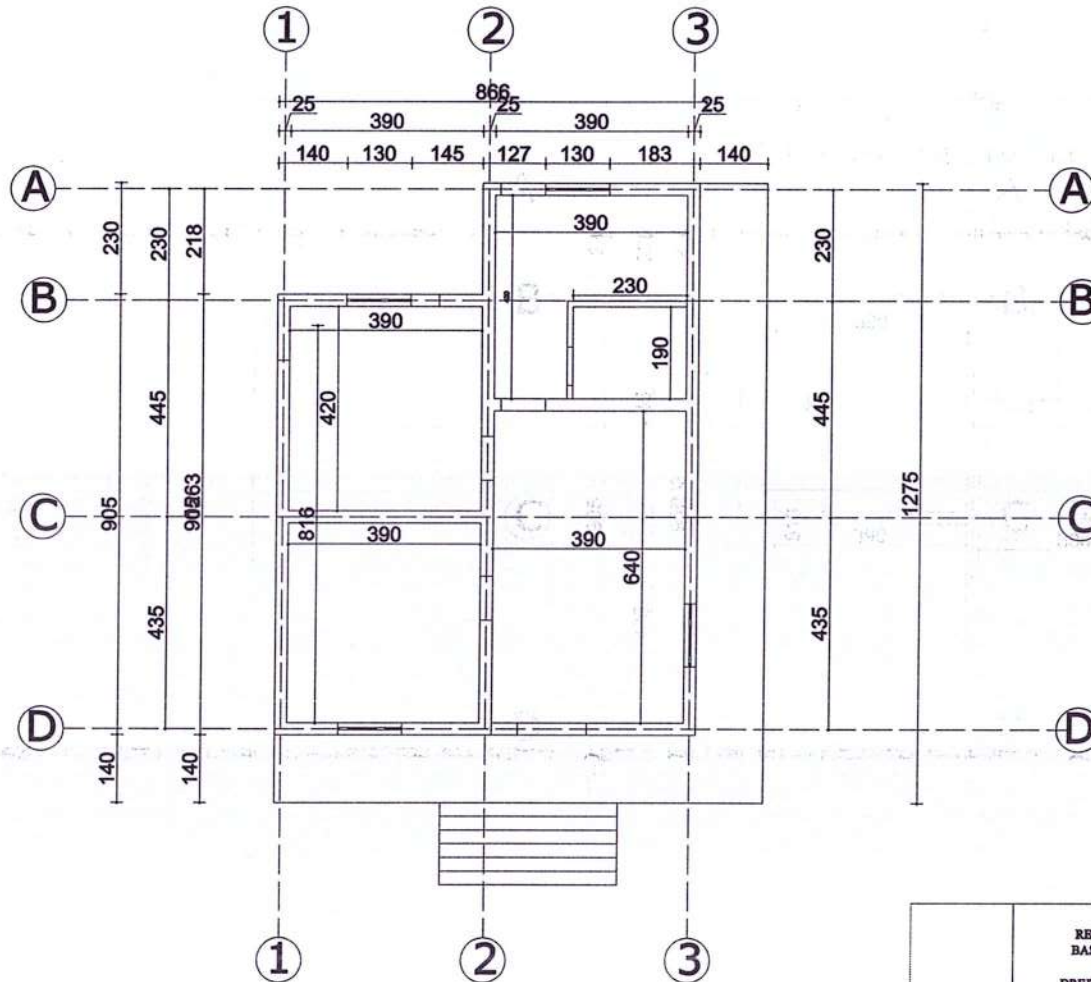

|   |   |   |                         |
|---|---|---|-------------------------|
|   | REPUBLIKA E SHQIPERISË<br>BASHKIA URA VAJGÛRORE<br><br>DREJTORIA E PLANIFIKIMIT TË<br>TERRITORIT, INVESTIMEVE,<br>KONTROLLIT TË PROJEKTEVE, E<br>SHËRBIMEVE PUBLIKE DHE STREHIMIT | DREJTOR<br>I DREJTORISË E PLANIFIKIMIT TË<br>TERRITORIT, INVESTIMEVE,<br>KONTROLLIT TË PROJEKTEVE,<br>E SHËRBIMEVE PUBLIKE<br>DHE STREHIMIT | ARK. ALTIN PALI         |
| OBJEKTI:<br>Z. KLODIAN MEMA             |   | SPECIALISTI TOPOGRAF  | TOP.IGRID SHKËMBI       |
| FSHATI QAMICE                      2023 |   | SPECIALIST I ZYRES<br>SE URBANISTIKES   | ING. JULIANA ABDURAMANI |

# PLANIMETRIA E CATISE SE BANESËS PAS RIKONSTRUKSIONIT SHK. 1:100

Z. KLODIAN MEMA FSHATI QAMICE

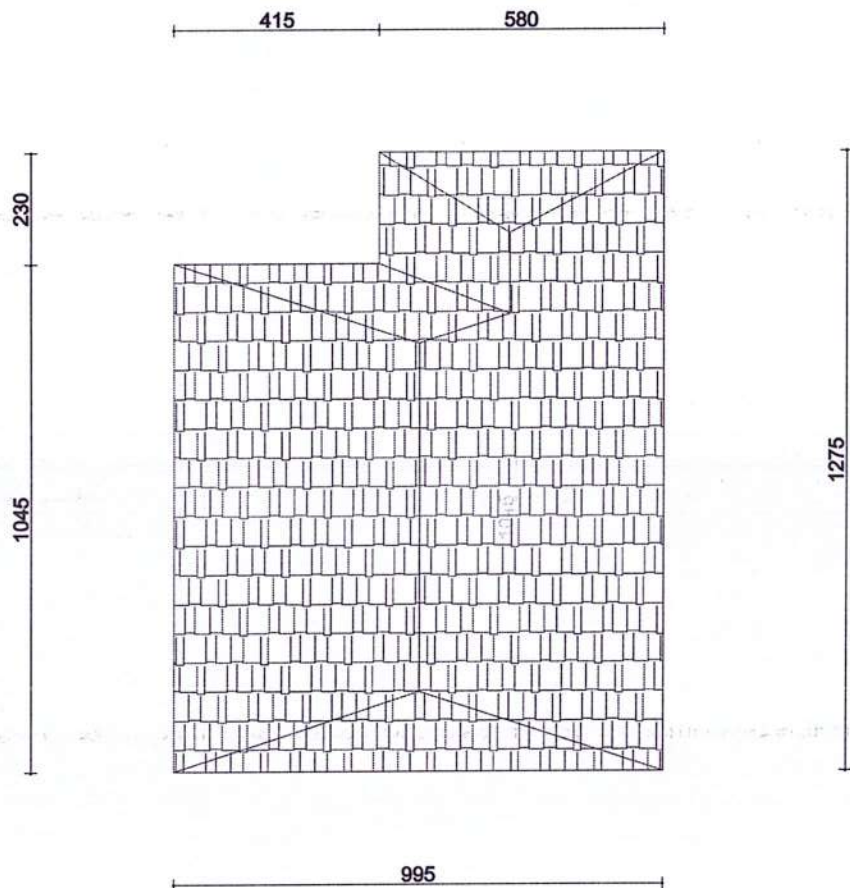

|                             |   |  |   |
|-----------------------------|---|--|---|
|                             | REPUBLIKA E SHQIPERISË<br>BASHKIA URA VAJGURORË<br><br>DREJTORIA E PLANIFIKIMIT TË<br>TERRITORIT, INVESTIMEVE,<br>KONTROLLIT TË PROJEKTEVE, E<br>SHËRBIMEVE PUBLIKE DHE STREHIMIT | DREJTOR<br>I DREJTORISË SE PLANIFIKIMIT TË<br>TERRITORIT, INVESTIMEVE,<br>KONTROLLIT TË PROJEKTEVE,<br>E SHËRBIMEVE PUBLIKE<br>DHE STREHIMIT | ARK. ALTIN PALI          |
| OBJEKTI:<br>Z. KLODIAN MEMA |   | SPECIALISTI TOPOGRAF   | TOP.IGRID SHKËMBI        |
| FSHATI QAMICE      2023     |   | SPECIALIST I ZYRES<br>SE URBANISTIKES  | ING. JULIANA ABDURAMANI  |

# PLANIMETRIA E CATISE SE BANESËS PAS RIKONSTRUKSIONIT SHK. 1:100

Z. KLODIAN MEMA FSHATI QAMICE

SKEMA E ELEMENTEVE TE KAPRIATES KAP-1

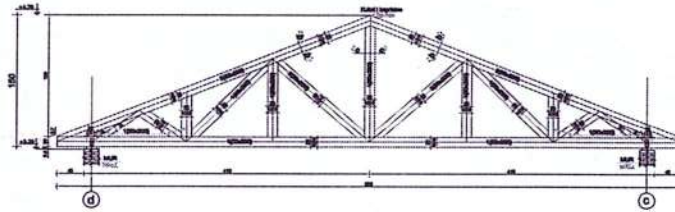

DETAJ D-1  
SHK 1:20

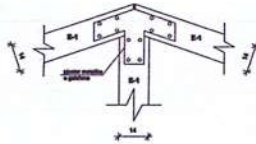

DETAJ D-2  
SHK 1:20

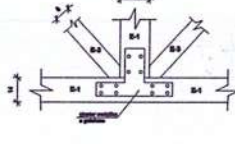

DETAJ D-3  
SHK 1:20

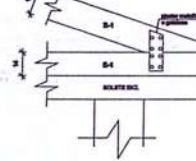

DETAJE  
SHKALLA 1:10

KULMI I KAPRIATES

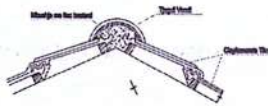

CATI ME T.JEGULLA MARSELEZE



DETAJ 1

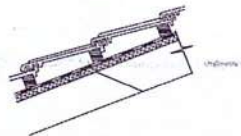

**SHENIM TEKNIK**  
 -Treguesi i materialit  
 -Faqja ose 35cm(4-5cm)  
 -Ngjësia e kufirit horizontal  
 -Dhërrasë e dorës së d=2,5cm  
 -Kapriatë e dorës së d=...m

|                             |   |  |  |
|-----------------------------|---|--|--|
|                             | REPUBLIKA E SHQIPERISË<br>BASHKIA URA VAJGURE<br><br>DREJTORIA E PLANIFIKIMIT TË<br>TERRITORIT, INVESTIMEVE,<br>KONTROLLIT TË PROJEKTEVE, E<br>SHËRBIMEVE PUBLIKE DHE STREHIMIT | DREJTOR<br>I DREJTORISË SE PLANIFIKIMIT TË<br>TERRITORIT, INVESTIMEVE,<br>KONTROLLIT TË PROJEKTEVE,<br>E SHËRBIMEVE PUBLIKE<br>DHE STREHIMIT | ARK. ALTIN PALI<br><br><br>         |
| OBJEKTI:<br>Z. KLODIAN MEMA |   | SPECIALISTI TOPOGRAF   | TOP.IGRID SHKËMBI<br><br><br>       |
| FSHATI QAMICE               | 2023  | SPECIALISTI I ZYRES<br>SE URBANISTIKES   | ING. JULIANA ABDURAMANI<br><br><br> |



# PLANIMETRIA E BANESËS PAS RIKONSTRUKSIONIT SHK. 1:100

Z.LUAN TOSKANJ

FSHATI SKREVAN

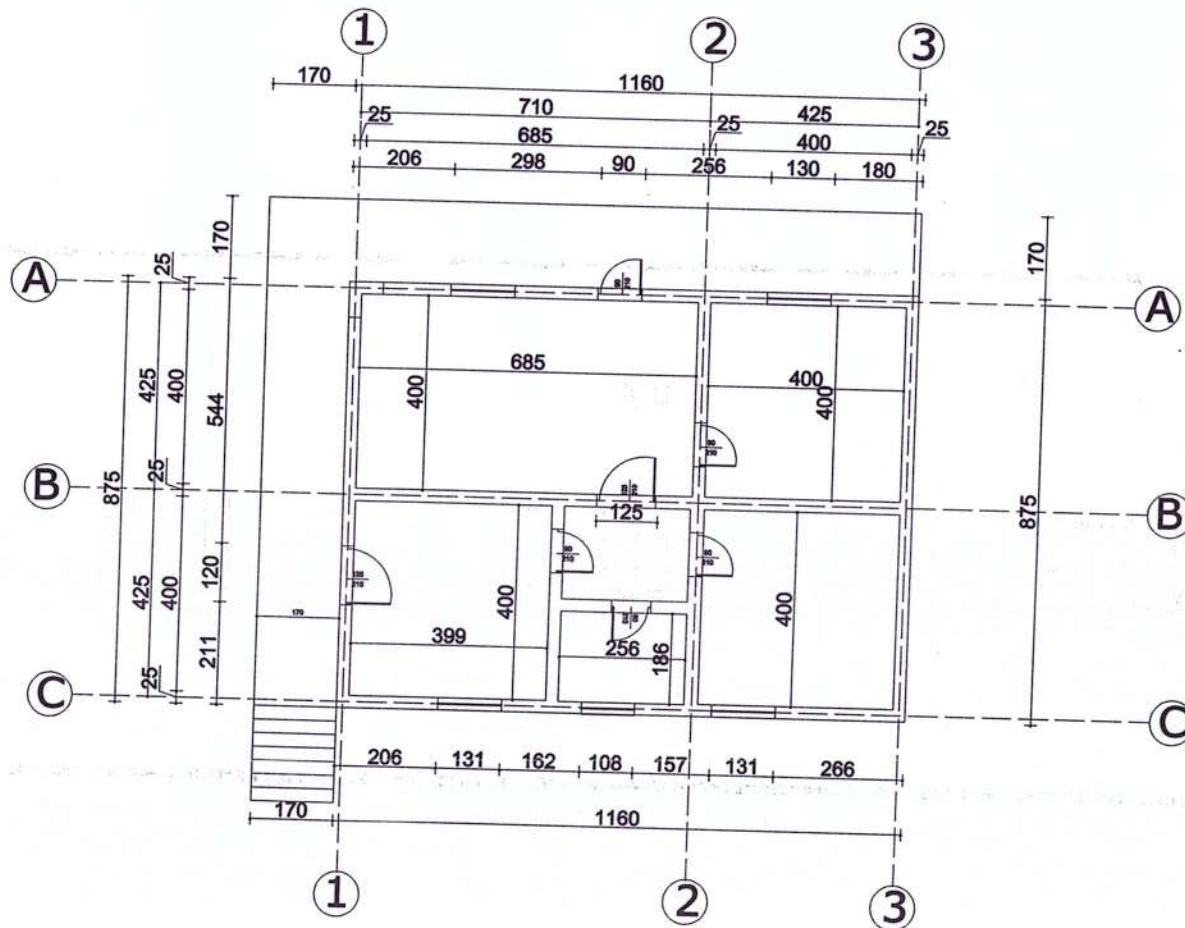

|                             |   |  |   |
|-----------------------------|---|--|---|
|                             | REPUBLIKA E SHQIPERISË<br>BASHKIA URA VAJGURORË<br><br>DREKTORIA E PLANIFIKIMIT TË<br>TERRITORIT, INVESTIMEVE,<br>KONTROLLIT TË PROJEKTEVE, E<br>SHËRBIMEVE PUBLIKE DHE STREHIMIT | DREJTOR<br>I DREJTORISË SE PLANIFIKIMIT TË<br>TERRITORIT, INVESTIMEVE,<br>KONTROLLIT TË PROJEKTEVE,<br>E SHËRBIMEVE PUBLIKE<br>DHE STREHIMIT | ARK. ALTIN PALI          |
| OBJEKTI:<br>Z. LUAN TOSKANJ |   | SPECIALISTI TOPOGRAF   | TOP.IGRID SHKËMBI        |
| FSHATI SKREVAN              | 2023  | SPECIALIST I ZYRES<br>SE URBANISTIKES  | ING. JULIANA ABDURAMANI  |

# PLANIMETRIA E CATISE SE BANESËS PAS RIKONSTRUKSIONIT SHK. 1:100

Z.LUAN TOSKANJ

FSHATI SKREVAN

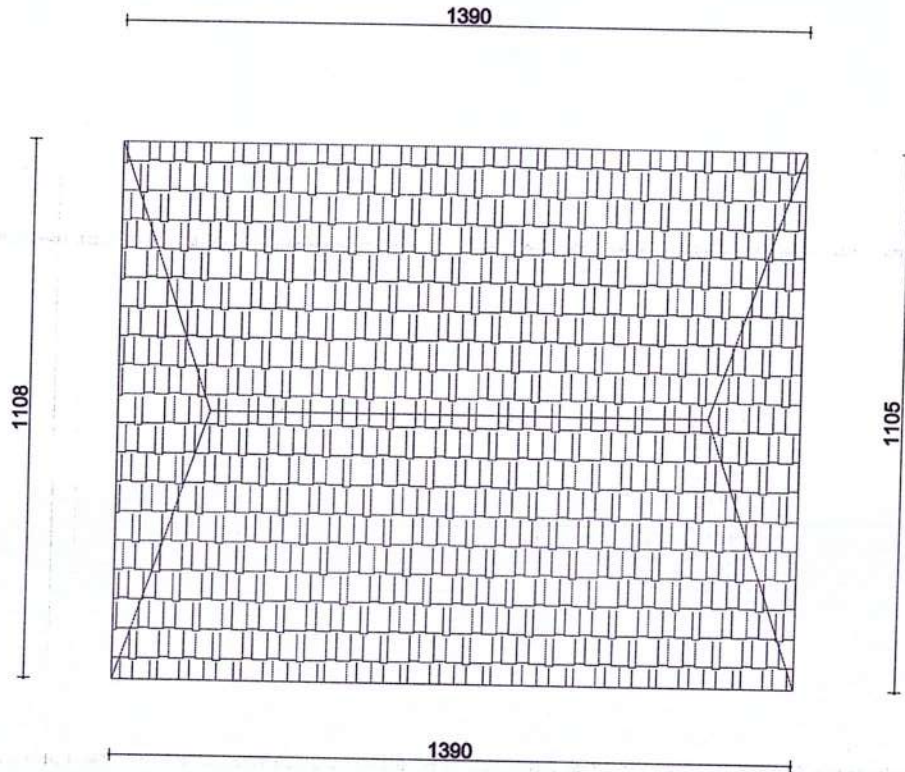

|   |   |   |   |
|---|---|---|---|
|   | REPUBLIKA E SHQIPERISË<br>BASHKIA URA VAJGURORË<br><br>DREKTORIA E PLANIFIKIMIT TË<br>TERRITORIT, INVESTIMEVE,<br>KONTROLLIT TË PROJEKTEVE, E<br>SHËRBIMEVE PUBLIKE DHE STREHIMIT | DREJTOR<br>I DREKTORISË SE PLANIFIKIMIT TË<br>TERRITORIT, INVESTIMEVE<br>KONTROLLIT TË PROJEKTEVE,<br>E SHËRBIMEVE PUBLIKE<br>DHE STREHIMIT   | ARK. ALTIN PALI  |
| OBJEKTI:<br>Z. LUAN TOSKANJ<br><br>FSHATI SKREVAN      2023 | SPECIALISTI TOPOGRAF<br><br>SPECIALIST I ZYRES<br>SE URBANISTIKES   | TOP.IGRID SHKËMBI<br><br>ING. JULIANA ABDURAMANI <br> |   |

# PLANIMETRIA E CATISE SE BANESËS PAS RIKONSTRUKSIONIT SHK. 1:100

Z.LUAN TOSKANJ FSHATI SKREVAN

SHKEMA E ELEMENTEVE TE KAPRIATES KAP-1

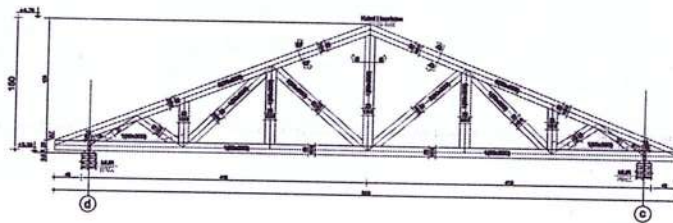

DETAJ D-1  
SHK 1:20

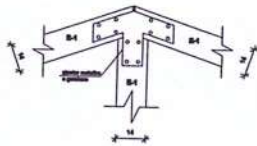

DETAJ D-2  
SHK 1:20

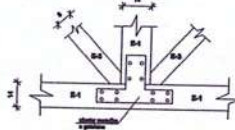

DETAJ D-3  
SHK 1:20

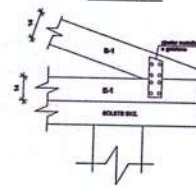

DETAJE  
SHKALLA 1:10

KULMI I KAPRIATES

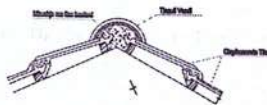

CATI ME T.JEGULLA MARSELIEZE

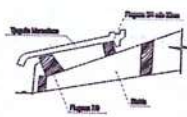

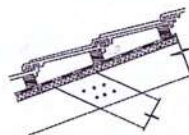

DETAJ 1

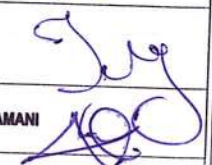

**SHENIM TEBORIC:**

- Tjeguulla marselieze
- Pjegura ebe 30cm(+8cm)
- Nje shtrime karton letror
- Shtrime dermansh d=0.5cm
- Kapriate dermansh ebe .20

|                             |  |   |  |
|-----------------------------|--|---|--|
|                             | REPUBLIKA E SHQIPERISE<br>BASHKIA URA VAJGJORE<br><br>DREJTORIA E PLANIFIKIMIT TE<br>TERRITORIT, INVESTIMEVE,<br>KONTROLLIT TE PROJEKTEVE, E<br>SHERBIMEVE PUBLIKE DHE STREHIMIT | DREJTOR<br>I DREJTORES SE PLANIFIKIMIT TE<br>TERRITORIT, INVESTIMEVE,<br>KONTROLLIT TE PROJEKTEVE,<br>E SHERBIMEVE PUBLIKE<br>DHE STREHIMIT | ARK. ALTIN PALI<br><br>         |
| OBJEKTI:<br>Z. LUAN TOSKANJ |  | SPECIALISTI TOPOGRAF  | TOP.IGRID SHKËMBI<br><br>       |
| FSHATI SKREVAN<br>2023      |  | SPECIALIST I ZYRES<br>SE URBANISTIKES   | ING. JULIANA ABDURAMANI<br><br> |



PLANIMETRIA EKZISTUESE E OBJEKTIT  
z.Myslim Zeka Fshati Hinge

SH 1:200

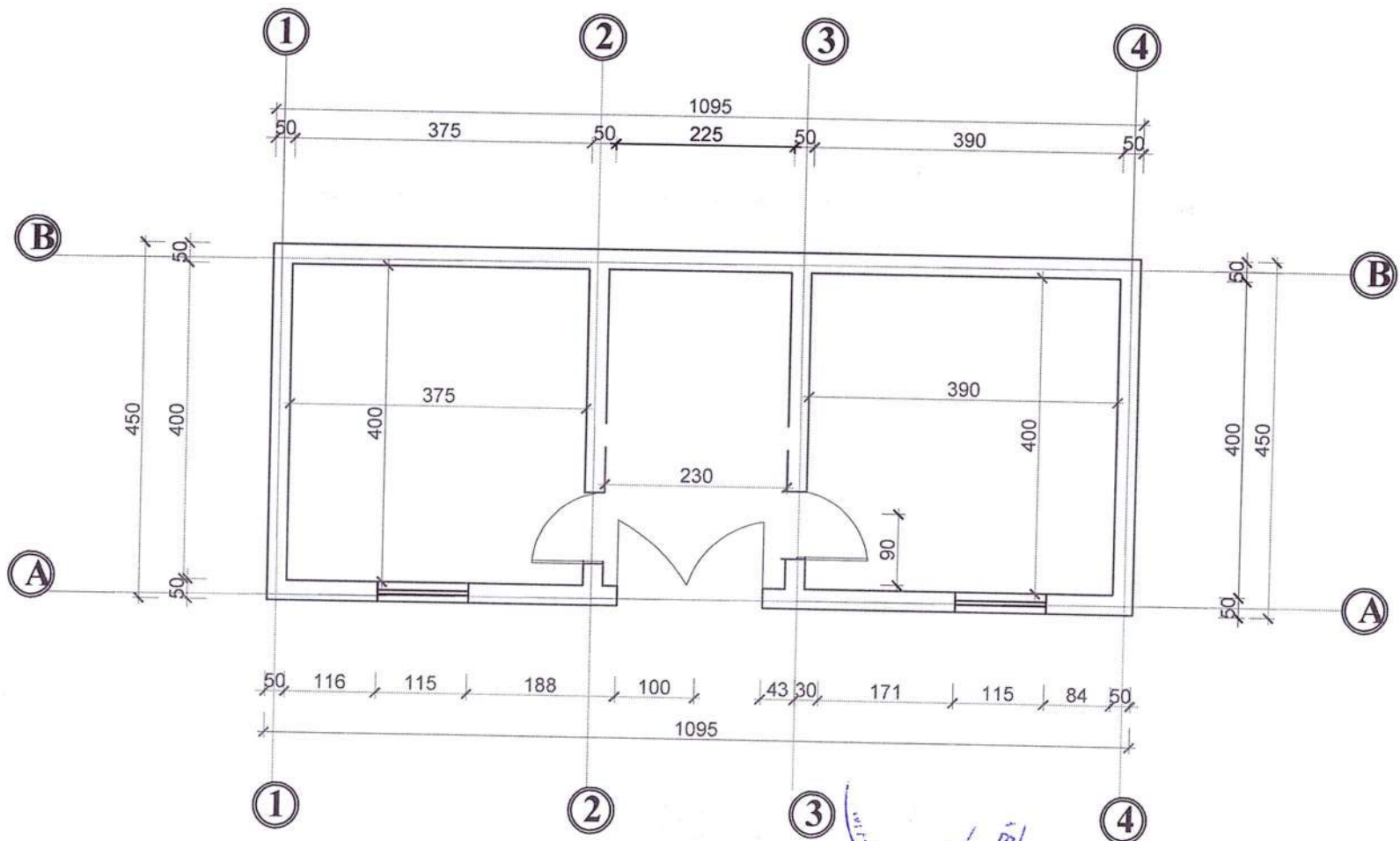

|  |   |                   |  |
|--|---|-------------------|--|
| REPUBLIKA E SHQIPERISE<br>BANKOGJIA URA VAJZORORE            | DIREKTOR<br>DIREKTORISE ME PLANIMETRI TE<br>TERRESTRIT ANVETISTORIVE,<br>KONTROLLIT TE PROJEKTEVE,<br>E SHIKIMEVE PUBLIKE<br>DHE STRUKTURIT | ARK. ALTIN PALI   |  |
| OBJEKTI:<br>PLANIMETRIA EKZISTUESE E BANESQ<br>Z.Myslim Zeka | SPECIALISTI TOPOGRAF  | TOP.IGRID SHKEMBI |  |
| FSHATI HINGE   | SPECIALISTI ZYRES<br>SE URBANISTIKES  | TEK. MALVINA DAKA |  |
| 2022   |   |                   |  |

# PLANIMETRIA E BREZIT ANTISIZMIK TE RI DHE ARMIMI I TIJ

SH. 1:150

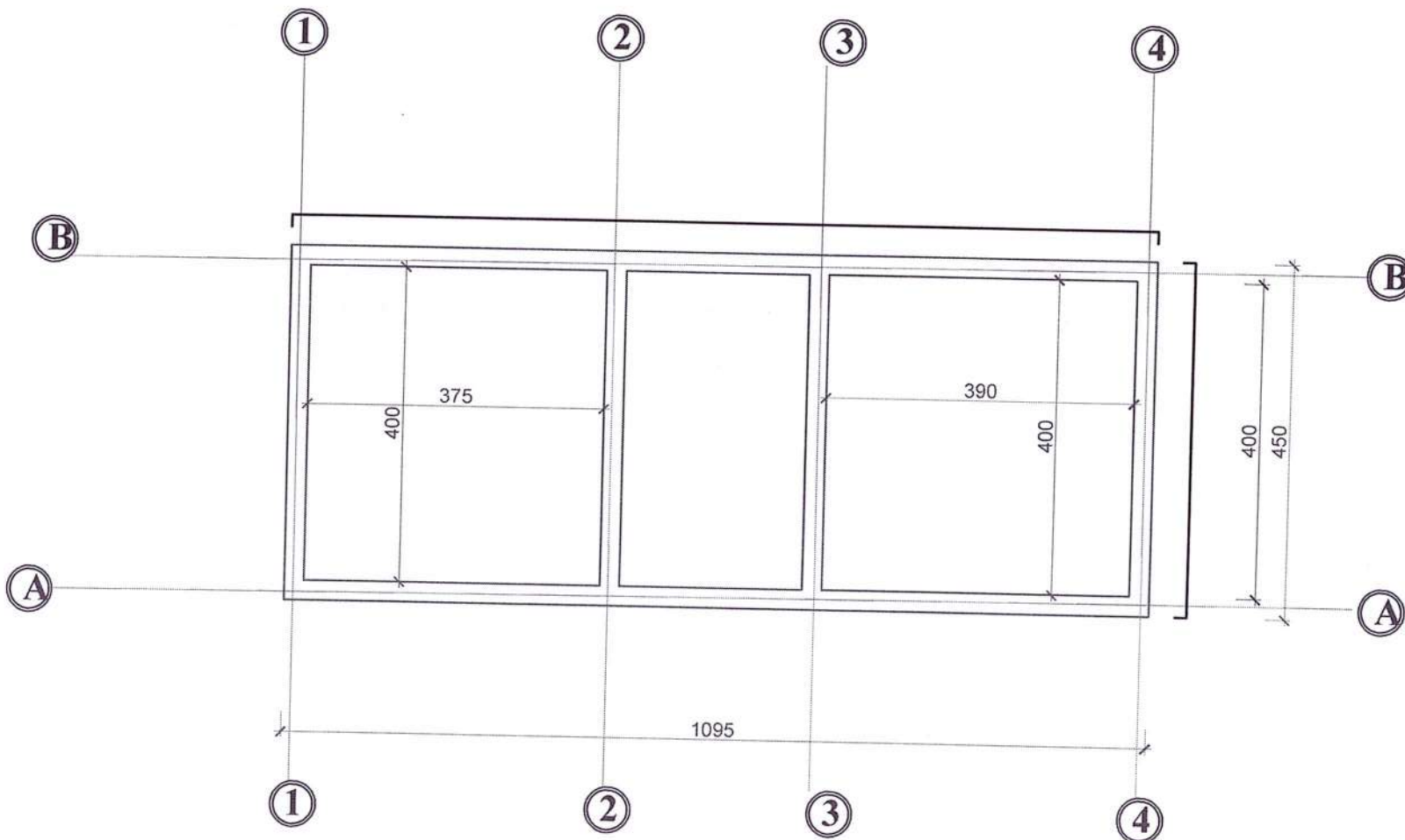

PRERJE TIP E BREZIT

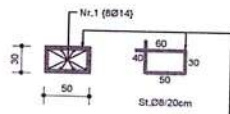

|              |  |  |                   |  |
|--------------|--|--|-------------------|--|
|              | REPUBLIKA E SHQERISE<br>BASHKIA URA VAJGJORE | DREZITON<br>DIREKTORINAT E PLANIFIKIMIT I<br>TERRITORIT INVESTIMIVE<br>KONTROLLIT TE PROJEKTEVE,<br>E MIERHIMIVE PUBLIKE<br>DHE KREDIMIT | ARK. ALTIN PALI   |  |
| OBJEKTI:     | ARMIMI I BREZIT ANTISIZMIK<br>2. Mylym Zeqa  | SPECIALISTI TOPOGRAF   | TOPJGRID SHKËMBI  |  |
| FSHATI HINGË | 2022   | SPECIALISTI I ZYRES<br>SE URBANISTIKES   | TEK. MALVINA DAKA |  |

# PLANIMETRIA E ÇATISE SE OBJEKTIT

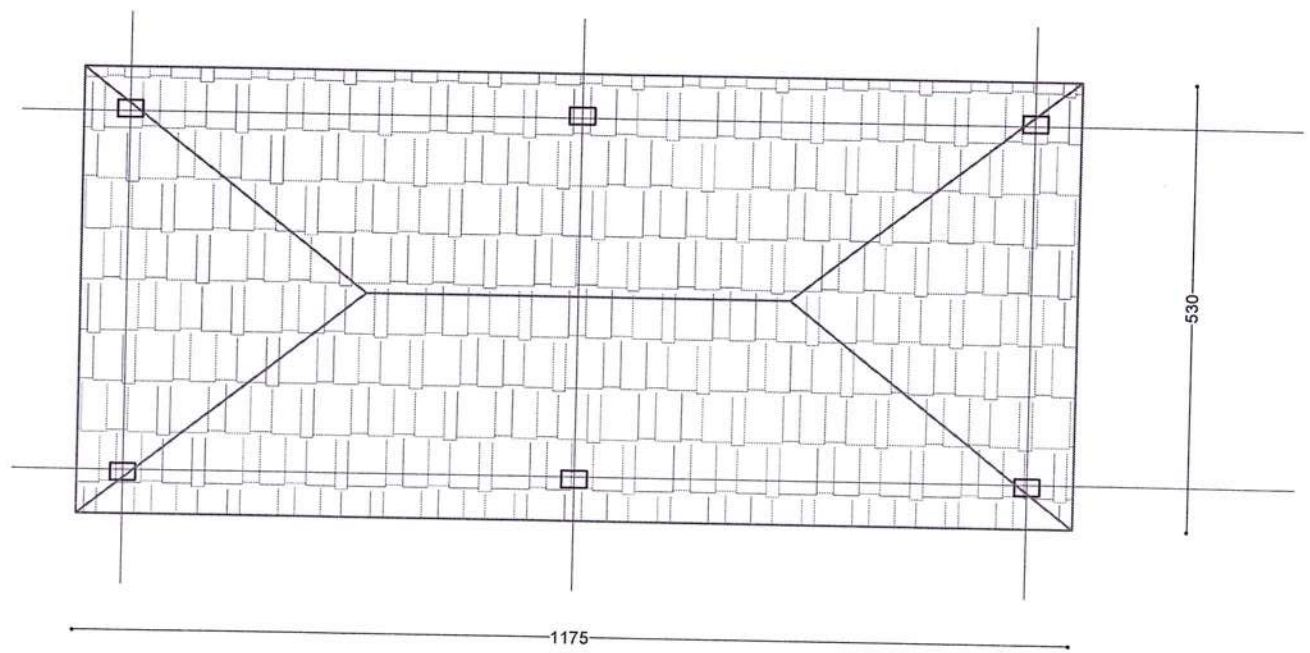

|  |   |  |                                       |   |
|--|---|--|---------------------------------------|---|
|  | REPUBLIKA E SHQIPËRISE<br>BASHKËVËNIMI URBAN<br>DREJTORIA E PLANIMIT DHE BASHKËVËNIMIT URBAN<br>KONTROLLI I PROJEKTEVE, E SHËRBIMEVE PUBLIKE DHE STRUKTURIT | DREJTORI<br>I SHËRBIMEVE URBANISTIKE DHE<br>KONTROLLIT I PROJEKTEVE, E SHËRBIMEVE PUBLIKE DHE STRUKTURIT | ARK. ALTRIN PALI                      |  |
| OBJEKTI:<br>PLANIMETRIA E ÇATISE<br>Z. Myslim Zejka<br>FSHATI POSHULJE | 2022  | SPECIALISTI TOPOGRAF<br>SPECIALISTI I ZYRËS<br>SE URBANISTIKES   | TOPJGRID SHKËMBI<br>TEK. MALVINA DAKA |  |



# SKEMA E ELEMENTEVE TE KAPRIATES KAP-1

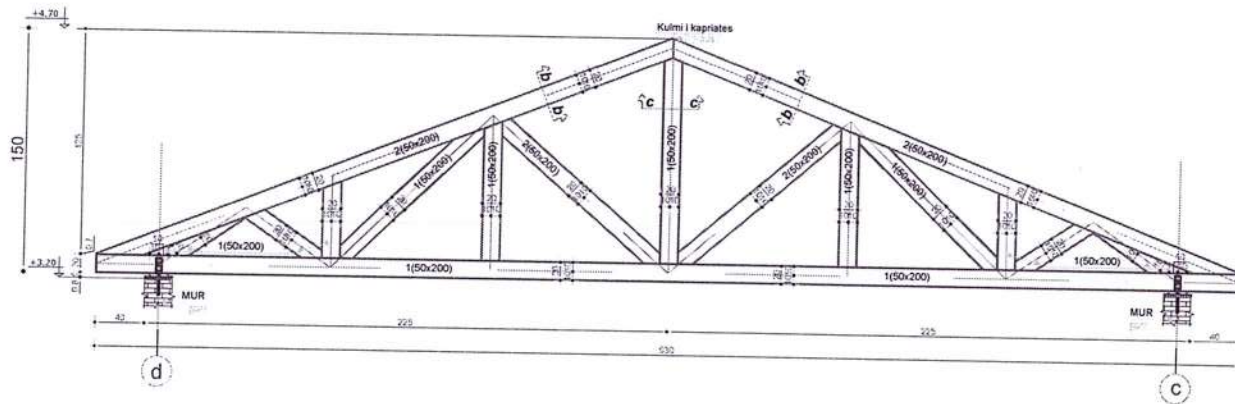

DETAJ D-1  
SHK 1:20

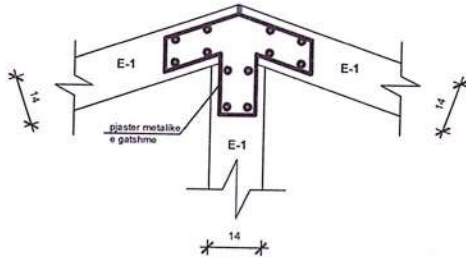

DETAJ D-2  
SHK 1:20

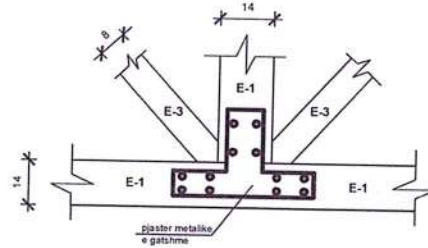

DETAJ D-3  
SHK 1:20

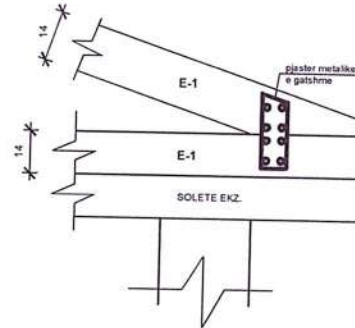

|  |  |  |                   |  |
|--|--|--|-------------------|--|
|  | REPUBLIKA E SHQIPERISE<br>BASHKIA URA VAJGRORE | DIKTOR<br>I DREKTORES SE PLANIFIKIMIT TE<br>TERRITORIT INVESTIMEVE<br>KONTROLLIT TE PROJEKTEVE<br>E SHERBIMEVE PUBLIKE<br>DHE STRUKTURIT | ARK. ALTHI PALI   |  |
| OBJEKTI:<br>SKEMA E ELEMENTEVE TE KAPRIATES<br>Z. Myqim Zeka |  | SPECIALISTI TOPOGRAF   | TOPJGRID SHKËMBI  |  |
| FSHATI/HINDE<br>2022   |  | SPECIALISTI ZYRES<br>SE URBANISTIKES   | TEK. MALVINA DAKA |  |

# ANIMETRIA E BANESËS PAS RIKONSTRUKSIONIT SHK. 1:100

Z.PËLLUMB KAPAJ

FSHATI ÇETË

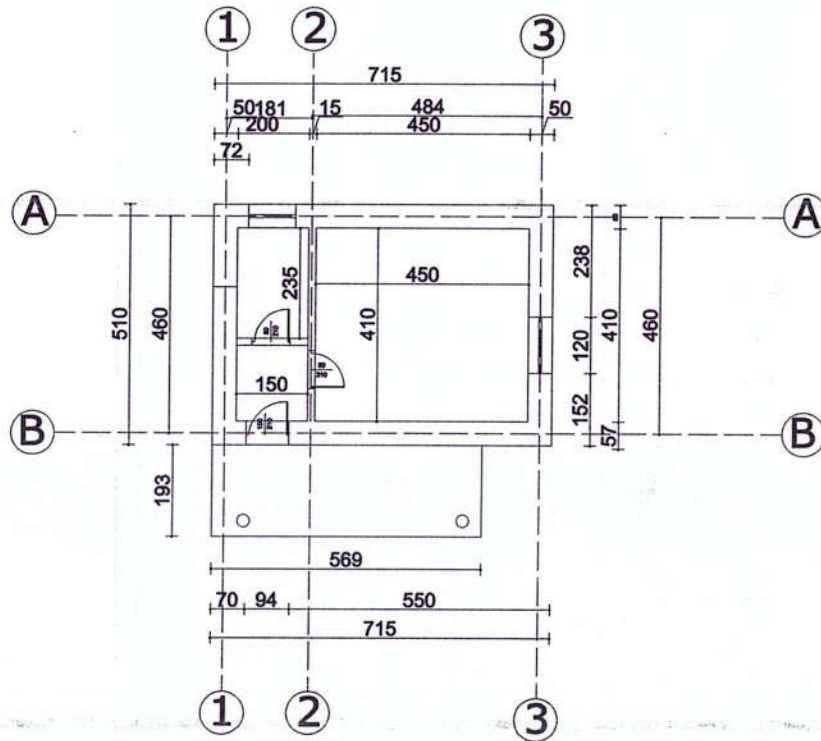

|                                       |  |   |  |
|---------------------------------------|--|---|--|
|                                       | REPUBLIKA E SHQIPERISË<br>BASHKIA URA VAJGJURORË<br><br>DREJTORIA E PLANIFIKIMIT TË<br>TERRITORIT, INVESTIMEVE,<br>KONTROLLIT TË PROJEKTEVE, E<br>SHËRBIMEVE PUBLIKE DHE STREHIMIT | DREJTOR<br>I DREJTORISË SE PLANIFIKIMIT TË<br>TERRITORIT, INVESTIMEVE<br>KONTROLLIT TË PROJEKTEVE,<br>E SHËRBIMEVE PUBLIKE<br>DHE STREHIMIT | ARK. ALTIN PALI<br>         |
| OBJEKTI:<br>Z.PËLLUMB KAPAJ           |  | SPECIALISTI TOPOGRAF  | TOP.IGRID SHKËMBI<br>       |
| FSHATI ÇETË                      2023 |  | SPECIALISTI I ZYRES<br>SE URBANISTIKES  | ING. JULIANA ABDURAMANI<br> |

# PLANIMETRIA E CATISE SE BANESËS PAS RIKONSTRUKSIONIT SHK. 1:100

Z.PËLLUMB KAPAJ

FSHATI ÇETË

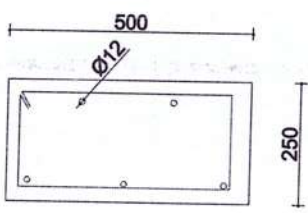
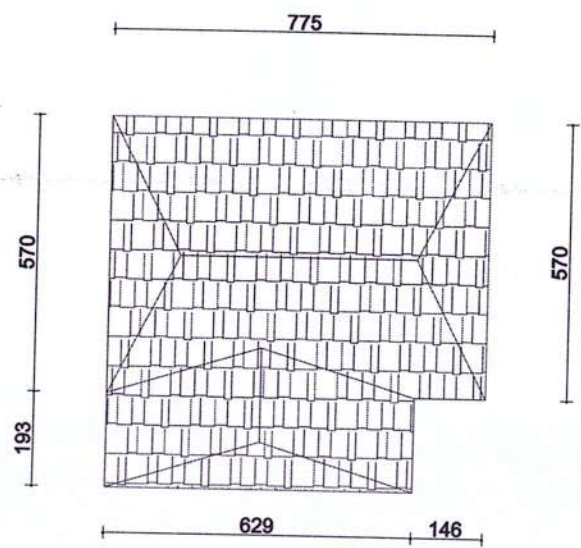

BREZ BETONARME  
SHKALLA 1:10

|                                       |   |  |   |
|---------------------------------------|---|--|---|
|                                       | REPUBLIKA E SHQIPERISË<br>BASHKIA URA VAJGURORË<br><br>DREJTORIA E PLANIFIKIMIT TË<br>TERRITORIT, INVESTIMEVE,<br>KONTROLLIT TË PROJEKTEVE, E<br>SHËRBIMEVE PUBLIKE DHE STREHIMIT | DREJTOR<br>I DREJTORISË SE PLANIFIKIMIT TË<br>TERRITORIT, INVESTIMEVE,<br>KONTROLLIT TË PROJEKTEVE,<br>E SHËRBIMEVE PUBLIKE<br>DHE STREHIMIT | ARK. ALTIN PALI          |
| OBJEKTI:<br>Z.PËLLUMB KAPAJ           |   | SPECIALISTI TOPOGRAF   | TOP.IGRID SHKËMBI        |
| FSHATI ÇETË                      2023 |   | SPECIALIST I ZYRES<br>SE URBANISTIKES  | ING. JULIANA ABDURAMANI  |



# PLANIMETRIA E CATISE SE BANESËS PAS RIKONSTRUKSIONIT SHK. 1:100

Z.PËLLUMB KAPAJ

FSHATI ÇETË

SKEMA E ELEMENTEVE TE KAPRIATES KAP-1

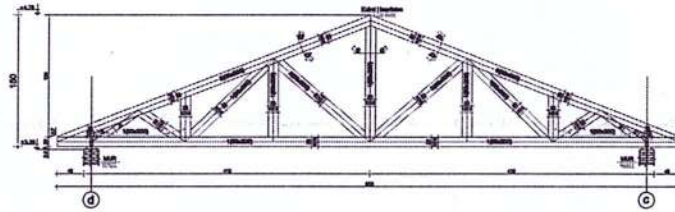

DETAJ D-1  
SHK 1:20

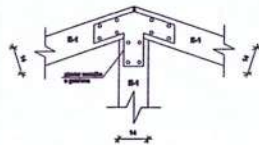

DETAJ D-2  
SHK 1:20

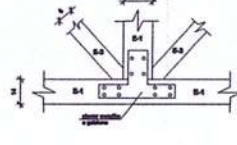

DETAJ D-3  
SHK 1:20

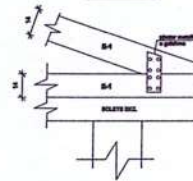

DETAJE  
SHKALLA 1:10

KULMI I KAPRIATES

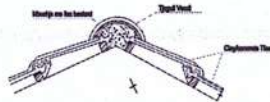

CATI ME TJEJULLA MARSELIEZE



DETAJ 1

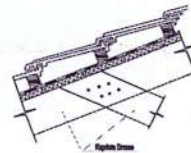

**SHENIM TEOHNIK:**

- Treguesi numerik
- Ngjyra e bardhe (4-3cm)
- Ngjyra e zezë (4-3cm)
- Shprehja e dimensionit (m)
- Kaptimet e dimensionit (m)

|                             |   |  |   |
|-----------------------------|---|--|---|
|                             | REPUBLIKA E SHQIPERISË<br>BASHKIA URA VAJGURORË<br><br>DREKTORIA E PLANIFIKIMIT TË<br>TERRITORIT, INVESTIMEVE,<br>KONTROLLIT TË PROJEKTEVE, E<br>SHËRBIMEVE PUBLIKE DHE STREHIMIT | DREJTOR<br>I DREKTORISE SE PLANIFIKIMIT TË<br>TERRITORIT, INVESTIMEVE,<br>KONTROLLIT TË PROJEKTEVE,<br>E SHËRBIMEVE PUBLIKE<br>DHE STREHIMIT | ARK. ALTIN PALI          |
| OBJEKTI:<br>Z.PËLLUMB KAPAJ |   | SPECIALISTI TOPOGRAF   | TOP.IGRID SHKËMBI        |
| FSHATI ÇETË                 | 2023  | SPECIALIST I ZYRES<br>SE URBANISTIKES  | ING. JULIANA ABDURAMANI  |

# LANIMETRIA E BANESËS PAS RIKONSTRUKSIONIT SHK. 1:100

Z. PETRIT KALIVACI URE VAJGURORE

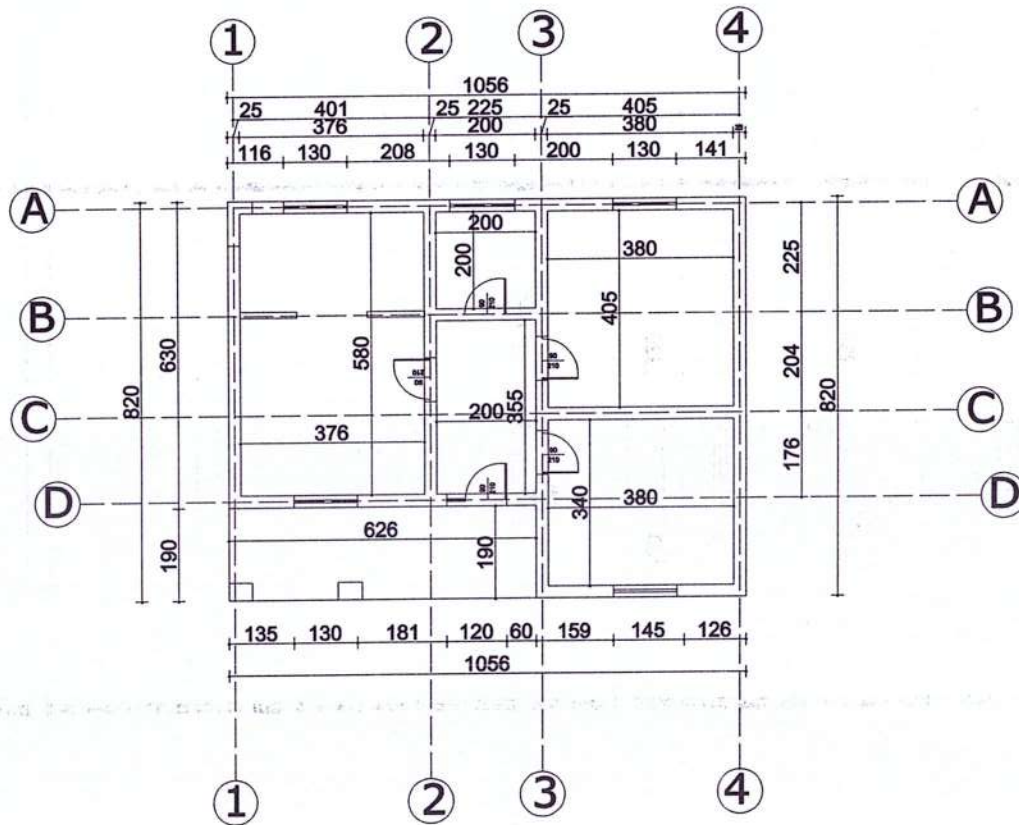

|                                |  |  |  |
|--------------------------------|--|--|--|
|                                | REPUBLIKA E SHQIPERISË<br>BASHKIA URA VAJGURORE<br><br>DRETORIA E PLANIFIKIMIT TË<br>TERRITORIT, INVESTIMEVE,<br>KONTROLLIT TË PROJEKTEVE, E<br>SHËRBIMEVE PUBLIKE DHE STREHIMIT | DREJTOR<br>I DREKTORISE SE PLANIFIKIMIT TË<br>TERRITORIT, INVESTIMEVE,<br>KONTROLLIT TË PROJEKTEVE,<br>E SHËRBIMEVE PUBLIKE<br>DHE STREHIMIT | ARK. ALTIN PALI<br><br><br> |
| OBJEKTI:<br>Z. PETRIT KALIVACI |  | SPECIALISTI TOPOGRAF   | TOP.IGRID SHKËMBI  |
| FSHATI PASHALLI      2023      |  | SPECIALISTI I ZYRES<br>SE URBANISTIKES   | ING. JULIANA ABDURAMANI  |

# PLANIMETRIA E CATISE SE BANESËS PAS RIKONSTRUKSIONIT SHK. 1:100

Z. PETRIT KALIVACI URE VAJGURORE

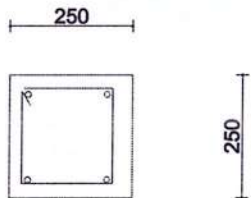
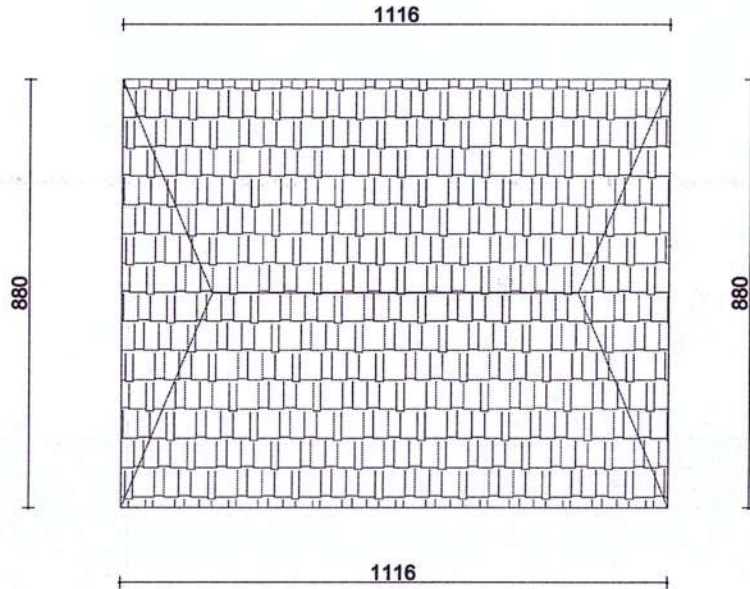

BREZ BETONARME  
SHKALLA 1:10

|                                |   |  |                         |  |
|--------------------------------|---|--|-------------------------|--|
|                                | REPUBLIKA E SHQIPERISË<br>BASHKIA URA VAJGURORE<br><br>DREJTORIA E PLANIFIKIMIT TË<br>TERRITORIT, INVESTIMEVE,<br>KONTROLLIT TË PROJEKTEVE, E<br>SHËRBIMEVE PUBLIKE DHE STREHIMIT | DREJTOR<br>I DREJTORISE SE PLANIFIKIMIT TË<br>TERRITORIT, INVESTIMEVE,<br>KONTROLLIT TË PROJEKTEVE,<br>E SHËRBIMEVE PUBLIKE<br>DHE STREHIMIT | ARK. ALTIN PALI         |  |
| OBJEKTI:<br>Z. PETRIT KALIVACI |   | SPECIALISTI TOPOGRAF   | TOP.IGRID SHKËMBI       |  |
| FSHATI PASHALLI      2023      |   | SPECIALIST I ZYRES<br>SE URBANISTIKES  | ING. JULIANA ABDURAMANI |  |



# PLANIMETRIA E CATISE SE BANESËS PAS RIKONSTRUKSIONIT SHK. 1:100

Z. PETRIT KALIVACI URE VAJGURORE

SKEMA E ELEMENTEVE TE KAPRIATES KAP-1

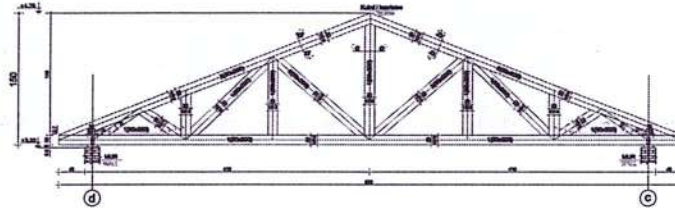

DETAJ D-1  
SHK 1:20

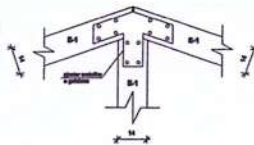

DETAJ D-2  
SHK 1:20

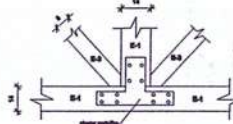

DETAJ D-3  
SHK 1:20

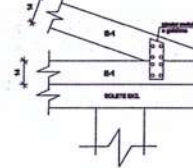

DETAJE  
SHKALLA 1:10

KULMI I KAPRIATES

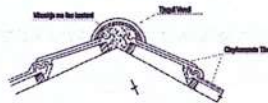

CATI ME T'JEGULLA MARSELEZE



DETAJ 1

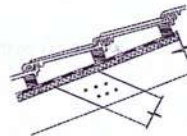

**SHENIM TEBNIK:**  
-Treguesi i materialit  
-Figura e objektit  
-Shprehja e shprehjes teknike  
-Shprehja e shprehjes teknike  
-Kapriates derese e ...m

|   |   |  |   |
|---|---|--|---|
|   | REPUBLIKA E SHQIPERISE<br>BASHKIA URA VAJGURORE<br><br>DREJTORIA E PLANIFIKIMIT TE<br>TERRITORIT, INVESTIMEVE,<br>KONTROLLIT TE PROJEKTEVE, E<br>SHERBIMEVE PUBLIKE DHE STREHIMIT | DREJTOR<br>I DREJTORISE SE PLANIFIKIMIT TE<br>TERRITORIT, INVESTIMEVE,<br>KONTROLLIT TE PROJEKTEVE,<br>E SHERBIMEVE PUBLIKE<br>DHE STREHIMIT | ARK. ALTIN PALI<br><br><br>                              |
| OBJEKTI:<br>Z. PETRIT KALIVACI<br><br>FSHATI PASHALLI | 2023  | SPECIALISTI TOPOGRAF<br><br>SPECIALIST I ZYRES<br>SE URBANISTIKES  | TOP.IGRID SHKËMBI<br><br>ING. JULIANA ABDURAMANI<br><br> |

# PLANIMETRIA E TRAREVE TE ÇATISE SE OBJEKTIT

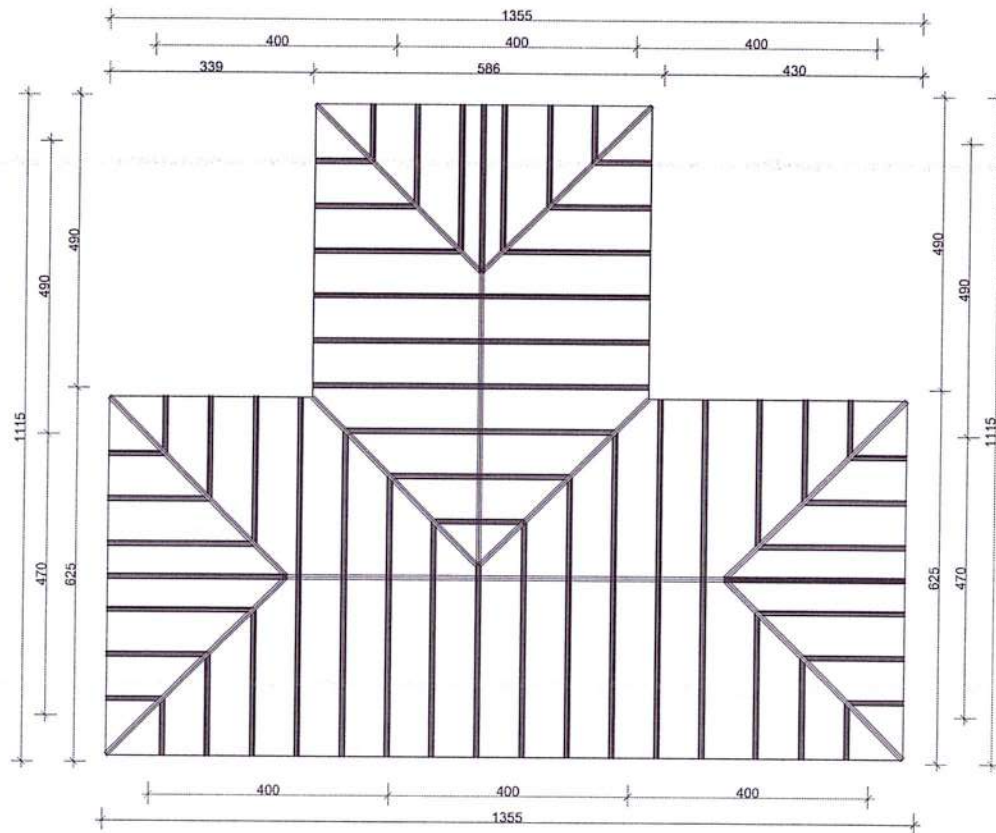

REPUBLIKA E SHqipërisë  
SHKËMBI DIMAL

|   |  |   |                   |  |
|---|--|---|-------------------|--|
|   | REPUBLIKA E SHqipërisë<br>BASINJA URA VAOUKORË<br>DIREKTORIA E PLANIFIKIMIT TE<br>TERRITORIT, INVESTIMEVE,<br>KONTROLLIT TE PROJEKTEVE, E<br>SHËRBIMEVE PUBLIKE DHE STRUKTURIMIT | DREJTORIA<br>E DREJTORISE SE PLANIFIKIMIT TE<br>TERRITORIT, INVESTIMEVE,<br>KONTROLLIT TE PROJEKTEVE,<br>E SHËRBIMEVE PUBLIKE<br>DHE STRUKTURIMIT | ARK. ALTIN PALI   |  |
| OBJEKTI:<br>PLANIMETRIA TRAREVE TE ÇATISE<br>Z.Ramadan Lila |  | SPECIALISTI TOPOGRAF  | TOP.IGRID SHKËMBI |  |
| FSHATI SYZES<br>2022  |  | SPECIALIST I ZYRES<br>SE URBANISTIKES   | TEK. MALVINA DAKA |  |

# PLANIMETRIA E TRAREVE TE ÇATISE SE OBJEKTIT

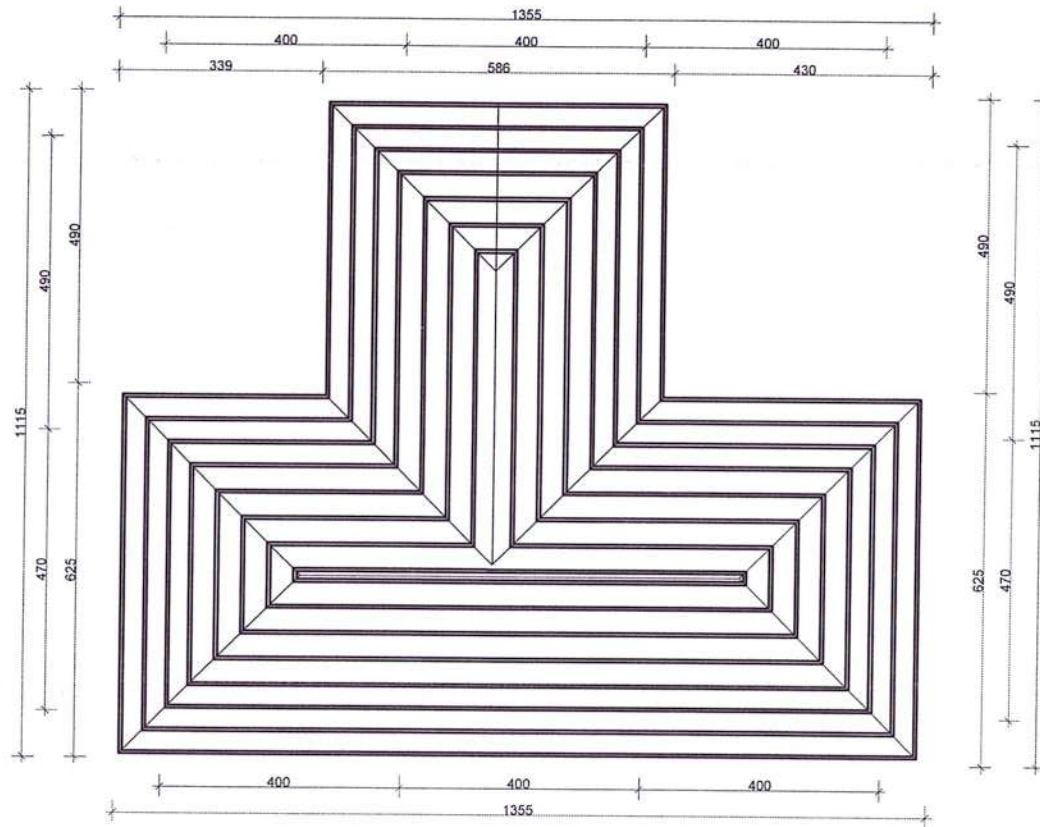

SHKURTARIA  
SHKËRIMET

|               |  |   |                   |  |
|---------------|--|---|-------------------|--|
|               | REPUBLIKA E SHQIPERISE<br>BASHKIA URK VAOUKORE   | DIREKTOR<br>I DREKTORESISE SE PLANIFIKIMIT TE<br>TERRITORIT, INVESTIMIVE<br>KONTROLLIT TE PROJEKTEVE,<br>K SHERBIMEVE PUBLIKE<br>DHE STRUKTURIT | ARK. ALTIN PALI   |  |
| OBJEKTI:      | PLANIMETRIA TRAREVE TE ÇATISE<br>Z. Ramadan Lita | SPECIALISTI TOPOGRAF  | TOPJGRID SHKËMBI  |  |
| FISHATI SYZES | 2022   | SPECIALISTI I ZYRES<br>SE URBANISTIKES  | TEK. MALVINA DAKA |  |



# PLANI I BREZIT BETONARME NEN ÇATI

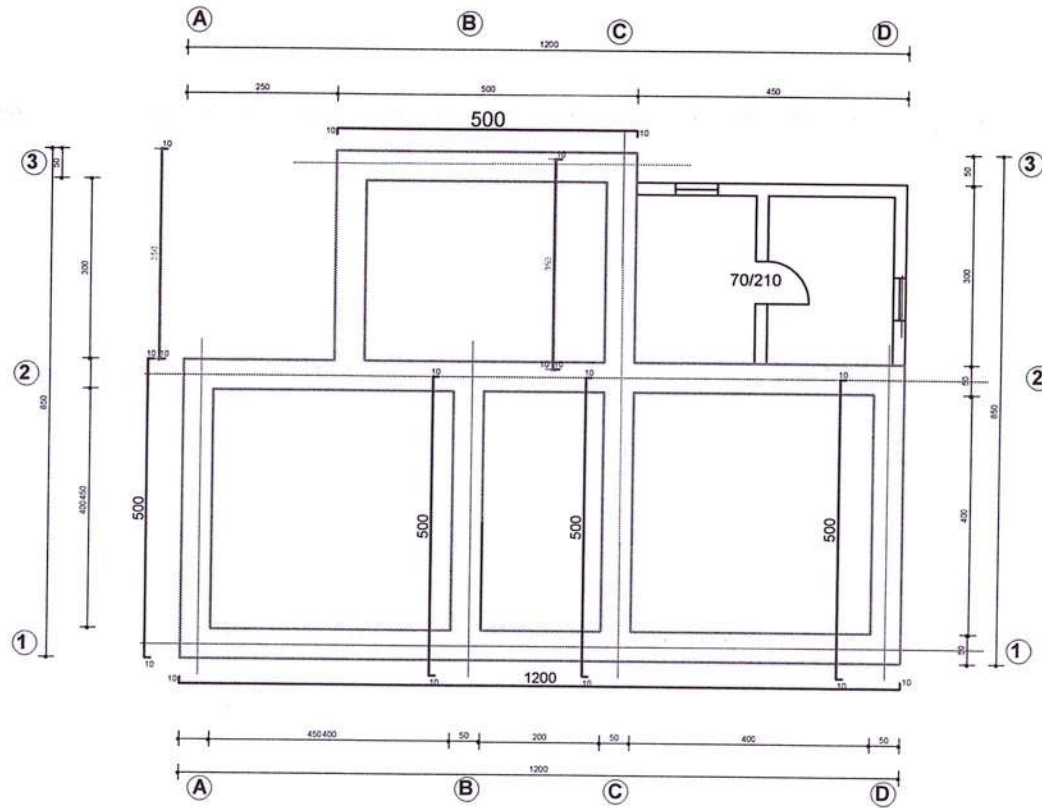

REPUBLIKA E SHQIPËRIE  
BASHKIA E DIMAL

|  |   |                   |  |
|--|---|-------------------|--|
| REPUBLIKA E SHQIPËRIE<br>BASHKIA E DIMAL                   | DIREKTOR<br>DIREKTORIN E PLANIFIKIMIT TE<br>TERRITORIT, INVESTIMET,<br>KONTROLLIT TE PROJEKTEVE, E<br>SHËRBIMEVE PUBLIKE DHE STRUKTURIT | ARK. ALTIN PALI   |  |
| OBJEKTI:<br>PLANI I BREZIT B/A NEN ÇATI<br>Z. Ramadan Lila | SPECIALISTI TOPOGRAF  | TOPJGRID SHKËMBI  |  |
| FSHATI SYZES<br>2022                                       | SPECIALISTI I ZYRES<br>SE URBANISTIKES  | TEK. MALVINA DAKA |  |

PLANIMETRIA EKZISTUESE E OBJEKTIT  
z.Ramadan Lila Fshati Syzes

SH 1:300

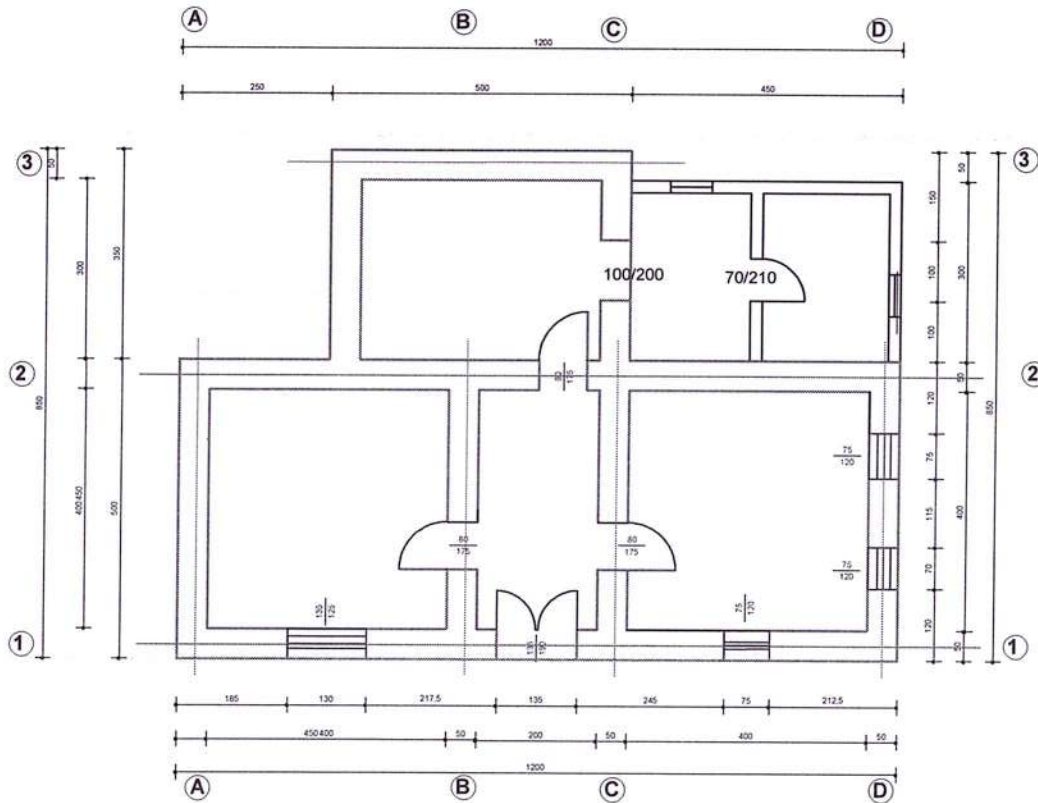

|   |  |  |                   |  |
|---|--|--|-------------------|--|
|   | REPUBLIKA E SHQIPERISE<br>BASHKIA URA VAJZUORE<br>DREJTORIA E PLANIFIKIMIT TE<br>TERRITORIT, INVESTIMEVE,<br>KONTROLLIT TE PROJEKTEVE, E<br>SHKEMBIVE PUBLIKE DHE STREHNIMIT | DIREKTOR<br>DREJTORISE E PLANIFIKIMIT TE<br>TERRITORIT, INVESTIMEVE,<br>KONTROLLIT TE PROJEKTEVE,<br>E SHKEMBIVE PUBLIKE<br>DHE STREHNIMIT | ARK. ALTIN PALI   |  |
| OBJEKTI<br>PLANIMETRIA EKZISTUESE E BANESES<br>Z.Ramadan Lila |  | SPECIALISTI TOPOGRAF   | TOPJGRID SHKEMBI  |  |
| FSHATI SYZES<br>2022  |  | SPECIALISTI I ZYRES<br>SE URBANISTIKES   | TEK. MALVINA DAKA |  |

# PLANIMETRIA E ÇATISE SE BANESES

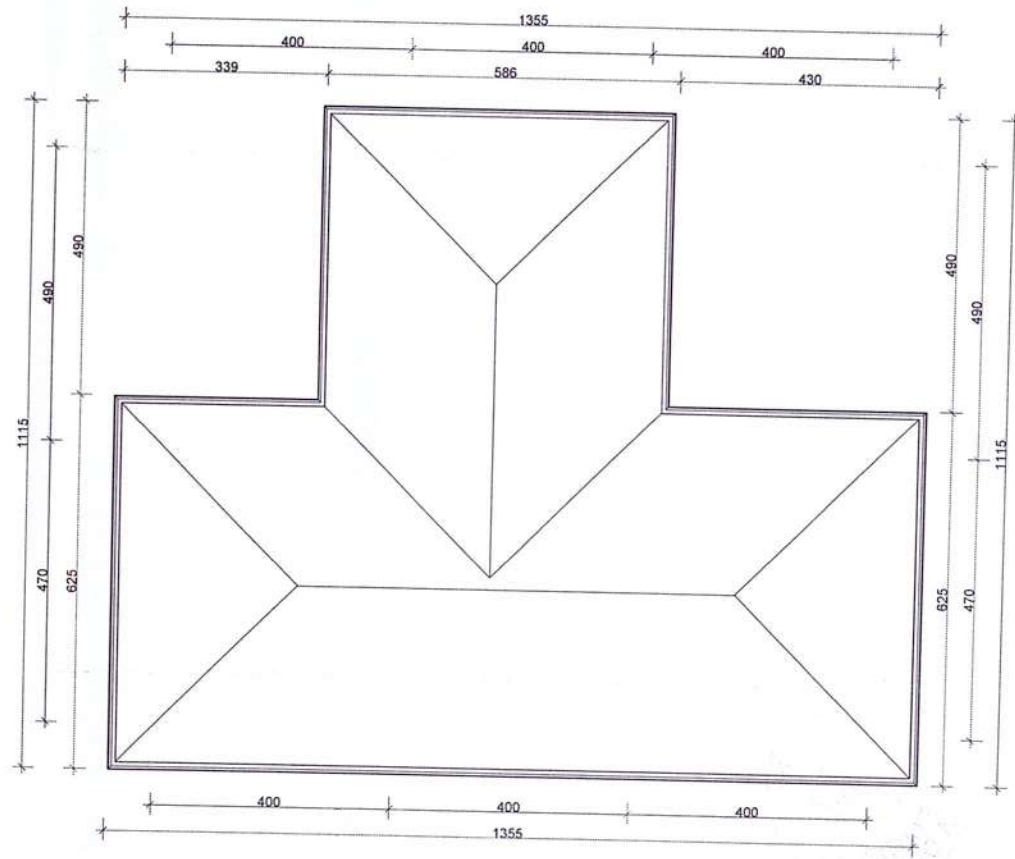

REPUBLIKA E SHQIPËRIE  
BASHKIA E VAJDEKORË  
SEKRET I BASHKIAE

|  |   |                   |  |
|--|---|-------------------|--|
| REPUBLIKA E SHQIPËRIE<br>BASHKIA E VAJDEKORË<br>DREJTORIA E PLANIFIKIMIT TË<br>TERRITORT, INVESTIMEVE,<br>KONTROLLIT TË PROJEKTEVE E<br>SHËRMBËVE PUBLIKE DHE ADRMIMIT | DIREKTOR<br>I DREJTORISË SË PLANIFIKIMIT TË<br>TERRITORT, INVESTIMEVE,<br>KONTROLLIT TË PROJEKTEVE,<br>KËSHILLORËVE PUBLIKË<br>DHE ADRMIMIT | ARK. ALTIN PALI   |  |
| OBJEKTI:<br>PLANIMETRIA E ÇATISE<br>Z. Ramadan Lila  | SPECIALISTI TOPOGRAF  | TOPJGRID SHKËMBI  |  |
| FSHATI SYZES<br>2022   | SPECIALISTI I ZYRES<br>SË URBANISTIKES  | TEK. MALVINA DAKA |  |



PLANIMETRIA EKZISTUESE E OBJEKTIT SH 1:300  
z.Shefqet Toska Fshati Hingë

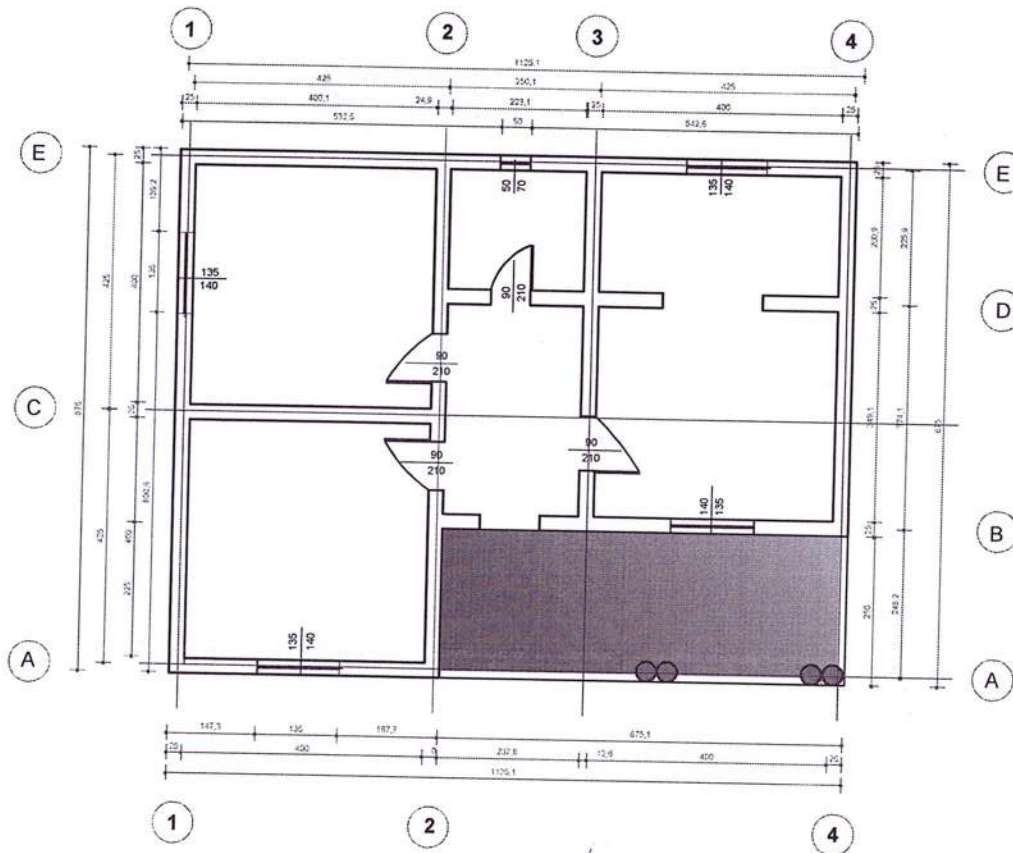

19-REPUBLIKA

|                              |  |   |                   |  |
|------------------------------|--|---|-------------------|--|
|                              | REPUBLIKA E SHQËRIE<br>BASHKËA URA VAJGJORRE<br>DREKTORIA E PLANIFIKIMIT TE<br>TERRITORIT, INVESTIMEVE,<br>KONTROLLIT TE PROJEKTEVE E<br>SHËRBIMEVE PUBLIKE DHE STRUKTURIMIT | DREKTOR<br>I DREKTORIT SE PLANIFIKIMIT TE<br>TERRITORIT INVESTIMEVE,<br>KONTROLLIT TE PROJEKTEVE,<br>E SHËRBIMEVE PUBLIKE<br>DHE STRUKTURIMIT | ARK. ALTIN PALI   |  |
| OBJEKTI:<br>Z. Shefqet Toska |  | SPECIALISTI TOPOGRAF  | TOP.IGRID SHKËMBI |  |
| FSHATI HINGË                 | 2022   | SPECIALISTI ZYRES<br>SE URBANISTIKES  | TEK. MALVINA DAKA |  |

PLANIMETRIA E THEMELEVE TË GURIT TË OBJEKTIT  
z.Shefqet Toska Fshati Hingë

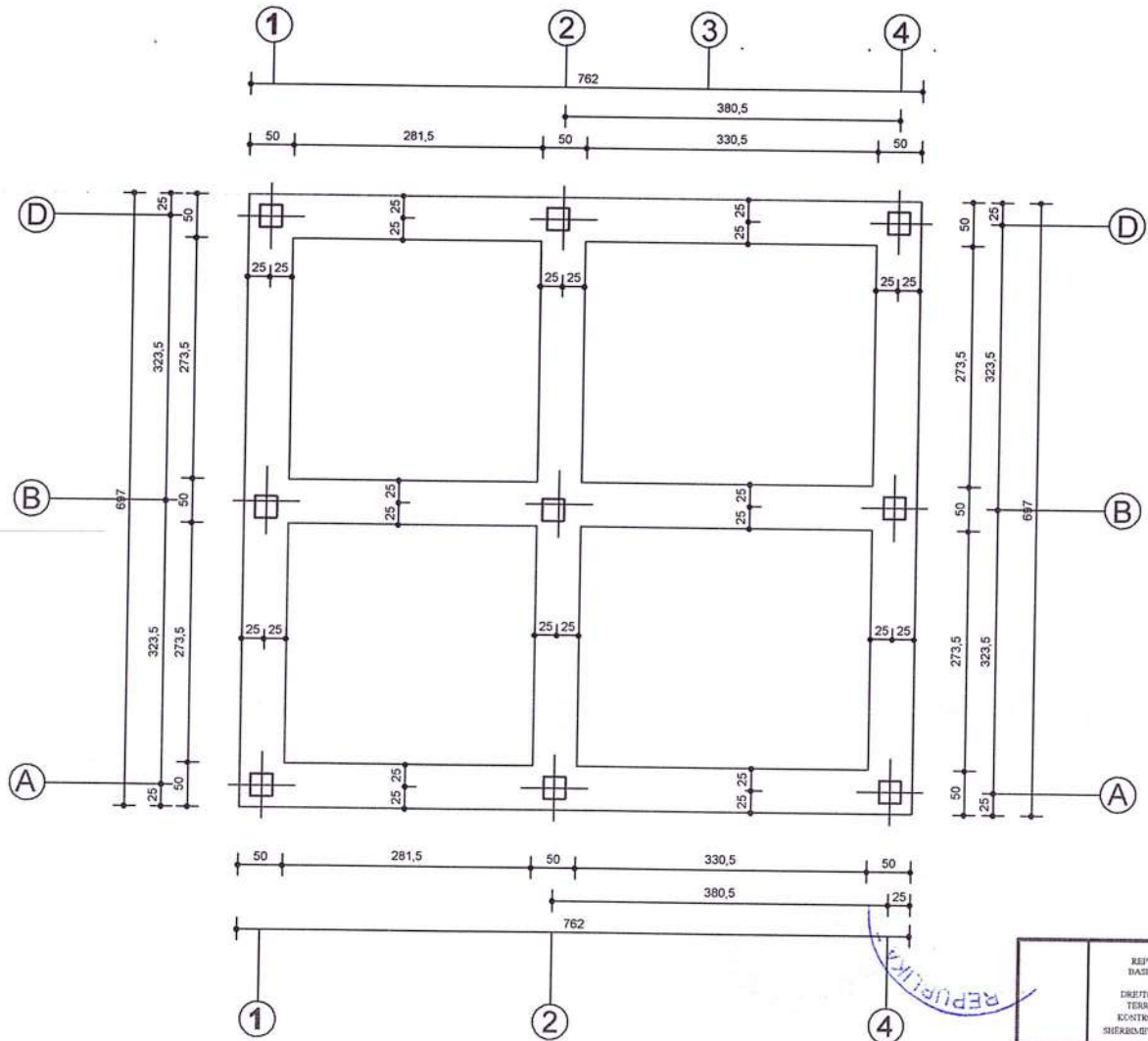

|  |  |                  |  |
|--|--|------------------|--|
| REPUBLIKA E SHQIPERISE<br>BASIRIA E RA VAJURORIE | DIREKTOR<br>I DREJTORISE NE PLANIFIKIMET TE<br>TERRESTRIT JVBETIMOR<br>KONTROLLIT TE PROJEKTEVE<br>E SHERBIMEVE PUBLIKE<br>DHE STRUKTURE | ARK. ALTIN PALI  |  |
| OBJEKTI:<br>Z.Shefqet Toska                      | SPECIALISTI TOPOGRAF   | TOPJGRID SHKËMBI |  |
| FSHATHIRIVE<br>2022                              | SPECIALISTI ZVRES<br>SE URBANISTIKES   | TEK.MALVINA DAKA |  |

PLANIMETRIA E BREZAVE BETON ARME NË KOKË TË THEMELIT

z.Shefqet Toska Fshati Hingë

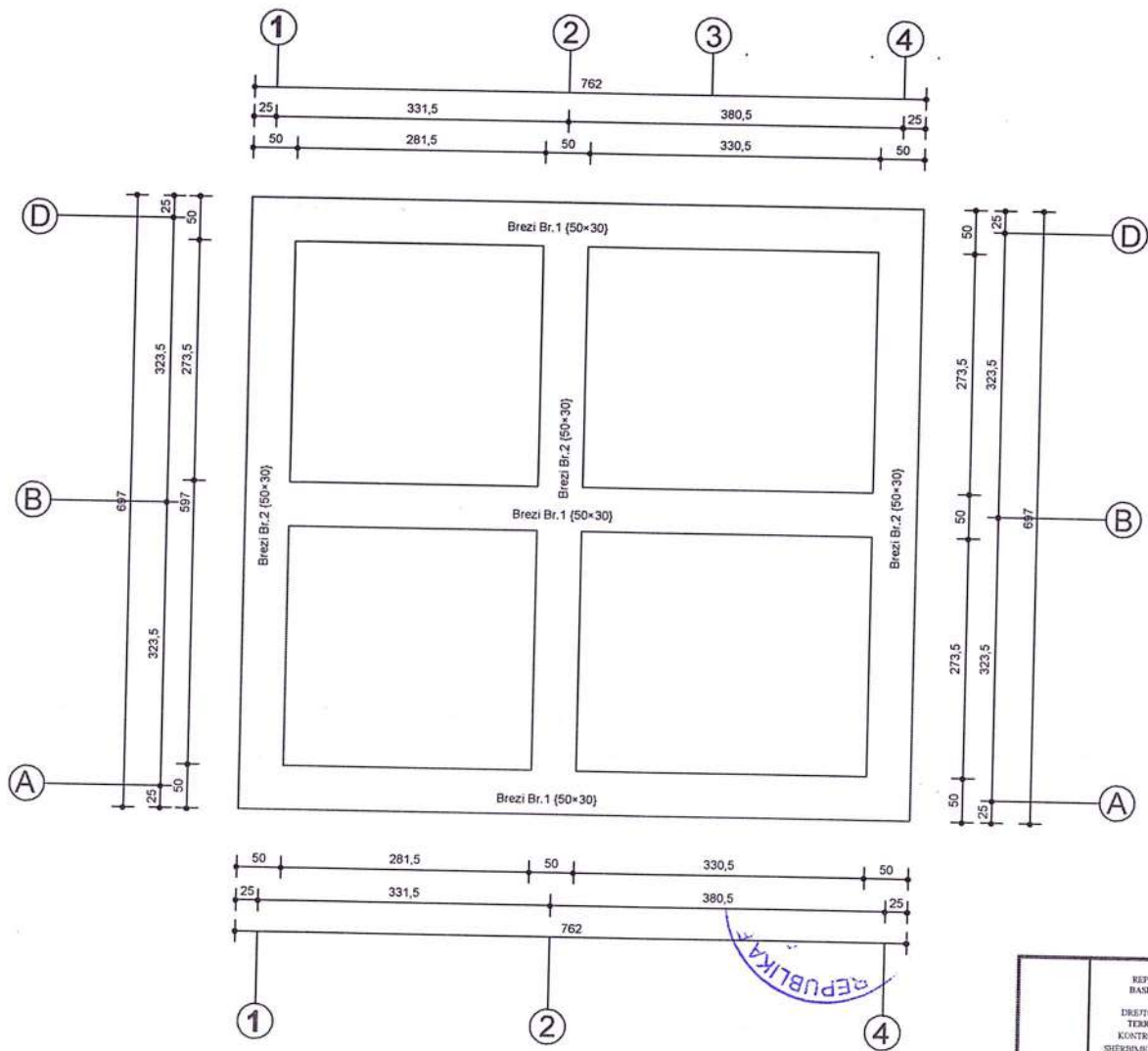

|                             |  |   |                   |  |
|-----------------------------|--|---|-------------------|--|
|                             | REPUBLIKA E SHqipëRIE<br>BASHKËA URK VARGËRORE<br>DREKTORIA E PLANIFIKIMIT TË<br>TERRITORIT, INVESTIMAVE,<br>KONTROLLIT TË PROJEKTEVE, Ë<br>SHËRIMAVE PUBLIKE DHE STRUKTURIT | DREKTOR<br>I DREKTORIT TË PLANIFIKIMIT TË<br>TERRITORIT, INVESTIMAVE,<br>KONTROLLIT TË PROJEKTEVE,<br>Ë SHËRIMAVE PUBLIKË<br>DHE STRUKTURIT | ARK. ALTIN PALI   |  |
| OBJEKTI:<br>Z.Shefqet Toska |  | SPECIALISTI TOPOGRAF  | TOPJGRID SHKËMBI  |  |
| FSHATI HINGË                | 2022   | SPECIALISTI I ZYRES<br>SE URBANISTIKES  | TEK. MALVINA DAKA |  |



PLANIMETRIA ARMIMIT TË BREZAVE BETON ARME NË KOKË TË THEMELIT

z.Shefqet Toska Fshati Hingë

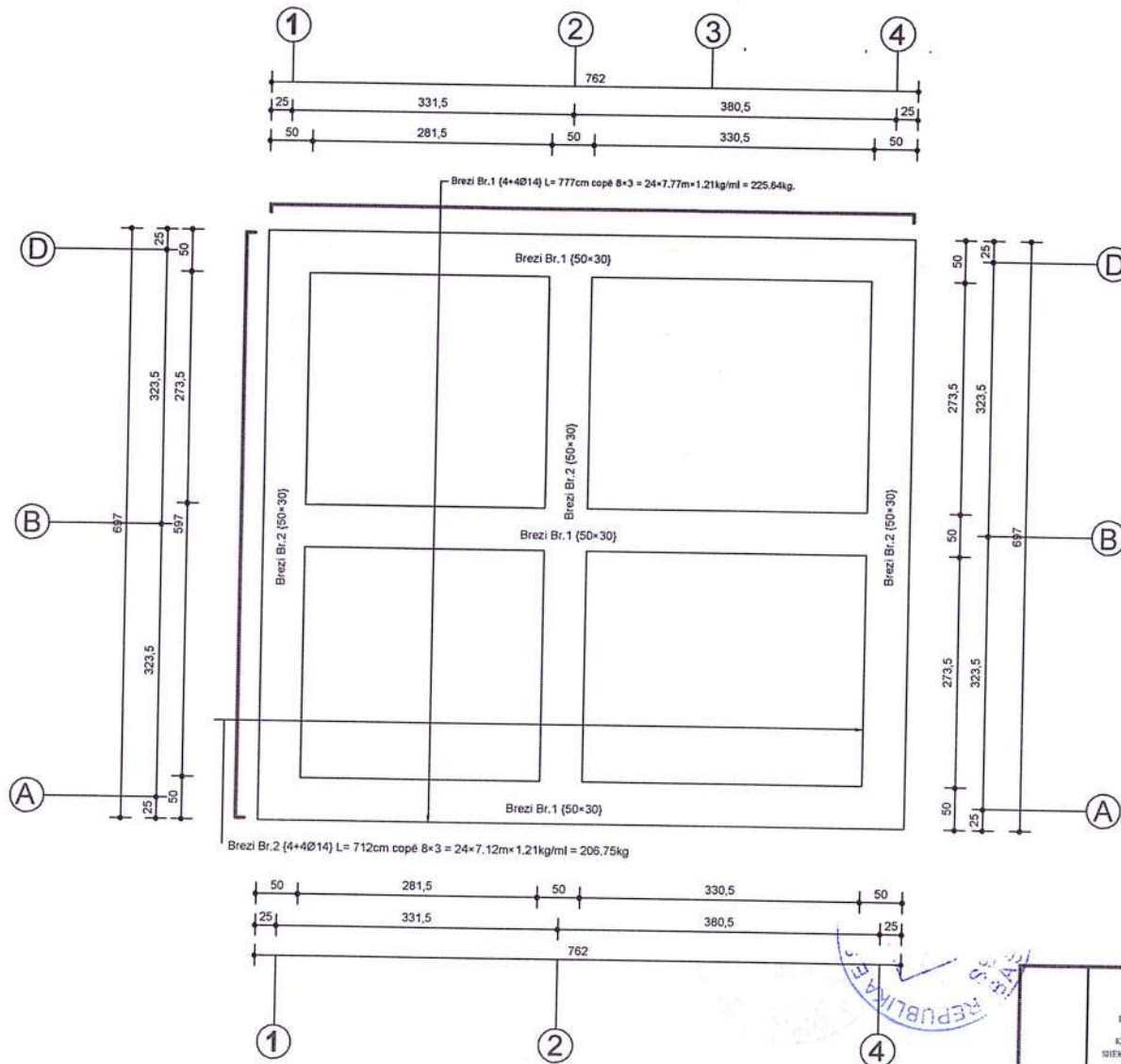

|              |   |   |                   |  |
|--------------|---|---|-------------------|--|
|              | REPUBLIKA E SHQIPËRIE<br>BASISIA URVAJGRORE | DIREKTORIA E PLANIFIKIMIT TË<br>TERRITORIT, INVESTIMEVE,<br>KONTROLLIT TË PROJEKTEVE,<br>E SHËRBIMEVE PUBLIKE<br>DHE STRUKTURIT | ARK. ALTIN PALI   |  |
| OBJEKTI:     | Z.Shefqet Toska                             | SPECIALISTI TOPOGRAF  | TOPJGRID SHKËMBI  |  |
| FSHATI/HINDE | 2022  | SPECIALISTI ZYRES<br>SE URBANISTIKES  | TEK. MALVINA DAKA |  |

# KOLONA RIGIDE ANTISIZMIKE

## z.Shefqet Toska Fshati Hingë

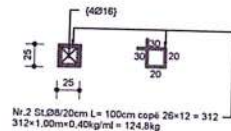
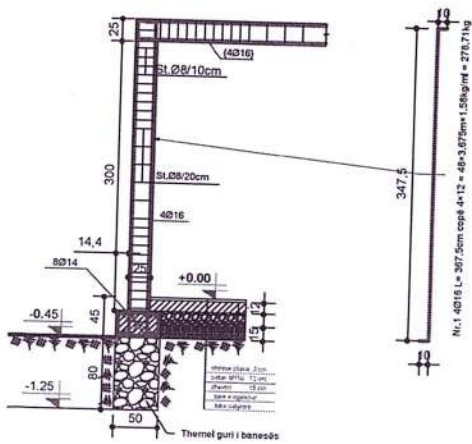

PRER. TIP E BR.1

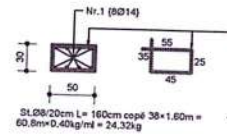

PRER. TIP E BR.2

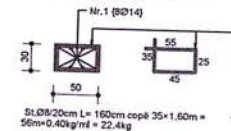

PRER. TIP E BR.1Ç

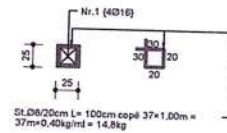

PRER. TIP E BR.2Ç SHK. 1:40

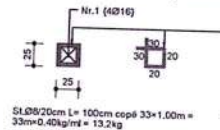

REPUBLIKA E SHQIPËS

|             |  |  |                   |  |
|-------------|--|--|-------------------|--|
|             | REPUBLIKA E SHQIPËS<br>BASHKËRIA VARGËRORE<br>DREKTORIA E PLANIFIKIMIT TË<br>TERRITORIT, INVESTIMEVE,<br>KONTROLLIT TË PROJEKTEVE, E<br>SHËRIMIMEVE PUBLIKE DHE STRUKTURIT | DIREKTOR<br>I DREKTORIT TË PLANIFIKIMIT TË<br>TERRITORIT, INVESTIMEVE,<br>KONTROLLIT TË PROJEKTEVE,<br>E SHËRIMIMEVE PUBLIKE<br>DHE STRUKTURIT | ARK. ALTIN PALI   |  |
| OBJEKTI:    | Z.Shefqet Toska  | SPECIALISTI TOPOGRAF   | TOPJGRID SHKËMBI  |  |
| FSHATI HVGË | 2022   | SPECIALIST I ZYRES<br>SE URBANISTIKES  | TEK. MALVINA DAKA |  |

# PLANI CATISE

z.Shefqet Toska Fshati Hingë

900

500

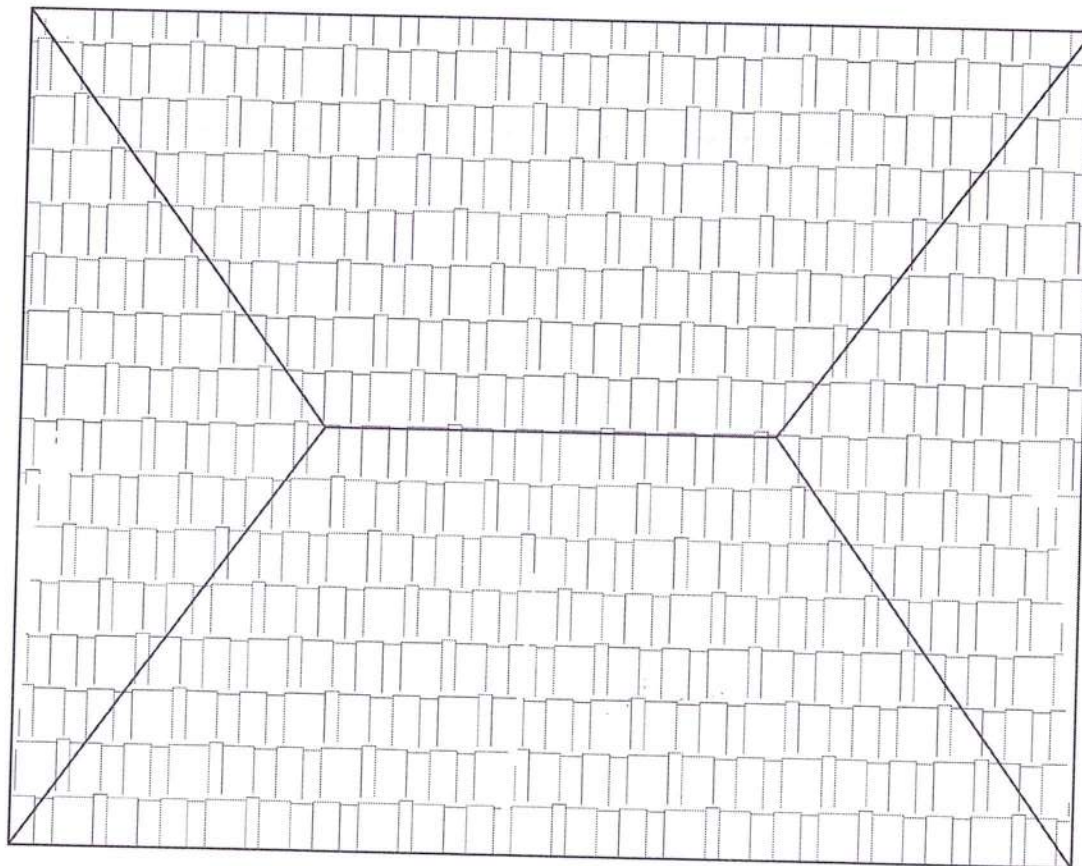

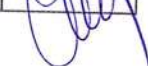
|                              |   |   |                   |   |
|------------------------------|---|---|-------------------|---|
|                              | REPUBLIKA E SHQËRIKË<br>DASHIDA URA VASHTRIKË<br>DIREKTORIA E PLANIFIKIMIT TË<br>TERKSTORIT, INVESTIMEVE,<br>KONTROLLIT TË PROJEKTEVE, E<br>SHËRBIMEVE PUBLIKE DHE STREHMIMIT | DIREKTOR<br>I DREKTORIT TË PLANIFIKIMIT TË<br>TERKSTORIT, INVESTIMEVE,<br>KONTROLLIT TË PROJEKTEVE,<br>E SHËRBIMEVE PUBLIKE<br>DHE STREHMIMIT | ARK. ALTIN PALI   |  |
| OBJEKTI:<br>Z. Shefqet Toska |   | SPECIALISTI TOPOGRAF  | TOPJGRID SHKËMBI  |  |
| FSHATI HINGË                 | 2022  | SPECIALISTI I ZYRES<br>SE URBANISTIKES  | TEK. MALVINA DAKA |  |



# PLANIMETRIA E BANESËS PAS RIKONSTRUKSIONIT SHK. 1:100

ZNJ. THIMIE QYLI

URE VAJGURORE

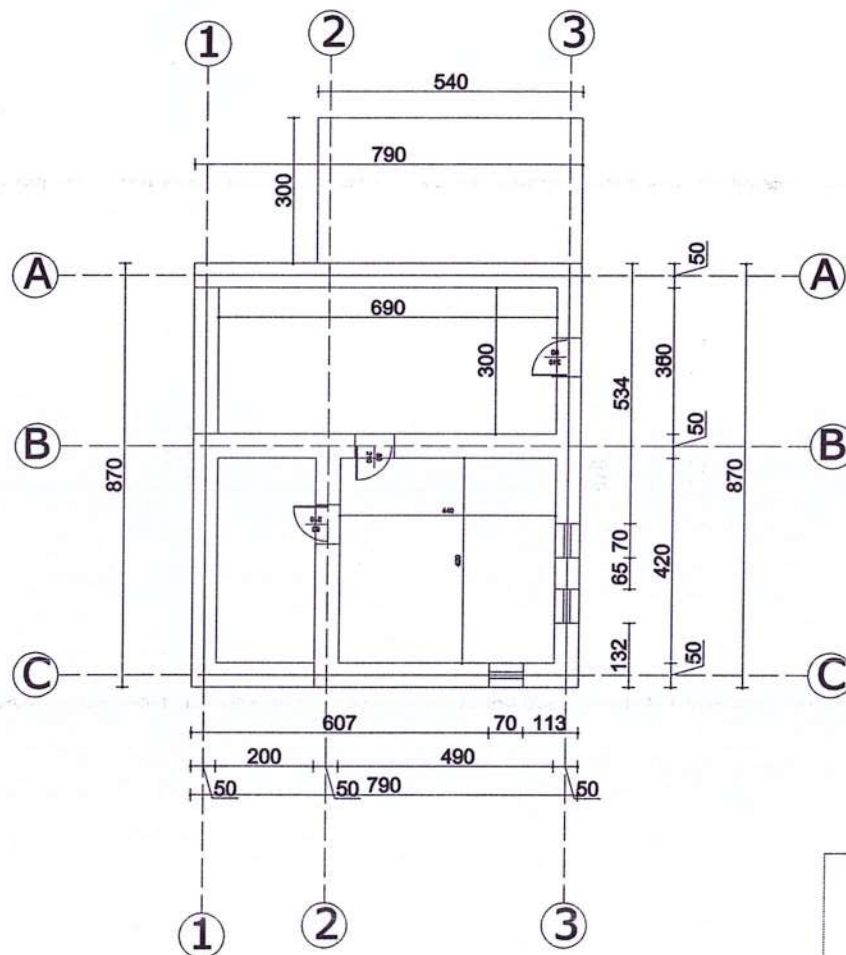

|   |   |  |  |
|---|---|--|--|
|   | REPUBLIKA E SHQIPERISË<br>BASHKIA URA VAJGURORE<br><br>DREJTORIA E PLANIFIKIMIT TË<br>TERRITORIT, INVESTIMEVE,<br>KONTROLLIT TË PROJEKTEVE, E<br>SHËRBIMEVE PUBLIKE DHE STREHIMIT | DREJTOR<br>I DREJTORISE SE PLANIFIKIMIT TE<br>TERRITORIT, INVESTIMEVE,<br>KONTROLLIT TË PROJEKTEVE,<br>E SHËRBIMEVE PUBLIKE<br>DHE STREHIMIT | ARK. ALTIN PALI                                   |
| OBJEKTI:<br>Znj. THIMIE QYLI<br><br>URE VAJGURORE | 2023  | SPECIALISTI TOPOGRAF<br><br>SPECIALIST I ZYRES<br>SE URBANISTIKES  | TOP.IGRID SHKËMBI<br><br>ING. JULIANA ABDURAMANI  |

# PLANIMETRIA E CATISE SE BANESËS PAS RIKONSTRUKSIONIT SHK. 1:100

ZNJ. THIMIE QYLI

URE VAJGURORE

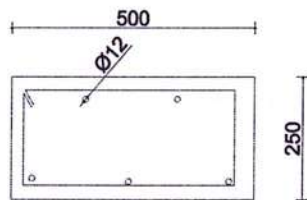
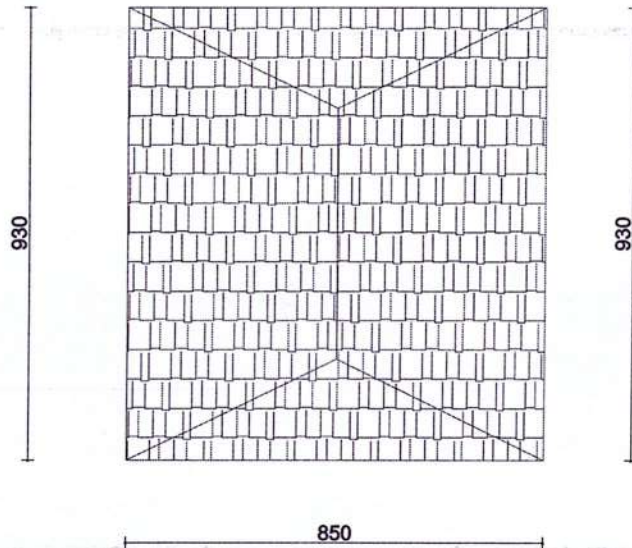

BREZ BETONARME  
SHKALLA 1:10

|   |   |  |   |
|---|---|--|---|
|   | REPUBLIKA E SHQIPERISË<br>BASHKIA URA VAJGURORE<br><br>DREKTORIA E PLANIFIKIMIT TË<br>TERRITORIT, INVESTIMEVE,<br>KONTROLLIT TË PROJEKTEVE, E<br>SHËRBIMEVE PUBLIKE DHE STREHIMIT | DREKTOR<br>I DREJTORISE SE PLANIFIKIMIT TË<br>TERRITORIT, INVESTIMEVE,<br>KONTROLLIT TË PROJEKTEVE,<br>E SHËRBIMEVE PUBLIKE<br>DHE STREHIMIT | ARK. ALTIN PALI          |
| OBJEKTI:<br>Znj. THIMIE QYLI            |   | SPECIALISTI TOPOGRAF   | TOP.IGRID SHKËMBI        |
| URE VAJGURORE                      2023 |   | SPECIALIST I ZYRES<br>SE URBANISTIKES  | ING. JULIANA ABDURAMANI  |

# PLANIMETRIA E CATISE SE BANESËS PAS RIKONSTRUKSIONIT SHK. 1:100

ZNJ. THIMIE QYLI

URE VAJGUORE

SKEMA E ELEMENTEVE TE KAPRIATES KAP-1

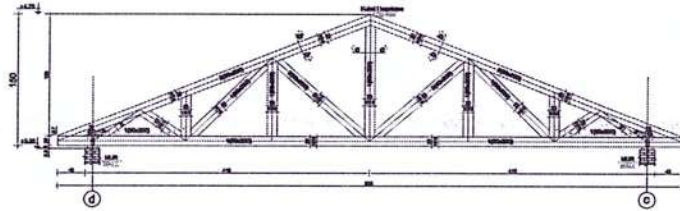

DETAJ D-1  
SHK 1:20

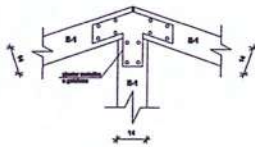

DETAJ D-2  
SHK 1:20

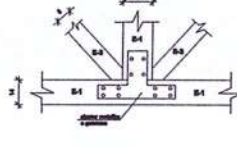

DETAJ D-3  
SHK 1:20

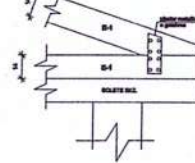

DETAJE  
SHKALLA 1:10

KULMI I KAPRIATES

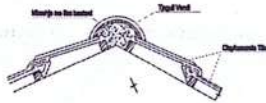

CATI ME TJEGULLA MARSELIEZE

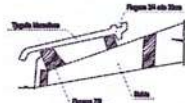

DETAJ I

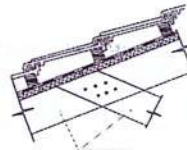

SHENIM TEPORIC:  
-Treguesi marrëveshje  
-Figura e shprehur (1:100)  
-Nje shprehje karton laborator  
-Strana driteshah 0-2.5cm  
-Kopjete derimesh e shprehur

|                              |  |  |  |
|------------------------------|--|--|--|
|                              | REPUBLIKA E SHQIPERISE<br>BASHKIA URA VAJGUORE<br><br>DREJTORIA E PLANIFIKIMIT TE<br>TERRITORIT, INVESTIMEVE,<br>KONTROLLIT TE PROJEKTEVE, E<br>SHERBIMEVE PUBLIKE DHE STREHIMIT | DREJTOR<br>I DREJTORISE SE PLANIFIKIMIT TE<br>TERRITORIT, INVESTIMEVE,<br>KONTROLLIT TE PROJEKTEVE,<br>E SHERBIMEVE PUBLIKE<br>DHE STREHIMIT | ARK. ALTIN PALI<br><br>         |
| OBJEKTI:<br>Znj. THIMIE QYLI |  | SPECIALISTI TOPOGRAF   | TOP.IGRID SHKËMBI<br><br>       |
| URE VAJGUORE<br>2023         |  | SPECIALIST I ZYRES<br>SE URBANISTIKES  | ING. JULIANA ABDURAMANI<br><br> |



# ANIMETRIA E BANESËS PAS RIKONSTRUKSIONIT SHK. 1:100

Z. TOMORR KAZANXHIU

FSHATI PASHALLI

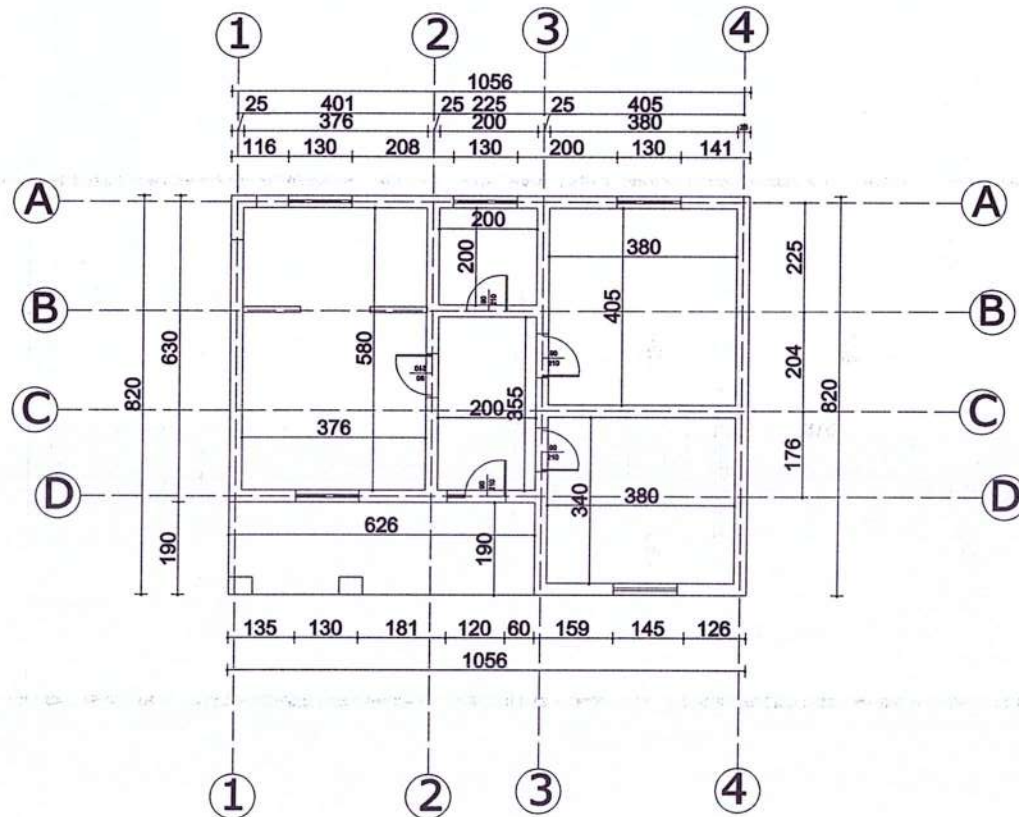

|   |   |  |   |
|---|---|--|---|
|   | REPUBLIKA E SHQIPERISË<br>BASHKIA URA VAJGURORË<br><br>DREKTORIA E PLANIFIKIMIT TË<br>TERRITORIT, INVESTIMEVE,<br>KONTROLLIT TË PROJEKTEVE, E<br>SHËRBIMEVE PUBLIKE DHE STREHIMIT | DREJTOR<br>I DREKTORISË SE PLANIFIKIMIT TË<br>TERRITORIT, INVESTIMEVE,<br>KONTROLLIT TË PROJEKTEVE,<br>E SHËRBIMEVE PUBLIKE<br>DHE STREHIMIT   | ARK. ALTIN PALI  |
| OBJEKTI:<br>Z. TOMORR KAZANXHIU<br><br>FSHATI PASHALLI 2023 | SPECIALISTI TOPOGRAF<br><br>SPECIALISTI I ZYRES<br>SE URBANISTIKES  | TOP.IGRID SHKËMBI <br><br>ING. JULIANA ABDURAMANI  |   |

# PLANIMETRIA E CATISE SE BANESËS PAS RIKONSTRUKSIONIT SHK. 1:100

Z. TOMORR KAZANXHIU FSHATI PASHALLI

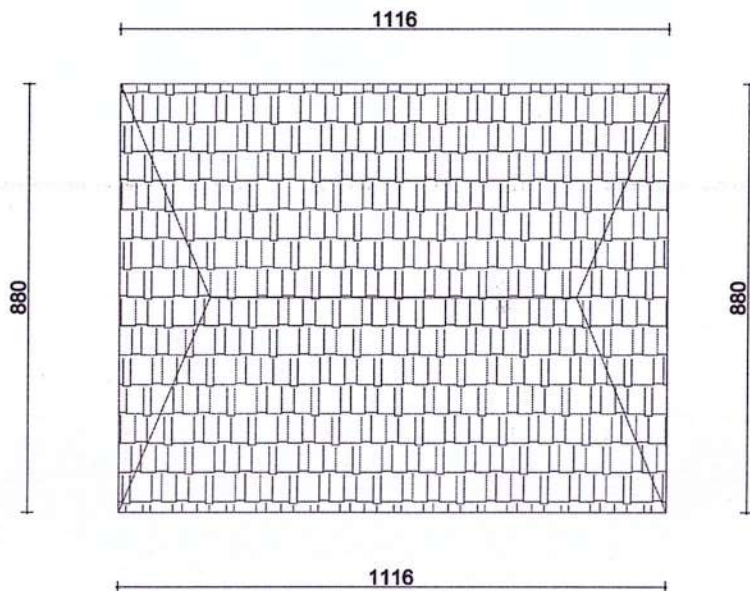

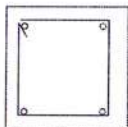

250

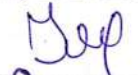

250

BREZ BETONARME  
SHKALLA 1:10

|  |  |  |   |
|--|--|--|---|
|  | REPUBLIKA E SHQIPERISË<br>BASHKIA URA VAJGJORE<br><br>DREKTORIA E PLANIFIKIMIT TË<br>TERRITORIT, INVESTIMEVE,<br>KONTROLLIT TË PROJEKTEVE, E<br>SHËRBIMEVE PUBLIKE DHE STREHIMIT | DREKTOR<br>I DREJTORISE SE PLANIFIKIMIT TË<br>TERRITORIT, INVESTIMEVE,<br>KONTROLLIT TË PROJEKTEVE,<br>E SHËRBIMEVE PUBLIKE<br>DHE STREHIMIT | ARK. ALTIN PALI    |
| OBJEKTI:<br>Z. TOMORR KAZANXHIU<br><br>FSHATI PASHALLI | 2023   | SPECIALISTI TOPOGRAF<br><br>SPECIALIST I ZYRES<br>SE URBANISTIKES  | TOP.IGRID SHKËMBI<br><br>ING. JULIANA ABDURAMANI <br> |

# PLANIMETRIA E CATISE SE BANESËS PAS RIKONSTRUKSIONIT SHK. 1:100

## Z. TOMORR KAZANXHIU FSHATI PASHALLI

SHKEMA E ELEMENTEVE TE KAPRIATES KAP-1

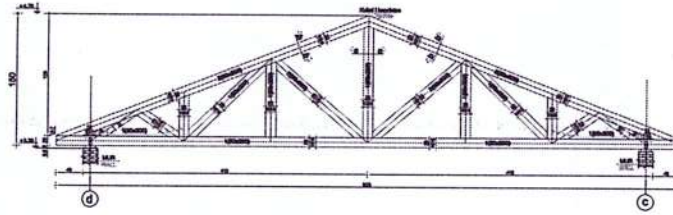

DETAJ D-1  
SHK 1:20

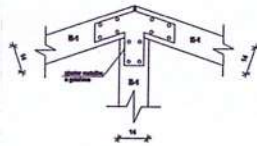

DETAJ D-2  
SHK 1:20

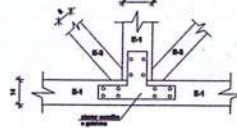

DETAJ D-3  
SHK 1:20

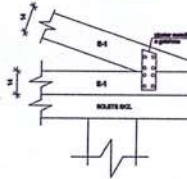

DETAJE  
SHKALLA 1:10

KULMI I KAPRIATES

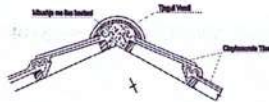

CATI ME T.JEGULLA MARSELIEZE

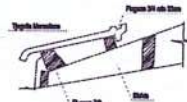

DETAJ 1

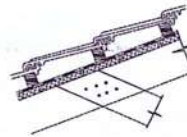

**SHENIM TEBORRE:**

- Tjega dhe marra me...
- Rruga e rreze 30cm (4-5cm)
- Nje shtrirje karton izolues
- Distrues derueshah Ø=2,5cm
- Kapriate derueshah 2x4



|  |   |  |   |
|--|---|--|---|
|  | REPUBLIKA E SHQIPERISE<br>BASHKIA URA VAJGJRORE<br><br>DREJTORIA E PLANIFIKIMIT TE<br>TERRITORIT, INVESTIMEVE,<br>KONTROLLIT TE PROJEKTEVE, E<br>SHERBIMEVE PUBLIKE DHE STREHIMIT | DREJTOR<br>I DREJTORISE SE PLANIFIKIMIT TE<br>TERRITORIT, INVESTIMEVE,<br>KONTROLLIT TE PROJEKTEVE,<br>E SHERBIMEVE PUBLIKE<br>DHE STREHIMIT | ARK. ALTIN PALI<br><br>                                  |
| OBJEKTI:<br>Z. TOMORR KAZANXHIU<br><br>FSHATI PASHALLI | 2023  | SPECIALISTI TOPOGRAF<br><br>SPECIALIST I ZYRES<br>SE URBANISTIKES  | TOP.IGRID SHKËMBI<br><br>ING. JULIANA ABDURAMANI<br><br> |

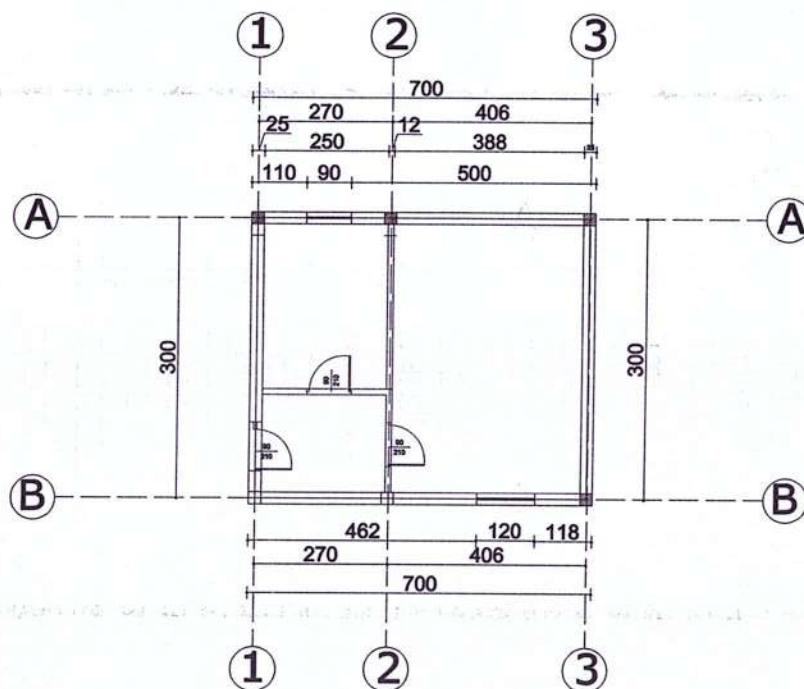

# PLANIMETRIA E BANESËS PAS RIKONSTRUKSIONIT SHK. 1:100

Z. VIKTOR DANI L.18 TETORI, URE VAJGURORE

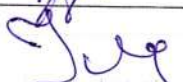

|  |   |  |   |
|--|---|--|---|
|  | REPUBLIKA E SHQIPERISË<br>BASHKIA URA VAJGURORE<br><br>DREJTORIA E PLANIFIKIMIT TË<br>TERRITORIT, INVESTIMEVE,<br>KONTROLLIT TË PROJEKTEVE, S<br>SHËRBIMEVE PUBLIKE DHE STREHIMIT | DREJTOR<br>I DREJTORISË SE PLANIFIKIMIT TË<br>TERRITORIT, INVESTIMEVE,<br>KONTROLLIT TË PROJEKTEVE,<br>E SHËRBIMEVE PUBLIKE<br>DHE STREHIMIT | ARK. ALTIN PALI    |
| OBJEKTI:<br>Z. VIKTOR DANI<br><br>L. 18 TETORI | 2023  | SPECIALISTI TOPOGRAF<br><br>SPECIALIST I ZYRES<br>SE URBANISTIKES  | TOP.IGRID SHKËMBI<br><br>ING. JULIANA ABDURAMANI <br> |

# PLANIMETRIA E CATISE SE BANESËS PAS RIKONSTRUKSIONIT SHK. 1:100

Z. VIKTOR DANI L.18 TETORI, URE VAJGURORE

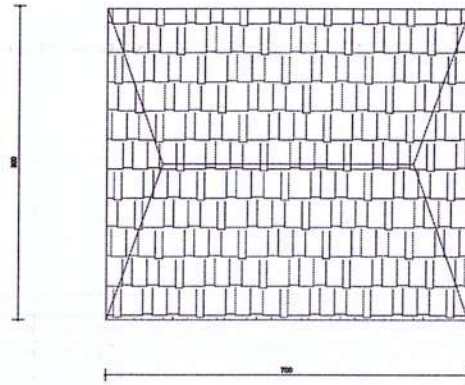

250

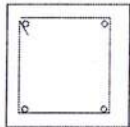

250

BREZ BETONARME  
SHKALLA 1:10

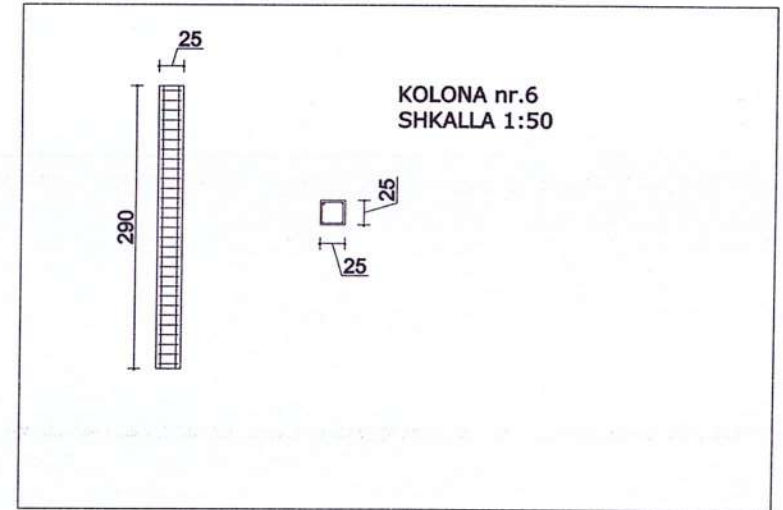

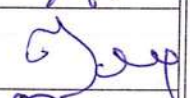
|                            |   |  |  |
|----------------------------|---|--|--|
|                            | REPUBLIKA E SHQIPERISË<br>BASHKIA URA VAJGURORË<br><br>DREJTORIA E PLANIFIKIMIT TË<br>TERRITORIT, INVESTIMEVE,<br>KONTROLLIT TË PROJEKTEVE, E<br>SHËRBIMEVE PUBLIKE DHE STREHIMIT | DREJTOR<br>I DREJTORISË SE PLANIFIKIMIT TË<br>TERRITORIT, INVESTIMEVE,<br>KONTROLLIT TË PROJEKTEVE,<br>E SHËRBIMEVE PUBLIKE<br>DHE STREHIMIT | ARK. ALTIN PALI<br><br>         |
| OBJEKTI:<br>Z. VIKTOR DANI |   | SPECIALISTI TOPOGRAF   | TOP.IGRID SHKËMBI<br><br>       |
| L. 18 TETORI               | 2023  | SPECIALISTI I ZYRES<br>SE URBANISTIKES   | ING. JULIANA ABDURAMANI<br><br> |

# PLANIMETRIA E CATISE SE BANESËS PAS RIKONSTRUKSIONIT SHK. 1:100

Z. VIKTOR DANI L.18 TETORI, URE VAJGURORE

SKEMA E ELEMENTEVE TE KAPRIATES KAP-1

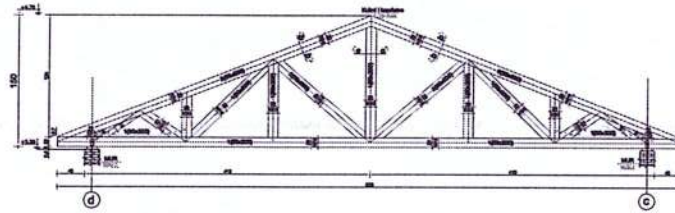

DETAJ D-1  
SHK 1:20

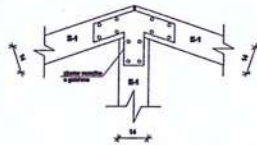

DETAJ D-2  
SHK 1:20

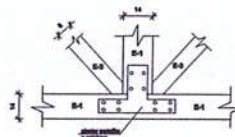

DETAJ D-3  
SHK 1:20

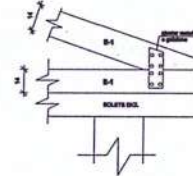

DETAJE  
SHKALLA 1:10

KULMI I KAPRIATES

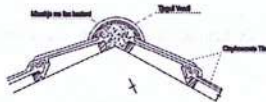

CATI ME TJEGULLA MARSELEZE



DETAJ 1

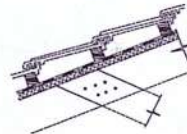

**SHENIM TIBONIK:**  
-Tjeggulla marseleze  
-Kaptete e02 (4-5cm)  
-Ngjeshja e02 (4-5cm)  
-Ngjeshja e02 (4-5cm)  
-Ngjeshja e02 (4-5cm)  
-Kaptete e02 .m

|  |   |  |  |
|--|---|--|--|
|  | REPUBLIKA E SHQIPERISË<br>BASHKIA URA VAJGURORE<br><br>DREJTORIA E PLANIFIKIMIT TË<br>TERRITORIT, INVESTIMEVE,<br>KONTROLLIT TË PROJEKTEVE, E<br>SHËRBIMEVE PUBLIKE DHE STREHIMIT | DREJTOR<br>I DREJTORISE SE PLANIFIKIMIT TË<br>TERRITORIT, INVESTIMEVE,<br>KONTROLLIT TË PROJEKTEVE,<br>E SHËRBIMEVE PUBLIKE<br>DHE STREHIMIT | ARK. ALTIN PALI                                  |
| OBJEKTI:<br><br>Z. VIKTOR DANI<br><br>L. 18 TETORI | 2023  | SPECIALISTI TOPOGRAF<br><br>SPECIALIST I ZYRES<br>SE URBANISTIKES  | TOP.IGRID SHKËMBI<br><br>ING. JULIANA ABDURAMANI |