

# **PLANIMETRI DHE SKICA**

**OBJEKTI: "REABILITIM DHE NDERTIMI I KANALEVE VADITese 2024"**

Planimetria pusetes Liqeni Maqellare

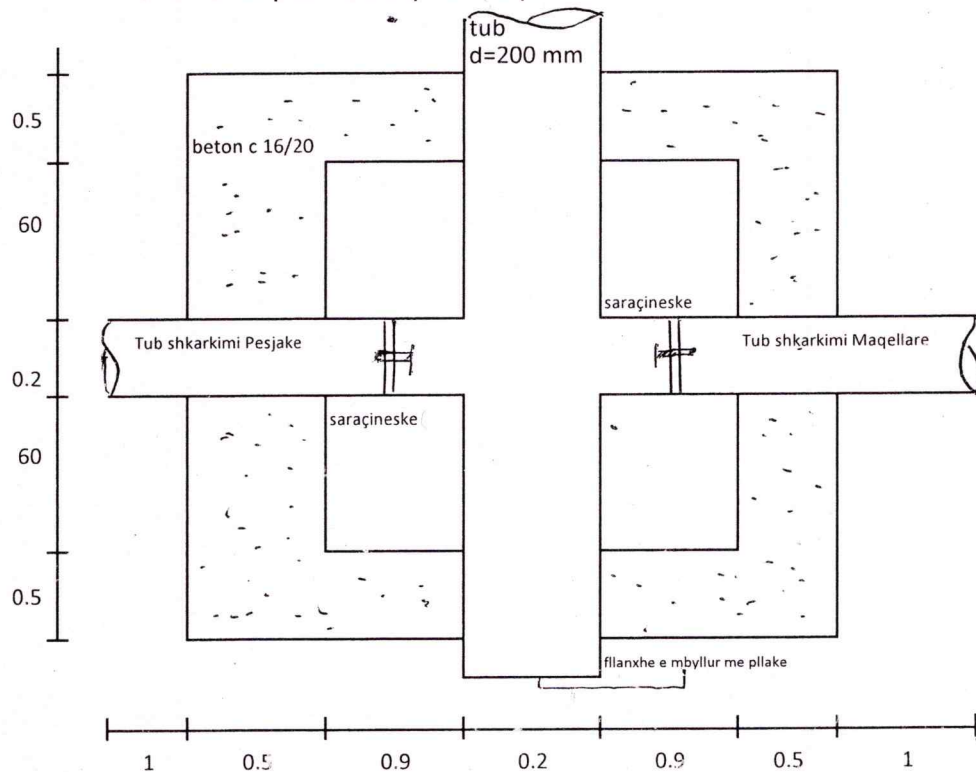

Shenim :Puseta do te kete mure 0.5 m trashesi .Ne pusete do te montohen dy saraçine ka d=200mm sipas preventivit,njera per degezimin Maqellare dhe tjetra per degezimin Pesjake.Puseta do kete permasa 3\*2.4 m

Do te hiqet saraçineska ekzistuese dhe do te behet zghatim I tubit shkarkues

Prerje terthore e pusetes

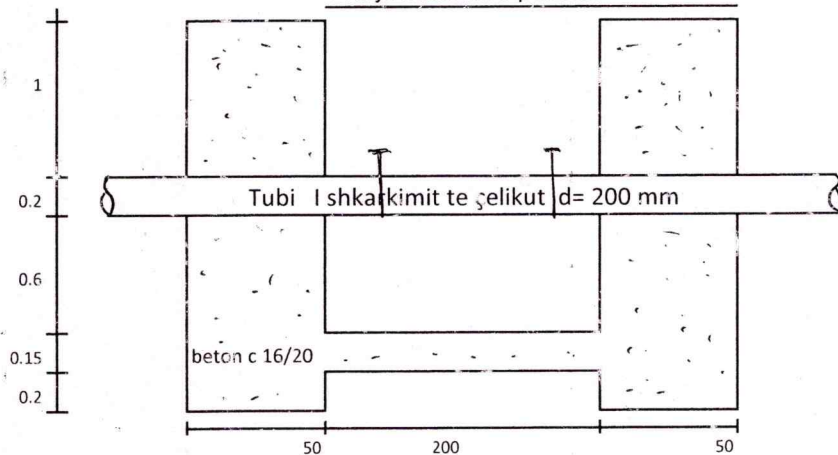

Republika Shqiperise BASHKIA DIBER	" Reabilitim dhe ndertimi I kanaleve vaditese 2024 "	MIRATOI Kryetari Rahim SPAHU
	DETAJE,SKICA	Projektues Fatos Mandrri
Date __/__/2024	Faza Zbatim / Format A4 / Sh 1 : __	Vizatim nr <i>[Signature]</i>

Detaji I profilite te kanalit Ish-reparti-Kallavere

L = 370 m/l

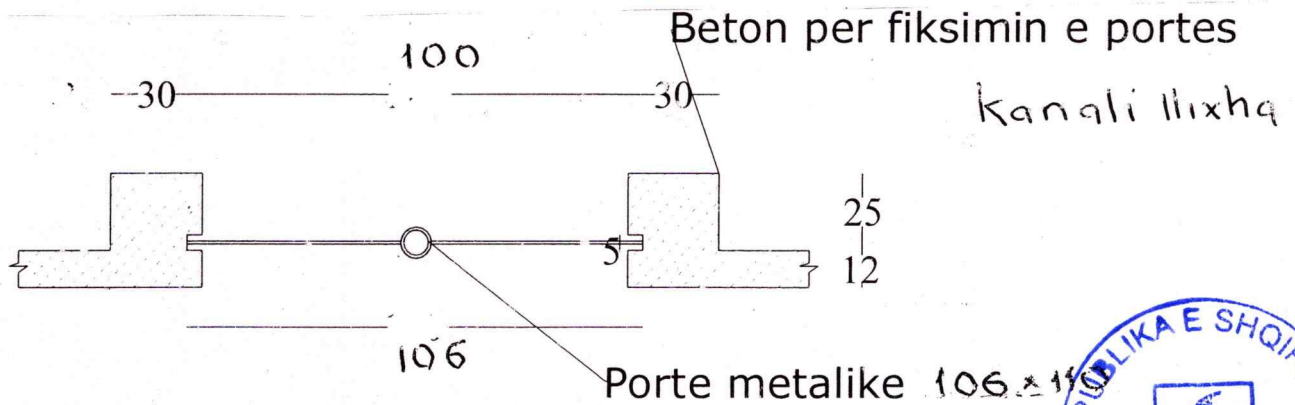
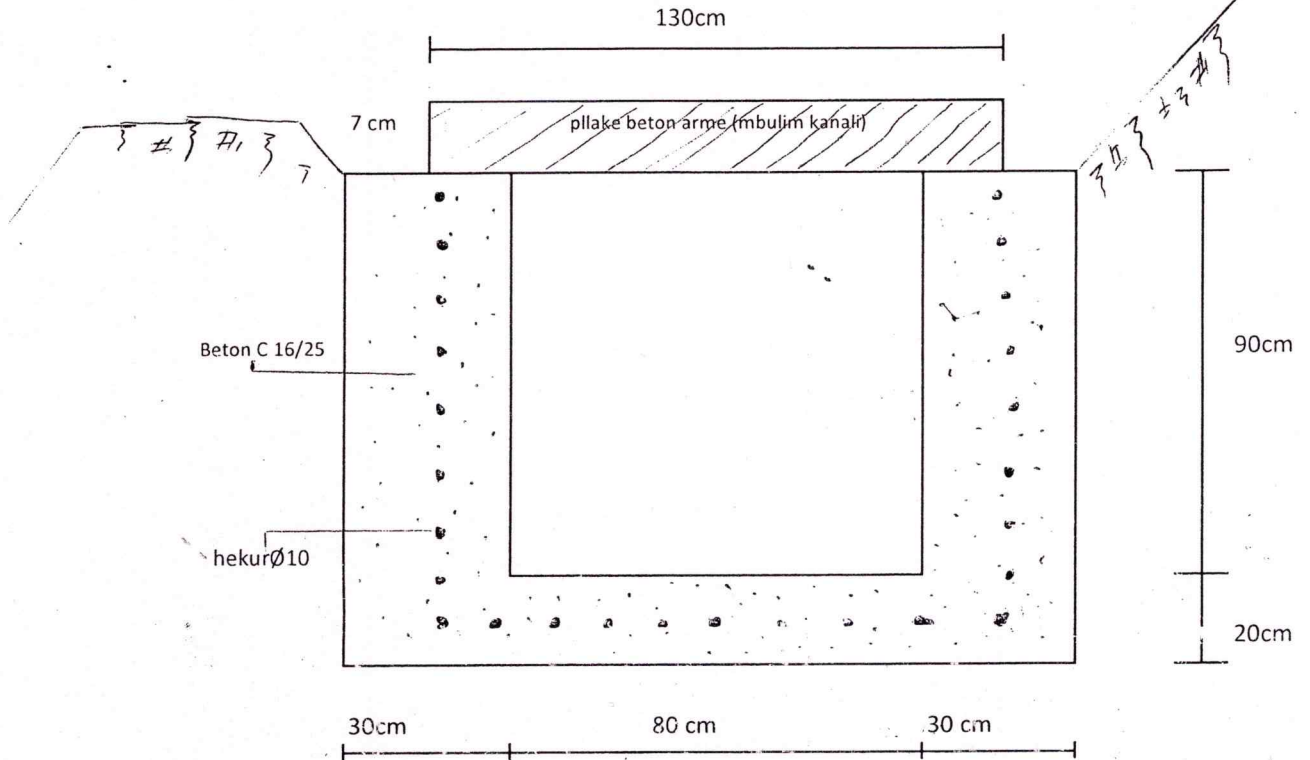

Republika Shqiperise BASHKIA DIBER	" Reabilitim dhe ndertimi I kanaleve vaditese 2024 "	MIRATOI Kryetari Rahim SPANU
	DETAJE,SKICA	Projektues Fatos Mandrri
Date __/__/2024	Faza Zbatim / Format A4 / Sh 1 : ____	Vizatim nr ____

Prerje pllake betonarme per mbulim kanali(I.Rustane)

L= 18 m/l

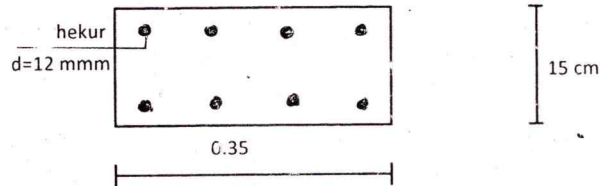

Shenim: Pllaka do te kete permasa 0.35\*0.15\*1.5 m  
Hekuri do te vendoset dopio zgate d= 12mm, çdo 10 cm largesi

Prerje pllake betonarme per mbulim kanali(Ish-reparti deri tek puseta )

L= 258 m/l

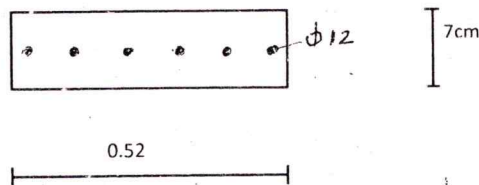

Shenim: Pllaka do te kete permasa 0.52\*0.07\*1.2 m  
Hekuri d= 12 mm do te vendoset çdo 8 cm largesi  
Hekuri d= 10 mm do te vendoset çdo 12 cm largesi

Republika Shqiperise BASHKIA DIBER	" Reabilitim dhe ndertimi I kanaleve vaditese 2024 "	MIRATOI Kryetar Rahim SPAHIU
	DETAJE, SKICA	Projektues Fatos Mandrri
Date __/__/2024	Faza Zbatim / Format A4 / Sh 1 : __	Vizatim nr __

Profil I germimit te seksionit te kanalit Ish-reparti-Kallavere

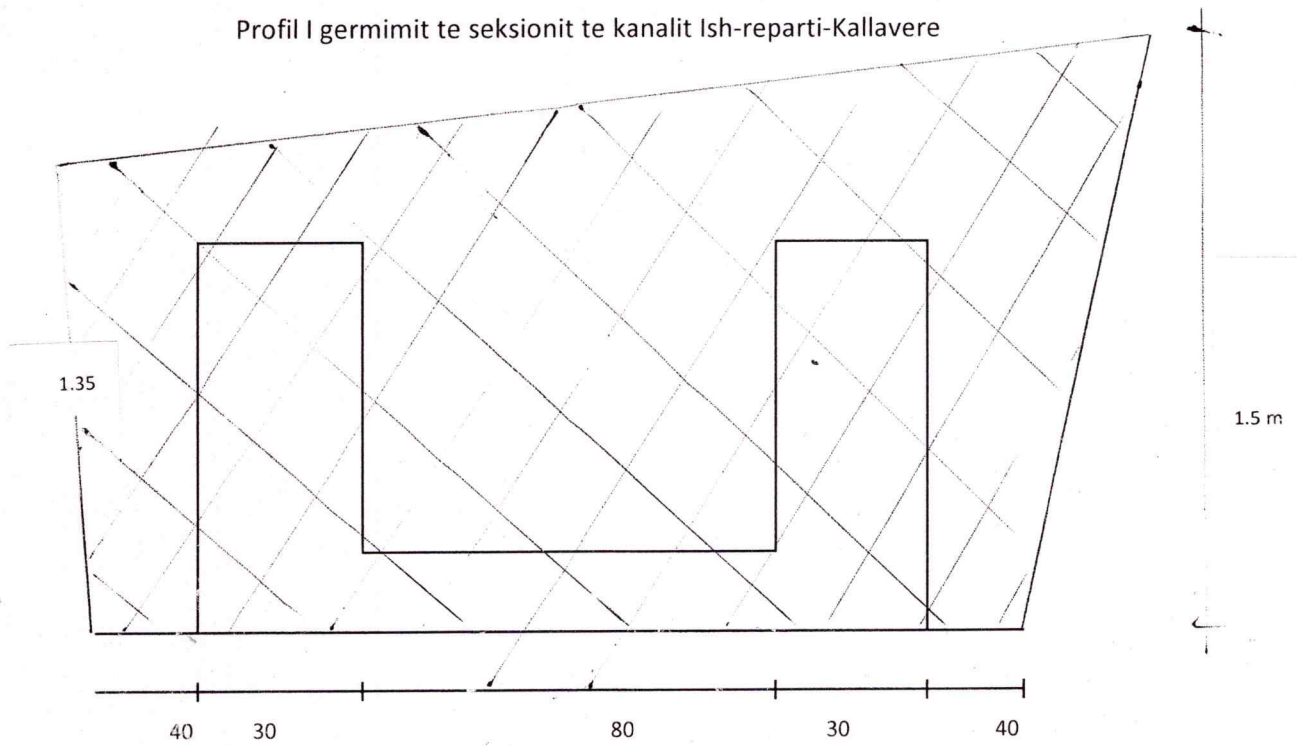

Sg= 3.56 m<sup>2</sup>

Germimi do te jete 40 cm me l gjere se profili I kanalit per arsye te vendosjes se armatures , gjate procesit te betonimit te kanalit, dhe do te germohet me pjerresi ,ne rr ne menyre qe te mos bien dherat gjate procesit te punes pas heqjes se armatures te behet ngjeshja e dheut ne dy anet e betonit.



Republika Shqiperise BASHKIA DIBER	" Reabilitim dhe ndertimi I kanaleve vaditese 2024 "	MIRATOI Kryetari Rahim SPAHIU
	DETAJE,SKICA	Projektues Fatos Mandrri
Date __/__/2024	Faza Zbatim / Format A4 / Sh 1 : __	Vizatim nr __

Detaji kanali Vakuf ,Beton C16/20

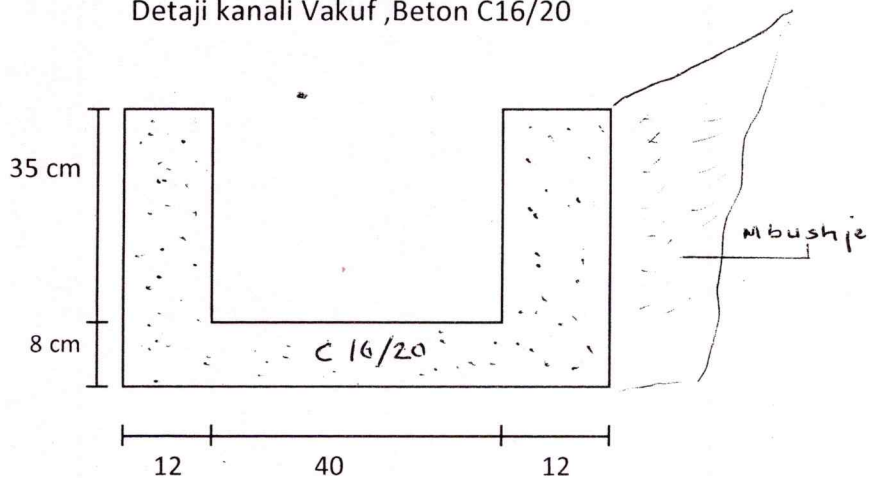

Detaji kanali Venisht (Lagjia Fejze) ,Beton C16/20

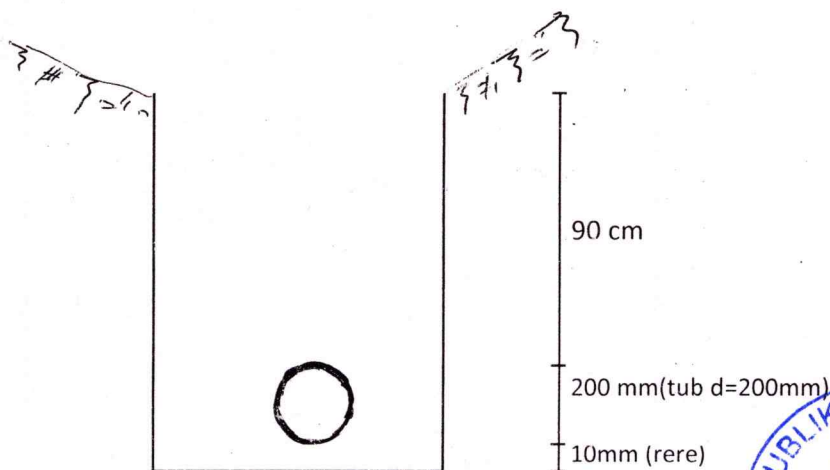
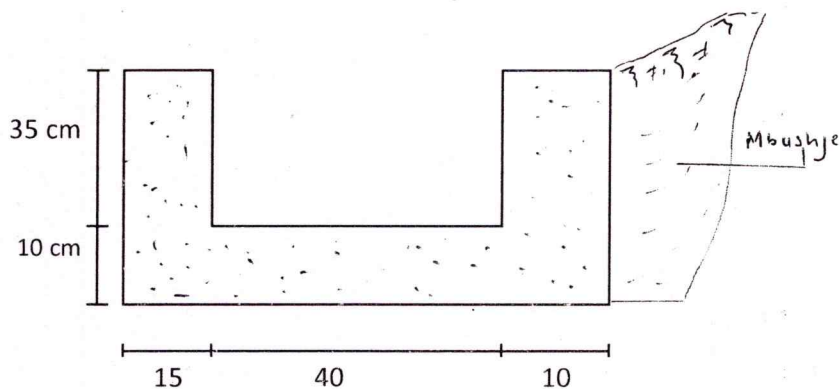

Detaji vendosje tubi HDPE (Venisht,Lagj.Fejze)

Republika Shqiperise BASHKIA DIBER	" Reabilitim dhe ndertimi I kanaleve vaditese 2024 "	
	DETAJE,SKICA	
Date __/__/2024	Faza Zbatim / Format A4/ Sh 1 : __	Vizatim nr __

Detaj, Kanali Grames Fshati Bllice L= 7 m/l

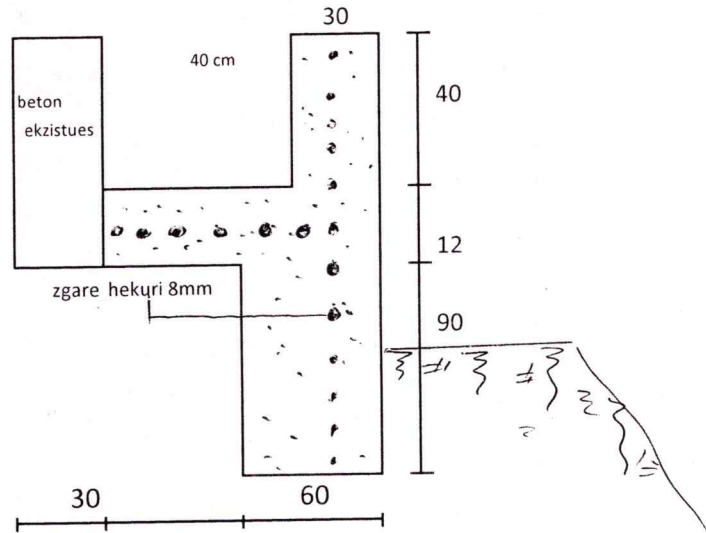

Shenim. Ne profilin me sipër do përdoret hekur  $d = 8 \text{ mm}$  duke formuar një zgare  $c = 10 \text{ cm}$  do të përdoret beton markë C 16/20

Detaj mur anesor L= 12.9 m fshati Bllice

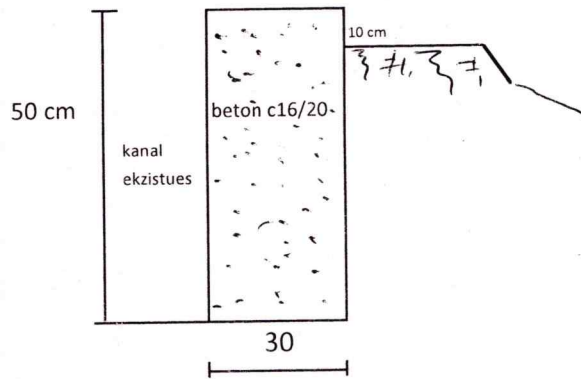

Republika Shqiperise BASHKIA DIBER	" Reabilitim dhe ndertimi I kanaleve vaditese 2024 "	MIRATOI Kryetar Bahim SPANIU
	DETAJE, SKICA	Projektues Fatos Mandrri
Date __/__/2024	Faza Zbatim / Format A4 / Sh 1 : __	Vizatim nr __

### Kanali Melan -Dovolan

L= 94 m/l

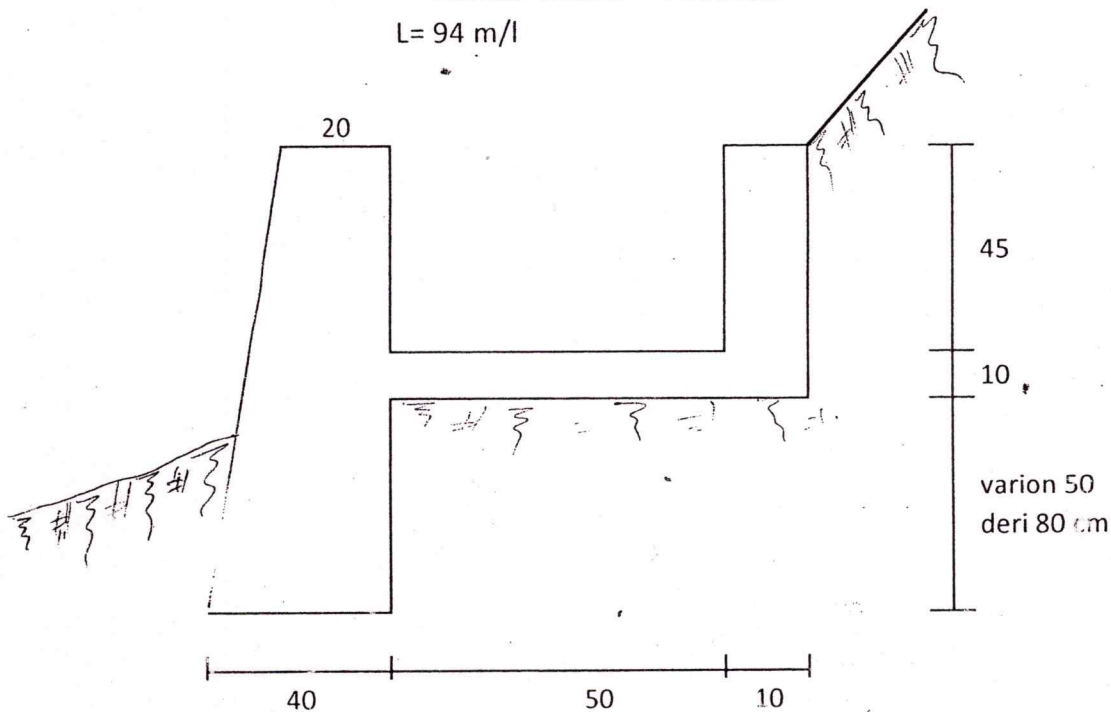

Shenim :Ky kanal do te ndertohet ne gjurmen e kanali ekzistues  
 Kanali ekzistues do te prishet ,duke larguar dhe  
 mbetjet inerte nga sheshi i ndertimit.  
 Marka e bet nit C 16/20

### Profil I kanalit Melan (kerjake) Nj.AJ MELAN Beton C 16/20

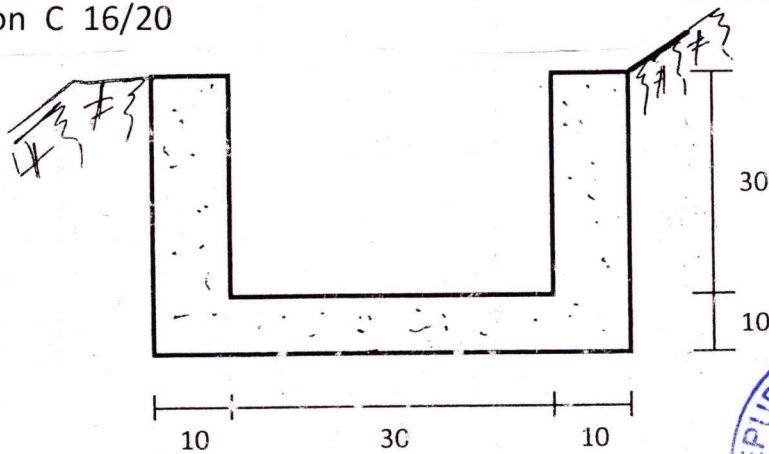

Republika Shqiperise BASHKIA DIBER	" Reabilitim dhe ndertimi i kanaleve vaditesse 2024 "	
	DETAJE,SKICA	
Date __/__/2024	Faza Zbatim / Format A4 / Sh 1 : __	Vizatim nr



Detaji I profilit te mbingritjes te kanalit I.Rustane  
L = 18 m/l

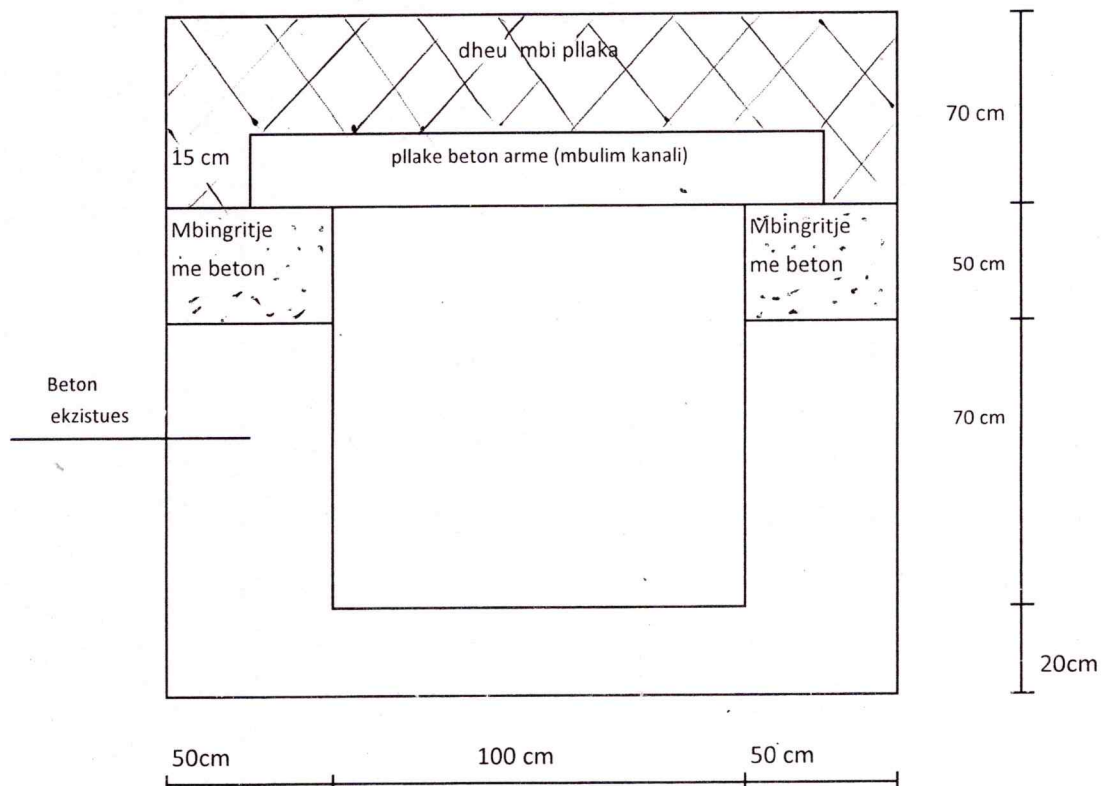

Shenim: Kanali ekzistues ka nje gjeresi nje meter,dhe mure me gjeresi 50 cm mbi bazamentin ekzistues do te behet mbingritja dhe b=mbulimi me pllaka Siper pllakave do te behet hedhja e dheut te nevojshem per sheshimin e terrenit,dhe kthimin ne normalitet.Nje pjese e dheut do te largohet me karroce dore dhe me pas me mjete ne vendin e percaktuar.



Republika Shqiperise BASHKIA DIBER	" Reabilitim dhe ndertimi I kanaleve vaditese 2024 "	MIRATOI Kryetari Rahim SPAHIU
	DETAJE,SKICA	Projektues Fatos Mandrri
Date __/__/2024	Faza Zbatim / Format A4 / Sh 1 : ____	Vizatim nr ____

Detaj riparim I shembjes kanali shkarkues Liqeni Brezhdan

L=6.5 m/l

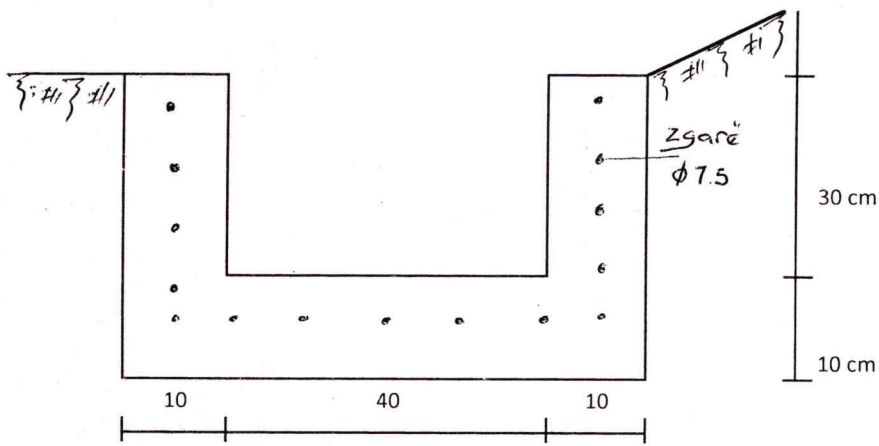
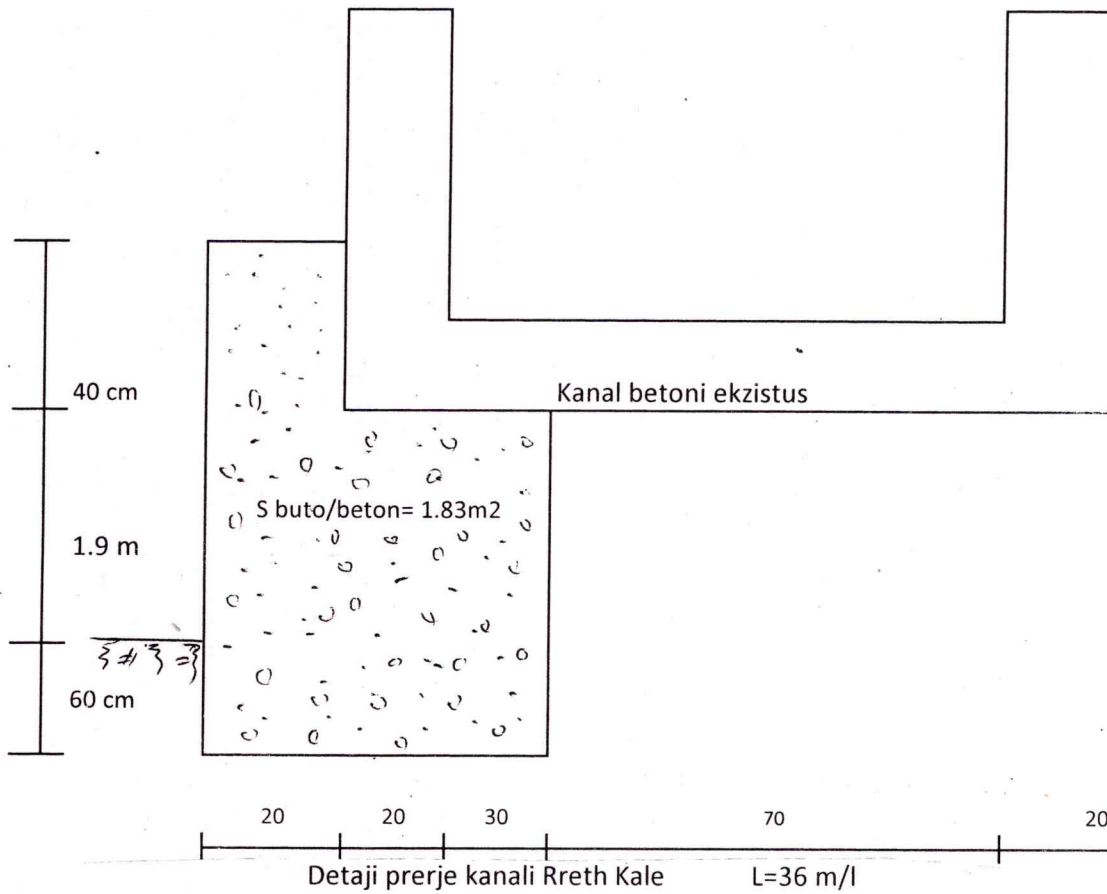

Shenim: ky segment kanali do te behet me zgare hekuri 7.5 mm



Republika Shqiperise BASHKIA DIBER	" Reabilitim dhe ndertimi I kanaleve vaditese 2024 "	MIRATOI Kretari Rahim SPAHIU
	DETAJE,SKICA	Projektues Fatos Mandrri
Date __/__/2024	Faza Zbatim / Format A4 / Sh 1 : __	Vizatim nr

Detaji prerje Pusete Venisht (Lagjia Fejze) ,Beton C16/20

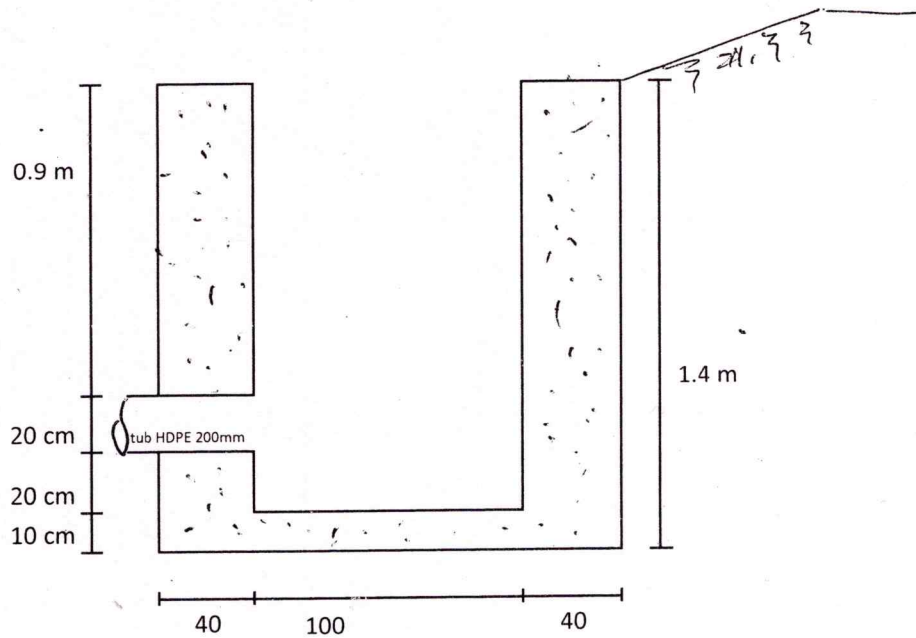

Puseta thithjes Sifoni Dobrove ,Prerje  
Lartesia e pusetes 1.1 meter

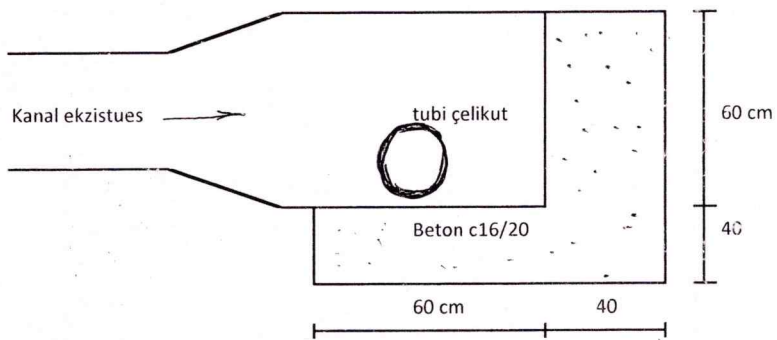

Shenim: Puseta do te behet me dy faqe anesore, ne tabanin e se ciles do vendoset tubi çelikut d=250mm



Republika Shqiperise BASHKIA DIBER	" Reabilitim dhe ndertimi I kanaleve vaditese 2024 "	MIRATOI Kryetari Rahim SPANU
	DETAJE,SKICA	Projektues Fatos Mandrri
Date __/__/2024	Faza Zbatim / Format A4 / Sh 1 : ____	Vizatim nr ____

Detaj mur mbajtes l= 6 m/l  
Kanali Dohoshisht

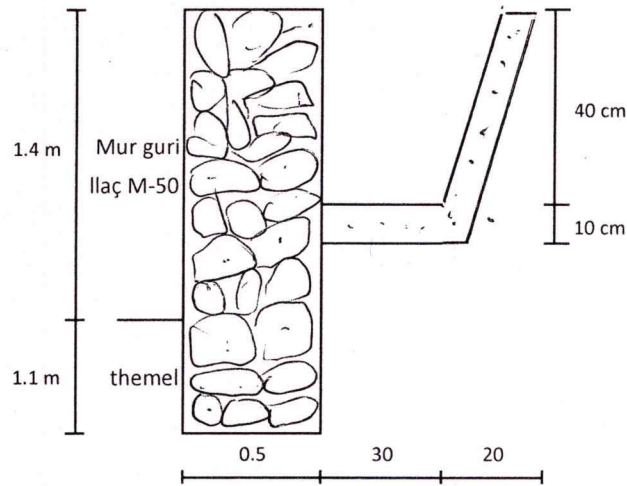

Detaj germimi Kanali Dobrove Nj.Ad. Peshkopi  
L= 80m/l

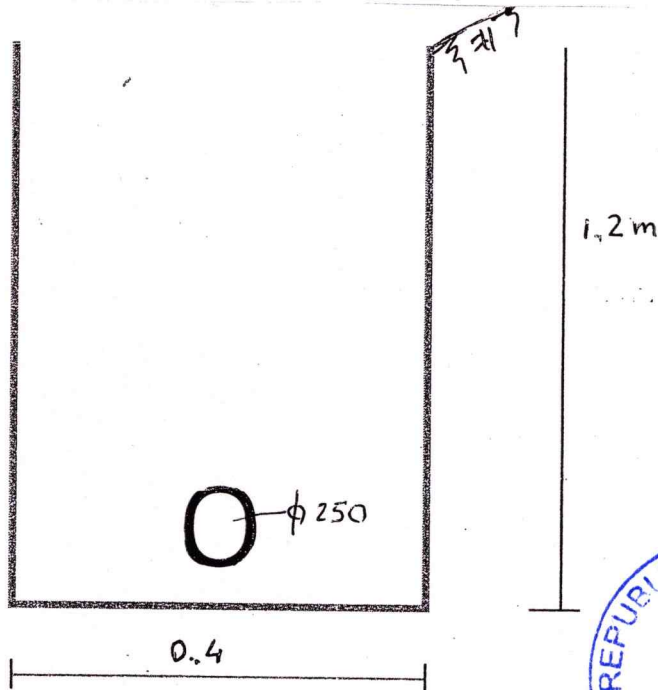

Republika Shqiperise BASHKIA DIBER	" Reabilitim dhe ndertimi I kanaleve vaditese 2024 "	MIRATOI Kryetari Rahim SPAHIU
	DETAJE,SKICA	Projektues Fatos Mandrri
Date __/__/2024	Faza Zbatim / Format A4 / Sh 1 : __	Vizatim nr __

Detaj prerje Kanali Dohoshisht, Nj. Ad. Tomin  
 Beton c 16/20 L=25 m

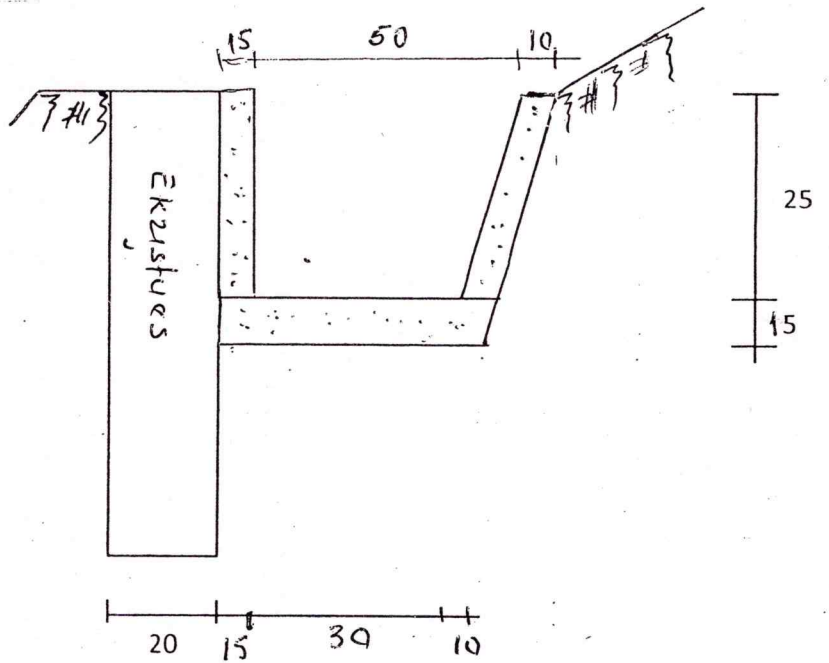

Beton c 16/20 L=65 m

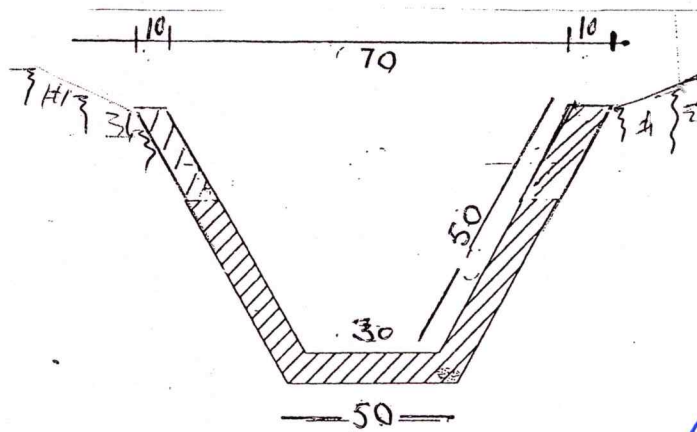

REPUBLICA E SHQIPERISE  
 BASHKIA DIBER  
 MIRATOI  
 Kryetari  
 Rahim SPANU  
 Fatos Mandrri  
 Vizatim nr

Republika Shqiperise BASHKIA DIBER	" Reabilitim dhe ndertimi I kanaleve vaditese 2024 "	Projektues Fatos Mandrri
	DETAJE,SKICA	Vizatim nr
Date __/__/2024	Faza Zbatim / Format A4 / Sh 1 : __	

Detaj mur mbajtes l= 3 m/l  
Kanali Dohoshisht

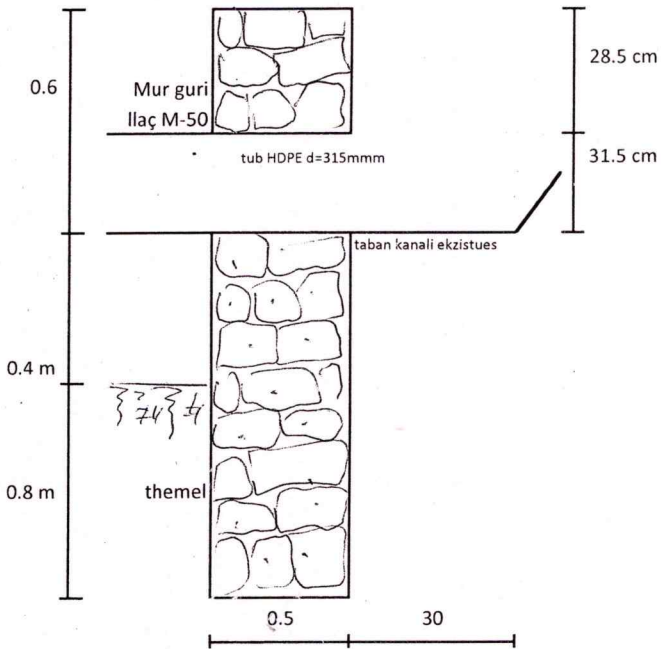

Detaj mur mbajtes l= 4 m/l  
Kanali Dohoshisht

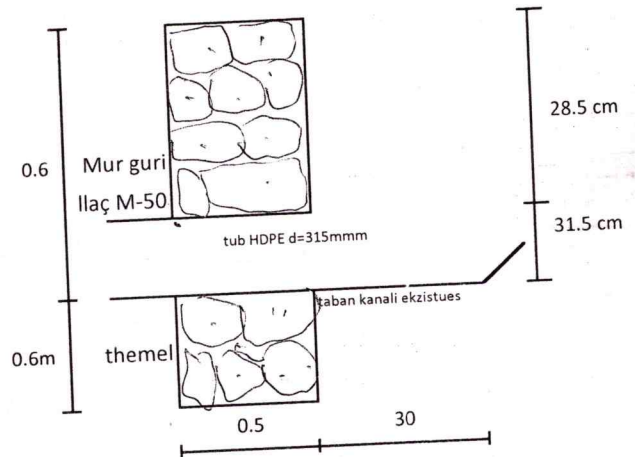

Detaj veshje tabani kanali Dohoshisht  
L=85 m/l

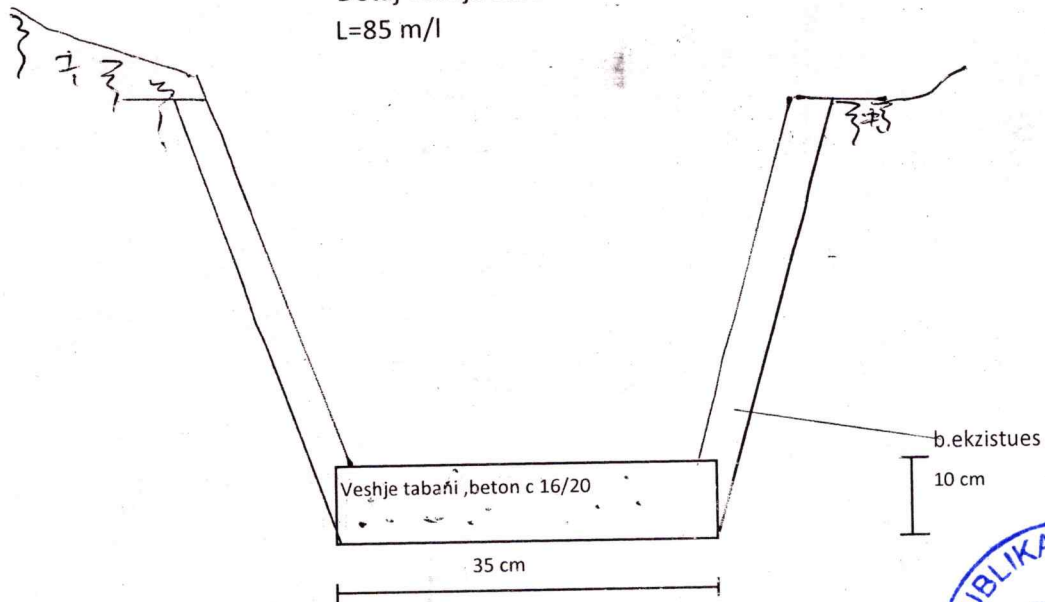

Shenim .Do behet veshja me beton e tabanit te demtuar te kanalit ekzistues



Republika Shqiperise BASHKIA DIBER	" Reabilitim dhe ndertimi I kanaleve vaditese 2024 "	MIRATOI Kryetari Rahim SPAHIU
	DETAJE,SKICA	Projektues Fatos Mandrri
Date ___/___/2024	Faza Zbatim / Format A4/ Sh 1 : ___	Vizatim nr _____



44 937  
09 936

# kanali Kallavere

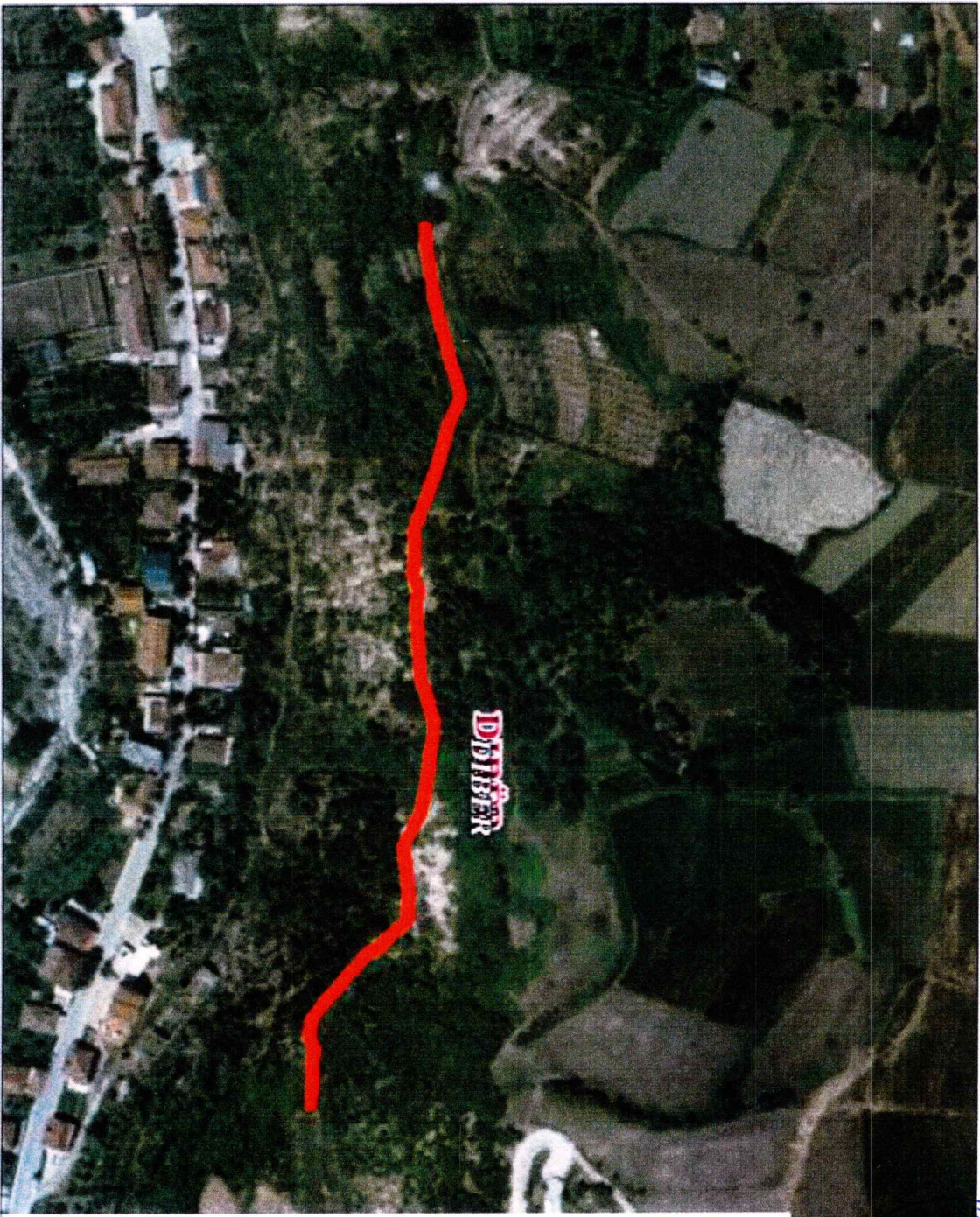

424 237  
312 836

<https://geoportali.asig.gov.al/otron-te-dhena-geonapetimitore-te-ofuara-nga-autoritetet-publike-perqiejese>  
Pergjegjësia për saktësinë e të dhënave është e autoritetit publik që i ka krijuar ato.

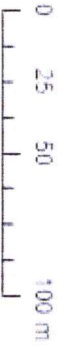

- Legjend:**
- Shtresë Eaze
  - Rendi 3 (Bashku)
  - Rendi 2 (Qarku)
  - Rendi 1
  - Re
  - Re

<https://geoportali.asig.gov.al>  
 MIRATOI Kryetari  
 RAMIR SPANU  
 Projektoes Fatos Mandrri  
 Vizatim nr \_\_\_\_\_

Republika Shqiperise BASHKIA DIBER	" Reabilitim dhe ndertimi I kanaleve vaditese 2024 "	
	DETAJE,SKICA	
Date __/__/2024	Faza Zbatim / Format A4 / Sh 1 : ____	Vizatim nr _____



370 558  
117 228

# kanali vadites Lagjia "Fejze"

<https://geoportal.gov.al>  
Data e P

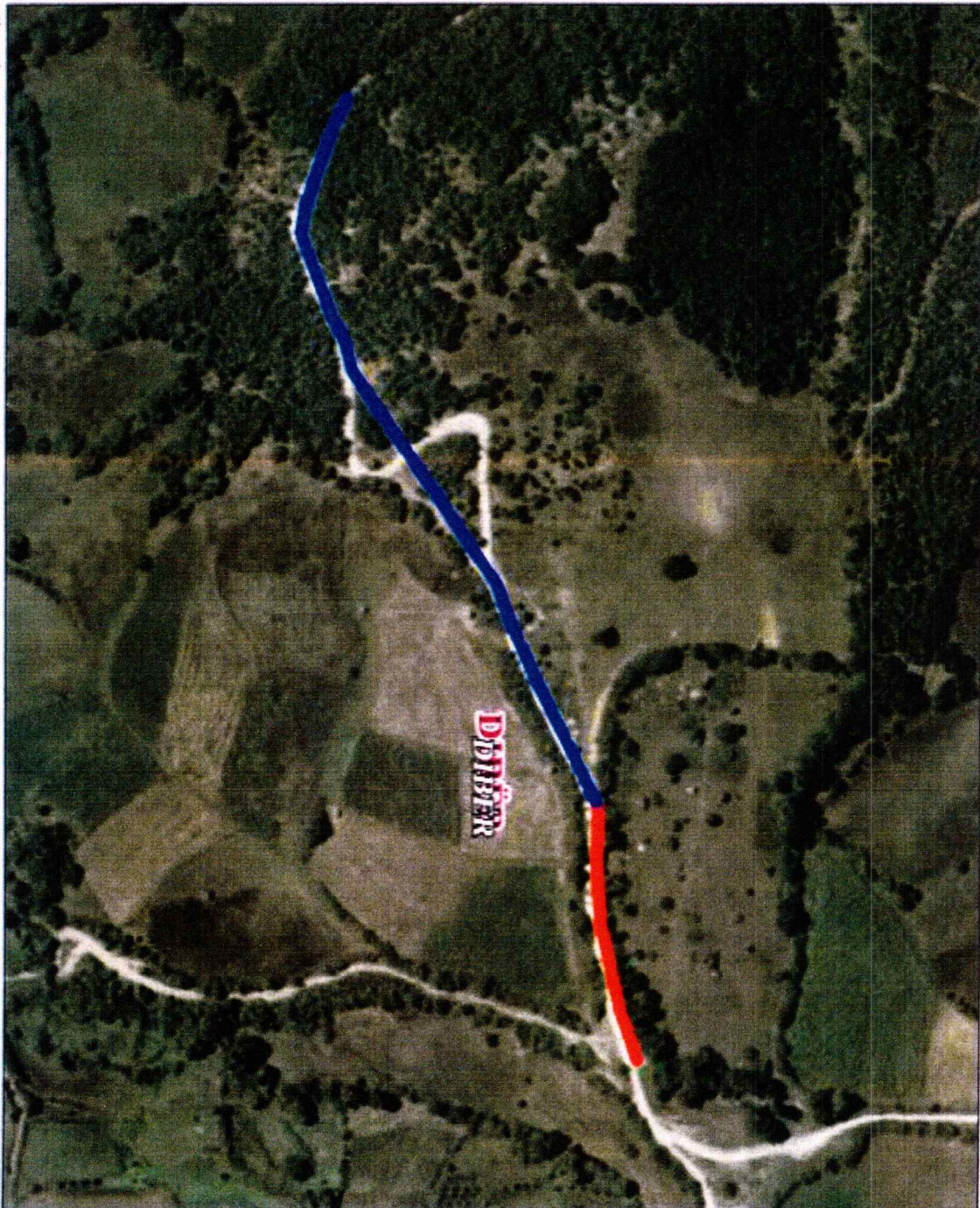

370 558  
324 526

<https://geoportal.gov.al> ofron te dhena  
gjeohapësimore te ofruara nga autoritetet publike  
përgjegjëse  
Përgjegësia për saktësinë e të dhënave është e  
autoritetit publik që i ka krijuar ato

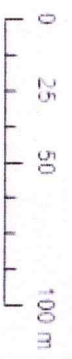

<b>Legjen</b>		Rendi 2 Qarkull
Shtesë Baze		Rendi 3 Bashki
		Rendi 1
		Re

**REPUBLIKA E SHQIPËRISE**  
**BASHKIA DIBER**

**MIRATOI**  
Kryetar  
**Rahim SPAHIU**

Projektues  
Fatos Mandri

Vizatim nr \_\_\_\_\_

<b>Republika Shqiperise</b> <b>BASHKIA DIBER</b>	" Reabilitim dhe ndertimi I kanaleve vaditese 2024 "
	<b>DETAJE,SKICA</b>
Date __/__/2024	Faza Zbatim / Format A4 / Sh 1 : _____



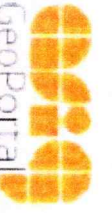

# kanali Vajmdhej

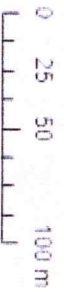
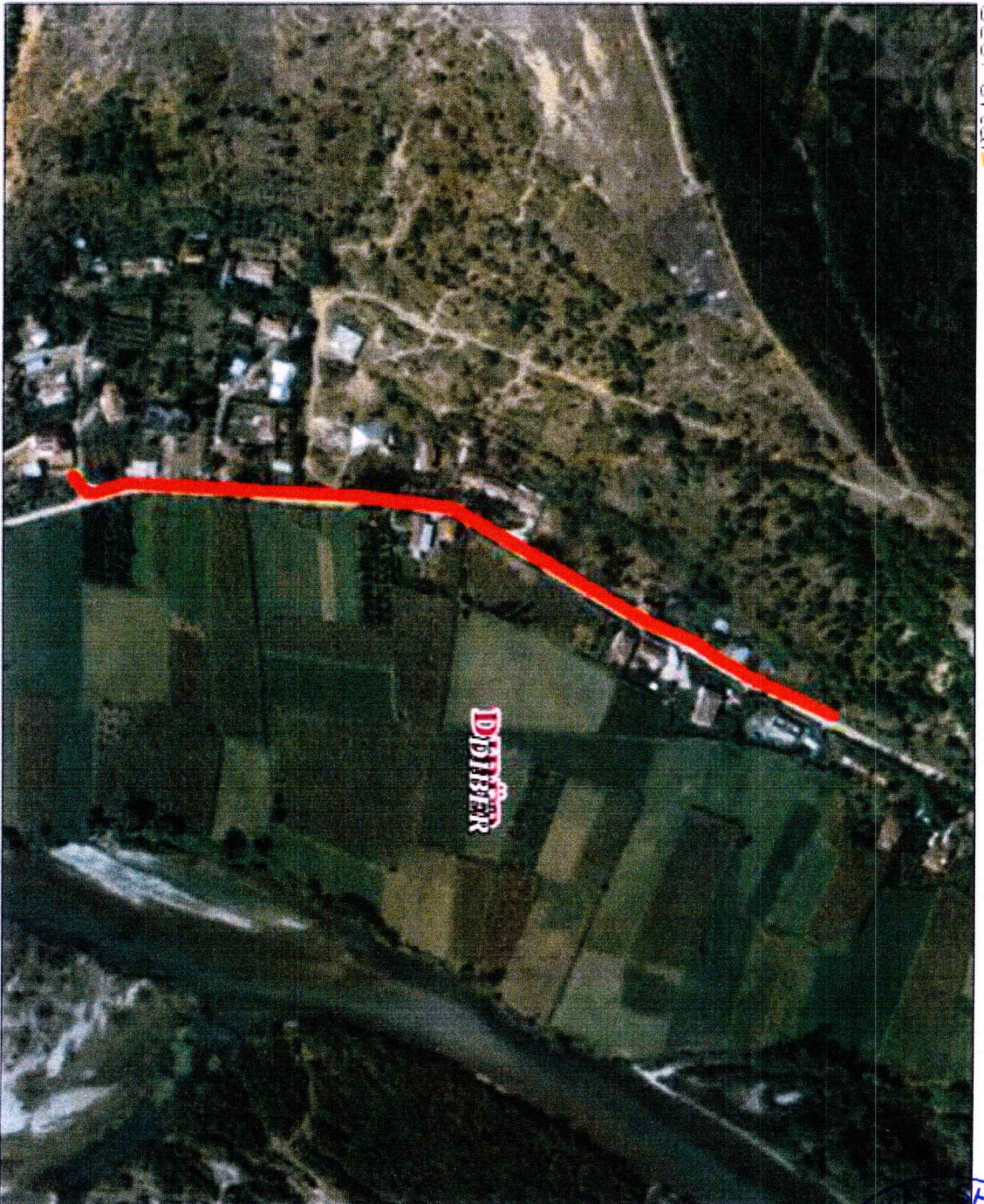

https://geoportal.asig.gov.al/iron/te-dhena-  
gjeonapetimore-te-ofruara-nga-autoritetet-publike-  
perqiejese  
Perqiejese per saktesine e te dhena eshte e  
autoritetit publik qe i ka krijuar ato

**Legjen**

- Shtrese Baze
- Rendi 1
- Rendi 2 (Qarku)
- Rendi 3 (Bashki)
- Re
- Re



Republika Shqiperise <b>BASHKIA DIBER</b>	" Reabilitim dhe ndertimi I kanaleve vaditese 2024 "	MIRATOI Kryetari Rahim SPAHIU
	DETAJE,SKICA	Projektues Fatos Mandrri
Date ___/___/2024	Faza Zbatim / Format A4 / Sh 1 : ___	Vizatim nr _____



# sifoni celikut L=180ml

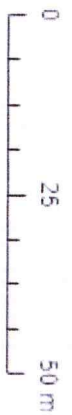

132 757  
334 287

https://geoportal.asig.gov.al/ofroni-te-dhena-  
qeo-napasinore-te-ofruara-nga-autoritetet-publike-  
per-qeqljese  
Perqeljesia per saktesine e te dhenave eshte e  
autoritetit publik qe i ka krijuar ato

	Re
	Rendi 1
	Rendi 2 (Qarkull)
	Rendi 3 (Eashku)
	Baze
	Shtese
	Legjen

ERISE-  
MIRATOI  
Kryetari  
Rahim SPAHIU

BASHKIA DIBER

Projektues  
Fatos Mandrri

Vizatim nr

Republika Shqiperise BASHKIA DIBER	" Reabilitim dhe ndertimi I kanaleve vaditese 2024 "
	DETAJE,SKICA
Date ___/___/2024	Faza Zbatim / Format A4 / Sh 1 : ___



# Kanali Melan (Kerjake)

012 369  
324 133



012 369  
333 733

<https://geoportali.asig.gov.al/ofron-te-dhena>

qjeonapesinore te ofruara nga autoritetet publike  
përgjegjëse

Përgjegësia për saktësinë e të dhënave është e  
autoritetit publik që i ka krijuar ato

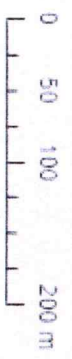

- Legjien**
- Shtresë
  - Baze
  - Rendi 1
  - Rendi 2
  - Rendi 3
  - Rendi 4
  - Rendi 5
  - Rendi 6
  - Rendi 7
  - Rendi 8
  - Rendi 9
  - Rendi 10
  - Rendi 11
  - Rendi 12
  - Rendi 13
  - Rendi 14
  - Rendi 15
  - Rendi 16
  - Rendi 17
  - Rendi 18
  - Rendi 19
  - Rendi 20
  - Rendi 21
  - Rendi 22
  - Rendi 23
  - Rendi 24
  - Rendi 25
  - Rendi 26
  - Rendi 27
  - Rendi 28
  - Rendi 29
  - Rendi 30
  - Rendi 31
  - Rendi 32
  - Rendi 33
  - Rendi 34
  - Rendi 35
  - Rendi 36
  - Rendi 37
  - Rendi 38
  - Rendi 39
  - Rendi 40
  - Rendi 41
  - Rendi 42
  - Rendi 43
  - Rendi 44
  - Rendi 45
  - Rendi 46
  - Rendi 47
  - Rendi 48
  - Rendi 49
  - Rendi 50
  - Rendi 51
  - Rendi 52
  - Rendi 53
  - Rendi 54
  - Rendi 55
  - Rendi 56
  - Rendi 57
  - Rendi 58
  - Rendi 59
  - Rendi 60
  - Rendi 61
  - Rendi 62
  - Rendi 63
  - Rendi 64
  - Rendi 65
  - Rendi 66
  - Rendi 67
  - Rendi 68
  - Rendi 69
  - Rendi 70
  - Rendi 71
  - Rendi 72
  - Rendi 73
  - Rendi 74
  - Rendi 75
  - Rendi 76
  - Rendi 77
  - Rendi 78
  - Rendi 79
  - Rendi 80
  - Rendi 81
  - Rendi 82
  - Rendi 83
  - Rendi 84
  - Rendi 85
  - Rendi 86
  - Rendi 87
  - Rendi 88
  - Rendi 89
  - Rendi 90
  - Rendi 91
  - Rendi 92
  - Rendi 93
  - Rendi 94
  - Rendi 95
  - Rendi 96
  - Rendi 97
  - Rendi 98
  - Rendi 99
  - Rendi 100



Republika Shqiperise <b>BASHKIA DIBER</b>	" Reabilitim dhe ndertimi I kanaleve vaditese 2024 "	MIRATOI Kryetari <b>RABIA SPANIU</b>
	DETAJE,SKICA	Projektues Fatos Mandrri
Date __/__/2024	Faza Zbatim / Format A4 / Sh 1 : ____	Vizatim nr ____

# Kanali Vakuf

<https://geoportal.asig.gov.al>  
Data e Printimit: 12.02.2024

530230 4  
4617644 0

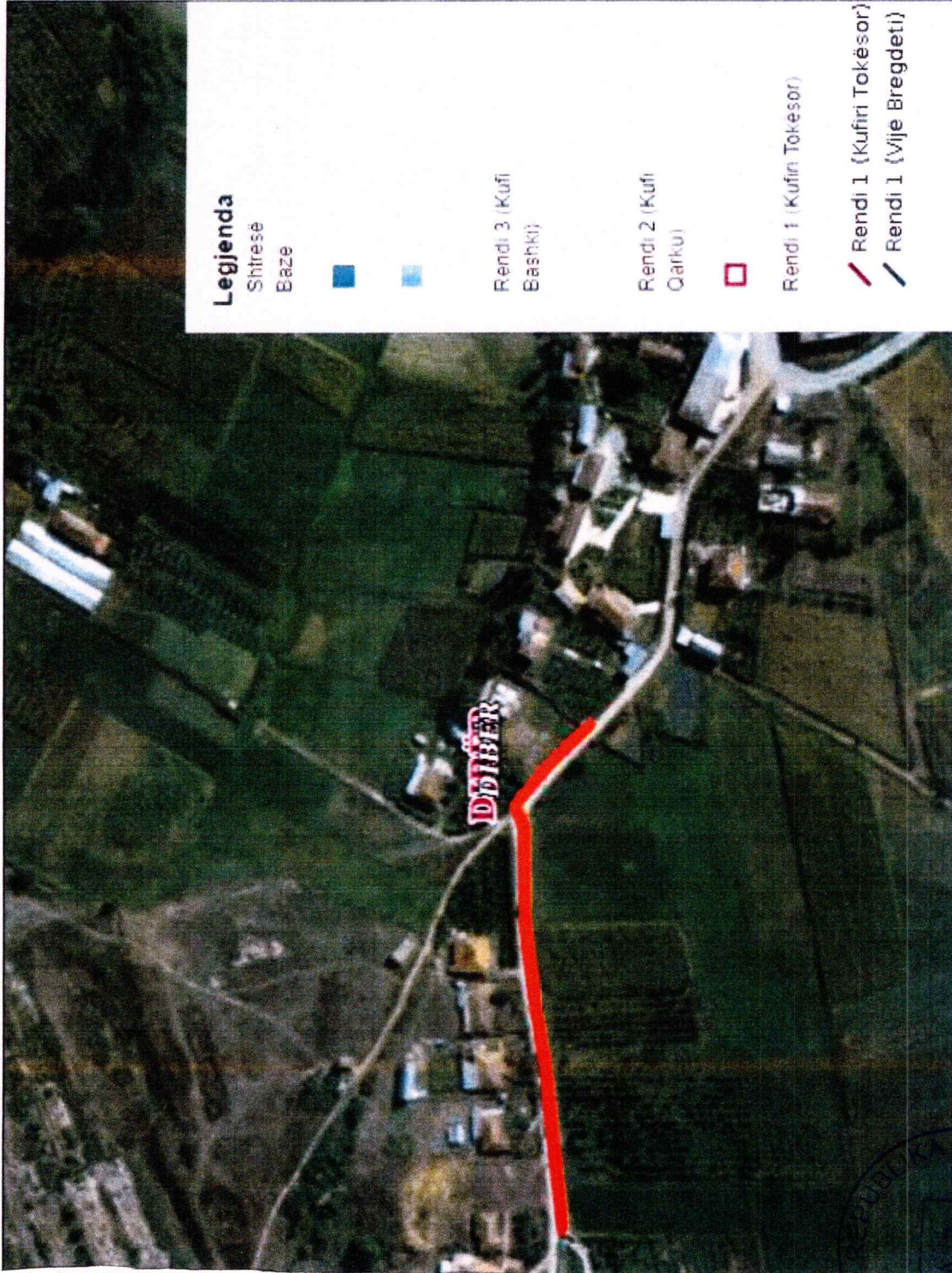

Republika Shqiperise <b>BASHKIA DIBER</b>	" Reabilitim dhe ndertimi I kanaleve vaditese 2024 "	<b>MIRATOI</b> Kryetari <b>Rahim SPAHIU</b>
	DATEJ,SKICA	Projektues Fatos Mandrri
Date __/__/2024	Faza Zbatim / Format A4 / Sh 1 : ____	Vizatim nr. _____

Shikoni te dhënat  
nga autoritetet publike  
e te dhënave eshte e  
qartë

**BASHKIA DIBER**

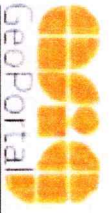

# kanali Melan Trepce

30 457  
10 336

130 457  
775 885



<https://geoportal.gov.al>  
Data: 15/11/2024

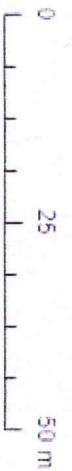

<https://geoportal.gov.al> ofron te dhena gjeohapësinore te ofruara nga autoritetet publike perqiejese Përqiejese per saktësimet e te dhënave eshte e autoritetit publik qe i ka krijuar ato.

<b>Legjendë</b>
Shtresë Baze
Rendi 3 Bashki
Rendi 2 Qarku
Rendi 1
Re
Re

Republika Shqiperise <b>BASHKIA DIBER</b>	" Reabilitim dhe ndertimi I kanaleve vaditese 2024 "	
	DETAJE,SKICA	
Date __/__/2024	Faza Zbatim / Format A4 / Sh 1 : __	Vizatim nr