



REPUBLIKA E SHQIPERISE  
BASHKIA PEQIN

## PROJEKT ZBATIMI: RINDERTIMI I SHKOLLES 9-VJECARE SHEZE PROJEKTI HIDROTEKNIK



PROJEKTUES  
"A.SH. ENGINEERING" sh.pk

MAJ, 2024

# PLANI I FURNIZIMIT ME UJE

## SHKOLLA

REPUBLIKA E SHQIPERISE

BASHKIA PEQIN

KLIENT: BASHKIA PEQIN

PROJEKT ZBATIMI: RINDERTIMI I SHKOLLES 9-VJECARE SHEZE

EMERTIMI I FLETES:  
PLANI I FURNIZIMIT ME UJE

APROVIMI I KLIENTIT:

PROJEKTUAR:

"A.SH. ENGINEERING" sh.pk

VENDNDODHJA E OBJEKTIT: PEQIN

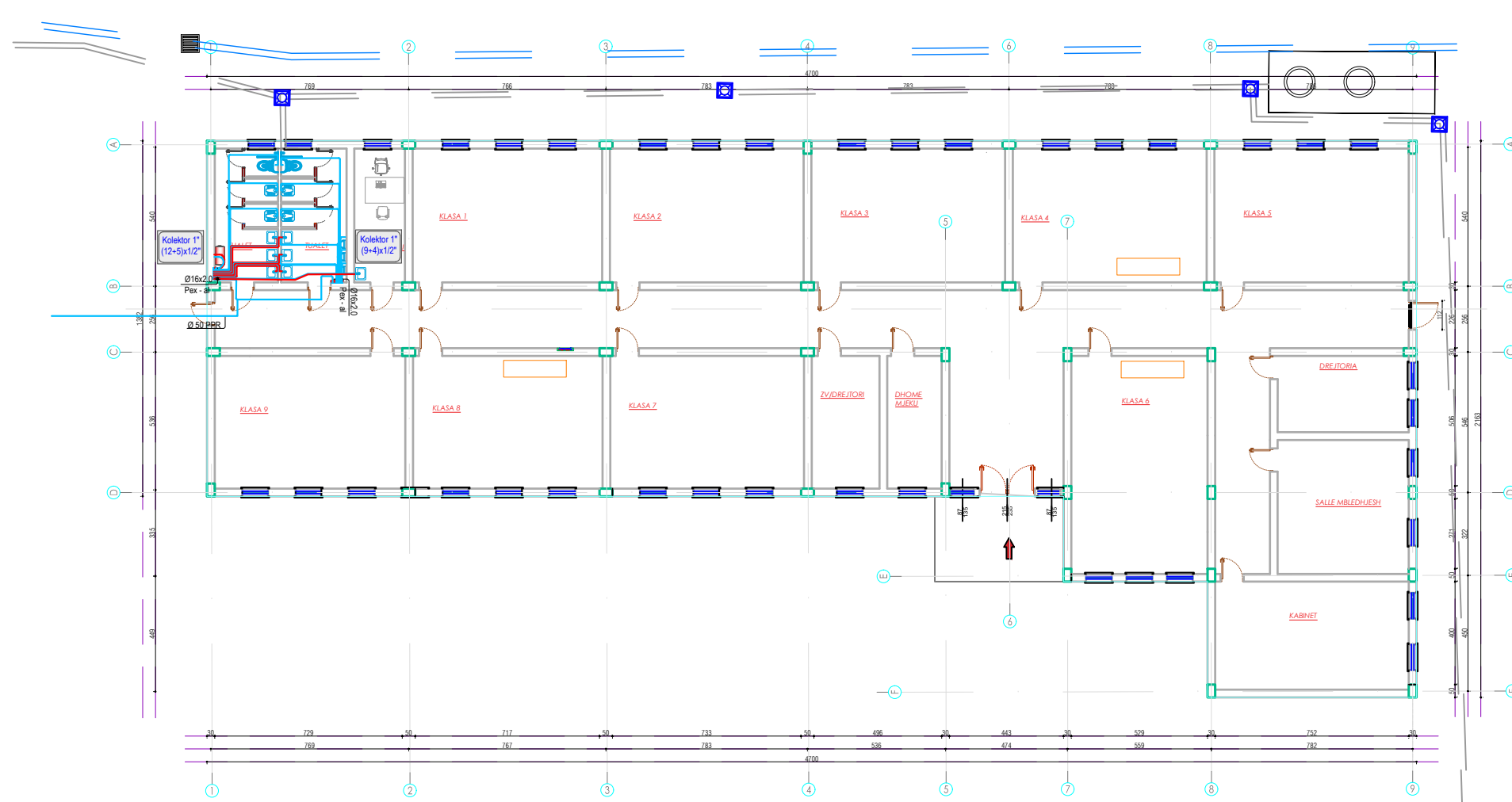

DETAJ I

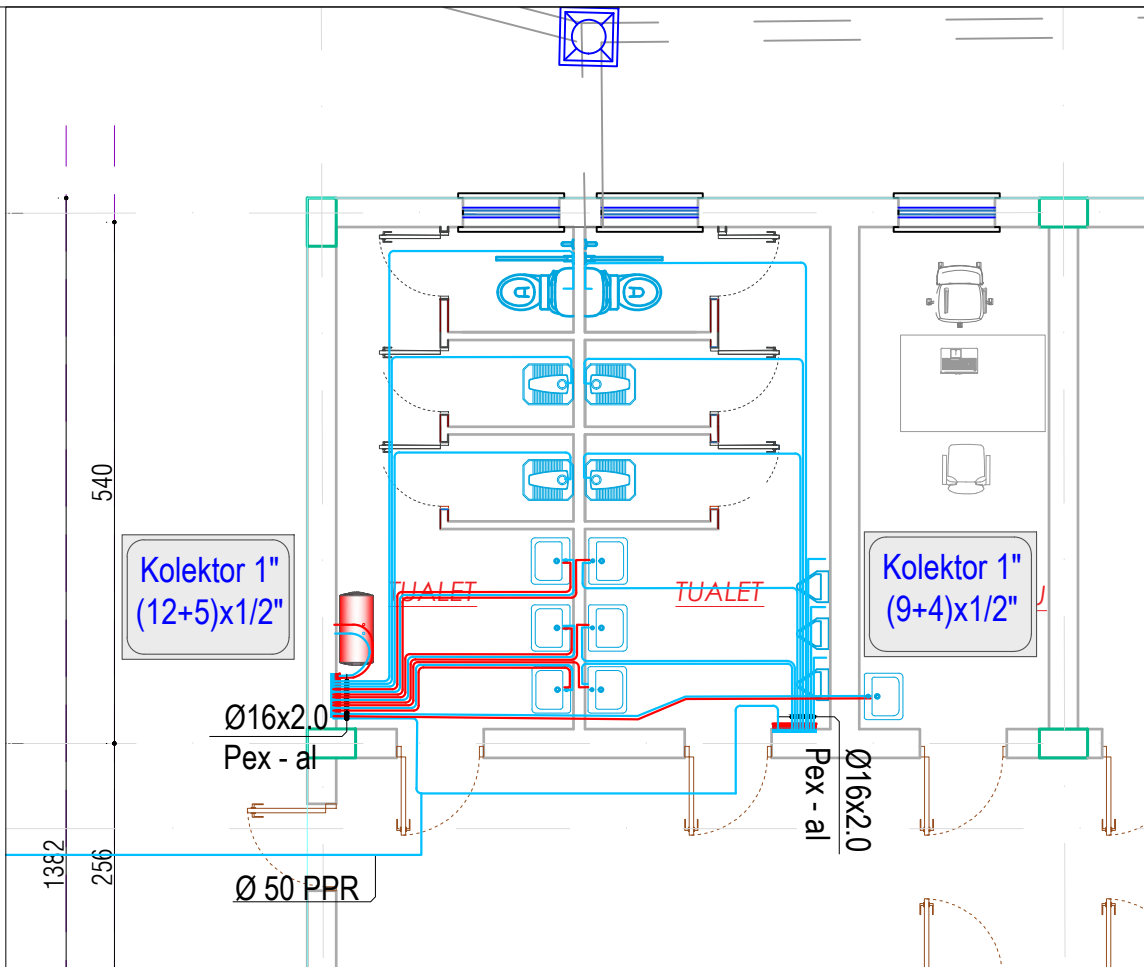

PLANI I FURNIZIMIT ME UJE  
KOPSHTI

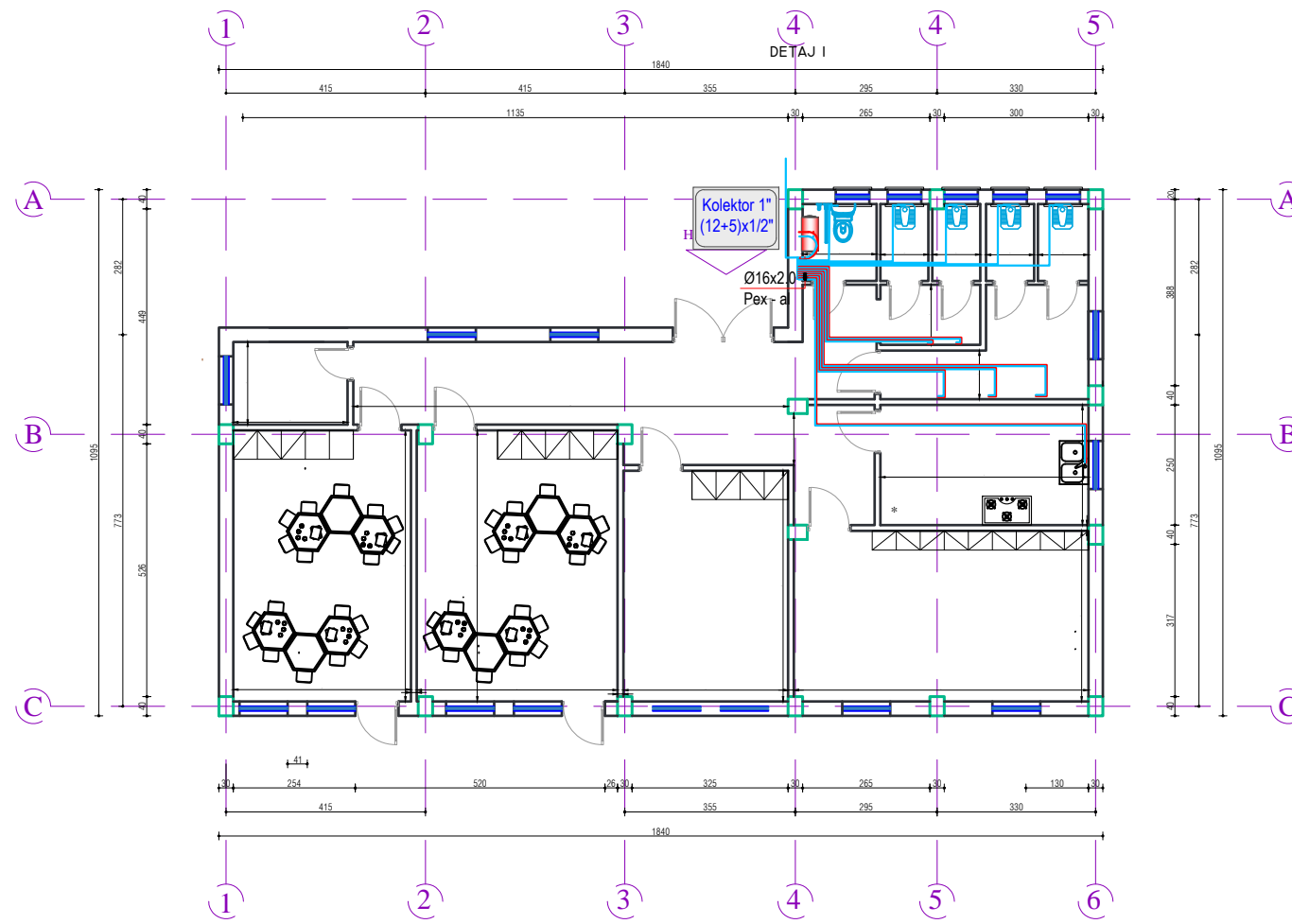

DETAJ I

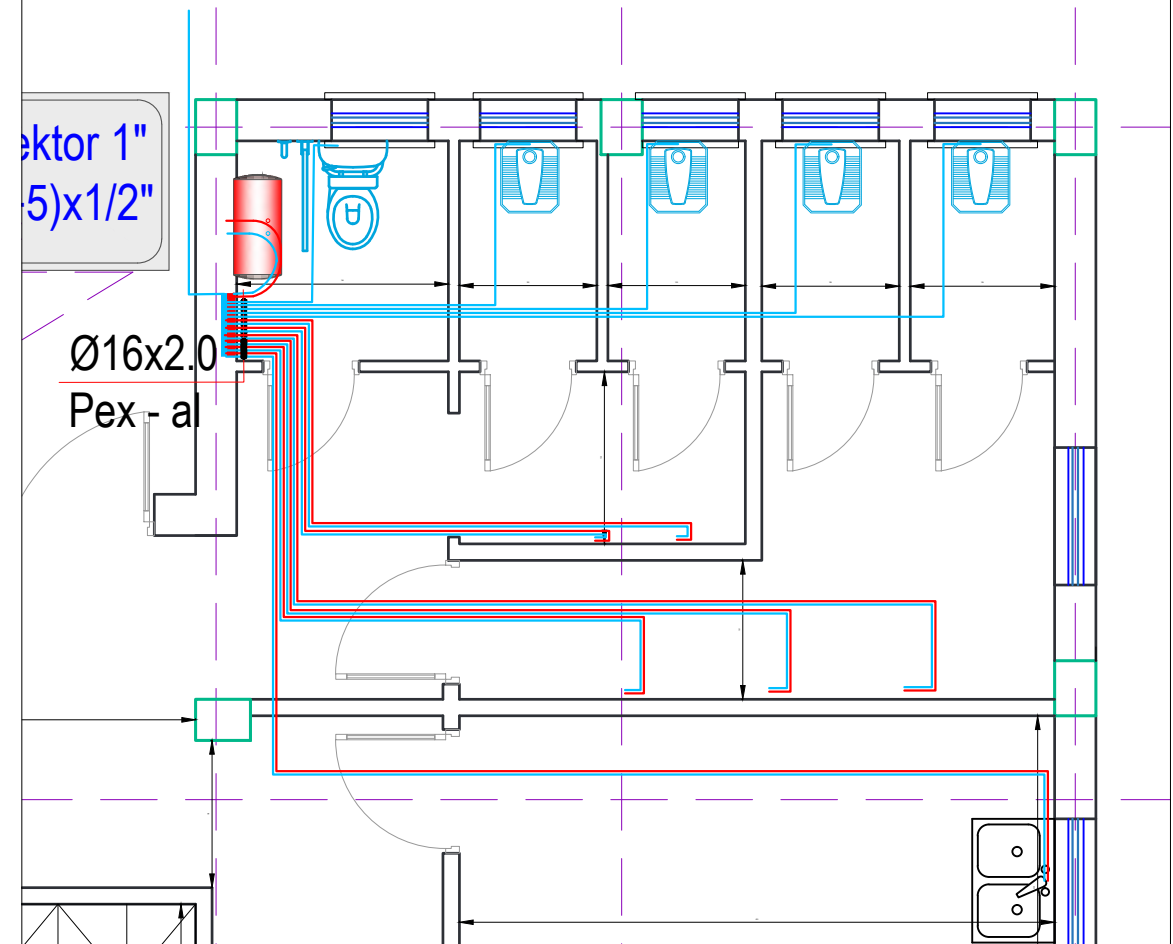

REPUBLIKA E SHQIPERISE

BASHKIA PEQIN

KLIENT: BASHKIA PEQIN

PROJEKT ZBATIMI: RINDERTIMI I SHKOLLES 9-VJECARE SHEZE

EMERTIMI I FLETES:  
PLANI I FURNIZIMIT ME UJE

APROVIMI I KLIENTIT:

PROJEKTUAR:

"A.SH. ENGINEERING" sh.pk

VENDNDODHJA E OBJEKTIT: PEQIN

SHKOLLA

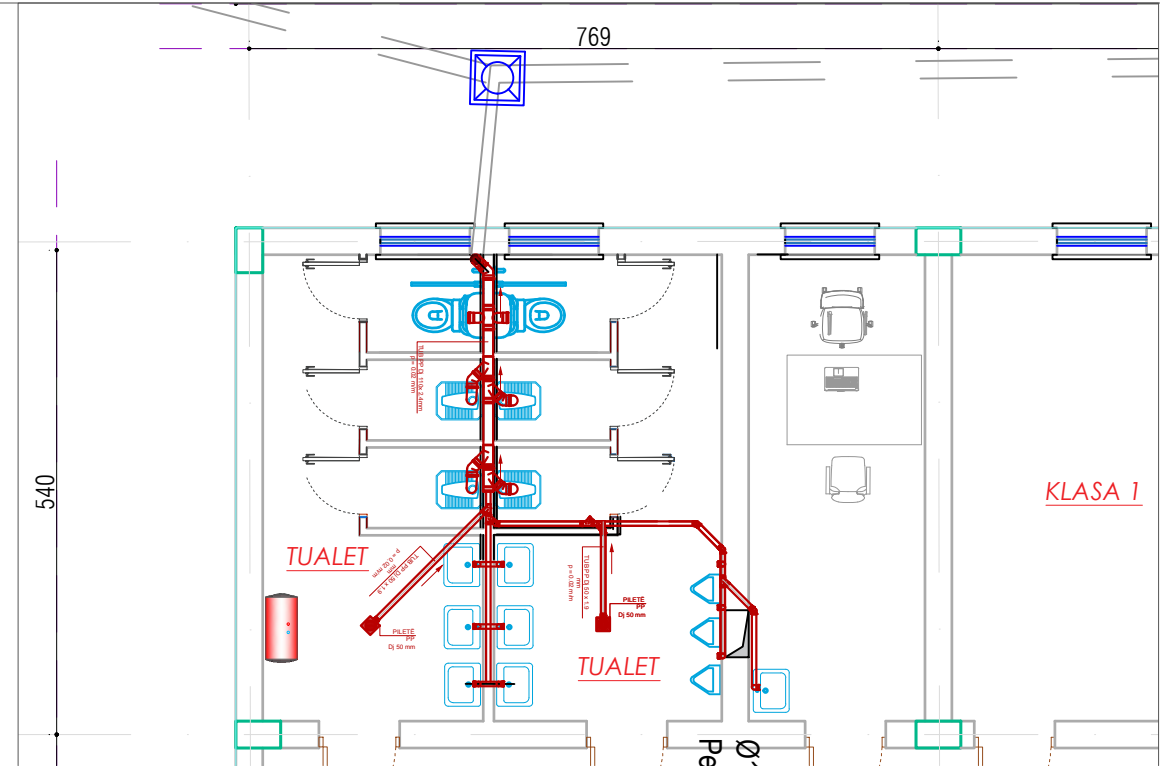
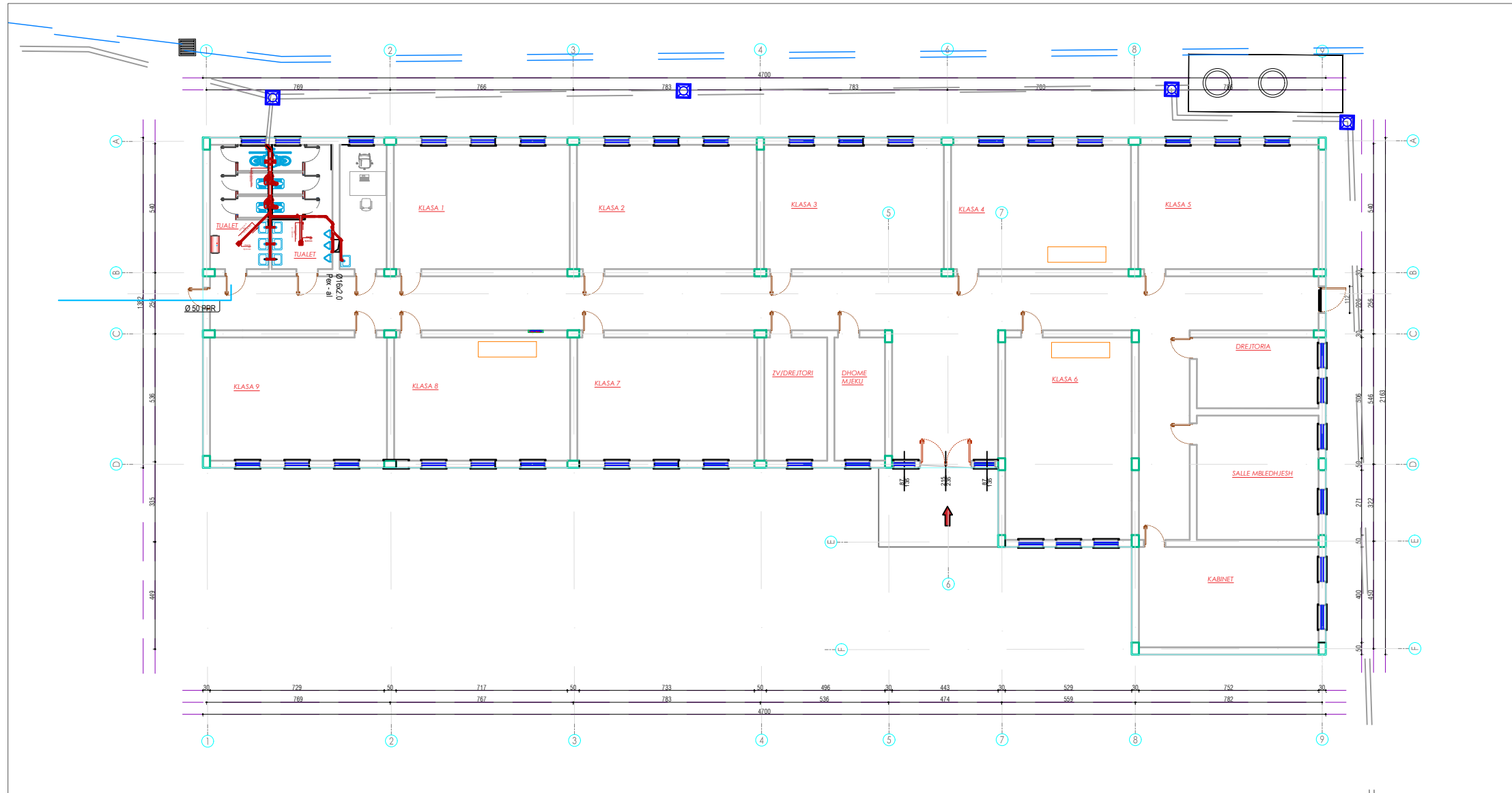

REPUBLIKA E SHQIPERISE

BASHKIA PEQIN

KLIENT: BASHKIA PEQIN

PROJEKT ZBATIMI: RINDERTIMI I SHKOLLES 9-VJECARE SHEZE

EMERTIMI I FLETES:  
PLANI I SHKARKIMEVE TE UJERAVE TE NDOTUR

APROVIMI I KLIENTIT:

PROJEKTUAR:

"A.SH. ENGINEERING" sh.pk

VENDNDODHJA E OBJEKTIT: PEQIN

# KOPSHTI

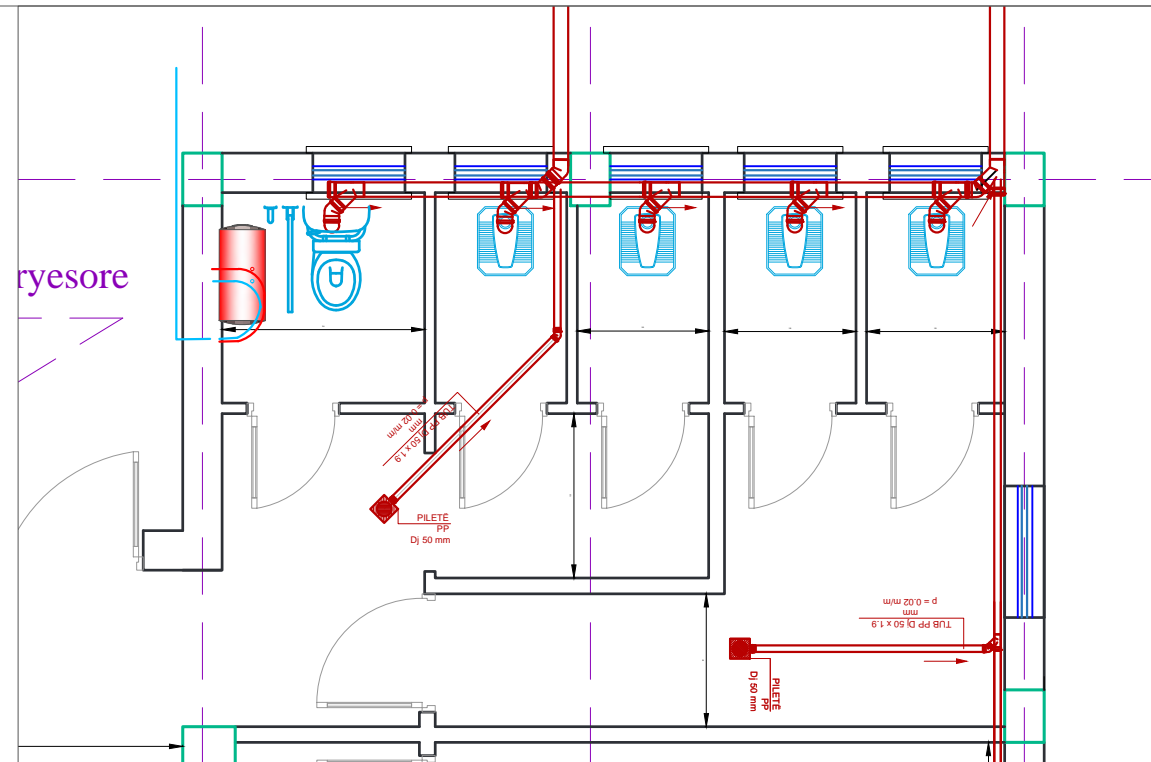
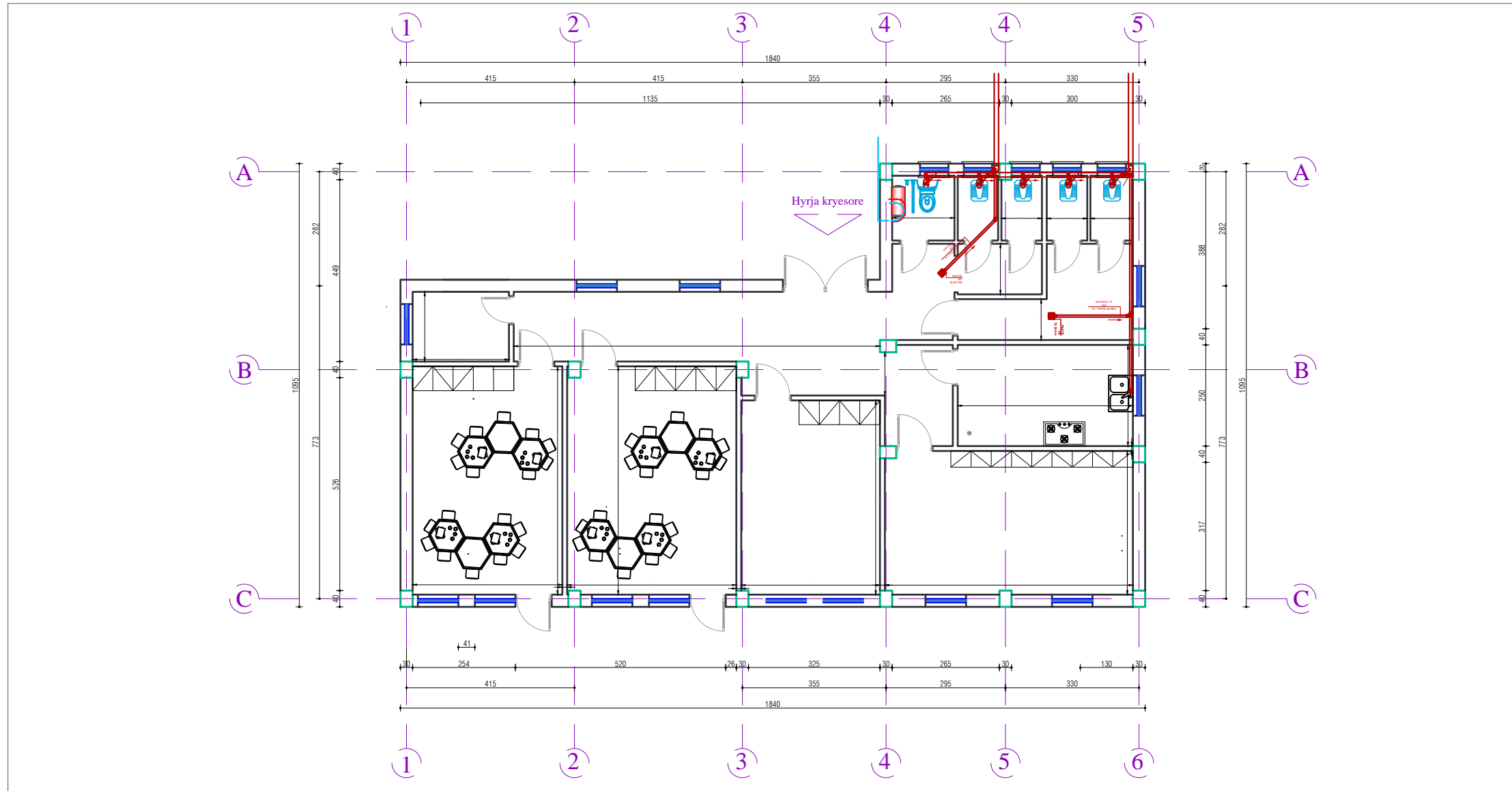

REPUBLIKA E SHQIPERISE

BASHKIA PEQIN

KLIENT: BASHKIA PEQIN

PROJEKT ZBATIMI: RINDERTIMI I SHKOLLES 9-VJECARE SHEZE

EMERTIMI I FLETES:  
PLANI I SHKARKIMEVE TE UJERAVE TE NDOTUR

APROVIMI I KLIENTIT:

PROJEKTUAR:

"A.SH. ENGINEERING" sh.pk

VENDNDODHJA E OBJEKTIT: PEQIN

PLANIMETRIA SHK.1:50

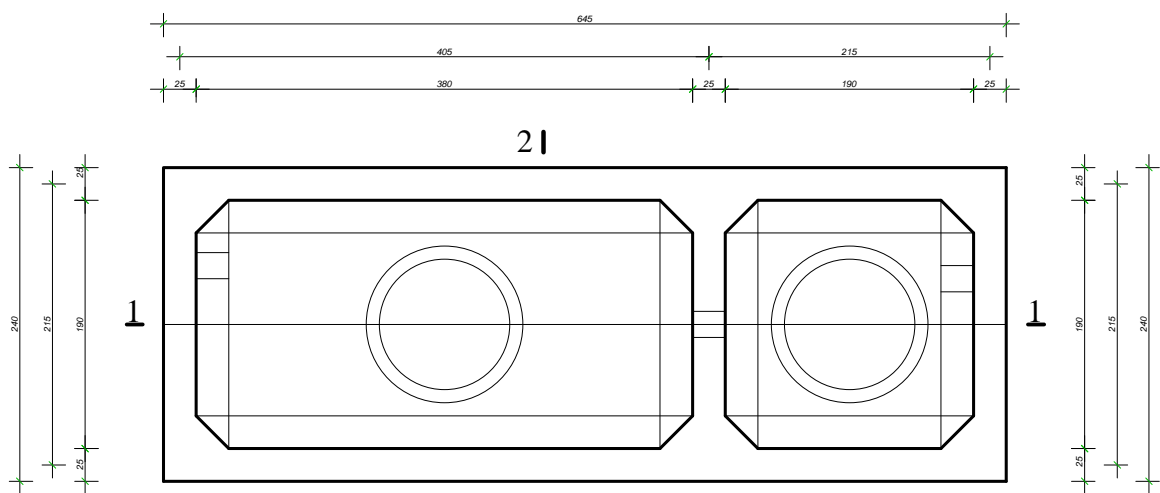

21

21

PRERJA 1-1 SHK.1:50

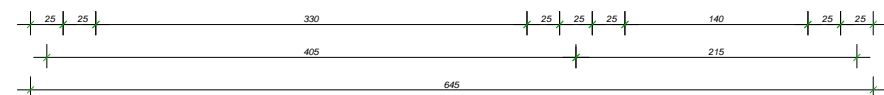
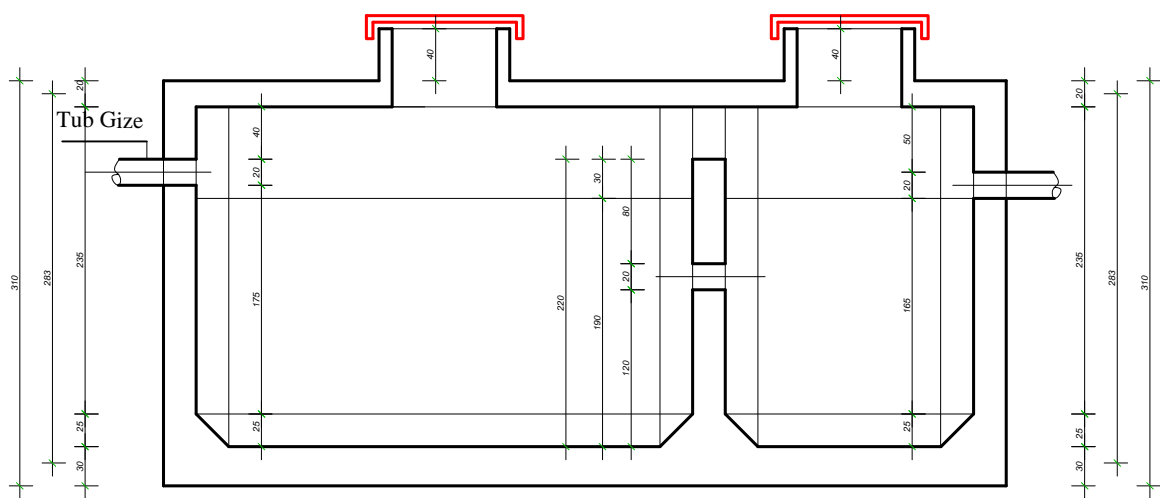
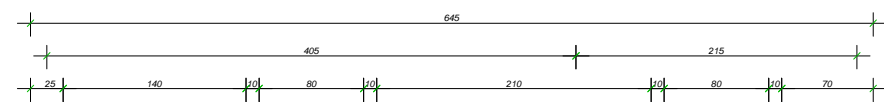

PAMJA NGA LART SHK.1:50

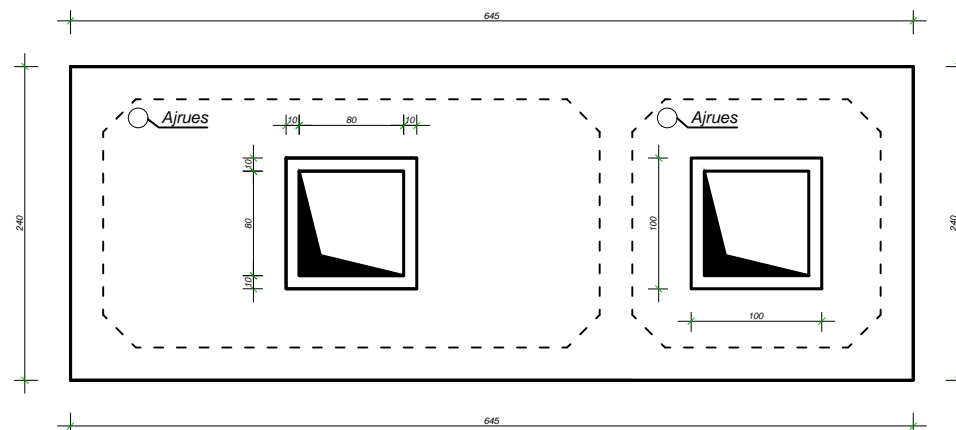

PRERJA 2-2 SHK.1:50

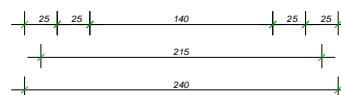
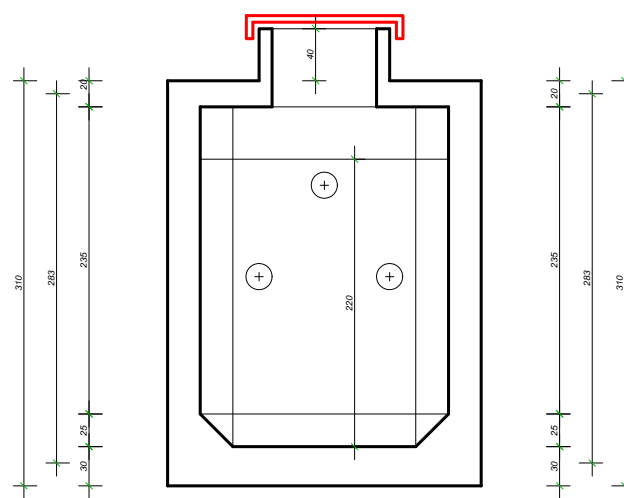
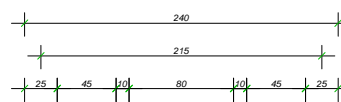

REPUBLIKA E SHQIPERISE

BASHKIA PEQIN

KLIENT: BASHKIA PEQIN

PROJEKT ZBATIMI: RINDERTIMI I SHKOLLES 9-VJECARE SHEZE

EMERTIMI I FLETES:  
GROPA SEPTIKE

APROVIMI I KLIENTIT:

PROJEKTUAR:

"A.SH. ENGINEERING" sh.pk

VENDNDODHJA E OBJEKTIT: PEQIN



ARMIMI I DYSHEMESE POSHTE

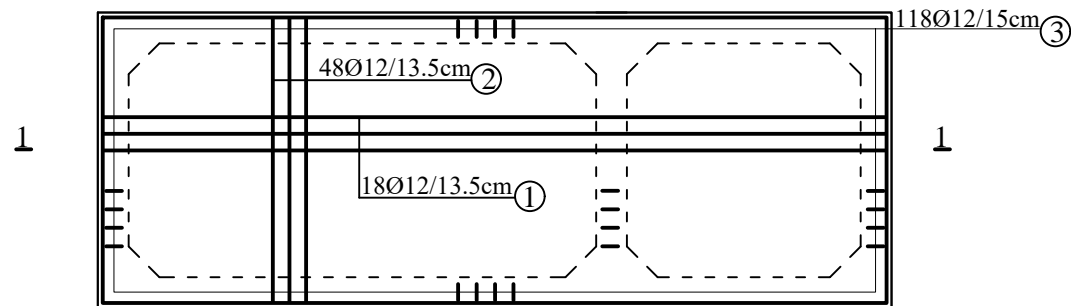

ARMIMI I DYSHEMESE LART

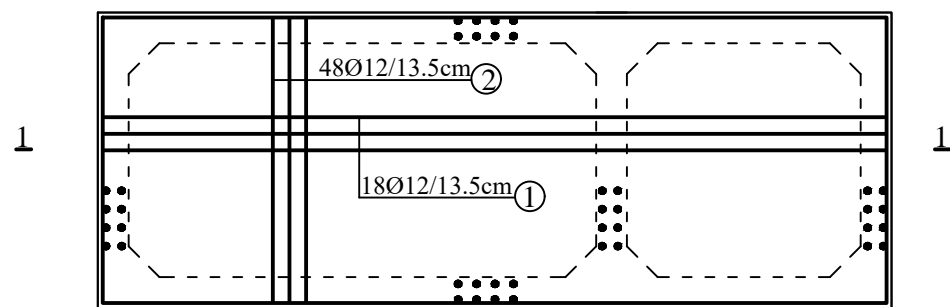

ARMIMI I MUREVE

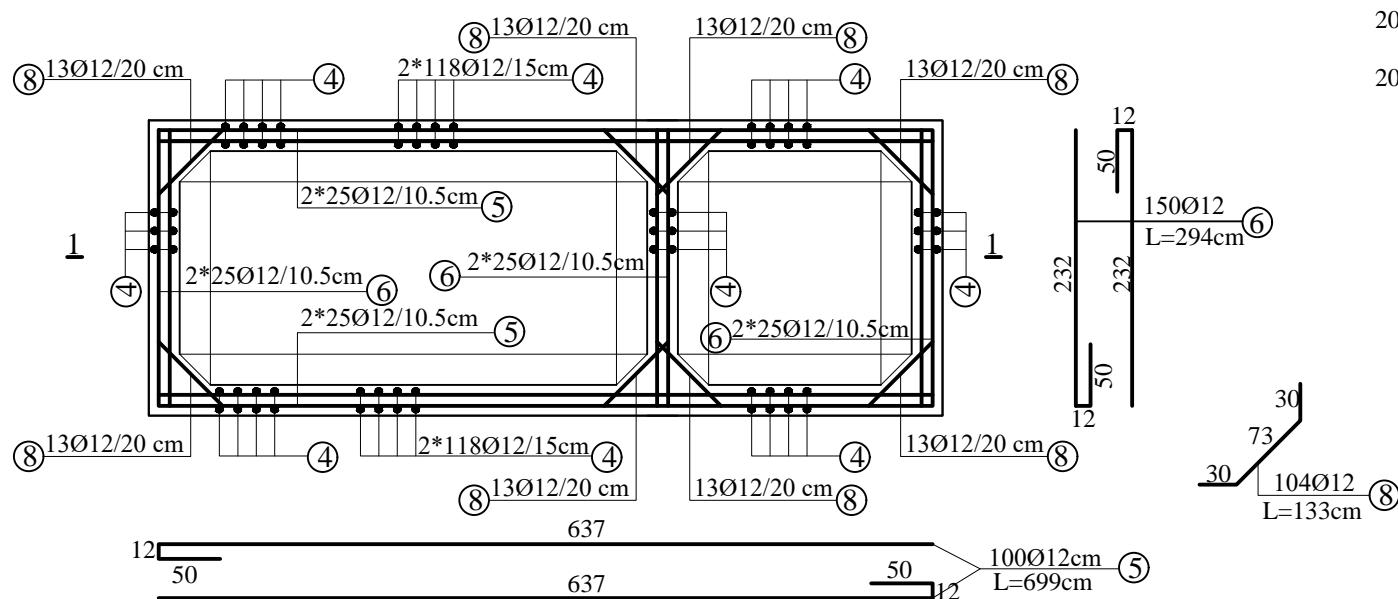

PRERJA 1-1

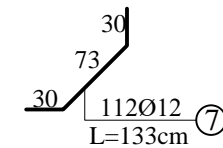
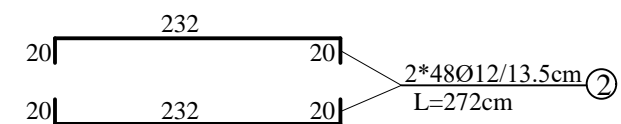
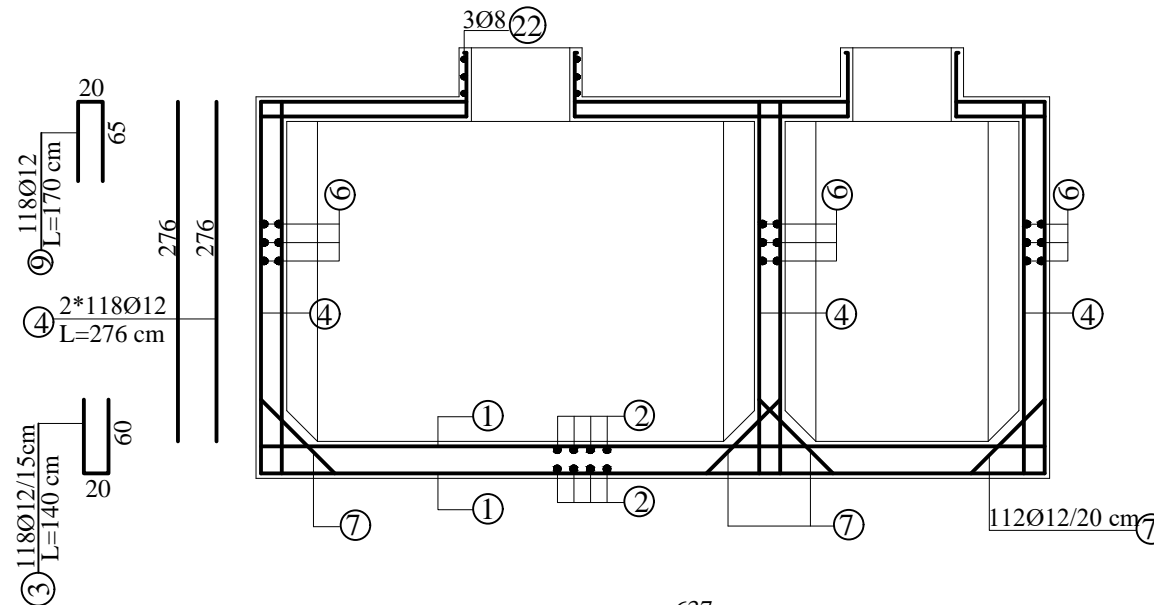

BETON M-250  
ÇELIKU FeB 44k  
me  $\sigma_{rrj} \geq 430 \text{ N/mm}^2$ .

Tabela e Specifikimit te Armatures

Emri	Nr.	Ø	L,cm	Cope	ΣL,m	Ø	ΣL,m	Pesha, kg
Gropa Septike	1	12	677	36	243.7	8	19	8
	2	12	272	96	261.1	12	3364	3011
	3	12	140	118	165.2			
	4	12	276	236	651.4			
	5	12	699	100	699			
	6	12	294	150	441			
	7	12	133	112	149			
	8	12	133	104	138.3			
	9	12	170	118	200.6			
	10	12	670	10	67			
	11	12	237	6	14.2			
	12	12	329	6	19.7			
	13	12	142	6	8.5			
	14	12	265	28	74.2			
	15	12	142	24	34.1			
	16	12	640	10	64			
	17	12	200	6	12			
	18	12	255	6	15.3			
	19	12	105	6	6.3			
	20	12	265	28	74.2			
	21	12	105	24	25.2			
	22	8	330	6	19			3019

**BETON M-250**  
**ÇELIKU FeB 44k**  
me  $\sigma_{rrj} \geq 430 \text{ N/mm}^2$ .

Armimi i Soletes-Hekurat Poshte

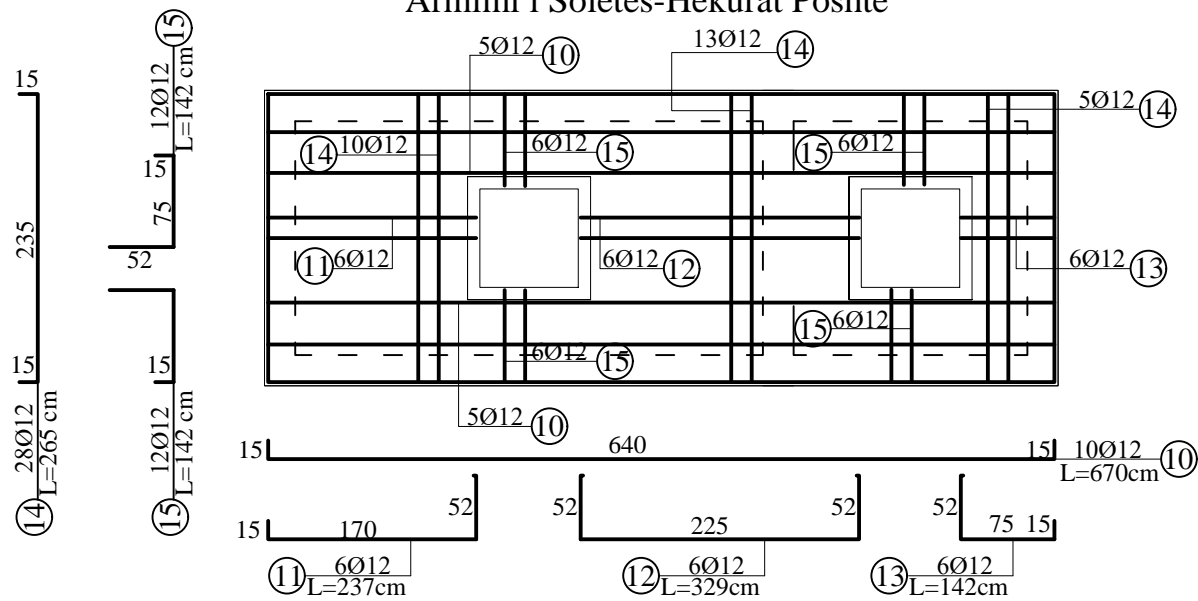

Armimi i Soletes-Hekurat Lart

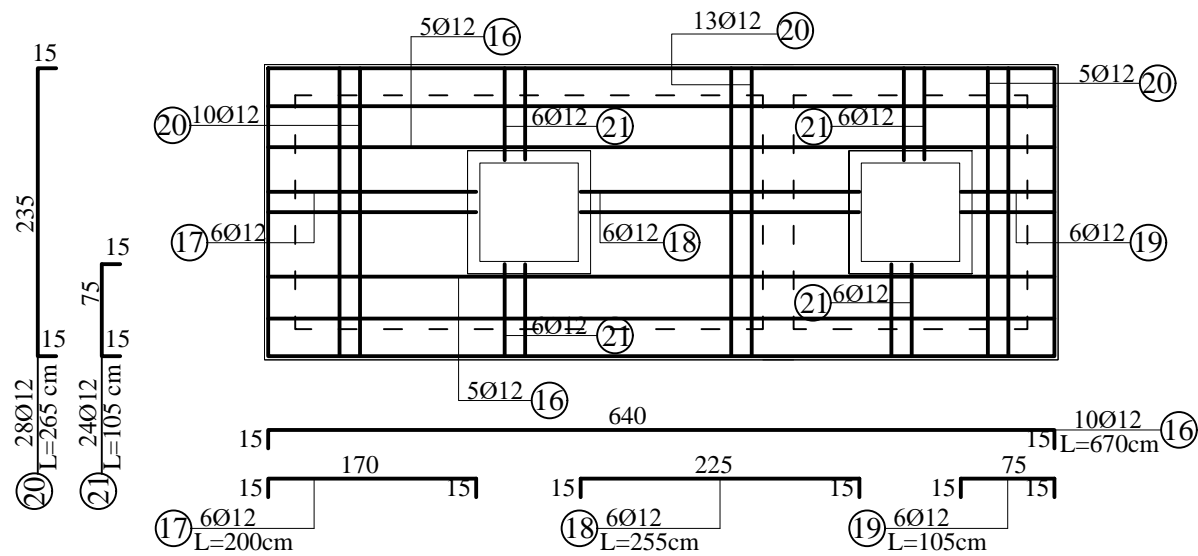

Prerja e Soletes

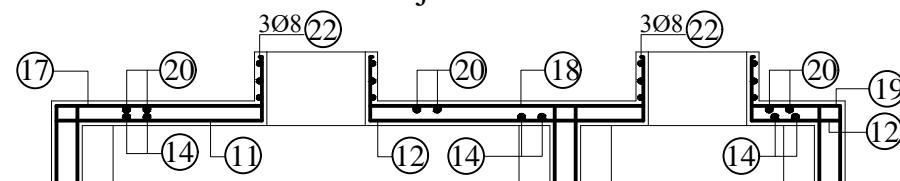



PLANIMETRIA E Pusetes

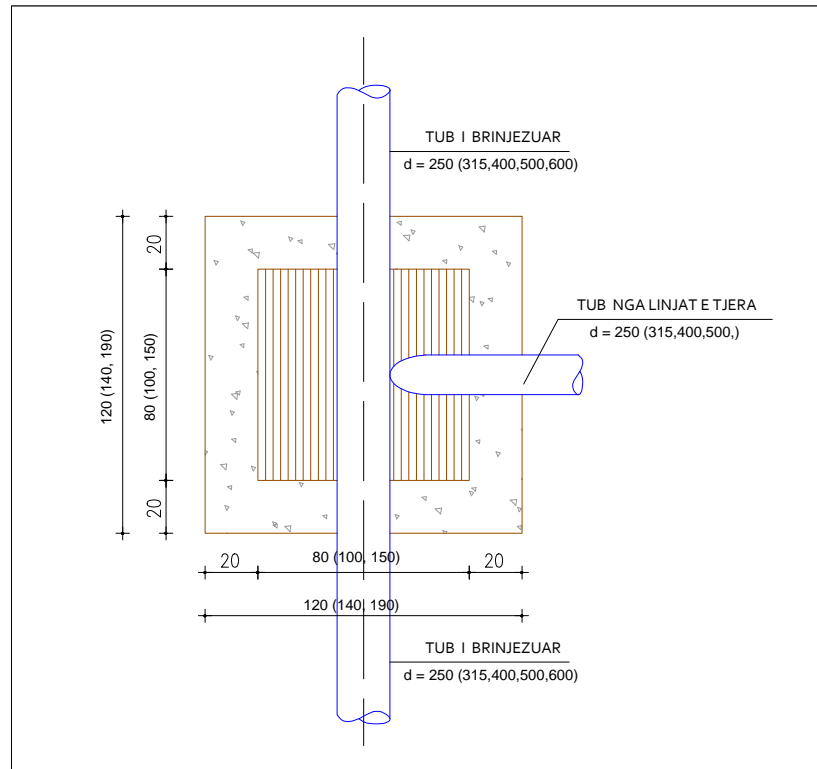

PUSETA TIP E KUZ

SH 1 : 25

PRERJA GJATESORE E Pusetes

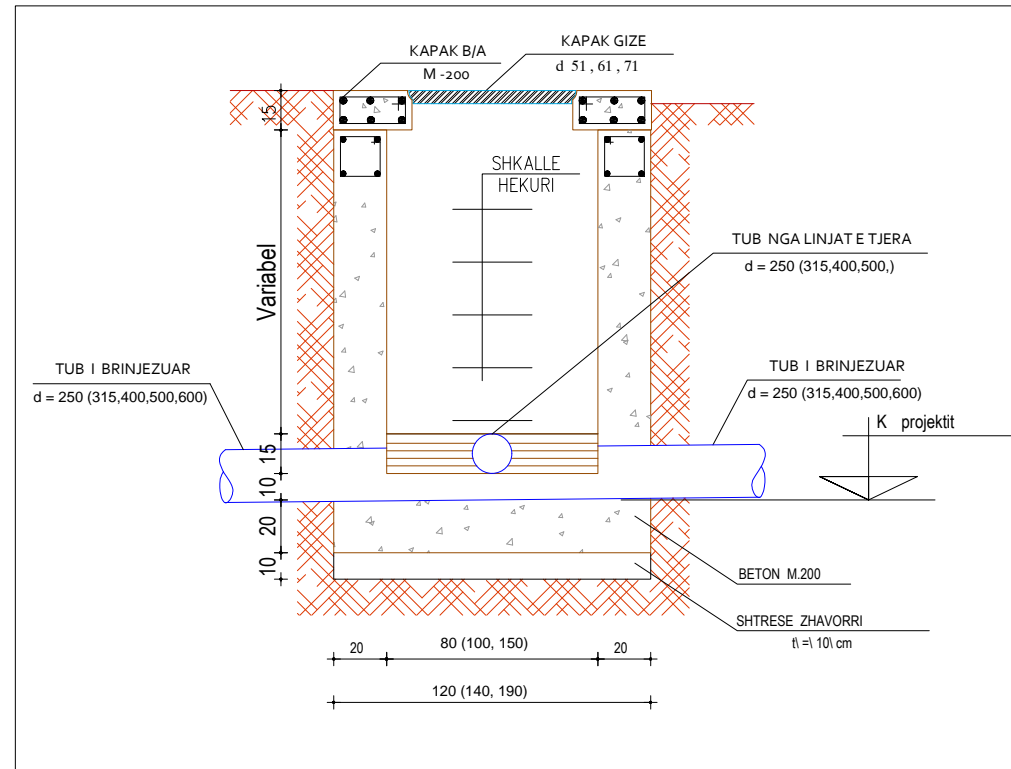

PRERJA TERTHORE E Pusetes

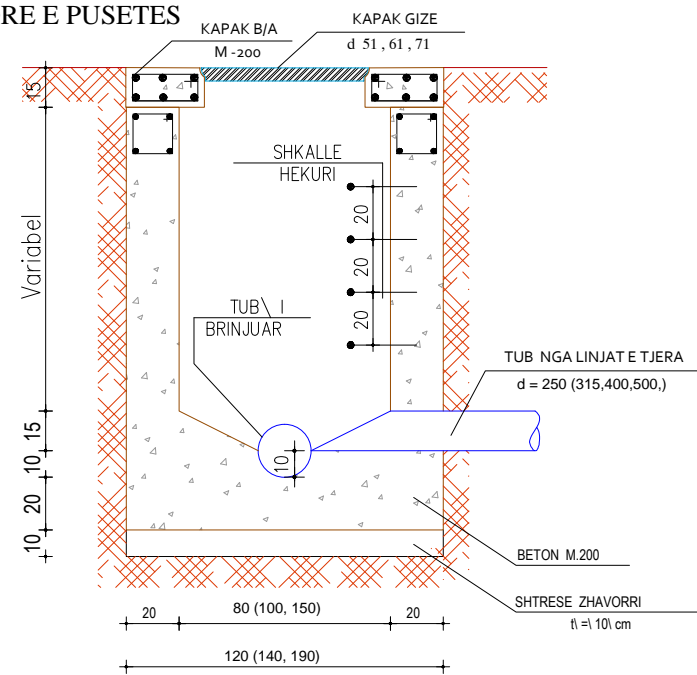

PAMJE NGA SIPER E Pusetes

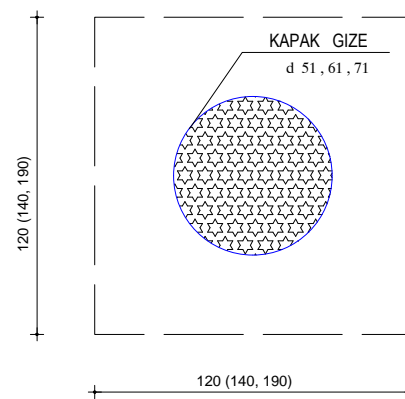

SHENIM:

PRERJA E TUBIT BRENDA Pusetes  
TE BEHET MBAS NDERTIMIT TE Pusetes

E BRENDESHME JANE 100 x 100 cm

PER Pusetat ME LARTESI > 200 cm PERMASAT  
E BRENDESHME JANE 150 x 150 cm

PLANIMETRIA E PORTALIT

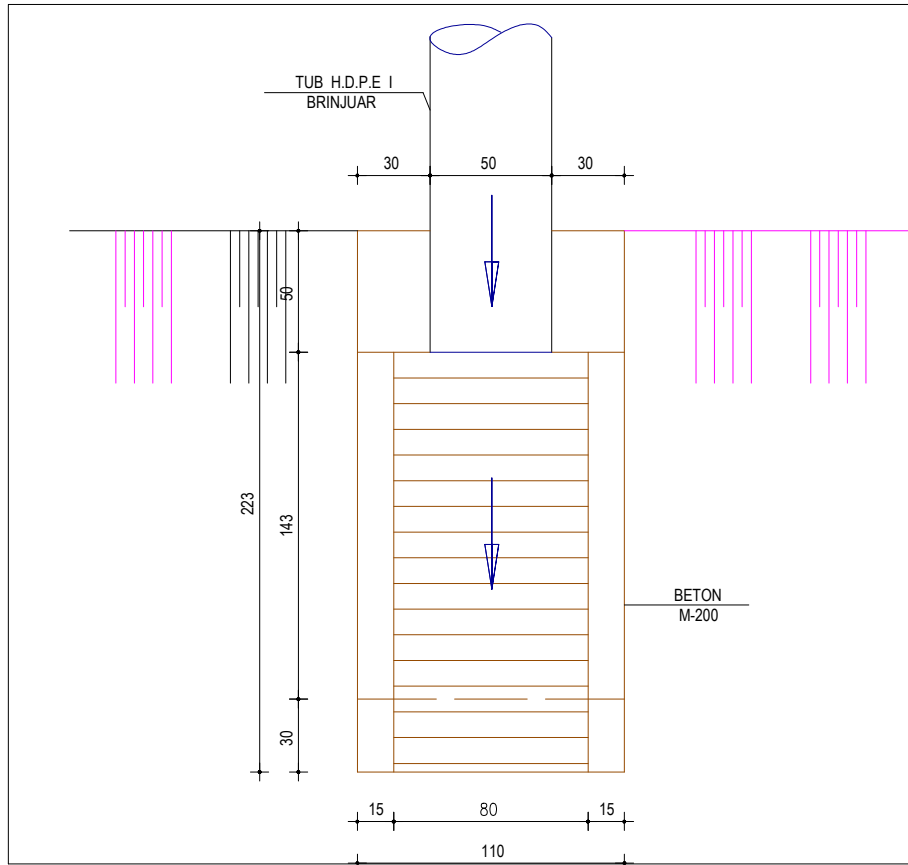

PUSETA TIP E KUZ  
SH 1 : 25

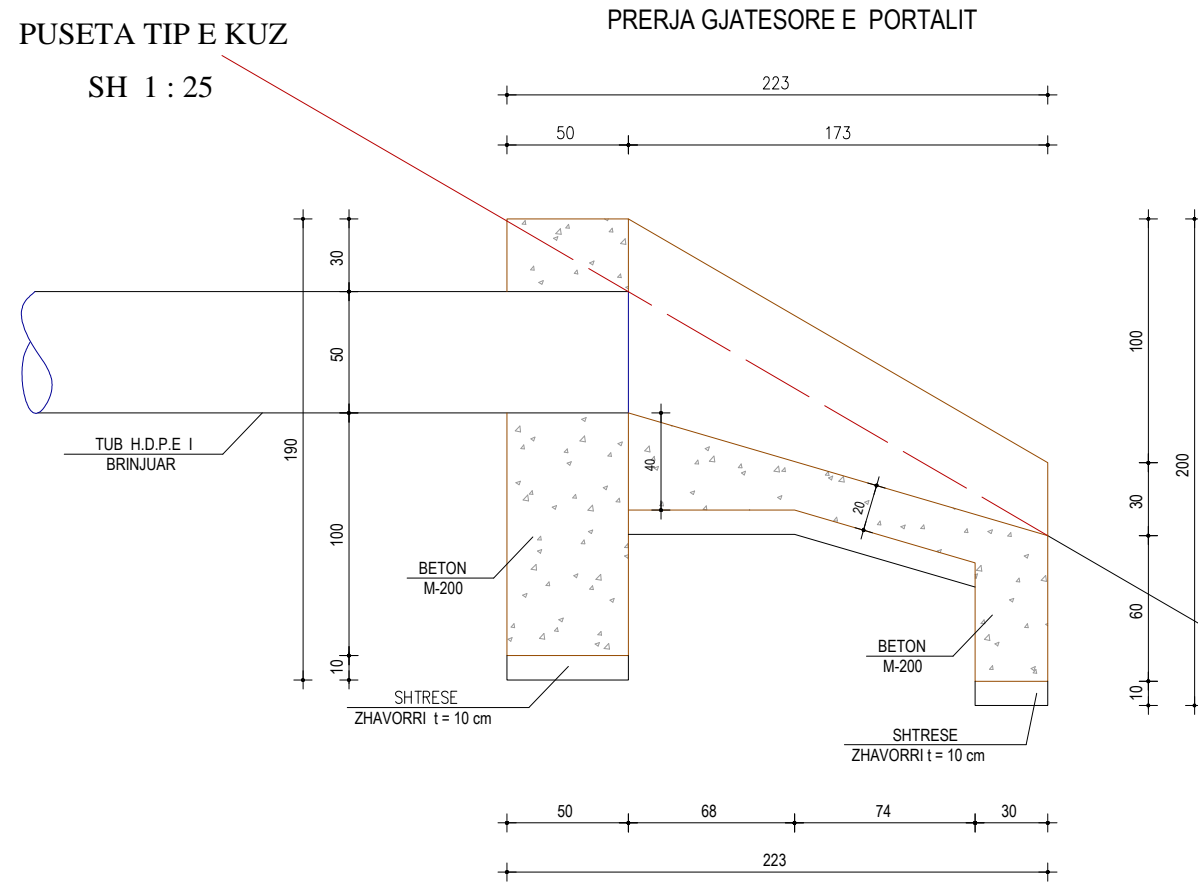

PRERJA TERTHORE E PORTALIT

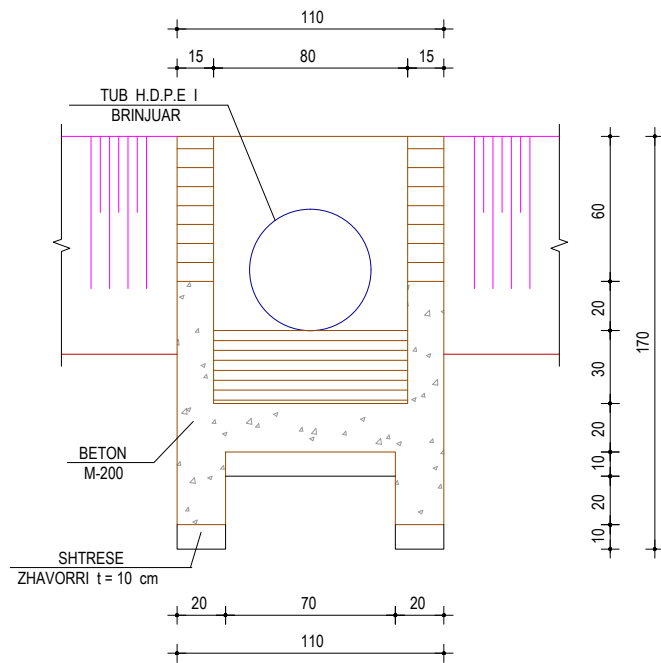

REPUBLIKA E SHQIPERISE

BASHKIA PEQIN

KLIENT: BASHKIA PEQIN

PROJEKT ZBATIMI: RINDERTIMI I SHKOLLES 9-VJECARE SHEZE

EMERTIMI I FLETES:  
GROPA SEPTIKE

APROVIMI I KLIENTIT:

PROJEKTUAR:

"A.SH. ENGINEERING" sh.pk

VENDNDODHJA E OBJEKTIT: PEQIN