

Mirato:

KRYETARE MAJLINDA BUFI



Porosjtes:

BASHKIA ROSKOVEC



PROJEKT-ZBATIMI

"NOVATECH STUDIO "SHPK



ING. EMIL NOVA

Grupi projektimit:

ING. ENKEL	1980
ING. ENKEL	1980
ING. ENKEL	1980
ING. ENKEL	1980
ING. ENKEL	1980
ING. ENKEL	1980
ING. ENKEL	1980
ING. ENKEL	1980
ING. ENKEL	1980
ING. ENKEL	1980



Titulli i Projektit

**REHABILITIMI URBAN I NJE PJESE TE BLOKUT NR.3 NE QENDER TE QYTETIT ROSKOVEC
(FAZA NR 1)**

3- SISTEMIMI I KANALIT KULLUES DHE NDERTIMI I RRUGES LIDHESHE MBI TE

PROJEKTI I ZBATIMIT

POZICIONIMI I KOLEKTORIT UJEMJLEDHES NE LIDHJE ME INFRASTUKTUREN RRUGORE SHK:1:1000

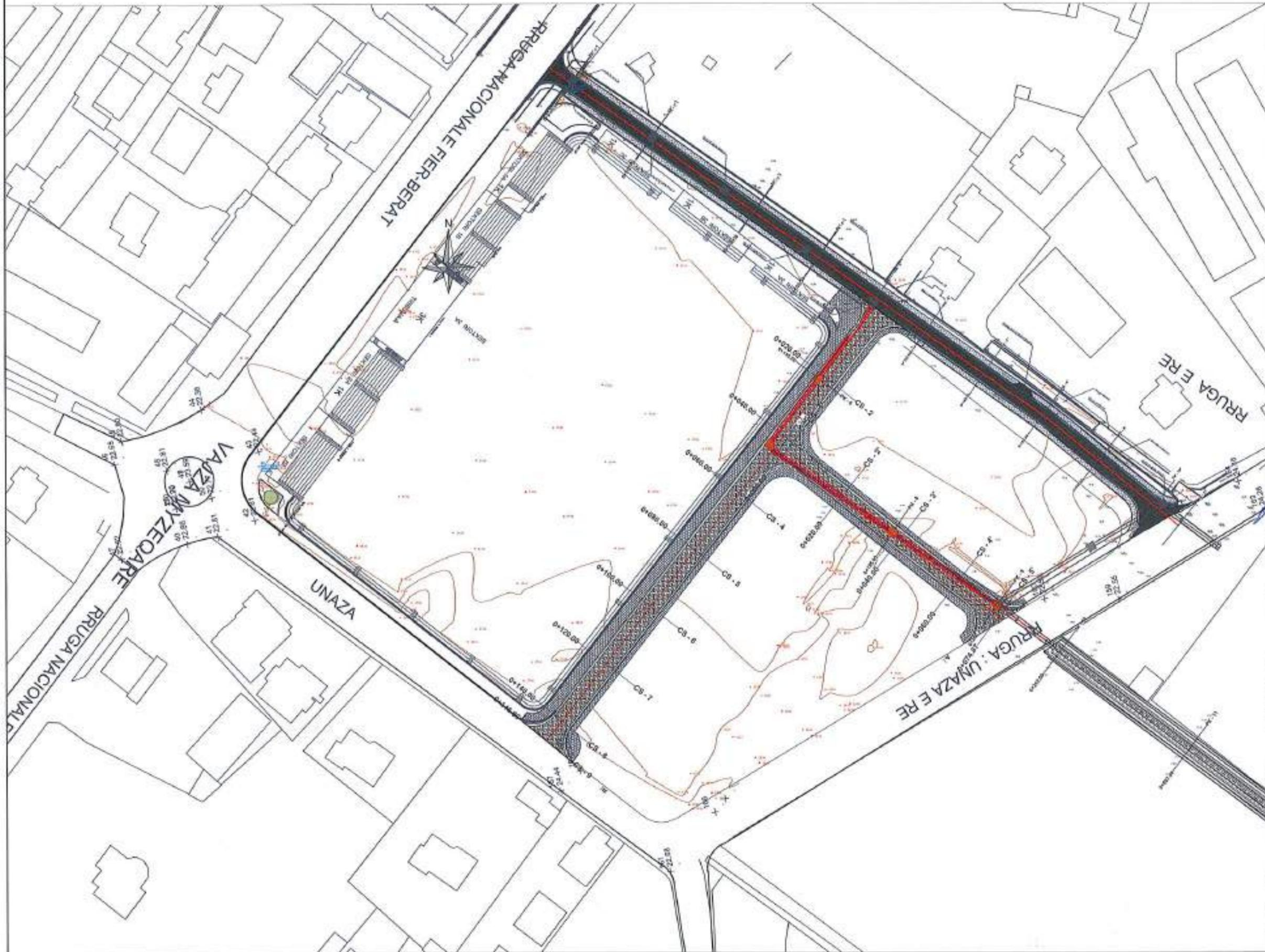

LEGJENDE

- Objekte dhe ndarje ekzistuese
- kolektori tombino D=1000mm
- Puseta kontrolli te kolektorit
- Asfaltim Rruge
- Trotuar me pllaka 6cm
- Aksi i rruges
- Progresivat sipas aksit
- Rilevimi topografik (kuotat)
- Rilevimi topografik (izoipset)

Posahtësia
 Titulli i Projektit
BASHKIA ROSKOVEC
REHABILITIMI URBAN I NJE PJESE
TE BLOKUT NR.3 NE QENDER TE
QYTETIT ROSKOVEC (FAZA NR 1)

Faqe **PROJEKT IDE**
 Vela
 Autor **"NOVATECH STUDIO" SHPK**

ING. KNIL MOVA

Grupi projektues

Kopitulli
PROJEKTI ARKITEKTONIK
 Virallia dhe shprehja
POZICIONIMI I KOLEKTORIT
UJEMJLEDHES NE LIDHJE ME
INFRASTUKTUREN RRUGORE
 Realizuar **QESHOR 2022** Shkalla **1:1000**
 Emri i Planit
A.2 - 02

GENPLAN INFRASTRUKTURA RRUGORE SHK:1:1000

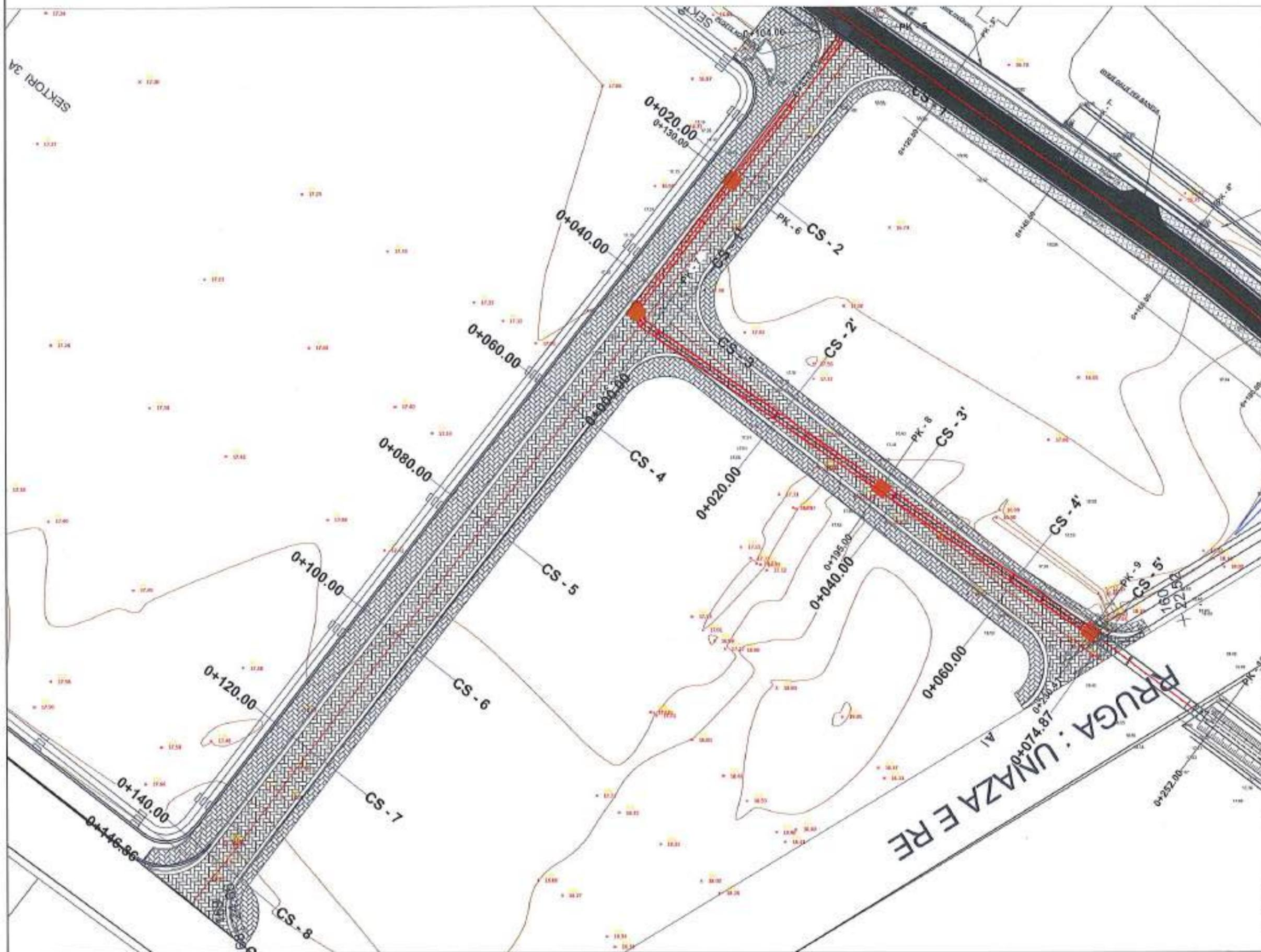

LEGJENDE

- Objekte dhe ndarje ekzistuese
- Shtylla elektrike
- Aksi i rruges
- Asfaltim Rrugë
- Trotuar me pllaka 6cm
- Progresivët sipas aksit
- Rilevimi topografik (kuotal)
- Rilevimi topografik (izolinset)

Posedhësi
 BASHKIA DUKAGJIN
 Titulli i Projektit
 RERABILITIMI URBAN I NJE PJESE
 TE BLOKUT NR.3 NE QENDER TE
 QYTETIT DUKAGJIN (FAZA NR 1)
 Forma
 PROJEKTI IDE
 Vendi
 Autor
 "NOVATECH STUDIO" SHPK
 ING. KNIL MOVA
 Dregimi projektues
 NOVATECH STUDIO SHPK
 Projekti Arkitektonik
 Genplan Infrastruktura Rrugore
 Realizuar
 QERSHOR 2022
 Shkalla
 1:500
 Emblimi i Planit
A.2 - 03

PLANIMETRIA E RRUGES AKSI 1 SHK:1:250

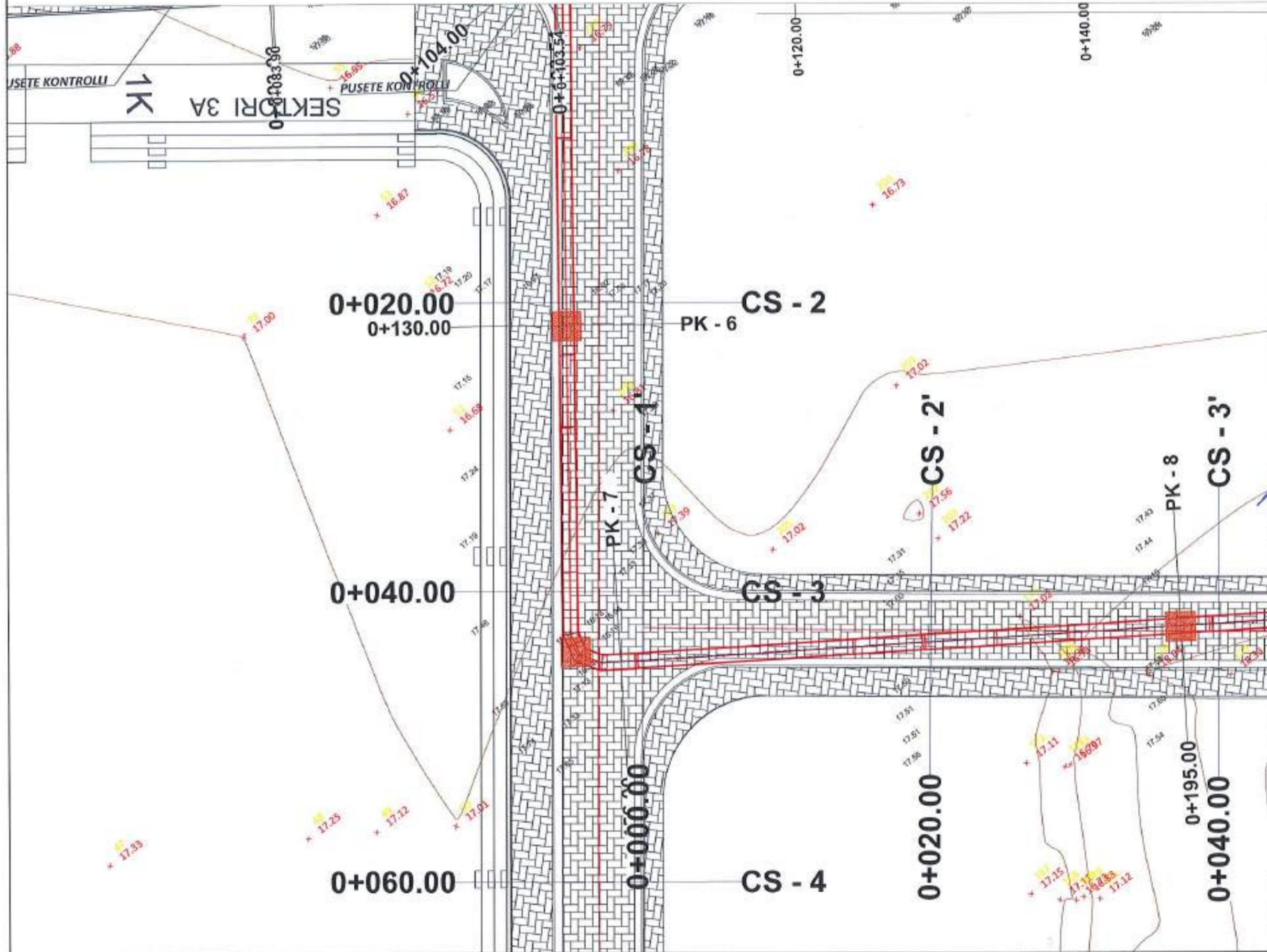

LEGJENDE

- Objekte dhe ndarje ekzistuese
- Shtylla elektrike
- Aksi i rruges
- Asfaltim Rruga
- Trotuar me pllaka 6cm
- Progresivat sipas aksit
- Rilevimi topografik (kuotat)
- Rilevimi topografik (izoipset)

 BASHKIA ROSKOVEC	
Titulli i Projektit REHABILITIMI URBAN I NJE PJESE TE BLOKUT NR.3 NE QENDER TE QYTETIT ROSKOVEC (FAZA NR 1)	
Faza PROJEKTI IDE	
Vendi "NOVATECH STUDIO" SHPK  ING. EMIL NOVA	
Autori "NOVATECH STUDIO" SHPK 	
Vendi Projekti Arkitektonik	
Titulli i Vizatimit PLANIMETRIA E RRUGES AKSI 01	
Realizuar QERROROK 2022	Shkalla 1:250
Kategoria i Dizajni A.2 - 04	

PLANIMETRIA E RRUGES AKSI 1 SHK:1:250

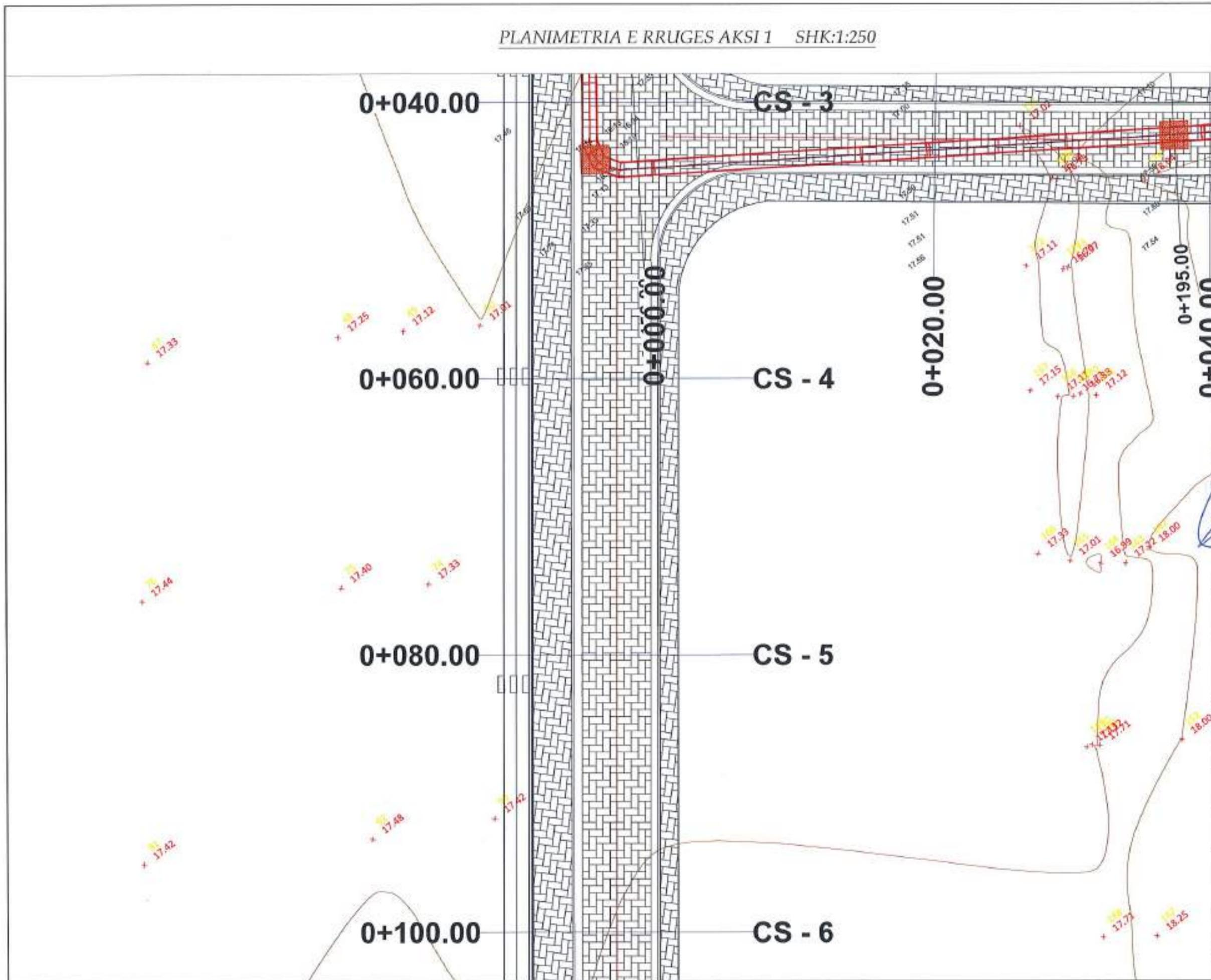

LEGJENDE

- Objekte dhe ndarje ekzistuese
- Shtylla elektrike
- Aksi i rruges
- Asfaltim Rruga
- Trocur me pllaka 6cm
- Progresivat sipas aksit
- Rilevimi topografik (kuota)
- Rilevimi topografik (izoipset)

Parashite

BASHKIA ROSKOVEC

Titulli i Projektit

REHABILITIMI URBAN I NJE PJESE
TE BLOKUT NR.3 NE QENDER TE
QYTETIT ROSKOVEC (FAZA NR 1)

Faza PROJEKTI IDE

Vula

Autor "NOVATECH STUDIO" SHPK

ING. EMIL NOVA

Grupi projektues

NOVATECH STUDIO SHPK

Vula

Kapitulli

PROJEKTI ARKITEKTONIK

Titulli i Viteutit

PLANIMETRIA E RRUGES AKSI 01

Rektori QERSHOR 2022 **Shkalla** 1:250

Redaktori i Planit

A.2 - 05

PLANIMETRIA E RRUGES AKSI 1 SHK:1:250

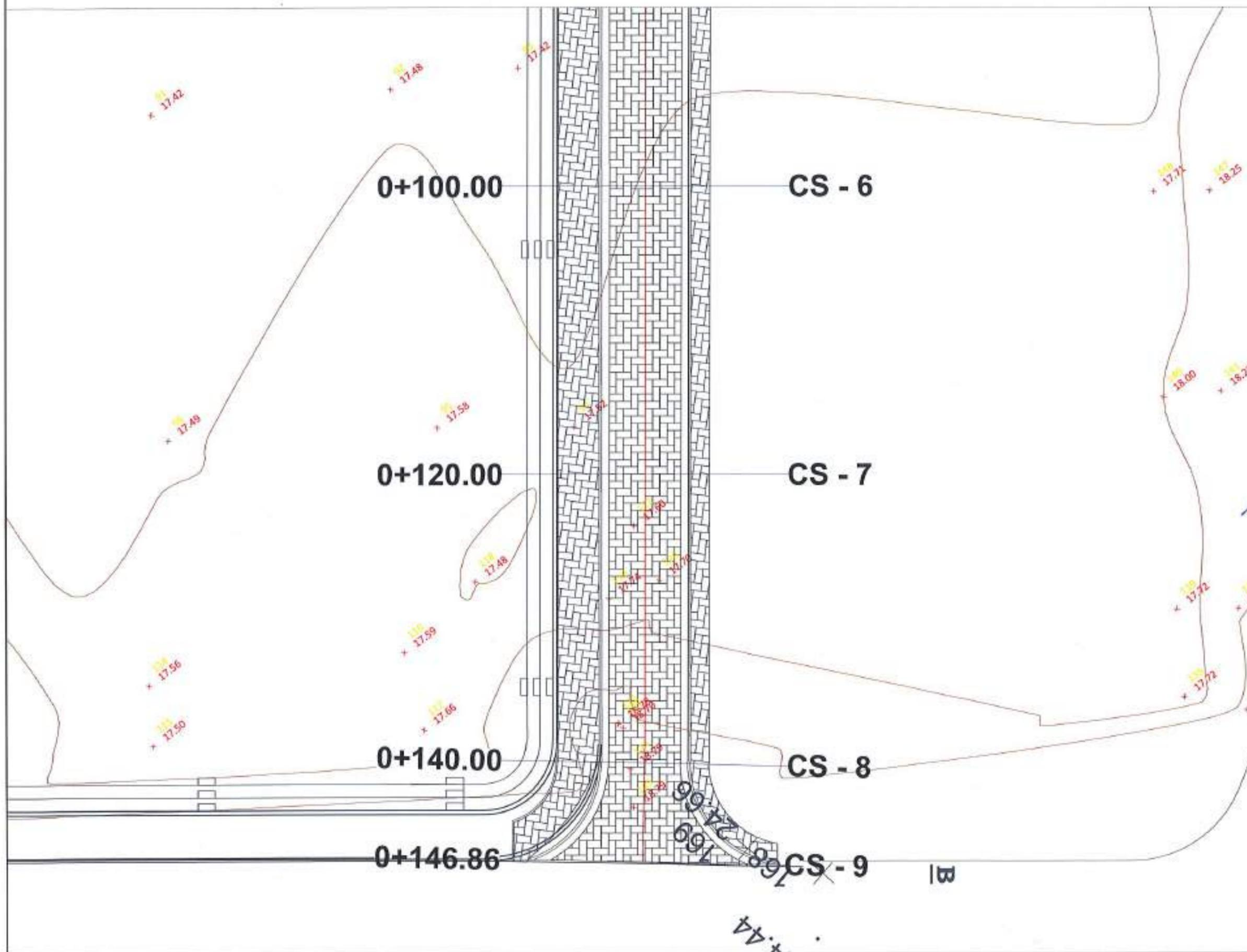

LEGJENDE

- Objekte dhe ndrje ekzistuese
- Shtylla elektrike
- Aksi i rruges
- Asfaltim Rruga
- Troçitur me pllaka 6cm
- Progresivat sipas aksit
- Rilevimi topografik (kuotat)
- Rilevimi topografik (izoipset)

Parashikim

BASHKIA ROSKOVEC

Titulli i Projektit

REHABILITIMI URBAN I NJE PJESE
TE BLOKUT NR.3 NE QENDER TE
QYTETIT ROSKOVEC (PAGA NR 1)

Faza

PROJERT IDE

Vula

Autor

"NOVATECH STUDIO" SHPK

ING. KHEL NOVA

Grupi projektues

NOVATECH STUDIO SHPK	NOVATECH STUDIO SHPK	NOVATECH STUDIO SHPK	NOVATECH STUDIO SHPK
ING. KHEL NOVA	ING. KHEL NOVA	ING. KHEL NOVA	ING. KHEL NOVA

Vula

Kapitulli

PROJEKTI ARKITEKTONIK

Titulli i Vizimit

PLANIMETRIA E RRUGES AKSI 01

Revizimi

QERSHOR 2022

Shkala

1:250

Emblimi i Fletës

A.2 - 06

PROFILI GJATESOR SHK:1:1000;1:100

PROFILI GJATESOR AKSI 01

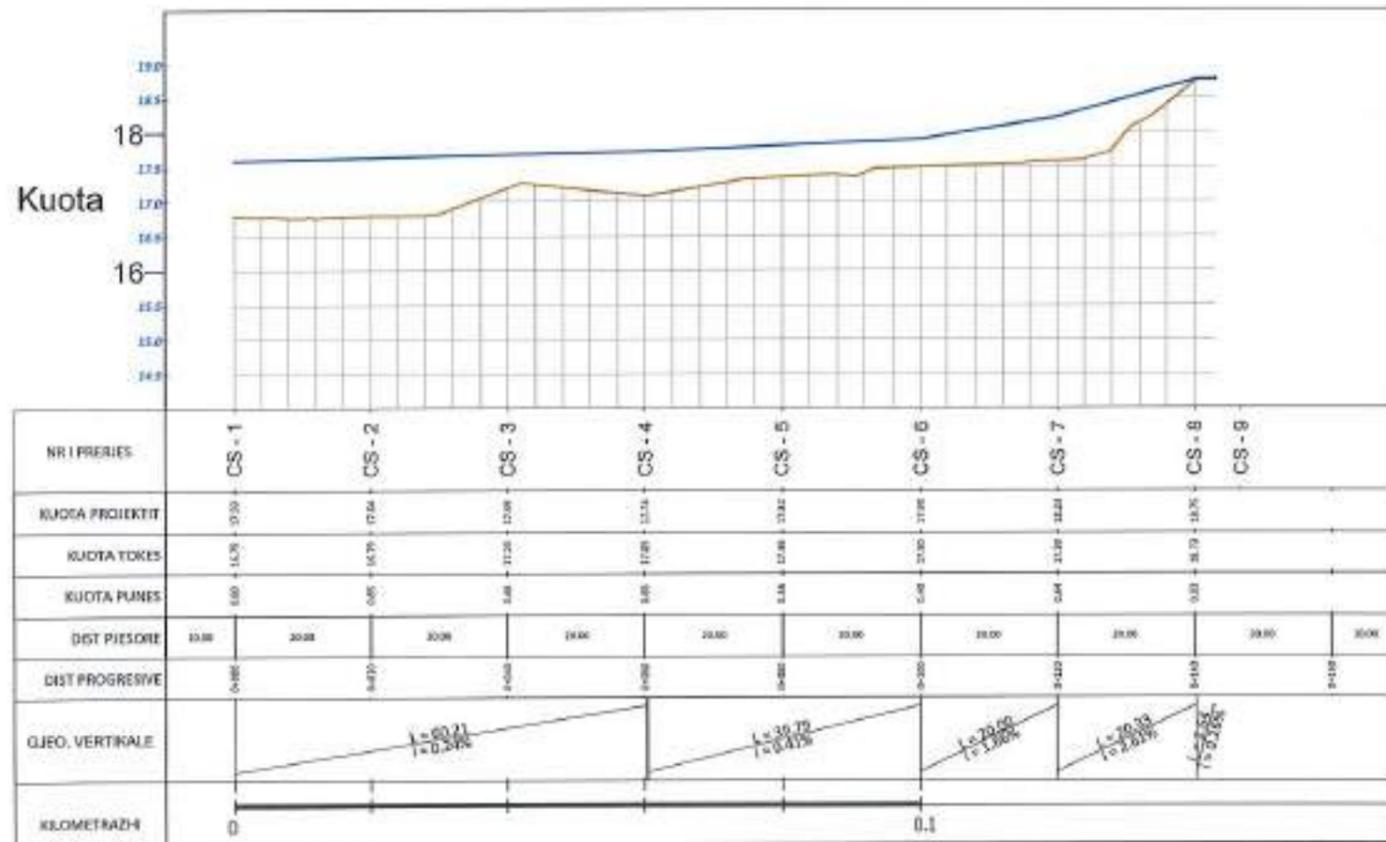

PROFILI GJATESOR AKSI 02

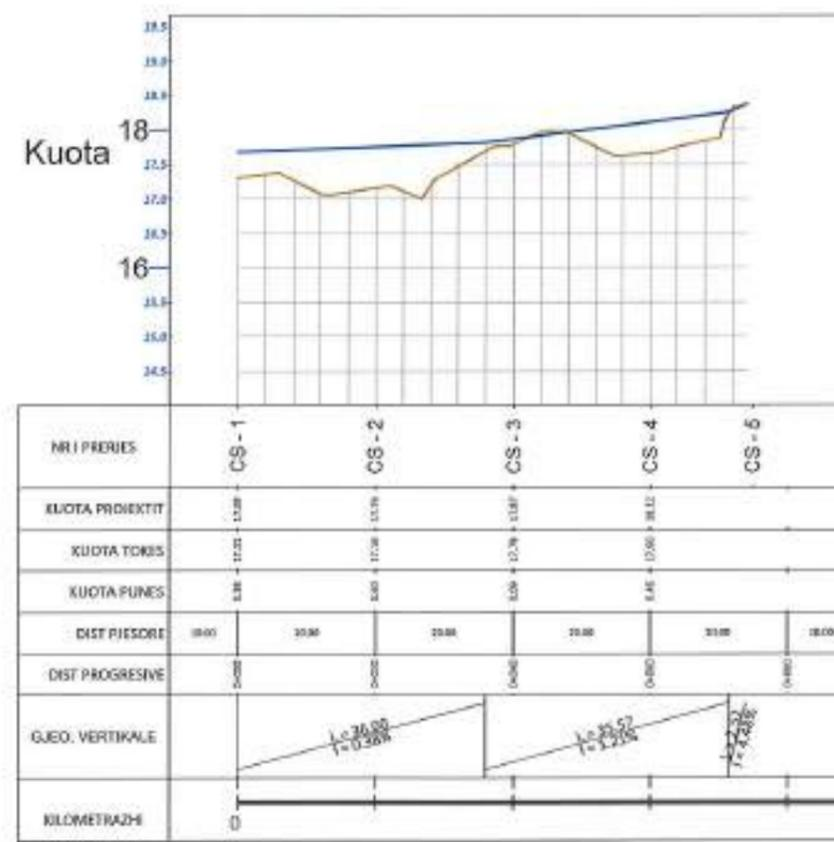

Bashkia ROSKOVEC

 Titull i Projektit

 REHABILITIMI URBAN I NJE PJESE

 TE BLOKUT NR.3 NE QENDER TE

 QYTETIT ROSKOVEC (FAZA NR 1)

Faza **PROJEKT IDE**

 Vula

Autor **"NOVATECH STUDIO" SHPK**

 ING. EMIL NOVA

Grupi projektant

 NOVATECH STUDIO SHPK

 Vula

Emri i Projektit

PROJEKTI ARKITEKTONIK

 Titull i Vëllimit

PROFILI GJATESOR

 Skallor

 QERSHOR 2022

 Skallë 1:1000

 1:100

A.2 - 08

PROFILA TIP SHK:1:40

PROFIL TIP 1 aksi 01
pg0+000-pg0+146.4m
(CS1-CS9)

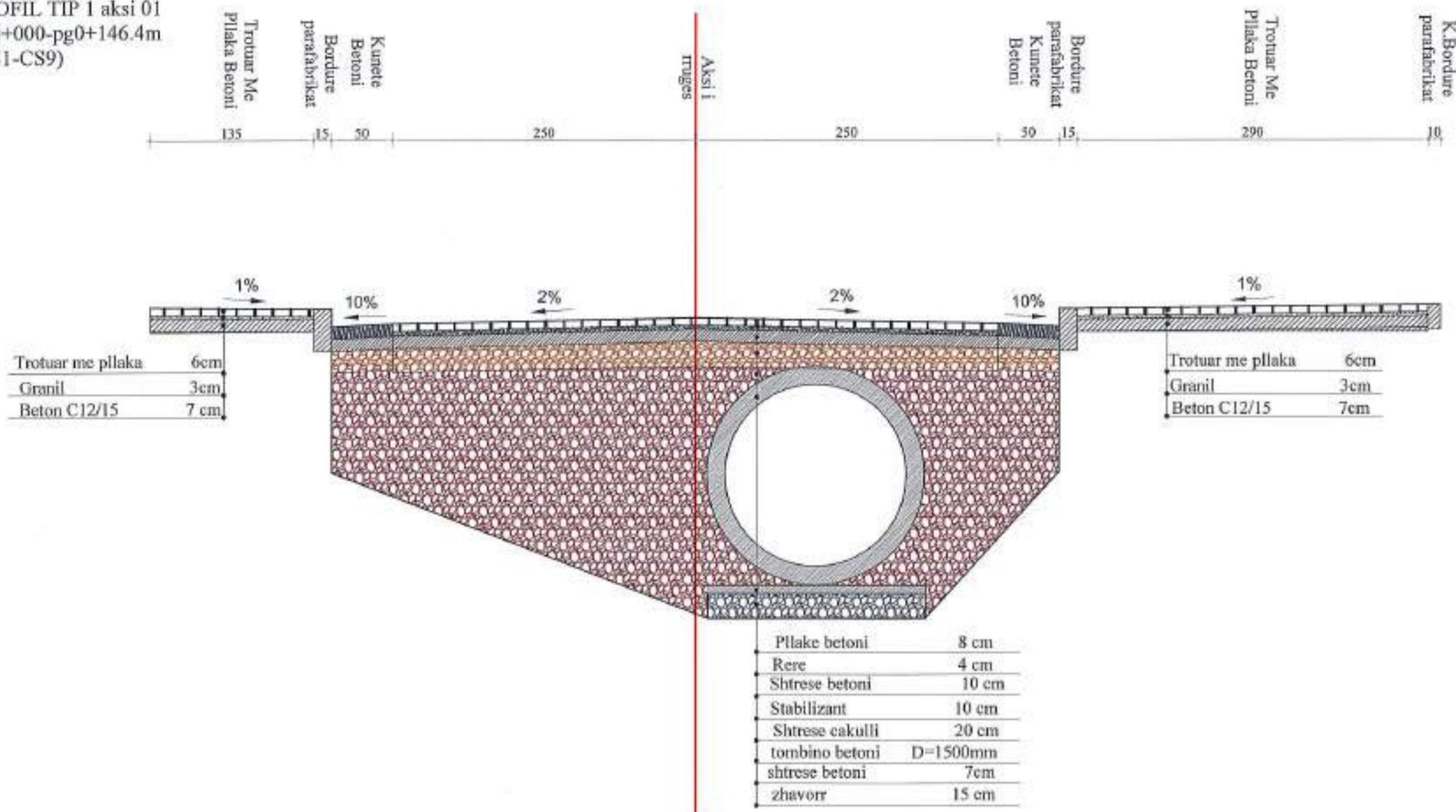

Poselbë
KASHKIA ROSKOVEC
Projekti i Propozimit
REHABILITIMI URBAN I NJE PJESE
TE BLOKUT NR.3 NE QENDER TE
QYTETIT ROSKOVEC (FAZA NR 1)

Faza **PROJEKT IDE**
Vula

Autor **"NOVATECH STUDIO" SHPK**
ING. EMIL NOVA

Grupi projektues
"NOVATECH STUDIO" SHPK
Vula

Kapitulli
PROJEKTI ARKITEKTONIK

Titulli i Vizatimit
PROFILI TIP

Realizuar **QERRSHOR 2023** Shkalla **1:40**

A.2 - 09

PROFILA TIP SHK:1:40

PROFIL TIP 2 aksi 02
pg0+080-pg0+74.87m
(PK1'-PK5')

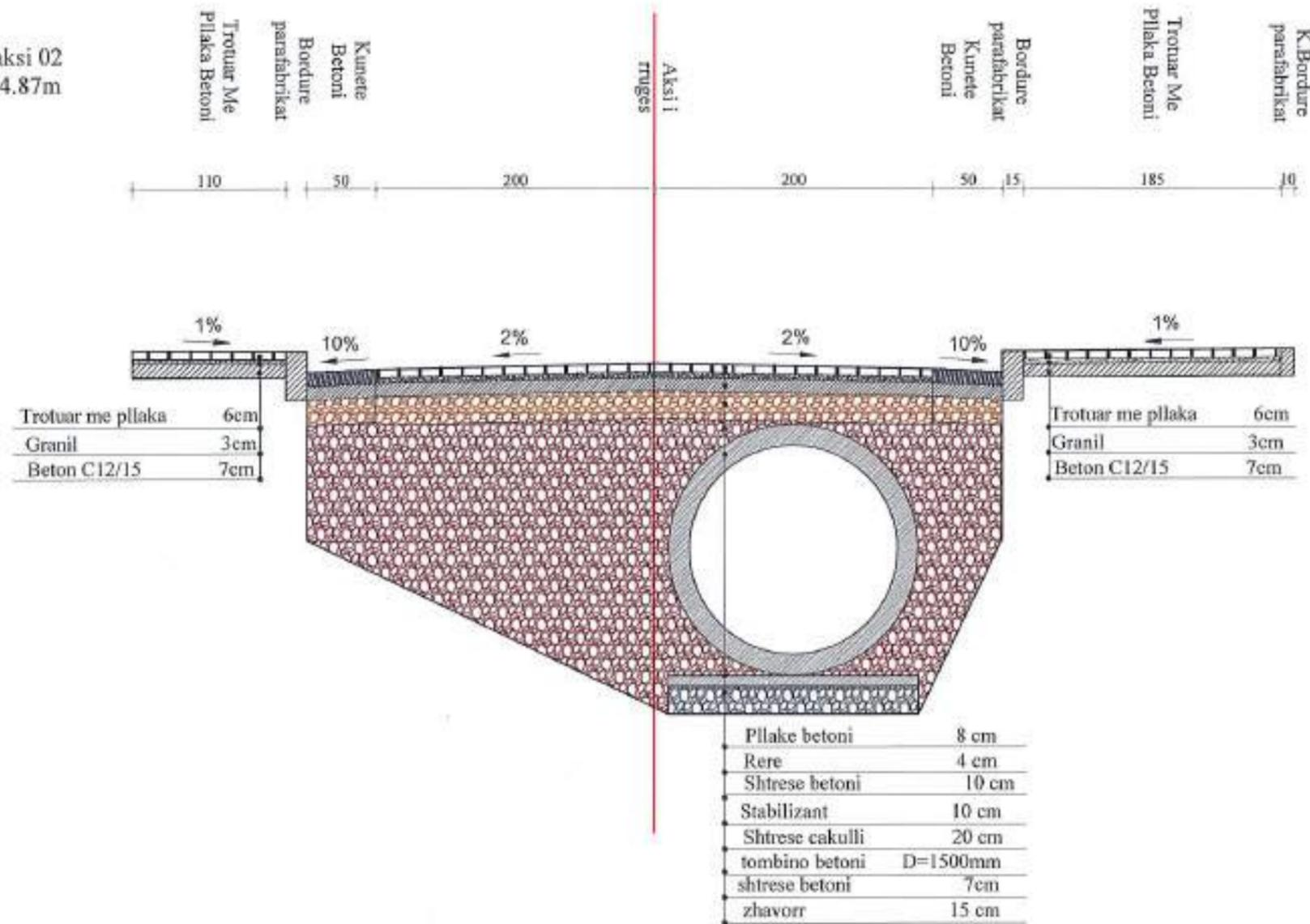

 KASHKIA ROSKOVEC
 Titulli i Posaqesit

REHABILITIMI URBAN I NJE PJESE
 TE BLOKUT NR.3 NE QENDER TE
 QYTETIT ROSKOVEC (FAZA NR 1)

Faza **PROJEKT IDE**
 Vula

Autor **"NOVATECH STUDIO" SHPK**

 ING. EDIL NOVA

Grupi projektues **NOVATECH STUDIO SHPK**

 Vula

Kategoria **PROJEKTI ARKITEKTONIK**

Titulli i Vizatimit **PROFILI TIP K.U.B**

Realizuar **QERROROK 2022** Shkalla **1:40**

Enderi i Dizajnerit **A.2 - 10**

PROFILA TIP SHK:1:40

PROFIL TIP 1 aksi 01 Sistemi
K.U.B. pg0+000-pg0+146.4m
(CS1-CS9)

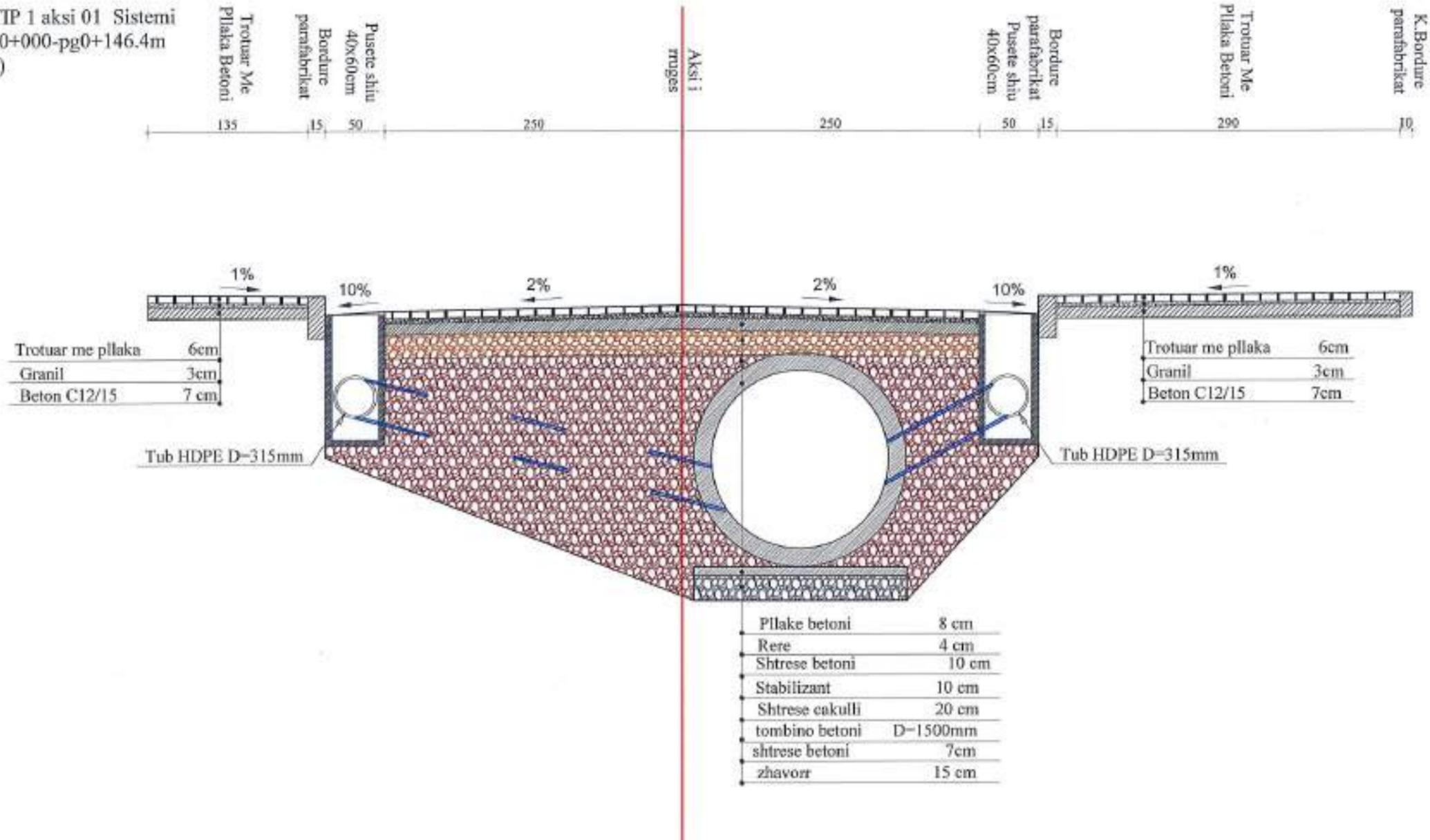

BASHKIA ROSKOVEC
REHABILITIMI URBAN I NJE PJESE
TE BLOKUT NR.3 NE QENDR TE
QYTETIT ROSKOVEC (FAZA NR 1)

Faza **PROJEKT IDE**
Vula

Autor **"NOVATECH STUDIO" SH.PK**
ING. ERIL NOVA



Projekti **PROJEKTI ARKITEKTONIK**

Titulli i Vazhdimt **PROFILI TIP K.U.B**

Realizuar **QERROR 2022** Skala **1:40**

Numri i Planit **A.2 - 10/1**

PROFILA TIP SHK:1:40

PROFIL TIP 2 aksi 02 Sistemi K.U.B.
pg0+080-pg0+74.87m
(PK1'-PK5')

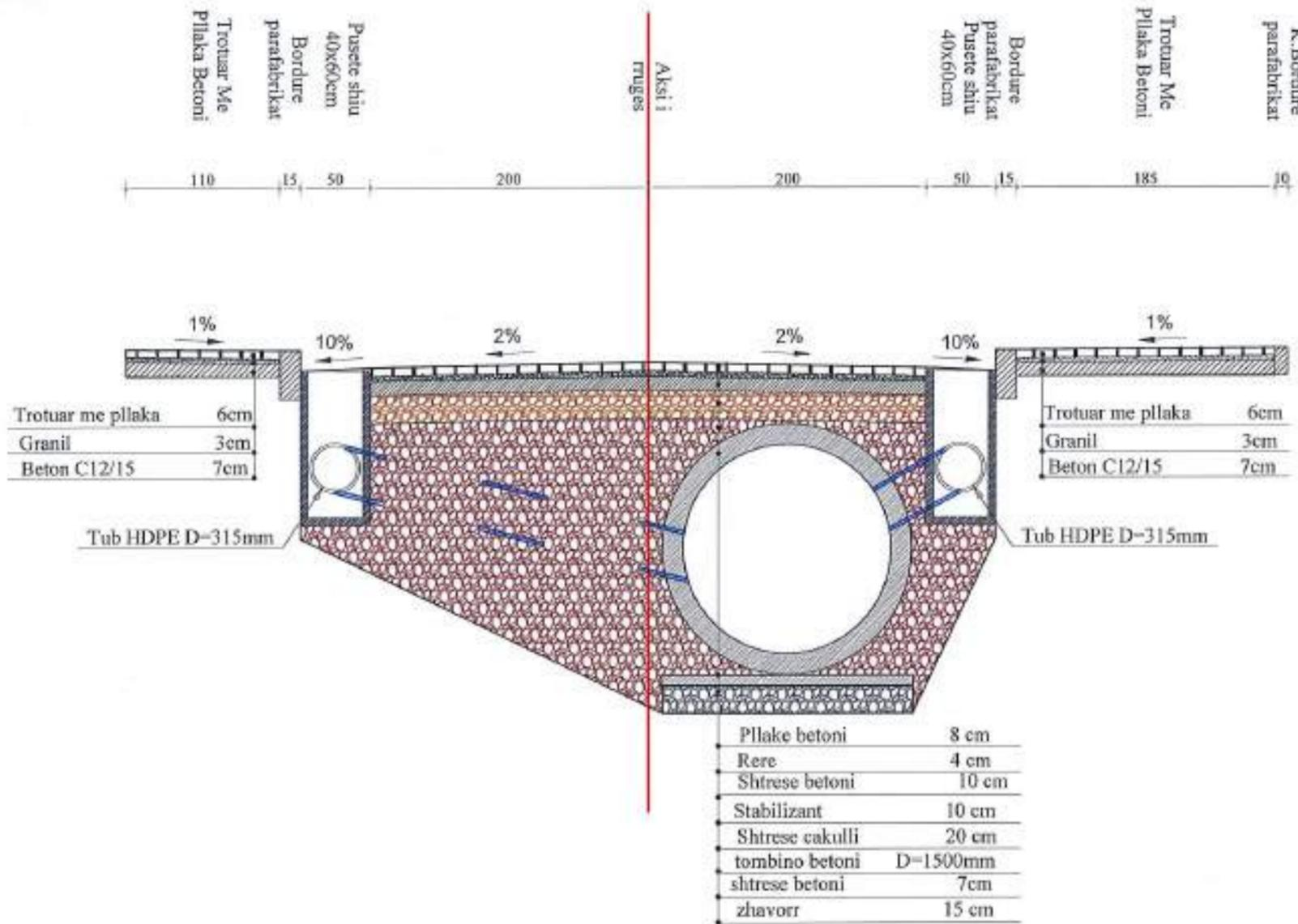

Perdorues
BASHKIA ROSKOVEC
KASHKIA ROSKOVEC

Titulli i Projektit
REHABILITIMI URBAN I NJE PJESE
TE BLOKUT NR.3 NE QENDER TE
QYTETIT ROSKOVEC (FAZA NR 1)

Faza
PROJEKT IDE

Vula

Autor
"NOVATECH STUDIO" SHPK
ING. EMIL NOVA

Grupi projektant:
NOVATECH STUDIO SHPK
PRIME MINISTRI
REPUBLICA E SHQIPERISE
DREKTORI
ING. EMIL NOVA
PROJEKTI ARKITEKTONIK
SHK. 1:40
Vula

Kepitulli

PROJEKTI ARKITEKTONIK

Titulli i Vazhduimit
PROFILI TIP K.U.B

Redaktor
QERSHOR 2022
Shkalla
1:40

Emri i Pjeses
A.2 - 10/2

PLANIMETRIA E KANALIZIMEVE TE UJRAVE TE BARDHA SHK:1:500

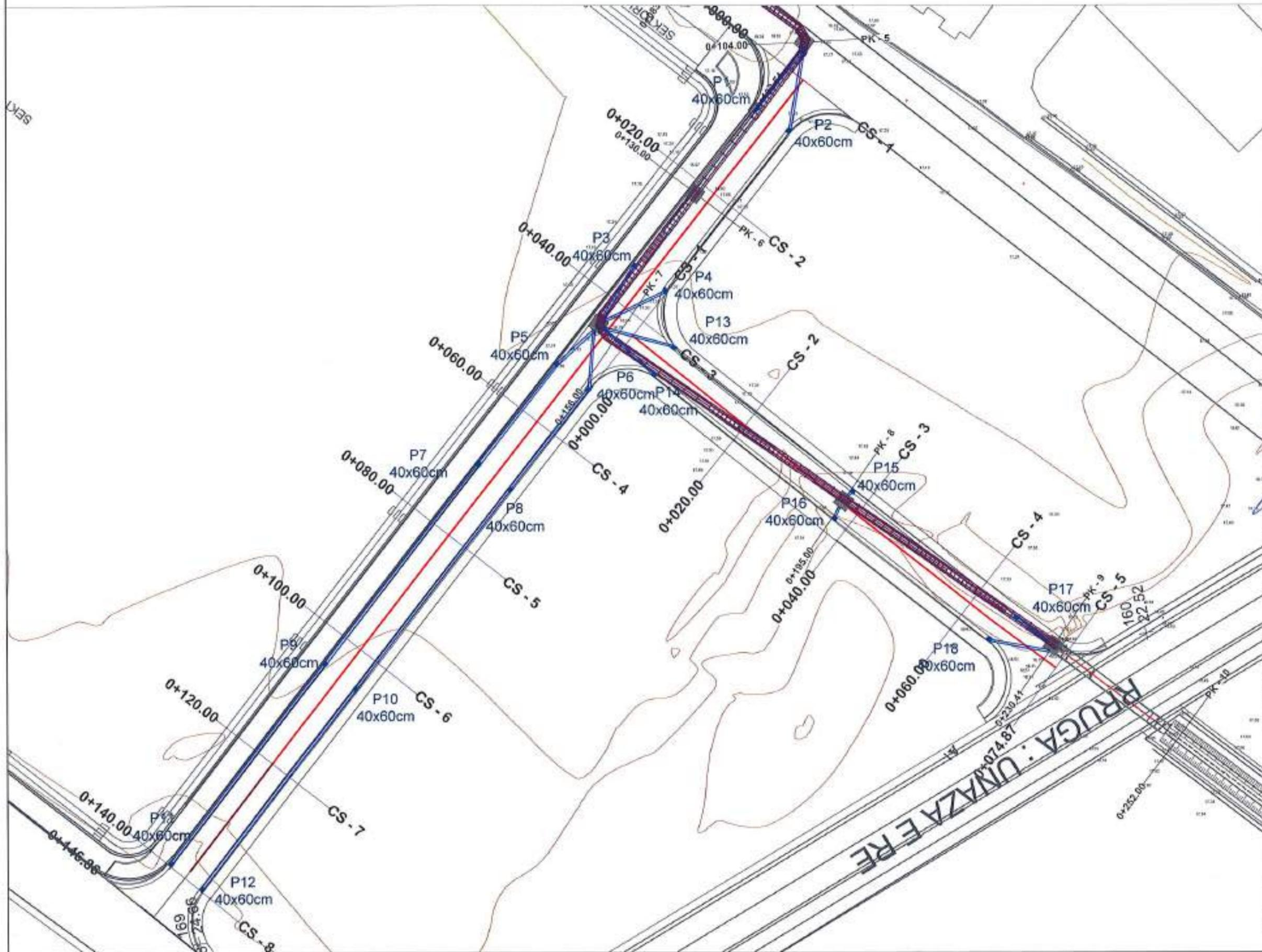

LEGENDE

- Objekte dhe ndarje ekzistuese
- Kolektori D=1000mm
- Aksi i ruges
- Pusete shiu 40x60cm
- Tub HDPE D=315mm
- Pusete kontrolli 1.5x1.5m (kolektori)

KASHKIA ROSKOVEC
 Titull i Projektit
 REHABILITIMI URBAN I NJE PJESE
 TE BLOKUT NR.3 NE QENDER TE
 QYTETIT ROSKOVEC (FAZA NR 1)

Faza **PROJEKT IDE**

Autor **"NOVATECH STUDIO" SHPK**

 ING. EDIL NOVA

Grupi projektimit

ING. EDIL NOVA	Udhëheqës	15/03
ING. EDIL NOVA	Projektues	15/03
ING. EDIL NOVA	Projektues	15/03
ING. EDIL NOVA	Projektues	15/03
ING. EDIL NOVA	Projektues	15/03
ING. EDIL NOVA	Projektues	15/03
ING. EDIL NOVA	Projektues	15/03
ING. EDIL NOVA	Projektues	15/03
ING. EDIL NOVA	Projektues	15/03
ING. EDIL NOVA	Projektues	15/03

Grupi projektimit

PROJEKTI ARKITEKTONIK

Titull i Vizatimit
PLANIMETRIA K.U.B.

Realizuar **QERSHOR 2023** Shkalla **1:500**

PLANIMETRIA E KANALIZIMEVE TE UJRAVE TE BARDHA SHK:1:250

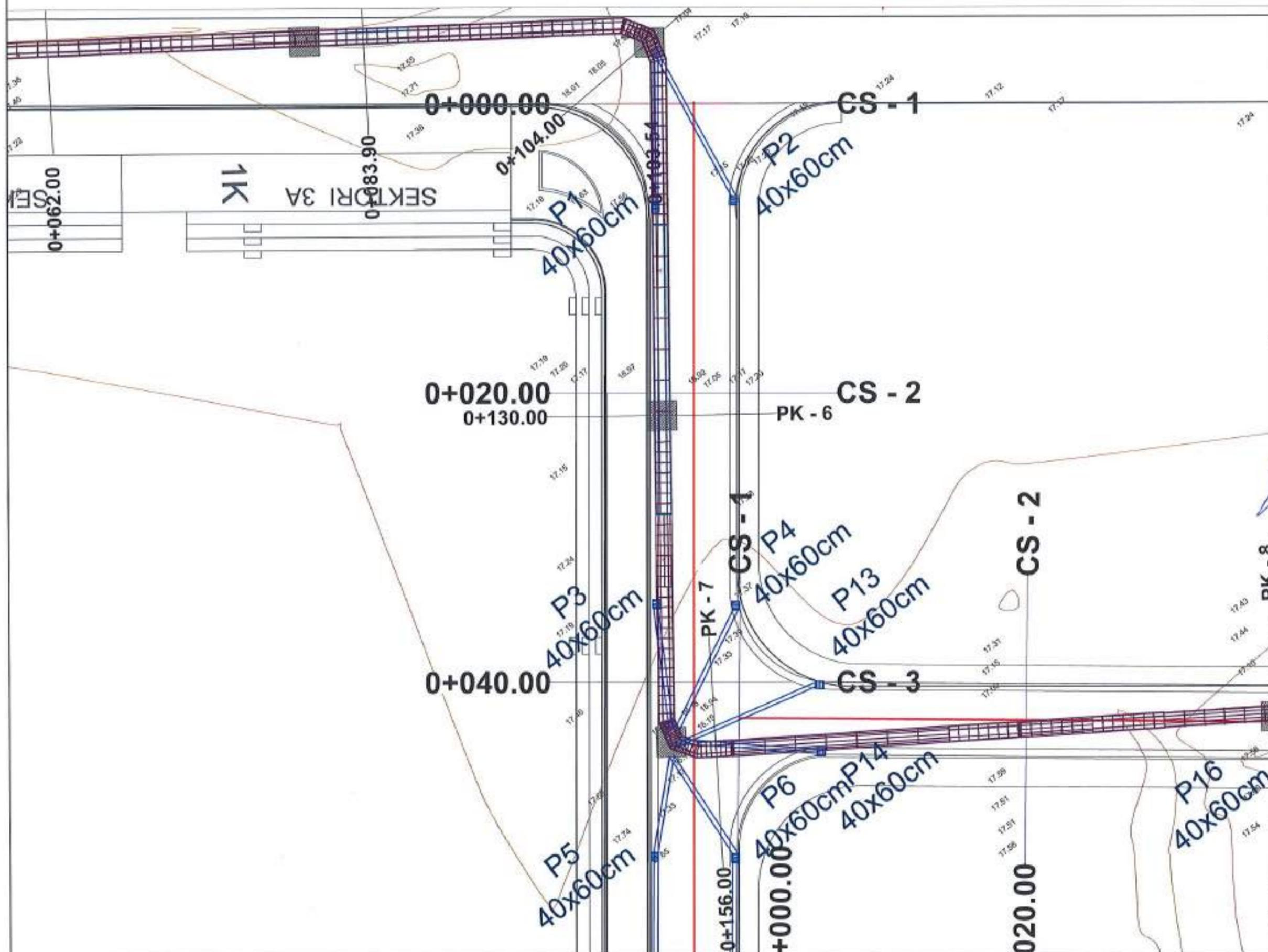

LEGJENDE

- Objekte dhe ndarje ekzistuese
- Kolektori D=1000mm
- Aksi i rruges
- Pusete shiu 40x60cm
- Tub HDPE D=315mm
- Pusete kontrolli 1.5x1.5m (kolektori)

Posestesi

 BASHKIA ROSKOVEC

Titulli i Projektit
 REHABILITIMI URBAN I NJE PJESE
 TE BLOKUT NR.3 NE QENDER TE
 QYTIMIT ROSKOVEC (PAGA NR 1)

Fees
 PROJEKT IDE

Vlota
 PK - 8

Autori
 "NOVATECH STUDIO" SHPK
 ING. EMIL NOVA

Grupi përbërës

 Projekti i Vizatimit

Kapiteulli
 PROJEKTI ARKITEKTONIK

Titulli i Vizatimit
 PLANIMETRIA K.U.B.
 Realizuar
 QERSHOR 2022
 Skala
 1:250
 Emri i Vizatuesit
A.2 - 12

PLANIMETRIA E KANALIZIMEVE TE UJRAVE TE BARDHA SHK:1:250

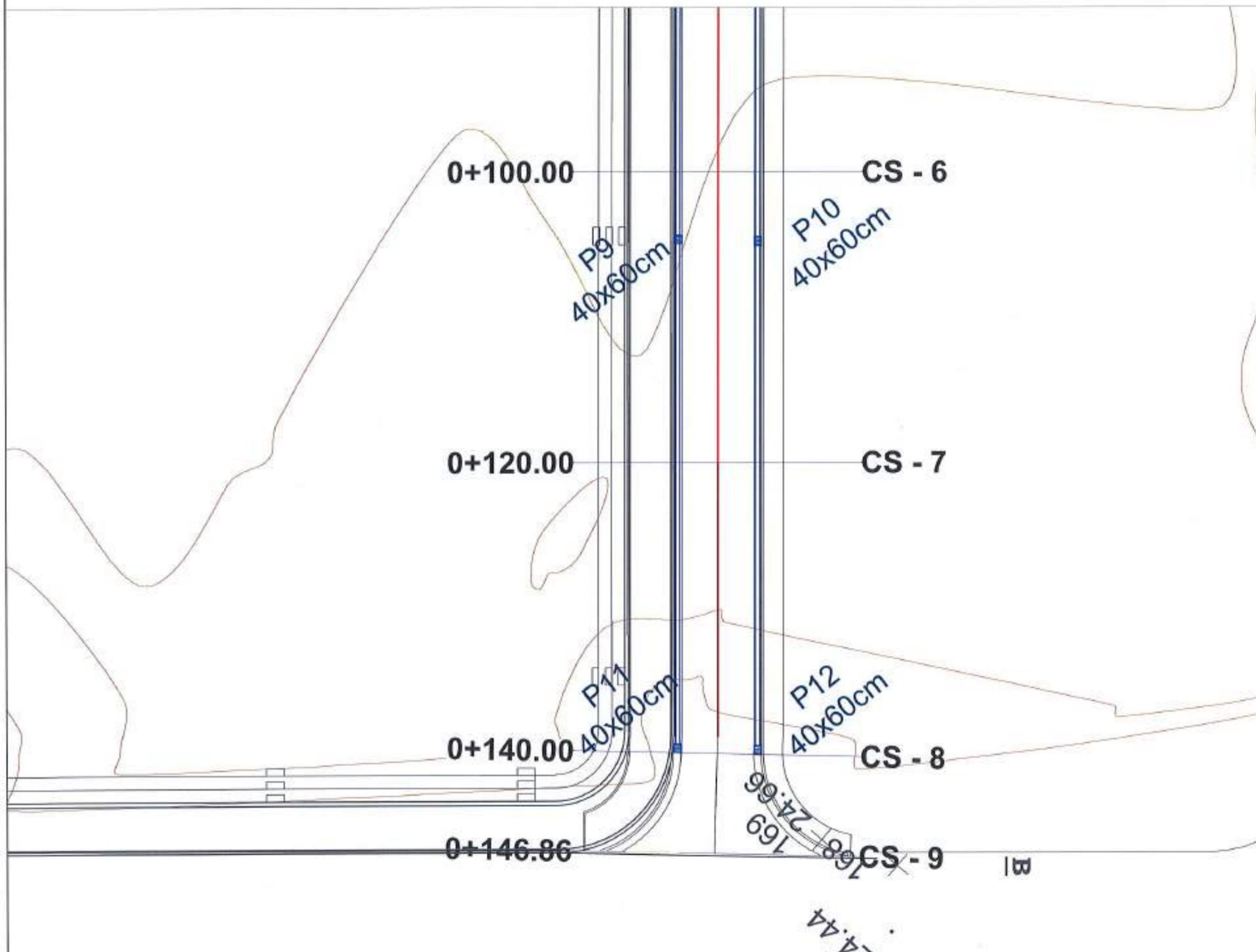

LEGJENDE

- Objekte dhe ndarje ekzistuese
- Kolektori D=1000mm
- Aksi i rruges
- Pusete shiu 40x60cm
- Tub HDPE D=315mm
- Pusete kontrolli 1.5x1.5m (kolektori)



REHABILITIMI URBAN I NJE PJESE
TE BLOKUT NR.3 NE QENDER TE
QYTETIT ROSKOVEC (FAZA NR 1)

Faza: PROJEKT IDE

Autor: "NOVATECH STUDIO" SHPK
ING. ENEL NOVA



PROJEKTI ARKITEKTONIK

PLANIMETRIA K.U.B.

QERSHOR 2022 Shkalla 1:250

A.2 - 14

PLANIMETRIA E KANALIZIMEVE TE UJRAVE TE BARDHA SHK:1:250

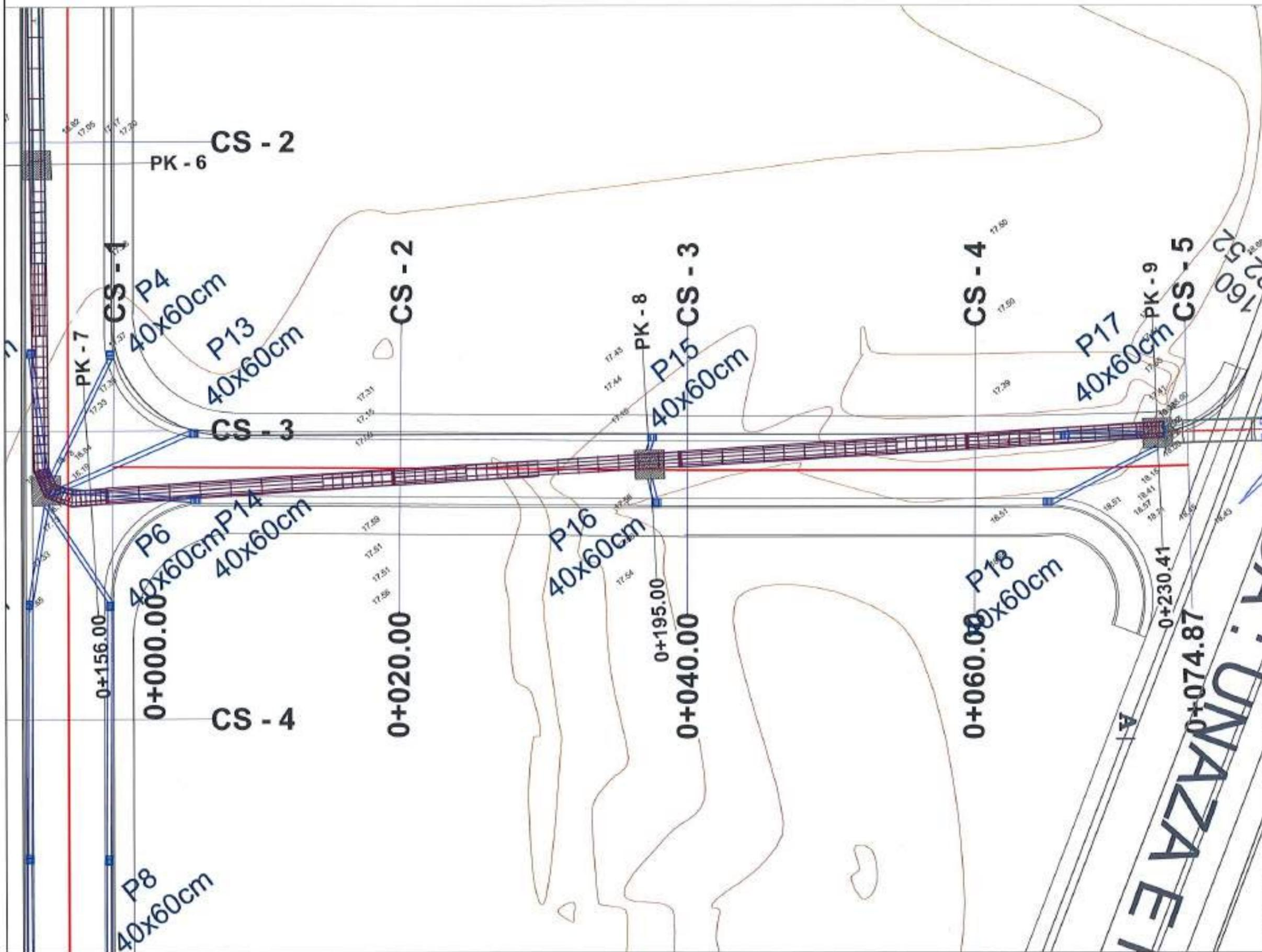

LEGJENDE

- Objekte dhe ndarje ekzistuese
- Kolektori D=1000mm
- Aksi i rruges
- Pusete shiu 40x60cm
- Tub HDPE D=315mm
- Pusete kontrolli 1.5x1.5m (kolektori)

 Republika e Shqipërisë
 Ministria e Transportit dhe Infrastruktura
 KAMIKI ROSKOVËC
 Titulli i Projektit
 NEJADITI I UJRAVE TE BARDHA I NJE PJESE
 TE BLOKUT NR.3 NE QENDER TE
 QYTETIT ROSKOVËC (FAZA NR 1)
 Forma
 PROJEKT IDE
 Viti
 Autor
 "NOVATECH STUDIO" SHPK

 ING. EMIL NOVA
 Grupi projektues

 Vuli
 Kapitulli
PROJEKTI ARKITEKTONIK
 Titulli i Vieshtimit
PLANIMETRIA K.U.B.
 Revizor
 QERSHOR 2022 Shkalla 1:250
 Erafotografia Pika
A.2 - 15

PROFILA TERTHORE AKSI 01 SHK:1:100

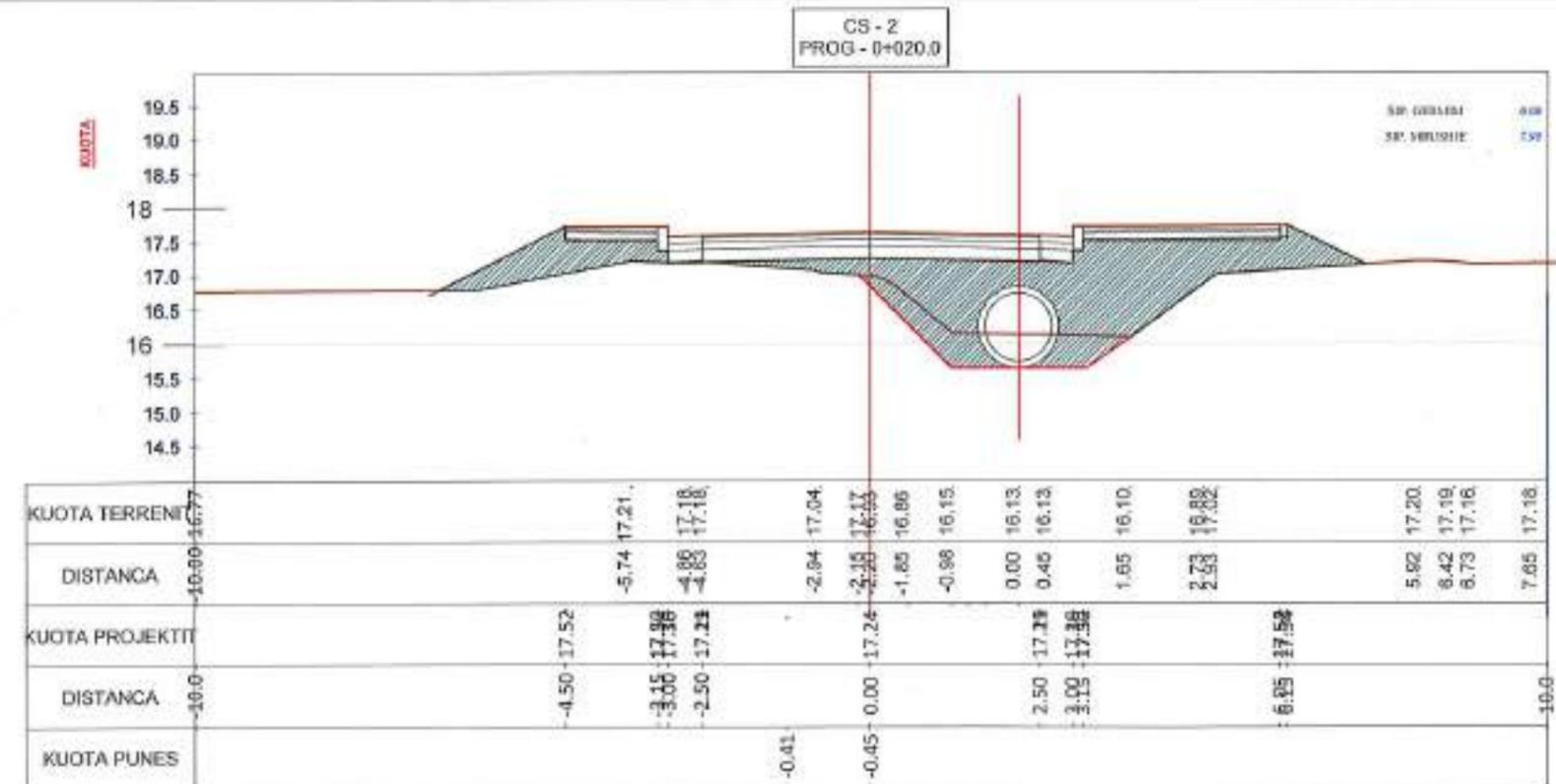
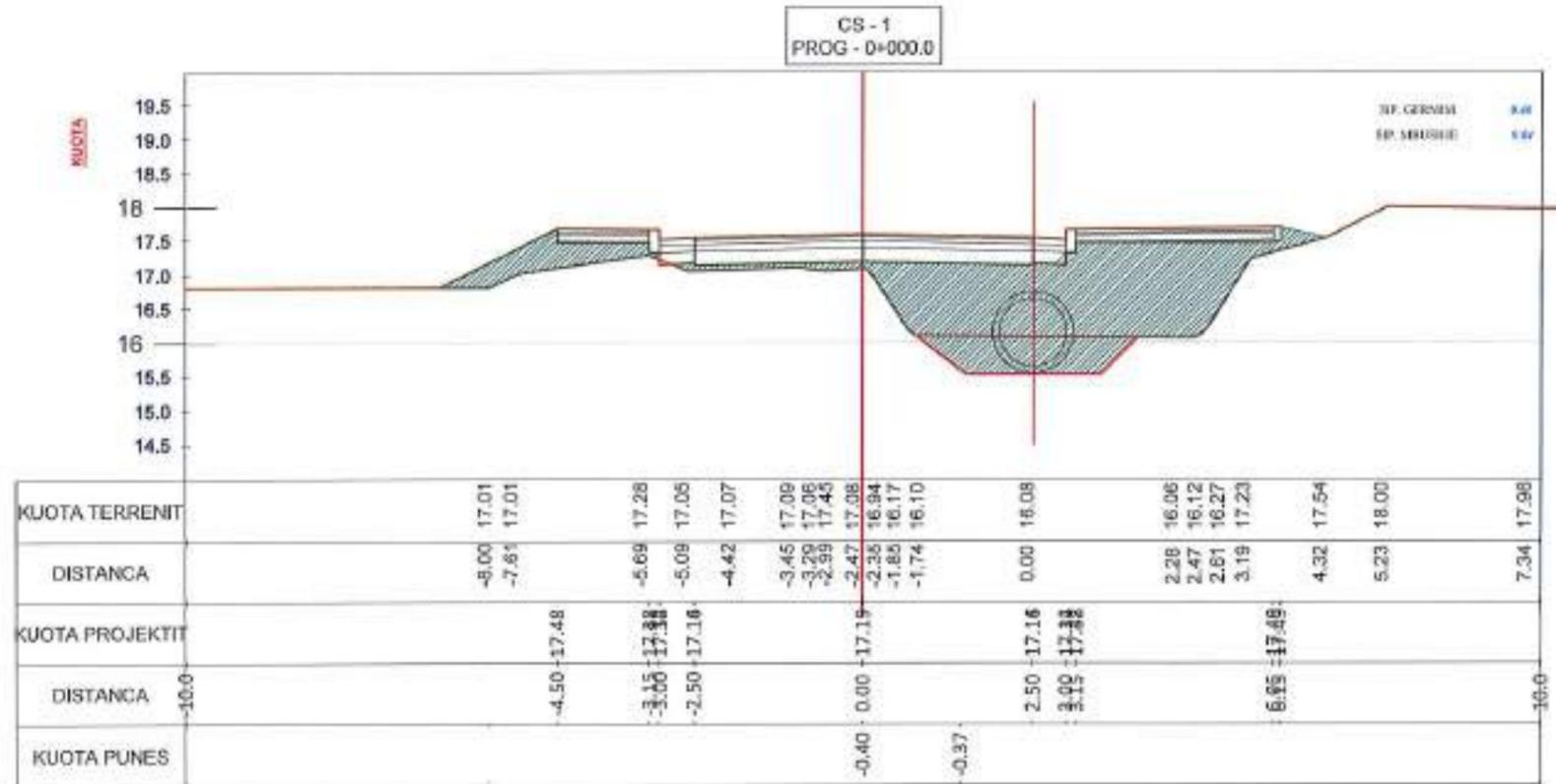

LEGJENDE

- Siperfaqe Mbusheje
- Siperfaqe Gernimi
- Gernim i detruar nga Kolektori D=1000mm
- Vija e tokes

Perdoruesi

REPUBLIKA E KOSOVES
MINISTRI I PLANIMIT URBAN I NJE PJESE
DE BLOKUT NR.3 NE QENDER TE
QYTETIT ROSHVOEC (FAZA NR 1)

Faza: PROJEKT IDE

Autor: "NOVATECH STUDIO" SHPK
ING. EMIL NOVA

Grupi projektues

PROJEKTI ARKITEKTONIK

Titulli i Vizatimit: PROFILA TERTHORE

Reshtor: QERSHOR 2022

Skalla: 1:100

Emri i Vizatimit: A.2 - 16

PROFILA TERTHORE AKSI 01 SHK:1:100

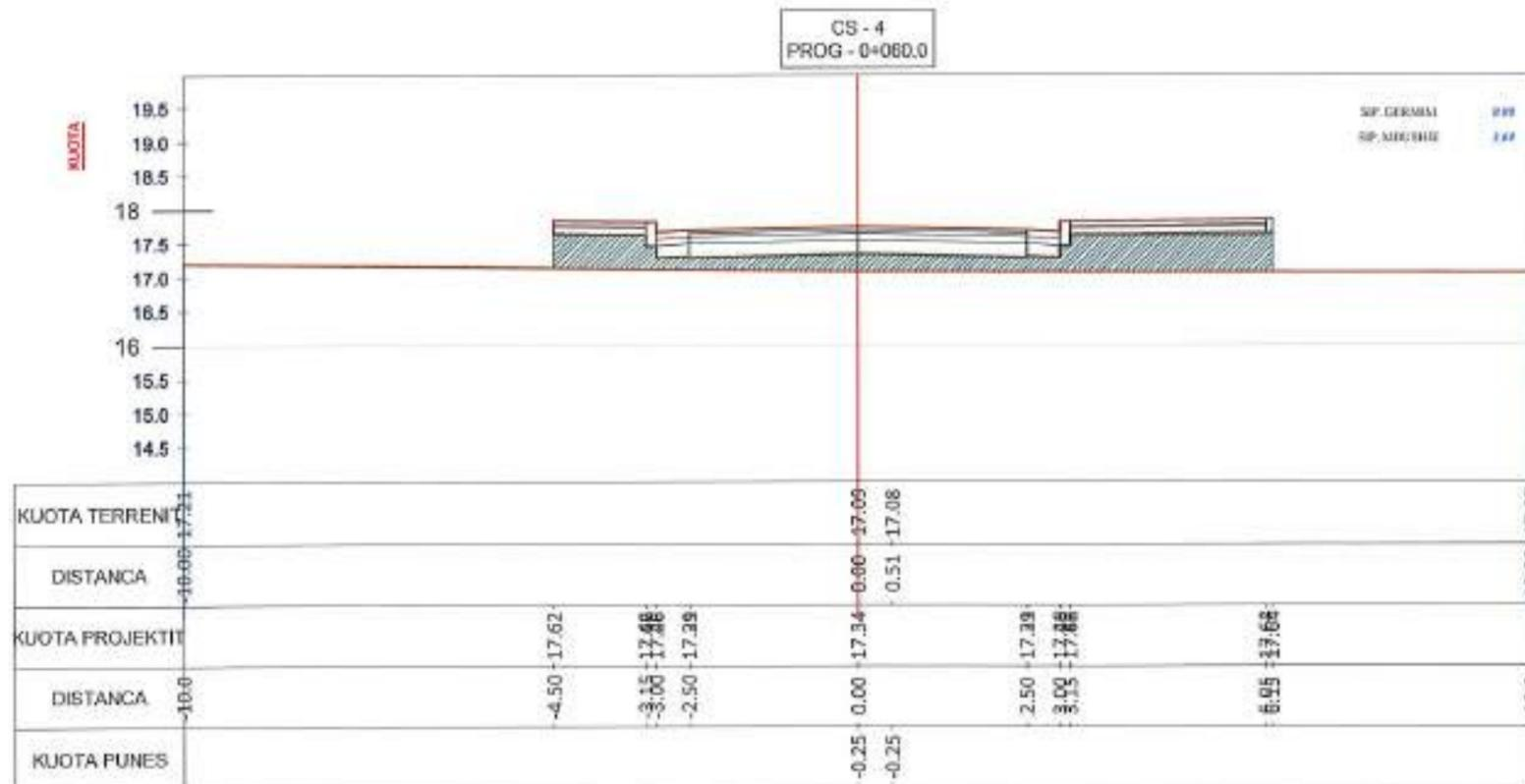
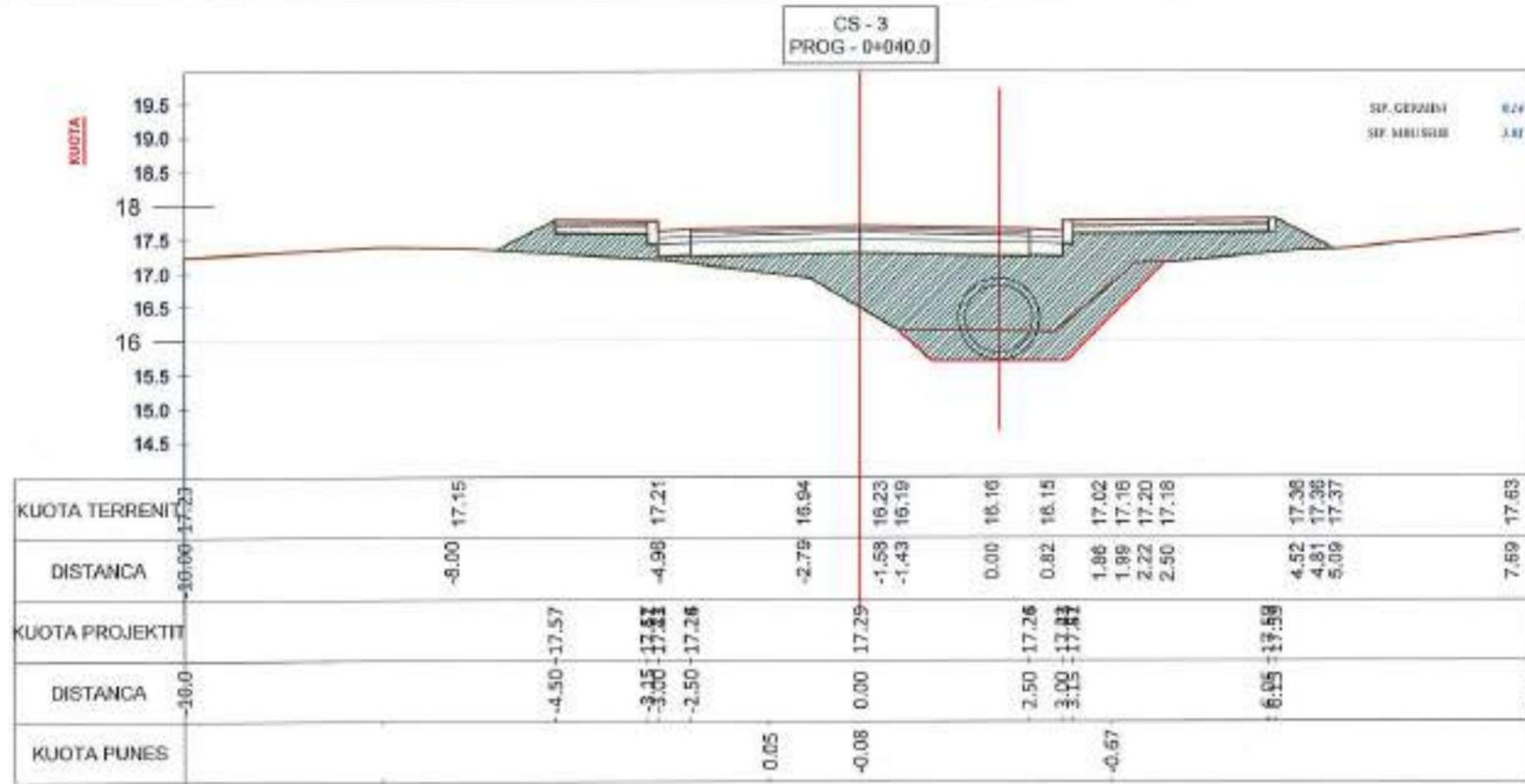

LEGJENDE

- Siperfaqe Mbusheje
- Siperfaqe Gernimi
- Gernimi i detyruar nga Kolektori D=1000mm
- Vija e tokes



Parashtetja	
REPUBLIKA E SHqipërisë ING. ENJEL ROSKOVIC	
Titulli i Projektit	
REHABILITIMI URBAN I NJE PJESE TE BLOKUT NR.3 NE QENDER TE QYTETIT ROSKOVIC (FAZA NR 1)	
Faza	
PROJEKT IDE	
Vidhi	
Autor	
"NOVATECH STUDIO" SHPK ING. EMIL ROVA	
Grupi projektimi	
NOVATECH STUDIO SHPK	
Vidhi	
Kapitulli	
PROJEKTI ARKITEKTONIK	
Titulli i Vizatimit	
PROFILA TERTHORE	
Realizuar	Shkalla
QERSHORI 2022	1:100
Emërtimi i Detyrës	
A.2 - 17	

PROFILA TERTHORE AKSI 01 SHK:1:100

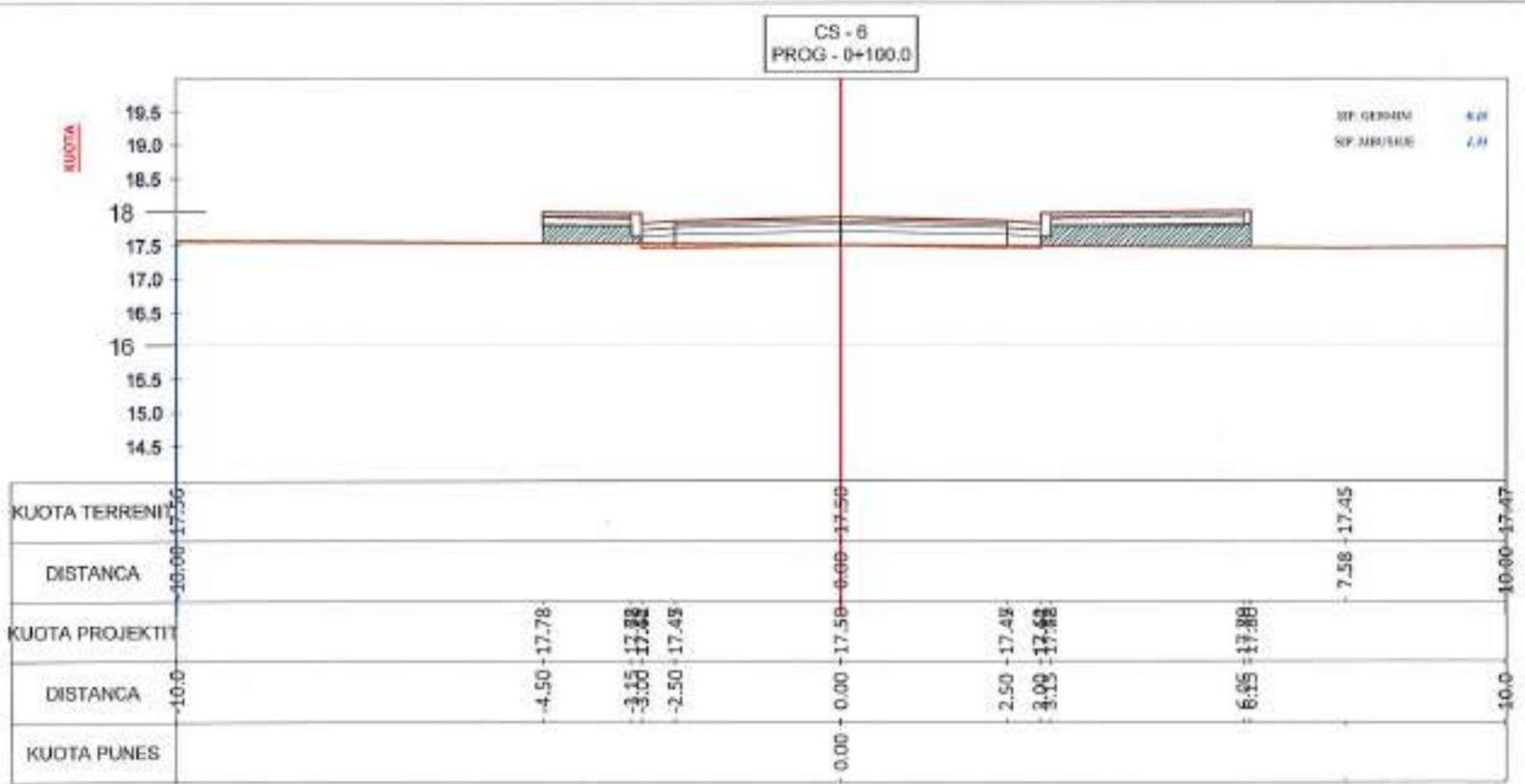
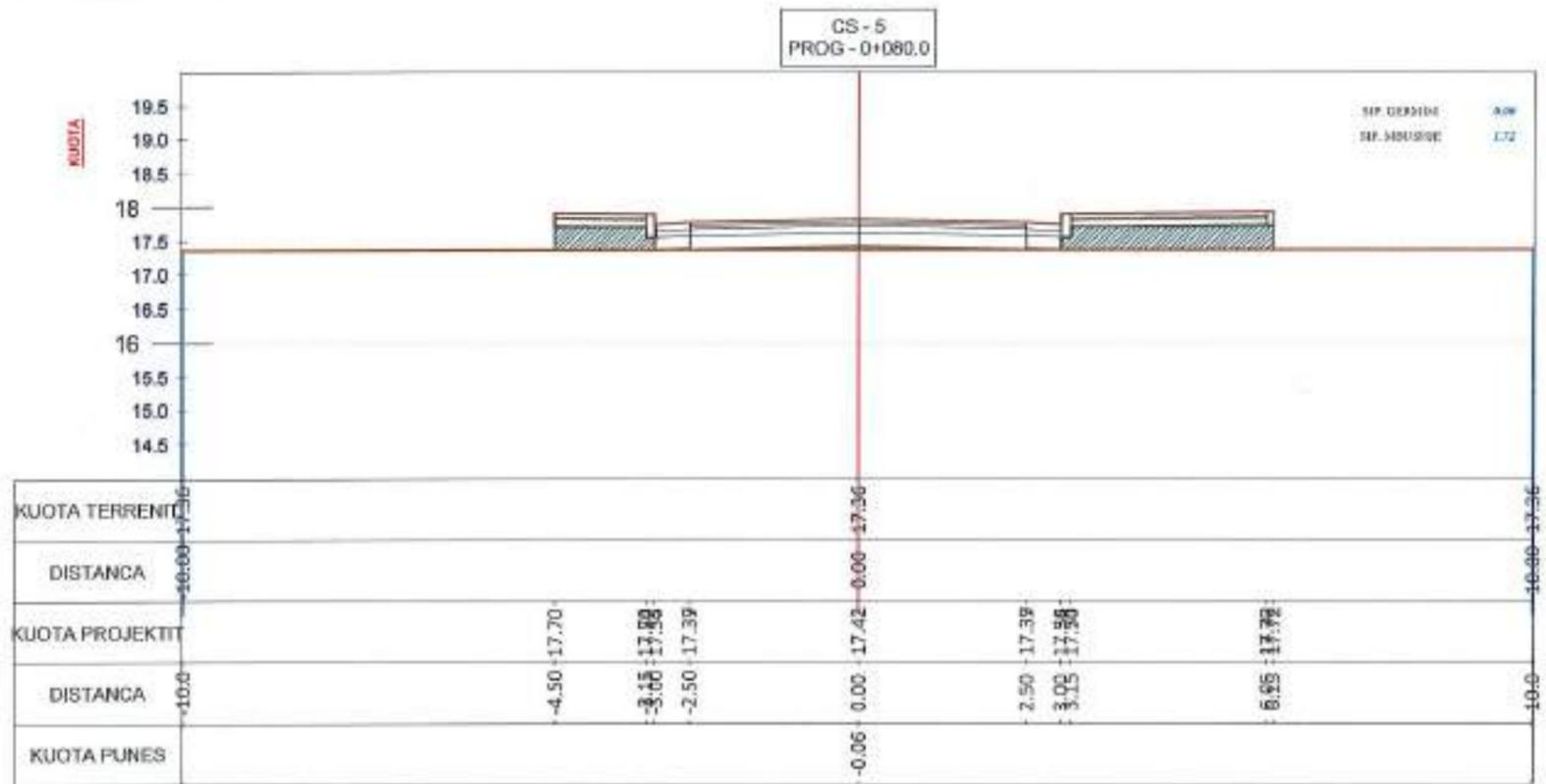

LEGJENDE

- Siperfaqe Mbulshje
- Siperfaqe Germimi
- Germim i detynuar nga Kolektori D=1000mm
- Vija e tobes



REHABILITIMI URBAN I NJE PJESE
TE BLOKUT NR.3 NE QENDER TE
QYTETIT ROSKOVEC (FAZA NR 1)

Faza **PROJEKT IDE**

Autor
NOVATECH STUDIO "SHPE"
ING. EMIL NOVA

Grupi projektimit:

ING. NOVA	Mirator
ING. NOVA	NGJ. PAK
ING. NOVA	NGJ. MOU
ING. NOVA	NGJ. NOVA
ING. NOVA	NGJ. NOVA
ING. NOVA	NGJ. NOVA
ING. NOVA	NGJ. NOVA
ING. NOVA	NGJ. NOVA
ING. NOVA	NGJ. NOVA
ING. NOVA	NGJ. NOVA

Vula

PROJEKTI ARKITEKTONIK

Titulli i Vizatimit
PROFILA TERTHORE

Rrealizuar **QERSHORI 2022** Shkalla **1:100**

PROFILA TERTHORE AKSI 01 SHK:1:100

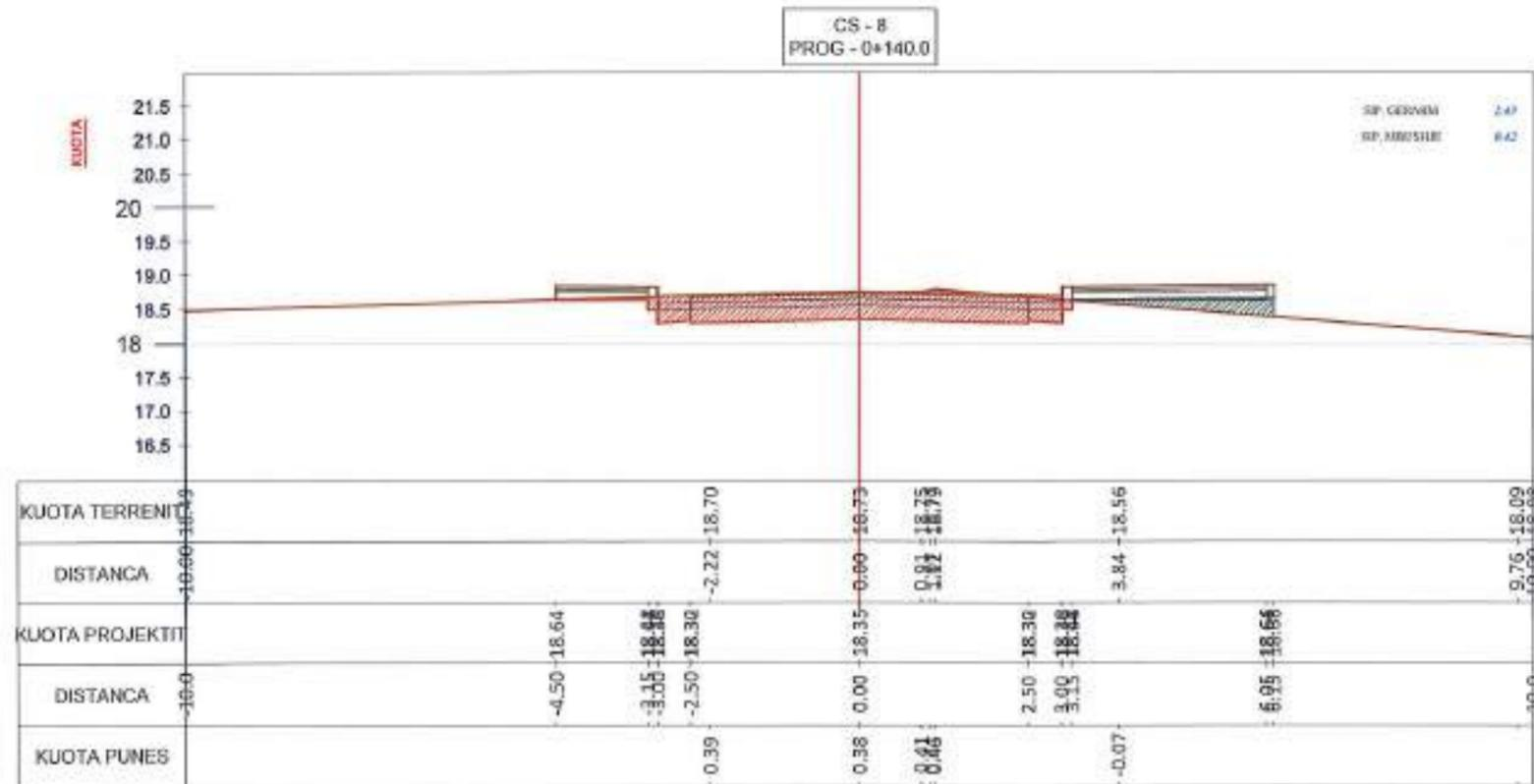
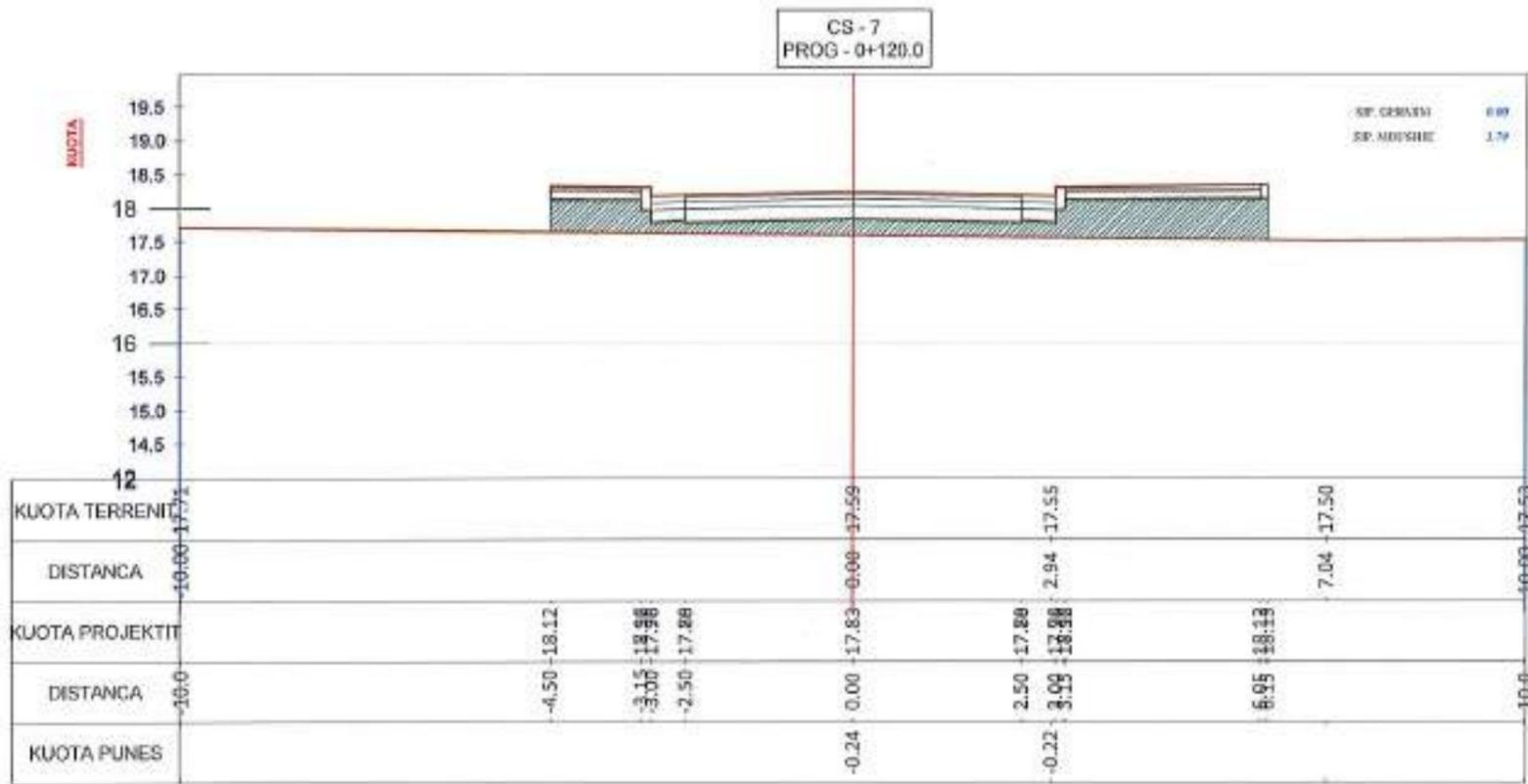

LEGJENDE

- Siperfaqe Mbulshje
- Siperfaqe Germimi
- Germim i detruar nga Kolektori D=1000mm
- Vija e tokes



REHABILITIMI URBAN I NJE PJESE TE BLOKUT NR.3 NE QENDER TE QYTETIT ROSKOVEC (FAZA NR 1)

Faza **PROJEKT IDE**

Autor **"NOVATECH STUDIO" SH.P.K.**
ING. EMIL ROVA



PROJEKTI ARKITEKTONIK

Titulli i Vizatimit **PROFILA TERTHORE**

Krahasuar **QERSHOR 2023** Shkalla **1:100**

PROFILA TERTHORE AKSI 02 SHK:1:100

LEGJENDE

- Siperfaqe Mbnushje
- Siperfaqe Gjenerale
- Gjurmim i detyruar nga Kolektori D=1000mm
- Vija e tokes

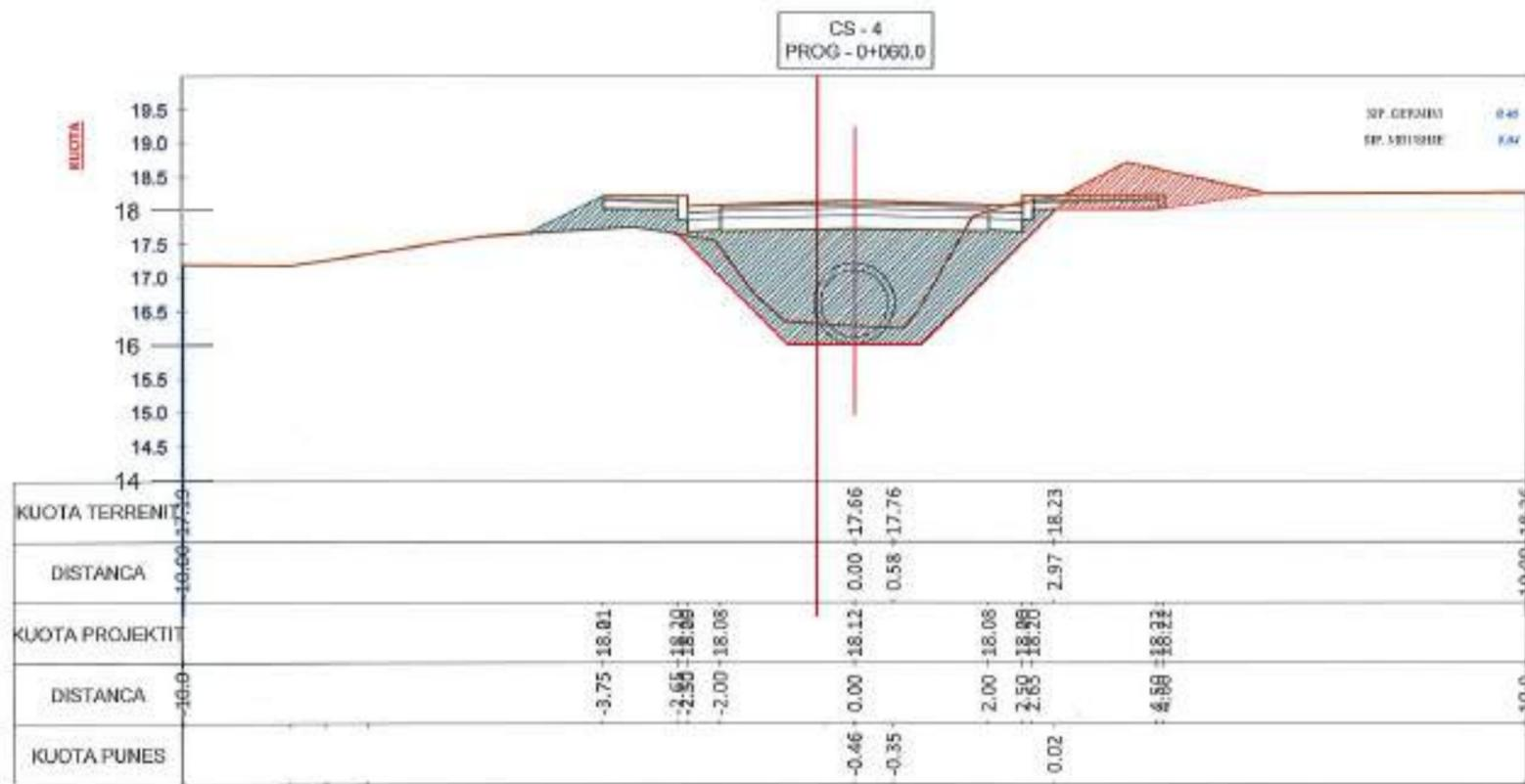

Titulli i Projektit
REHABILITIMI URBAN I NJE PJESE TE BLOKUT NR.3 NE QENDER TE QYTIMIT ROSKOVEC (FAZA NR.1)

Faza **PROJEKT IDE**

Vula

Autor **"NOVATECH STUDIO" SHPK**



ING. ENEL NOVA

Grupi projektimit:



Vula

Kopjimi

PROJEKTI ARKITEKTONIK

Titulli i Vëstitimit
PROFILA TERTHORE

Realizuar **QERSHOR 2022** Shkalla **1:100**

Kendrimi i Plote

A.2 - 22

DETAJ PUSETA E UJRAVE TE SHIUT SH 1:10

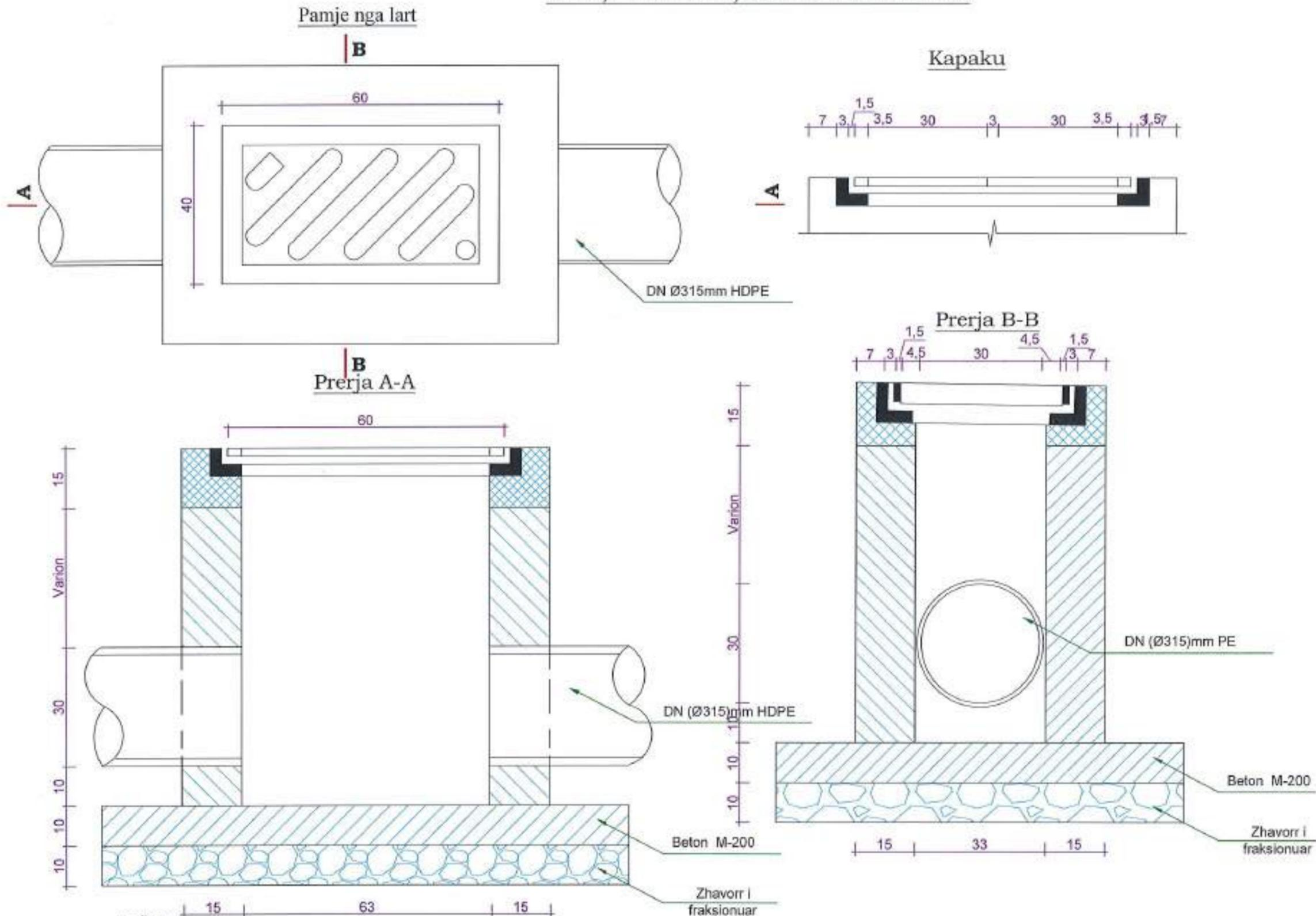

SHËNIME :

- 1.Muret e pusetes do te jene beton M-200 dhe me trashesi 15cm.
- 2.Betoni qe do te perdoret per brezin duhet te jete M-200, ndersa betoni i ullikut dhe shtreses do te jete M-150.
- 3.Telajo e kapakut do te jete prej gize i inkastruar me brezin e betonit dhe i vendosur ne nivelin e mbaruar te rruges sipas projektit.
- 4.Fundi i tubit duhet te jete 10cm nga fundi i pusetes.
- 5.Diametri i tubit do te jete si ne planimetri.



Titulli i Projektit
REHABILITIMI URBAN I NJE PJESE
TE BLOKUT NR.3 ME QENDER TE
QYTETIT ROSKOVEC (FAZA NR 1)

Faza PROJEKT IDE

Vula

Autor "NOVATECH STUDIO" SHPK



Vula

Kapitulli

PROJEKTI ARKITEKTONIK

Titulli i Viteut

DETAJ

Revizuar QERSHOR 2022 Skala 1:10

Emblimi i Detyra

A.2 - 23

PLANIMETRIA E PERGJITHSHME, SH 1:1000



<p>Parashtetja: Vula</p> <p>BASHKIA ROSKOVEC</p>	<p>Titulli i Projektit:</p> <p>REHABILITIMI URBAN I NJE PJESE TE BLOKUT NR.3 NE QENDER TE QYTETIT ROSKOVEC (FAZA NR 1)</p> <p>Nezupjektet:</p> <p>INFRASTRUKTURA RRUGORE AKSI 03</p>	<p>Autor:</p> <p>"NOVATECH STUDIO" SHPK</p> <p>ADMEN ING. EMIL BOVA</p>	<p>Grupi projektuesit:</p> <table border="1"> <tr><td>ING. NGJYRI</td><td>Wllesir TOMCO</td></tr> <tr><td>ING. NIKOLLE</td><td>Mirza BACI</td></tr> <tr><td>ING. NIKOLLE</td><td>Edvin BODI</td></tr> <tr><td>ING. NIKOLLE</td><td>Artur BODI</td></tr> <tr><td>ING. NIKOLLE</td><td>Vasko BODI</td></tr> <tr><td>ING. NIKOLLE</td><td>Arben BAKSARI</td></tr> <tr><td>ING. NIKOLLE</td><td>Ilir DOKU</td></tr> <tr><td>ING. NIKOLLE</td><td>Marina SHALBU</td></tr> <tr><td>ING. NIKOLLE</td><td>Skënder BAKSARI</td></tr> </table>	ING. NGJYRI	Wllesir TOMCO	ING. NIKOLLE	Mirza BACI	ING. NIKOLLE	Edvin BODI	ING. NIKOLLE	Artur BODI	ING. NIKOLLE	Vasko BODI	ING. NIKOLLE	Arben BAKSARI	ING. NIKOLLE	Ilir DOKU	ING. NIKOLLE	Marina SHALBU	ING. NIKOLLE	Skënder BAKSARI	<p>Projektori:</p> <p>PROJEKTI ARKITEKTONIK</p>	<p>Titulli i Viteut:</p> <p>PLANIMETRI E PERGJITHSHME AKSI 03</p>	<p>Reshtuar:</p> <p>QERSHOR 2023</p> <p>1:1000</p>	<p>Shprehja:</p> <p>A3 - 01</p>
ING. NGJYRI	Wllesir TOMCO																								
ING. NIKOLLE	Mirza BACI																								
ING. NIKOLLE	Edvin BODI																								
ING. NIKOLLE	Artur BODI																								
ING. NIKOLLE	Vasko BODI																								
ING. NIKOLLE	Arben BAKSARI																								
ING. NIKOLLE	Ilir DOKU																								
ING. NIKOLLE	Marina SHALBU																								
ING. NIKOLLE	Skënder BAKSARI																								

PROFILI TERTHORE TE RRUGES

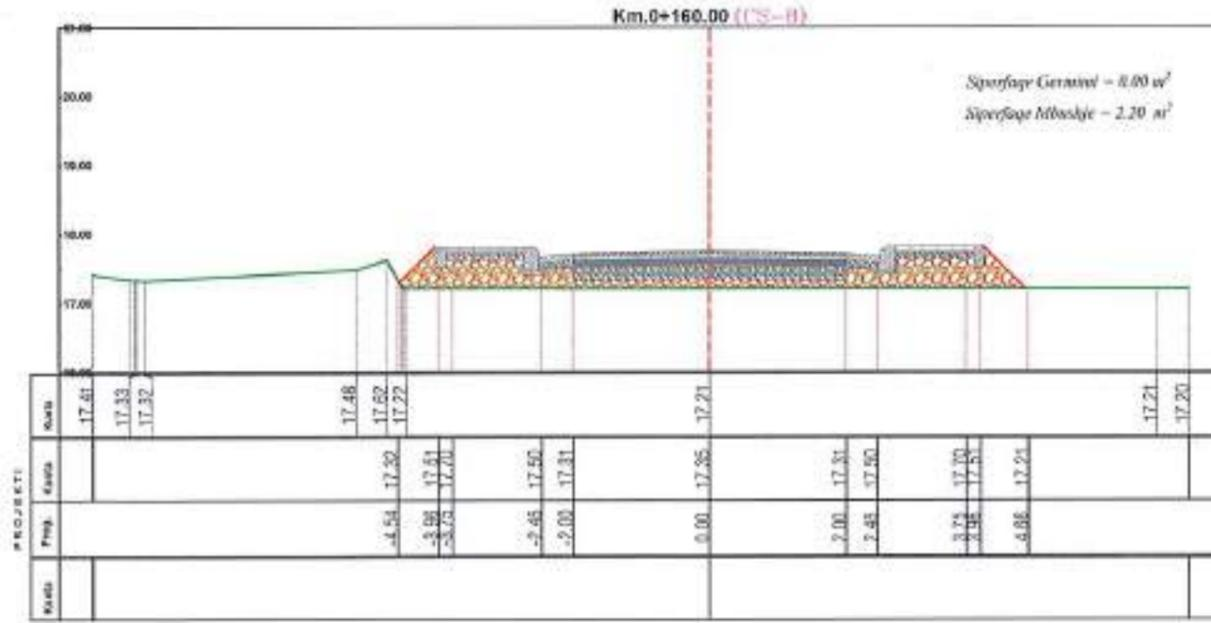
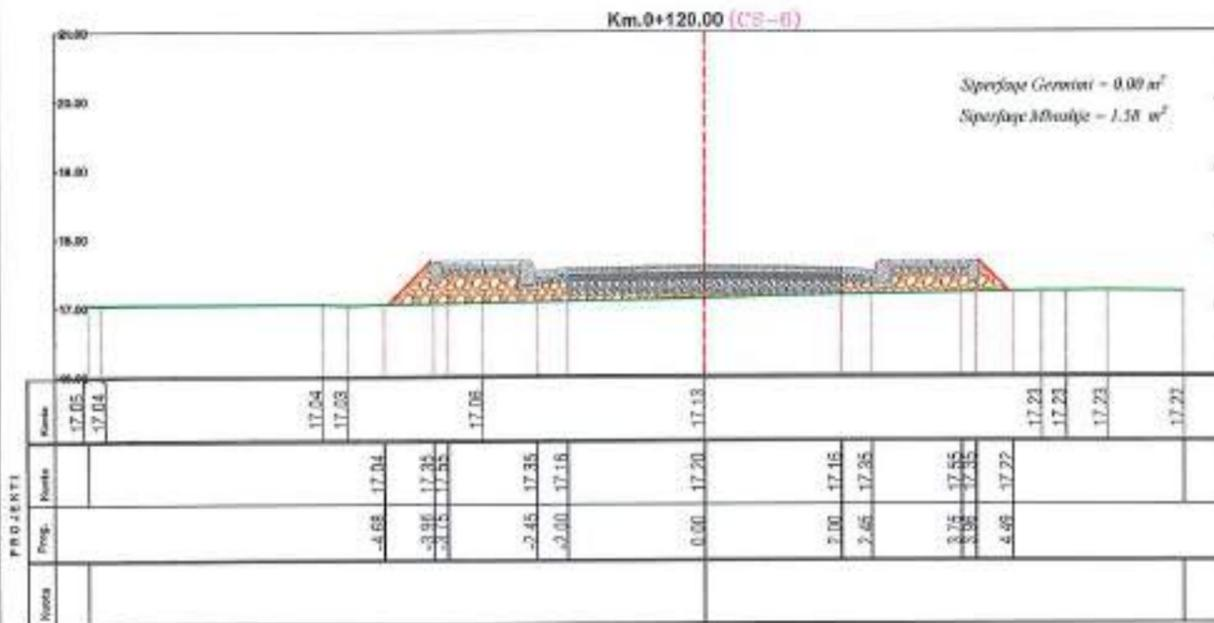
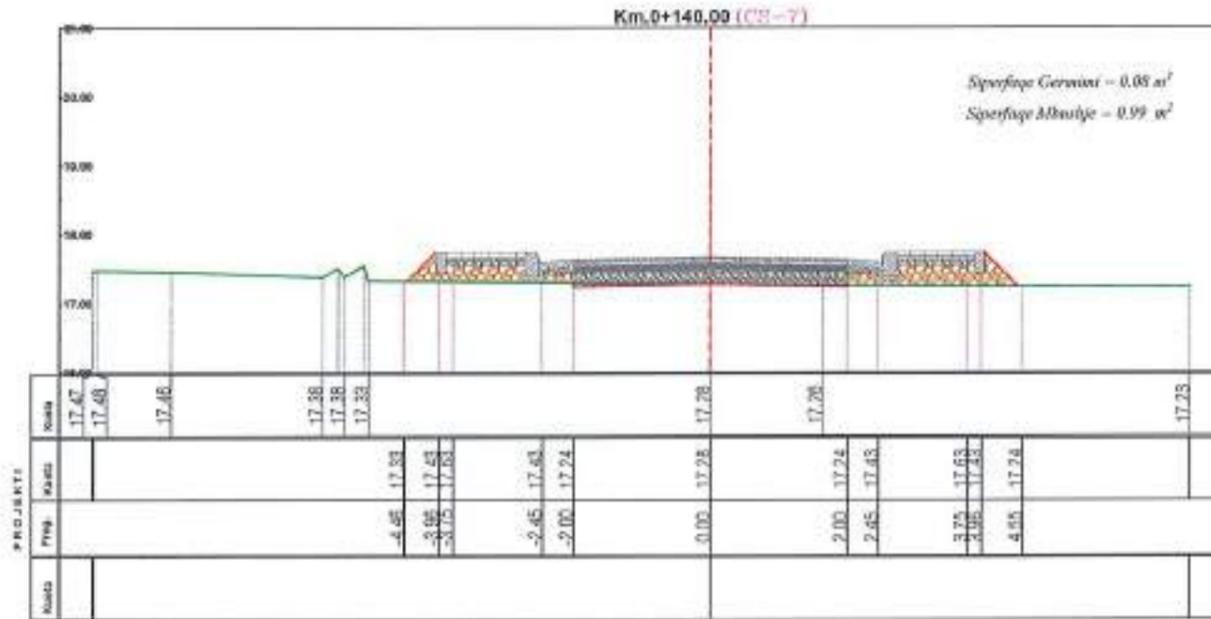
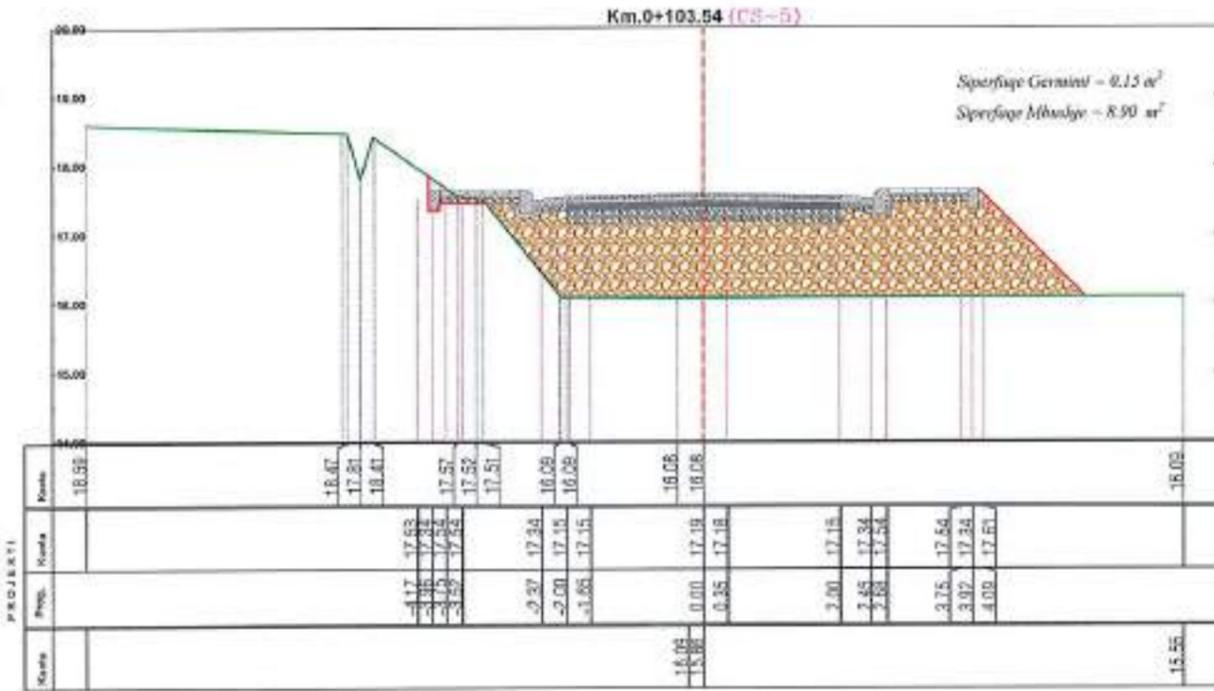

Porosuesi: Yula

Yllinorë

BASHKIA ROSKOVEC

REPUBLICA E SHQIPERISE - DETERMINIM I PLANIT URBAN I NJE PJESE TE BLOKUT NR.2 NE QENDER TE QYTETIT ROSKOVEC (FAZA NR 1)

Wspoprojekt:

INFRASTRUKTURA RRUGORE AKSI 03

Autor

"NOVATECH STUDIO" SHPK

ADMIN ING. ENEL NOVA

PROJEKTIM I PASURIMETHE PALLUAJTES SIME

SUPERVIZION FUNKSIONAL

NOVATECH STUDIO

SH.P.K.

Grupi projektues:

MR. ENRIK	Mirza RACI
MR. KADRI	"BIR" BAZI
MR. ENRIK	KODRAN RENO
MR. ENRIK	DAVI BANI
MR. ENRIK	ERANDA BANA
MR. ENRIK	ADRIAN BASHAM
MR. ENRIK	SKENAJ BANI
MR. ENRIK	MARSHI BILANI
MR. ENRIK	NIKOLAJ BISHI

Kapitulli

PROJEKTI ARKITEKTONIK

Titulli i Vizimitit

PROFILI TERTHORE AKSI 03

Emetuar

QERROR 2022

Emetuesi i Planit

Shkalla

1:100

A3 - 06

PROFILI TERTHORE TE RRUGES

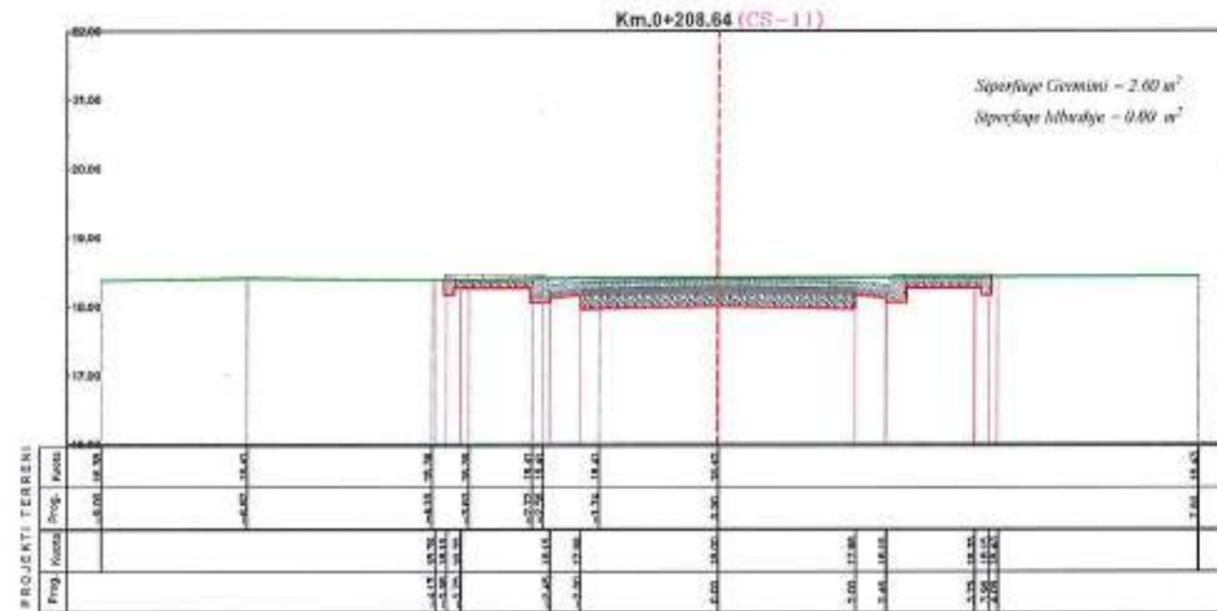
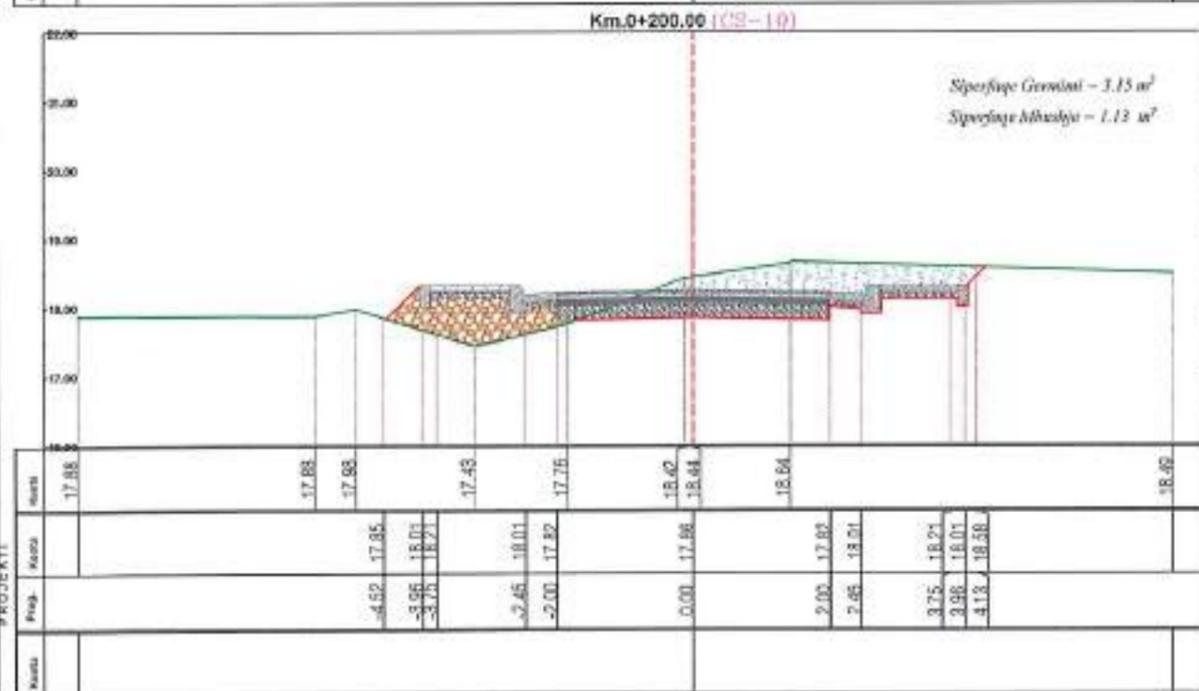
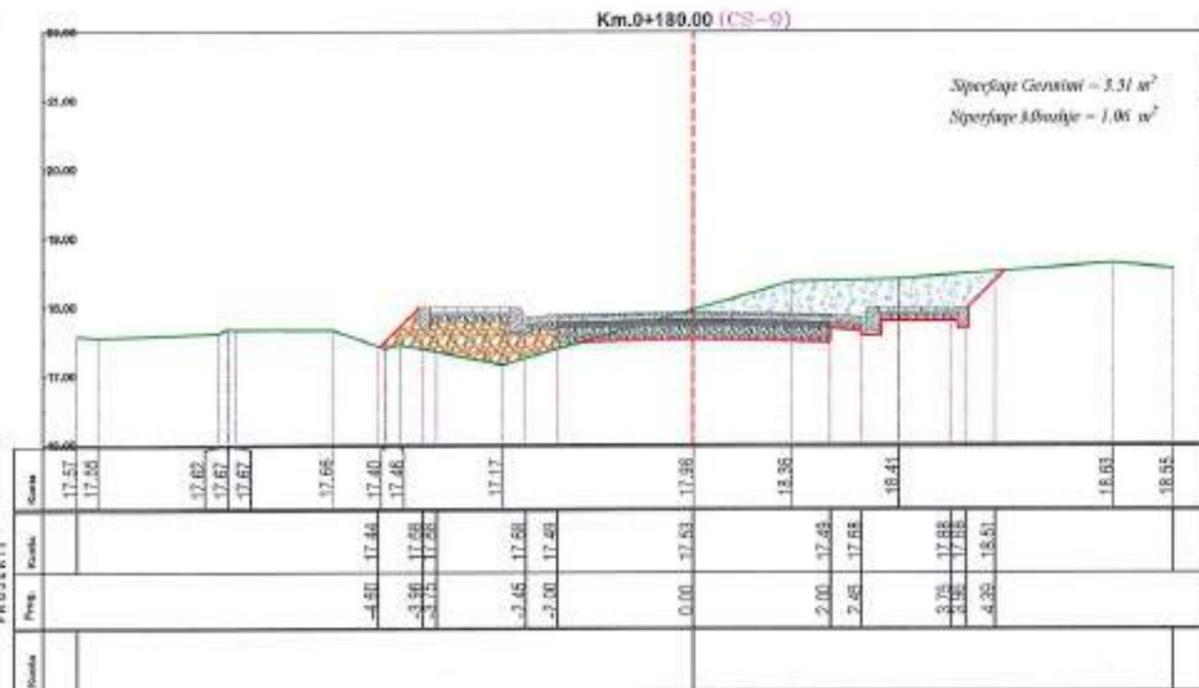

Personela: **BASHKIA ROSKOVEC**

Titulli i Projektit: **REHABILITIMI URBAN I NJE PJESE TE BLAGUT NR.3 NE QENDRA TE QYTETIT ROSKOVEC (FAZA NR 1)**

Titulli i Projektit: **INFRASTRUKTURA RRUGORE AKSI 03**

Autor: **NOVATECH STUDIO "BHPK"**

ADMIN ING. ENIL NOVA



Grupi projektuesit:

NO. 000001: **Meser TIRAO**

NO. 000002: **HEIN SADI**

NO. 000003: **HEIN SADI**

NO. 000004: **GRUP KVA**

NO. 000005: **KALASHI NOV**

NO. 000006: **ARTURIA BASHKIM**

NO. 000007: **HELDON DOR**

NO. 000008: **SHALAJ**

NO. 000009: **SHALAJ**

Titulli i Vizatimit: **PROJEKTI ARKITEKTONIK**

Titulli i Vizatimit: **PROFILI TERTHORE AKSI 03**

Realizuar: **QERSHOR 2022**

Skalla: **1:100**

A3 - 07

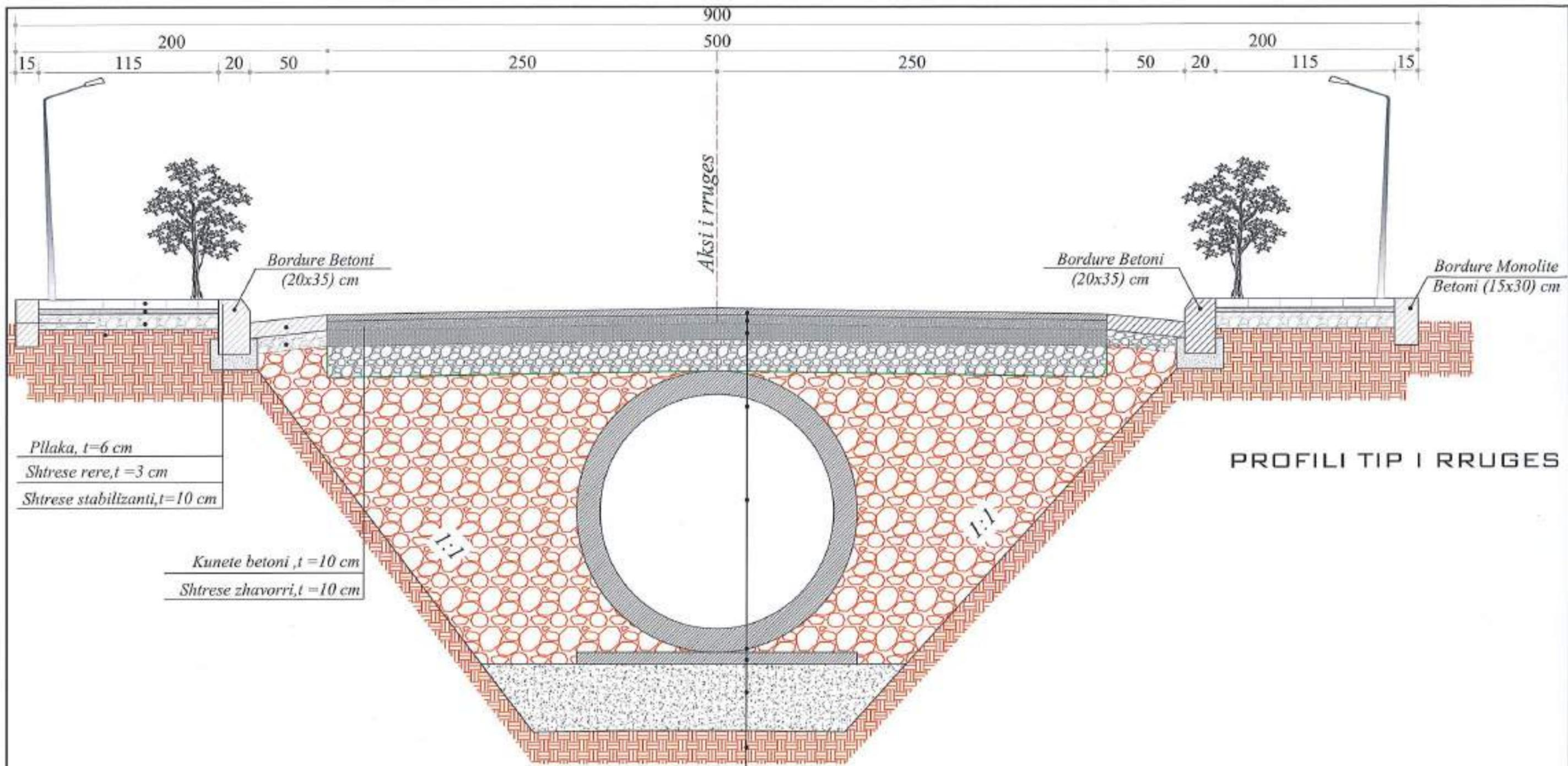

PROFILI TIP I RRUGES

Pllaka, $t=6\text{ cm}$
 Shtrese rere, $t=3\text{ cm}$
 Shtrese stabilizanti, $t=10\text{ cm}$

Kunete betoni, $t=10\text{ cm}$
 Shtrese zhavorri, $t=10\text{ cm}$

Shtrese asfalti, $t=4\text{ cm}$
 Shtrese binderi, $t=6\text{ cm}$
 Shtrese stabilizanti, $t=10\text{ cm}$
 Gjeotekstil 165 gr/m^2
 Shtrese çakelli, $t=20\text{ cm}$
 Tombino $\text{Ø}1500\text{mm}$
 Mbushje çakelli per vije projekti
 Shtrese betoni $t=7\text{ cm}$
 Shtrese zhavorri $t=15\text{ cm}$

Porositës: BASHKIA ROSKOVEC	Vula REPUBLIKA E SHQIPERISE	Projekti: REHABILITIMI URBAN I NJE NJESE TE BELLONIT NR.3 NE QENDER TE QYTETIT ROSKOVEC (FAZA NR 1)	Menprojekti: INFRASTRUKTURA RRUGORE ARSI 03	Autor: NOVATECH STUDIO "SHPK" ADMIN ING. EMIL NOVA	Vula NOVATECH STUDIO	Grupi projektuesi: ING. NOERTINI ING. NOERTINI ING. HIDROTEKNIK ARHITEKT ING. HIDROTEKNIK ING. GJED. DUK ING. HESKANI ING. ELEKTRIK ING. TOPOGRAF	Mesa: TONC Mete BEO Karta BOKA Kartolina NOVA Aktuale: 30X30cm Skalë: 0000 Mushje: SHKAR Fotografia: RSK0295	Kapitulli: PROJEKTI ARKITEKTONIK	Titulli i Vizatimit: PROFILI TIP I RRUGES ARSI 03	Redaktor: QESHOR 2022	Shkollë: 1:25
A3 - 08											

SEKSION TIP I RRUGES,
PK.6-11, SH.1:25

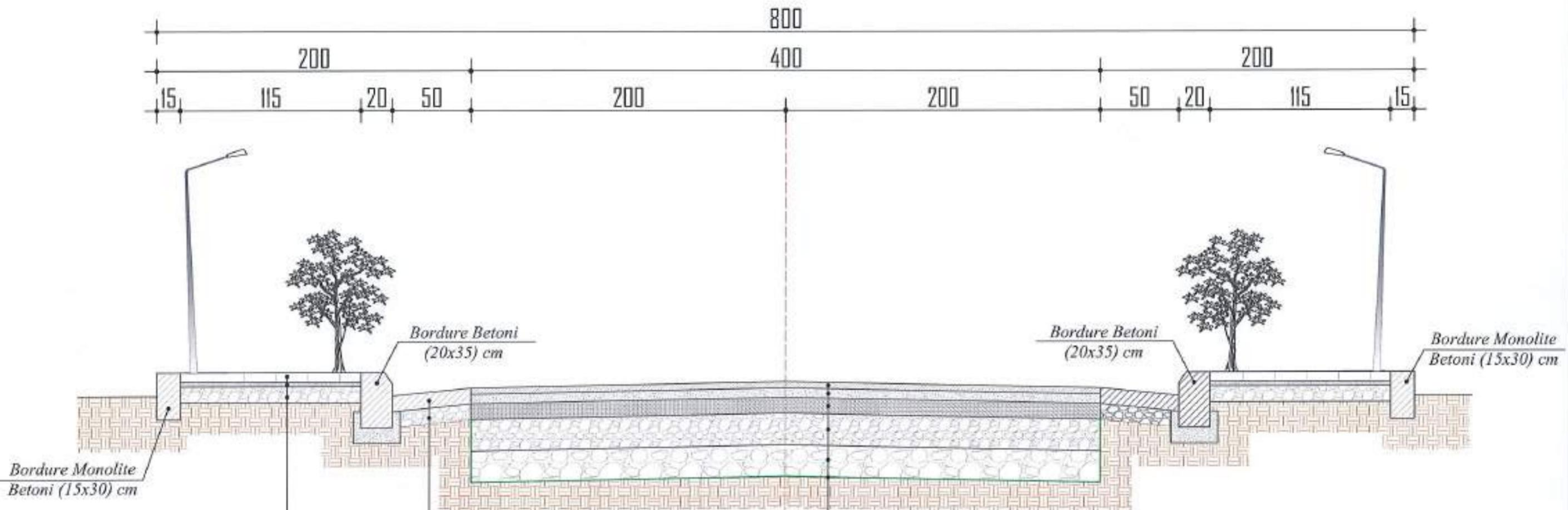

**Bordure Monolite
Betoni (15x30) cm**

Pllaka, t=6 cm
Shtrese rere, t=3 cm
Shtrese stabilizanti, t=10 cm

**Bordure Betoni
(20x35) cm**

Kunete betoni, t=10 cm
Shtrese zhavorri, t=10 cm

Shtrese asfalti, t=4 cm
Shtrese binderi, t=6 cm
Shtrese stabilizanti, t=10 cm
Shtrese çakelli, t=20 cm
Mbushje çakelli per vije projekti
Gjeotekstil 165 gr/m²

DETAJ BORDURE
SH.1:10

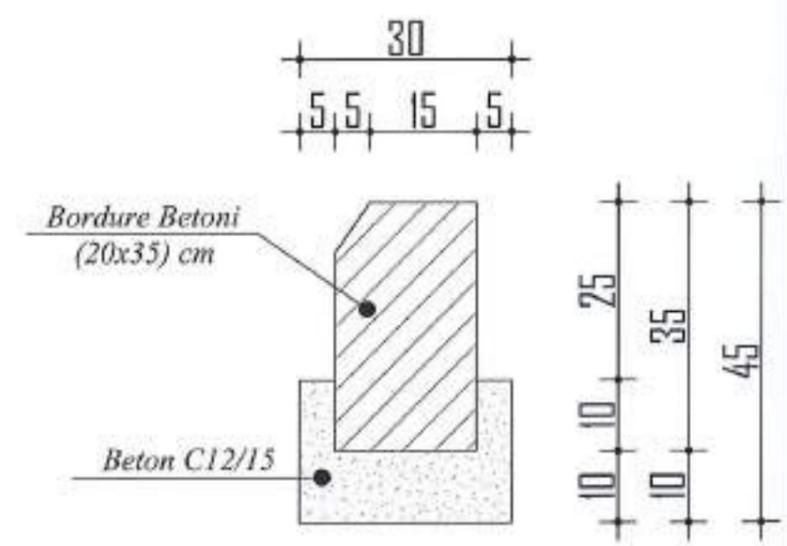

Përshiti: Bashkia Roskovec Vendi: Roskovec Titulli i Projektit: RINDRANIMI I QENDRIT DHE QENDER TE QYFETIT ROSKOVEC (FAZA NR 1) Ne grupin: INFRASTRUKTURA RRUGORE AKSI 03	Autor: NOVATECH STUDIO "SHPK" ADMIN ING. EMEL ROVA	Grupi projektimi: ING. NGERTIM: Mirza YMERI, Rola BACI ING. NGERTIM: Kadir BASHI ING. HIDROTEKNIK: Sulej BASHI ARKITEKT: Krenar NVA ING. HIDROTEKNIK: Arben DASHI ING. SHTRENGJER: Arben DASHI ING. MEKANIK: Rikard BASHI ING. ELEKTRIK: Kadir BASHI ING. TOPOGRAFI: Sulej BASHI	Kapitulli: PROJEKTI ARKITEKTONIK	Titulli i Vizatimit: PROFILI TIP I RRUGES AKSI 03	Realizuar: QERSHOR 2023 Emri i Fletës: A3 - 09	Shkalla: 1:25 1:10
--	---	---	----------------------------------	---	---	-----------------------

PUSETA TIP K.U.B
SH. 1:25

PLANIMETRIA E PUSITES
SH. 1:25

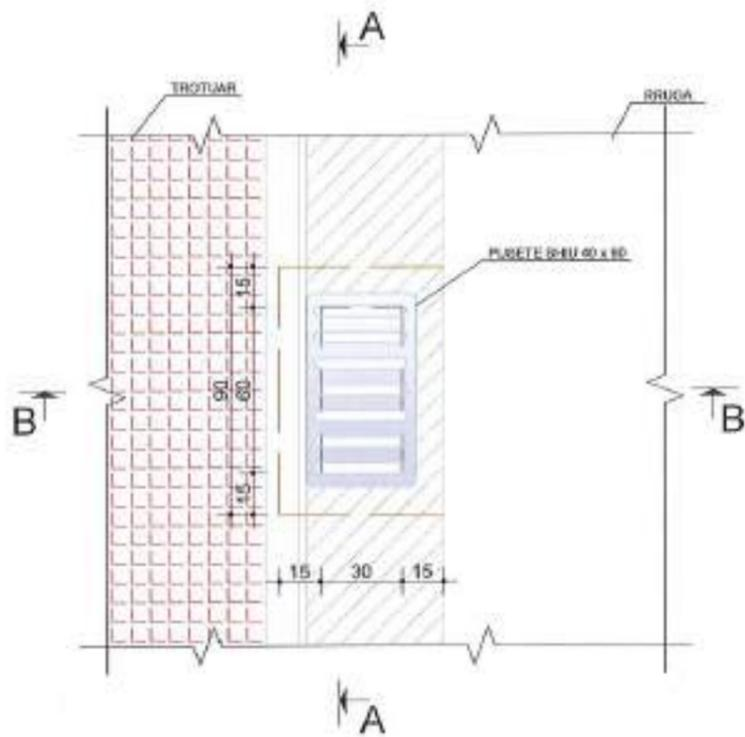

PRERJA A-A
SH. 1:25

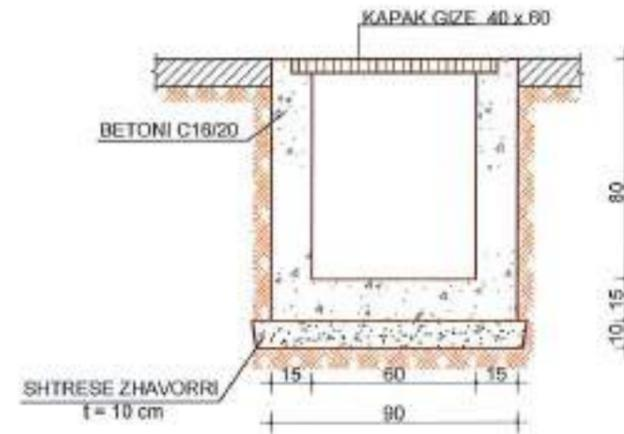

PRERJA B-B
SH. 1:25

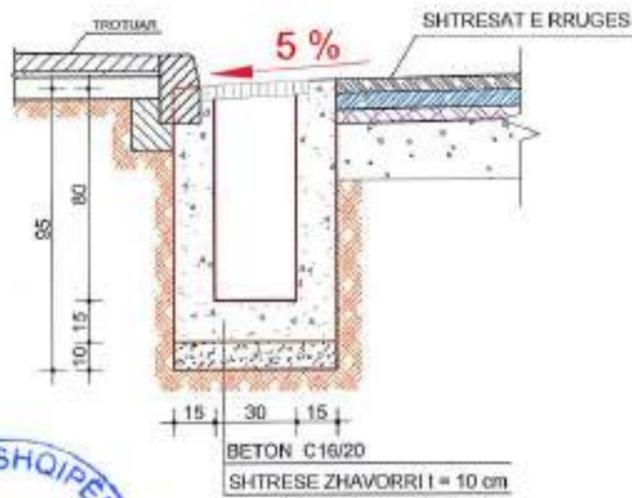

Forësitë:
BASHKIA ROSKOVEC

Titulli i Projektit:
KONABILITIMI URBAN I NJË PJESE
TË BLOKUT NR.3 NE QENDER TE
QYTETIT ROSKOVEC (FAZA NR 1)
Titulli i Projektit:
INFRASTRUKTURA RRUGORE AKSI 03

Autore:
"NOVATECH STUDIO" SHPK
ADMIN ING. EMIL NOVA



Grupi projektues:
Menesi TOMO
Vula: SAK
KOSOVA
GJITHI
KOSOVA
KOSOVA
KOSOVA
KOSOVA
KOSOVA
KOSOVA
KOSOVA

Kapitulli:
**PROJEKTI
ARKITEKTONIK**

Titulli i Vizimit:
DETALJE TE RRUGES
ANG 03

Realizuar:
QERROR 2022
Emërtimi i Planit:
VAR

A3 - 10

PUSETE KONTROLLI

PLANIMETRIA SH 1:25

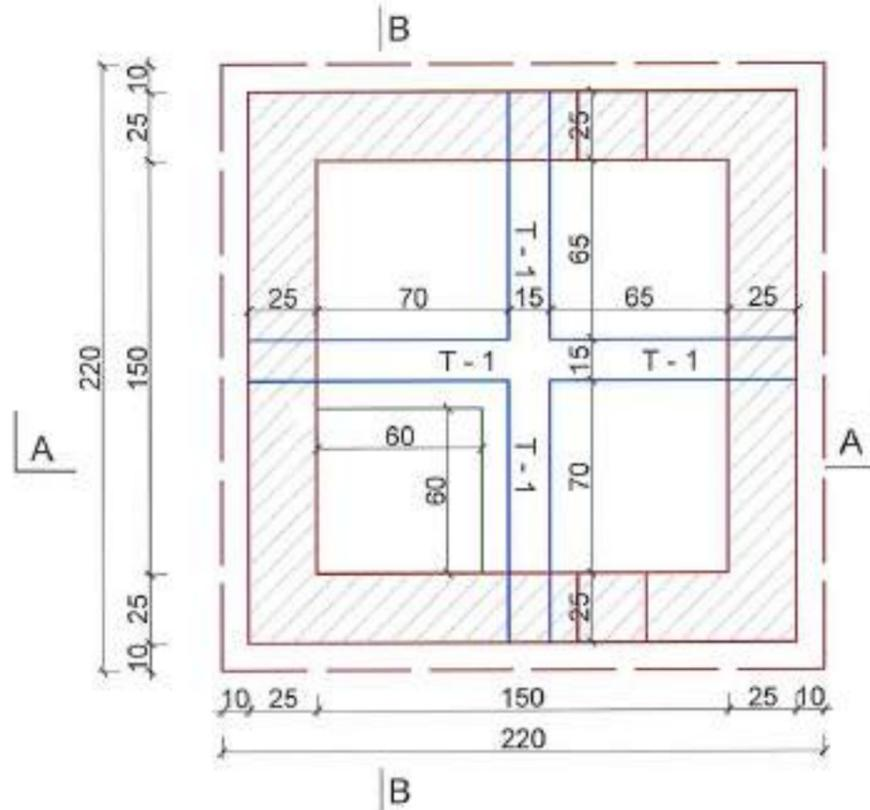

ARMIMI I SOLETES SH 1:25

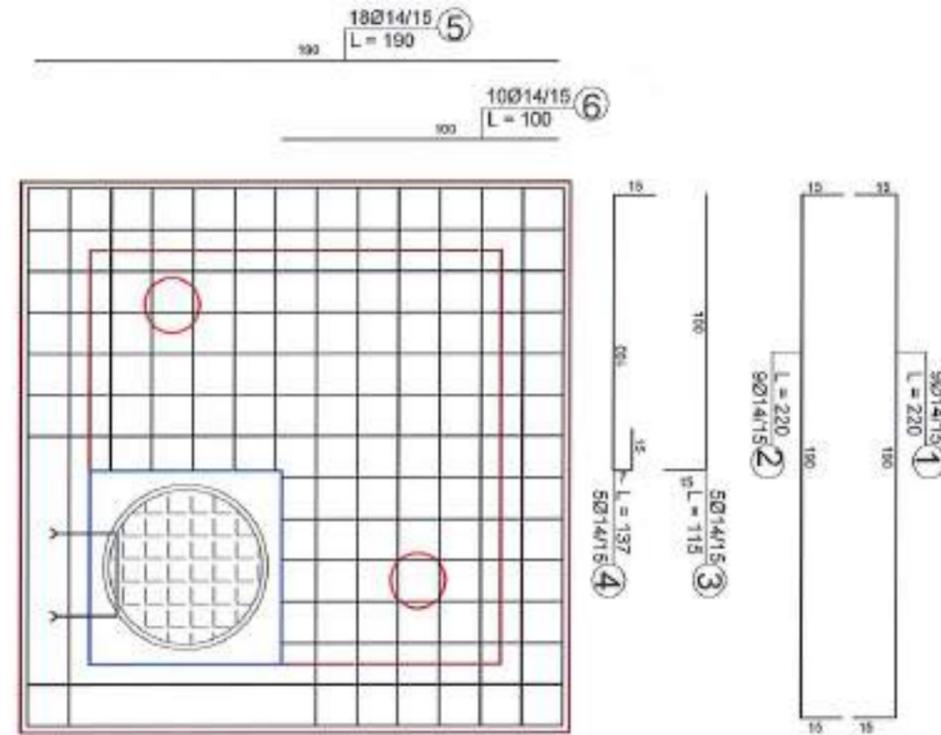

PRERJE A-A SH.1:25

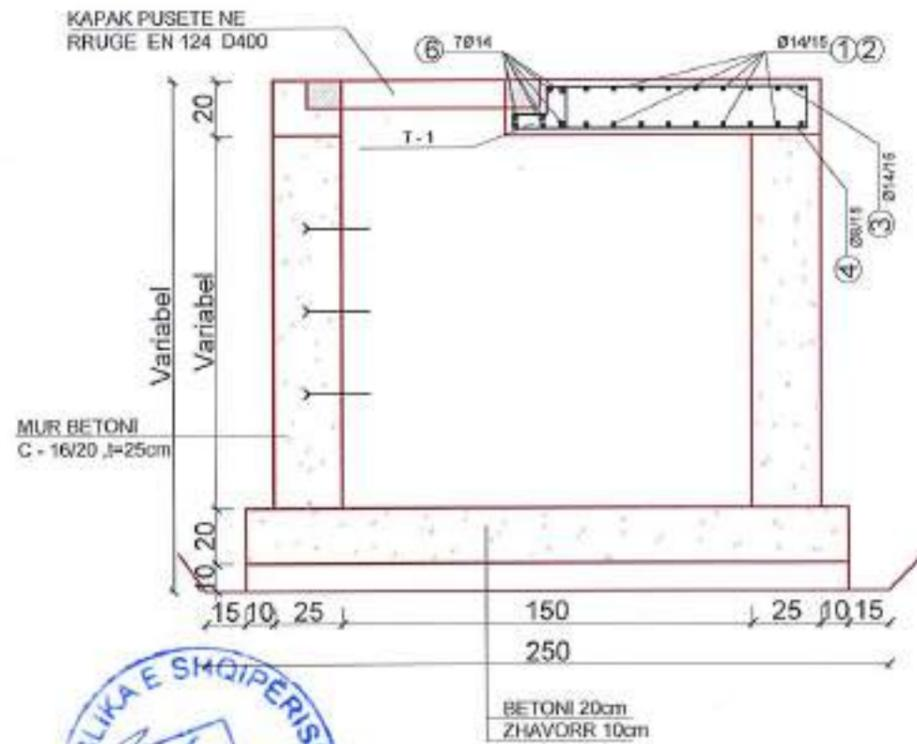

T-1 SH.1:25

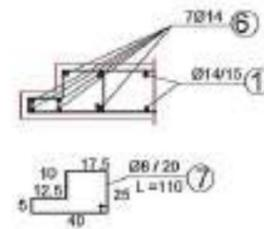

GANXHE SH.1:25

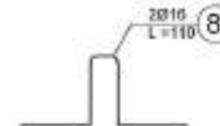

PRERJA B - B SH.1:25

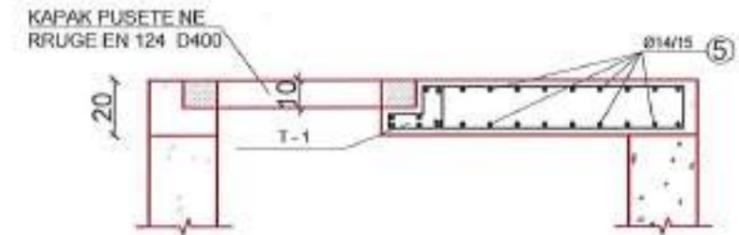

TABELE HEKURI

ELEMENT		SPECIFIKIMET E ARMIMIT					PER 1 ELEMENT			PESHA
TIPI	COPE	NR	Ø	L/cm	COPE	L/m	Ø	EL/m	P/kg	TOTAL
PRERJA 1-1		1	14	220	9	19.8	8	22	0.395	8.69
		2	14	220	9	19.8	14	113.72	1.208	137.37
		3	14	115	5	5.75	16	2.2	1.578	3.47
		4	14	137	5	6.67				149.53
PRERJA 2-2		5	14	190	18	34.2				
		6	14	195	14	27.3				
		7	8	110	20	22				
		8	16	110	2	2.2				

PLANIMETRIA E PERGJITHSHME, SH 1:500

Rruga Isuf Shabihasa

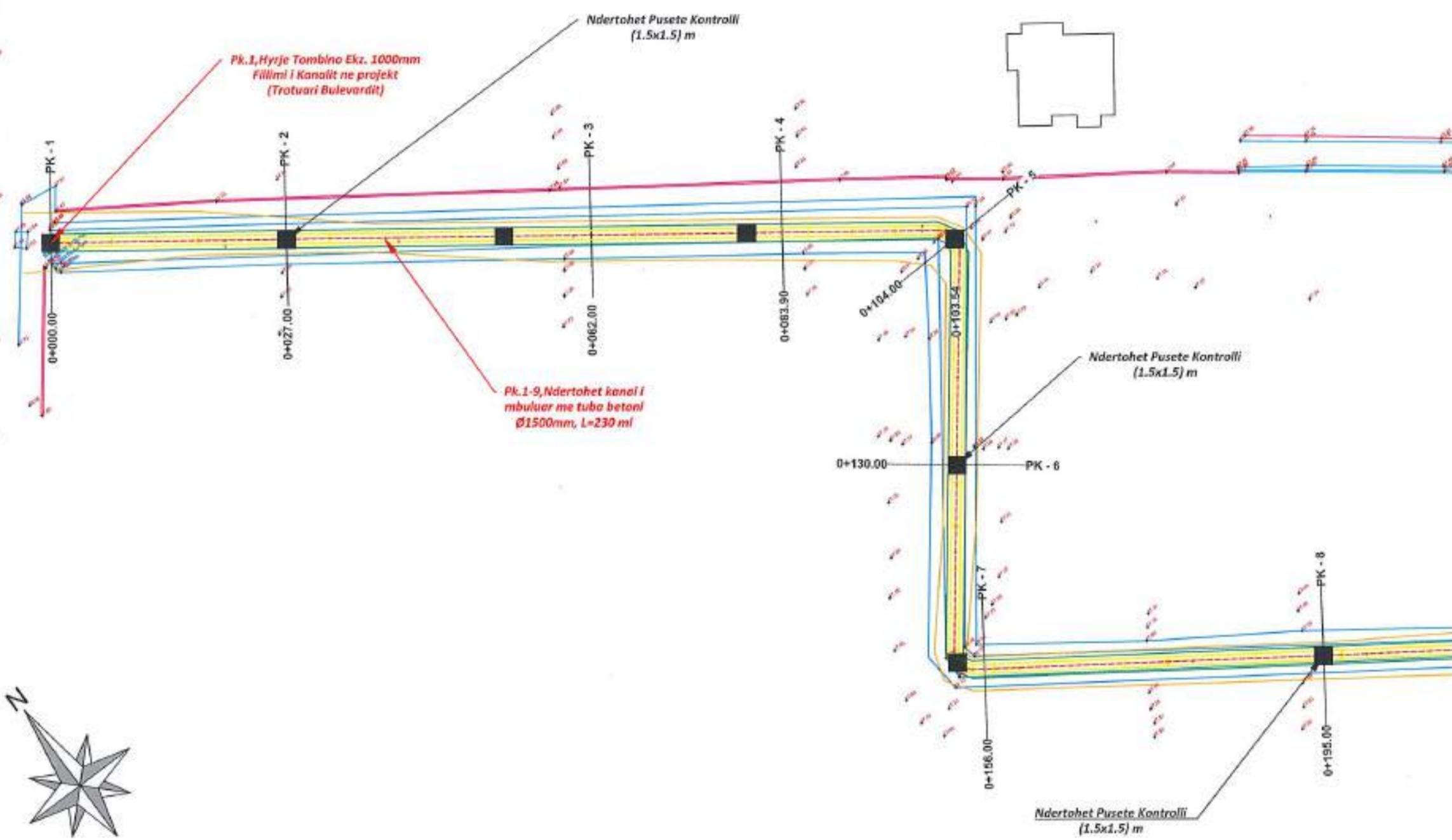

PLANIMETRIA E PERGJITHSHME, SH 1:500

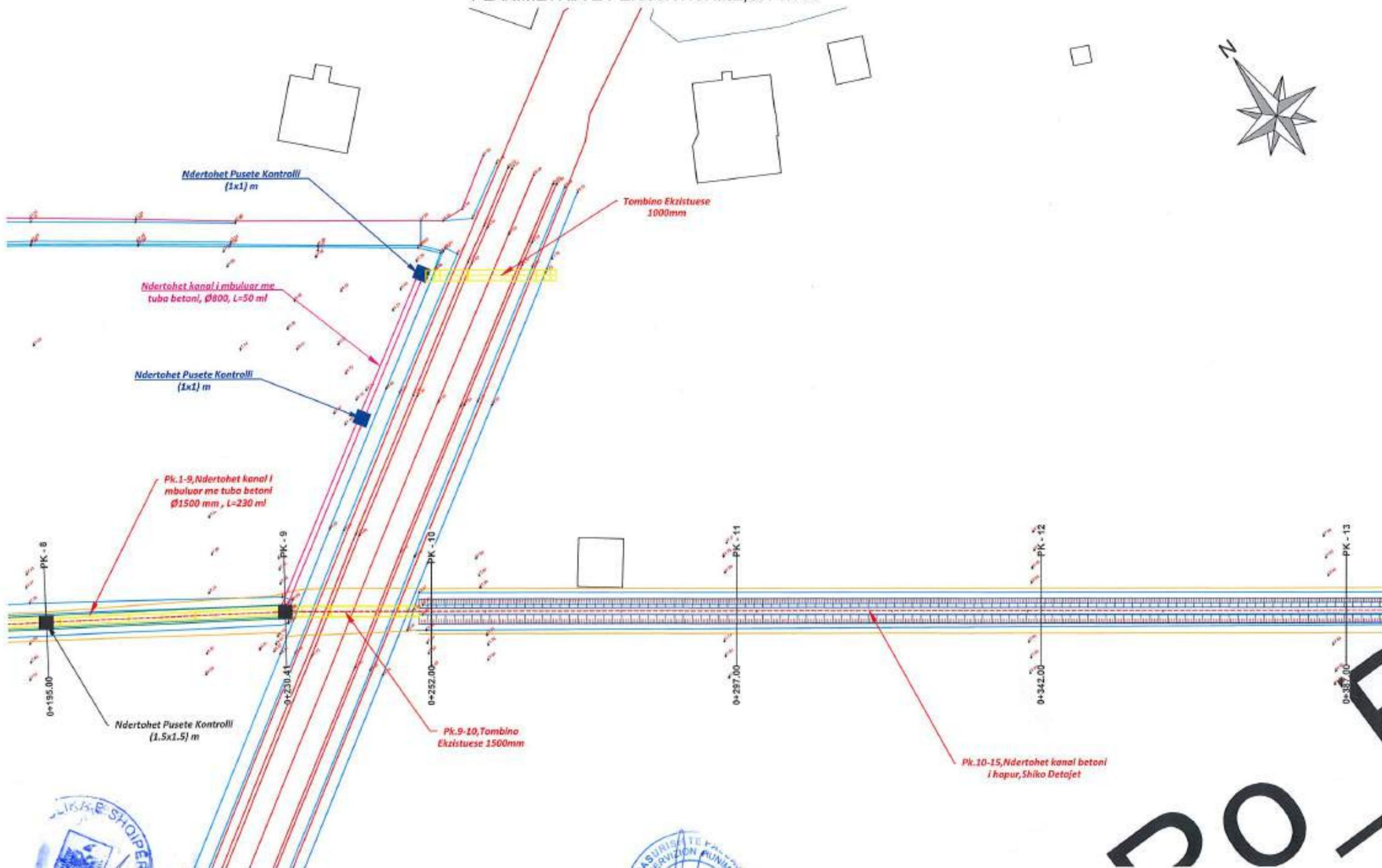

Prosjekti: Bashkia ROSKOVEC

Titulli i Projektit: REHABILITIMI URBAN I NJE PJESE TE BLOKUT NR.3 NE QENDER TE QYTESH ROSKOVEC (FAZA NR 1)
 Subprojekti: KANALI I UJRAVE TE LARTA

Autori: "NOVATECH STUDIO" SHPE
 ADMIN ING. EMIL NOVA



Grupi projektues:
 NO. ARKITEKT: Mirza TEMO
 NO. INZHINIERI: Kren BACI
 NO. INZHINIERI: Rodon ROKI
 NO. INZHINIERI: Greta NOVA
 NO. INZHINIERI: Klement TOSI
 NO. INZHINIERI: Armand BASHKIMI
 NO. INZHINIERI: Edvin DOKU
 NO. INZHINIERI: Mehmet SELLAU
 NO. INZHINIERI: Klement REXHEBI

Kapitulli: **PROJEKTI ARKITEKTONIK**

Titulli i Viteutit: PLANIMETRIA E PERGJITHSHME 1:500

Realizuar: QERSHOR 2022
 Skala: 1:500
 Eshfritimi i Fletës: **A4 - 03**

PLANIMETRIA E PERGJITHSHME, SH 1:500

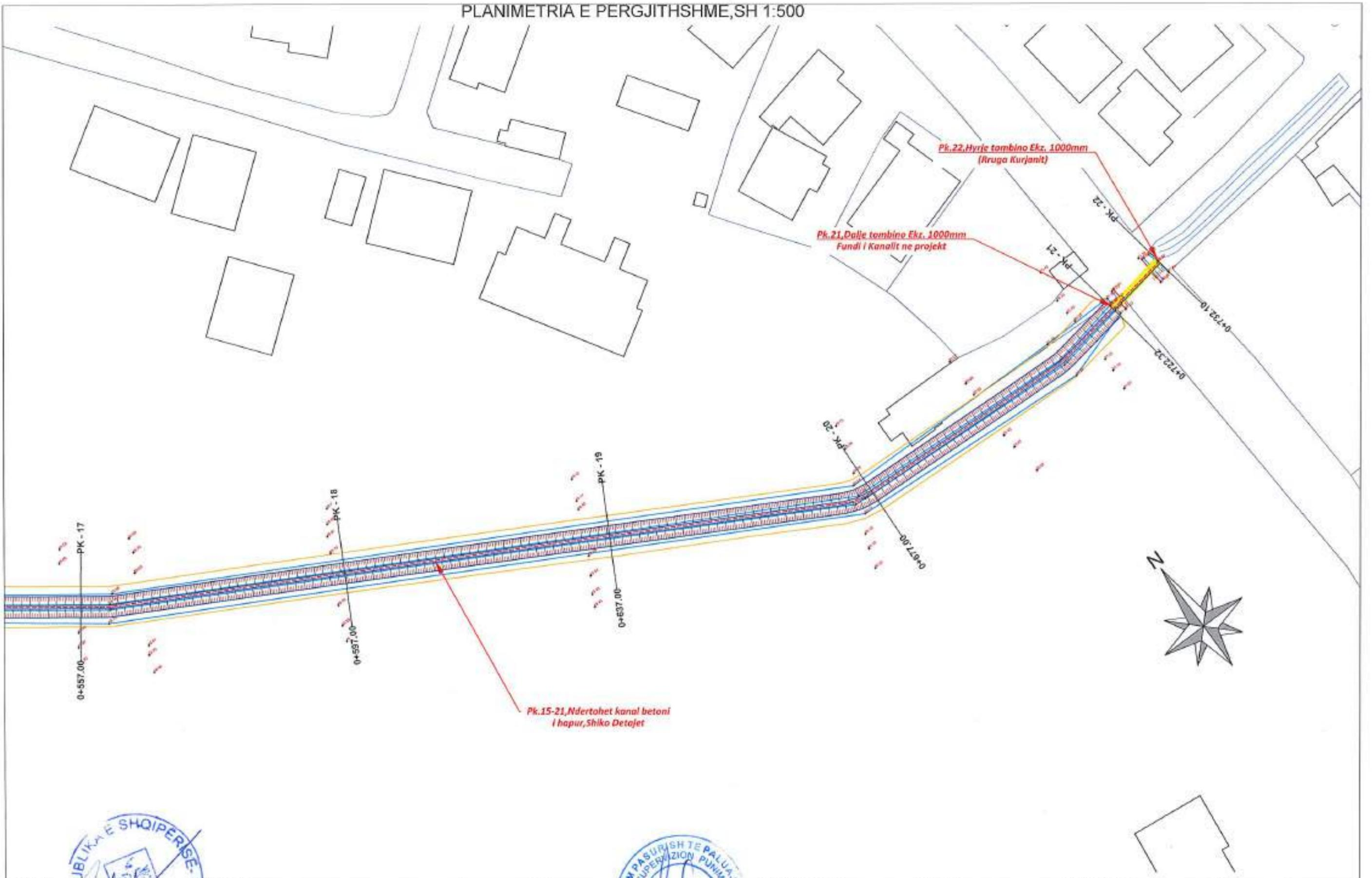

Porsebluac: Bashkia Roskovec	Vula: Bashkia Roskovec	Titulli i Projektit: RENABILITIMI URBAN I NJE PJESE TE BLOKUT NR.3 NE QENDER TE QYTETIT ROSKOVEC (FAZA NR 1) Responjenti: KANALI I UJRAVE TE LARTA
---------------------------------	---------------------------	---

Autor: "NOVATECH STUDIO" SHPK ADMIN ING. EMIL NOVA
--



Grupi projektues: NO. SHKURTESI: Miroslav NOVAK NO. SHKURTESI: Miroslav NOVAK NO. SHKURTESI: Miroslav NOVAK NO. SHKURTESI: Miroslav NOVAK NO. SHKURTESI: Miroslav NOVAK NO. SHKURTESI: Miroslav NOVAK NO. SHKURTESI: Miroslav NOVAK NO. SHKURTESI: Miroslav NOVAK NO. SHKURTESI: Miroslav NOVAK NO. SHKURTESI: Miroslav NOVAK

Kapiteti: PROJEKTI ARKITEKTONIK

Titulli i Vlastetit: PLANIMETRIA E PERGJITHSHME 1:500
--

Realizues: QERRHOR 2022	E shkalla: 1:500
Emblirani i Fletës: A4 - 04	

PROFILI GJATESOR I KANALIT KULLUES

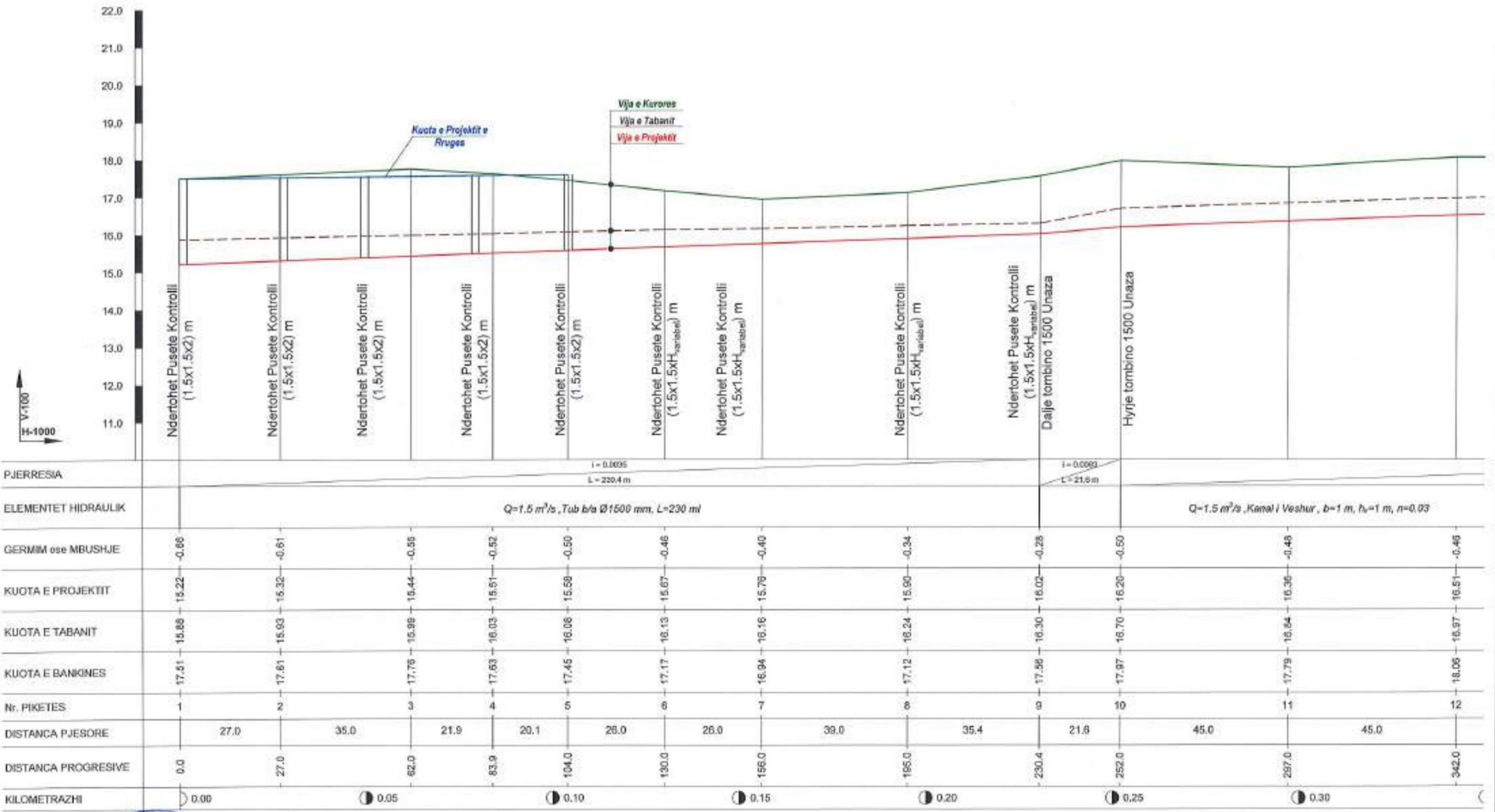

PROFILI GJATESOR I KANALIT KULLUES

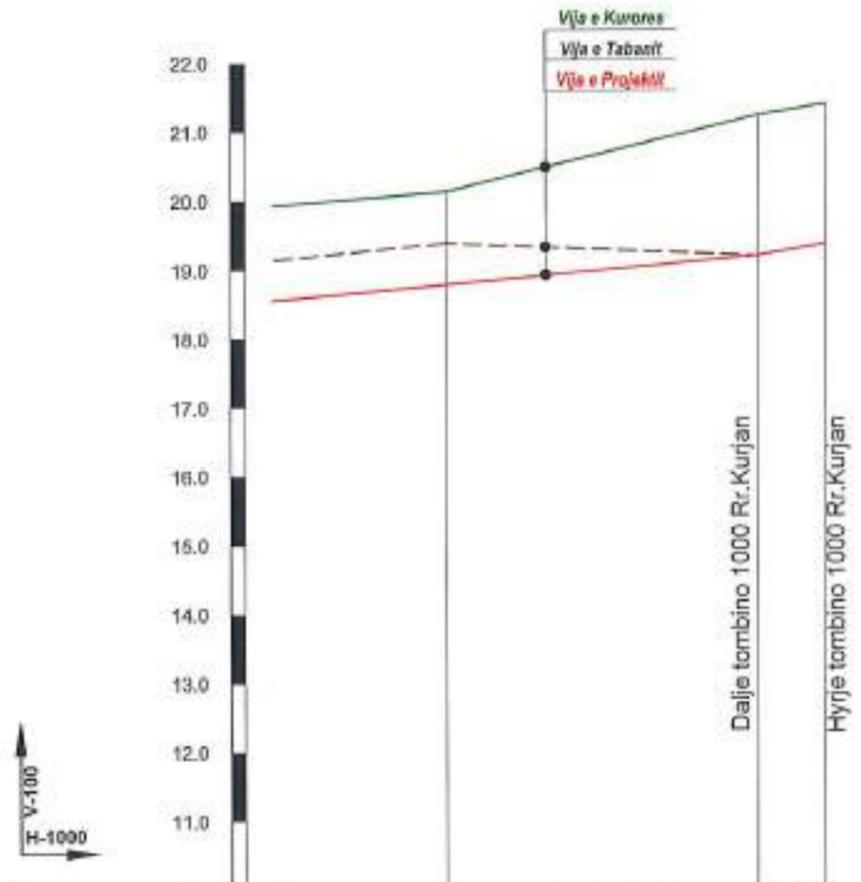

PROFIL TIP
PK.10-15, L=228.1 ml
SH.1:50

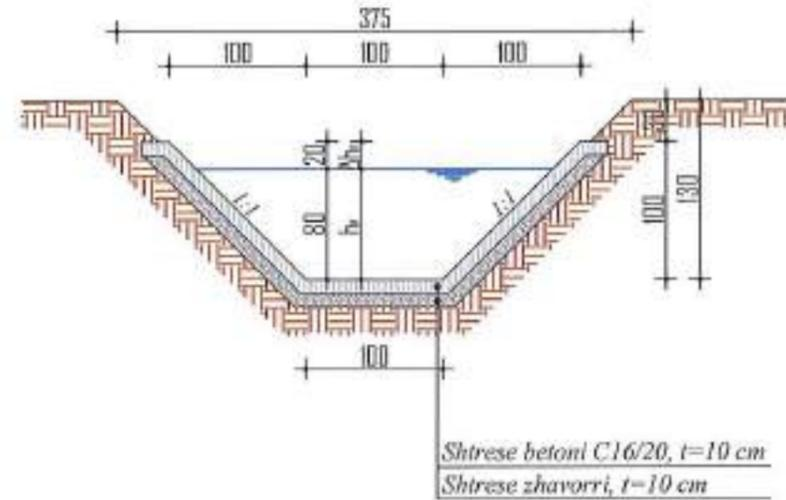

PROFIL TIP PK.15-21,
L=242.2 ml
SH.1:50

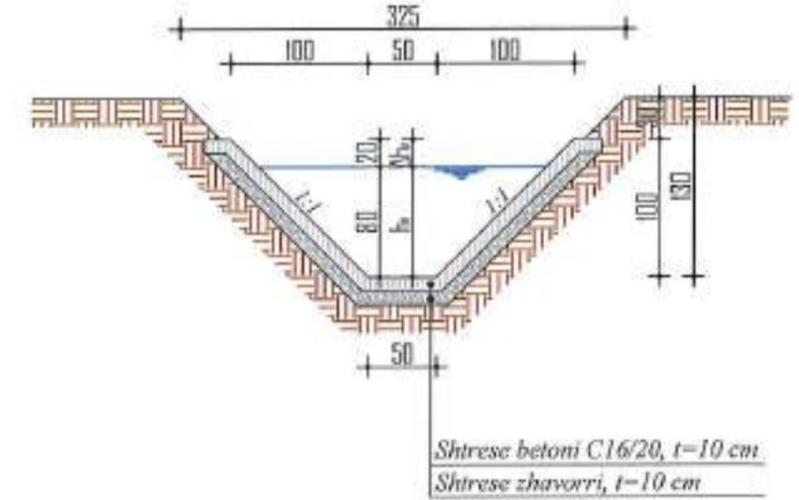

PJERRESIA	0.0139 9.8		
ELEMENTET HIDRAULIK	Q=1.5 m ³ /s, Kanal i Veshur, b=0.5 m, h _v =1 m, n=0.03		
GERMIM ose MBUSHJE	-0.60	0.00	0.00
KUOTA E PROJEKTIIT	18.79	19.20	19.37
KUOTA E TABANIT	18.38	19.20	19.37
KUOTA E BANKINES	20.74	21.24	21.40
Nr. PIKETES	20	21	22
DISTANCA PJESORE	40.0	45.3	9.8
DISTANCA PROGRESIVE	677.0	722.3	732.1
KILOMETRAZHI	+ 0.65	0.70	
SHENIME			

SHENIME TEKNIKE :

- Projekti ka parashikuar veshje te kanalit nga Pk.10-21.
- Para fillimit te mbushjeve me dhe ne kanal te behet me pare skarifikimi i siperfaqeve ekzistuese me nje thellesi jo me pak se 10 cm.
- Mbushjet me dhe per formimin e seksionit te kanalit do te behen me shtresa cdo 15 cm duke ngjeshur dheun me tokmak.
- Veshjet me beton te kanalit do te behen me kampata me gjatesi jo me shume se 5 m (50 x t), ku t-ja eshte trashesia e veshjes se betonit e shprehur ne cm.
- Midis dy kampatave lihet fuge deletacioni me trashesi 2cm e mbushur me llac-cimento M-50, betonimi i cdo kampate behet pa nderpreje.
- Ne llogaritjen e volumit te germimit per riseksionim kanali eshte perfshire edhe volumi i dherave qe gerohen per vendosjen e shtreses se betonit.
- Gjate zbatimit te punimeve vazhdimisht te shikohet profili gjatesor i projektit.
- Ne llogaritjen e volumeve te betonit eshte marre parasysh edhe ndryshimi i bazes kur ajo ndryshon nga seksioni tip i kanalit.

 ASHKIA RSKOVEC	 BASHKIA E ROSHKOVEC	Autor "NOVATECH STUDIO" SHPK ADMIN ING. EMIL NOVA	 NOVATECH STUDIO SH.p.k.	Drejti projektimit: ING. JERONIM MERO ING. KOSTA MERO ING. MARIJANA MERO ING. MARIJANA MERO ING. MARIJANA MERO ING. MARIJANA MERO ING. MARIJANA MERO ING. MARIJANA MERO ING. MARIJANA MERO ING. MARIJANA MERO	Skala: 1:1000 1:100	Titulli i Veprimit: PROFILI GJATESOR PROFILA TIP	Reshtuar: QERSHOR 2022 Kontrollimi i Pictes	Skalla: 1:1000 1:100
				Projekti: PROJEKTI ARKITEKTONIK	A4 - 08			

PROFILE TERTHORE

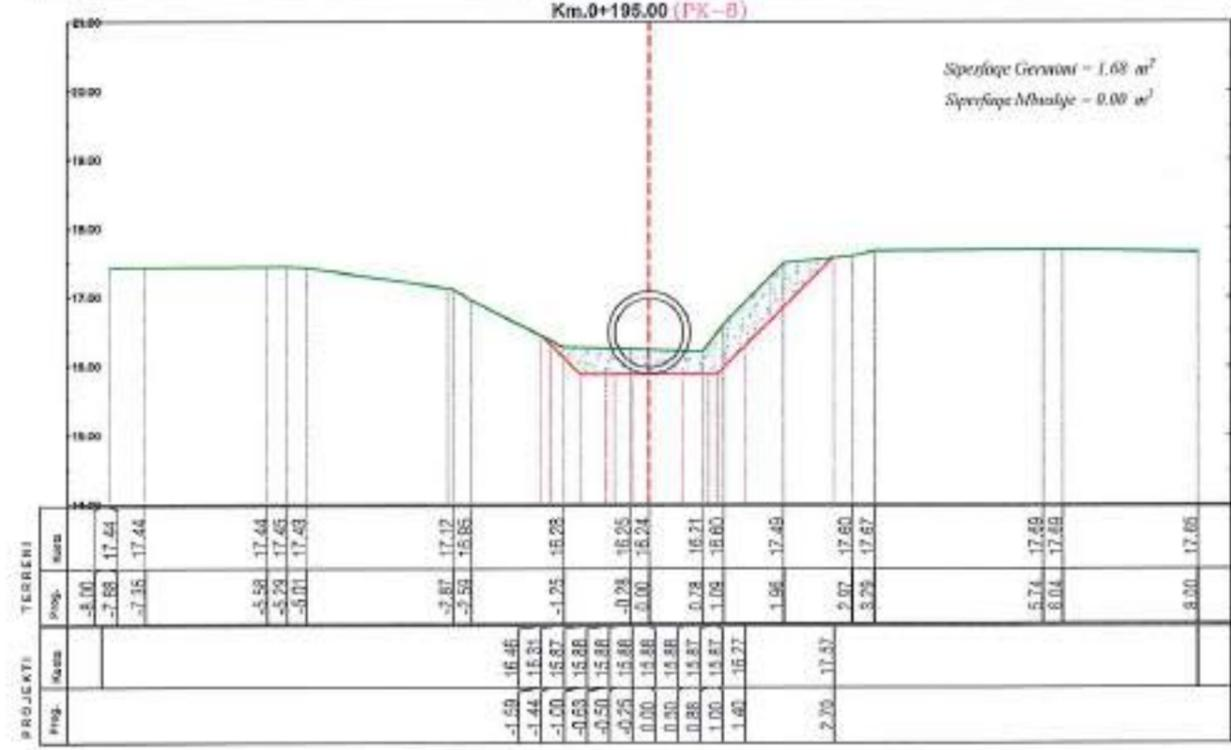
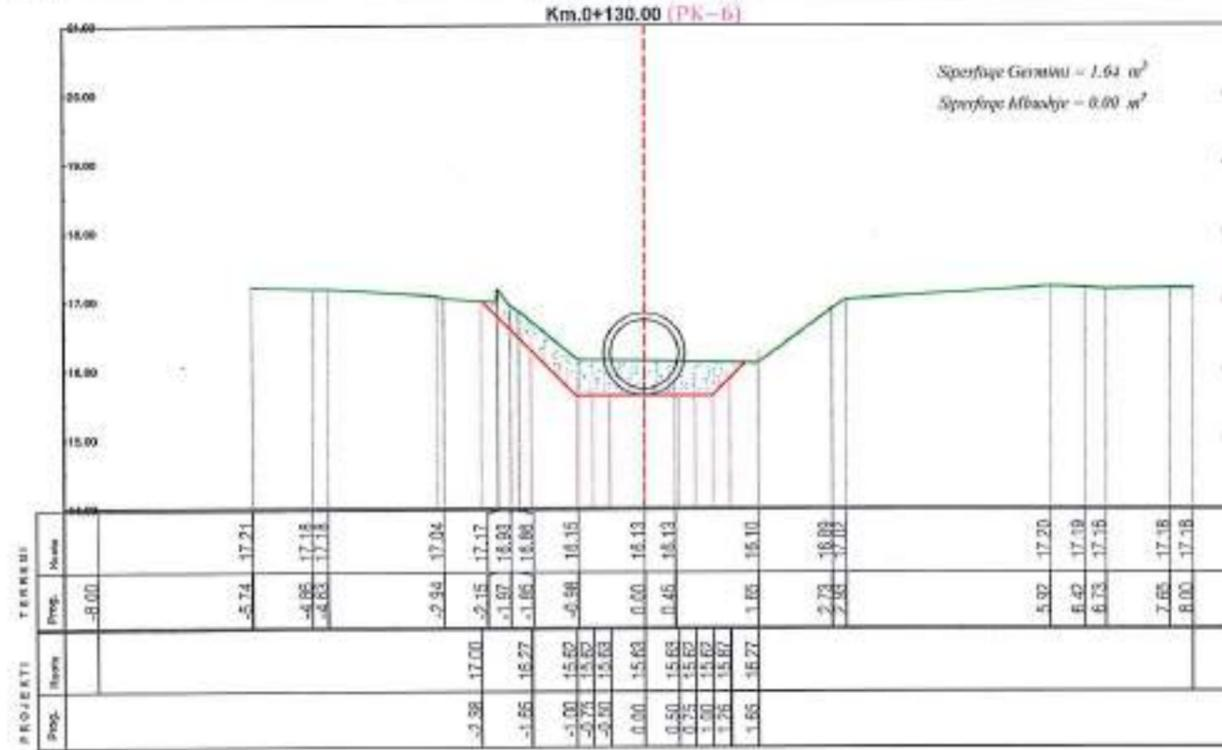
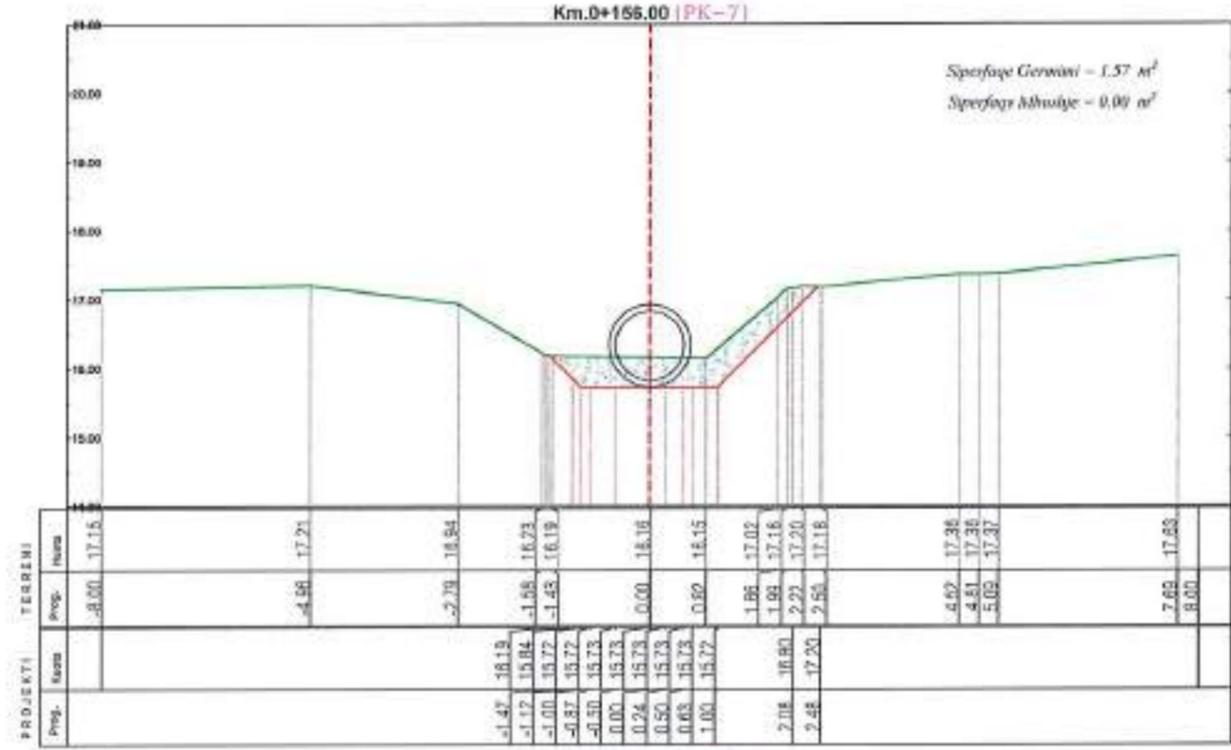
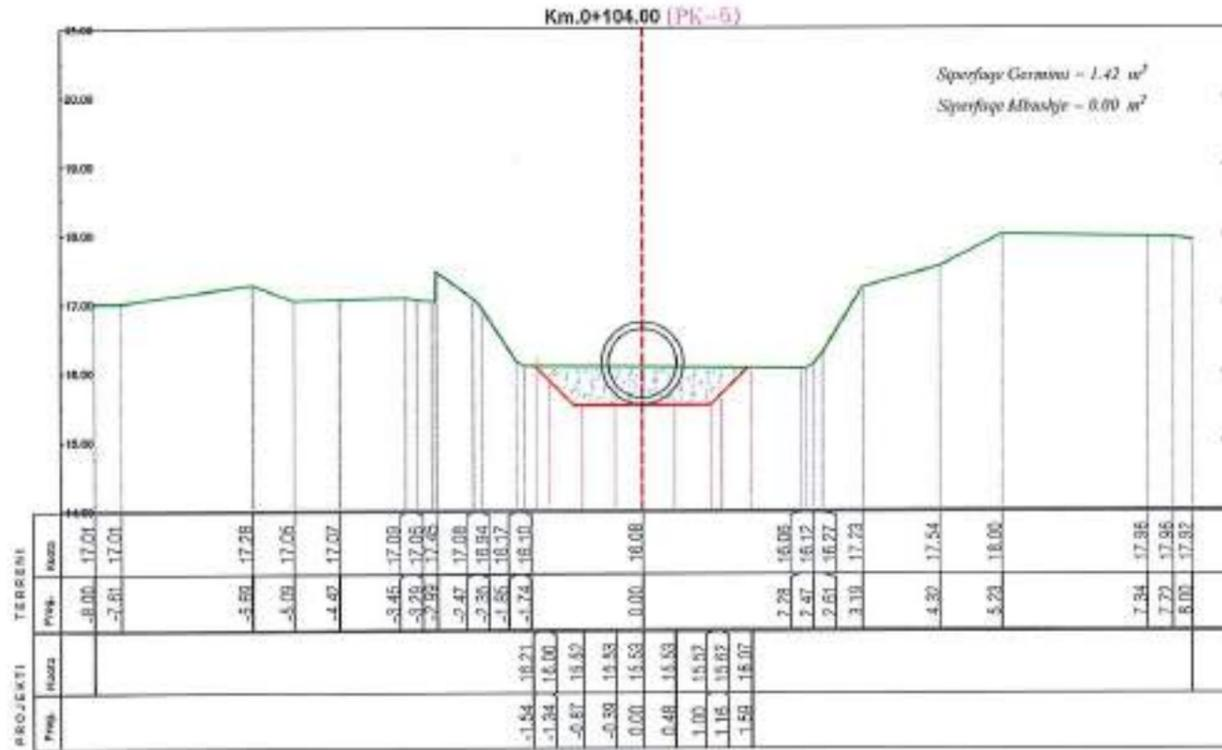

Përcaktues: BASHKIA ROSKOVEC	Titulli i Projektit: REHABILITIMI URBAN I NJE PJESE TE BULEVUT NR.3 NE QENDER TE QYLLIAT ROSKOVEC (FAZA NR 1) Kategoria i Ujrave te Larta	Autor: "NOVATECH STUDIO" SHPK ADMIN ING. EMIL NOVA	Organi përcaktues: (List of officials and titles)	Kapitulli: PROJEKTI ARKITEKTONIK	Titulli i Vazhimit: PROFILE TERTHORE	Revizues: QERSHOR 2022	Shkalla: 1:100
						Kufomat i Plote: A4 - 10	

PROFILE TERTHORE

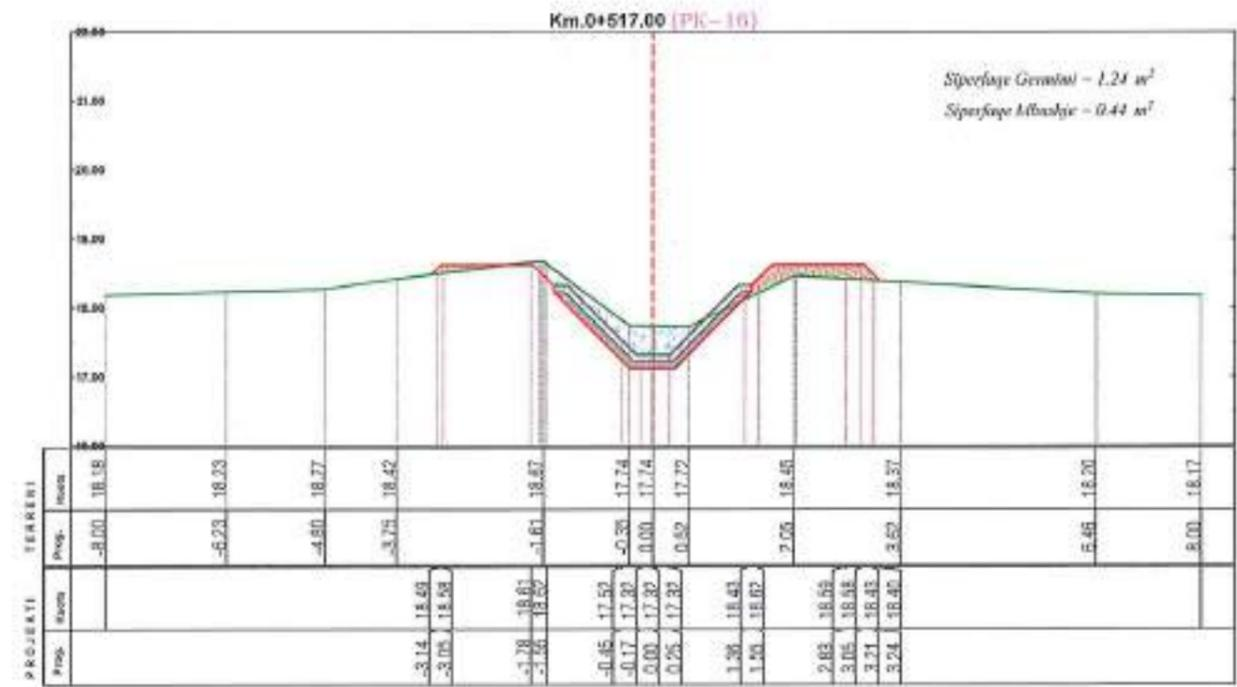
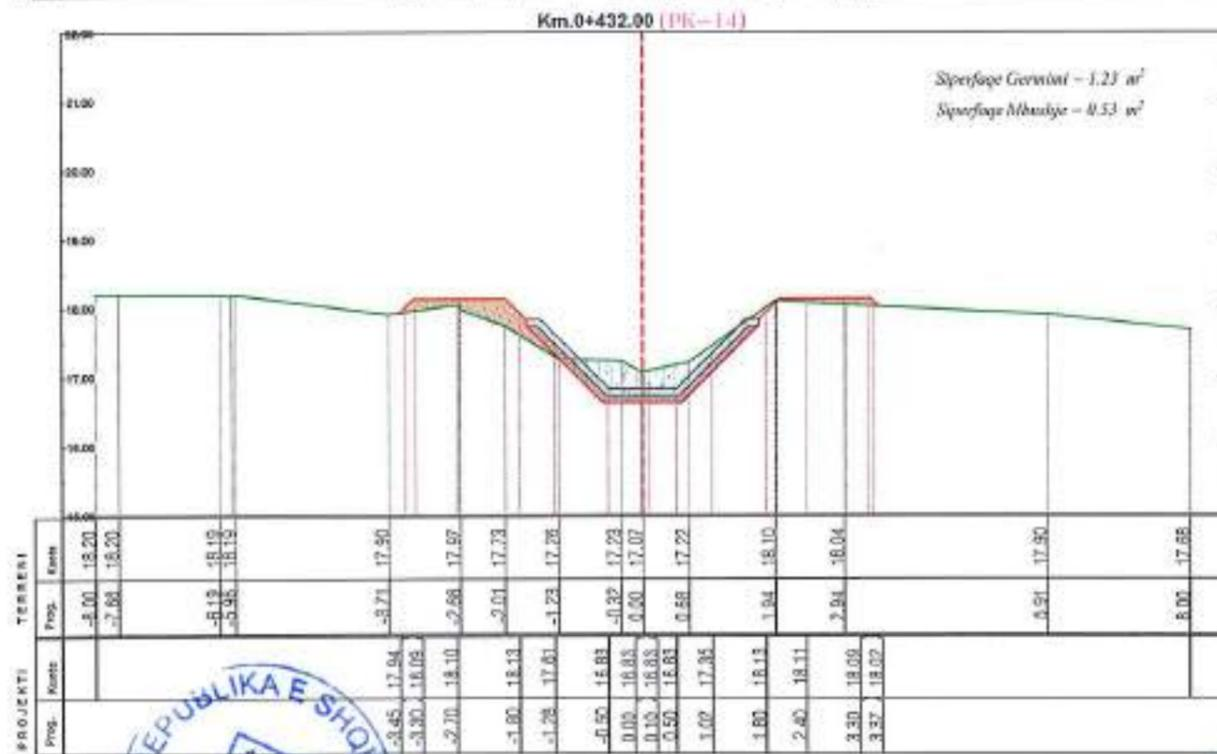
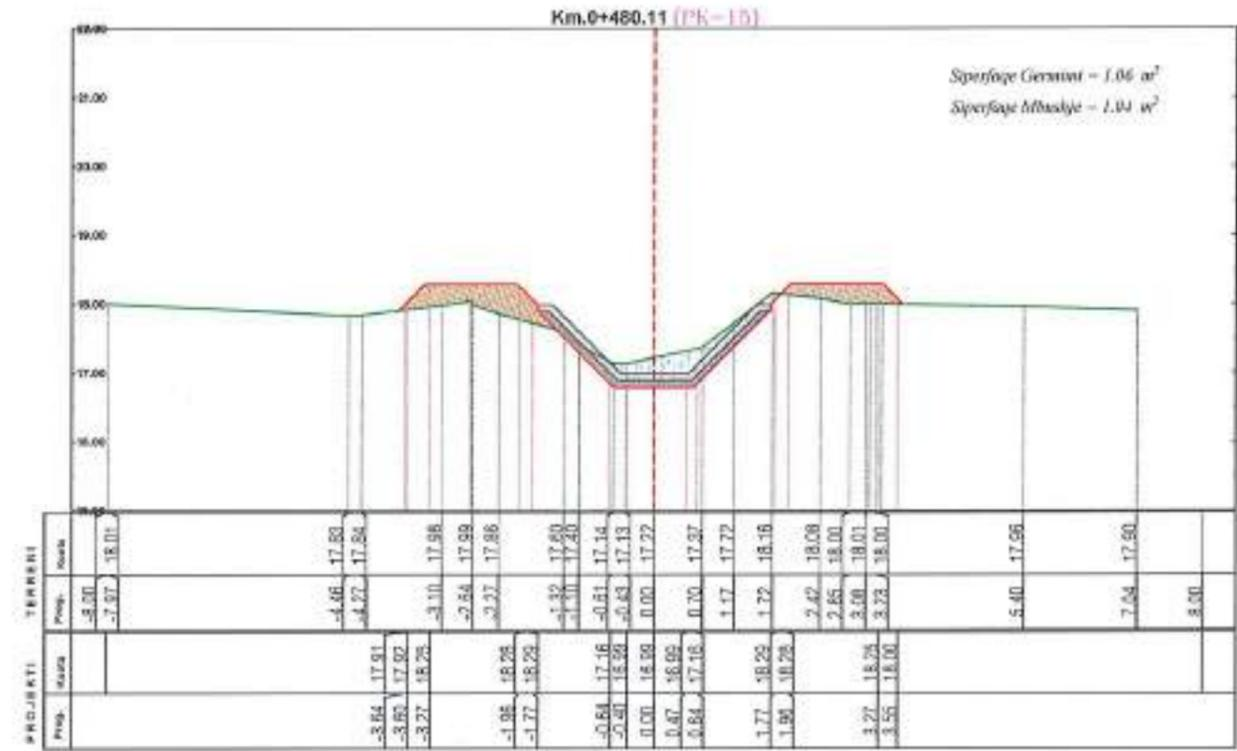
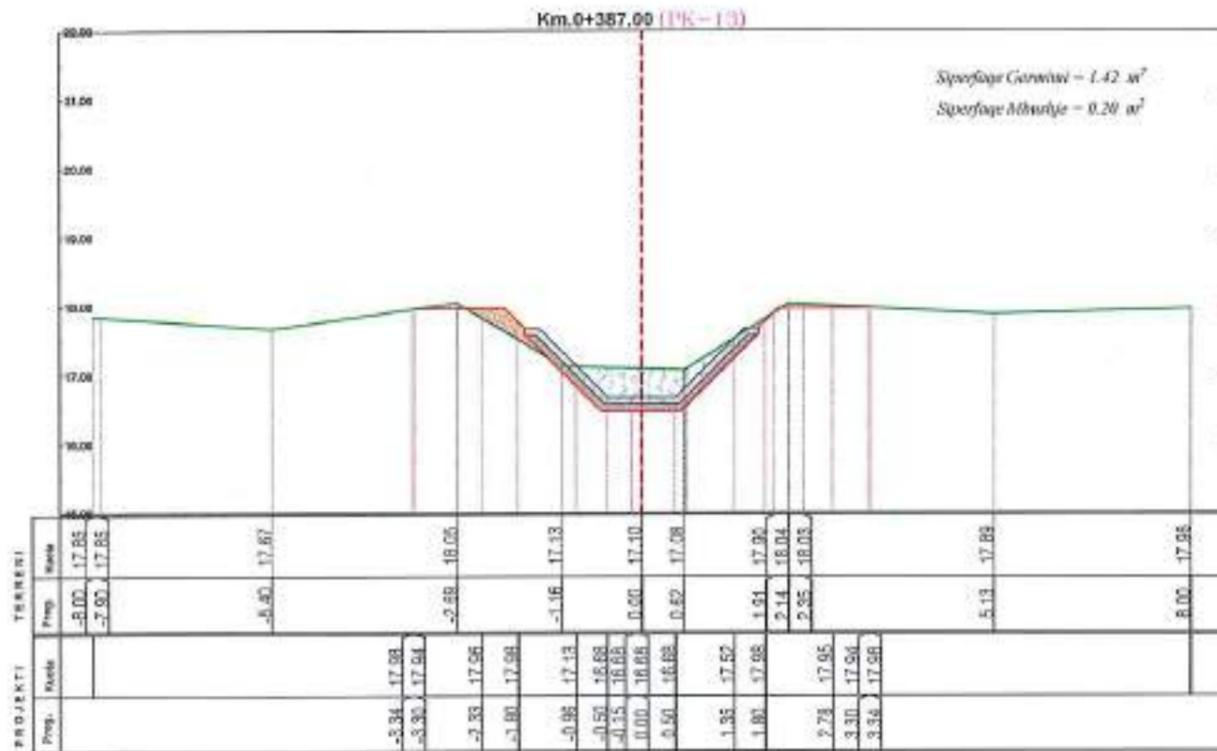

BASHKIA ROSKOVEC



Titulli i Projektit
**REHABILITIMI URRAN I NJE PJESE
 TE BILLOKUT NR.3 NE QENDER TE
 QUTETIT ROSKOVEC (FAZA NR.1)**
 Kanali i Urrave te Larta

Autor
'NOVATECH STUDIO' SHPK
ADMIR ING. KRIL NOVA



Grupi projektant:
 SHK. NOVIUM
 SHK. NOVINA
 SHK. NOVORAMA
 SHK. NOVODRAMA
 SHK. NOVODRAMA
 SHK. NOVODRAMA
 SHK. NOVODRAMA
 SHK. NOVODRAMA

PROJEKTI
ARKITEKTONIK

Titulli i Viteutit
PROFILE TERTHORE

Realizuar
QESHOR 2022
 Shkalla
1:100
A4 - 12

