

# PROJEKT ZBATIM

## PROJEKTI ARKITEKTONIK

OBJEKTI: STUDIM PROJEKTIM "NDËRTIMI I SHKOLLËS 9 VJEÇARE  
"EDIT DURHAM"



PROJEKTUES  
OE "INFRATECH" shpk

**INFRATECH**®

# PLANI I PIKETIMIT

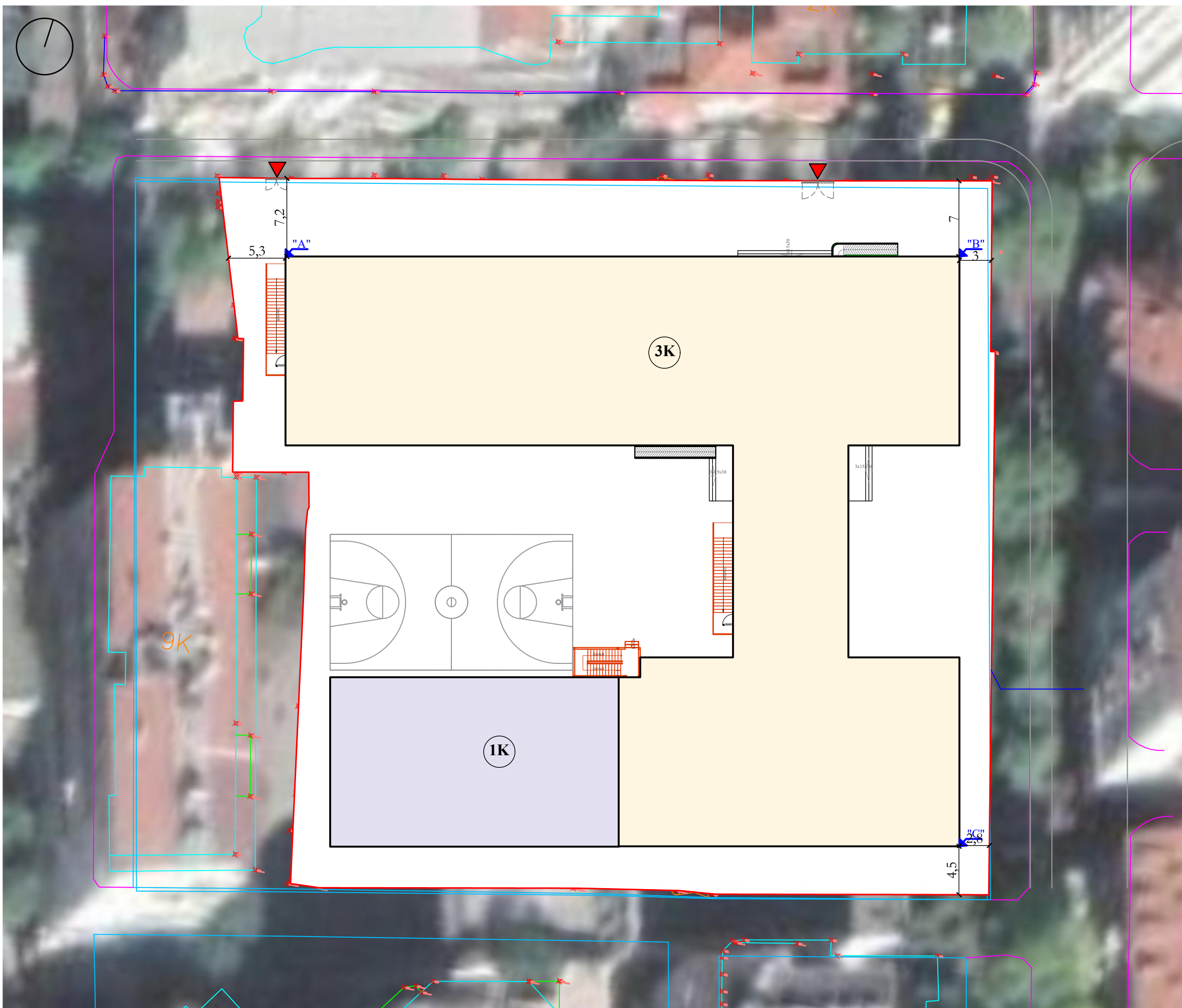

REPUBLIKA E SHQIPËRISË  
BASHKIA TIRANË



ZONA E PROJEKTIT



OBJEKTI: STUDIM PROJEKTIM "NDËRTIMI I SHKOLLËS  
9 VJEÇARE "EDIT DURHAM"

## PLANI I PIKETIMIT

FAZA PROJEKT ZBATIM	VITI 2024	NR.	A01
		SHKALLA	1:350
Ing. Hidroteknik	Filjana Veizaj	H/T.0110/9	
Arkitekt	Iva Mezezi	A.0831/4	
Ing. Ndertimi	Rafael Kote	H/T.0129/7	
Ing. Elektrik	Florjan Lame	E.1631	
Ing. Elektrik	Fatmira Shyti	E.0462/3	
Projektues	OE "INFRATECH" shpk		

**INFRATECH**  
Administrator  
Filjana Veizaj

# PLANI I ORGANIZIMIT TE PUNIMEVE

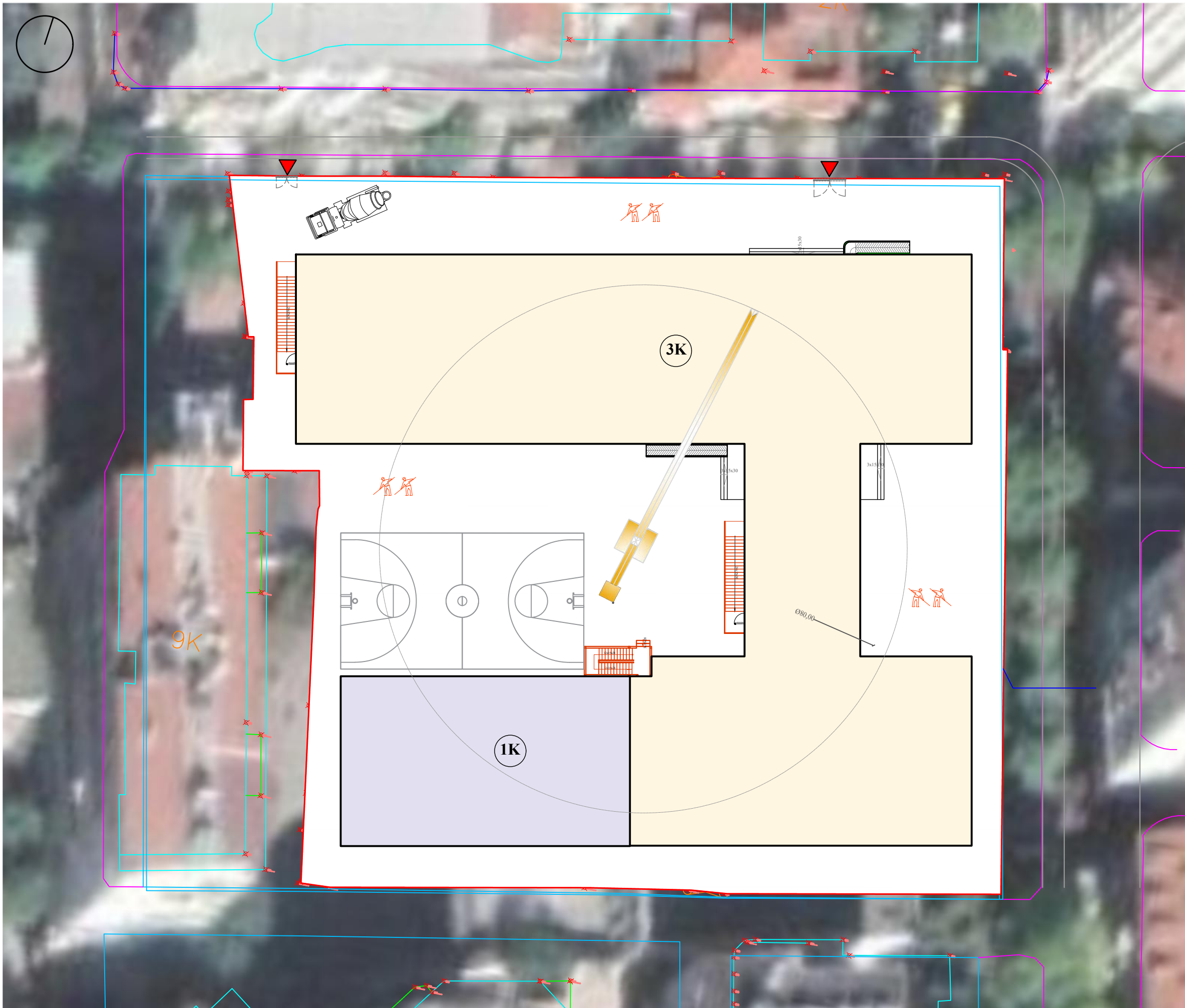

REPUBLIKA E SHQIPËRISË  
BASHKIA TIRANË



ZONA E PROJEKTIT



OBJEKTI: STUDIM PROJEKTIM "NDËRTIMI I SHKOLLËS  
9 VJEÇARE "EDIT DURHAM"

## PLANI I ORGANIZIMIT TE PUNIMEVE

FAZA PROJEKT ZBATIM	VITI 2024	NR. SHKALLA	A02 1:350
Ing. Hidroteknik	Filjana Veizaj	H/T.0110/9	
Arkitekt	Iva Mezezi	A.0831/4	
Ing. Ndertimi	Rafael Kote	H/T.0129/7	
Ing. Elektrik	Florjan Lame	E.1631	
Ing. Elektrik	Fatmira Shyti	E.0462/3	
Projektues	OE "INFRATECH" shpk		

**INFRATECH**  
Administrator  
Filjana Veizaj

# PLANVENDOSJE

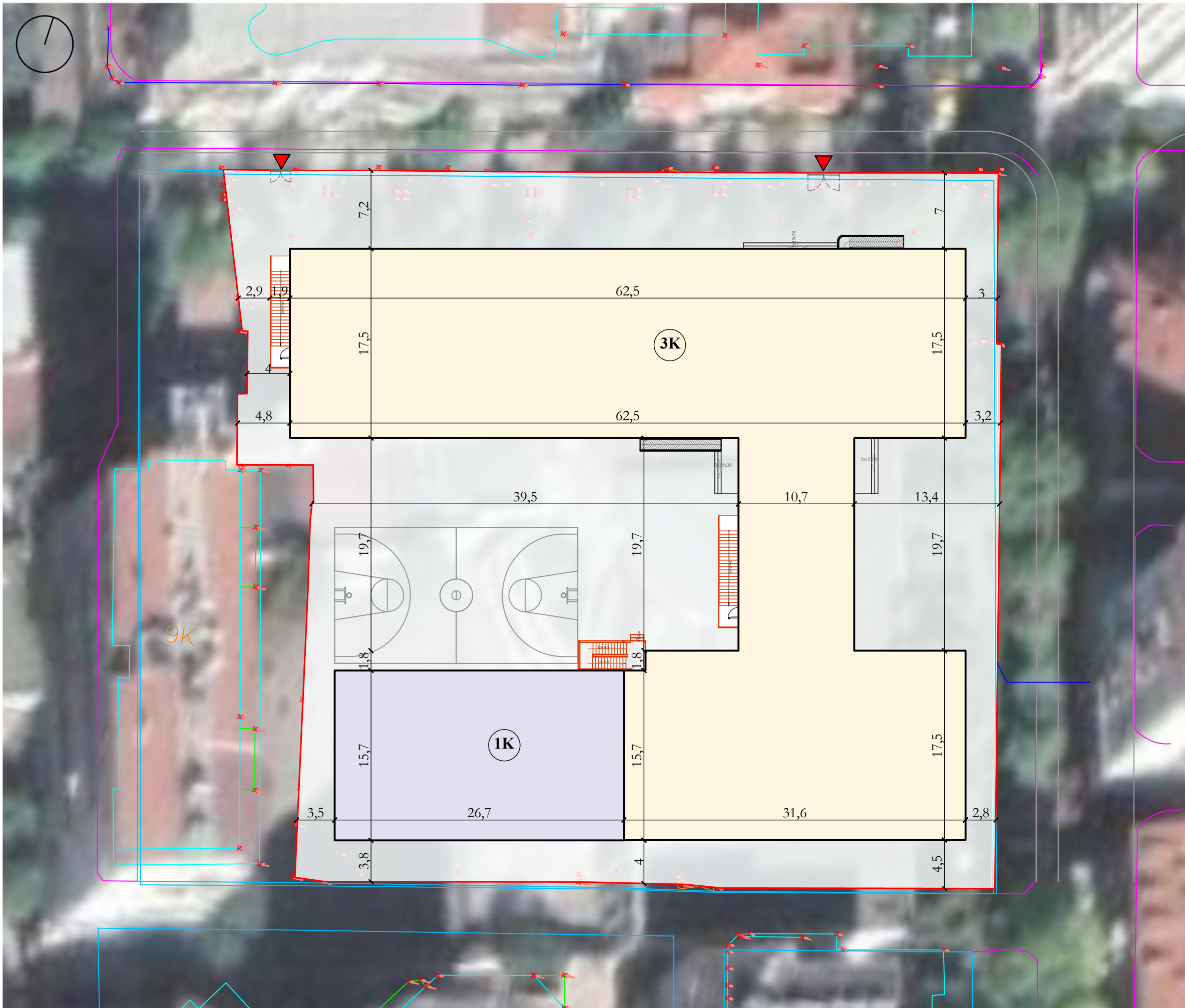

REPUBLIKA E SHQIPËRISË  
BASHKIA TIRANË



ZONA E PROJEKTIT

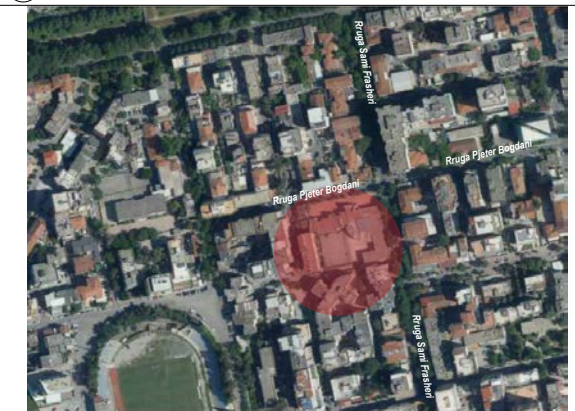

OBJEKTI: STUDIM PROJEKTIM "NDËRTIMI I SHKOLLËS  
9 VJEÇARE "EDIT DURHAM"

## PLANVENDOSJE

FAZA PROJEKT ZBATIM	VITI 2024	NR. SHKALLA	A03 1:350
Ing. Hidroteknik	Filjana Veizaj	H/T.0110/9	
Arkitekt	Iva Mezezi	A.0831/4	
Ing. Ndertimi	Rafael Kote	H/T.0129/7	
Ing. Elektrik	Florjan Lame	E.1631	
Ing. Elektrik	Fatmira Shyti	E.0462/3	
Projektues	OE "INFRATECH" shpk		

**INFRATECH**  
Administrator  
Filjana Veizaj

# PLANSISTEMIMI



REPUBLIKA E SHQIPËRISË  
BASHKIA TIRANË



ZONA E PROJEKTIT



OBJEKTI: STUDIM PROJEKTIM "NDËRTIMI I SHKOLLËS  
9 VJEÇARE "EDIT DURHAM"

## PLANSISTEMIMI

FAZA PROJEKT ZBATIM	VITI 2024	NR. SHKALLA	A04 1:350
Ing. Hidroteknik	Filjana Veizaj	H/T.0110/9	
Arkitekt	Iva Mezezi	A.0831/4	
Ing. Ndertimi	Rafael Kote	H/T.0129/7	
Ing. Elektrik	Florjan Lame	E.1631	
Ing. Elektrik	Fatmira Shyti	E.0462/3	
Projektues	OE "INFRA TECH" shpk		

**INFRA TECH**  
Administrator  
Filjana Veizaj

# PLANSISTEMIMI TEKNIK



REPUBLIKA E SHQIPËRISË  
BASHKIA TIRANË



ZONA E PROJEKTIT

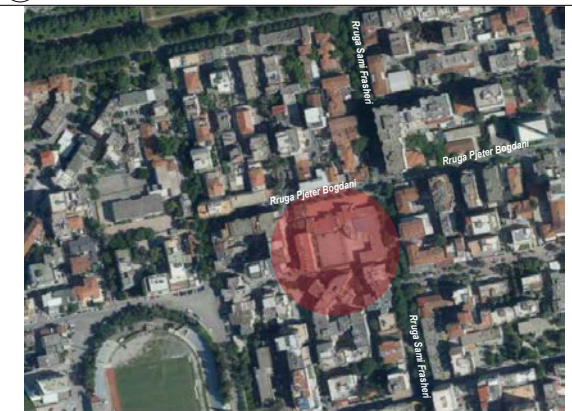

OBJEKTI: STUDIM PROJEKTIM "NDËRTIMI I SHKOLLËS  
9 VJEÇARE "EDIT DURHAM"

## PLANSISTEMIMI TEKNIK

FAZA PROJEKT ZBATIM	VITI 2024	NR. SHKALLA	A05 1:350
Ing. Hidroteknik	Filjana Veizaj	H/T.0110/9	
Arkitekt	Iva Mezezi	A.0831/4	
Ing. Ndertimi	Rafael Kote	H/T.0129/7	
Ing. Elektrik	Florjan Lame	E.1631	
Ing. Elektrik	Fatmira Shyti	E.0462/3	
Projektues	OE "INFRAËTECH" shpk		

**INFRAËTECH**  
Administrator  
Filjana Veizaj

# PLANI I MOBILIMIT I PODRUMIT

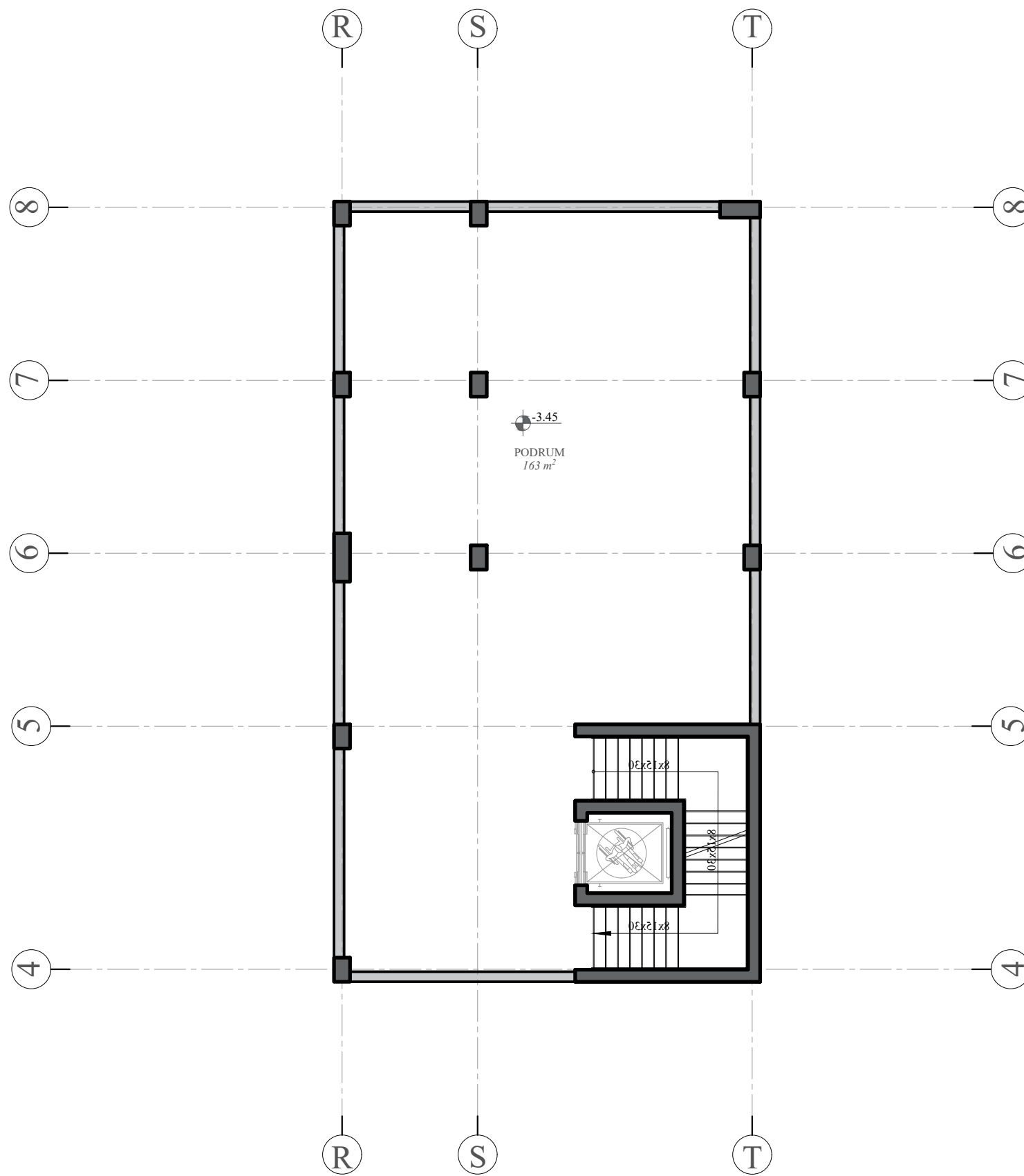
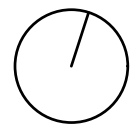

REPUBLIKA E SHQIPËRISË  
BASHKIA TIRANË



ZONA E PROJEKTIT



OBJEKTI: STUDIM PROJEKTIM "NDËRTIMI I SHKOLLËS  
9 VJEÇARE "EDIT DURHAM"

## PLANI I MOBILIMIT I PODRUMIT

FAZA PROJEKT ZBATIM	VITI 2024	NR. SHKALLA	A06 1:150
Ing. Hidroteknik	Filjana Veizaj	H/T.0110/9	
Arkitekt	Iva Mezezi	A.0831/4	
Ing. Ndertimi	Rafael Kote	H/T.0129/7	
Ing. Elektrik	Florjan Lame	E.1631	
Ing. Elektrik	Fatmira Shyti	E.0462/3	
Projektues	OE "INFRA TECH" shpk		

**INFRA TECH**  
Administrator  
Filjana Veizaj





# PLANI I MOBILIMIT I KATIT TE PARE

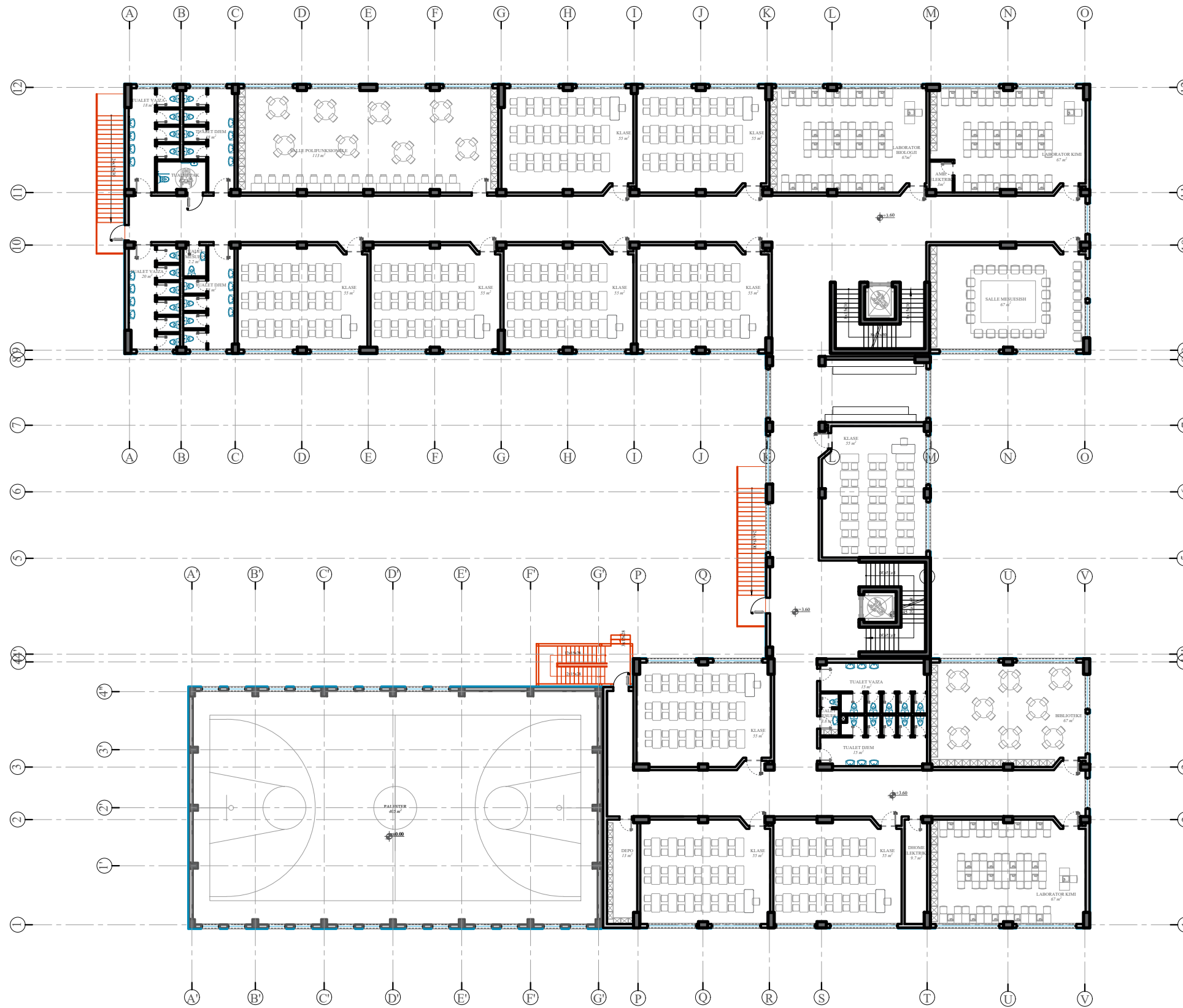
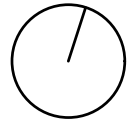

REPUBLIKA E SHQIPËRISË  
BASHKIA TIRANË



ZONA E PROJEKTIT

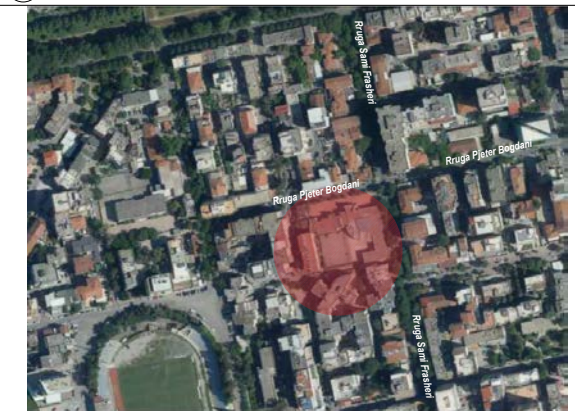

OBJEKTI: STUDIM PROJEKTIM "NDËRTIMI I SHKOLLËS  
9 VJEÇARE "EDIT DURHAM"

## PLANI I MOBILIMIT I KATIT TE PARE

FAZA PROJEKT ZBATIM	VITI 2024	NR. SHKALLA	A08 1:300
Ing. Hidroteknik	Filjana Veizaj	H/T.0110/9	
Arkitekt	Iva Mezezi	A.0831/4	
Ing. Ndertimi	Rafael Kote	H/T.0129/7	
Ing. Elektrik	Florjan Lame	E.1631	
Ing. Elektrik	Fatmira Shyti	E.0462/3	
Projektues	OE "INFRA TECH" shpk		

**INFRA TECH**  
Administrator  
Filjana Veizaj

# PLANI I MOBILIMIT I KATIT TE DYTE

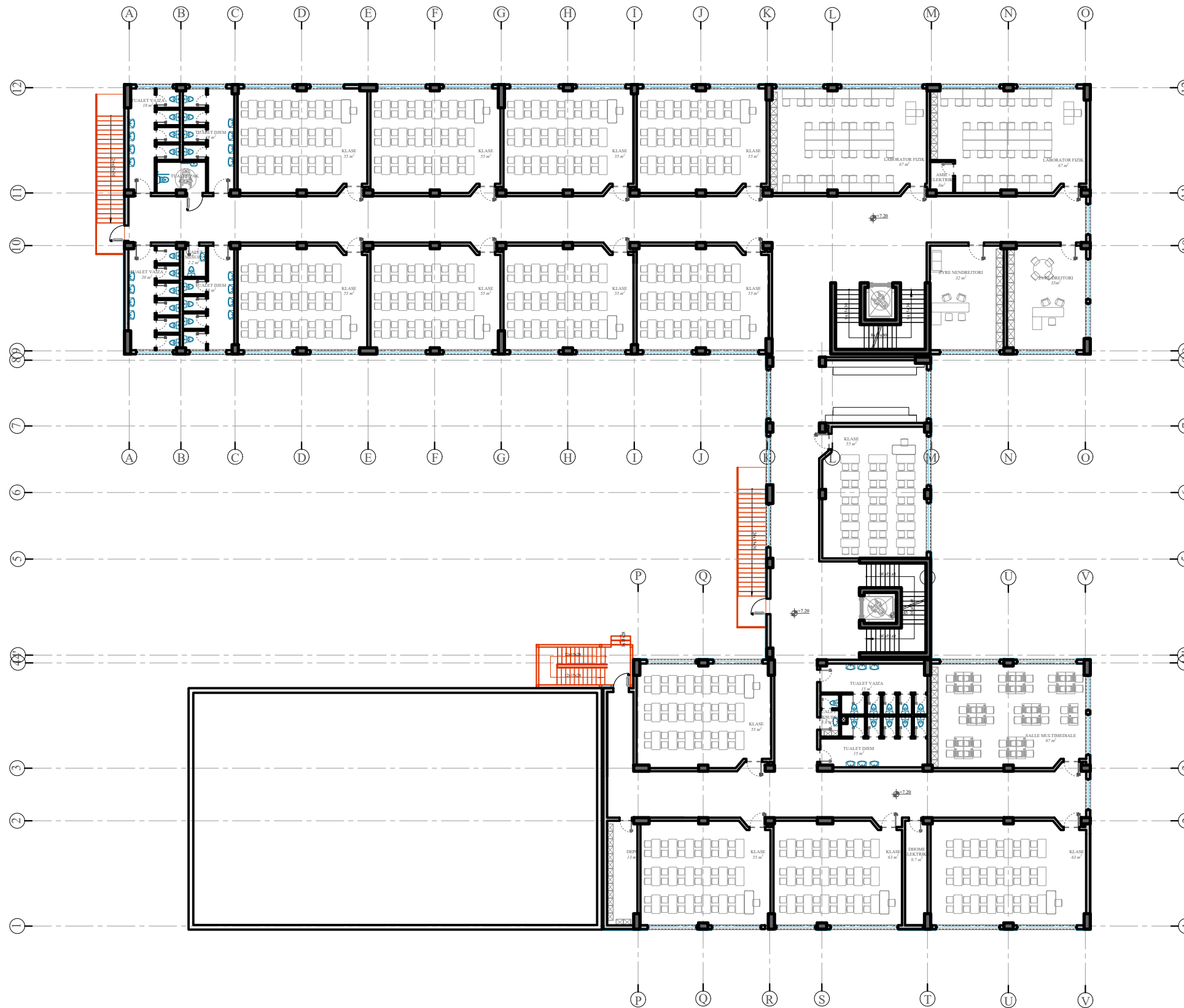
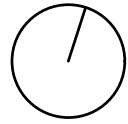

REPUBLIKA E SHQIPËRISË  
BASHKIA TIRANË



OBJEKTI: STUDIM PROJEKTIM "NDËRTIMI I SHKOLLËS 9 VJEÇARE "EDIT DURHAM"

## PLANI I MOBILIMIT I KATIT TE DYTE

FAZA PROJEKT ZBATIM	VITI 2024	NR. SHKALLA	A09 1:300
Ing. Hidroteknik	Filjana Veizaj	H/T.0110/9	
Arkitekt	Iva Mezezi	A.0831/4	
Ing. Ndertimi	Rafael Kote	H/T.0129/7	
Ing. Elektrik	Florjan Lame	E.1631	
Ing. Elektrik	Fatmira Shyti	E.0462/3	
Projektues	OE "INFRA TECH" shpk		

**INFRA TECH**  
Administrator  
Filjana Veizaj

# PLANI TEKNIK I PODRUMIT

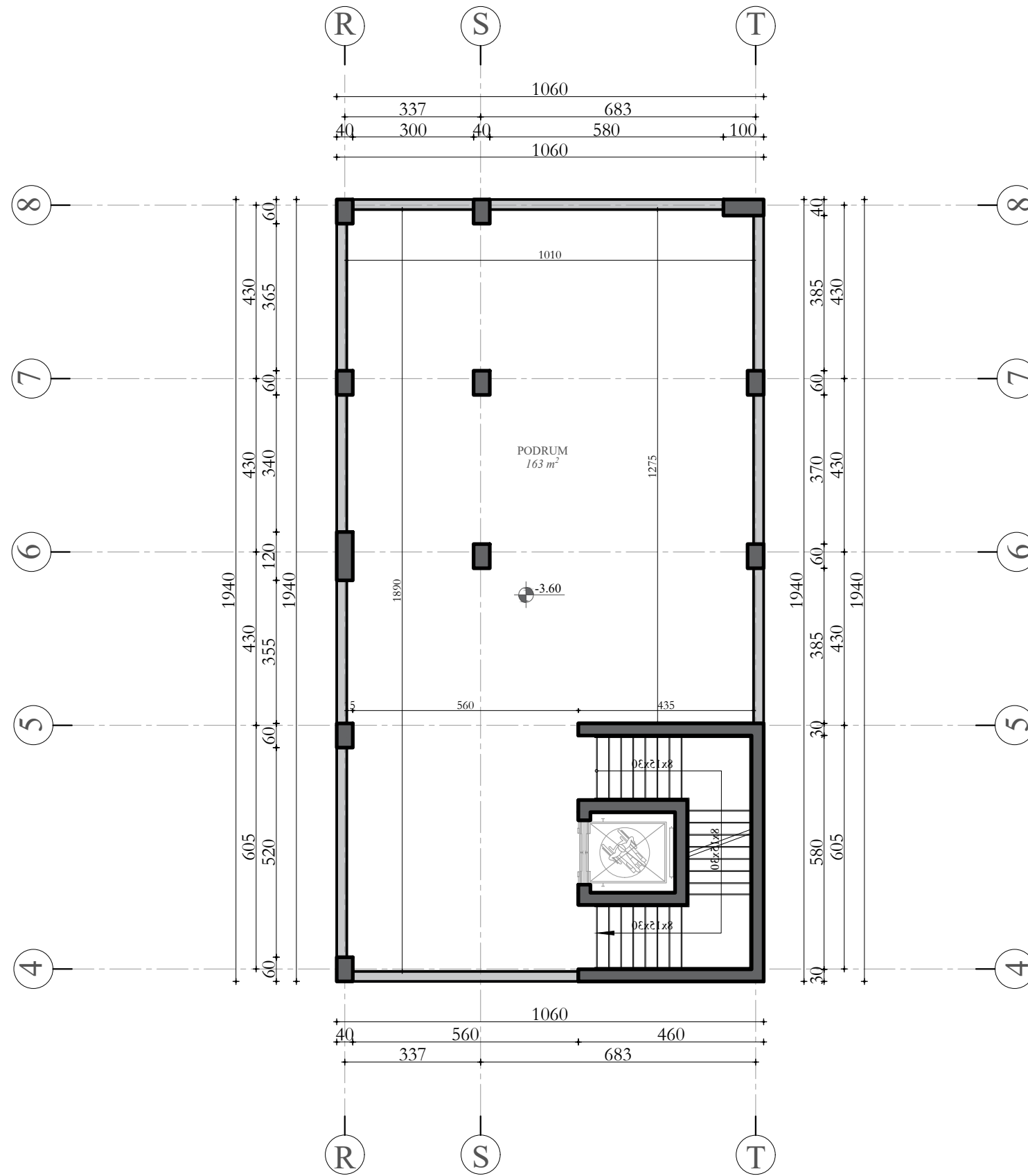
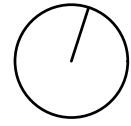

REPUBLIKA E SHQIPËRISË  
BASHKIA TIRANË



ZONA E PROJEKTIT

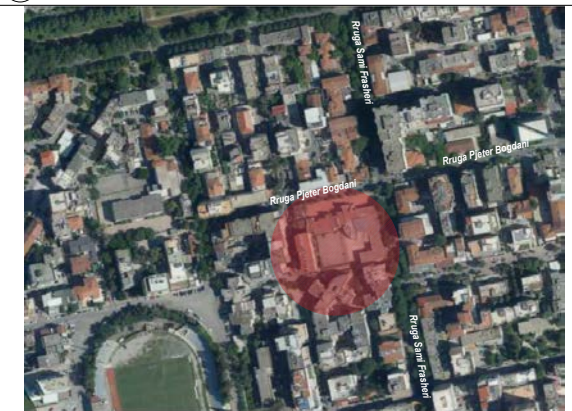

OBJEKTI: STUDIM PROJEKTIM "NDËRTIMI I SHKOLLËS  
9 VJEÇARE "EDIT DURHAM"

## PLANI TEKNIK I PODRUMIT

FAZA PROJEKT ZBATIM	VITI 2024	NR. SHKALLA	A10 1:150
Ing. Hidroteknik	Filjana Veizaj	H/T.0110/9	
Arkitekt	Iva Mezezi	A.0831/4	
Ing. Ndertimi	Rafael Kote	H/T.0129/7	
Ing. Elektrik	Florjan Lame	E.1631	
Ing. Elektrik	Fatmira Shyti	E.0462/3	
Projektues	OE "INFRATECH" shpk		

**INFRATECH**  
Administrator  
Filjana Veizaj



# PLANI TEKNIK I KATIT TE PARE

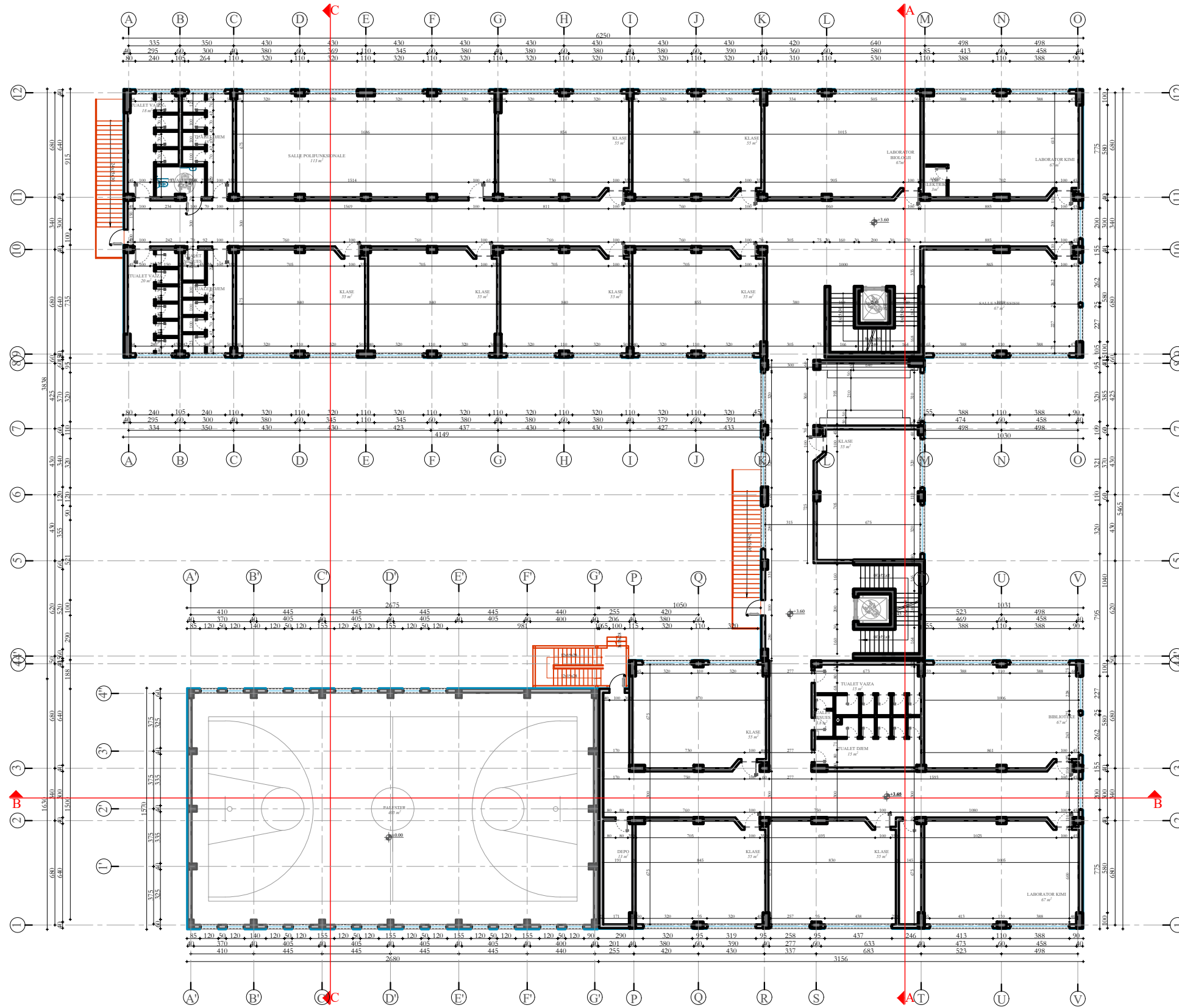
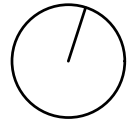

REPUBLIKA E SHQIPËRISË  
BASHKIA TIRANË



ZONA E PROJEKTIT

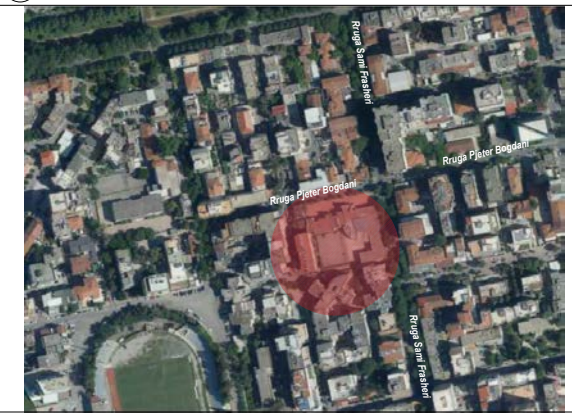

OBJEKTI: STUDIM PROJEKTIM "NDËRTIMI I SHKOLLËS  
9 VJEÇARE "EDIT DURHAM"

## PLANI TEKNIK I KATIT TE PARE

FAZA PROJEKT ZBATIM	VITI 2024	NR. SHKALLA	A12 1:300
Ing. Hidroteknik	Filjana Veizaj	H/T.0110/9	
Arkitekt	Iva Mezezi	A.0831/4	
Ing. Ndertimi	Rafael Kote	H/T.0129/7	
Ing. Elektrik	Florjan Lame	E.1631	
Ing. Elektrik	Fatmira Shyti	E.0462/3	
Projektues	OE "INFRA TECH" shpk		

**INFRA TECH**  
Administrator  
Filjana Veizaj

# PLANI TEKNIK I KATIT TE DYTE

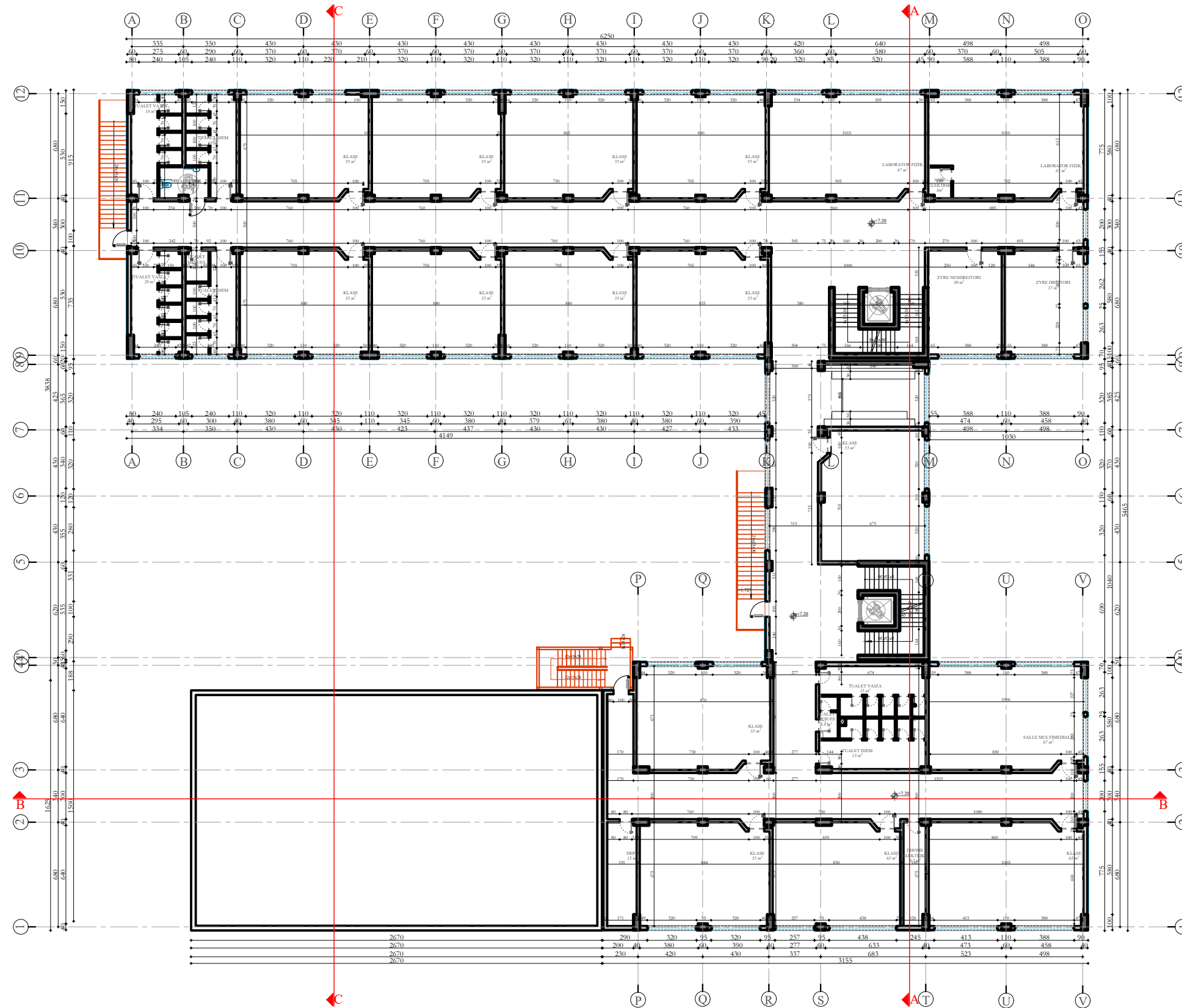
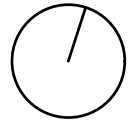

REPUBLIKA E SHQIPËRISË  
BASHKIA TIRANË



OBJEKTI: STUDIM PROJEKTIM "NDËRTIMI I SHKOLLËS  
9 VJEÇARE "EDIT DURHAM"

## PLANI TEKNIK I KATIT TE DYTE

FAZA PROJEKT ZBATIM	VITI 2024	NR. SHKALLA	A13 1:300
Ing. Hidroteknik	Filjana Veizaj	H/T.0110/9	
Arkitekt	Iva Mezezi	A.0831/4	
Ing. Ndertimi	Rafael Kote	H/T.0129/7	
Ing. Elektrik	Florjan Lame	E.1631	
Ing. Elektrik	Fatmira Shyti	E.0462/3	
Projektues	OE "INFRA TECH" shpk		

**INFRA TECH**  
Administrator  
Filjana Veizaj

# PLANI I MBULIMIT

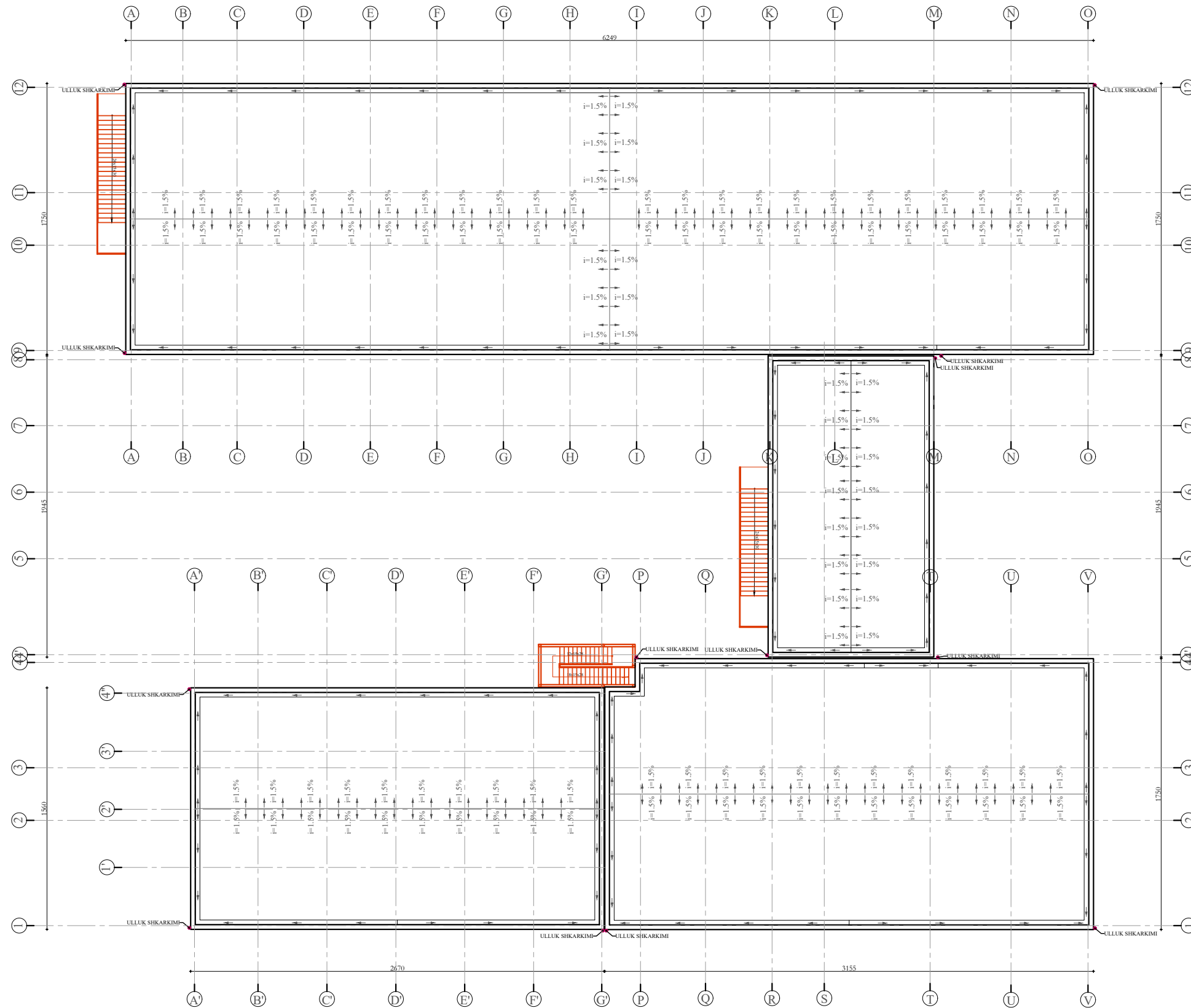
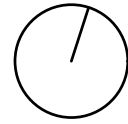

REPUBLIKA E SHQIPËRISË  
BASHKIA TIRANË



ZONA E PROJEKTIT



OBJEKTI: STUDIM PROJEKTIM "NDËRTIMI I SHKOLLËS 9 VJEÇARE "EDIT DURHAM"

## PLANI I MBULIMIT

FAZA PROJEKT ZBATIM	VITI 2024	NR. SHKALLA	A14 1:300
Ing. Hidroteknik	Filjana Veizaj	H/T.0110/9	
Arkitekt	Iva Mezezi	A.0831/4	
Ing. Ndertimi	Rafael Kote	H/T.0129/7	
Ing. Elektrik	Florjan Lame	E.1631	
Ing. Elektrik	Fatmira Shyti	E.0462/3	
Projektues	OE "INFRA TECH" shpk		

**INFRA TECH**  
Administrator  
Filjana Veizaj

# PLANI I RIFINITURES I PODRUMIT

Shttrim me pllaka gres porcelan mat me dimensione 40x40 cm.

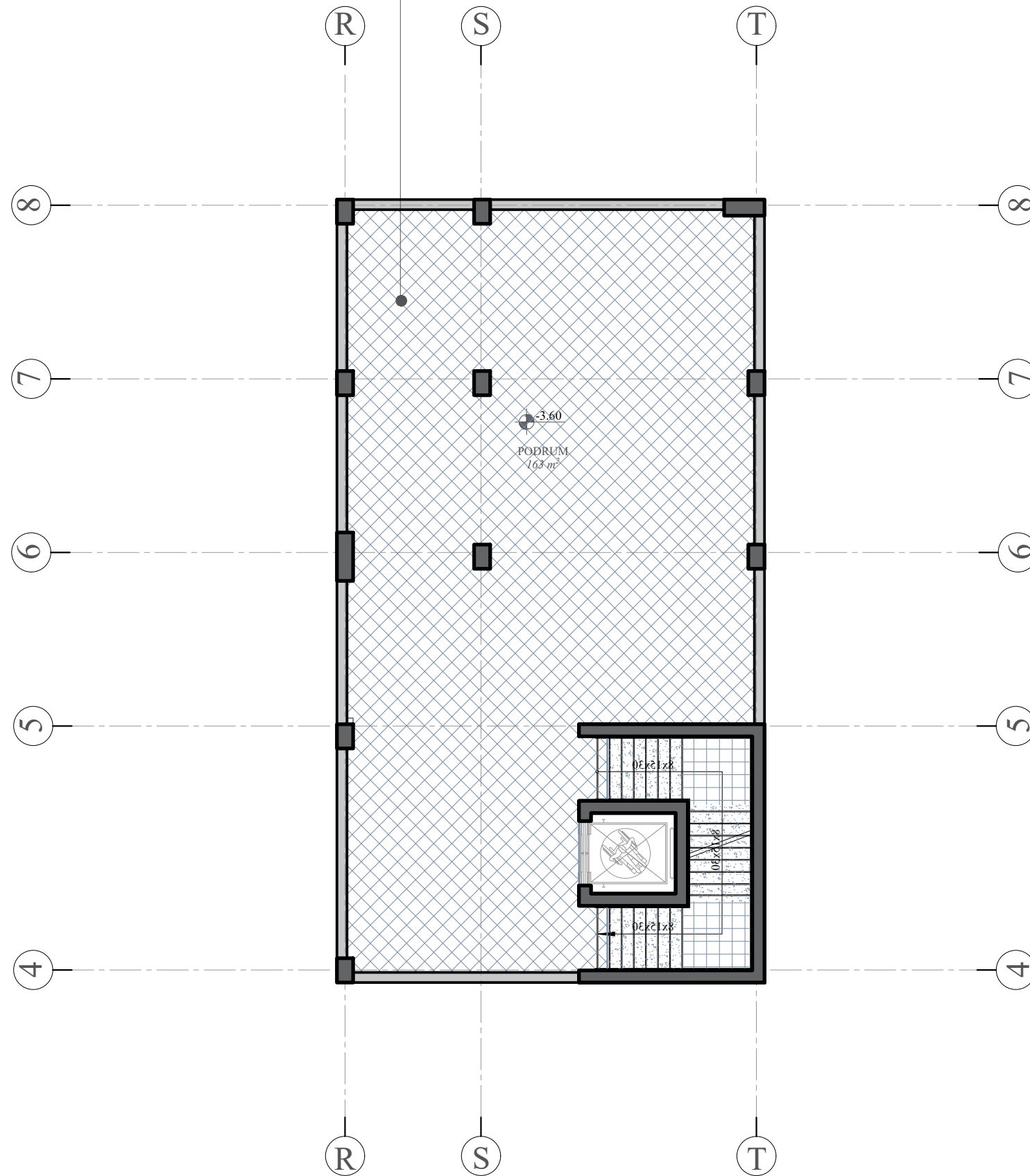

REPUBLIKA E SHQIPËRISË  
BASHKIA TIRANË



ZONA E PROJEKTIT

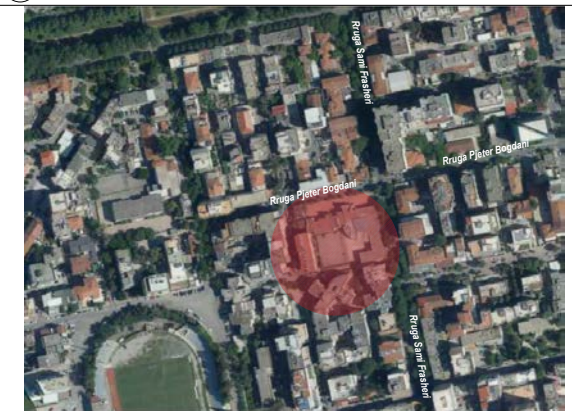

OBJEKTI: STUDIM PROJEKTIM "NDËRTIMI I SHKOLLËS 9 VJEÇARE "EDIT DURHAM"

## PLANI I RIFINITURES I PODRUMIT

FAZA PROJEKT ZBATIM	VITI 2024	NR. SHKALLA	A15 1:150
Ing. Hidroteknik	Filjana Veizaj	H/T.0110/9	
Arkitekt	Iva Mezezi	A.0831/4	
Ing. Ndertimi	Rafael Kote	H/T.0129/7	
Ing. Elektrik	Florjan Lame	E.1631	
Ing. Elektrik	Fatmira Shyti	E.0462/3	
Projektues	OE "INFRATECH" shpk		

**INFRATECH**  
Administrator  
Filjana Veizaj



# PLANI I RIFINITURES I KATIT PERDHE

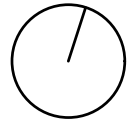

REPUBLIKA E SHQIPËRISË  
BASHKIA TIRANË



OBJEKTI: STUDIM PROJEKTIM "NDËRTIMI I SHKOLLËS 9 VJEÇARE "EDIT DURHAM"

## PLANI I RIFINITURES I KATIT PERDHE

FAZA PROJEKT ZBATIM	VITI 2024	NR. SHKALLA	A16 1:300
Ing. Hidroteknik	Filjana Veizaj	H/T.0110/9	
Arkitekt	Iva Mezezi	A.0831/4	
Ing. Ndertimi	Rafael Kote	H/T.0129/7	
Ing. Elektrik	Florjan Lame	E.1631	
Ing. Elektrik	Fatmira Shyti	E.0462/3	
Projektues	OE "INFRA TECH" shpk		

**INFRA TECH**  
Administrator  
Filjana Veizaj

# PLANI I RIFINITURES I KATIT TE PARE

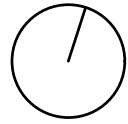

REPUBLIKA E SHQIPËRISË  
BASHKIA TIRANË



OBJEKTI: STUDIM PROJEKTIM "NDËRTIMI I SHKOLLËS 9 VJEÇARE "EDIT DURHAM"

## PLANI I RIFINITURES I KATIT TE PARE

FAZA PROJEKT ZBATIM	VITI 2024	NR. SHKALLA	A17 1:300
Ing. Hidroteknik	Filjana Veizaj	H/T.0110/9	
Arkitekt	Iva Mezezi	A.0831/4	
Ing. Ndertimi	Rafael Kote	H/T.0129/7	
Ing. Elektrik	Florjan Lame	E.1631	
Ing. Elektrik	Fatmira Shyti	E.0462/3	
Projektues	OE "INFRA TECH" shpk		

**INFRA TECH**  
Administrator  
Filjana Veizaj

# PLANI I RIFINITURES I KATIT TE DYTE

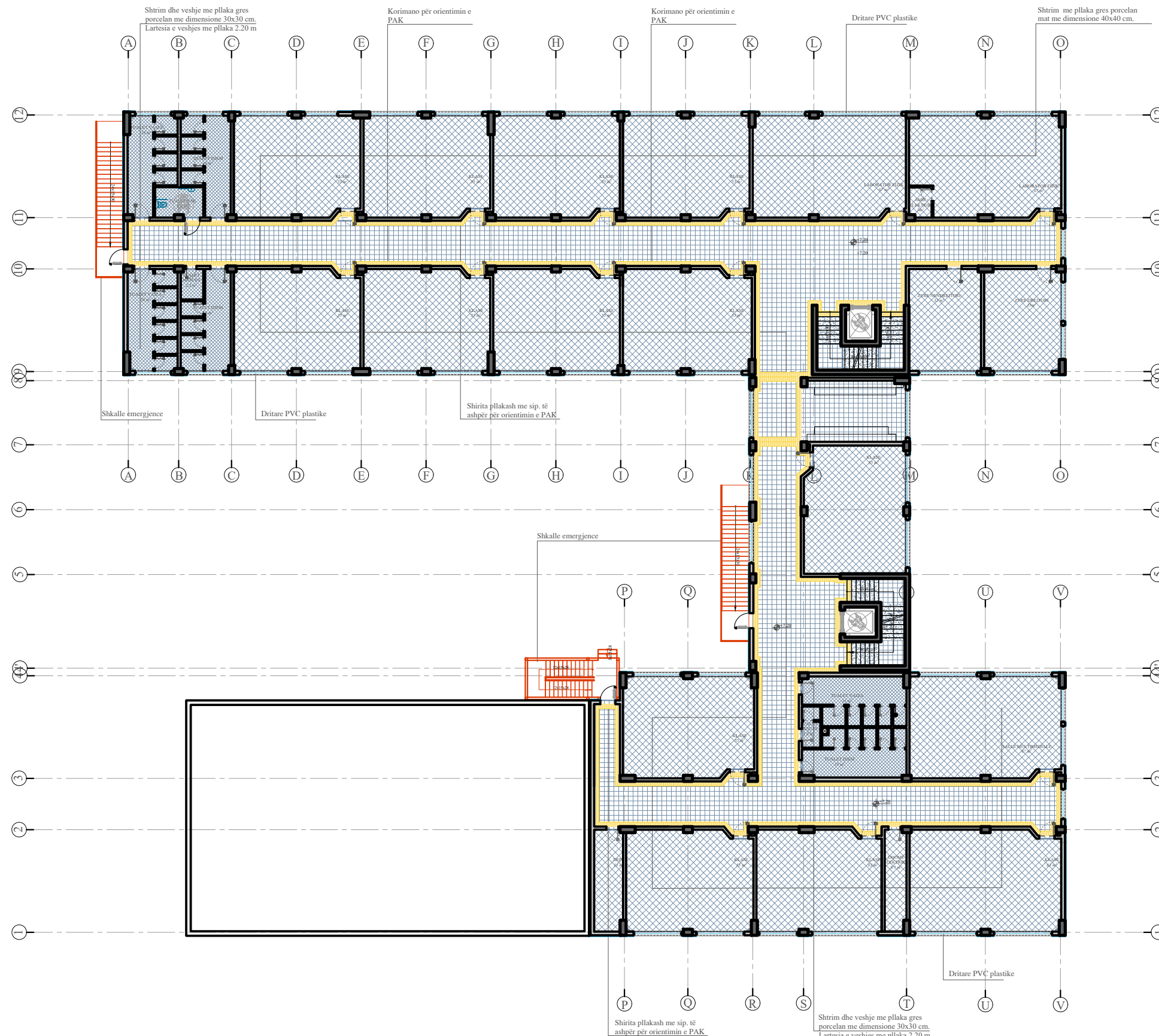
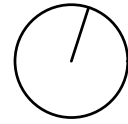

REPUBLIKA E SHQIPËRISË  
BASHKIA TIRANË



ZONA E PROJEKTIT

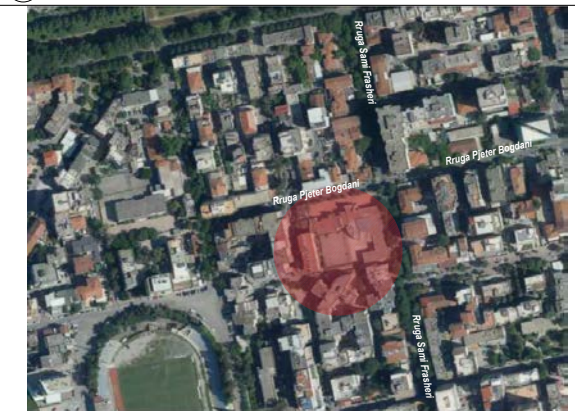

OBJEKTI: STUDIM PROJEKTIM "NDËRTIMI I SHKOLLËS  
9 VJEÇARE "EDIT DURHAM"

## PLANI I RIFINITURES I KATIT TE DYTE

FAZA PROJEKT ZBATIM	VITI 2024	NR. SHKALLA	A18 1:300
------------------------	--------------	----------------	--------------

Ing. Hidroteknik	Filjana Veizaj	H/T.0110/9
Arkitekt	Iva Mezezi	A.0831/4
Ing. Ndertimi	Rafael Kote	H/T.0129/7
Ing. Elektrik	Florjan Lame	E.1631
Ing. Elektrik	Fatmira Shyti	E.0462/3

Projektues OE "INFRATECH" shpk

**INFRATECH**  
Administrator  
Filjana Veizaj

# PLANI I TAVANIT I KATIT PERDHE

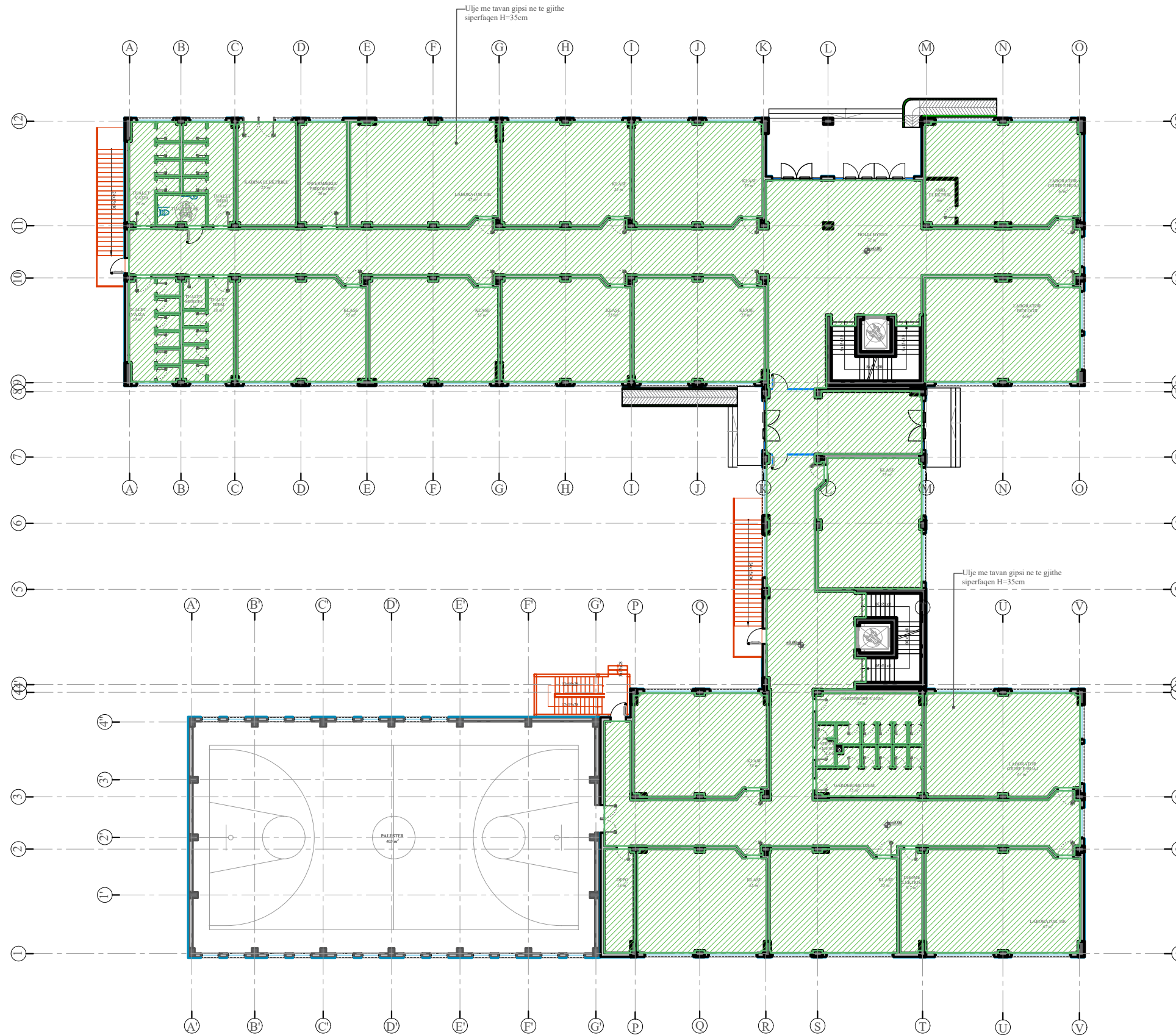
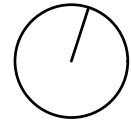

REPUBLIKA E SHQIPËRISË  
BASHKIA TIRANË



OBJEKTI: STUDIM PROJEKTIM "NDËRTIMI I SHKOLLËS  
9 VJEÇARE "EDIT DURHAM"

## PLANI I TAVANIT I KATIT PERDHE

FAZA PROJEKT ZBATIM	VITI 2024	NR. SHKALLA	A19 1:300
Ing. Hidroteknik	Filjana Veizaj	H/T.0110/9	
Arkitekt	Iva Mezezi	A.0831/4	
Ing. Ndertimi	Rafael Kote	H/T.0129/7	
Ing. Elektrik	Florjan Lame	E.1631	
Ing. Elektrik	Fatmira Shyti	E.0462/3	
Projektues	OE "INFRA TECH" shpk		

**INFRA TECH**  
Administrator  
Filjana Veizaj

# PLANI I TAVANIT I KATIT TE PARE

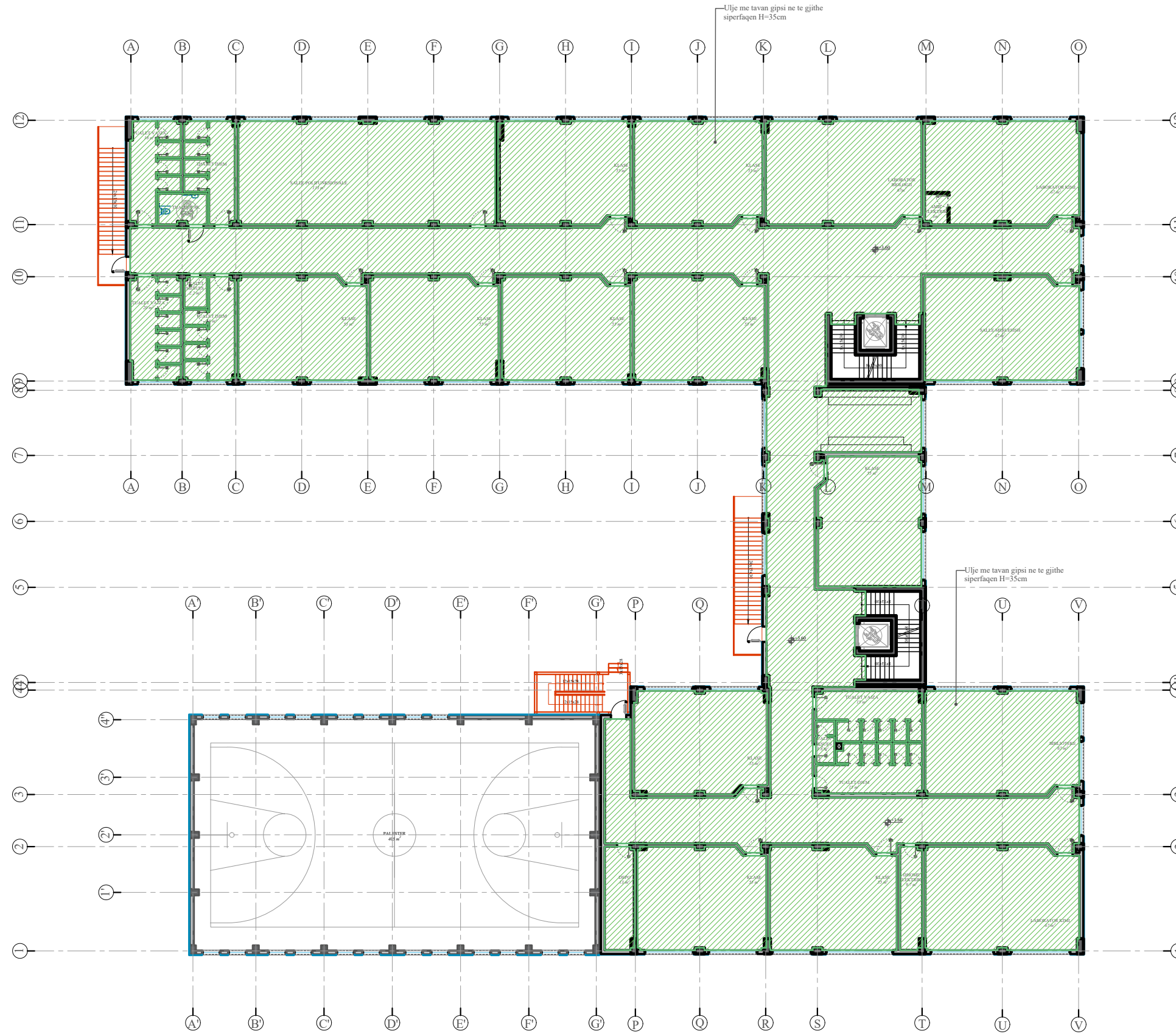
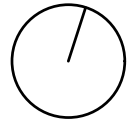

REPUBLIKA E SHQIPËRISË  
BASHKIA TIRANË



ZONA E PROJEKTIT



OBJEKTI: STUDIM PROJEKTIM "NDËRTIMI I SHKOLLËS  
9 VJEÇARE "EDIT DURHAM"

## PLANI I TAVANIT I KATIT TE PARE

FAZA PROJEKT ZBATIM	VITI 2024	NR. SHKALLA	A20 1:300
------------------------	--------------	----------------	--------------

Ing. Hidroteknik	Filjana Veizaj	H/T.0110/9
Arkitekt	Iva Mezezi	A.0831/4
Ing. Ndertimi	Rafael Kote	H/T.0129/7
Ing. Elektrik	Florjan Lame	E.1631
Ing. Elektrik	Fatmira Shyti	E.0462/3

Projektues	OE "INFRA TECH" shpk
------------	----------------------

**INFRA TECH**  
Administrator  
Filjana Veizaj

# PLANI I TAVANIT I KATIT TE DYTE

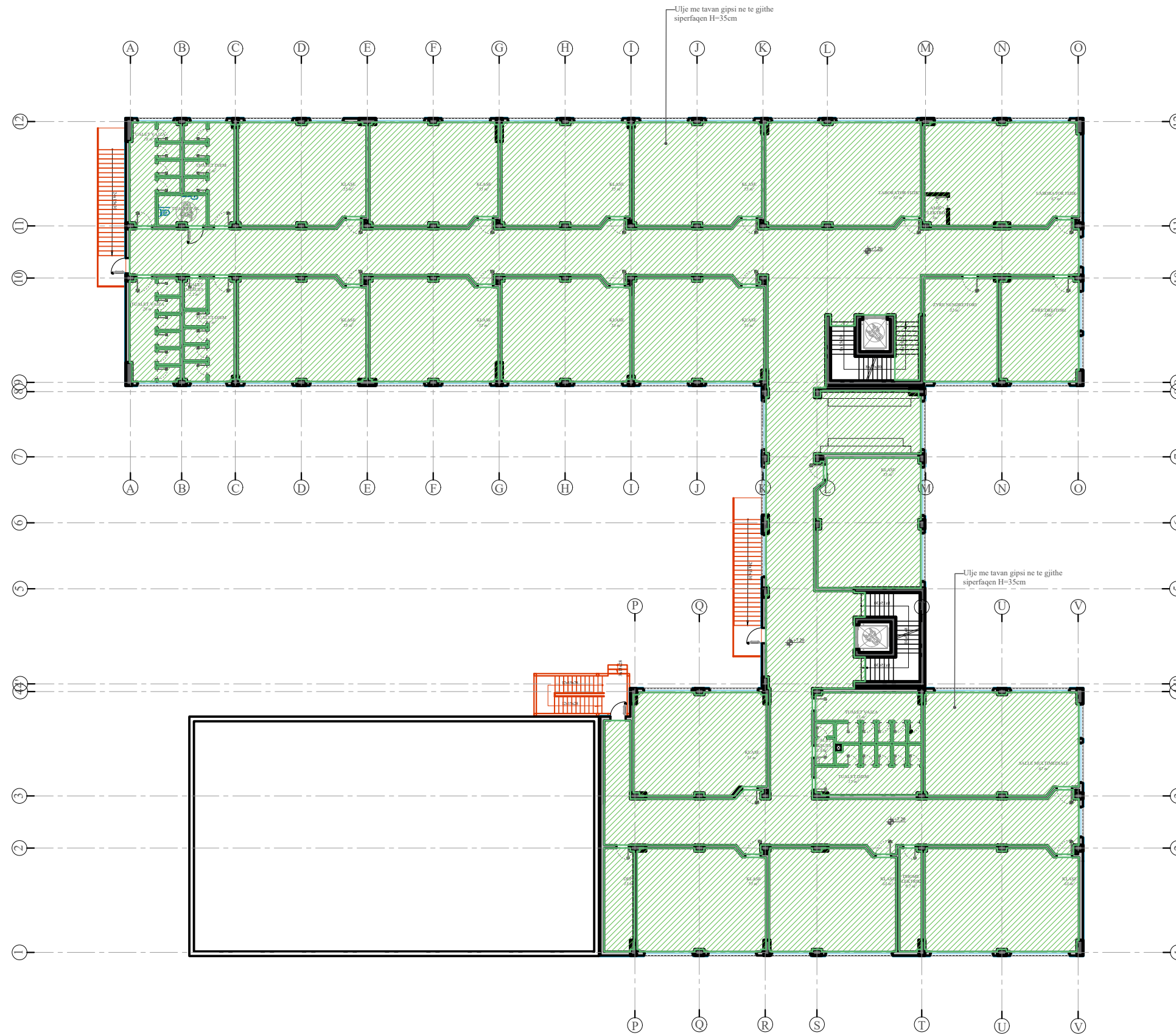
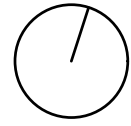

REPUBLIKA E SHQIPËRISË  
BASHKIA TIRANË



ZONA E PROJEKTIT

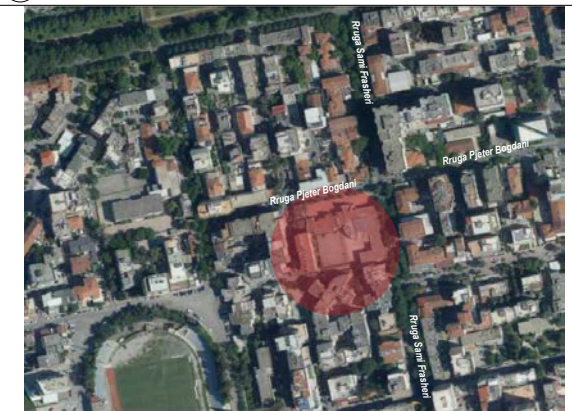

OBJEKTI: STUDIM PROJEKTIM "NDËRTIMI I SHKOLLËS  
9 VJEÇARE "EDIT DURHAM"

## PLANI I TAVANIT I KATIT TE DYTE

FAZA PROJEKT ZBATIM	VITI 2024	NR. SHKALLA	A21 1:300
Ing. Hidroteknik	Filjana Veizaj	H/T.0110/9	
Arkitekt	Iva Mezezi	A.0831/4	
Ing. Ndertimi	Rafael Kote	H/T.0129/7	
Ing. Elektrik	Florjan Lame	E.1631	
Ing. Elektrik	Fatmira Shyti	E.0462/3	
Projektues	OE "INFRA TECH" shpk		

**INFRA TECH**  
Administrator  
Filjana Veizaj

# PLANI I DYER-DRITAREVE I KATIT PERDHE

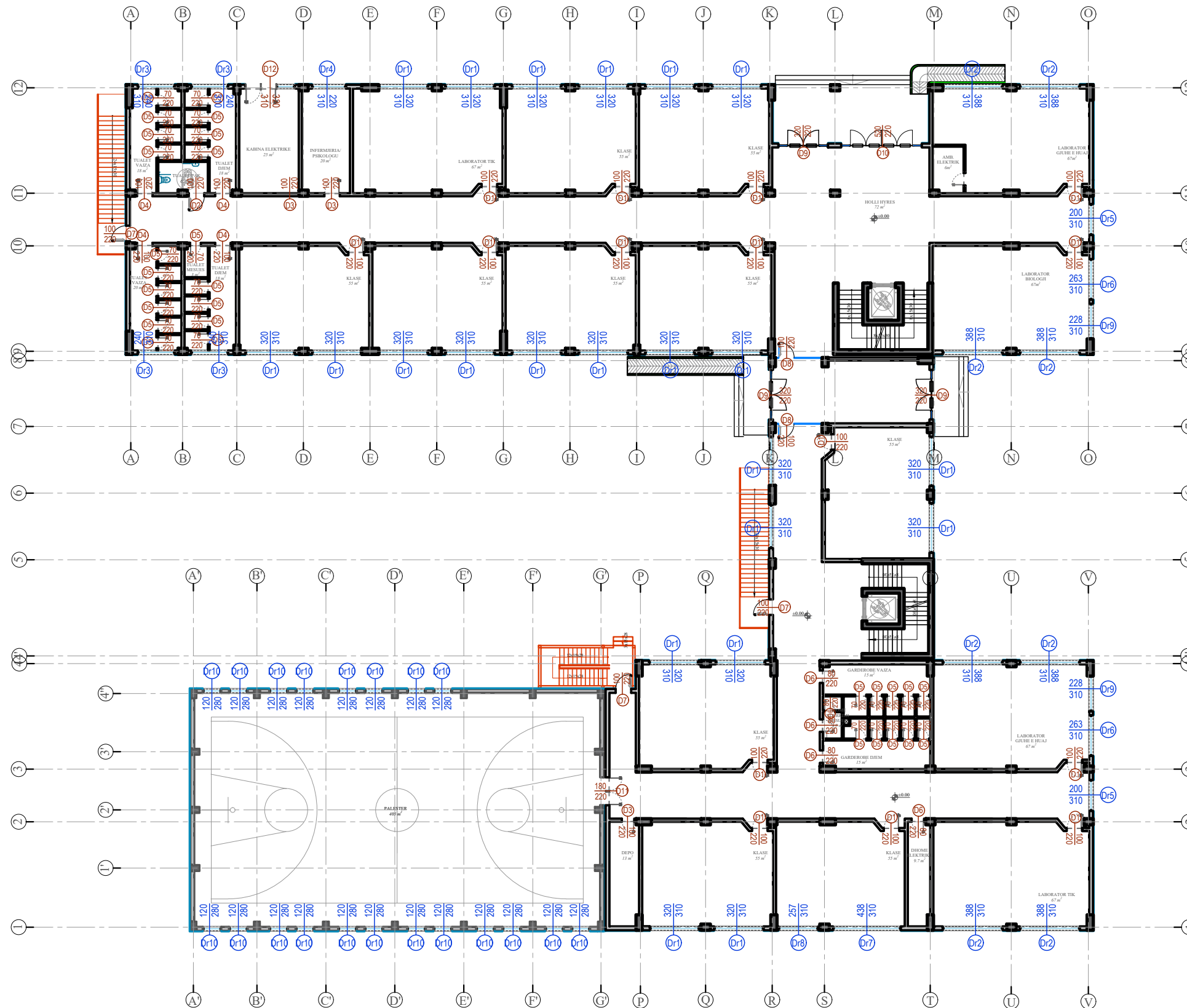
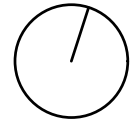

REPUBLIKA E SHQIPËRISË  
BASHKIA TIRANË



ZONA E PROJEKTIT

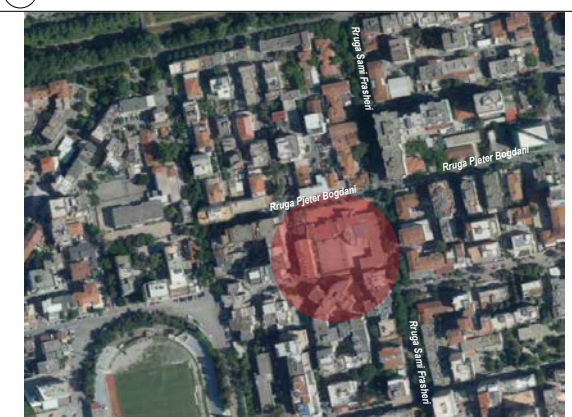

OBJEKTI: STUDIM PROJEKTIM "NDËRTIMI I SHKOLLËS  
9 VJEÇARE "EDIT DURHAM"

## PLANI I DYER-DRITAREVE I KATIT PERDHE

FAZA PROJEKT ZBATIM	VITI 2024	NR. SHKALLA	A22 1:300
Ing. Hidroteknik	Filjana Veizaj	H/T.0110/9	
Arkitekt	Iva Mezezi	A.0831/4	
Ing. Ndertimi	Rafael Kote	H/T.0129/7	
Ing. Elektrik	Florjan Lame	E.1631	
Ing. Elektrik	Fatmira Shyti	E.0462/3	
Projektues	OE "INFRA TECH" shpk		

**INFRA TECH**  
Administrator  
Filjana Veizaj

# PLANI I DYER-DRITAREVE I KATIT TE PARE

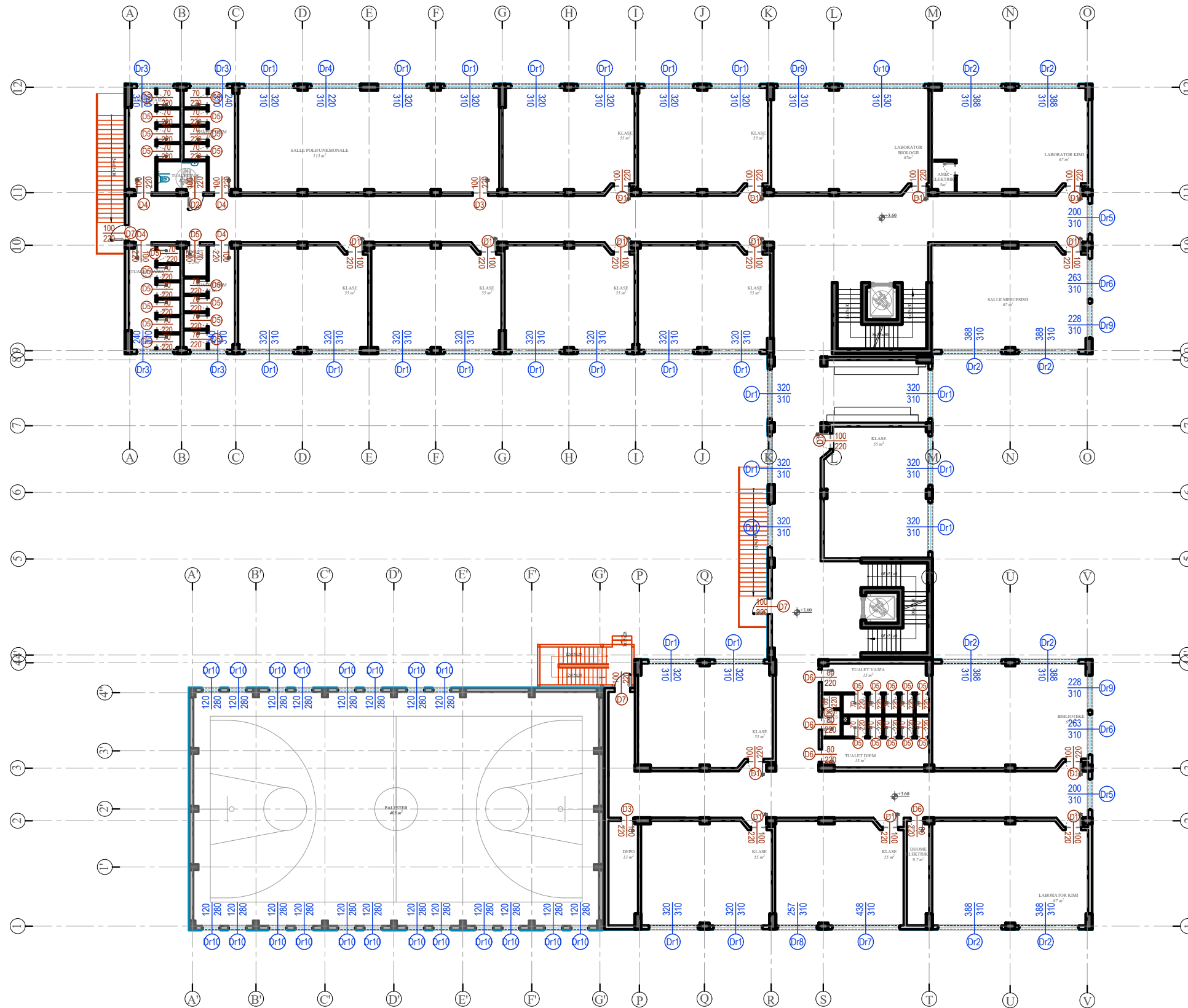
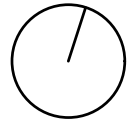

REPUBLIKA E SHQIPËRISË  
BASHKIA TIRANË



OBJEKTI: STUDIM PROJEKTIM "NDËRTIMI I SHKOLLËS 9 VJEÇARE "EDIT DURHAM"

## PLANI I DYER-DRITAREVE I KATIT TE PARE

FAZA PROJEKT ZBATIM	VITI 2024	NR. SHKALLA	A23 1:300
Ing. Hidroteknik	Filjana Veizaj	H/T.0110/9	
Arkitekt	Iva Mezezi	A.0831/4	
Ing. Ndertimi	Rafael Kote	H/T.0129/7	
Ing. Elektrik	Florjan Lame	E.1631	
Ing. Elektrik	Fatmira Shyti	E.0462/3	
Projektues	OE "INFRA TECH" shpk		

**INFRA TECH**  
Administrator  
Filjana Veizaj



# PLANI I DYER-DRITAREVE I KATIT TE DYTE

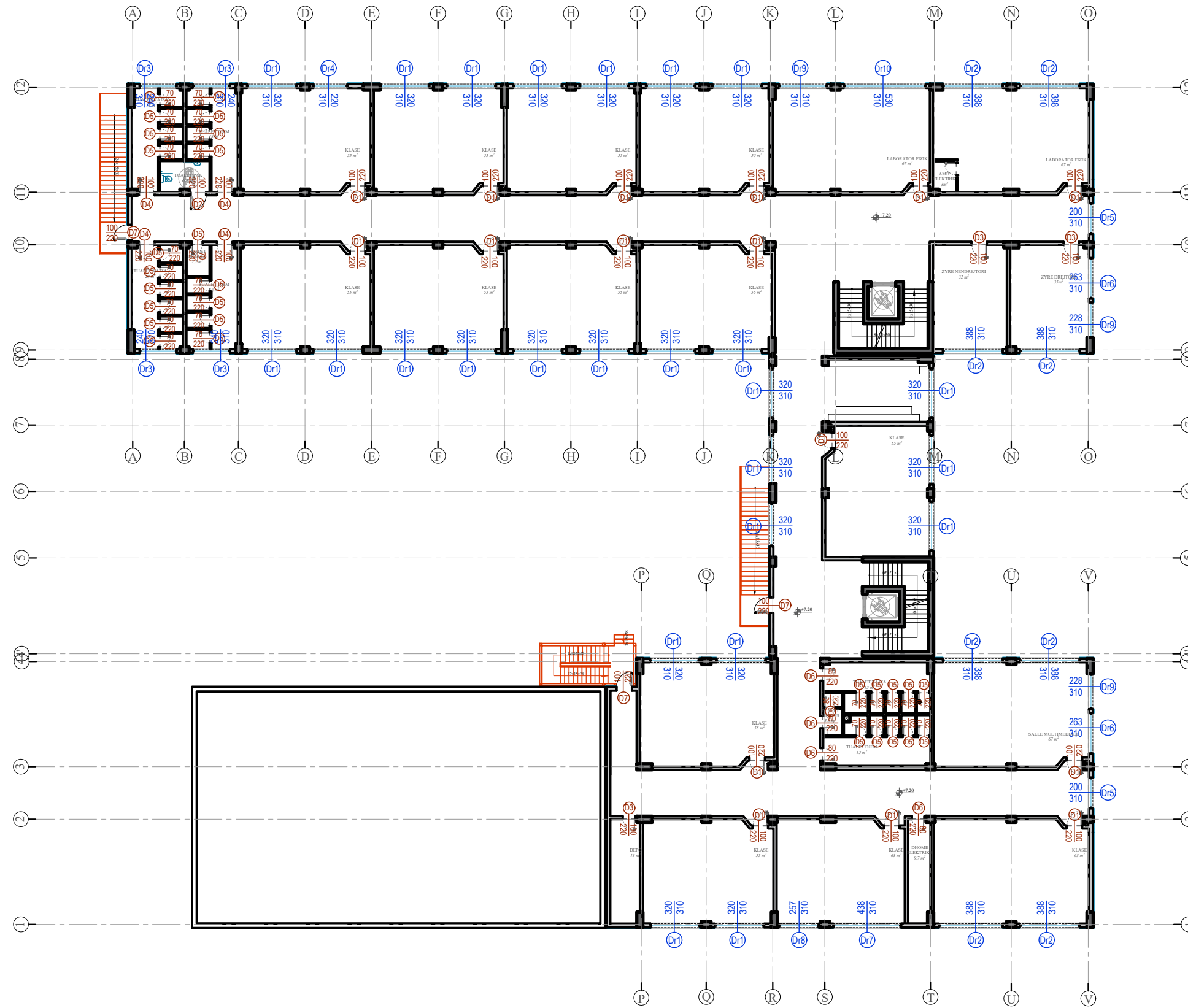
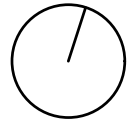

REPUBLIKA E SHQIPËRISË  
BASHKIA TIRANË



ZONA E PROJEKTIT

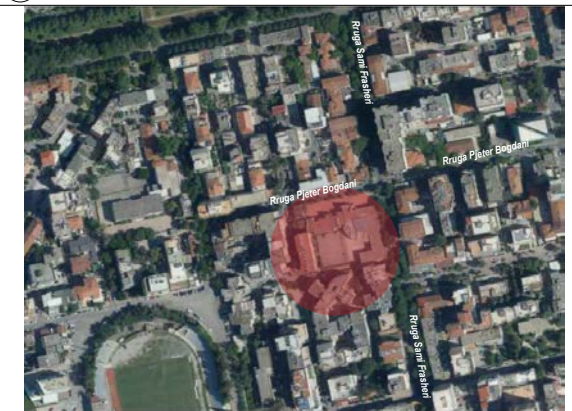

OBJEKTI: STUDIM PROJEKTIM "NDËRTIMI I SHKOLLËS  
9 VJEÇARE "EDIT DURHAM"

## PLANI I DYER-DRITAREVE I KATIT TE DYTE

FAZA PROJEKT ZBATIM	VITI 2024	NR. SHKALLA	A24 1:300
------------------------	--------------	----------------	--------------

Ing. Hidroteknik	Filjana Veizaj	H/T.0110/9
Arkitekt	Iva Mezezi	A.0831/4
Ing. Ndertimi	Rafael Kote	H/T.0129/7
Ing. Elektrik	Florjan Lame	E.1631
Ing. Elektrik	Fatmira Shyti	E.0462/3

Projektues	OE "INFRA TECH" shpk
------------	----------------------

**INFRA TECH**  
Administrator  
Filjana Veizaj

# FASADA VERIORE

REPUBLIKA E SHQIPËRISË  
BASHKIA TIRANË



ZONA E PROJEKTIT



OBJEKTI: STUDIM PROJEKTIM "NDËRTIMI I SHKOLLËS  
9 VJEÇARE "EDIT DURHAM"

## FASADA VERIORE

FAZA PROJEKT ZBATIM	VITI 2024	NR. SHKALLA	A25 1:250
Ing. Hidroteknik	Filjana Veizaj	H/T.0110/9	
Arkitekt	Iva Mezezi	A.0831/4	
Ing. Ndertimi	Rafael Kote	H/T.0129/7	
Ing. Elektrik	Florjan Lame	E.1631	
Ing. Elektrik	Fatmira Shyti	E.0462/3	
Projektues	OE "INFRATECH" shpk		

**INFRATECH**

Administrator

Filjana Veizaj

# FASADA JUGORE

REPUBLIKA E SHQIPËRISË  
BASHKIA TIRANË

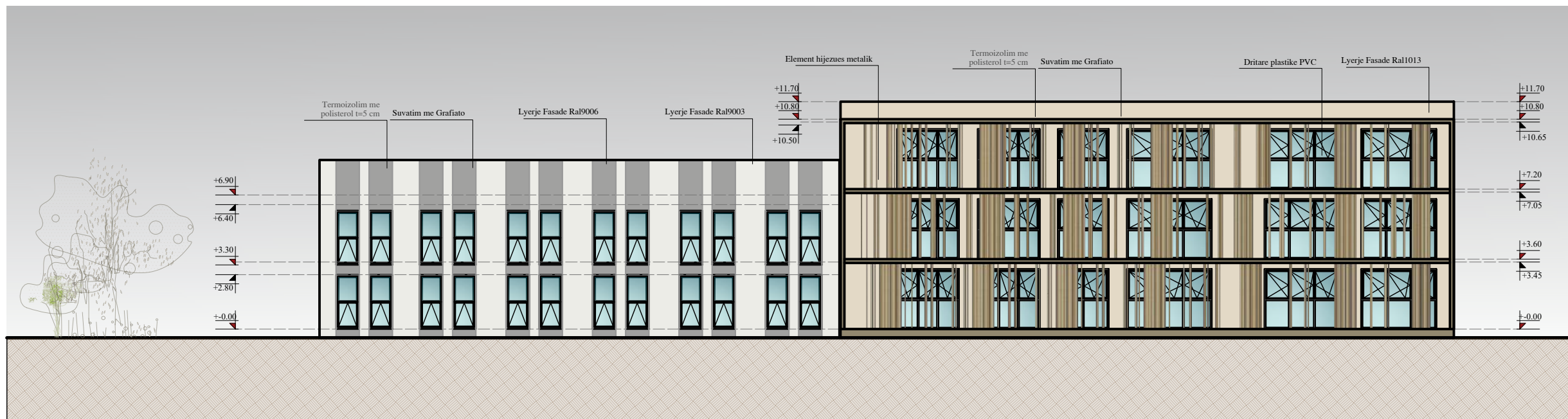

ZONA E PROJEKTIT



OBJEKTI: STUDIM PROJEKTIM "NDËRTIMI I SHKOLLËS 9 VJEÇARE "EDIT DURHAM"

## FASADA JUGORE

FAZA PROJEKT ZBATIM	VITI 2024	NR. SHKALLA	A26 1:250
Ing. Hidroteknik	Filjana Veizaj	H/T.0110/9	
Arkitekt	Iva Mezezi	A.0831/4	
Ing. Ndertimi	Rafael Kote	H/T.0129/7	
Ing. Elektrik	Florjan Lame	E.1631	
Ing. Elektrik	Fatmira Shyti	E.0462/3	
Projektues	OE "INFRATECH" shpk		

**INFRATECH**  
Administrator  
Filjana Veizaj

# FASADA LINDORE

REPUBLIKA E SHQIPËRISË  
BASHKIA TIRANË



ZONA E PROJEKTIT

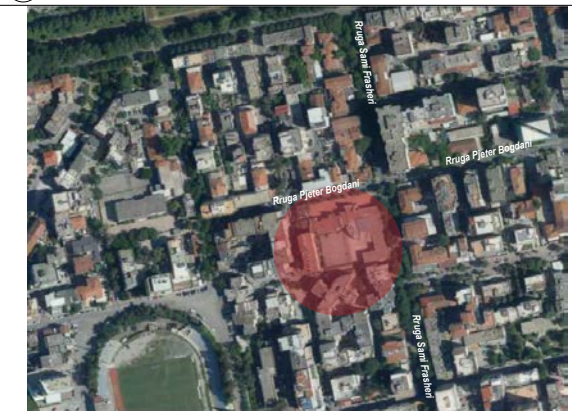

OBJEKTI: STUDIM PROJEKTIM "NDËRTIMI I SHKOLLËS  
9 VJEÇARE "EDIT DURHAM"

## FASADA LINDORE

FAZA PROJEKT ZBATIM	VITI 2024	NR. SHKALLA	A27 1:250
Ing. Hidroteknik	Filjana Veizaj	H/T.0110/9	
Arkitekt	Iva Mezezi	A.0831/4	
Ing. Ndertimi	Rafael Kote	H/T.0129/7	
Ing. Elektrik	Florjan Lame	E.1631	
Ing. Elektrik	Fatmira Shyti	E.0462/3	
Projektues	OE "INFRATECH" shpk		

**INFRATECH**  
Administrator  
Filjana Veizaj

# FASADA PERENDIMORE

REPUBLIKA E SHQIPËRISË  
BASHKIA TIRANË



ZONA E PROJEKTIT



OBJEKTI: STUDIM PROJEKTIM "NDËRTIMI I SHKOLLËS  
9 VJEÇARE "EDIT DURHAM"

FASADA PERENDIMORE

FAZA PROJEKT ZBATIM	VITI 2024	NR. SHKALLA	A28 1:250
Ing. Hidroteknik	Filjana Veizaj	H/T.0110/9	
Arkitekt	Iva Mezezi	A.0831/4	
Ing. Ndertimi	Rafael Kote	H/T.0129/7	
Ing. Elektrik	Florjan Lame	E.1631	
Ing. Elektrik	Fatmira Shyti	E.0462/3	
Projektues	OE "INFRATECH" shpk		

**INFRATECH**  
Administrator  
Filjana Veizaj

# PRERJA A-A

REPUBLIKA E SHQIPËRISË  
BASHKIA TIRANË

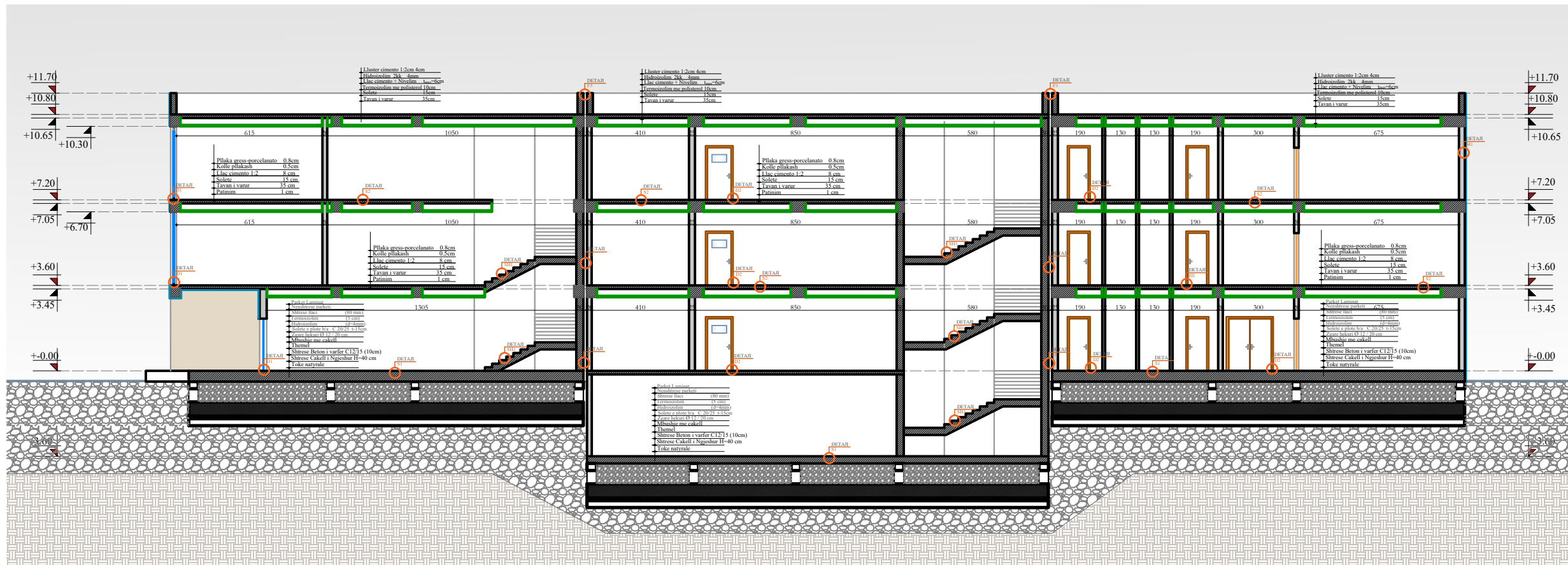

OBJEKTI: STUDIM PROJEKTIM "NDËRTIMI I SHKOLLËS 9 VJEÇARE "EDIT DURHAM"

## PRERJA A-A

FAZA PROJEKT ZBATIM	VITI 2024	NR. SHKALLA	A29 1:200
Ing. Hidroteknik	Filjana Veizaj	H/T.0110/9	
Arkitekt	Iva Mezezi	A.0831/4	
Ing. Ndertimi	Rafael Kote	H/T.0129/7	
Ing. Elektrik	Florjan Lame	E.1631	
Ing. Elektrik	Fatmira Shyti	E.0462/3	
Projektues	OE "INFRA TECH" shpk		

**INFRA TECH**  
Administrator  
Filjana Veizaj

# PRERJA B-B

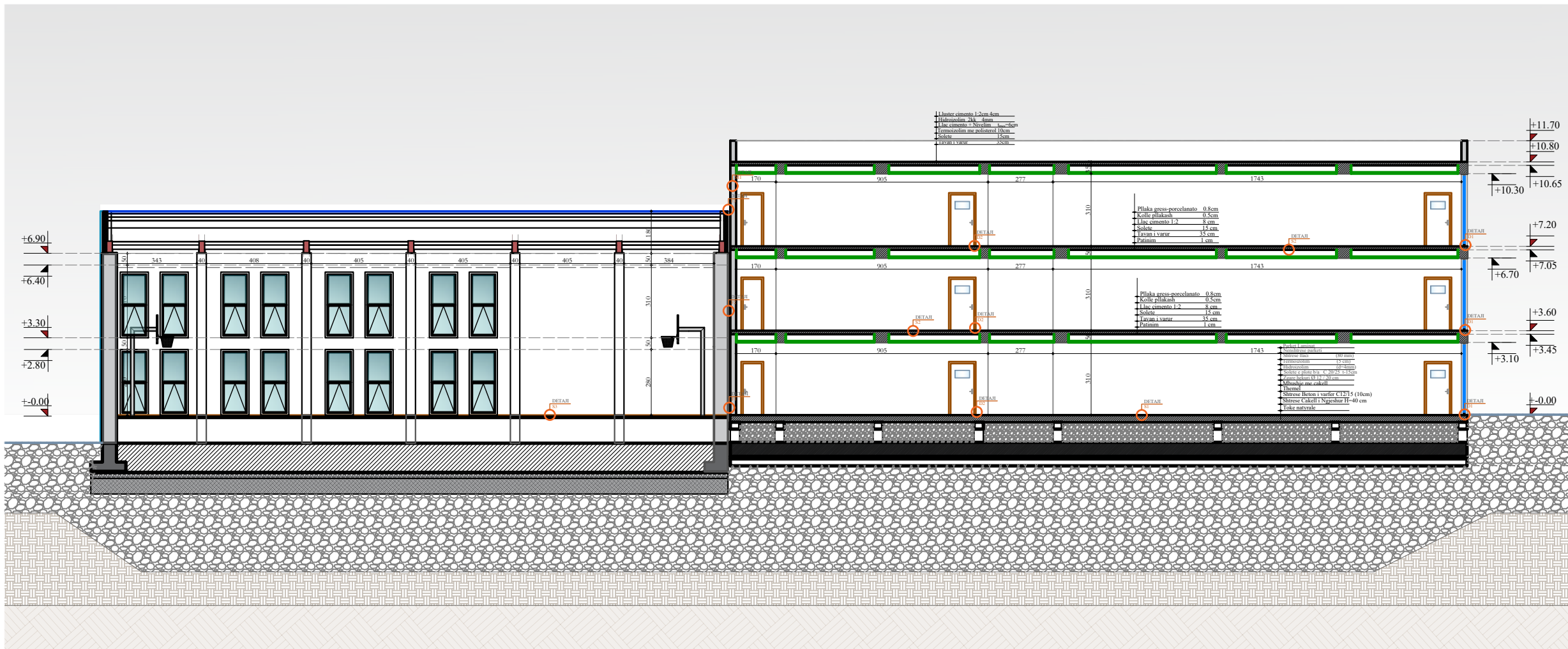

REPUBLIKA E SHQIPËRISË  
BASHKIA TIRANË



OBJEKTI: STUDIM PROJEKTIM "NDËRTIMI I SHKOLLËS  
9 VJEÇARE "EDIT DURHAM"

## PRERJA B-B

FAZA PROJEKT ZBATIM	VITI 2024	NR. SHKALLA	A30 1:200
Ing. Hidroteknik	Filjana Veizaj	H/T.0110/9	
Arkitekt	Iva Mezezi	A.0831/4	
Ing. Ndertimi	Rafael Kote	H/T.0129/7	
Ing. Elektrik	Florjan Lame	E.1631	
Ing. Elektrik	Fatmira Shyti	E.0462/3	
Projektues	OE "INFRA TECH" shpk		

**INFRA TECH**  
Administrator  
Filjana Veizaj





# SKEDAT E DRITAREVE

REPUBLIKA E SHQIPËRISË  
BASHKIA TIRANË



<p>DRITARE E JASHTME DR1</p> <p>SASIA: 22+25+25=72</p> <p>DIMENSIONET 320 x 310 cm</p> <p>MATERIALI DRITARE PLASTIKE PVC ME DOPIO XHAM</p> <p>POZICIONIMI KATI PERDHE, I PARE, I DYTE</p> <p>SHENIME DRITARE PLASTIKE PVC ME IZOLIM TERMIK DRITARE ME DOPIO XHAM (4+4mm) BOSHLEK AJRI (10mm)</p>	<p>DRITARE E JASHTME DR2</p> <p>SASIA: 8+8+8=24</p> <p>DIMENSIONET 388 x 310 cm</p> <p>MATERIALI DRITARE PLASTIKE PVC ME DOPIO XHAM</p> <p>POZICIONIMI KATI PERDHE, I PARE, I DYTE</p> <p>SHENIME DRITARE PLASTIKE PVC ME IZOLIM TERMIK DRITARE ME DOPIO XHAM (4+4mm) BOSHLEK AJRI (10mm)</p>	<p>DRITARE E JASHTME DR3</p> <p>SASIA: 4+4+4=12</p> <p>DIMENSIONET 240 x 310 cm</p> <p>MATERIALI DRITARE PLASTIKE PVC ME DOPIO XHAM</p> <p>POZICIONIMI KATI PERDHE, I PARE, I DYTE</p> <p>SHENIME DRITARE PLASTIKE PVC ME IZOLIM TERMIK DRITARE ME DOPIO XHAM (4+4mm) BOSHLEK AJRI (10mm)</p>	<p>DRITARE E JASHTME DR4</p> <p>SASIA: 1+1+1=3</p> <p>DIMENSIONET 240 x 310 cm</p> <p>MATERIALI DRITARE PLASTIKE PVC ME DOPIO XHAM</p> <p>POZICIONIMI KATI PERDHE, I PARE, I DYTE</p> <p>SHENIME DRITARE PLASTIKE PVC ME IZOLIM TERMIK DRITARE ME DOPIO XHAM (4+4mm) BOSHLEK AJRI (10mm)</p>	<p>DRITARE E JASHTME DR5</p> <p>SASIA: 2+2+2=6</p> <p>DIMENSIONET 200 x 310 cm</p> <p>MATERIALI DRITARE PLASTIKE PVC ME DOPIO XHAM</p> <p>POZICIONIMI KATI PERDHE, I PARE, I DYTE</p> <p>SHENIME DRITARE PLASTIKE PVC ME IZOLIM TERMIK DRITARE ME DOPIO XHAM (4+4mm) BOSHLEK AJRI (10mm)</p>	<p>DRITARE E JASHTME DR6</p> <p>SASIA: 2+2+2=6</p> <p>DIMENSIONET 263 x 310 cm</p> <p>MATERIALI DRITARE PLASTIKE PVC ME DOPIO XHAM</p> <p>POZICIONIMI KATI PERDHE, I PARE, I DYTE</p> <p>SHENIME DRITARE PLASTIKE PVC ME IZOLIM TERMIK DRITARE ME DOPIO XHAM (4+4mm) BOSHLEK AJRI (10mm)</p>	<p>DRITARE E JASHTME DR7</p> <p>SASIA: 1+1+1=3</p> <p>DIMENSIONET 438 x 310 cm</p> <p>MATERIALI DRITARE PLASTIKE PVC ME DOPIO XHAM</p> <p>POZICIONIMI KATI PERDHE, I PARE, I DYTE</p> <p>SHENIME DRITARE PLASTIKE PVC ME IZOLIM TERMIK DRITARE ME DOPIO XHAM (4+4mm) BOSHLEK AJRI (10mm)</p>	<p>DRITARE E JASHTME DR8</p> <p>SASIA: 1+1+1=3</p> <p>DIMENSIONET 257 x 310 cm</p> <p>MATERIALI DRITARE PLASTIKE PVC ME DOPIO XHAM</p> <p>POZICIONIMI KATI PERDHE, I PARE, I DYTE</p> <p>SHENIME DRITARE PLASTIKE PVC ME IZOLIM TERMIK DRITARE ME DOPIO XHAM (4+4mm) BOSHLEK AJRI (10mm)</p>	<p>DRITARE E JASHTME DR9</p> <p>SASIA: 1+1+1=3</p> <p>DIMENSIONET 228 x 310 cm</p> <p>MATERIALI DRITARE PLASTIKE PVC ME DOPIO XHAM</p> <p>POZICIONIMI KATI PERDHE, I PARE, I DYTE</p> <p>SHENIME DRITARE PLASTIKE PVC ME IZOLIM TERMIK DRITARE ME DOPIO XHAM (4+4mm) BOSHLEK AJRI (10mm)</p>	<p>DRITARE E JASHTME DR10</p> <p>SASIA: 20+20=40</p> <p>DIMENSIONET 120 x 280 cm</p> <p>MATERIALI DRITARE PLASTIKE PVC ME DOPIO XHAM</p> <p>POZICIONIMI KATI PERDHE, I PARE</p> <p>SHENIME DRITARE PLASTIKE PVC ME IZOLIM TERMIK DRITARE ME DOPIO XHAM (4+4mm) BOSHLEK AJRI (10mm)</p>
--	---	---	--	--	--	--	--	--	--



OBJEKTI: STUDIM PROJEKTIM "NDËRTIMI I SHKOLLËS 9 VJEÇARE "EDIT DURHAM"

## SKEDAT E DRITAREVE

FAZA	VITI	NR.	A32
PROJEKT ZBATIM	2024	SHKALLA	1:100
Ing. Hidroteknik	Filjana Veizaj	H/T.0110/9	
Arkitekt	Iva Mezezi	A.0831/4	
Ing. Ndertimi	Rafael Kote	H/T.0129/7	
Ing. Elektrik	Florjan Lame	E.1631	
Ing. Elektrik	Fatmira Shyti	E.0462/3	
Projektues	OE "INFRA TECH" shpk		

**INFRA TECH**  
Administrator  
Filjana Veizaj

# SKEDAT E DYERVE

**DERE E BRENDSHME** **D1**

SASIA: 15+15+16=46

DIMENSIONET 100 x 220cm

MATERIALE DERE E BRENDSHME ME DRU PISHE

POZICIONIMI KATI PERDHE, I PARE, I DYTE

**DERE E BRENDSHME** **D2**

SASIA: 1+1+1=3

DIMENSIONET 100 x 220cm

MATERIALE DERE E BRENDSHME ME DRU PISHE

POZICIONIMI KATI PERDHE, I PARE, I DYTE

**DERE E BRENDSHME** **D3**

SASIA: 3+2+3=8

DIMENSIONET 100 x 220cm

MATERIALE DERE E BRENDSHME ME DRU PISHE

POZICIONIMI KATI PERDHE, I PARE, I DYTE

**DERE E BRENDSHME** **D4**

SASIA: 4+4+4=12

DIMENSIONET 100 x 220cm

MATERIALE DERE ME PANEL

POZICIONIMI KATI PERDHE, I PARE, I DYTE

**DERE E BRENDSHME** **D5**

SASIA: 29+29+29=87

DIMENSIONET 70 x 220cm

MATERIALE DERE ALUMINI ME XHAM

POZICIONIMI KATI PERDHE, I PARE, I DYTE

**DERE E BRENDSHME** **D6**

SASIA: 5+5+5=15

DIMENSIONET 80 x 220cm

MATERIALE DERE E BRENDSHME ME DRU PISHE

POZICIONIMI KATI PERDHE, I PARE, I DYTE

**DERE E BRENDSHME** **D7**

SASIA: 3+3+3=9

DIMENSIONET 100 x 220cm

MATERIALE DERE METALIKE ANTI-PANIK

POZICIONIMI KATI PERDHE, I PARE, I DYTE

**DERE E BRENDSHME** **D8**

SASIA: 2

DIMENSIONET 100 x 220cm

MATERIALE DERE ME XHAM

POZICIONIMI KATI PERDHE

**DERE E JASHMTE** **D9**

SASIA: 3

DIMENSIONET 320 x 220cm

MATERIALE DERE E JASHMTE ME XHAM

POZICIONIMI KATI PERDHE

**DERE E JASHMTE** **D10**

SASIA: 1

DIMENSIONET 520 x 220cm

MATERIALE DERE E JASHMTE ME XHAM

POZICIONIMI KATI PERDHE

**DERE E BRENDSHME** **D11**

SASIA: 1

DIMENSIONET 160 x 220cm

MATERIALE DERE E BRENDSHME ME DRU PISHE

POZICIONIMI KATI PERDHE

**DRITARE E JASHMTE** **D12**

SASIA: 1

DIMENSIONET 320 x 310 cm

MATERIALI DERE METALIKE DRITARE PLASTIKE ME XHAM TE TEMPERUAR

POZICIONIMI KATI PERDHE, I PARE, I DYTE

SHENIME DRITARE PLASTIKE PVC ME IZOLIM TERMIK DRITARE ME DOPIO XHAM (4+4mm) BOSHILLEK AJRI (10mm)

REPUBLIKA E SHQIPËRISË  
BASHKIA TIRANË



OBJEKTI: STUDIM PROJEKTIM "NDËRTIMI I SHKOLLËS  
9 VJEÇARE "EDIT DURHAM"

## SKEDAT E DYERVE

FAZA	VITI	NR.	A33
PROJEKT ZBATIM	2024	SHKALLA	1:100
Ing. Hidroteknik	Filjana Veizaj	H/T.0110/9	
Arkitekt	Iva Mezezi	A.0831/4	
Ing. Ndertimi	Rafael Kote	H/T.0129/7	
Ing. Elektrik	Florjan Lame	E.1631	
Ing. Elektrik	Fatmira Shyti	E.0462/3	
Projektues	OE "INFRA TECH" shpk		

**INFRA TECH**  
Administrator  
Filjana Veizaj

# DETAJE

## Detaj i fuges

### F-3

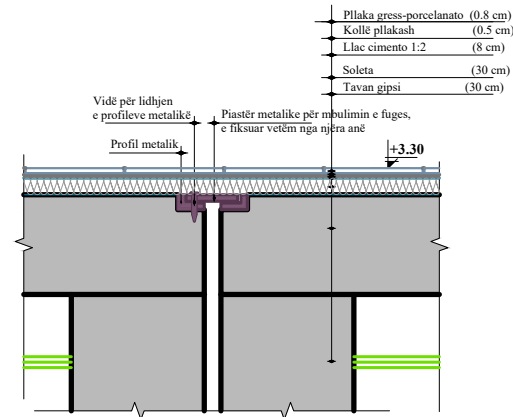

### F-1

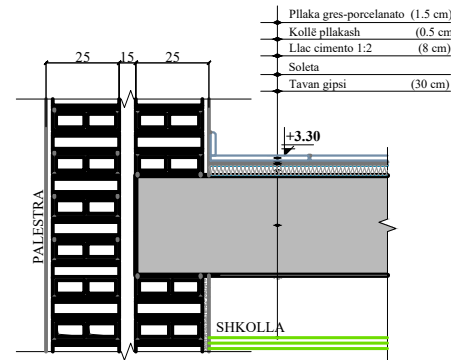

### F-2

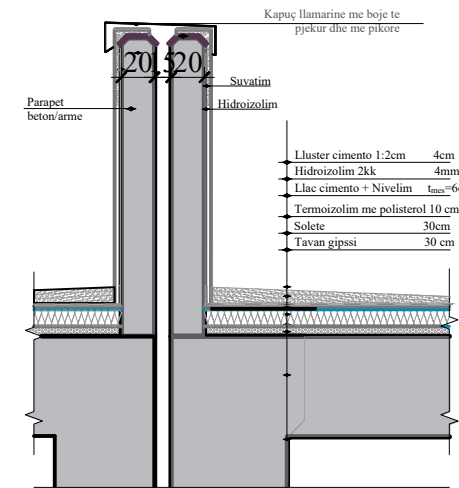

## Detaj i shtresave te murit "M-1"

### M-1

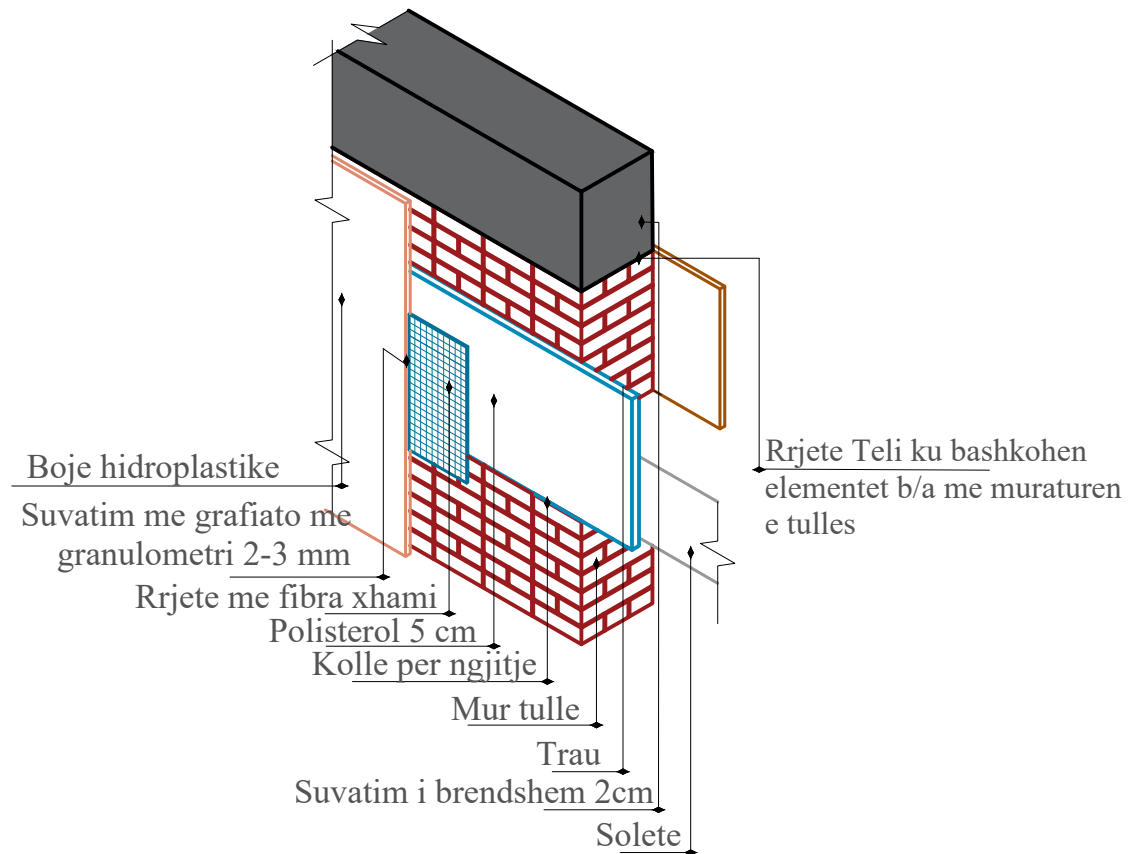
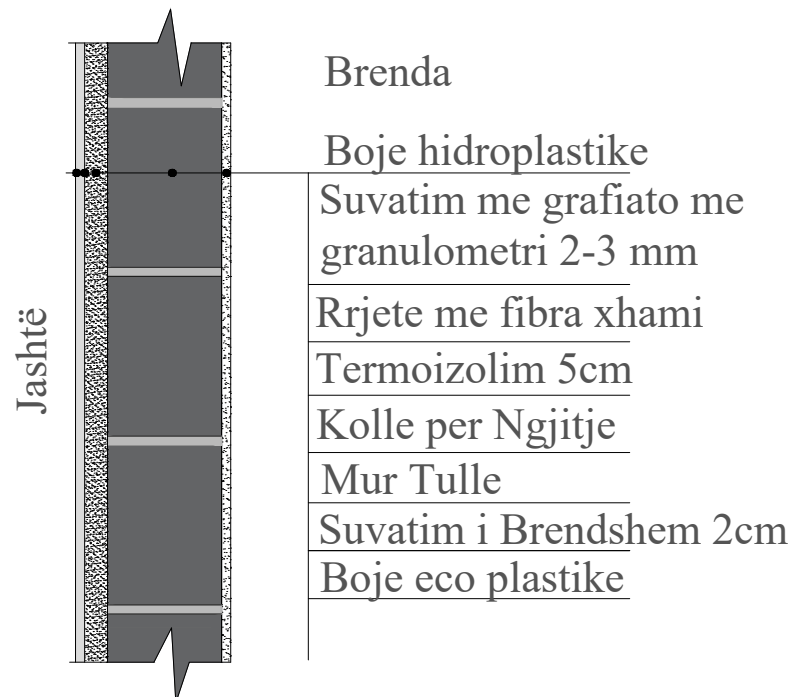

REPUBLIKA E SHQIPËRISË  
BASHKIA TIRANË



ZONA E PROJEKTIT

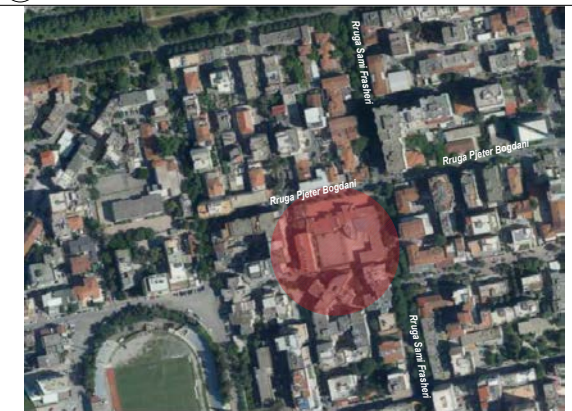

OBJEKTI: STUDIM PROJEKTIM "NDËRTIMI I SHKOLLËS 9 VJEÇARE "EDIT DURHAM"

### DETAJE

FAZA	VITI	NR.	A34
PROJEKT ZBATIM	2024	SHKALLA	
Ing. Hidroteknik	Filjana Veizaj	H/T.0110/9	
Arkitekt	Iva Mezezi	A.0831/4	
Ing. Ndertimi	Rafael Kote	H/T.0129/7	
Ing. Elektrik	Florjan Lame	E.1631	
Ing. Elektrik	Fatmira Shyti	E.0462/3	
Projektues	OE "INFRATECH" shpk		

**INFRATECH**

Administrator

Filjana Veizaj

# DETAJE

## Detaj i shtresave te dyshemese "S-1"

### S-1

- Pllaka gress-porcelanato (0.8cm)
- Kolle pllakash (0.5cm)
- Llac çimento 1:2 (8 cm)
- Termoizolim kompakt (5 cm)
- Hidroizolim 1kk 4mm
- Solete e plote b/a C20/25 t-15 cm
- Mbushje me cakell (120cm)
- Pllake Betoni (50cm)
- Shtrese Betoni i Varfer C12/15 (10cm)
- Shtrese Cakell i Ngjeshur H=2\*30 cm
- Shtrese Cakell i Ngjeshur H=20 cm
- Toke Natyrale

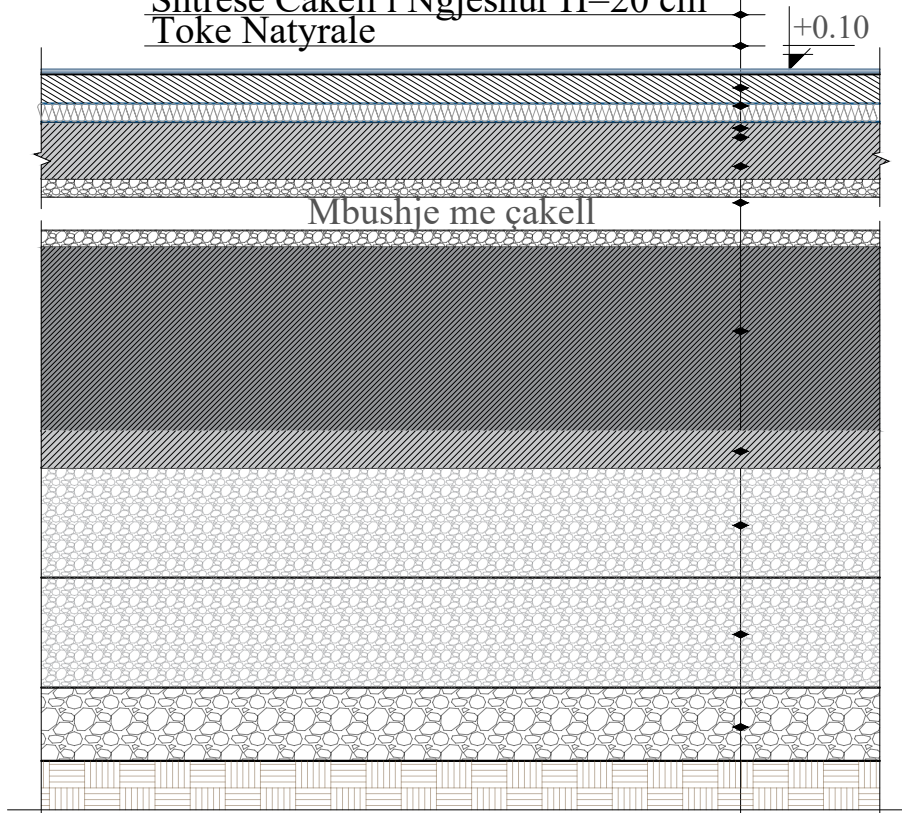

## Detaj i shtresave te dyshemese NDERKAT "S-2"

### S-2

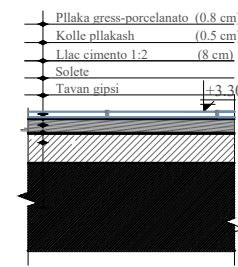

### S-3

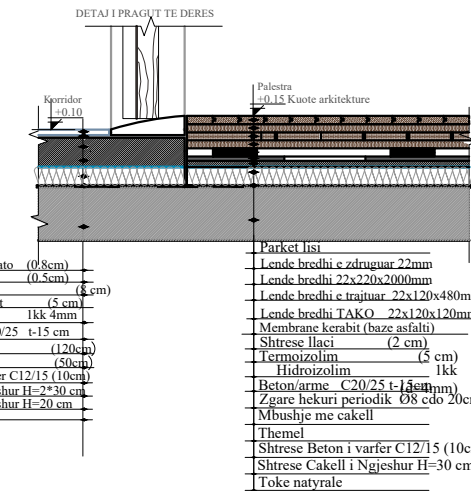

## Detaj i shtresave te dyshemese se palestres

### S-4

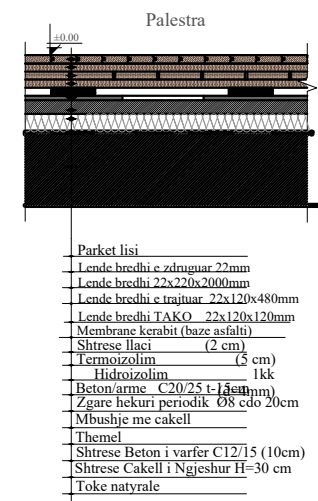

### Shenim:

Parketi i drurit dhe shtrimi i tij do behen sipas standarteve teknike duke u perdorur te gjithë elementet e nevojshme.



OBJEKTI: STUDIM PROJEKTIM "NDËRTIMI I SHKOLLËS 9 VJEÇARE "EDIT DURHAM"

### DETAJE

FAZA PROJEKT ZBATIM	VITI 2024	NR. SHKALLA	A35
Ing. Hidroteknik	Filjana Veizaj	H/T.0110/9	
Arkitekt	Iva Mezezi	A.0831/4	
Ing. Ndertimi	Rafael Kote	H/T.0129/7	
Ing. Elektrik	Florjan Lame	E.1631	
Ing. Elektrik	Fatmira Shyti	E.0462/3	
Projektues	OE "INFRA TECH" shpk		

# DETAJE

## Detaj i dritares

### DR-1

**SHENIM:**  
DRITARE PLASTIKE PVC ME DOPIO XHAM ME PRERJE TERMIKE  
PROFLET PLASTIKE TE DRITAREVE DHE VETRATAVE TE OBJEKTIT DO TE KENE NGJYRE GRI TE ERRET.

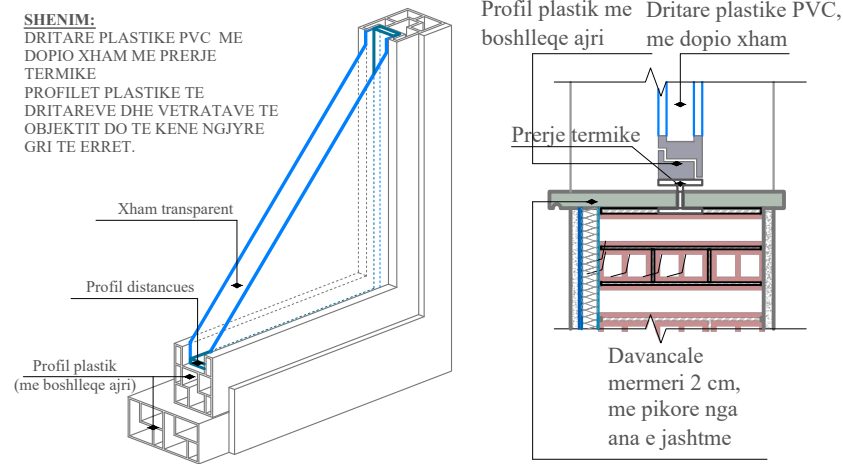

## Detaj i deres

### D-1

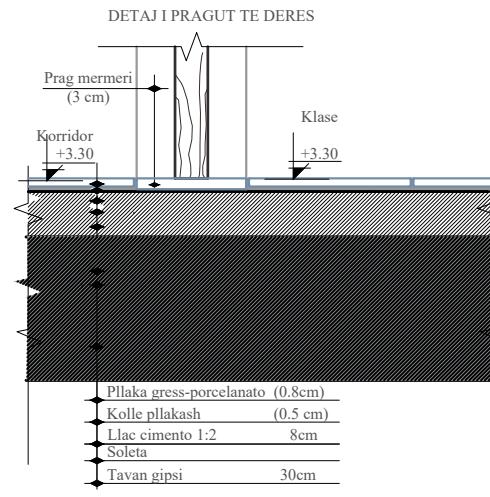

### D2

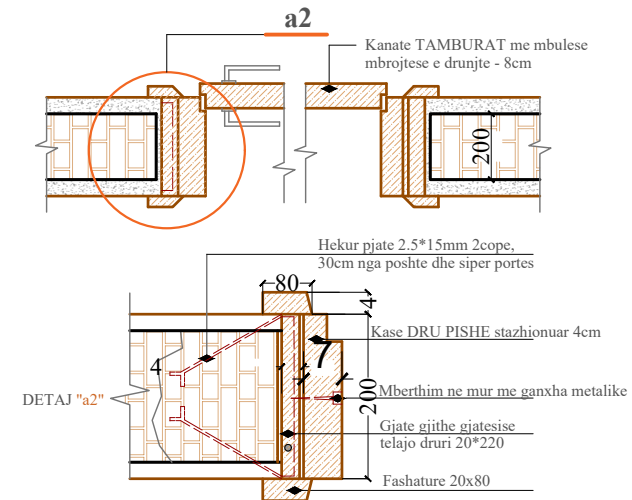

## Detaj i parapetit te palestra

### P-2

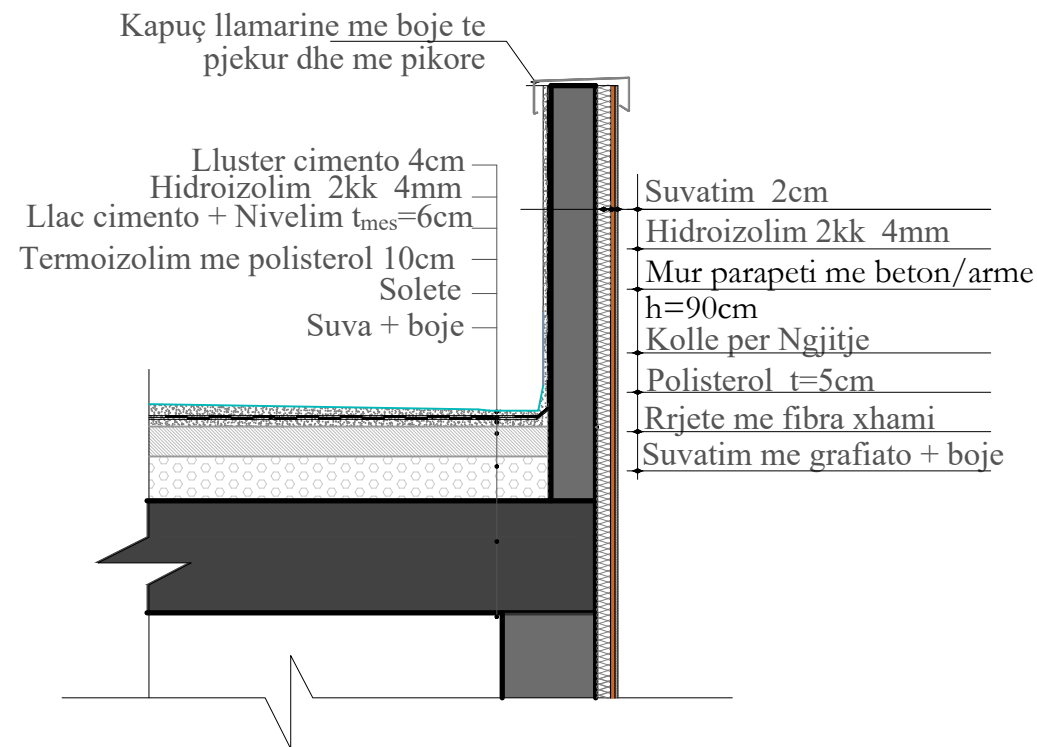

## Detaj i ahkalles "SH-1"

### SH-1

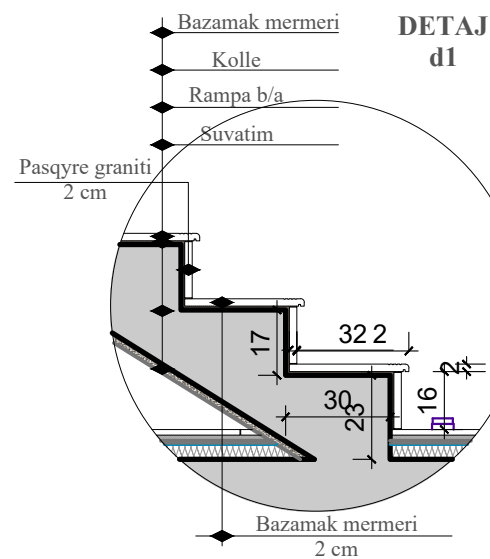

REPUBLIKA E SHQIPËRISË  
BASHKIA TIRANË



ZONA E PROJEKTIT

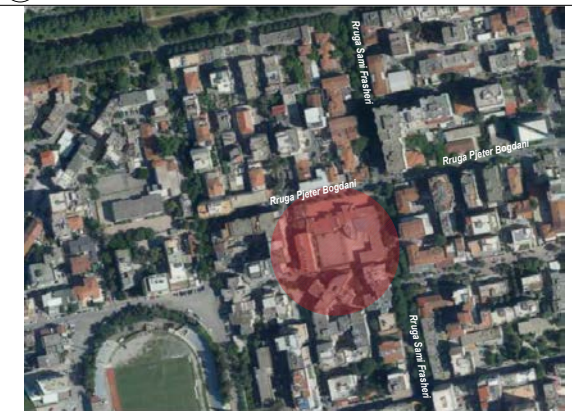

OBJEKTI: STUDIM PROJEKTIM "NDËRTIMI I SHKOLLËS 9 VJEÇARE "EDIT DURHAM"

### DETAJE

FAZA PROJEKT ZBATIM	VITI 2024	NR. SHKALLA	A36
Ing. Hidroteknik	Filjana Veizaj	H/T.0110/9	
Arkitekt	Iva Mezezi	A.0831/4	
Ing. Ndertimi	Rafael Kote	H/T.0129/7	
Ing. Elektrik	Florjan Lame	E.1631	
Ing. Elektrik	Fatmira Shyti	E.0462/3	
Projektues	OE "INFRATECH" shpk		

**INFRATECH**

Administrator

Filjana Veizaj

# DETAJE

## Detaj i parapetit te shkolla

P-1

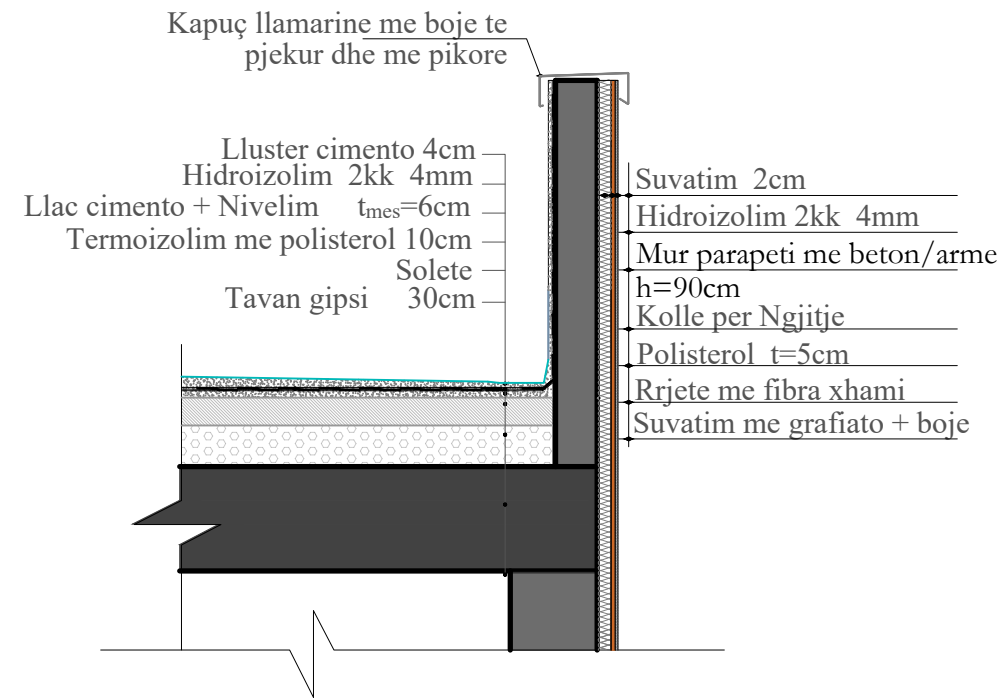

## DETAJ DRENAZHIMI

Gjeotekstil

HDPE i brinjezuar  
160 mm me vrime  
Mbushje me cakull  
te fraksionuar  
d=2-3cm

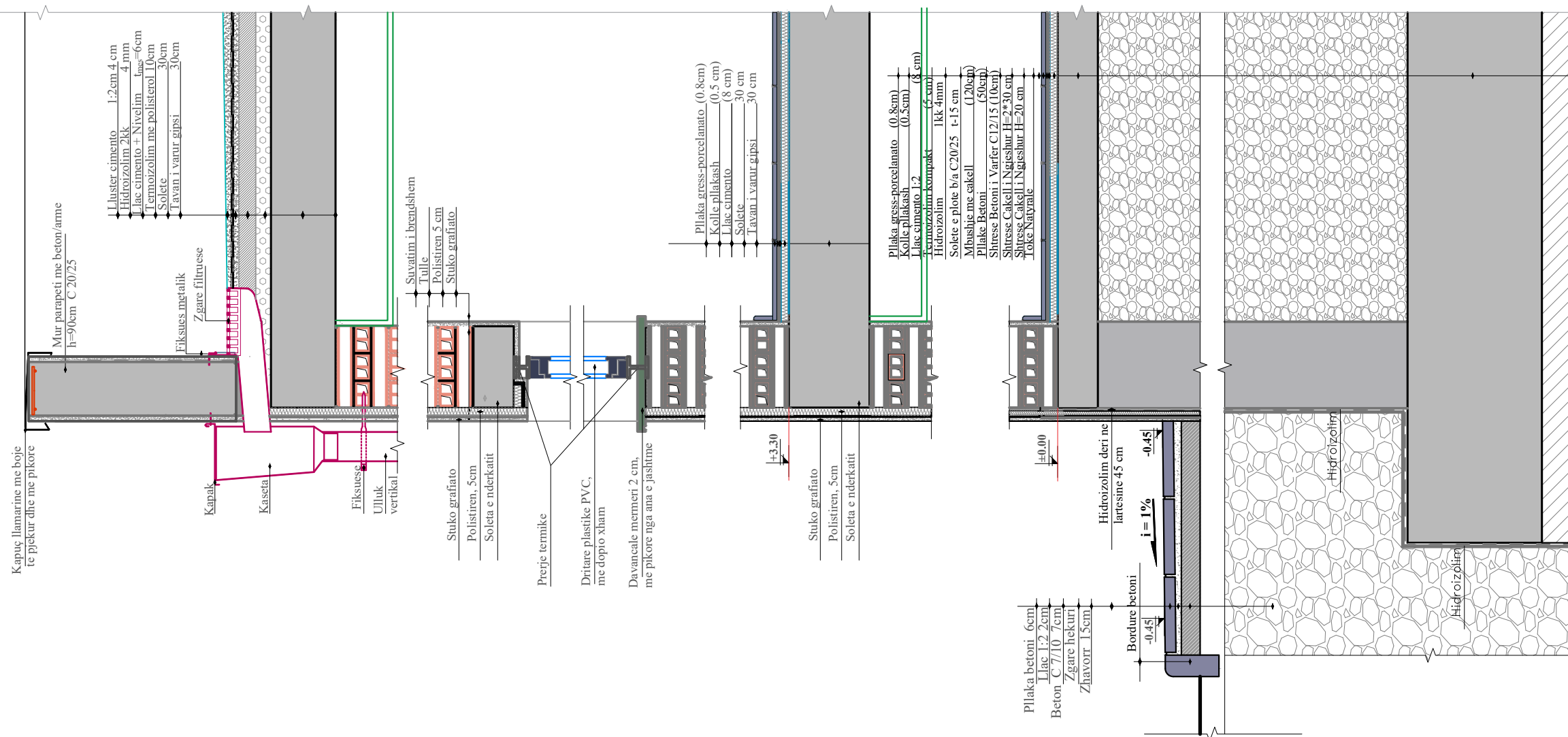
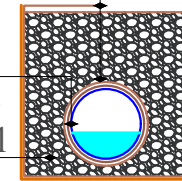

REPUBLIKA E SHQIPËRISË  
BASHKIA TIRANË



ZONA E PROJEKTIT



OBJEKTI: STUDIM PROJEKTIM "NDËRTIMI I SHKOLLËS  
9 VJEÇARE "EDIT DURHAM"

### DETAJE

FAZA PROJEKT ZBATIM	VITI 2024	NR. SHKALLA	A37
Ing. Hidroteknik	Filjana Veizaj	H/T.0110/9	
Arkitekt	Iva Mezezi	A.0831/4	
Ing. Ndertimi	Rafael Kote	H/T.0129/7	
Ing. Elektrik	Florjan Lame	E.1631	
Ing. Elektrik	Fatmira Shyti	E.0462/3	
Projektues	OE "INFRA TECH" shpk		

**INFRA TECH**  
Administrator  
Filjana Veizaj

# DETAJE

## DETAJ STOLI

### D-1

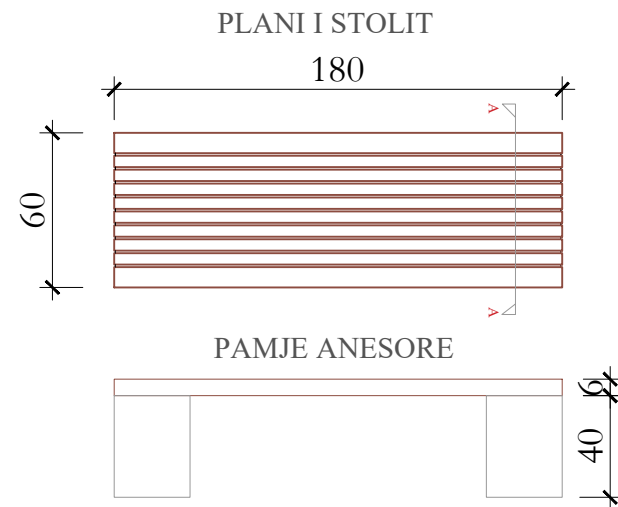

### PRERJE A-A

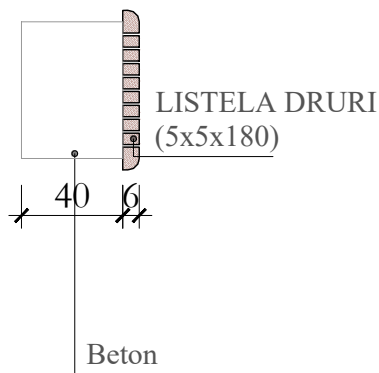

## DETAJ I KOSHIT TE MBETURINAVE

### D-6

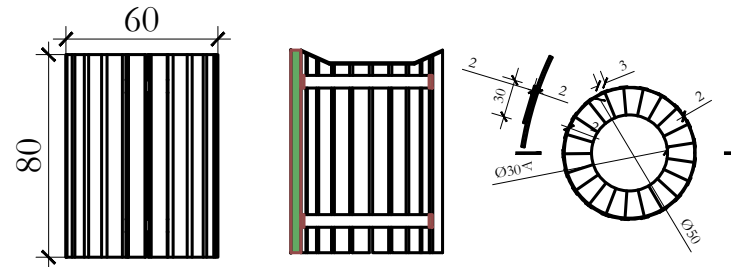

#### SHENIM:

Koshi do te pergatitet me elemente metalike me spesor 2mm, te fiksuar ne dy unaza metalike te vendosura ne anen e brendshme te koshit , te spostuara 15cm nga skajet. Fiksimi i elementeve do te realizohet me saldim. Pjesa e anesore do funksionoje si kapak me menteshe. Brenda koshit do vendost nje kosh tjetër me llamarine te zinkuar dhe me vrima Ø5mm te vendosura çdo 3cm.

## DETAJ KOSHIT TE BASKETIT

Kosh basketbolli teleskopik (i levizshem) , 2.3-2.05 m, diametri I koshit 45 cm, tabela 110 x 75 cm



REPUBLIKA E SHQIPËRISË  
BASHKIA TIRANË



ZONA E PROJEKTIT

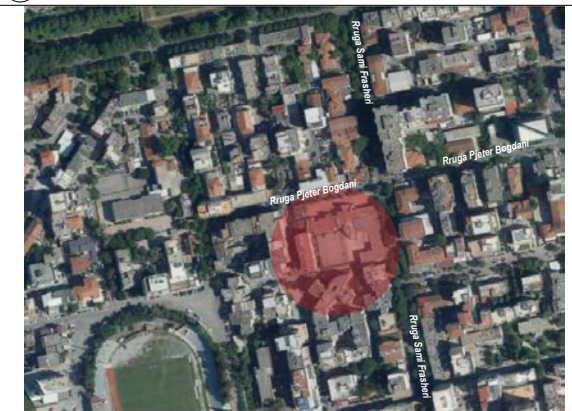

OBJEKTI: STUDIM PROJEKTIM "NDËRTIMI I SHKOLLËS  
9 VJEÇARE "EDIT DURHAM"

### DETAJE

FAZA PROJEKT ZBATIM	VITI 2024	NR. SHKALLA	A38
Ing. Hidroteknik	Filjana Veizaj	H/T.0110/9	
Arkitekt	Iva Mezezi	A.0831/4	
Ing. Ndertimi	Rafael Kote	H/T.0129/7	
Ing. Elektrik	Florjan Lame	E.1631	
Ing. Elektrik	Fatmira Shyti	E.0462/3	
Projektues	OE "INFRATECH" shpk		

**INFRATECH**

Administrator

Filjana Veizaj

# DETAJE

Detaj i shkalleve te jashtme SH-3

Detaj i rampes R-1

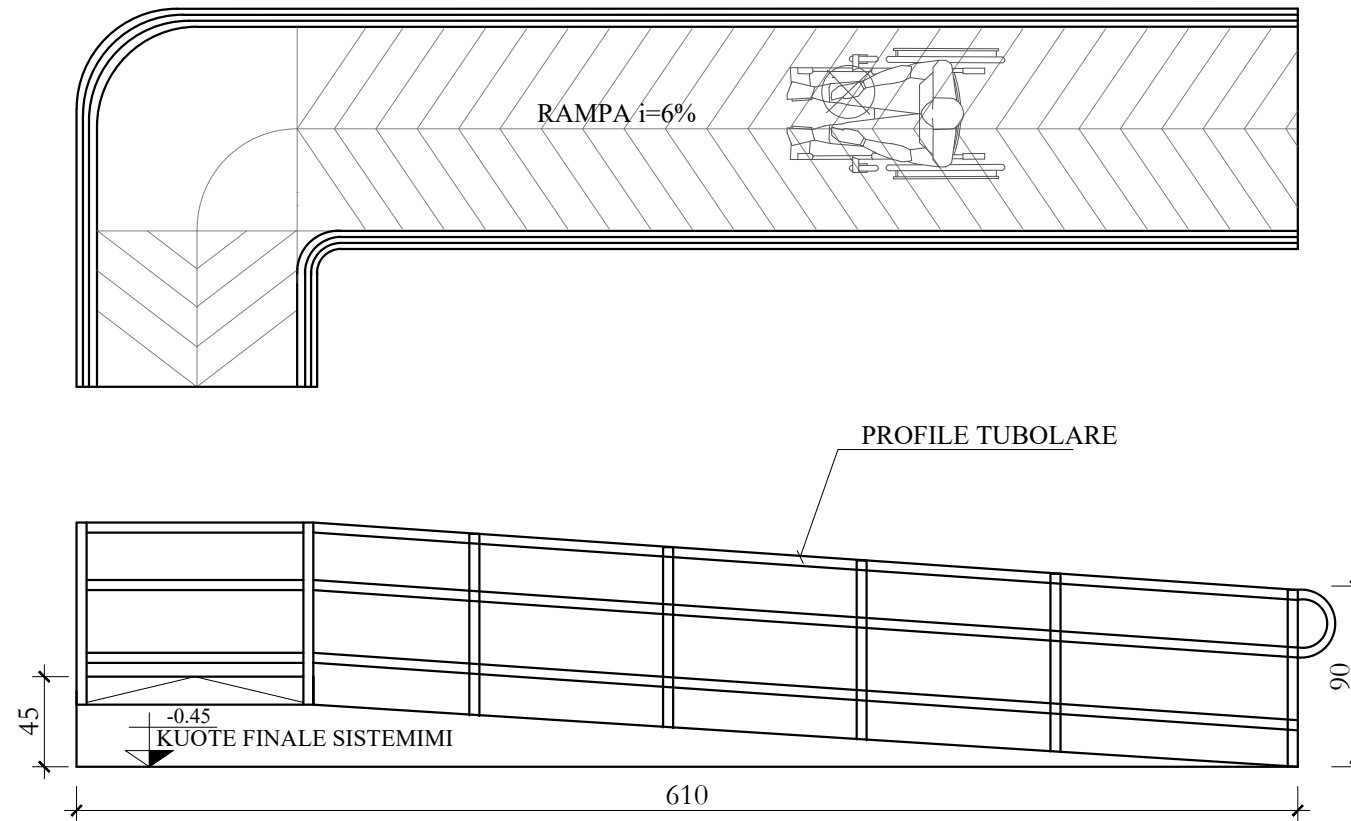
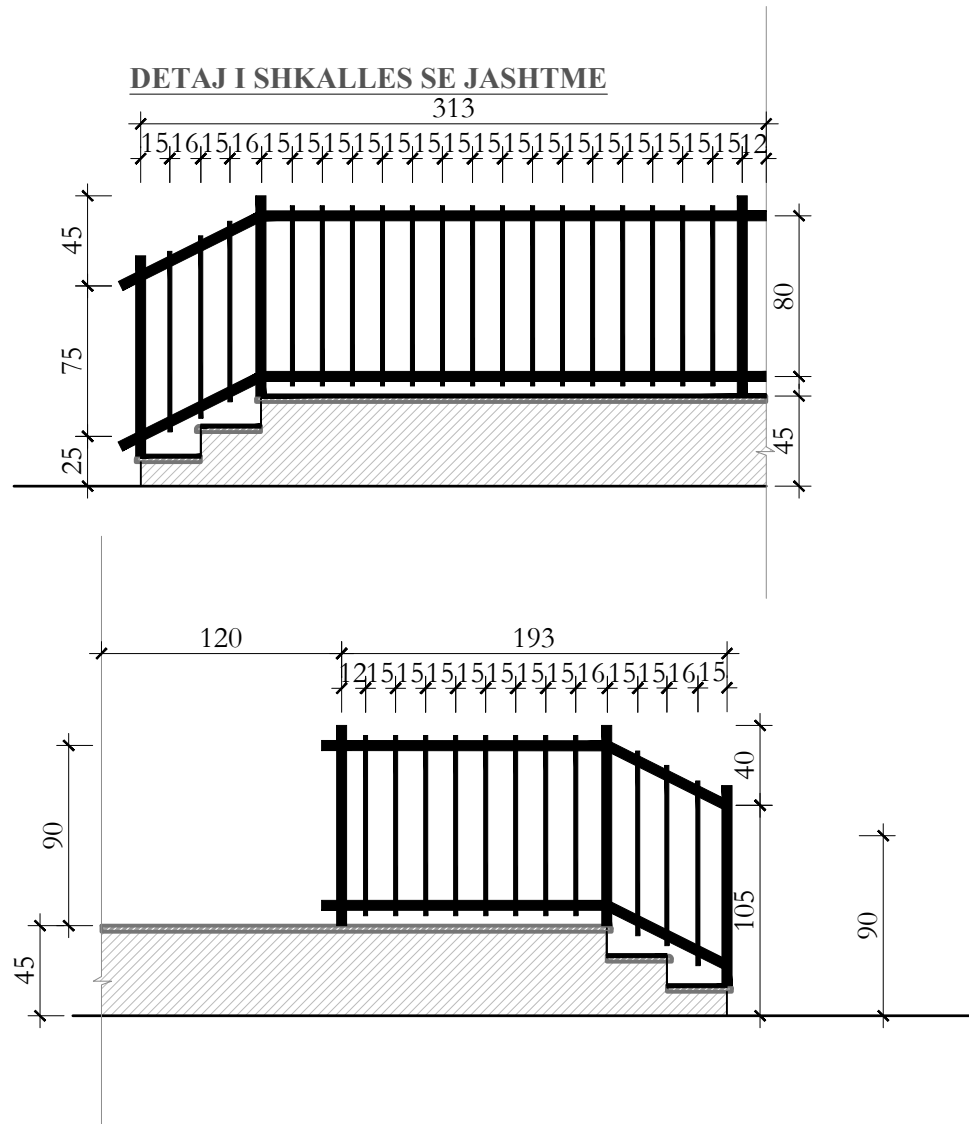

DETAJI I SHKALLEVE TE JASHTME

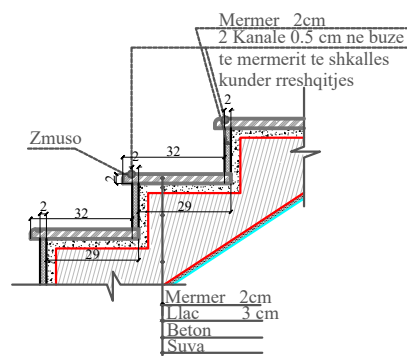

REPUBLIKA E SHQIPËRISË  
BASHKIA TIRANË



ZONA E PROJEKTIT

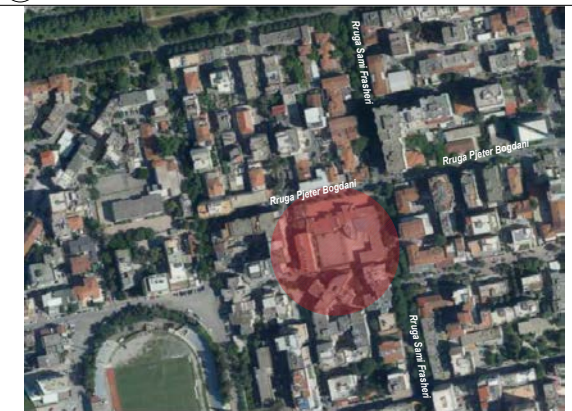

OBJEKTI: STUDIM PROJEKTIM "NDËRTIMI I SHKOLLËS 9 VJEÇARE "EDIT DURHAM"

## DETAJE

FAZA PROJEKT ZBATIM	VITI 2024	NR. SHKALLA	A39
Ing. Hidroteknik	Filjana Veizaj	H/T.0110/9	
Arkitekt	Iva Mezezi	A.0831/4	
Ing. Ndertimi	Rafael Kote	H/T.0129/7	
Ing. Elektrik	Florjan Lame	E.1631	
Ing. Elektrik	Fatmira Shyti	E.0462/3	
Projektues	OE "INFRA TECH" shpk		

**INFRA TECH**  
Administrator  
Filjana Veizaj



# DETAJE

## DETAJ I STREHES POLIKARBONAT

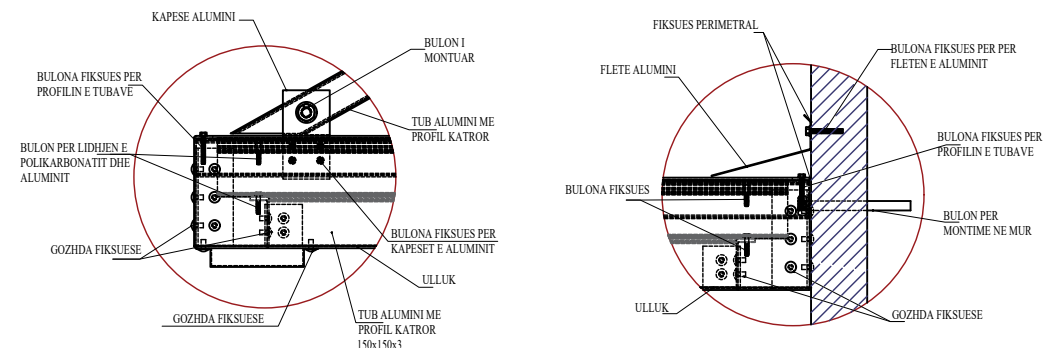
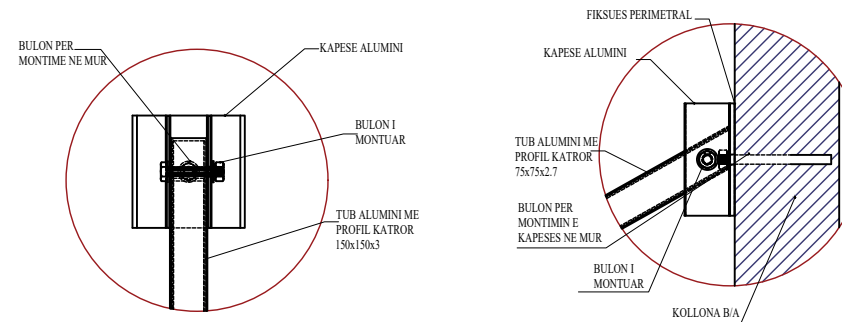
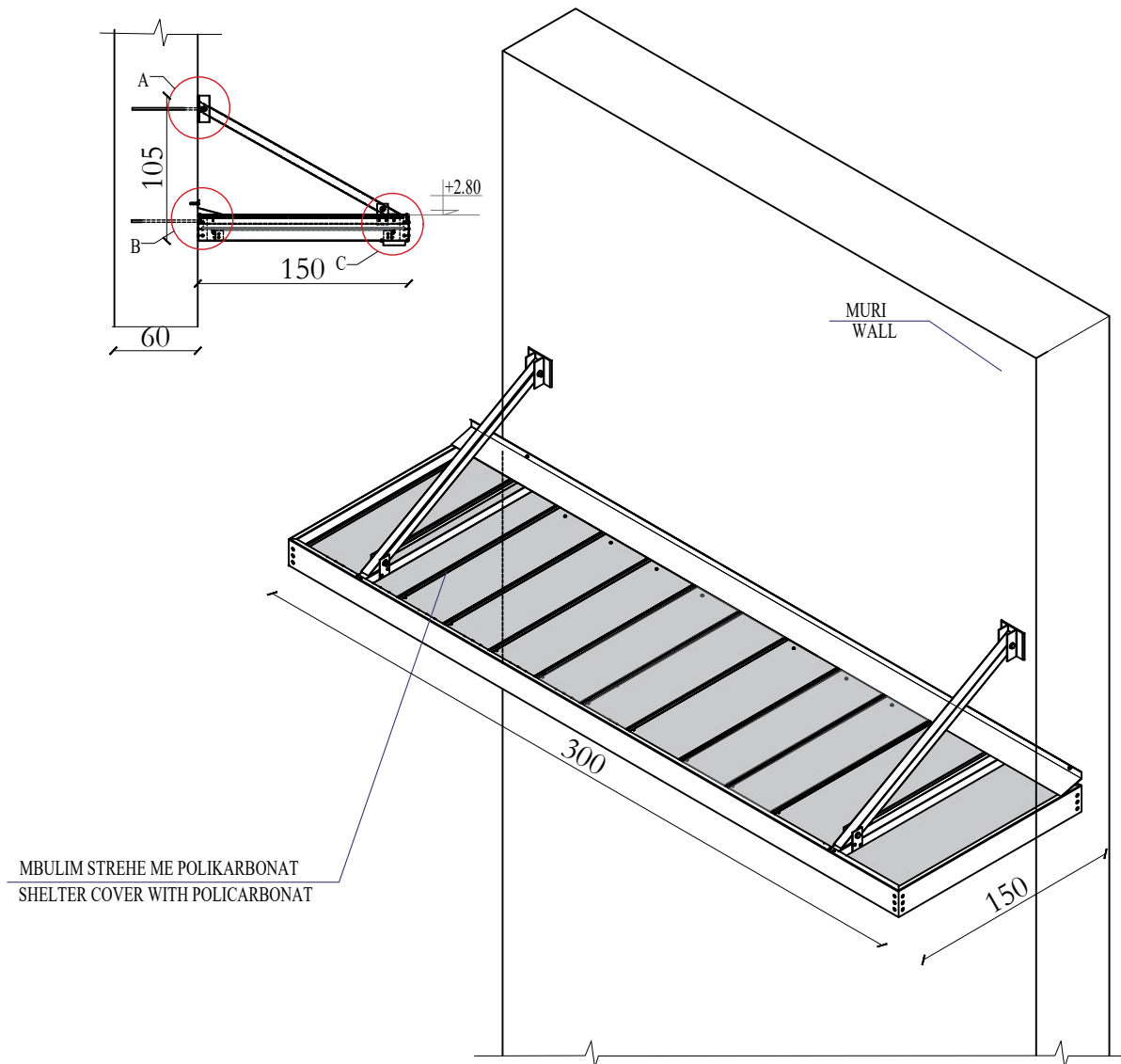

## DETAJE I ELEMENTEVE HIJEZUES

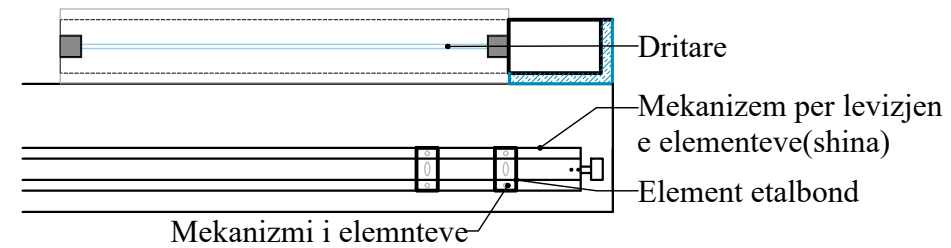
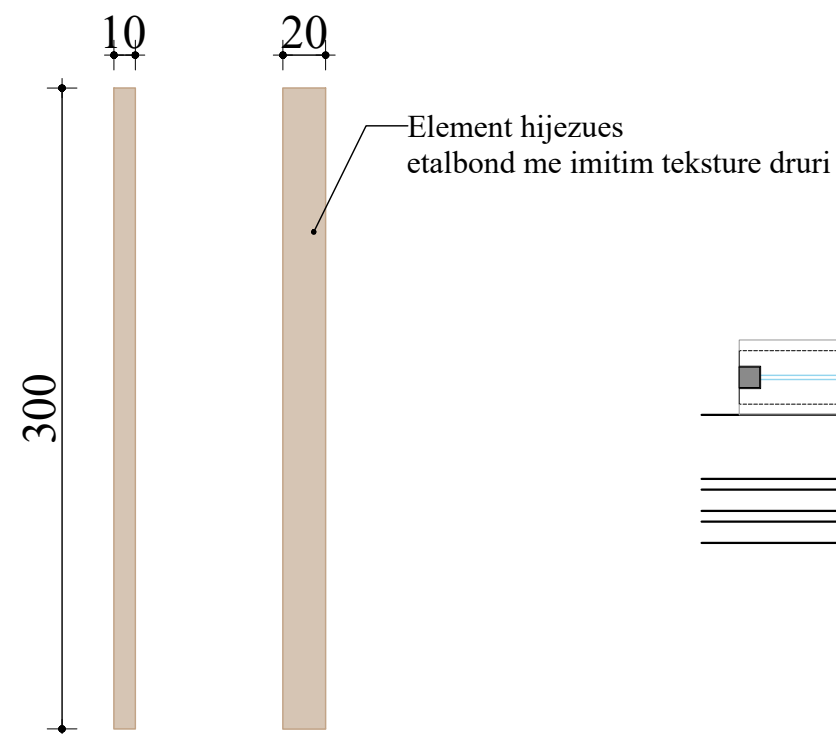

REPUBLIKA E SHQIPËRISË  
BASHKIA TIRANË



ZONA E PROJEKTIT

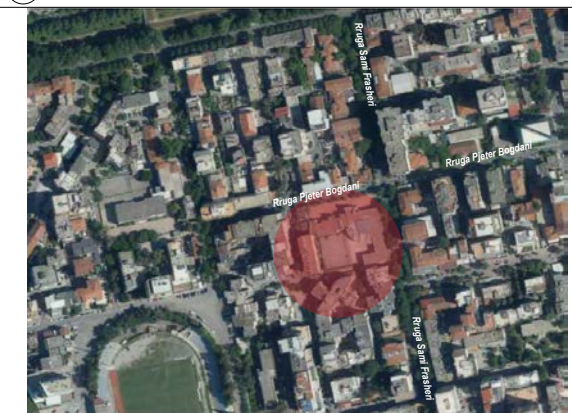

OBJEKTI: STUDIM PROJEKTIM "NDËRTIMI I SHKOLLËS 9 VJEÇARE "EDIT DURHAM"

### DETAJE

FAZA PROJEKT ZBATIM	VITI 2024	NR. SHKALLA	A40
Ing. Hidroteknik	Filjana Veizaj	H/T.0110/9	
Arkitekt	Iva Mezezi	A.0831/4	
Ing. Ndertimi	Rafael Kote	H/T.0129/7	
Ing. Elektrik	Florjan Lame	E.1631	
Ing. Elektrik	Fatmira Shyti	E.0462/3	
Projektues	OE "INFRATECH" shpk		

**INFRATECH**  
Administrator  
Filjana Veizaj

# DETAJE

## DETAJ I MURIT RRETHUES DHE GJELBERIMI

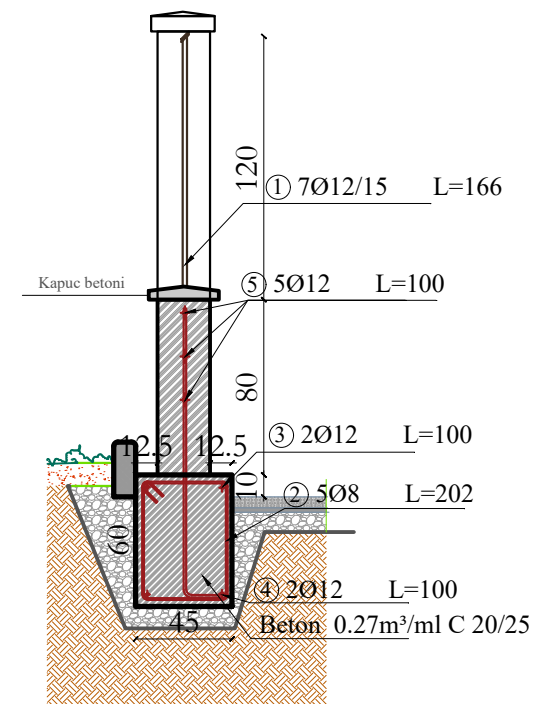
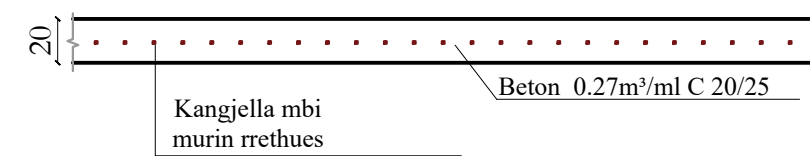
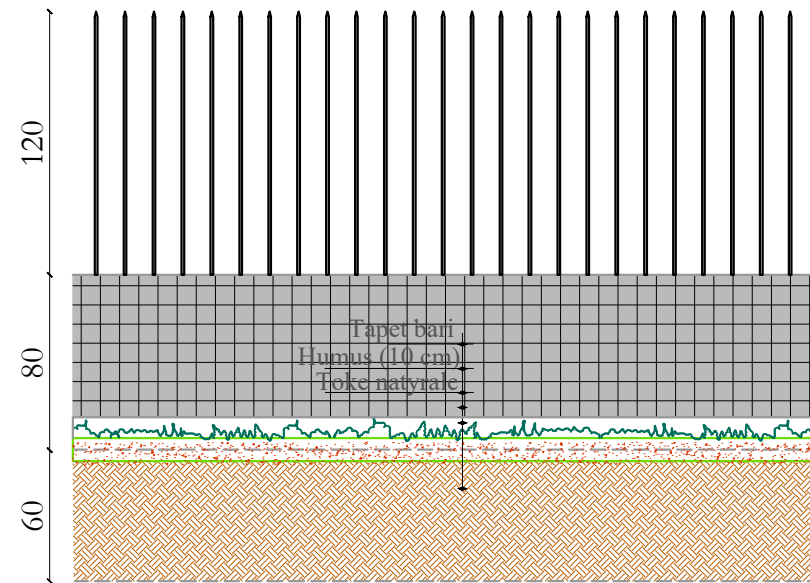
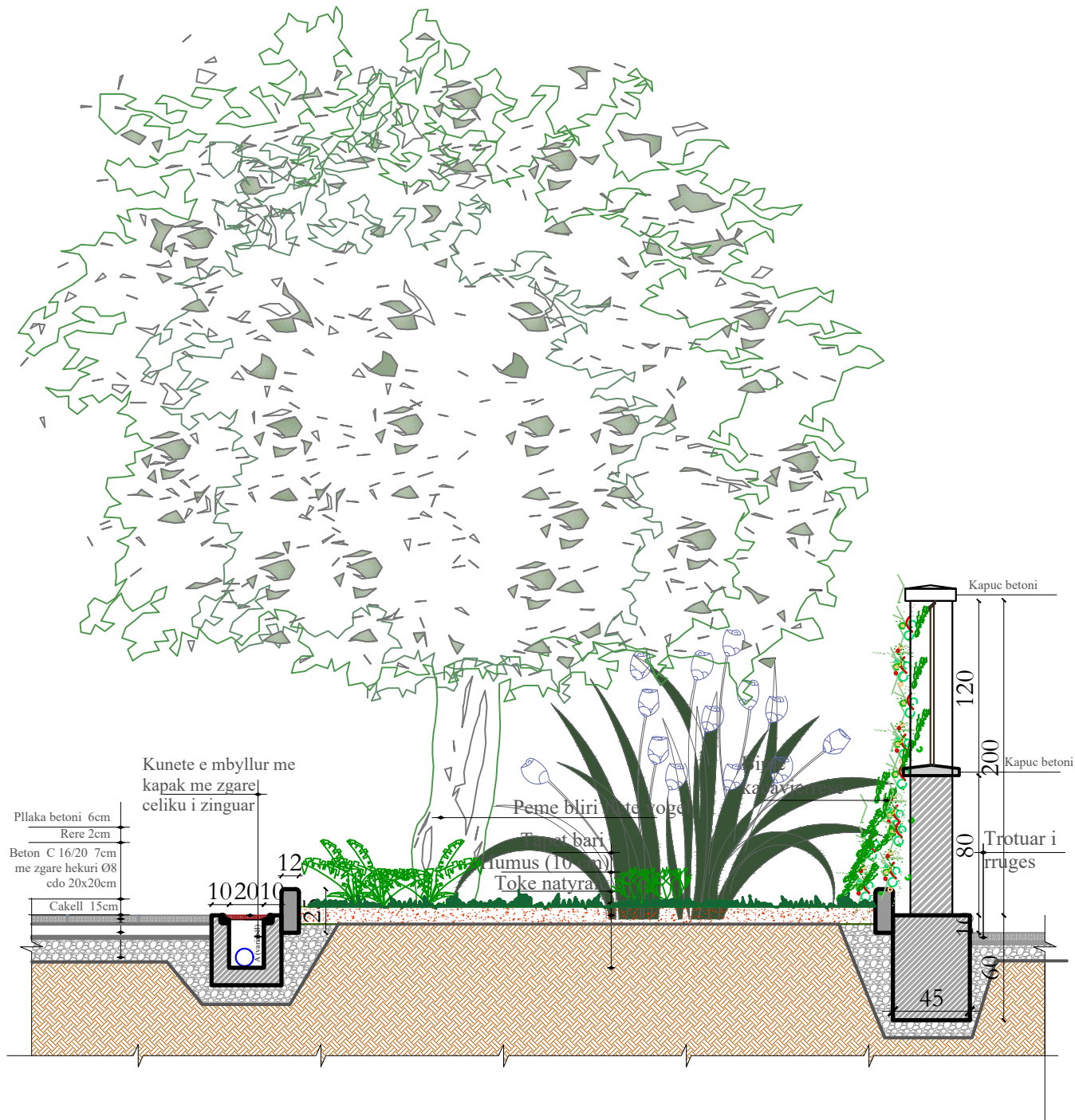

REPUBLIKA E SHQIPËRISË  
BASHKIA TIRANË



ZONA E PROJEKTIT

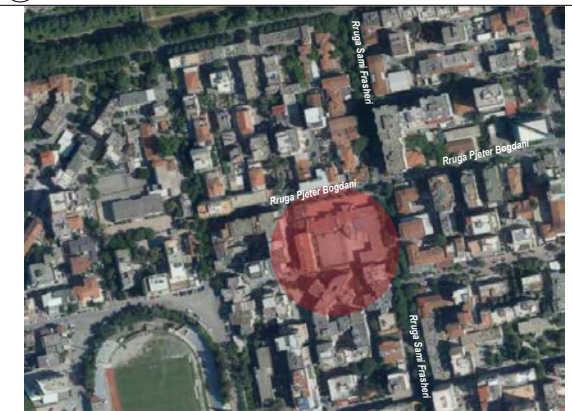

OBJEKTI: STUDIM PROJEKTIM "NDËRTIMI I SHKOLLËS  
9 VJEÇARE "EDIT DURHAM"

### DETAJE

FAZA PROJEKT ZBATIM	VITI 2024	NR. SHKALLA	A41
Ing. Hidroteknik	Filjana Veizaj	H/T.0110/9	
Arkitekt	Iva Mezezi	A.0831/4	
Ing. Ndertimi	Rafael Kote	H/T.0129/7	
Ing. Elektrik	Florjan Lame	E.1631	
Ing. Elektrik	Fatmira Shyti	E.0462/3	
Projektues	OE "INFRATECH" shpk		

**INFRATECH**  
Administrator  
Filjana Veizaj



# RENDER



REPUBLIKA E SHQIPËRISË  
BASHKIA TIRANË



ZONA E PROJEKTIT

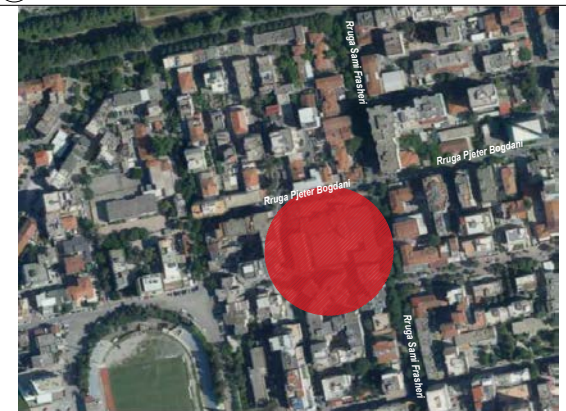

OBJEKTI: STUDIM PROJEKTIM "NDËRTIMI I SHKOLLËS  
9 VJEÇARE "EDIT DURHAM"

## RENDER

FAZA PROJEKT ZBATIM	VITI 2024	NR. SHKALLA	A43
Ing. Hidroteknik	Filjana Veizaj	H/T.0110/9	
Arkitekt	Iva Mezezi	A.0831/4	
Ing. Ndertimi	Rafael Kote	H/T.0129/7	
Ing. Elektrik	Florjan Lame	E.1631	
Ing. Elektrik	Fatmira Shyti	E.0462/3	
Projektues	OE "INFRATECH" shpk		

**INFRATECH**

Administrator

Filjana Veizaj

# RENDER



REPUBLIKA E SHQIPËRISË  
BASHKIA TIRANË



ZONA E PROJEKTIT



OBJEKTI: STUDIM PROJEKTIM "NDËRTIMI I SHKOLLËS  
9 VJEÇARE "EDIT DURHAM"

## RENDER

FAZA PROJEKT ZBATIM	VITI 2024	NR. SHKALLA	A44
Ing. Hidroteknik	Filjana Veizaj	H/T.0110/9	
Arkitekt	Iva Mezezi	A.0831/4	
Ing. Ndertimi	Rafael Kote	H/T.0129/7	
Ing. Elektrik	Florjan Lame	E.1631	
Ing. Elektrik	Fatmira Shyti	E.0462/3	
Projektues	OE "INFRATECH" shpk		

**INFRATECH**

Administrator  
Filjana Veizaj

# RENDER



REPUBLIKA E SHQIPËRISË  
BASHKIA TIRANË



ZONA E PROJEKTIT

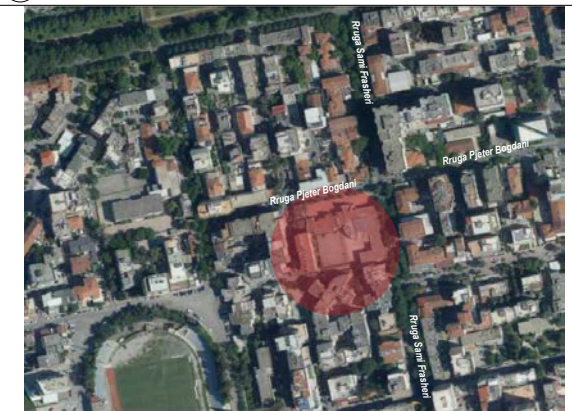

OBJEKTI: STUDIM PROJEKTIM "NDËRTIMI I SHKOLLËS  
9 VJEÇARE "EDIT DURHAM"

## RENDER

FAZA PROJEKT ZBATIM	VITI 2024	NR. SHKALLA	A45
Ing. Hidroteknik	Filjana Veizaj	H/T.0110/9	
Arkitekt	Iva Mezezi	A.0831/4	
Ing. Ndertimi	Rafael Kote	H/T.0129/7	
Ing. Elektrik	Florjan Lame	E.1631	
Ing. Elektrik	Fatmira Shyti	E.0462/3	
Projektues	OE "INFRATECH" shpk		

**INFRATECH**

Administrator

Filjana Veizaj

# RENDER



REPUBLIKA E SHQIPËRISË  
BASHKIA TIRANË



ZONA E PROJEKTIT



OBJEKTI: STUDIM PROJEKTIM "NDËRTIMI I SHKOLLËS  
9 VJEÇARE "EDIT DURHAM"

## RENDER

FAZA PROJEKT ZBATIM	VITI 2024	NR. SHKALLA	A46
Ing. Hidroteknik	Filjana Veizaj	H/T.0110/9	
Arkitekt	Iva Mezezi	A.0831/4	
Ing. Ndertimi	Rafael Kote	H/T.0129/7	
Ing. Elektrik	Florjan Lame	E.1631	
Ing. Elektrik	Fatmira Shyti	E.0462/3	
Projektues	OE "INFRA TECH" shpk		

**INFRA TECH**

Administrator  
Filjana Veizaj

# RENDER



REPUBLIKA E SHQIPËRISË  
BASHKIA TIRANË



ZONA E PROJEKTIT



OBJEKTI: STUDIM PROJEKTIM "NDËRTIMI I SHKOLLËS  
9 VJEÇARE "EDIT DURHAM"

## RENDER

FAZA PROJEKT ZBATIM	VITI 2024	NR.	A47
		SHKALLA	
Ing. Hidroteknik	Filjana Veizaj	H/T.0110/9	
Arkitekt	Iva Mezezi	A.0831/4	
Ing. Ndertimi	Rafael Kote	H/T.0129/7	
Ing. Elektrik	Florjan Lame	E.1631	
Ing. Elektrik	Fatmira Shyti	E.0462/3	
Projektues	OE "INFRATECH" shpk		

**INFRATECH**

Administrator

Filjana Veizaj



# RENDER



REPUBLIKA E SHQIPËRISË  
BASHKIA TIRANË



ZONA E PROJEKTIT



OBJEKTI: STUDIM PROJEKTIM "NDËRTIMI I SHKOLLËS  
9 VJEÇARE "EDIT DURHAM"

## RENDER

FAZA PROJEKT ZBATIM	VITI 2024	NR. SHKALLA	A48
Ing. Hidroteknik	Filjana Veizaj	H/T.0110/9	
Arkitekt	Iva Mezezi	A.0831/4	
Ing. Ndertimi	Rafael Kote	H/T.0129/7	
Ing. Elektrik	Florjan Lame	E.1631	
Ing. Elektrik	Fatmira Shyti	E.0462/3	
Projektues	OE "INFRATECH" shpk		

**INFRATECH**

Administrator

Filjana Veizaj